

bTwin
Retail scale

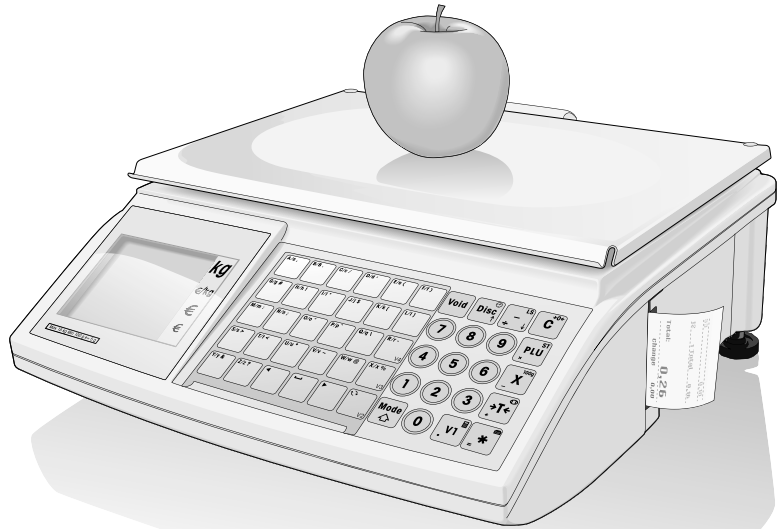

METTLER TOLEDO



Contents

Contents

1	Your new retail scale	5
1.1	Most important functions	5
1.2	Device overview	5
1.3	Safety instructions	9
1.4	Calibration instructions	10
2	Setup and device settings	11
2.1	Contents	11
2.2	Requirements for scale's location	11
2.3	Setting up the scale	11
2.4	Inserting paper	13
2.5	Inserting the battery	15
2.6	Connecting to mains power	16
2.7	Turning on/off	16
2.8	Turning on background lighting/saving energy	16
2.9	Cleaning	17
2.10	Disposal	17
3	Fast and easy operation	18
3.1	Free input	18
3.2	Working with PLUs	19
3.3	Entering large quantities	21
3.4	Weighing with 100 g price unit	22
3.5	Using quantity PLU and multiplication	22
3.6	Using tare	23
3.7	Zeroing	23
3.8	The scale as a calculator	24
3.9	The scale as a clock	24

4 Active selling	25
4.1 Voiding	25
4.2 Granting a discount	26
4.3 Granting a rebate on the total sum	27
4.4 Refunding (ST)	28
4.5 Suspending a transaction (ticket parking)	29
4.6 Working with several vendors	30
4.7 Customer change function	31
4.8 Various payment methods	32
4.9 Basket function	35
4.10 Working with 2 PLUs per preset key	37
5 Setup	39
5.1 Overview	39
5.2 List of all setup points	40
5.3 Setup operation	42
5.4 Setup group 1	45
5.5 Setup group 2	57
5.6 Setup group 3	59
5.7 Setup group 4	60
5.8 Setup group 5	65
5.9 Setup group 6	66
5.10 Setup group 7	71
5.11 Setup group 8	75
5.12 Setup group 10	77
6 What do you do if...?	81
7 Technical data and accessories	83
7.1 Technical data	83
7.2 Accessories	83
8 Appendix	84
8.1 Unicode Table	84
8.2 Label formats	86
8.3 Declaration of conformity	87

1 Your new retail scale

1.1 Most important functions

Congratulations on your new scale.

This robust scale with its battery operation, connectable cash drawer and integrated ticket printer facilitates comfortable, mobile selling while maintaining the highest accuracy.

Your new scale not only stands out due to its mobility, but also due to its network-capability and fast data transfer to and from a computer. This lets you, for example, operate integrated scales which are connected to quickly and easily create sales reports.

1.2 Device overview

1.2.1 Display

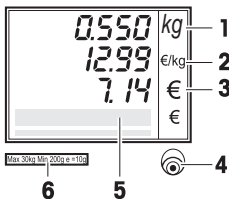



This display is laid out as follows from the customer and vendor point of view:

- 1 Weight display
- 2 Unit price
- 3 Price
- 4 Level indicator
- 5 Field for instructions or status messages
- 6 Calibration plate

In addition to the weight and price, the following status messages and indicators can be displayed:

- >0<-** Gross weight is 0
- P P** Prepack mode
- ST** Refund mode
- X** Quantity mode
- 100G** Price per 100 g
- NET** Net weight
- LS** Large sale mode
- PLU** PLU number is displayed
- FIX** Unit price and/or tare are not hidden when the item is removed from the weighing pan or when several items are accumulated

-  Connected to mains power supply

-  Network operation: the scale functions as a **master** and is connected to at least one slave

-  Network operation: the scale functions as a **slave** and is connected to the master

-  Illuminated: the scale is in battery-powered operation
 Flashing: battery too low
 charge or replace battery

-  Flashing and power supply operation symbol illuminated: battery is charging





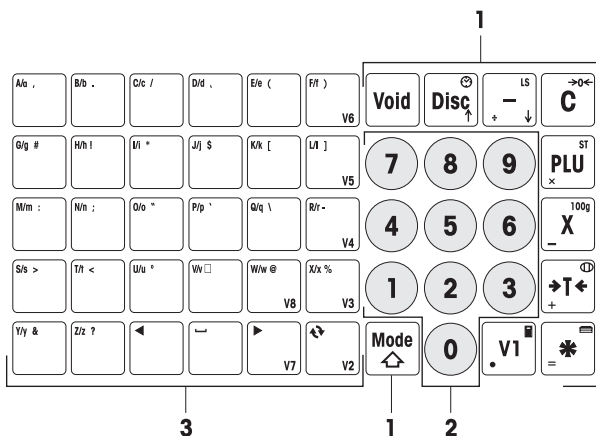





1.2.2 Keyboard

The keyboard is divided into three sections:



















- 1 Function keys
- 2 Number keys
- 3 Key panel for entering text / direct keys / vendor keys (V2-V8)

In addition to their main function, most of the function keys have one or more auxiliary functions which are shown on the upper right and lower left of the key.

Function keys	Key	Name	Function
Main function		Void key	Cancel the item
		Discount key	Enter the discount in percent
		Minus key	Absolute decrease
		Delete key	Delete the entry
		PLU key	Call up a PLU
		Quantity key	Enter quantity
		Tare key	Tare the scale
		Asterisk key	Complete the transaction, print ticket
		Vendor key	Book items to Vendor V1 . The vendor keys, V2 to V8, are located to the left of the number panel.
		Mode key	Enter/leave the setup mode, call up the auxiliary function

Function keys Used in combination with the mode key, the function keys have the following secondary functions:

Auxiliary function

Key	Function
 + 	Display/hide date/time *
 + 	Activate large sale mode **
 + 	Zero the scale *
 + 	Turn refund mode on/off *
 + 	Toggle between price/100 g and price/kg **
 + 	Park ticket
 + 	Open cash drawer
 + 	Turn calculator on/off *

* Activate/deactivate using key combinations: while holding the mode key, press the function key.

** To activate, either a price must first be entered or a PLU must be called up. After the transaction is completed, the scale returns to the normal operating mode.

1.2.3 Connections

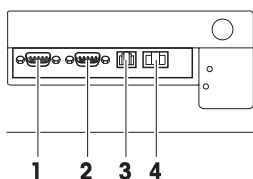

The following connections are located on the underside of the scale:

- 1 RS-232/COM1 for a scanner or computer
- 2 RS-232/COM2 for a scanner or computer
- 3 Cash drawer connection
- 4 Ethernet connection to set up a network of scales

1.2.4 Options/Accessories

The following options/accessories are available to enhance the performance of your scale:

- Tower to position the customer display at eye level
- Battery for mobile operation
- Cash drawer
- Integrated calculation function



If you want to add an option/accessory to your scale, please contact your sales representative.

1.3 Safety instructions



Basic safety instructions

- ▶ Read these operating instructions prior to using your scale.
- ▶ Store these operating instructions in the vicinity of the scale for future reference.
- ▶ Do not open the scale.
- ▶ Always unplug the scale before cleaning.



Safety instructions for battery operation

- ▶ The battery must not come into contact with chemical solvents, oil or water.
- ▶ Keep batteries away from heat and fire.
- ▶ Do not open the battery.



1.4 Calibration instructions

Scales that have been factory-calibrated have a label indicating this on the packaging.

Scales with a green M on the type plate are ready for operation.



Scales that are calibrated in two stages have a label indicating this on the packaging.

These scales have only been calibrated in a first stage (declaration of conformity in accordance with EN 45501-8.2). The second stage of the calibration must be done on-site by authorized service personnel.

Please contact your local representative.



Medium accuracy scales that are used in commerce where certified calibration is required must be calibrated and certified.

Observe the respective measurement data guidelines in your country.

2 Setup and device settings

2.1 Contents

- ♣ Check that the delivery is complete:
 - Scale
 - Stainless steel weighing pan
 - Power cable
 - Ticket roll
 - Operating instructions
 - Quick guide

2.2 Requirements for scale's location

The right location is critical to weighing accuracy.

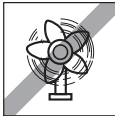

Conditions for an ideal location:

- No shocks and vibrations
 - No excessive temperature fluctuations
 - No direct sunlight
 - No strong drafts
-
- Select a stable, vibration-free and preferably horizontal location for your scale.

2.3 Setting up the scale

2.3.1 Levelling the scale



Only a perfectly levelled scale delivers accurate weighing results. The scale is equipped with a level indicator to make it easier to level the scale.

- ♣ To level the scale, turn the scale's adjustable feet until the air bubble in the level indicator is positioned in the inner circle.

2.3.2 Removing the transportation lock

3 kg scales are equipped for transport with a locking bolt.

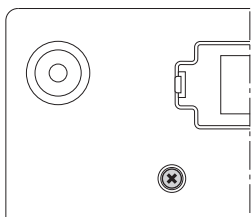

1. Remove the weighing pan.
2. Unscrew the locking bolt and put the weighing pan back on.

2.3.3

Mounting the tower (optional)

The tower is available as an option to mount the customer display at eye level.

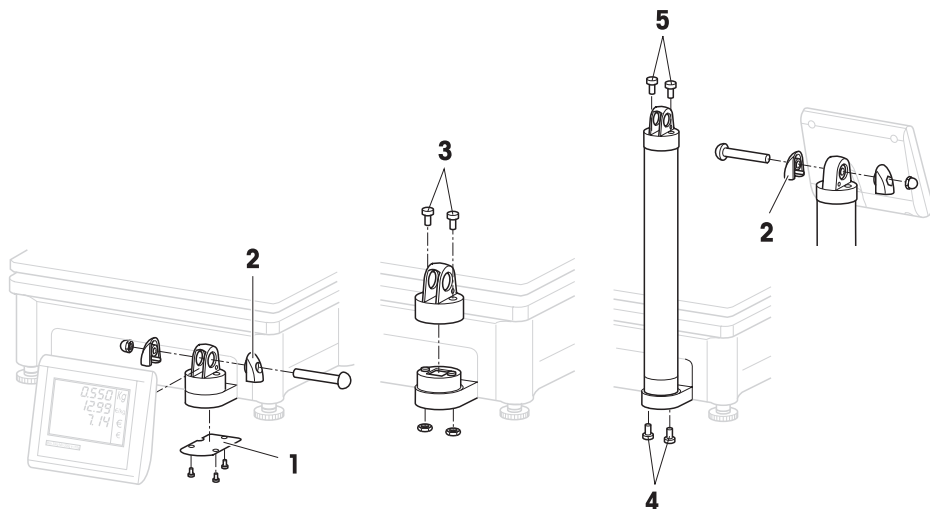

1. Loosen the 3 screws on the underside of the scale to remove the cover plate (1).
2. Remove the screws and nuts from the side screw caps (2).
3. Remove the screws (3) that fasten the customer display to the display holder.
4. Remove the display from the display holder and pull the display cable out of the cable duct.
5. Lay the cable in the tower.
6. Put the tower on the display holder and fasten it to the scale with 2 screws (4).

7. Put the customer display on the tower and fasten it to the tower with 2 screws (5).
8. Fasten both side screw caps (2) with screws and nuts.

2.4 Inserting paper

2.4.1 Paper format

Ticket rolls or label rolls must comply with the following measures:

Legend

- A at least 12 mm
- B max. 68 mm
- C 57 mm
- D 50 mm
- E 2 mm
- F 20 - 60 mm
- G 2 mm
- H 46 mm

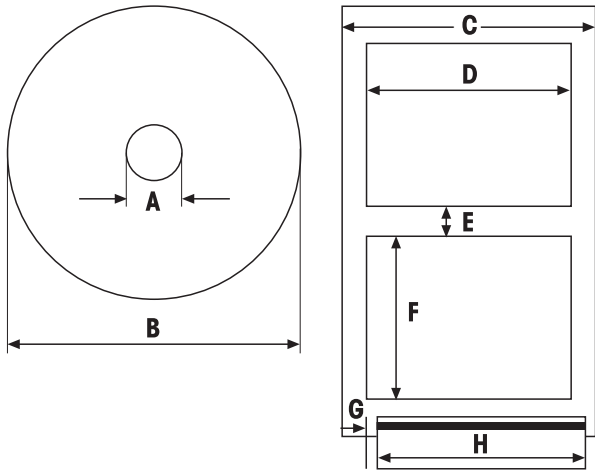

- The paper used (incl. carrier paper) must not be thicker than 0.12 mm.
- Do not slam the printer door as this will damage the printer.

2.4.2 Inserting the ticket roll

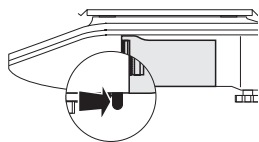

1. To open the printer door press back the small lever on the right side (towards the customer) underneath the scale.

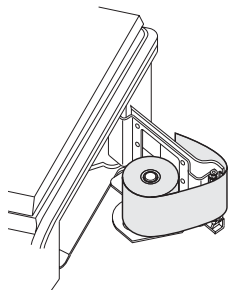

2. Push the ticket roll onto the spindle as shown.
3. Pull the paper to the outside over the black spool.
4. Close the printer door and tear off the excess paper.

2.4.3 Inserting the label roll

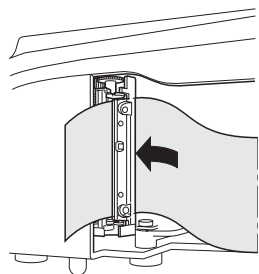

1. Open the printer door as described under inserting the ticket roll.
2. Push the label roll onto the spindle.
3. Remove the first two labels.
4. Pull the carrier paper through the plastic guide behind the paper cutter as shown.
5. Close the printer door.

2.5 Inserting the battery



The scale can only be battery-operated when this function has been activated with a license. If this is not yet the case for your scale, contact your sales representative.



CAUTION

The battery can be damaged if it is incorrectly installed.

- ♣ Pay attention to the correct battery polarity. The positive pole (+) and negative pole (-) cannot be short circuited.
- ♣ **Only use original manufacturer batteries.**

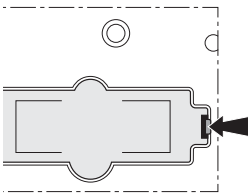

1. Remove the weighing pan.
2. Remove the battery compartment cover.
3. Place the battery in the compartment so that the terminal ends face upwards.
4. Connect the red terminal end to the positive pole (red or +) and the black terminal end to the negative pole (black or -).
5. Close the battery compartment.
6. Put the weighing pan back on.



- The battery life is affected by charging and discharging conditions.
- If correctly used, the battery life can reach approx. 300 charging cycles.
- A fully charged battery lasts up to 30 hours. The battery capacity decreases with age.
- The battery's operating time is reduced when the battery has not been used over a longer period of time (two months).
- It is recommended that the battery be charged at least every 3 months.
- If the battery was not used over a longer period of time, then charge the battery at least three times and use it until it is completely discharged.
- The charging time decreases if the battery is not fully discharged.
- Battery specification: 12 V / 5 Ah.

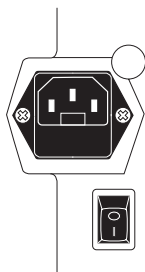

2.6 Connecting to mains power

1. Connect the supplied power cable to the power connection socket on the bottom of the scale.
2. Plug the power plug into a correctly grounded power outlet.

2.7 Turning on/off

- ♣ Turn the scale on using the switch on the bottom of the scale.



- After it is turned on, the scale runs through a short display test. All segments and status messages briefly light up.
- The GEO value and the software version are displayed.
- The scale is ready when the weight display appears.



2.8 Turning on background lighting/saving energy

- The scale comes equipped with a backlit display. If the ambient lighting is not sufficient, background lighting can be turned on so that the display can be easily read.
- During power supply operation, the background lighting stays on until you turn it off.
- To extend the battery's operating life, the background lighting turns off automatically when the scale is not used for more than one minute.
- When a weight is placed on the scale or a key is pressed, the background lighting automatically turns on again.

Turning on background lighting

- ♣ Press and hold the C key until a signal sounds and the background lighting turns on.

Turning off background lighting

- ♣ Press and hold the C key until a signal sounds and the background lighting turns off.

2.9 Cleaning



CAUTION

Damages to the scale

- ♣ Turn off and unplug the device before cleaning.
- ♣ Do not open the device.
- ♣ Make sure that no fluids get inside the device.
- ♣ Do not use scouring powders or plastic dissolving cleaning agents for cleaning.

Cleaning

- ♣ Remove the weighing pan and clean it with a commercially available household detergent.
- ♣ If heavily soiled, clean the surface of the device with a damp cloth that has been dipped in water containing a mild washing-up liquid and then well wrung out.

2.10 Disposal



In accordance with the requirements of European Directive 2002/96 EC on Waste Electrical and Electronic Equipment (WEEE), this device may not be disposed of with domestic refuse. This also applies for countries outside the EU in accordance with their respective national regulations.

- ♣ Please dispose of this product in accordance with local regulations for the separate collection of waste electrical and electronic equipment.

Should you have any questions, please contact the corresponding authorities or the dealer from whom this device was purchased.

If this device is passed on (for example for further private or commercial/ industrial use), this regulation is also to be passed on.

Many thanks for your contribution to the protection of the environment.

Battery disposal

Batteries contain heavy metals and therefore cannot be disposed of in the normal refuse.

- ♣ Observe local regulations on the disposal of materials that are hazardous to the environment.

3 Fast and easy operation



The applications described in this chapter pertain to working with one vendor.

3.1 Free input

You can immediately use your scale for weighing and selling - without prior configuration.

With the factory settings, the scale can total several entries and calculate the customer change.

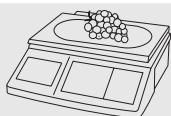

0 ... 9 V1

...



0 ... 9



1. Place the item on the scale.
2. Enter the unit price (price/kg) and enter by pressing the V1 vendor key.
3. For more items, repeat steps 1 and 2.
4. Total the items with the asterisk key.
5. Enter the customer payment.
6. Complete the transaction with the asterisk key.

The scale calculates the change and prints the ticket.



- If you do not want to use the customer change function, omit step 5. In this case, press the asterisk key twice to total up and print the ticket.
- Enter the price as usual without the decimal point, but with all the decimal places.

3.2 Working with PLUs

You can save your item data in the scale's PLU memory and simply call it up later.

With the factory settings, a PLU contains the item name, price type (per kg or per piece) and unit price.

PLUs are created in the scale setup.

Creating a PLU

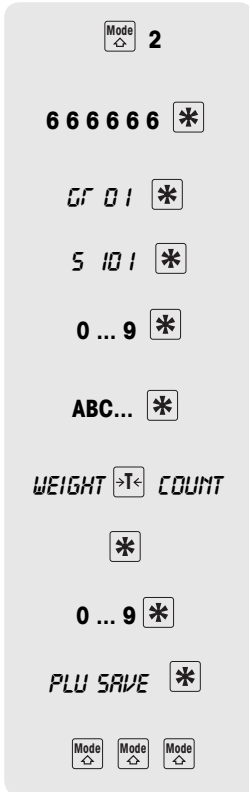

1. Use the mode key to go to setup and then press 2.
2. Enter password: enter the number 6 six times and confirm with the asterisk key.
3. Activate setup group 01 with the asterisk key.
4. Activate setup point 101 with the asterisk key.
5. Enter the desired PLU no. and confirm with the asterisk key.
6. Enter the item name using the keys in the left key field and confirm with the asterisk key.
7. Select the price type (weight or quantity) with the tare key.
8. Confirm the price type with the asterisk key.
9. Enter the unit price and confirm with the asterisk key.
10. Confirm PLU SAVE with the asterisk key.
11. To exit the setup mode, press the mode key 3 times.
The scale prints a list of the saved PLUs for your files.



- Enter other PLUs as described in steps 5 to 10.
- Setup can be accessed in two different ways with different authorizations. Further information can be found in section 5.11, setup group 8

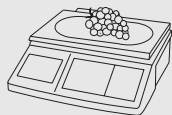

V1

...

Calling up PLUs

1. Place item on the scale.
2. Enter the corresponding PLU NUMBER and press the PLU key. The unit price and item name appear in the display as a check.
3. Confirm the entry with the vendor key.
4. Complete the transaction with the vendor key and the asterisk key as described in section 3.1.



If you discover that you have entered the wrong PLU number, before you have confirmed the entry with the vendor key, then you can clear it with the C- key and then enter the correct PLU.

PLU preset keys

You can save the most important PLUs to the keys in the left-hand key field.



A 3 sec

0 ... 9 *

Setting up preset keys

1. Press the desired preset key, e.g. A, for approx. 3 seconds until PLU appears in the bottom left of the display.
2. Enter the relevant PLU no. and confirm with the asterisk key.

Two acoustic signals confirm that the PLU was assigned to the preset key.



- This key field comes with a card insert for custom key labelling.
- If you want to work with more than one vendor, then the vendor keys (V2 ... V8) cannot be used as PLU preset keys.
- 2 PLUs can be assigned to a preset key, refer to section 4.10.

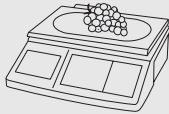

A

V1

...

Calling up PLUs with preset keys

1. Place item on the scale.
2. Press relevant preset key.
The unit price and item name appear in the display as a check.
3. Accept the entry with the vendor key.
4. Enter further items and complete the transaction with the asterisk key as described in section 3.1.

3.3 Entering large quantities

Using the large sale function, you can also enter weights that are larger than the scale's capacity, e.g. when you want to sell a whole package with a known weight.

0 ... 9 **PLU**

0 ... 9



0 ... 9 **V1**

...

1. Enter the respective PLU number and press the PLU key.
The unit price and the item name appear in the display as a check.
- or
- ▶ Enter the unit price.
 2. To go to the large sale function, press the LS key while pressing the mode key.
LS appears at the bottom of the display.
 3. Enter the known weight and confirm with the vendor key.
The large sale mode is ended.
 4. Enter further items and complete the transaction with the asterisk key as described in section 3.1.

3.4 Weighing with 100 g price unit



0 ... 9 **PLU**

0 ... 9



V1

...

For many products, customers are used to a price per 100 g.

1. Place item on the scale.
2. Enter the associated PLU number and press the PLU key.
The unit price and the item name appear in the display as a check.

or

- ▶ Enter the unit price.
3. To go to the 100 g mode, press the 100 g key while holding the mode key.
The unit price per 100 g will be displayed.
 4. Accept the entry with the vendor key.
The 100 g mode is ended.
 5. Enter further items and complete the transaction with the asterisk key as described in section 3.1.

3.5 Using quantity PLU and multiplication

With the multiplication function, you can enter several items for a PLU. How to create a PLU for items is described in section 3.1.

0 ... 9 **PLU**

0 ... 9

X

0 ... 9 **V1**

...

1. Enter the PLU number of the item and press the PLU key.
The unit price and the item name appear in the display as a check.

or

- ▶ Enter the unit price.
2. Press the X key to call up the multiplication function.
 3. Enter the number of items and confirm with the vendor key.
The multiplication mode is ended.
 4. Enter further items and complete the transaction with the asterisk key as described in section 3.1.

3.6 Using tare

You fill containers with your products or customers bring their own container. The tare function makes sure that only the goods are entered and paid.

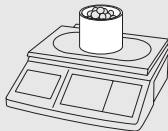
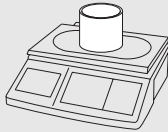

...

1. Place the empty container on the scale.
2. Press the tare key.
The scale is tared.

The weight display is reset to 0.000 kg and the NET symbol appears. The tare weight is displayed in the bottom line of the display.

3. Fill the container with the goods to be weighed.
4. Carry out the transaction as described in section 3.1 and complete it with the vendor key.
The tare value is cleared.
5. Enter further items and complete the transaction with the asterisk key as described in section 3.1.



Known tare weights can also be entered via the keyboard, refer to manual tare in setup point 445.

3.7 Zeroing

Due to soiling on the weighing pan or unfavourable external influences, it is possible that the weight display of an unloaded weighing pan may no longer be 0.000 kg. In such cases, the scale must be reset to zero.

0.010 kg

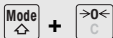

+



0.000 kg

- ▶ While holding the mode key, press the zeroing key.

The weight display is set to zero.

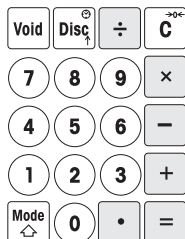

3.8 The scale as a calculator

The scale not only performs all calculations for you during sales; it also performs any other calculations.

In the calculator mode, the keys have the shown values.

The mathematical operators are shown on the lower left of the keys.



Calling up the calculator mode

- ▶ While holding the mode key, press the calculator key (V1).
CALCULA appears on the display. The calculator mode is active.

Input	Display	Example: $3 \times 5 + 5.67$
3 x	3	
5	5	
+	15	
5.67	5.67	
=	20.67	

Notes

- The calculation is finished when the = key is pressed. It is not possible to continue with this calculation.
- To end the calculation mode, again press and hold the mode key and then press the calculation key (V1).

3.9 The scale as a clock

You can display the date and time in the display at any time.



- ▶ While holding the mode key, press the clock (DISC) key.
The date and time are displayed.



- When the date and time are displayed on the scale, you cannot weigh or enter values.
- To return to the scale mode, again press and hold the mode key and then press the DISC key.

The clock as a screen saver

When the "sleep mode" is activated in setup point 412, the scale always displays the time when there has been no scale activity for 3 minutes. As soon as a weight is put on the scale or a key is pressed, the weight display again appears.

4 Active selling

4.1 Voiding

Your customer decides not to buy one or more items that have already been weighed, but not paid. In this case, you can void the items that are not wanted.

Before totalling, you can void one or more vendor entries.

The following procedures are described based on the factory settings.

Voiding individual entries



1. Enter, but not total one or more PLUs or direct price items to a vendor key, also refer to chapter 3 on entering.
2. Press the void key.
Unit price, total price per PLU and PLU number of the item that was last entered appear in the display.
3. Use the minus key or the discount key to select the entry to be voided.
4. Confirm the selected entry with the asterisk key.
VOID OK appears in the display.
5. If more entries should be voided, repeat steps 2 to 4.
6. Enter further items and complete the transaction with the asterisk key as described in section 3.1.
The voided entries are printed on the ticket.

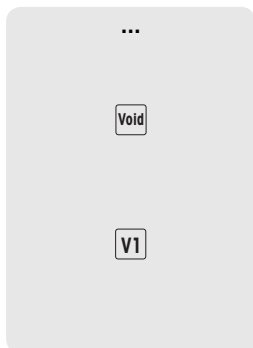

Voiding all entries

1. Enter, but not total one or more PLUs or direct price items to a vendor key, also refer to chapter 3 on entering.
2. Press the void key.
Unit price, total price per PLU and PLU number of the item that was last entered appear in the display.
3. Press the vendor key.
The message VOID ALL appears in the display. All of the vendor's entries are voided.
A void ticket is created.

Now you can serve the next customer.

4.2 Granting a discount

You want to grant your customer a discount in percent. With the factory settings, you can grant a discount on a single entry or on the total sum.

Granting a discount on a single entry

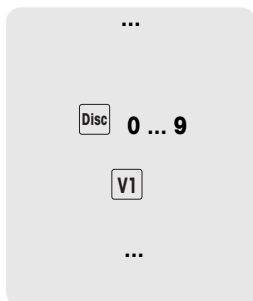

1. Weigh the PLU item as described in chapter 3, but do not confirm it with the vendor key.
2. Press the discount key and enter the discount in percent.
3. Confirm the discount with the vendor key.
4. Enter further items and complete the transaction with the asterisk key as described in section 3.1.
The discount is printed on the ticket.

Granting a discount on the total sum



1. Enter items and total with the asterisk key as described in chapter 3.
2. Press the discount key and enter the percent discount for the total sum.
3. Confirm the discount with the asterisk key.
4. Complete the transaction as described in section 3.1.
The discount is printed on the ticket.



In setup point 116, you can define automatic discount promotions for a specific time period for individual PLUs or groups.

4.3 Granting a rebate on the total sum

You want to decrease or round down single entries or end amounts. The rebate function allows - contrary to the discount function - to give absolute price reductions.

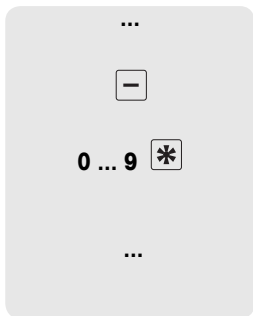

1. Enter items as described in chapter 3.
2. Press the minus key.
3. Enter the amount of the rebate to two decimal places and confirm with the asterisk key.
4. Enter further items and complete the transaction with the asterisk key as described in section 3.1.
The decrease is printed on the ticket.



If you always want to reduce the total sum or single items by one or two decimal places, then you can enter these settings in setup point 431.

4.4 Refunding (ST)

Your customer has paid for an item, but wants to return it. To partially or completely refund the sales price, use the refund function.

The following processes are described based on the factory settings.

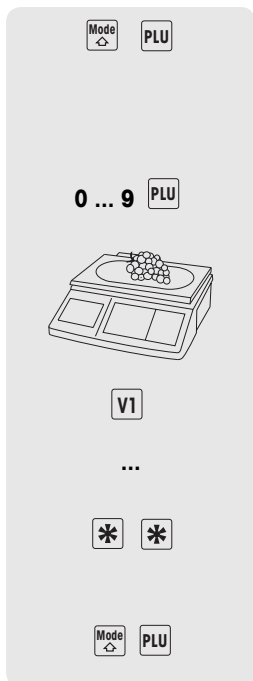

1. While holding the mode key, press the PLU key.
The scale switches to the refund mode, the status ST appears in the lower line of the display.
2. Enter the direct price or the PLU number of the items that are to be refunded and press the PLU key.
The unit price or item price and the item name appear in the display as a check.
3. Place the item that is to be refunded on the scale or enter the quantity.
4. Confirm the negative entry with the vendor key.
5. For more refunds, repeat steps 2 to 4.
6. Press the asterisk key twice to complete the refund.
A refund ticket is printed.
7. To return to the weighing mode, simultaneously press the mode key and the PLU key.

4.5 Suspending a transaction (ticket parking)

You have weighed and entered the items the customer wanted. The customer is not able to pay immediately. In this case, you can suspend the already entered transaction and serve other customers in the meantime.

The following procedure is described based on the factory settings.

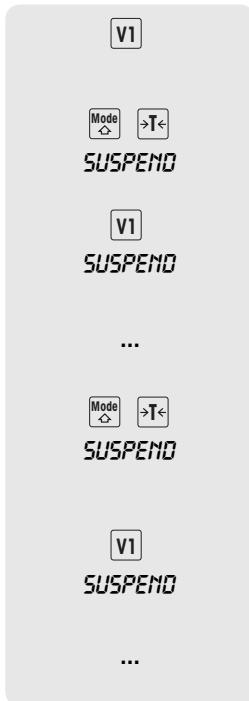

1. Carry out the transaction as described in section 3.1 and confirm it with the vendor key, but do not total it.
2. While holding the mode key, press the tare key.
SUSPEND appears in the display.
3. Press the vendor key.
SUSPEND appears in the display. Two short acoustic signals confirm that the transaction was suspended.
4. You can now serve other customers.
5. To recall the suspended transaction, press the tare key while holding the mode key.
SUSPEND appears in the display.
6. Press the vendor key.
SUSPEND appears in the display. Two short acoustic signals confirm that the suspended transaction was recalled.
7. Complete the transaction as described in section 3.1.
The ticket is printed.



- Each vendor can only suspend one transaction.
- If a suspended transaction is not completed, then the message NO MORE SUSPEND appears when you try to suspend another transaction.

4.6 Working with several vendors

Up to 8 vendors can be activated on the scale. They are automatically assigned to the vendor keys V1 to V8.

The factory setting is one activated vendor.

Condition

1. Working with several vendors is activated under setup point 409.
2. Vendor names can be entered under setup point 105 if desired.
3. Individual passwords for the vendors can be defined under setup point 801 if desired.

4.6.1 Activating several vendors



1. Go to setup with the mode key and then press 2.
2. Enter the password: Enter the number 6 six times and confirm with the asterisk key.
3. Activate setup group 04: enter the number 4 and confirm with the asterisk key.
4. Call up setup point 409: enter the number 9 and confirm with the asterisk key.
5. Enter the number of vendors (1 to 8) and confirm with the asterisk key.
6. Exit setup: press the mode key 3 times.

The number of vendors entered is now activated on the scale.



- When working with more than one vendor, the occupied vendor keys can no longer be used as preset keys.
- In the basic state, the scale displays the logged-in vendor in the bottom line of the display. For example, "V 123 BON" means that vendors 1, 2 and 3 are logged in.
- Setup can be accessed in two different ways with different authorizations. Further information can be found in section 5.11, setup group 8

4.6.2 Working with several vendors

When working with several vendors, each vendor has to use his/her vendor key to enter items.

Example Vendor 2 has weighed several items and wants to complete his/her transaction.

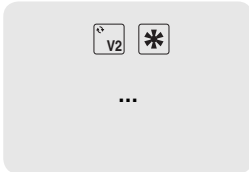

1. To total up, press the vendor key V2 and then the asterisk key.
2. Complete the transaction as described in section 3.1 .
The ticket is printed.

- If more than one vendor is active, then a vendor's entries are hidden after approx. 2 seconds to prevent incorrect entries.
- If a vendor tries to complete a transaction directly with the asterisk key without his/her vendor key, then the message USER IDENT appears.
- The vendor messages are retained when the scale is turned off and back on.

4.7 Customer change function

The scale calculates the customer's change for you.



1. Total the items using the asterisk key.
2. Enter the customer's payment and confirm with the asterisk key.

The scale displays the change and prints the ticket.

If the change should not be printed on the ticket, then this can be turned off in setup point 222.

4.8 Various payment methods

With the factory settings, the scale only accepts cash payment. However, you can also enter vouchers, credit cards and cheques as payment methods. To do this, MULTI-PAY must be enabled in setup point 443.

4.8.1 Enabling multiple payment

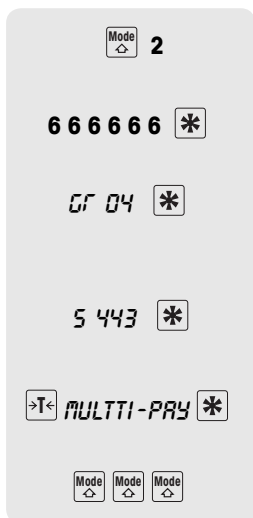

1. Use the mode key to go to setup and then press 2.
2. Enter password: enter the number 6 six times and confirm with the asterisk key.
3. Activate setup group 04: enter the number 4 and confirm with the asterisk key.
4. Call up setup point 443: enter the numbers 4 and 3 and confirm with the asterisk key.
5. Use the tare key to select MULTI-PAY and confirm with the asterisk key.
6. Exit setup: press the mode key 3 times.

In addition to cash, it is now possible to pay by voucher, credit card and cheque.

Key assignments

The various payment methods are assigned to the following keys:

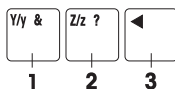

- 1 Voucher
- 2 Credit card
- 3 Cheque

4.8.2 Paying by credit card

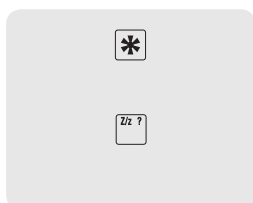

1. Carry out the transaction as described in section 3.1 and total it with the asterisk key.
2. Press the Z key.
The ticket is printed with the information that it is a credit card payment. The cash drawer does not open.

4.8.3 Paying by cheque



1. Carry out the transaction as described in section 3.1 and total it with the asterisk key.
2. Press the "left" cursor key.
The ticket is printed with the information that it is a cheque payment. The cash drawer does not open.

4.8.4 Paying with a voucher

Version 1

The amount of the voucher exceeds the total sum. You give the customer the difference in cash.



1 ... 8



1. Carry out the transaction as described in section 3.1 and total it with the asterisk key.
2. Press the Y key.
3. Enter the amount of the voucher and confirm with the asterisk key.
The message C CHG appears in the bottom line of the display. The ticket is printed with the information that it is a voucher payment and with the amount of cash change. The cash drawer opens.

Version 2

The amount of the voucher exceeds the total sum. You give the customer the difference in the form of another voucher.



4. Carry out the transaction as described in section 3.1 and total it with the asterisk key.
1. Press the Y key.
2. Enter the amount of the voucher and confirm with the Y key.
The message V CHG appears in the bottom line of the display. The ticket is printed with the information that it is a voucher payment and with the amount returned in the form of a voucher. The cash drawer does not open.

Version 3 The amount of the voucher does not completely cover the total sum. The customer can pay the difference in cash or with a credit card.



1 ... 9

1 ... 9

1 ... 9

1. Carry out the transaction as described in section 3.1 and total it with the asterisk key.

2. Press the Y key.

3. Enter the amount of the voucher and confirm with the Z key to pay the difference with a credit card.

The ticket is printed with the information that it is a credit card and voucher payment. The cash drawer does not open.

or

▶ Enter the amount of the voucher and confirm with the asterisk key to pay the difference in cash.

▶ Enter the amount of the cash payment and confirm with the asterisk key.

The ticket is printed with the information that it is a voucher and cash payment and with the amount of cash change. The cash drawer opens.



It is not possible to combine voucher and cheque payment.

4.9 Basket function

Your customers pick themselves, e.g. strawberries, and bring their own baskets. If the basket function is enabled, you can save the weight of each basket and recall it when weighing. In this way, your customer only pays for what was actually picked.

4.9.1 Enabling the basket function



1. Use the mode key to go to setup and then press 2.
2. Enter password: enter the number 6 six times and confirm with the asterisk key.
3. Activate setup group 04: enter the number 4 and confirm with the asterisk key.
4. Call up setup point 444: enter the number 4 twice and confirm with the asterisk key.
5. Use the tare key to select ENABLE and confirm with the asterisk key.
6. Exit setup: press the mode key 3 times.

The basket function is now enabled.

Key functions when the basket mode is enabled

V	Saves the tare weight
Space key	Calls up the saved tare weight



- The V key and the space key can no longer be used for PLUs.
- Manual tare can be enabled in setup point 445. Known tare weights can then be entered using the P key.

4.9.2 Working with the basket function

Saving the basket weight

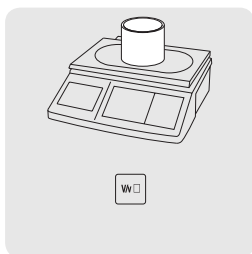

1. Place the empty basket on the scale.

2. Press V.

The basket weight is saved. A ticket with the number and weight of the basket is printed.



- A max. of 999 different basket weights can be saved in the scale.
- If you have reached basket number 999, the scale automatically creates and prints a basket report. The basket number is then reset to 1.

Calling up the basket weight

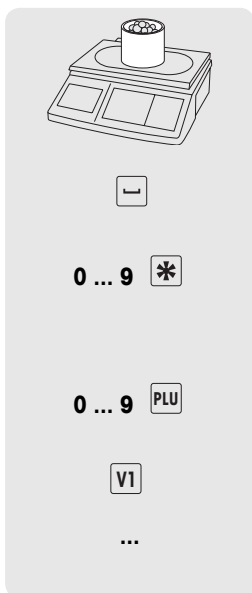

1. Place the filled basket on the scale.

2. Press the space key to call up the saved basket weight.

3. Enter the basket number and confirm with the asterisk key.
The symbol NET, the net weight and the tare weight appear in the instruction field.

4. Enter the associated PLU number and press the PLU key.
The unit price and item name appear in the display as a check.

5. Confirm the transaction with the vendor key.

6. Complete the transaction as described in chapter 3.

4.10 Working with 2 PLUs per preset key

PLUs can be assigned to PLU preset keys on 2 levels.
To do this, 2 PLU must be enabled in setup point 405.

4.10.1 Enabling 2 PLUs per preset key



1. Use the mode key to go to setup and then press 2.
2. Enter password: enter the number 6 six times and confirm with the asterisk key.
3. Activate setup group 04: enter the number 4 and confirm with the asterisk key.
4. Call up setup point 405: enter the number 5 and confirm with the asterisk key.
5. Use the tare key to select 2 PLU and confirm with the asterisk key.
6. Exit setup: press the mode key 3 times.

Now, 2 PLUs can be stored per preset key.

4.10.2 Assigning 2 PLUs to a preset key

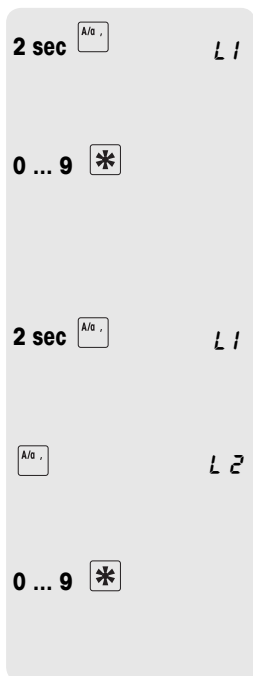

1. Press down and hold the desired preset key, e.g. the A key, for approx. 3 seconds.
The message L1 appears in the display.
2. Enter the PLU number for level 1 and confirm with the asterisk key.
Two short acoustic signals confirm that the PLU is assigned to level 1.
3. Press down and hold the desired preset key, e.g. the A key, for approx. 2 seconds.
The message L1 appears in the display.
4. Briefly press the preset key once.
The message L2 appears in the display. You can assign a level 2 PLU.
5. Enter the PLU number for level 2 and confirm with the asterisk key.
Two short acoustic signals confirm that the PLU is assigned to level 2.

4.10.3 Calling up PLUs



Calling up a level 1 PLU

- Briefly press the relevant preset key, e.g. the A key one time.
The unit price and the item name appear in the display as a check.

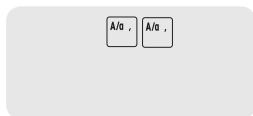

Calling up a level 2 PLU

- Briefly press the relevant preset key, e.g. the A key two times.
The unit price and the item name appear in the display for checking purposes.

5 Setup

5.1 Overview

In the setup mode, you can set up the scale to handle your special sales and back office tasks. Specific functions and groups are only accessible if you have a license. Ask your sales representative.

The setup mode features are organized in 10 groups:

01 – Info Input In this group you enter your item data (PLUs) and ticket and label printing information.

02 – Label/Ticket In this group you define what information should appear on the print-out.

03 – Data Clear In this group you delete item data.

04 – Operation In this group you define operating sequences.

05 – Service Mode This group can only be accessed by the service engineer.
Only exception: setup point 518 - language settings

06 – Reports The scale assists you with evaluations. In this group you set up your reports.

07 – Network Configuration In this group, you enter the settings to communicate with a computer or to operate the scale in a network, e.g. to work in the integrated operation mode.

08 – Password The setup mode is password protected. You can enter passwords and authorizations here.

09 – Tests and Servicing This group can only be accessed by the service engineer.

10 – Extra This group can only be accessed with a network license and contains additional functions such as self service and label printing.

5.2 List of all setup points

The most important and most frequently used points are indicated in **bold** print.

Group 1: Information input

101	PLU EDIT
102	PRICE CHANGE
103	PLU CONTENT
104	GROUP EDIT
105	VENDOR EDIT
106	DATE/TIME
107	SHOP EDIT
108	SCALE NO.
109	HEAD/FOOTER
111	TARE EDIT
112	BARCODE
113	BAR C VS T/L
116	DISCOUNT ITEMS
122	PRINT PLU

Group 2: Label/ticket

201	RESTORE DEF
203	PRINTING
205	PRN STUB
206	PRN COPY
207	PRN METHOD
216	AFTER DESCRP
217	PRN SCALE
218	PRN VENDOR
219	PRN DATE
220	PRN TICK.NO.
222	PRN CHG
223	PRN BARCODE
224	PRN VOID
225	PRN LOGO
230	TARE PRN
231	PRN TOTAL

Group 3: Deleting data

301	DELETE PLU
302	DELETE GROUP
305	RESET SCALE
306	PID LID
307	DEL LOG

Group 4: Operation

401	RESTORE DEF
402	CALL PLU TEXT
403	LOAD PLU TYPE
404	PRINT EDIT
405	PRESET PLU
406	PRICE CHANGE
408	HAND PRICE
409	VENDOR QTY
411	TARE/P CLEAR
412	SLEEP MODE
413	LIGHT TYPE
414	ST
415	VOID
416	QTY SOLD
430	ROUND CONFIG
431	CUT CONFIG
432	CUT EFFECT
433	CUT KEY
434	CUT CHANGE
438	PRINT SPEED
439	CONTRAST
440	FIRST DAY TYPE
441	FILTER TYPE
442	ECR CHECKOUT
443	MULTI-PAY
444	BASKET-FUNC
445	TM KEY
446	TRAINING
450	PLU CONFIG
451	SAVE LOG

Group 5: Service mode

518	SET LANGUAGE
-----	--------------

Group 6: Reports

601	RESTORE DEF
602	SALES REPORT
603	PLU REPORT
604	PROMOTION REP
605	GROUPS
607	HOURLY RPT
610	ST/RETN RPT
611	VENDOR RPT
613	WEEKLY RPT
616	COMBINE
617	LOG
618	BASKET RPT
622	VAT REPORT
623	DEL REPORT
624	DEL ALL REPT
625	DEL AU/MA

Group 7: Network configuration

701	RS-232
702	ETHERNET
703	WORK MODES

Group 8: Password

801	PW MANAGER
802	RIGHT LIMIT

Group 10: Extra

1003	PRODUCT DATE
1004	EXTRA TEXT
1005	PRN TYPE
1006	D L W FORMAT
1007	D L Q FORMAT
1008	D P W FORMAT
1009	D P Q FORMAT
1010	D L T FORMAT
1011	ACT TO V1
1016	SELF-SERVICE
1017	GROUP H RPT
1020	CASHDRAW RPT
1021	MONTHLY RPT
1022	YEARLY RPT
1025	PLU REPORT
1026	MODE SWITCH

5.3 Setup operation

5.3.1 Entering setup

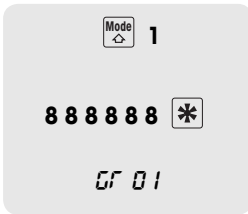

1. Use the mode key to go to setup and then press 1.
2. Enter password: enter the number 8 six times and confirm with the asterisk key.

The first setup group is displayed.









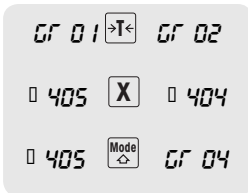



Setup can be accessed in two different ways with different authorisations. Further information can be found in section 5.1.1, setup group 8.

5.3.2 Key functions during setup

The following keys can be used during setup:



-  Confirm selection / complete entry
-  Page forwards, e.g. Gr 01  Gr 02  Gr 03 ...
-  Page backwards, e.g. S 405  S 404  S 403 ...
-  Go back a level, e.g. S 405  Gr 04  0.000 kg



Within a setup group, a point can be called up directly by its number.

5.3.3 Ending setup



- ▶ Press the mode key repeatedly until the weight display appears again.

The scale is now again in the normal operating mode.

5.3.4 Example: price change for PLU 25

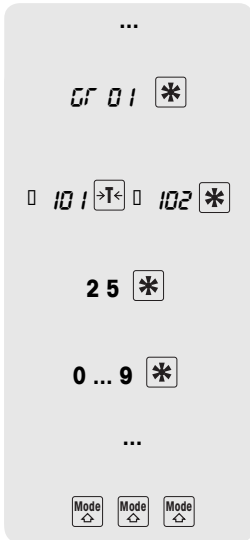

1. Enter setup as described in section 5.3.1.
2. Activate setup group 01 with the asterisk key. S 101 is displayed.
3. Use the tare key to go to S 102 and confirm with the asterisk key.
4. Enter an existing PLU number (in the example: 25) and confirm with the asterisk key.
5. Enter the new unit price and confirm with the asterisk key.
6. To change other PLUs, repeat steps 4 and 5.
7. To exit the setup mode, press the mode key 3 times.

5.3.5 Direct access using the setup shortcut keys

It is possible to directly access a setup point using shortcut keys in the left key field.

101 Edit PLU	B/b .	C/c /	605 Group Report	E/e (F/f)
102 PLU Price Change	116 Discount Items	616 Combine Reports	J/j \$	K/k [L/l]
104 Edit Group	N/n ;	602 Sales Report	P/p `	613 Weekly Report	R/r -
S/s >	T/t <	603 PLU Report	611 Vendor Report	W/w @	X/x %
V/v &	Z/z ?	607 Hourly Report	←	→	↻

1. To call up setup, refer to section 5.3.1.
2. Press the shortcut key.

The corresponding setup point is called up.



You can print a list of all shortcut keys and the assigned menu points by pressing the mode key and then key V6.

5.3.6 Text input

Text is entered using the alphanumeric key field.

Function keys

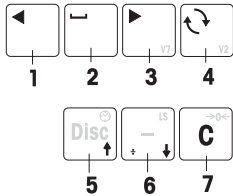

The bottom row of the alphanumeric key field and the upper row of the right key field have the following function keys for entering text:

- 1 Left cursor key
- 2 Space
- 3 Right cursor key (V7)
- 4 Shift key uppercase/lowercase/special symbols (V2)
- 5 One line up
- 6 One line down
- 7 Delete characters

Upper/lower case

The entered characters are shown in the display. Repeatedly pressing the shift key shows the following values in the given sequence:

- , Upper case letters
- 5 Lower case letters
- , Special characters
- z Unicode characters

Example Entering "Fruit -10%"

Switch	Type	Input
-	L	F
	5	r u i t
	z	00150 (-)
	L	10
	,	%



All allowed characters are listed in the "Unicode Characters" table in the appendix.

5.4 Setup group 1

In this group you enter your item data (PLUs) and ticket and label printing information.

5.4.1 Tips for setting up and configuring PLUs

Edit PLUs (101) ► Save your items (PLUs) in setup point **101**.

With the factory settings, a PLU contains the following components (item specifications) that describe the item:

- PLU number
- PLU name
- Price type (by weight/by count)
- Unit price

PLU contents (103) Depending on your operating sequence requirements, 1 to 10 pieces of information can be assigned to a PLU, e.g. the item number from your merchandise information system.

► Configure the contents of a PLU in setup point **103**.

Thus, the PLUs contain exactly the information that is important to you.

Groups (104) Categorize your sales in groups (cheese, fruit, vegetables, ...).

An individual value added tax rate can be assigned to each group (VAT rate).

► Create your groups in setup point **104**.

PLU tare (111) Store the tare weight in the PLU when the product is always sold in the same packaging.

► Create your groups in setup point **111**.

Call up a PLU (403) You can choose whether the PLU should be automatically called up when the PLU number is entered or via the PLU key.

Factory setting: call up via PLU key

► Enter your operating sequence in setup point **403**.

5.4.2 Example

You want to

- Assign an item number from your merchandise information system as well as a PLU number to your items
- Categorize your items in groups
- Assign a VAT rate to your PLUs
- Assign a tare weight to a specific PLU

1. Step Entering item contents in setup point 103

In the example, the following item contents will be needed:

- ID1 – DESCRIPT (item number)
- ID3 – Group and VAT rate
- ID7 – Tare

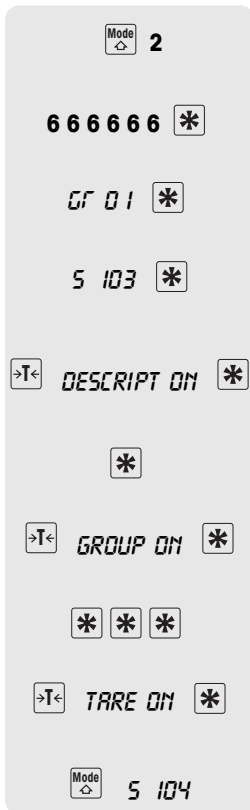

1. Use the mode key to go to setup and then press 2.
2. Enter password: enter the number 6 six times and confirm with the asterisk key.
3. Confirm setup group 01 with the asterisk key.
4. Call up setup point 103: enter the number 3 and confirm with the asterisk key.
5. Use the tare key to select ID1 DESCRIPT ON and confirm with the asterisk key.
6. Accept ID2 DESCRIPT ON with the asterisk key.
7. Use the tare key to select ID3 GROUP ON and confirm with the asterisk key.
8. Skip ID4 to ID6: to do this, press the asterisk key 3 times.
9. Use the tare key to select ID7 TARE ON and confirm with the asterisk key.
10. Exit setup point 103 with the mode key.
The scale goes to the next setup point 104.

When you enter PLUs in setup point 101, you will be asked for the item number, group and tare.

2. Step Setting up groups in setup point 104

This lets you better categorize your product range.

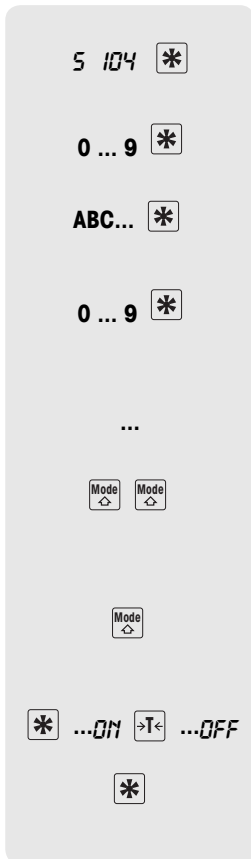

1. After finishing setup point 103, confirm setup point 104 with the asterisk key.
2. Enter the desired group No. and confirm with the asterisk key.
3. Enter the name of the group, e.g. fruit, using the keys in the left key field (refer to section 5.3.6) and confirm with the asterisk key.
4. Enter the VAT rate with two decimal places, e.g. 7.00, and confirm with the asterisk key.
With the factory settings, the VAT will be printed on the ticket.
5. Repeat points 2 to 4 for other groups.
6. To exit setup point 104, press the mode key 2 times.
The scale goes to the next setup point 105.

or

- ▶ To enable/disable printing of the VAT on the ticket, press the mode key once.
PRN VAT Y/N appears in the display.
- ▶ Press the asterisk key and use the tare key to toggle between PRN VAT and NOT PRN VAT.
- ▶ Confirm the print settings with the asterisk key.
The scale goes to the next setup point 105.

- The VAT for direct price items can be entered in group 0.
- A maximum of 20 groups can be entered.



3. Step Entering PLU tare weights in setup point 111

5 111 *

0 ... 9 *

0 ... 9 *

LS
↓

...

Mode
↔

1. After finishing setup point 104, call up setup point 111: enter the number 1 twice and confirm with the asterisk key.
2. Enter the desired tare No. and confirm with the asterisk key.
3. Enter the tare weight and confirm with the asterisk key.
or
▶ Place the empty container on the scale, accept with the LS key (down arrow) and confirm with the asterisk key.
4. Repeat points 2 and 3 for other groups.
5. Exit setup point 111 with the mode key.
The scale goes to the next setup point 106.



A maximum of 20 tare weights can be saved.

4. Step Entering item information (edit PLUs) in setup point 101

After all item contents have been defined, you can start entering your item data.

5 101 *

0 ... 9 *

0 ... 9 *

ABC... *

0 ... 9 *

WEIGHT \rightarrow T \leftarrow COUNT

*

0 ... 9 *

0 ... 9 *

PLU SAVE *

...

Mode \leftarrow Mode \leftarrow Mode \leftarrow

1. After finishing setup point 111, call up setup point 101: enter the number 1 and confirm with the asterisk key.
2. Enter the desired PLU No. and confirm with the asterisk key.
3. Enter the desired description (item number) and confirm with the asterisk key.
4. Enter the item name using the keys in the left key field and confirm with the asterisk key.
5. Enter the desired group number and confirm with the asterisk key.
6. Select the price type (weight or quantity) with the tare key.
7. Confirm the price type with the asterisk key.
8. Enter the unit price and confirm with the asterisk key.
9. Enter the correct tare weight and confirm with the asterisk key.
10. Confirm PLU SAVE with the asterisk key.
11. For more items, repeat steps 2 to 10.
12. To exit the setup mode, press the mode key 3 times.

5.4.2 Ticket layout

You can lay out your cash register ticket as desired. At the factory, the scale is setup so that the PLU name, unit price, weight/quantity and price appear on the ticket. You can add the following information:

1	→ TANNER 	
2	→ OBST UND GEMÜSE *****	
3	→ Ockerweg 3 35396 Gießen	
4	→ Verkäufer: Susan Bon Nr:0012	8
5	→ 08082008 08:08 Geräte Nr:01	9
	PLU TEXT	
	Kg(ST) € /kg(ST) €	

	Karotte 0,210 2,50 0,53	
	Apfel 2 0,45 0,90	

	ST 3 Total 1,43	
6	MWSt 7 % 0,09	

	Total 1,43	
	Bar 5,00	

	Zurück 3,57	
7	→ Vielen Dank für Ihren Einkauf Auf Wiedersehen	

1. Logo - set up in setup point 225
2. Shop name - set up in setup point 107
3. Header - set up in setup point 109 (header/footer)
4. Vendor name- set up in setup point 105
5. Date and time - set up in setup point 219
6. VAT - set up in setup point 104
7. Footer - set up in setup point 109 (header/footer)
8. Ticket number - set up in setup point 220
9. Scale number - set up in setup point 217

5.4.3 Remarks on barcodes

Barcode applications

- Printing barcodes in the following formats:
EAN 8, Code 25, EAN13, Code 39, Code 25, EAN128, UPC8, Code 13+5.
- Calling up PLUs in EAN13 and EAN8 formats with a scanner.
- Reading in tickets in EAN13 format with a scanner.
To do this, the ECR CHECKOUT function must be enabled in setup point 442.

Creating barcodes

Barcodes are configured in setup point 112.

The information that your barcode should contain is defined with the following parameters:

Barcode parameters

Parameter	Explanation	Note
0-9	Numbers	max. 12 digits
A	Item number	max. 12 digits
B	Amount	max. 7 digits
C	Checksum	1 digit
N	Ticket number	4 digits
P	PLU number	4 digits
Q	Weight/quantity	max. 5 digits
W	Group no.	max. 2 digits

Example Creating EAN 13 with ID 23, 5-digit item name, 5-digit amount and checksum

1. Call up setup point 112.
2. Enter the desired barcode number and confirm with the asterisk key.
3. Select the desired barcode format, e.g. EAN 13.
4. Enter barcode parameters e.g. 23 AAAAA BBBB C.
5. Enter the number of places the item number should be moved using the cursor keys and confirm with the asterisk key.
6. Enter the number of places the amount should be moved using the cursor keys and confirm with the asterisk key.
7. Select the checksum type using the tare key and confirm with the asterisk key.
8. Enter other barcode formats: to do this, repeat steps 2 to 7.



- After entering a barcode, select setup point 113 to create a relationship between the defined barcode format and a ticket/label.
- If a barcode format starts with two digits, then these two digits cannot be used for other formats.
- Entering a positive number under the sub-points A shift, B shift ... means moving to the right, a negative number means moving to the left.

Linking the barcode format to the ticket or label.

Example Barcode 3 should be printed on ticket format 1.

1. Call up setup point 113.
2. Select the ticket or label type using the tare key and confirm with the asterisk key.
3. Select the ticket format using the tare key, e.g. format 1, and confirm with the asterisk key.
4. Select the desired barcode using the tare key, e.g. barcode 3, and confirm with the asterisk key.
5. To exit the setup mode, press the mode key repeatedly until the weight display appears.



- In order for the barcode to be printed, "PRN BARCODE" must be selected in setup point 223.
- The item number cannot be printed as a barcode on tickets with several entries.



Reading in barcodes with a scanner

- You can read in PLUs as barcodes using a scanner.
- You can read in complete entries incl. the price as a barcode using the scanner. Please note the following:
 - Setup point 442 "ECR CHECKOUT" must be enabled.
 - Only barcode format EAN 13 is allowed.
 - Only one vendor can be active.

5.4.4 Granting a discount

Discounts can be granted in two different ways:

- manually using the discount key and
- automatically after entering the discount parameters in setup point 116.

In setup point 116, the scale provides several ways of defining an automatic discount:

- Discount promotion for a specific period of time
- Discounts on individual PLUs
- Discounts on individual groups
- Discounts on all items
- Discounts on the total sum
- Quantity discounts

Example You want to grant a 5 % discount on veal cutlet for weights over 500 g from 10.01.2008 until 14.01.2008. The promotion will start on January 10 at 8:30 a.m. and end on January 14 at 6:30 p.m.

1. Call up setup point 116 and sub-point DISCPROMO with the asterisk key.
2. Enter the starting date of the discount promotion in the following order: day, month, year and confirm with the asterisk key.
3. Enter the time the discount promotion shall start in the following order: hour, minute, second and confirm with the asterisk key.
4. Enter the date when the discount promotion ends and confirm with the asterisk key.
5. Enter the time the discount promotion should end and confirm with the asterisk key.
6. Use the tare key to scroll to the sub-point PLU and confirm with the asterisk key.
7. Enter the PLU number of the item to be discounted and confirm with the asterisk key.
8. Enter the discount rate and confirm with the asterisk key.
9. Enter the minimum weight for which the discount will be granted (condition) and confirm with the asterisk key.



5.4.5 Overview of setup group 1

- For access and navigation in setup, refer to section 5.3.1.
- For entering text, refer to section 5.3.3.
- Factory settings are indicated in **bold** print.

No.	Display	Description	Notes
101	PLU EDIT	Enter PLUs	
	PLU NUMBER	Enter desired PLU number	Possible values: 1 ... 9999
	PLU NAME	Enter PLU name	Max. 15 characters
	BY WEIGHT/BY COUNT	Select price by weight or item price	Select with the tare key
	UNIT PRICE	Enter unit price	
	PLU SAVE/ PLU ABORT	Save or cancel inputs	Select with the tare key
<hr/>			
Depending on the settings in point 103, more parameters can appear here. Then, either enter the next PLU or use the mode key to go to the next setup point.			
102	PRICE CHANGE	Change the prices of existing PLUs	
	PLU NUMBER	Select desired PLU number	Enter number or scroll through with the tare key or X key.
	UNIT PRICE	Enter new price	
<hr/>			
Then, either change the next PLU or use the mode key to go to the next setup point.			
103	PLU CONTENT	Define the contents of a PLU that should be printed	
	ID1 DESCR NO.	Switch working with additional item number on and off, e.g. numbers from the merchandise information system	Factory setting: NO
	ID2 DESCRIPTION	Switch item description on/off	Factory setting: on
	ID3 GROUP	Switch group on/off	Factory setting: NO
	ID4 PRICE	Switch unit price on/off	Factory setting: on
	ID5 QUANTITY	Switch quantity by piece or weight on/off	Factory setting: on Only for USA
	ID6 FIX WT	Switch working with a fixed tare weight on/off	Factory setting: NO
	ID7 TARE NO.	Switch tare number on/off	Factory setting: NO
	ID8 SELL BY *	Switch sell by date on/off	Factory setting: NO
	ID9 BEST BEFORE *	Switch best before date on/off	Factory setting: NO
	ID10 LABEL NO. *	Switch ticket No. assignment on/off	Factory setting: NO
	ID11 EXTRA TEXT *	Switch extra text on/off	Factory setting: NO
<hr/>			
*	These functions can only be used when the scale is equipped with a network license. Contact your sales representative.		

No.	Display	Description	Notes
104	GROUP EDIT	Create group	
	GROUP NO.	Enter the desired group number	Possible values: 1 ... 20
	GROUP NAME	Enter the name of the group	Max. 20 characters
	INPUT VAT	Enter the value added tax	Enter with two decimal places, e.g. 7.00 %
		Then, either create the next group or continue with the mode key.	
	PRN VAT Y/N	Print the VAT on the ticket	
	PRN VAT/NOT PRN VAT	Switch printing of the VAT on the ticket on/off	Factory setting: on
105	VENDOR EDIT	Enter vendor	
	VENDOR NO.	Enter vendor number	Max. 8 vendors
	VENDOR NAME	Enter vendor name	Max. 20 characters
		Then, either enter the next vendor or use the mode key to go to the next setup point.	
106	DATE/TIME	Setting date and time	
	DD-MM-YY	Enter day, month, year	Enter date and time in the displayed format
	HH-MM-SS	Enter hours, minutes, seconds	
107	SHOP EDIT	Enter shop data	
	SHOP EDIT	Enter name, address, ...	Max. 9 lines with 25 characters each
108	SCALE NO.	Scale number(when the scale is connected to a network)	
	SCALE NO.	Enter the scale number	Possible values: 1 ... 99
109	HEAD/FOOTER	Enter the text for the ticket header and footer	
	HEADER	Enter the header text for the ticket	Max. 9 lines with 33 characters each
	FOOTER	Enter the footer text for the ticket	
111	TARE EDIT	Enter known tare weights	
	TARE NO.	Enter the tare number	Possible values: 1 ... 20
	TARE	Enter the corresponding tare weight or place the empty container on the scale and accept with ↓	Tare < scale capacity
		Then, either enter the next tare weight or use the mode key to go to the next setup point.	

No.	Display	Description	Notes
112	BARCODE	Create barcodes	
	BAR	Enter barcode number	Possible values: 1 ... 12
	EAN 13/...	Select the desired barcode format using the tare key and enter barcode text	Refer to section 5.3.3
	A SHIFT	Move the item number	Possible values: -12 ... +12
	B SHIFT	Move the amount	Negative values: to the left
	Q/W SHIFT	Move the unit price per weight	Positive values: to the right
	Q/Q SHIFT	Move the item price	
	C PARITY	Select 1 (uneven) or 2 (even) using the tare key	
Then, either enter the next barcode or use the mode key to go to setup point 113 to assign the entered barcode formats to a ticket/label.			
113	BAR C VS T/L	Assign entered barcodes to the ticket or label.	
	LABEL*/TICKET	Select label or ticket	
		Enter label/ticket	
	BARCODE	Enter relevant barcode number	Barcodes are defined in setup point 112. Printing of barcodes must be activated in setup point 223.
	*	It is only possible to print labels when the scale has a network license. Contact your dealer.	
Then, either enter the next label/ticket or use the mode key to go to the next setup point.			
116	DISCOUNT ITEMS	Enter discount promotion	
	DISCPROMO	Enter a promotion which automatically grants a discount	
	FROM DD-MM-YY	Start of discount: Day, Month, Year	
	FROM HH-MM-SS	Start of discount: Hours, Minutes, Seconds	
	TO DD-MM-YY	End of discount: Day, Month, Year	
	TO HH-MM-SS	End of discount: Hours, Minutes, Seconds	
	ALL ITEMS	Same discount for all items	
	PERCENT*	Enter discount in percent	
	GROUP	Discount by group	
	GRP	Enter group	
	PERCENT*	Enter discount in percent	
Then, either enter the next group or use the mode key to go to the next setup point.			

No.	Display	Description	Notes
	PLU	Discount for individual PLUs	
	NO.	Enter PLU number	
	PERCENT */ NEW PRICE	Discount / enter new price	
	CONDITION	Min. quantity to receive discount	
		Then, either process the next PLU or use the mode key to go to the next setup point.	
	TOTAL	Discount on the total sum	
	PERCENT*	Enter discount in percent	
	CONDITION	Min. quantity to receive discount	
	CLEAR ALL	Delete all discount settings	
	SAVE YES/NO	Confirmation prompt	
	*	Enter with two decimal places, e.g. 3.00 %	
	DISC KEY	Discount will only be granted in specific cases using the DISC key	
	PLU + TOTAL	Discount possible on PLU and total sum	
	PLU ONLY	Discount only possible on PLUs	
	TOTAL ONLY	Discount only possible on total sum	
	DISABLE	Not possible to grant discount using the DISC key	
122	PRINT PLU	Print out a list of the PLUs entered	
	FROM ...	Enter the starting value	
	TO ...	Enter the final value	

5.5 Setup group 2

5.5.1 Printing tips

You can optimize the printer settings to fit your operating sequences.

Stub When printing with stubs (setup point 205), the scale prints a total ticket for your files as well as a customer ticket.

Save paper / protect thermal bar In setup points 216 to 231, you can set up the exact information that should be printed on your ticket.



If you have entered settings in another group, here you can make sure these are also printed out.

E.g. after a logo is loaded, printing of the logo must be activated in setup point 225.

5.5.2 Overview of setup group 2

No.	DISPLAY	Description	Notes
201	RESTORE DEF	Restore the factory settings for group 2	
	DEFAULT YES/NO	Should the settings should be restored, yes or no	
203	PRINT T	Select when the ticket should be printed	
	PRINT TICKET	The ticket is only printed after the transaction is completed	Factory setting
	WEIGHING T	Only weighing goods are printed; if piece goods are sold separately, then there is no printout	
205	STUB ?	Enable/disable printing of stub	
	NO STUB	Stub will not be printed	Factory setting
	SIMPLE	Ticket total will be printed as a ticket	
	DETAIL	Stub will be printed	
206	PRN COPY	Enable/disable printing of a copy of the ticket (ticket)	
	NO COPY	Print copy of ticket	Factory setting
	PRINT COPY	Do not print copy of ticket	
207	PRN METHOD	Set up printing method	
	ONE TIME PRN	Print ticket at the end of the transaction	Factory setting
	LINE BY LINE	Ticket printed out line by line	Only possible when using one vendor

No.	DISPLAY	Description	Notes
216	AFTER DESCRP	Print additional item information	
	EMPTY	Leave field empty	Factory setting
	ITEM NO	Print item number	The item number is ID1 in setup point 103
	PLU	Print PLU number	
217	PRN SCALE #?	Print scale number on the ticket	
	NOT PRN S	Print scale number	Factory setting
	NOT PRN S NO	Do not print scale number	
218	PRN VENDOR	Print vendor number on the ticket	
	PRN VENDOR	Print vendor name	Factory setting
	NOT PRN VEND	Do not print vendor name	
219	PRN DATE	Print date and time on ticket	
	PRN DATE	Print date and time	Factory setting
	NOT PRN DATE	Do not print date and time	
220	PRN S/N	Print ticket number on the ticket	
	PRN S/N	Print ticket number on the ticket	Factory setting
	NOT PRN S/N	Do not print ticket number on the ticket	
222	PRN CHG	Print the customer change	
	PRN CHG	Print customer's change on the ticket	Factory setting
	NOT PRN CHG	Do not print customer's change on the ticket	
223	PRN BARCODE	Print barcode on the ticket	
	NOT PRN BAR	Do not print barcode on the ticket	Factory setting
	FRANCE BAR C	Print the French barcode which has FRF and not EUR	Barcodes are set up in setup points 112 and 113
	PRN BARCODE	Print barcode	
224	PRN VOID	Print void data on the ticket	
	PRN VOID	Print the void data	Factory setting
	NOT PRN VOID	Do not print void data	
225	PRN LOGO	Print the shop logo	
	NOT PRN LOGO	Do not print the logo	Factory setting
	PRN LOGO	Print logo	
230	TARE PRN	Print tare weight on the ticket	
	NO TARE PRN	Do not print tare weight	Factory setting
	PRN TARE	Print tare weight	
231	PRN SUM ROUND	Rounding	Rounding is set up in setup point 430
	PRN ROUND	Print rounded prices	Factory setting
	NO ROUNDING	Print prices with all decimal places	

5.6 Setup group 3

In this group, item data can be deleted and additional functions can be enabled with licenses.

5.6.1 Licensing

You can add functions to your scale with one of the following licenses:

- Battery license**
- Battery operation for mobile use
- Network license**
- Enable the integrated operation function
 - Group 10 functions (label printing, self-service ...)

5.6.2 Overview of setup group 3

No.	DISPLAY	Description	Notes
301	DELETE PLU	Delete one or more PLUs	
	DEL FROM----	Enter the starting value	
	DEL TO-----	Enter the final value	
	SURE NO/YES	Confirmation prompt before deletion	
302	DEL GROUP	Delete group	
	DEL FROM----	Enter the starting value	
	DEL TO-----	Enter the final value	
	SURE NO/YES	Confirmation prompt before deletion	
305	RESET SCALE	Restore the scale's factory settings	
	SURE NO/YES	Confirmation prompt before deletion	Caution: RESET SCALE deletes all your settings. E.g. PLUs, GRP, formats ...
306	PID LID	Licensing for the battery and network options	
	MAINBOARD NO.	Display mainboard number	
	LICENSE	Display license number	1: no option enabled 7: options enabled
	PID	Display 20-digit product ID	Tell your handler the PID when an option is required.
	LID	Display 20-digit license ID	You get the LID from your dealer
307	DEL LOG	Delete log file	
	SURE NO/YES	Confirmation prompt before deletion	The scale logs all entries in the log file.

5.7 Setup group 4

5.7.1 Operating sequences

Your retail scale can be set up to handle your everyday business processes.

Training mode (446) When the training mode is activated, you can train your employees on the scale without affecting existing reports.

Basket function (447) Your customers bring their own baskets with them to pick fruit themselves in one of your fields. The basket function helps you save up to 999 tare weights and then call them up again later when weighing the goods. Also refer to section 4.9

Set up vendor (409) Define the number of vendors you have.

Load a PLU (403) Define whether you want to enter a PLU directly or by confirming it with the PLU key.

5.7.2 Overview of setup group 4

No.	DISPLAY	Description	Notes
401	RESTORE DEF DEFAULT NO YES	Restore factory settings Restore the factory settings, yes or no	
402	CALL PLU TYPE BY PLU BY ITEM NO	Call up the PLU by PLU number or item number Select by PLU number Select by item number	Factory setting To do this, the item number must be enabled as ID1 in setup point 103.
403	LOAD PLU TYPE BY PLU KEY AUTO LOAD	Method to call up the PLU Confirm the PLU number with the PLU key Automatically call up the PLU when the PLU number is entered	Factory setting
404	PRINT EDIT PRINT YES PRINT NO	Print the group 1 data Print data after it is entered Do not print data	Factory setting
405	PRESET PLU 1 PLU 2 PLU	Assign PLUs to a preset key Assign one PLU to a preset key Assign two PLUs to a preset key	Factory setting Refer to section 4.10.
406	PRICE CHANGE PRC CHG NO PRC CHG YES	Enable PLU price change Do not enable PLU price change PLU price change is enabled in setup point 102	Factory setting Price change process: call up the PLU, press the PLU key again and enter the new price.
408	HAND PRICE HAND PRICE 0 HAND PRICE 1	Enable manual entry of the price - working without PLUs Manual entry enabled Manual entry disabled	Factory setting
409	VENDOR QTY HANDLER	Define number of vendors Enter the number of vendors who work with the scale	Max. 8 vendors
411	TARE/P CLEAR CLEAR AUTO CLEAR MANUAL FIX T W/O P	Delete tare Tare and price are automatically cleared when there is no weight on the scale Tare and price must be manually cleared Fixed tare, price will be automatically cleared after the entry is registered	Factory setting

No.	DISPLAY	Description	Notes
412	SLEEP MODE	Enable the sleep mode when there is no change in weight	
	NO SLEEP	Do not enable the sleep function	Factory setting
	3M LATER	Enable the sleep function after three minutes	If there is no change in weight for 3 minutes, then the date and time appear in the display.
413	LIGHT TYPE	Turn on the background lighting	
	LIT AS REQUI	The background lighting turns on when there is a change in weight or a key is pressed	Factory setting
	ALWAYS	Background lighting is always on	
414	ST	Allow refunds	
	ST YES	Allow refunds	Factory setting
	REF NO	Do not allow refunds	
415	VOID	Void	
	VOID YES	Allow voiding	Factory setting
	VOID NO	Do not allow voiding	
416	QTY SOLD	Quantity of this item sold	
		Function not available in Europe	
430	ROUND CONFIG	Configure rounding	To print rounded prices, PRN ROUND must be enabled in setup point 231.
	SUM ROUND	Rounding of the total price when totalling	
	NO ROUND	No rounding	Factory setting
	ROUND TO 0/5	Round to 0.05	
	4 CUT 5 UP	Round down numbers 1 to 4 Round up numbers 5 to 9	
	ROUND UP	Round up the last decimal place	
	PRICE ROUND	Rounding of the given PLU's unit price	
	NO ROUND	No rounding	Factory setting
	ROUND TO 0/5	Round to 0.05	
	4 CUT 5 UP	Round down numbers 1 to 4 Round up numbers 5 to 9	
	ROUND UP	Round up the last decimal place	
	1/4 ROUND	Round to 0.25	
	TOTAL ROUND	Rounding of individual items	
		Settings as under PRICE ROUND	

No.	DISPLAY	Description	Notes
431	CUT CONFIG	Standard rebate on the total price	
	SUM CUT	Rebate on the total sum	
	TOTAL CUT	Rebate on individual items	
	NO CUT DEFAULT	No standard rebate on the total price	Factory setting
	CUT TO X.XX	Maintain two decimal places	To do this, CUT AUTO must be enabled in setup point 432.
	CUT TO X.X0	Delete last decimal place	
	CUT TO X.00	Delete all decimal places	
432	CUT EFFECT	Grant rebate	
	CUT BY KEY	By pressing the minus key	Factory setting To do this, KEY ENABLE must be enabled in setup point 433.
	CUT AUTO	Automatic	
433	CUT KEY	Minus key	
	KEY ENABLE	Minus key enabled	Factory setting
	KEY DISABLE	Minus key disabled	
434	CUT CHANGE	Rebate by increasing customer change	
	CUT CHG NO	No rebate correction	
	CUT CHG YES	Rebate correction possible	Rebates can be granted and then corrected before the entry is completed.
438	PRINT SPEED	Set up the printing speed	
	SPEED FAST	Fast printing speed	Factory setting
	SPEED FASTER	Very fast printing speed	
	SPEED NORMAL	Normal printing speed	
439	CONTRAST	Set up print contrast	
	CONTRAST 0–8	Set up the print contrast between 0 and 8	Factory setting: 4
440	FIRST DAY TYPE	Define the first day of the week	
	MONDAY	The first day of the week is Monday	Factory setting
	SUNDAY	The first day of the week is Sunday	
441	FILTER TYPE	Set up the scale sensitivity	
	FILT NORMAL 1	Normal sensitivity	Factory setting
	FILT MIDDLE 2	Medium sensitivity	The higher the sensitivity setting, the more accurate, but slower the scale is.
	FILT HEAVY 3	High sensitivity	
	FILT VERY HEAVY 4	Highest sensitivity	
	FILT LIGHT 0	Low sensitivity	
442	ECR CHECKOUT	Enable cash drawer	
	ECR CKO NO	Disable cash drawer	Factory setting
	ECR CKO YES	Enable cash drawer	

No.	DISPLAY	Description	Notes
443	MULTI-PAY	Allow different payment methods	
	CASH ONLY	Only allow cash payments	Factory setting
	MULTI-PAY	Allow different payment methods	Payment by credit card, cheque or voucher, refer to section 4.8
444	BASKET FUNC	Basket function	
	NOT PERMIT/PERMIT	Enable basket function, yes or no	Save and call up container weight, refer to section 4.8
445	TM KEY	Manual tare input for known tare using the P key	
	NOT PERMIT	Disable manual tare input	Factory setting
	PERMIT	Enable manual tare input	Sequence: Press the P key. Enter tare and again press the P key. NET appears in the display.
446	TRAINING	Enable/disable training mode	
	TRAINING OFF	Switch off training mode	Factory setting
	TRAINING ON	Switch on training mode	
450	PLU CONFIG	Configure PLU	
	NUMBER OF PLUS	Define the number of PLUs	Max. 1000 PLUs
	NUM OF LOGS	The number of logs is displayed	The more PLUs there are, the fewer logs can be saved.
	SAVE NO/YES	Confirmation prompt before saving	
451	SAVE LOG	Save log file	
	SAVE AUTO	Save automatically	Factory setting When the maximum number of logs has been reached, the oldest entry will be overwritten.
	SAVE MANUAL	Save manually	
	NOT SAVE	Do not save	

5.8 Setup group 5

This group can only be accessed by the service engineer.
Only exception: setup point 518 - language settings

No.	DISPLAY	Description
518	SET LANGUAGE	Set up language
	DEFAULT	English
	ENGLISH	English
	CHINESE	Chinese
	FRENCH	French
	GERMAN	German
	SPANISH	Spanish
	ITALIAN	Italian
	HUNGARIAN	Hungarian
	POLISH	Polish
	CZECH	Czech
	CROATIAN	Croatian
	DUTCH	Dutch
	SLOVAK	Slovak
	SLOVENIAN	Slovenian
	GREEK	Greek
	DENMARK	Danish
	SWEDEN	Swedish
	NORWAY	Norwegian
	FINLAND	Finnish



- Display text and printouts are available in German, English, French, Spanish and Italian.
- For all other languages, only the printouts are localised. Display text is shown in English.
- Danish, Swedish, Norwegian and Finnish are in process.
- Languages will be updated regularly.

5.9 Setup group 6

The scale assists you with evaluations. In this group you set up your reports.



- Reports can be printed on the scale or transferred to a PC.
- If a report is printed on the scale, another report can be selected afterwards or the printed report can be deleted.

No.	DISPLAY	Description	Notes
601	RESTORE DEF DEFAULT YES/NO	Restore factory settings Restore the factory settings, yes or no	
602	SALES REPORT	Create sales report	
	TODAY	Create a sales report for this day	
	DETAIL/SIMPLE REPORT	Create detailed/simple report for today's sales	
	PRINT / NOT PRINT	Print the report, yes or no	
	ANOTHER YES/NO	Create other reports, yes or no	YES: go to 603 NO: go to DEL REPS
	DEL REPS NO/YES SURE NO/YES	Delete all reports created, yes or no Confirmation prompt before deletion	
	LAST VALID	Sales for the time period since the last sales report	If available, the date of the last report will be displayed.
		Further settings as under TODAY	
	TOTAL	Sales report covering all registered entries in the log file	
		Further settings as under TODAY	
	ALL	Summary of all sales reports (today + last valid + total)	
		Further settings as under TODAY	

No. DISPLAY	Description	Notes
603 PLU REPORT	Create report for all PLUs	
TODAY	Report about PLUs used today	
ALL PLUS	Create report for all PLUs	
FROM ... TO PLU NO.	Create a report for a range of PLUs	Enter the beginning and end values.
SORT BY SUM/PLU	Sort by amount/PLU number	
PRINT / NOT PRINT	Print the report, yes or no	
ANOTHER YES/NO	Create other reports, yes or no	YES: go to 604 NO: go to DEL REPS
DEL REPS NO/YES	Delete all reports created, yes or no	
SURE NO/YES	Confirmation prompt before deletion	
LAST VALID	PLU report for the time period since the last PLU report	If available, the date of the last PLU report will be displayed.
	Further settings as under TODAY	
TOTAL	PLU report covering all registered entries in the log file	
	Further settings as under TODAY	
ALL	Summary of all PLU reports (today + last valid + total)	
	Further settings as under TODAY	
604 PROMOTION REPORT	Create discount report	
	Refer to 603	
605 GROUPS RPT	Create group report	
TODAY	Report covering all groups used today	
ALL GROUPS	Create report covering all groups	
FROM ... TO GRP NO.	Create a report for a range of groups	Enter the beginning and end values.
SORT BY SUM/GRP	Sort by amount/number	
SIMPLE/DETAIL REPORT	Create simple/detail report for the current groups	
PRINT / NOT PRINT	Print the report, yes or no	
ANOTHER YES/NO	Create other reports, yes or no	YES: go to 607 NO: go to DEL REPS
DEL REPS NO/YES	Delete all reports created, yes or no	
SURE NO/YES	Confirmation prompt before deletion	
LAST VALID	Group report for the time period since the last group report	If available, the date of the last group report will be displayed.
	Further settings as under TODAY	
TOTAL	Group report covering all registered entries in the log file	
	Further settings as under TODAY	

No.	DISPLAY	Description	Notes
605	ALL	Summary of all group reports (today + last valid + total) Further settings as under TODAY	
607	HOURLY RPT	Create hourly report	
	TODAY	Create report on the hourly sales today	
	PRINT / NOT PRINT	Print the report, yes or no	
	ANOTHER YES/NO	Create other reports, yes or no	YES: go to 611 NO: go to DEL REPS
	DEL REPS NO/YES	Delete all reports created, yes or no	
	SURE NO/YES	Confirmation prompt before deletion	
	LAST VALID	Hourly report since the last valid report Further settings as under TODAY	
	TOTAL	List of all registered hourly reports in the log file Further settings as under TODAY	
	ALL	Summary of all hourly reports (today + last valid + total) Further settings as under TODAY	
610	ST/RETN RPT	Create refund report Refer to 605	
611	VENDOR RPT	Create vendor report	
	TODAY	Report of the vendor's transactions today	
	ALL VENDORS	Create report for all vendors	
	FROM ... TO VENDOR NO.	Create a report for a range of vendors	Enter the number of the first and last vendor.
	BY SUM / BY VEN	Sort by amount/vendor number	
	SIMPLE RPT / DETAIL RPT	Create simple/detail report for the vendors	
	PRINT / NOT PRINT	Print the report, yes or no	
	ANOTHER YES/NO	Create other reports, yes or no	YES: go to 613 NO: go to DEL REPS
	DEL REPS NO/YES	Delete all reports created, yes or no	
	SURE NO/YES	Confirmation prompt before deletion	
	LAST VALID	Vendor report for the time period since the last vendor report Further settings as under TODAY	If available, the date of the last vendor report will be displayed.
	TOTAL	Overview of all registered vendor reports in the log file Further settings as under TODAY	
	ALL	Summary of all vendor reports (today + last valid + total) Further settings as under TODAY	

No. DISPLAY	Description	Notes
613 WEEKLY RPT	Create weekly report	
PRINT / NOT PRINT	Print the report, yes or no	
ANOTHER YES/NO	Create other reports, yes or no	YES: go to 616 NO: go to DEL REPS
DEL REPS NO/YES	Delete all reports created, yes or no	
SURE NO/YES	Confirmation prompt before deletion	
616 COMBINE RPT	Create combined report from report 602 to 614	
602 YES/NO	Include sales report, yes or no	
603 YES/NO	Include PLU report, yes or no	
605 YES/NO	Include group report, yes or no	
607 YES/NO	Include hourly report, yes or no	
610 YES/NO	Include refund report, yes or no	
611 YES/NO	Include vendor report, yes or no	
613 YES/NO	Include weekly report, yes or no	
618 YES/NO	Include basket report, yes or no	
PRINT / NOT PRINT	Print the report, yes or no	
ANOTHER YES/NO	Create other reports, yes or no	YES: go to 617 NO: go to DEL REPS
DEL REPS NO/YES	Delete all reports created, yes or no	
SURE NO/YES	Confirmation prompt before deletion	
617 LOG	Create log	
SALES LOG	Create sales log	
FROM ... TO T NO.	Create log for a range of tickets	Enter the beginning and end values.
PRINT/NOT PRINT	Print the report, yes or no	
PROMOTE LOG	Create log for automatic discounts	
	Further settings as under SALES LOG	
ST/VOID LOG	Create log of refunds	
	Further settings as under SALES LOG .	
618 BASKET RPT	Report for the basket function	
PRINT / NOT PRINT	Print the report, yes or no	
DELETE NO/YES	Delete the report, yes or no	
ANOTHER YES/NO	Create other reports, yes or no	YES: go to 616 NO: go to DEL REPS
DEL REPS NO/YES	Delete all reports created, yes or no	
SURE NO/YES	Confirmation prompt before deletion	

No.	DISPLAY	Description	Notes
622	VAT REPORT	Create value added tax report	
	TODAY	Create VAT report for this day	
	PRINT / NOT PRINT	Print the report, yes or no	
	ANOTHER YES/NO	Create other reports, yes or no	YES: go to 623 NO: go to DEL REPS
	DEL REPS NO/YES	Delete all reports created, yes or no	
	SURE NO/YES	Confirmation prompt before deletion	
	LAST VALID	VAT report for the time period since the last VAT report	If available, the date of the last VAT report will be displayed.
		Further settings as under TODAY	
	TOTAL	VAT report for all registered entries	
		Further settings as under TODAY	
	ALL	Summary of all VAT reports	
		Further settings as under TODAY	
623	DEL REPORT	Automatic deletion of all reports except for weekly, monthly and annual reports	
	SURE NO/YES	Confirmation prompt	
624	DEL ALL REPT	Delete all reports	
	SURE NO/YES	Confirmation prompt before deletion	
625	DEL AU/MA	All reports automatically deleted each day at 0:00 a.m.	
	RPT DEL AUTO	Automatically delete report	
	RPT DEL MANU	Manually delete report	
	SURE NO/YES	Confirmation prompt	

5.10 Setup group 7

In this group, you enter the settings for communicating with a computer/scanner or for operating the scale in a scale network (integrated operation function).



The integrated operation function can only be enabled with a network license. Please contact your sales representative.

5.10.1 Connect the scale to a computer.

The computer connection lets you download item data and formats from the computer or upload them to the computer for further processing. Please contact your sales representative.

5.10.2 Connecting a scanner

To quickly and accurately read in PLUs, you can use a scanner. To connect a scanner to the scale, please contact your sales representative.

5.10.3 Integrated operation in a scale network

You have an extensive range of cold cuts and cheese and want to set up more than one scale on the counter. A network of up to 10 scales lets your vendors enter items on several scales and then complete the transaction on one of the scales used. In this case, one of the scales functions as the master, all the others are slaves. The item data and settings are transferred from the master scale to the slave scales and are therefore available to all scales.

The integrated operation function saves your vendors time and lets you serve your customers faster.

- Required accessories**
- 2 scales can be connected directly with a commercially available CAT5 cross cable via the Ethernet interface.



- For a network of more than 2 scales, a hub must be used.

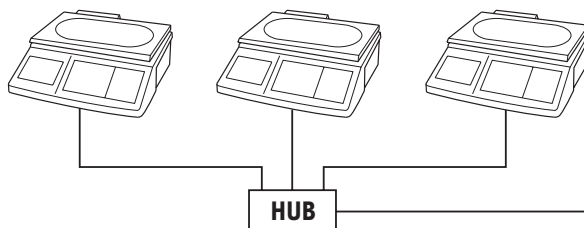

Setting up a scale network

Configure scale 1 (master)

1. On scale 1, select setup point 702 and confirm with the asterisk key.
2. Confirm "Host" with the asterisk key.
3. Enter IP address 192030007001 and confirm with the asterisk key.
4. Enter network mask 255255248000 and confirm with the asterisk key.
5. Call up setup point 703 and confirm with the asterisk key.
6. Use the tare key to select "FV Master" and confirm with the asterisk key.
7. Press the mode key twice to exit the setup mode.
8. Turn off the scale.



- Each scale in the network needs its own IP address.
- All scales in the network need the same network mask.
- If scales in an existing network need to be connected to other computers, then the network mask and IP address must be coordinated with the network. Ask your network administrator.

Configure scale 2 and others (slaves)

1. On scale 2, select setup point 702 and confirm with the asterisk key.
2. Confirm "Host" with the asterisk key.
3. Enter a different IP address as for scale 1, e.g. 192030007002, and confirm with the asterisk key.
4. Enter the same network mask 255255248000 and confirm with the asterisk key.
5. Press the mode key to go to setup point 703.
6. Call up setup point 703 and confirm with the asterisk key.
7. Use the tare key to select "FV Slave" and confirm with the asterisk key.
8. Press the mode key twice to exit the setup mode.
9. Turn off the scale.
10. For more slaves, repeat steps 1 to 9.

Connect scales

1. Connect the scales via the Ethernet interface with cross cables. For more than 2 scales, use a hub.

2. Turn on the master.

The following symbol appears on the display: 

3. Turn on the slave(s).

The following symbol appears on each display: 

The data in the master is transferred to the slave(s).

Working with integrated operation

Example

Vendor 5 sells meat on scale 1, cold cuts on scale 2 and cheese on scale 3.

1. Enter the meat on scale 1 with V5.
2. Enter the cold cuts on scale 2 with V5.
3. Complete the transaction on any of the scales with V5 as described in working with several vendors.



- In a scale network, the master scale always has to be turned on first, and then the slaves.
- When working in the integrated operation network, not all setup functions are active.
- If you have questions or problems, please contact your sales representative.

5.10.4 Overview of setup group 7

Factory settings are indicated in **bold** print.

No.	DISPLAY	Description	Possible settings
701	RS-232	Configure COM 1 and COM 2	
	COM ...	Select connection COM 1 or COM 2	COM 1: scanner connection for reading in barcodes COM 2: computer connection
	BAUDRATE	Set up baud rate	115200, 2400, 4800, 9600 , 19200, 38400, 57600 Baud
	BITS	Set up data bits	7 Bit / 8 Bit
	PARITY	Set up parity check	Even parity Odd parity No parity
	STOP BITS	Set up the number of stop bits	1 stop bit / 2 stop bits
	CONTROL	Set up handshake	Hardware handshake, no hand- shake
702	ETHERNET	Enter network settings	
	HOST	Configure host	
	HOST LOCAL	Enter local IP address	e.g. 192030007200 Each scale in the network needs its own IP address.
	HOST MASK	Enter mask code	Code-Nr.: 255255248000 All scales in the network need this mask code.
	IDLE (MS)	Enter timeout	1 ... 99 ms, 10
	HOST ROUTER IP	Enter the IP address of the router	
	MAC ADDRESS	Display the MAC address	
703	WORK MODES	Define the operating mode of the scale	
	STAND ALONE	The scale operates alone	
	FV SLAVE	The scale functions as a slave in the network	
	FV MASTER	The scale functions as the master in the network	

5.11 Setup group 8

In this group, you can assign passwords and authorizations for accessing the scale.

12345

- A 5-digit vendor password to access the scale can be set up in setup point 801.
- Factory setting: no vendor password



1 888888

- Setup access for the chief executive.
- Access to all setup groups
- Password in the factory settings: 888888



2 666666

- Setup access for the manager.
- Access to setup groups 1, 2, 4, 6 and 7 (factory settings)
- Password in the factory settings: 666666

5.11.1 Working with vendor passwords

If a vendor password is assigned, vendors can only use the scale after they have logged in with their password.

Vendor login

2 sec

1. To login, press the vendor key for approx. 2 seconds.

1 ... 9

2. Enter the vendor password using the number keys and confirm with the asterisk.

Vendor X is logged in when the messages VENDOR LOG IN and VENDOR TICKET appear in the bottom line of the display.

Vendor log off

2 sec

1. To log off, press the vendor key for approx. 2 seconds.

1 ... 9

2. Enter password using the number keys and confirm with the asterisk.

Vendor X is logged off when the messages VENDOR LOG OFF appears in the bottom line of the display.



Always log off when you are not using the scale.

5.11.2 Overview of setup group 8

No. DISPLAY	Description	Notes
801 PW MANAGER	Password administration	
CHG PW MANAGER	Change the manager's password	Factory setting: mode 2 666666
MANAGER PW NEW	Assign new password	Max. 5 characters
AGAIN	Repeat new password	
CHG PW VENDOR	Change vendor password	
VEND 1...8	Enter the number of the vendor whose password should be changed	Max. 8 vendors
VEND X PW NEW	Assign new password for vendor X	Max. 5 characters
AGAIN	Repeat new password	
	Then, either process the next vendor or use the mode key to go to the next setup point.	
CHG PW BOSS	Change the boss's password	Factory setting: mode 1 888888
BOSS PW NEW	Assign new password	Max. 5 characters
AGAIN	Repeat new password	
802 RIGHT LIMIT	Assign access rights	
MANAGER	Setup groups that the manager can edit	Enter more groups with the tare key Factory setting: groups 1, 2, 4, 6, 7
VEND	Setup groups that the vendor can edit	Enter more groups with the tare key Factory setting: no access



Record your passwords in a safe location.

5.12 Setup group 10

This group can only be accessed with a network license.

5.12.1 Label printing



- You can use your scale to print labels:
 - in the sales mode or
 - in the prepack mode
- The scale has predefined label formats. Up to 10 additional label formats can be configured with a PC.
- If you have questions, please contact your sales representative.

Required settings

- Define label information in groups 1 and 2
- Setup point 1026: select sales mode or prepack mode
- Setup point 1005: select ticket printing or label printing

5.12.2 Overview of setup group 10

No.	DISPLAY	Description	Notes
1003	PRODUCT DATE	Enter the product date for the printout	e.g. manufacturing date, sell by ..., best before date. Today's date is automatically displayed.
	CURRENT –	Number of days that the date should be moved forward	Max. 99 days
	CURRENT +	Number of days that it should be backdated	Max. 99 days
1004	EXTRA TEXT N	Enter additional text	Only for label printing
	TEXT 1 ...50	Enter the number of the extra text	Max. 50 extra text entries
		Enter additional text	Max. 183 characters
1005	PRN TYP	Select print method	
	PRINT TICKET	Print ticket	Factory setting
	PRINT LABEL	Print label	
	LABEL ENDLESS	Print endless label	
1006*	D L W FORMAT	Select label format for weight PLU	
	D L W FORMAT	Select label format	Factory setting: 101
1007*	D L Q FORMAT	Select label format for quantity PLU	
	D L Q FORMAT	Select label format	Factory setting: 102
1008*	D P W FORMAT	Select label format for prepacking for weight PLU	
	D P W FORMAT	Select label format	Factory setting: 103
1009*	D P Q FORMAT	Select label format for prepacking for quantity PLU	
	D P Q FORMAT	Select label format	Factory setting: 104

No.	DISPLAY	Description	Notes
1010*	D L T FORMAT	Select the format of the total label	
	D L T FORMAT	Select label format	Factory setting: 105
*	Notes on label formats	Possible formats: 1 to 10 and 101 to 110 The formats 101 to 110 are preconfigured and saved in the scale, refer to the format overview in the appendix. The formats 1 to 10 are free-form formats that can be downloaded from the computer.	
1011	ACT TO V1	Reaction to pressing the vendor key in the label printing mode	
	LABEL/NO TOT	Print label without totalling	Factory setting
	LABEL/TOT	Print label and total	
	NO LABEL/TOT	Total, but do not print label	
1016	SELF-SERVICE	Configure self-service for the scale	
	VENDOR M	Scale is operated by the vendor	Factory setting
	SELF-SERVICE	Self-service scale operation	
	MANUAL	Select manual self-service operation of the scale	Various items can be weighed by the customer. The customer places the item on the scale and presses the alphabetical key corresponding to that item.
	AUTOMATIC	Automatic self-service	
	PLU NUMBER	Enter the PLU number that should be weighed in the self-service mode	One and the same item can be weighed by the customer, e.g. salad buffet sales. The customer only has to place the item on the scale and the scale automatically prints the ticket.
1017	GROUP H RPT	Create a group report every hour	
	TODAY	Report covering all groups used today	
	ALL GROUPS	Create hourly report of all groups	
	FROM ... TO GROUP NO.	Create a report for a range of groups	Enter the beginning and end values.
	SORT SUM / SORT GRP	Sort by amount or by group	
	PRINT / NOT PRINT	Print the report, yes or no	
	ANOTHER YES / ANOTHER NO	Create other reports / Don't create other reports	YES: go to 1017 NO: go to DEL REPS
	DEL REPS NO / DEL REPS YES	Delete all reports created, yes or no	
	SURE NO/ SURE YES	Confirmation prompt before deleting the report	

No.	DISPLAY	Description	Notes
1017	LAST VALID	Report for the time period since the last group report Further settings as under TODAY	
	TOTAL	Report covering all registered groups in the log file Further settings as under TODAY	
	ALL	Summary of all reports (today + last valid + total) Further settings as under TODAY	
1020	CASHDRAW RPT	Create cash drawer report Refer to 1017	
1021	MONTHLY RPT	Create monthly report Refer to 1017, TODAY	
1022	YEARLY RPT	Create yearly report Refer to 1017, TODAY	
1025	PLU REPORT	Create PLU report Other settings as under 1017	
1026	MODE SWITCH	Switch between the sales mode and the prepack mode	
	OPERATION	Sales mode	Factory setting
	PP	Prepack mode	

6 What do you do if....?

In the case of an operating error, the error message will be displayed for approx. 1 second in the bottom line of the display. Error messages can be cleared with the C key.

Error	Cause	Remedy
TOO SMALL	Data entered too small	
INPUT ERROR	Incorrect input	
SAVE ERROR	Error during saving	
O TOO SMALL	Zero value during calibration too small	
O TOO LARGE	Zero value during calibration too large	
WT TOO SMALL	<ul style="list-style-type: none"> • Weight on scale too low • Item was removed from the weighing pan too quickly <p>During label printing or when total weight < 20 e</p>	▶ Only remove the item from the weighing pan after confirming the entry with the vendor key.
WT TOO LARGE	The weight on the scale during calibration is too heavy	
WT TOO HEAVY	The weight on the weighing pan exceeds the maximum load by more than 9 e	▶ To enter large quantities, refer to section 3.3.
NOT STABLE	The weight display is not stable when the scale is turned on	
CONF. ERROR	Incorrect configuration when the scale is turned on	▶ Please contact your dealer.
AMOUNT IS 0	When a label is printed or when totaling, the total price is 0	
PLU NOT FOUND	PLU not found when called up	▶ Enter the PLU, refer to section 3.2.
NO THIS PLU	This PLU is not stored	
TARE TOO BIG	Preset tare exceeds the maximum load	
NOT LOG IN	The vendor has not logged in	▶ Vendor login, refer to section 4.6.
CHANGE PAPER	The paper is empty	▶ Replace the ticket roll or label roll.
WRONG VENDOR	The vendor does not exist	▶ Vendor login, refer to section 4.6.
NO DISCOUNT	Discount not enabled	▶ Enable the discount key, refer to setup point 116.
DISC IMPOSS	The input does not meet the discount conditions	▶ Change the discount conditions.

Error	Cause	Remedy
NO VOID	There is no transaction to be voided	
NO CUST MEM	There is no customer record in the database	
MEMORY FULL	Memory full	
ERROR 203	Database checksum is incorrect	
KEY NO FUNCTION	The key is not valid for the transaction	▶ Use a key that is valid for the transaction.
SET TO SLAVE MULTI SERVER	There are two master scales in the network	▶ Change one of the master scales to a slave.
NETWORK ERROR	Network not working correctly	▶ Please contact your administrator.
VENDOR BUSY	Vendor number already in use	▶ Wait until the vendor number is free.
CMD UNAVAIL	Command is disabled	

7 Technical data and accessories

7.1 Technical data

Scale data

Maximum load	3 kg, 6 kg, 15 kg or 30 kg
Increments	1 g, 2 g, 5 g or 10 g

Display

Weight display	6 digits
Unit price display	6 digits
Total price	7 digits
Tare	4 digits

Ambient conditions

Operating temperature	-10° C to +40° C
Storage temperature	-25° C to +50° C

Electrical data

Mains connection	100–240 V AC
Battery (optional)	12 V / 5 Ah.

Interfaces

Cash drawer	Cash drawer connection
2 x RS232	for PC or scanner
Ethernet (optional)	to set up a scale network

Memory

No. of PLUs	9999
No. of groups	20
No. of tare weights	20

7.2 Accessories

The following optional accessories are available from your sales representative:

- Printer paper
- Labels
- Spare battery
- Network cable/computer cable
- Hub

8 Appendix

8.1 Unicode Table

Code	Type	Code	Type	Code	Type	Code	Type	Code	Type	Code	Type	Code	Type
00000		00040	(00080	P	00120	x	00160		00200	È	00240	č
00001		00041)	00081	Q	00121	y	00161	i	00201	É	00241	ň
00002		00042	*	00082	R	00122	z	00162	ç	00202	Ê	00242	ò
00003		00043	+	00083	S	00123	{	00163	£	00203	Ë	00243	ó
00004		00044	,	00084	T	00124		00164	□	00204	Ì	00244	ô
00005		00045	-	00085	U	00125	}	00165	¥	00205	Í	00245	õ
00006		00046	.	00086	V	00126	~	00166	ç	00206	Î	00246	ö
00007		00047	/	00087	W	00127		00167	§	00207	Ï	00247	÷
00008		00048	0	00088	X	00128		00168	™	00208	Ĉ	00248	ø
00009		00049	1	00089	Y	00129		00169	©	00209	Ñ	00249	ù
00010		00050	2	00090	Z	00130	,	00170	°	00210	Ò	00250	ú
00011		00051	3	00091	[00131	f	00171	«	00211	Ó	00251	û
00012		00052	4	00092	\	00132	„	00172	¬	00212	Ô	00252	ü
00013		00053	5	00093]	00133	...	00173		00213	Õ	00253	ď
00014		00054	6	00094	^	00134	†	00174	®	00214	Ö	00254	đ
00015		00055	7	00095	_	00135	‡	00175	™	00215	ē	00255	ÿ
00016		00056	8	00096	̀	00136		00176	°	00216	ø	00256	Ā
00017		00057	9	00097	a	00137	‰	00177	±	00217	Û	00257	ā
00018		00058	:	00098	b	00138	ć	00178	ë	00218	Ü	00258	Ă
00019		00059	;	00099	c	00139	<	00179	Ë	00219	Ū	00259	ă
00020		00060	<	00100	d	00140	Œ	00180	˙	00220	Ů	00260	Ą
00021		00061	=	00101	e	00141		00181	μ	00221	Ǫ	00261	ą
00022		00062	>	00102	f	00142		00182	¶	00222	ǫ	00262	ć
00023		00063	?	00103	g	00143		00183	˙	00223	Ǭ	00263	č
00024		00064	@	00104	h	00144		00184	˙	00224	ǻ	00264	Ĉ
00025		00065	A	00105	i	00145	’	00185	Ë	00225	ǵ	00265	ĉ
00026		00066	B	00106	j	00146	’	00186	°	00226	ǿ	00266	Ċ
00027		00067	C	00107	k	00147	”	00187	»	00227	ǻ	00267	ċ
00028		00068	D	00108	l	00148	”	00188	Ë	00228	ǻ	00268	Ĉ
00029		00069	E	00109	m	00149	°	00189	è	00229	ǻ	00269	ĉ
00030	-	00700	F	00110	n	00150	—	00190	¼	00230	œ	00270	Ď
00031		00710	G	00111	o	00151	—	00191	ı	00231	ç	00271	ď
00032		00720	H	00112	p	00152	™	00192	À	00232	è	00272	Đ
00033	!	00730	I	00113	q	00153	™	00193	Á	00233	é	00273	đ
00034	"	00074	J	00114	r	00154	Ĉ	00194	Â	00234	ê	00274	Ē
00035	#	00075	K	00115	s	00155	>	00195	Ã	00235	ë	00275	ē
00036	\$	00076	L	00116	t	00156	œ	00196	Ä	00236	ì	00276	Ë
00037	%	00077	M	00117	u	00157		00197	Å	00237	í	00277	ë
00038	&	00078	N	00118	v	00158		00198	Æ	00238	î	00278	Ë
00039		00079	O	00119	w	00159	ÿ	00199	Ç	00239	ï	00279	è

Code	Type	Code	Type	Code	Type	Code	Type	Code	Type	Code	Type	Code	Type
00280	Ē	00330	Ŋ	00380	ž	00430		00480		00530	Ř	00580	
00281	ē	00331	ŋ	00381	Ž	00431	Ů	00481		00531	ř	00581	
00282	Ě	00332	Ō	00382	ž	00432	ů	00482		00532	Ů	00582	
00283	ě	00333	ō	00383		00433		00483		00533	ů	00583	
00284	Ĝ	00334	Ŏ	00384		00434		00484	G	00534	Ů	00584	
00285	ĝ	00335	ö	00385		00435		00485	g	00535	ů	00585	
00286	Ĝ	00336	Ŏ	00386		00436		00486	Ĝ	00536	Ş	00586	
00287	ĝ	00337	ö	00387		00437		00487	ĝ	00537	ş	00587	
00288	G	00338	Œ	00388		00438		00488	K	00538	Ț	00588	
00289	g	00339	œ	00389		00439	Ț	00489	k	00539	ț	00589	
00290	Ĝ	00340	Ř	00390		00440		00490	Q	00540	Ț	00590	
00291	ĝ	00341	ř	00391		00441		00491	q	00541	ț	00591	
00292	H	00342	Ŕ	00392		00442		00492		00542			
00293	h	00343	ř	00393		00443		00493		00543			
00294	H	00344	Ŕ	00394		00444		00494	Ž	00544			
00295	h	00345	ř	00395		00445		00495	ž	00545			
00296	Ī	00346	Š	00396		00446		00496		00546			
00297	ī	00347	š	00397		00447		00497	DZ	00547			
00298	Ī	00348	Š	00398		00448		00498	Dz	00548			
00299	ī	00349	š	00399	ə	00449		00499	dz	00549			
00300	Ī	00350	Ş	00400		00450		00500		00550			
00301	ī	00351	ş	00401		00451		00501		00551			
00302	Ĵ	00352	Š	00402	f	00452		00502		00552			
00303	ĵ	00353	š	00403		00453		00503		00553			
00304	Ĵ	00354	Ț	00404		00454		00504		00554			
00305	ĵ	00355	ț	00405		00455		00505		00555			
00306	IJ	00356	Ț	00406		00456		00506	Á	00556			
00307	ij	00357	ț	00407		00457		00507	á	00557			
00308	J	00358	Ț	00408		00458		00508	Æ	00558			
00309	j	00359	ț	00409		00459		00509	æ	00559			
00310	K	00360	Ū	00410		00460		00510	Ø	00560			
00311	k	00361	ū	00411		00461	Ä	00511	ø	00561			
00312	κ	00362	Ū	00412		00462	ä	00512	Ä	00562	ÿ		
00313	Ĺ	00363	ū	00413		00463	Ī	00513	ä	00563	ÿ		
00314	ĺ	00364	ū	00414		00464	ī	00514	Ä	00564			
00315	Ľ	00365	Ū	00415		00465	Ö	00515	ä	00565			
00316	ľ	00366	Ū	00416	Ů	00466	ö	00516	Ë	00566			
00317	ľ	00367	ů	00417	σ	00467	Ů	00517	ë	00567			
00318	Ŕ	00368	Ů	00418		00468	ů	00518	Ë	00568			
00319	ŕ	00369	ů	00419		00469	Ů	00519	ë	00569			
00320	ŕ	00370	Ů	00420		00470	ů	00520	Ī	00570			
00321	Ł	00371	Ů	00421		00471	Ů	00521	Ī	00571			
00322	ł	00372	Ű	00422		00472	ű	00522	Ī	00572			
00323	Ń	00373	Ű	00423		00473	Ů	00523	ĭ	00573			
00324	ń	00374	Ų	00424		00474	ű	00524	Ō	00574			
00325	Ń	00375	Ų	00425		00475	Ů	00525	ö	00575			
00326	ņ	00376	Ų	00426		00476	ű	00526	Ō	00576			
00327	Ņ	00377	Ž	00427		00477		00527	ō	00577			
00328	ņ	00378	ž	00428		00478		00528	Ř	00578			
00329	h	00379	Ž	00429		00479		00529	ř	00579			

8.2 Label formats

#101: 40 x 50 mm



#102: 40 x 50 mm



#103: 35 x 50 mm



#104: 35 x 50 mm



#105: 20 x 40 mm

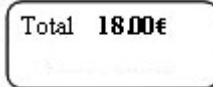

#106: 35 x 50 mm



#107: 30 x 40 mm



#108: 30 x 40 mm



#109: 30 x 40 mm



8.3 Declaration of conformity

Mettler-Toledo (ChangZhou) Measurement Technology Ltd.
Legal Metrology



METTLER TOLEDO

EC-Declaration of Conformity
EC-Konformitätserklärung
EC-Déclaration de conformité
EC-Declaración de Conformidad
EC-Conformiteitsverklaring
EC-Dichiarazione di conformità



We, Wir, Nous, Nosotros, Wij, Noi,

Mettler-Toledo (ChangZhou) Measurement Technology Ltd.
No.111, West TaiHu Road, XinBei District, ChangZhou, JiangSu, 213125, P.R.China

declare under our sole responsibility that the product,
erklären, in alleiniger Verantwortung, daß dieses Produkt,
déclarons sous notre seule responsabilité que le produit,
declaramos, bajo nuestra sola responsabilidad, que el producto,
verklaren onder onze verantwoordelijkheid, dat het product,
dichiariamo sotto nostra unica responsabilità, che il prodotto,

Model/Type: bTwin,bTwin-H2 series scale (EC Type Certificate No.:T6761)

To which this declaration relates , is in conformity with the following standard(s) or other normative document(s),
auf das sich diese Erklärung bezieht, mit/der/den folgenden Norm(en) oder Richtlinie(n) übereinstimmt.
Auquel se réfère cette déclaration est conforme à la (aux) norme(s) ou au(x) document(s) normatif(s).
Al que se refiere esta declaración es conforme a la(s) norma(s) u otro(s) documento(s) normativo(s).
Waarvoor deze verklaring verwijst, aan de volende norm(en) of richtlijn(en) beantwoordt.
A cui si riferisce questa dichiarazione è conforme alla/e sequente/i norma/e o documento/i normativo/i.

EC marking	EC Directive:	Applicable Standards:
	2006/95/EC Low Voltage	EN60950-1:2006
	2004/108/EC EMC	EN61326-1:2006
	2009/23/EC Non-automatic weighing instruments	EN 45501:1992 /AC:1993 1 ¹⁾

- xx: Last two digit of the year of initial verification
- yyyy: Notified Body of Metrology

- 1) **Applies only to certified non-automatic weighing instruments.**
gilt nur für geeichte nicht selbsttätige Waagen
s'applique uniquement aux instruments de pesage à fonctionnement non automatique vérifiées
aplicable solamente a strumenti di pesatura a funzionamento non automatico omologate
Enkel van toepassing op gecertificeerde Niet Automatische Weegwerktuigen
aplicable solamente a instrumentos de pesaje aprobados de funcionamiento no automático verificadas

Issued on: 2009-2-18 Revised on: 2012-3-1
Mettler-Toledo (ChangZhou) Measurement Technology Ltd.



Chen Huai
General Manager

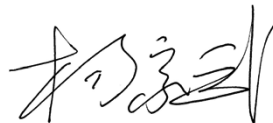

Yang JiaWu
QA Manager

www.mt.com/service

For more information

Mettler-Toledo AG
Sales International
CH-8606 Greifensee
Switzerland
Tel. +41 44 944 22 11
Fax +41 44 944 30 60

Subject to technical changes
© 06/2012 Mettler-Toledo AG
Printed in Switzerland
Order number 72179502C