

Static Dimensioning System

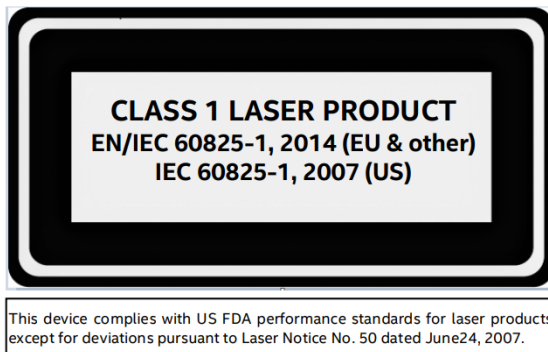

1 Safety Instructions

- This camera is classified as a Class 1 laser product under the EN/IEC 60825-1, Edition 3 (2014) internationally and IEC60825-1, Edition 2 (2007) in the US.
- This camera complies with US FDA performance standards under 21 CFR 1040.10 for laser products except for deviations pursuant to Laser Notice No. 50 dated June 24, 2007.
- Explanatory Label is as follow:



- Risk of electric shock hazard!
- Use only the power adapter delivered with the product.
- Never short-circuit the power adapter or the device.
- Never use damaged power cords or plugs or loose electrical sockets.
- Never touch the power cord with wet hands.
- Always disconnect from the main power before performing any work on the device.
- The unit has a power switch on the electronic module, short press, and wait seconds to power on after connecting the power source at the AC outlet.
- Handle cables and cable connectors with care.
- Do not allow inexperienced persons to operate this unit.
- Do not use this product if any of the components are cracked.
- Do not make alterations or modifications to the unit.
- Do not remove or obscure labels.
- Operate between 0° to 35°C (32° to 95°F).
- Keep the unit dry. Do not use near water, avoid contact with excessive moisture.
- Retain packaging. When transporting the unit, always disassemble and pack it in its original packaging.
- Never modify or attempt to repair the unit. Refer to qualified service personnel for service.
- Never use the product for anything other than its intended purpose.
- Mount on a flat surface.
- Never drop or allow an impact on the camera head.
- Ensure that the base plate and post assembly are all securely attached before attempting to move the unit.
- Structural parts may be heavy for some personnel. Please follow local safety requirements on proper lifting techniques.
- It is recommended to assemble the unit on the floor to allow easy access to all parts during assembly. After assembly, the unit can be transported to a final location with assistance.
- Due to the device's layout, the center of gravity is offset.
- Lift gently so you do not lose balance.

2 Product Overview

2.1 Key Components

The TLD250 Static Dimensioning System is designed to automatically dimension parcels and packages in post offices, sorting facilities, distribution centers and warehouses. It offers three models – TLD250-136, TLD250-156, and TLD250-176, and consists the following components:

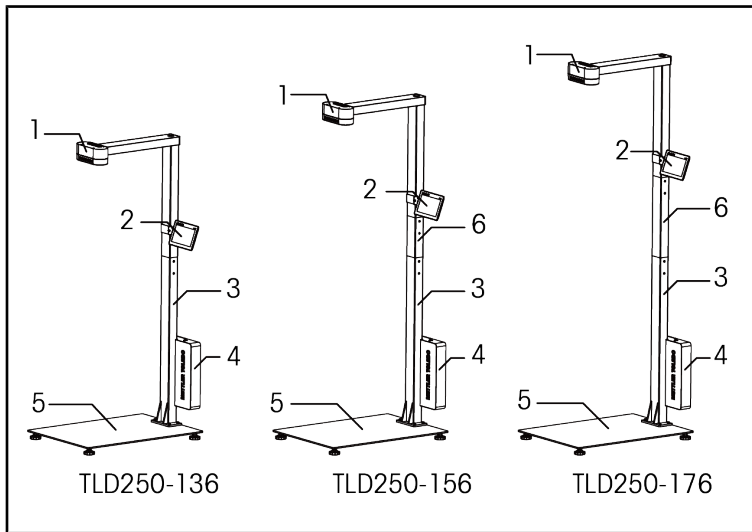

- 1 Upper post (with camera)
- 2 Display kit
- 3 Lower post
- 4 Electronic module
- 5 Base plate
- 6 Extension post
 - Length 20 cm for TLD250-156
 - Length 40 cm for TLD250-176

2.2 Connectivity

The electronic module provides the following interfaces for connection of power, camera, display, weighing scale, or other peripherals.

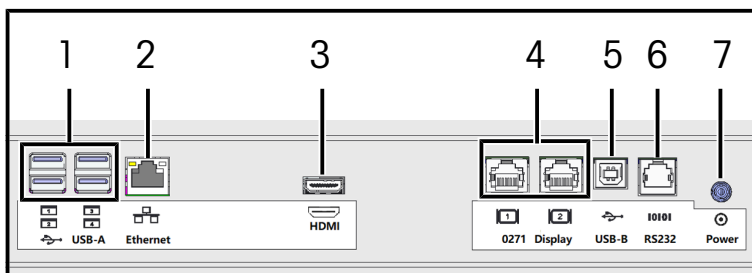

- 1 USB type A: for connection of
 - TLD250 camera
 - 0272 color touchscreen display
 - Weighing scale (configured as **USB - HIDPOS**)
 - Barcode scanner
- 2 Ethernet, for PC/ Host communications
- 3 HDMI: for connection of 0272 color touchscreen display
- 4 0271 display interface
- 5 USB, type B, for PC/ Host communications
- 6 RS232, for PC/ Host communications

7 Power port: To connect the power adapter

3 Inspection and Contents Checklist

Verify the contents and inspect the package immediately upon delivery. If the shipping container is damaged, check for internal damage and file a freight claim with the carrier if necessary. If the container is not damaged, remove the product from its protective package, noting how it was packed, and inspect each component for damage.

If shipping the product is required, it is best to use the original shipping container. The product must be packed correctly to ensure its safe transportation.

The product package should include the below items but may vary by region:

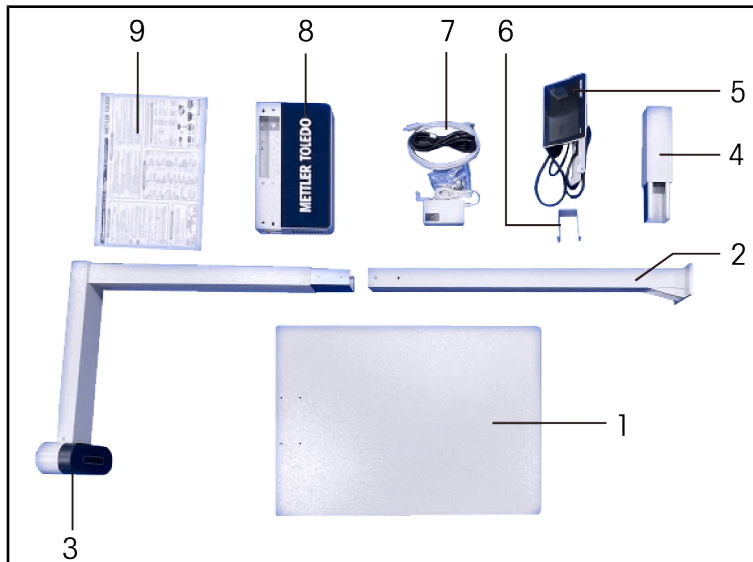

- 1 Base plate
- 2 Lower post
- 3 Upper post (with camera)
- 4 Extension post *
- 5 Display kit
- 6 U-shape bracket
- 7 Cables, screws, and power adapter
- 8 Electronic module
- 9 Quick guide

* : The product is delivered with an extension post of 20 cm in length. To configure an TLD250-176, please order a separate extension post of 40 cm in length. See [Spare Parts ► Page 21] for the ordering information.

4 Installation

4.1 Installation Requirements

- Avoid installation of the device near direct sunlight or near bright lights.
- Protect the device from static electricity and connect to a clean AC power outlet.
- Install the device on a table or sturdy level work surface large enough for the base plate and scale.
- Ensure the location provides enough work surface, clear from other objects in the measurement area.

4.2 Installation Instructions

Follow the instructions below or watch the "How-to-video-TLD250" to install the device.

Find the installation video on the link of <https://www.mt.com/TLD250>.

4.2.1 Tools

- 5 mm Allen key (provided with the product)
- Phillips screwdriver
- 16 mm open-end wrench, or adjustable wrench

4.2.2 Installing the Base Plate and the Lower Post

- 1 Place the base plate to the installation location which meets the requirements in [Installation Requirements ▶ Page 7].
- 2 Fasten the lower post to the base plate with four M6 screws. Tool: 5 mm Allen key.



4.2.3 Installing the Extension Post (optional)

The measuring capability of the device depends on the height of the camera view. To achieve measuring capability (see Technical Specifications) of the following model:

TLD250-136

Do not install the extension post.

TLD250-156

Install the extension post of 20 cm in length (delivered with the product).

(Recommended)

TLD250-176

Install the extension post of 40 cm in length (see [Spare Parts ▶ Page 21] for ordering information).

- Insert the extension post to the lower post and fasten it with four M4 flat-head screws. Tool: Phillips screwdriver.



4.2.4 Installing the Upper Post

- 1 Insert the camera cable into the lower post.
- 2 Fasten the upper post to the lower post with four M4 flat-head screws. Tool: Phillips screwdriver.



4.2.5 Installing the Display Kit

- 1 Partially fasten the display bracket to the U-shape bracket with one M4 pan-head screw, then rotate the U-shape bracket 180 degrees. Tool: Phillips screwdriver.



- 2 Slide the U-shape bracket onto the post, then rotate the display bracket back 180 degrees to match up the second screw hole.
- 3 Fasten the second M4 screw, then tighten both screws. Tool: Phillips screwdriver.



- 4 Remove the split cable bushing on the hole of the post, and then insert the display cables into the post.

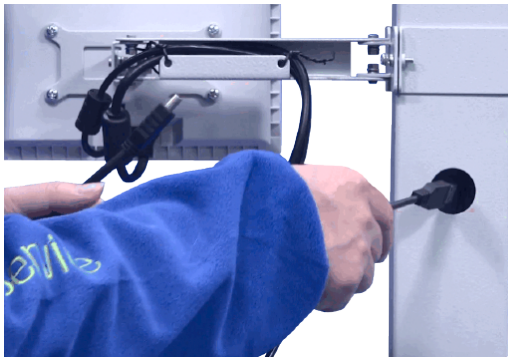

- 5 Organize the cables with the split cable bushing, and then attach the split cable bushing to the hole.



4.2.6 Installing the Electronic Module

- 1 Unlock the door of the electronic module.
- 2 Hang the electronic module onto the two holding pins at the rear of the lower post.



- 3 Fasten the electronic module with four M4 pan-head screws. Tool: Phillips screwdriver.



- 4 Connect the camera and display cables to the USB and HDMI interfaces. See [Connectivity ▶ Page 4] for more information.



4.2.7 Installing the Weighing Scale (optional)

If a weighing scale is to be used with the device, following the instructions below to install and connect the weighing scale.

- 1 Place the weighing scale on the base plate.
- 2 Choose one of the following mode to connect the device and the weighing scale to the host computer or shipping management system.
 - Mode A: Connect the weighing scale to TLD250's USB port, then connect TLD250 to the host computer or shipping control system.
 - Mode B: Connect the weighing scale and TLD250 separately to the host computer or shipping management system.

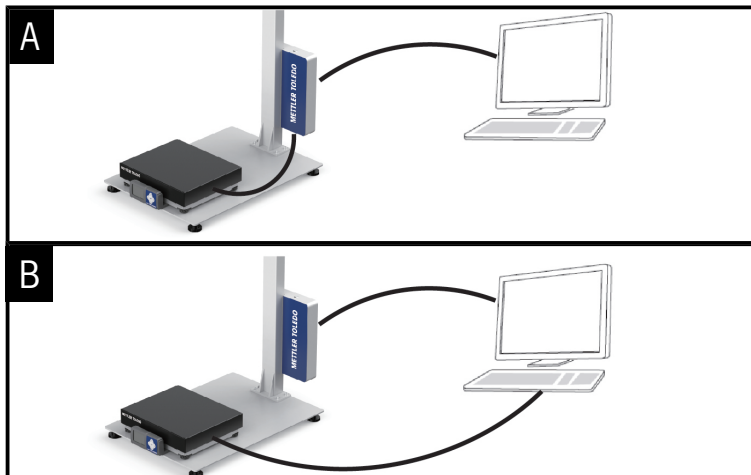

4.2.8 Leveling the Base Plate

- 1 Adjust the foot at each corner of the base plate until the base plate is level.
- 2 Tighten the nut to lock the foot at each corner. Tool: 16 mm open-end wrench or adjustable wrench.



4.2.9 Powering on

- 1 Connect the power cable connector to the port which has the label of "Input 12V". **NOTICE: Make sure that the power cable is routed through the opening cut at the bottom of the electronic module and is not pinched by the door.**



- 2 Lock the door of the electronic module.
- 3 Connect the power cable to an AC outlet. **NOTICE: Power requirement: 100 - 240 VAC, 50 -60 Hz.**
- 4 Press the power button on the top of the electric control box.



4.2.10 Powering the Device for First Use

If it is the first time to use the device, follow the instructions below to set it up after powering on.

- 1 After powering on, the display lights up and then enters the Bootup Wizard screen.

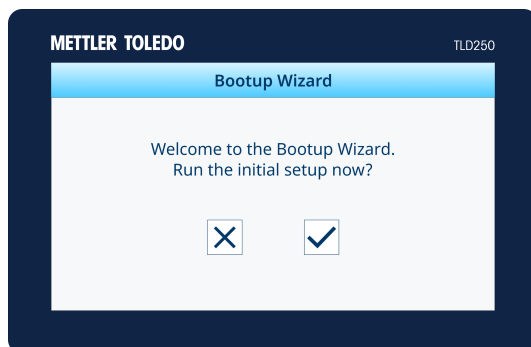

- 2 Press to start initial setup and continue at step 3, or press to enter the home screen.
- 3 Setup the date & time, communication protocol, and base type by following the instructions on the screen.
- 4 When done, press to confirm to reboot.

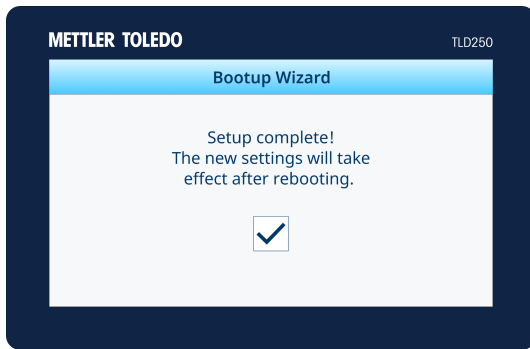

5 The display automatically reboots, then enters the home screen.

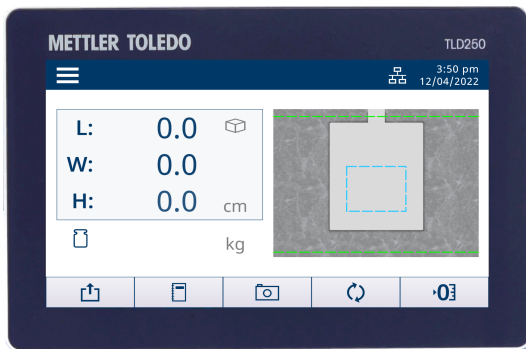

5 Operation

5.1 Measuring Capabilities

5.1.1 Definition of Dimensions

When reporting dimensions of an object, the device defines length, width and height as follows:



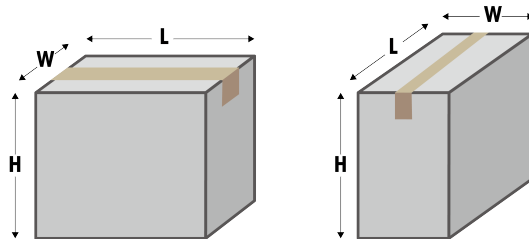



- Length – the longer of the two horizontal measurements
- Width – the shorter of the two horizontal measurements
- Height – the vertical measurement



The measurement capability depends on the specific model of the device. Refer to [General Technical Data ▶ Page 19] for more information.

5.1.2 Object Types







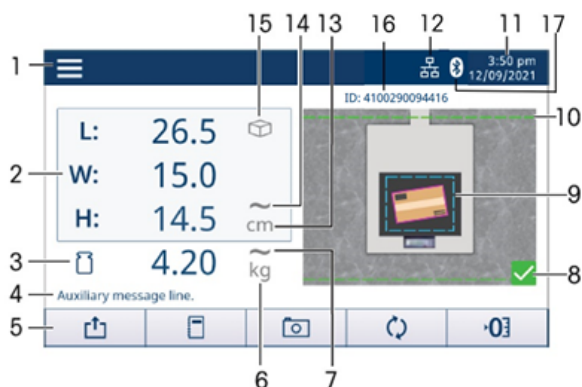



The device is designed to measure dimensions of both cuboidal and irregular (or non-cuboidal) shaped objects. Irregular shaped objects are dimensioned as the smallest cube around the shape, and the achieved irregular shapes include cylinders, donut, tubes, stacked or combined cuboidal objects.

Shape	Description	Shape	Description
	Standard cube		Stacked cubes
	Cylinder		Combined cubes
	Donut		Tube

5.2 Home Screen



- 1 Setup
- 2 Dimensioning results
- 3 Weighing results

		Weight	
		Dimensional weight	
		Billable weight	
4		Auxiliary message line	
5		Soft keys	
		TRANSMIT	To transmit data.
		LOG	To show the measuring records.
		CAPTURE	To capture top image of the object on the base plate.
		SWITCH	To switch between primary and secondary dimensioning unit.
		ZERO HEIGHT	To start ZERO HEIGHT operation.
6		Weight unit	
7		Weight motion	Appears when the weighing scale is in motion.
8		Capture saved	Appears when the image of the object is successfully saved.
9		Autosense Zone	Place the object at least partially within the Autosense zone.
10		Measurement boundary	
11		Date and time	
12		Connection status	
13		Dimension unit	
14		Dimension motion	Appears when the measurement is in motion.
15		Object type	
		Cuboidal	
		Non-cuboidal	
16		Bar code	
17		Bluetooth	

5.3 Performing a Measurement

5.3.1 Measuring an Object

- 1 To measure dimensions of an object, make sure that the dimension values show zero initially. If a weighing scale is connected to the device, it should be at zero weight.

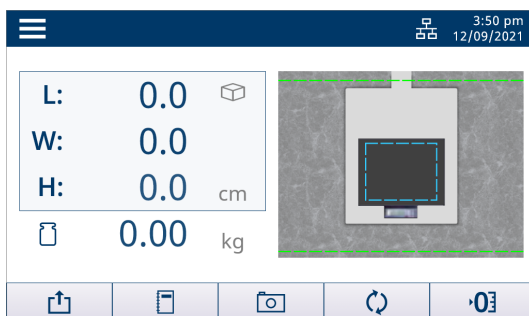

- 2 Place the object on the base plate or the weighing scale. Wait until the motion symbol  disappears for the final results.

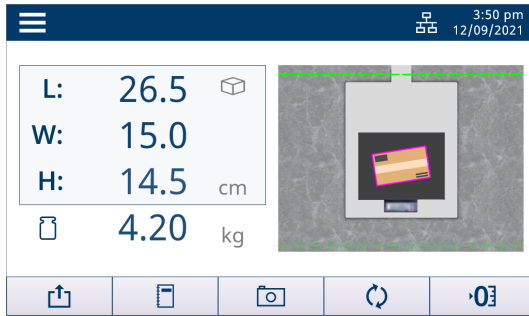

i Dos and dont's for placing an object

- The object must be placed completely within the measurement boundary (Green line).
- The object can be placed completely or partially within the Autosense Zone (Blue line).
- Very small objects close to the min dimensions should be placed in the center of the Autosense zone.

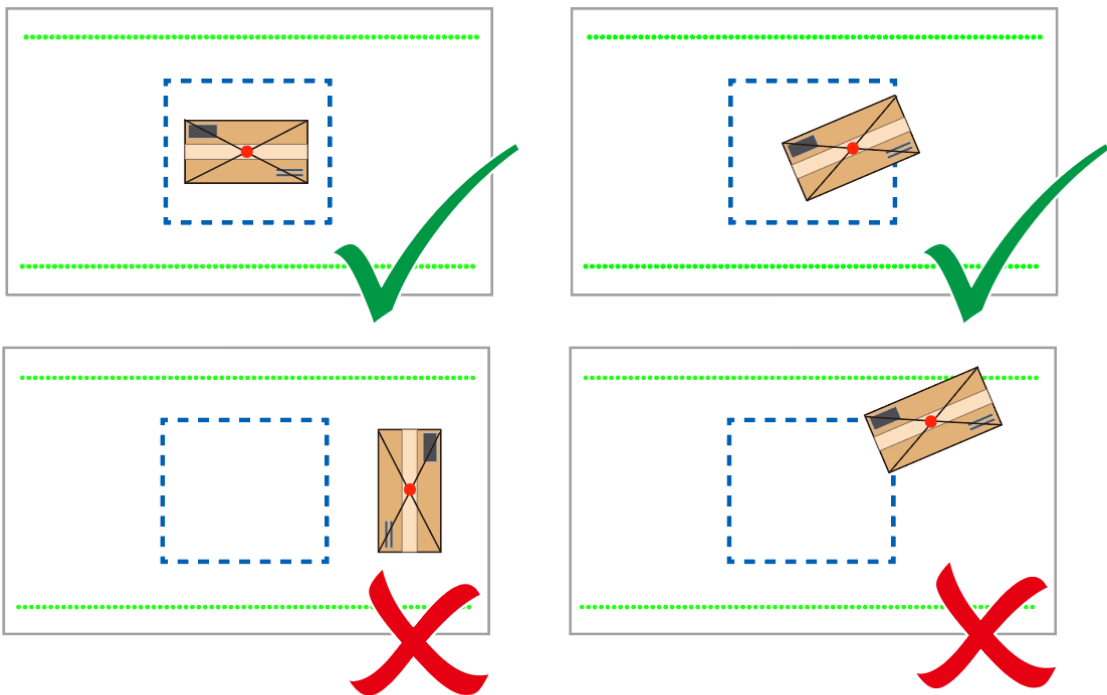

----- Autosense zone



..... Measurement boundary

5.3.2 Transmitting Data Manually

- To manually transmit data, press the TRANSMIT button  on the home screen.

- i** • The TRANSMIT button  is disabled when the data are unstable or the communication is configured to **HIDPOS** (in **Menu Setting ▶ Communication ▶ USB**).
- The data export can be configured to automatic mode (in **Menu Setting ▶ Communication ▶ Auto-Transmit Mode**).

5.3.3 Capturing Image Manually

- 1 To capture image of the object, press the CAPTURE button  on the home screen, then the image of the top side of the object will be saved.
- 2 When image is saved successfully, the icon  appears at the lower right corner of the screen.



- The CAPTURE button  is effective regardless if the device is motion or stable status.
- The image will be saved in .jpg format by default, and can be downloaded via the USB stick. For more information, please refer to the user manual.

5.3.4 Switching Unit







- To switch between the primary and secondary dimensioning unit, press the SWITCH button  on the home screen.

5.3.5 Zeroing Height









If the distance between the camera and the base plate is changed, e.g. when a scale is added or removed, it is necessary to perform a ZERO HEIGHT operation.



Perform zero height adjustment for a flat base

- 1 On the home screen, press the ZERO HEIGHT button .
- 2 The message "Are you sure to zero the height?" appears. Press  to continue (or press  to abort).
- 3 If the zero height operation is successful, the message "Zero height success" appears. Press  to confirm.
- or -
- 4 If the zero height operation is unsuccessful, the message "Zero height failed. Would you like to try again?" appears. Press  to repeat (or press  to abort) the zero height operation.



Perform zero height adjustment for an uneven base

- 1 On the home screen, press the ZERO HEIGHT button .
- 2 The message "Are you sure to zero the height?" appears. Press  to continue (or press  to abort).
- 3 The message "Please place the calibration box on the scale." appears. Follow the instruction and place the calibration box on the top of the scale. Press  to continue (or press  to abort).
- 4 If the zero height operation is successful, the message "Zero height success" appears. Press  to confirm.
- or -
- 5 If the zero height operation is unsuccessful, the message "Zero height failed. Would you like to try again?" appears. Press  to repeat (or press  to abort) the zero height operation.



- The base type (flat base or uneven base) is configured during the initial power-up setting or in **Menu Setting ▶ Dimensioner ▶ Base Type**.
- The calibration box can be ordered from METTLER TOLEDO. Refer to [Spare Parts ▶ Page 21] for ordering information.

6 Advanced Trouble Shooting

Issue	Possible reasons	Remedy
Zero Height Failed	Multiple bases of different height were detected in the Autosense Zone.	Set the Autosense Zone within the desired base plate/platform. Remove the obstacle from the desired base plate/platform.
	No flat base was detected in the Autosense Zone.	Level the base plate and/or scale. Put on the calibration box on the uneven scale.
	Inappropriate measurement environment	Avoid measurement under too bright or dark lights, no glare from overhead lights or abundant shadows.
	Exceed the zero range	Adjust the zero range in the menu or lower the height of the new measuring platform above the base plate.
	The scale platter is too shiny or reflective	Replace with an appropriate scale platter.
Display is Off	Power cable/adaptor is disconnected or damaged	Check the power cable connection along the electric module, power adaptor and AC outlet.
		Check the display cable connection between the display and the electric module.
		Press the power button on the electric module to power on the unit.
No live image	Camera cable is disconnected or damaged	Check the camera cable connection with the electronic module.
	Camera is damaged	Contact your local dealer or METTER TOLEDO Service.
Incorrect dimensions	Measuring on different platform, but without zeroing the height	Zero the height and measure again. If the issue persists, calibration may be required.
No dimensions detected	The object is placed completely beyond the Autosense Zone	Place the objects at least partially within the Autosense Zone.
	Over the maximum dimension	The object size is over the maximum dimension, please measure its dimensions manually, e.g., using a tape ruler.
	Under the minimum dimension	The object size is under the minimum dimension, please measure its dimensions manually, e.g., using a tape ruler.
	Under zero	Perform the Zero Height operation and measure again.

Issue	Possible reasons	Remedy
<p>—</p>	This symbol indicates the device failed to get stable dimensions.	
	The object is placed partially out of the measurement area	Place the object completely within the measurement area.
	The object edges are not well defined, e.g., rounded edges.	Reshape the object edges or repack the object.
	The object is placed too close to the post of the device.	Place the object in the center of the measurement area.
	Inappropriate object surface	Avoid the object surface that are reflective, shiny or too close to the base color.
	New camera sensor detected while the device is metrologically locked	Calibrate the device.
	Inappropriate measurement environment	Avoid measurement under too bright or dark lights, no glare from overhead lights or abundant shadows.

7 Technical Specifications

7.1 General Technical Data







Measuring capability	
TLD250_136	
Accuracy_Cuboidal Object	0.5 cm / 0.2 in
Accuracy_Non-Cuboidal Object	1.0 cm / 0.5 in
Maximum object size (L x W x H)	100 x 60 x 40 cm / 39 x 24 x 16 in
Minimum object size (L x W x H)	6 x 6 x 6 cm / 2.4 x 2.4 x 2.4 in
TLD250_156	
Accuracy_Cuboidal Object	0.5 cm / 0.2 in
Accuracy_Non-Cuboidal Object	1.0 cm / 0.5 in
Maximum object size (L x W x H)	100 x 60 x 60 cm / 39 x 24 x 24 in
Minimum object size (L x W x H)	6 x 6 x 6 cm / 2.4 x 2.4 x 2.4 in
TLD250_176	
Accuracy_Cuboidal Object	1.0 cm / 0.5 in
Accuracy_Non-Cuboidal Object	2.0 cm / 1.0 in
Maximum object size (L x W x H)	100 x 60 x 80 cm / 39 x 24 x 32 in
Minimum object size (L x W x H)	12 x 12 x 12 cm / 6 x 6 x 6 in
Dimensions and weight	
TLD250_136	
Physical dimensions (L x W x H)	70 x 50 x 148.2 cm / 27.6 x 19.7 x 58.3 in
Net weight	29.5 kg / 65 lb
TLD250_156	
Physical dimensions (L x W x H)	70 x 50 x 168.2 cm / 27.6 x 19.7 x 66.2 in
Net weight	31 kg / 68 lb
TLD250_176	
Physical dimensions (L x W x H)	70 x 50 x 188.2 cm / 27.6 x 19.7 x 74.1 in
Net weight	32.3 kg / 71 lb
Object requirements	
Object shape	Cuboidal and non-cuboidal solid objects (cylinder, trapezoid prism)
Object surface	All opaque packaging. Surfaces that are reflective, shiny and glossy chrome and/or black, covered with shrink/bubble wrap or polystyrene may cause performance deviations
Measurement time	
1 - 2 seconds	

*Display	
Display / keypad	O271 - 2.8" MonoChrome graphic display O272 - 7" color touchscreen display
Languages	English, Chinese*, Portuguese*, German*, French*, Italian*
Power	
Power supply	Universal 100-240 V, external power supply
Input voltage / power consumption	12 VDC/ 5A / 60 W
Interface connectivity	
Connectors	Standard: 1 x RS232 1 x USB 1 x Ethernet RJ45 (standard) Optional: Bluetooth (Dual-Mode)
Host protocols	CSN810, MT-SICS, Proto-U, USB Keyboard Wedge, USB HIDPOS
Operation environment	
Background lighting	Avoid direct sunlight and bright overhead lighting during measurement.
Temperature / humidity	0° to 35°C (32° to 95°F) / Non-condensing
Approval	
NTEP, MC Cuboidals*, OIML, MID	
Others	
Scale interface	USB (HIDPOS), TCP/IP (MT-SICS)
Barcode reader interface	USB
Secondary remote display (optional)	O271 - 2.8" Monochrome graphic display, or O272-7" color touchscreen display
Mechanical environment class	M1
Electromagnetic class	E1

*Pending

8 Spare Parts

Order #	Description	
Mounting bracket		
30714979	Flange mount kit (mount directly to counter top)	-
30714982	Extension post, 40 cm, for TLD250-176	-
Camera module		
30714974	Camera module	
Electronic module		
30714975	Electronic module	
Scale platter		
30499003	Platter, for BC30/60, SS, black	
30714984	Platter, 400x500, SS, black	
Display module		
30714976	0272 display module, color touch display	
30125729	0271 display module, mono LCD display, for wall mount	
Display bracket		
30714992	Display bracket	
Calibration box		

30667982	Calibration box, 450x300x120 mm, for TLD250-136 and TLD250-156	
30668030	Calibration box, 450x300x300 mm, for TLD250-136, TLD250-156, and TLD250-176	
Power supply and cables		
30668034	Power supply, 60W, 12VDC	
71210406	Power cord, type-B, 2.0 m, US, CA, MX, JP	
71210407	Power cord, type-F, 2.0m, 180°, EU	-
72243746	Power cord ext., type-G, UK	-
72243748	Power cord, type-I, 2.5m, 180°, CN, AU	-
30714983	Power cord combination kit, type-B, type-F, type-G and type-I	-
64057361	Cable, USB-A to USB-B, 3m	
30668031	0272 display module USB cable	
30668032	0272 display module HDMI cable	

To protect your product's future:

METTLER TOLEDO Service assures the quality, measuring accuracy and preservation of value of this product for years to come.

Please request full details about our attractive terms of service.

► www.mt.com/service

www.mt.com

For more information

Mettler-Toledo GmbH

Im Langacher 44
8606 Greifensee, Switzerland
www.mt.com/contact

Subject to technical changes.
© 09/2023 METTLER TOLEDO. All rights reserved.
30668025B



30668025