

Transmitter 7220X

Your Representative:

04/03
52 120 823

Mettler Toledo GmbH, Process Analytics, Postfach, 8902 Urdorf, Switzerland
Tel. +41 (01) 736 22 11, Fax +41 (01) 736 26 36



Warranty

Defects occurring within 3 years from delivery date shall be remedied free of charge at our plant (carriage and insurance paid by sender).

Accessories: 1 year

Subject to change without notice

Contents

| | |
|--|-------------|
| Package contents and unpacking | VII |
| Information on this instruction manual | VII |
| Warnings and notes | VII |
| Typical representations | VII |
| Safety information | VIII |
| Proper use | X |
| EC Declaration of Conformity | XI |
| EC-Type-Examination Certificate | XII |
| 1 Assembly, installation, and maintenance | 1-1 |
| Assembly | 1-1 |
| Installation and commissioning | 1-5 |
| Notes concerning performance | 1-6 |
| Maintenance and cleaning | 1-6 |
| 2 Capabilities of Transmitter 7220X | 2-1 |
| Overview of Transmitter 7220X | 2-1 |
| Sensocheck [®] sensor monitoring | 2-2 |
| Temperature detection | 2-2 |
| Passive output 2 | 2-4 |
| Typical wirings | 2-5 |
| Terminal assignments | 2-11 |
| 3 Operating Transmitter 7220X | 3-1 |
| User interface | 3-1 |
| Measuring mode | 3-2 |
| Measurement recorder | 3-4 |
| Menu structure | 3-5 |
| Menu operation | 3-6 |

| | | |
|----------|--|------------|
| 4 | Parameter setting | 4-1 |
| | Language selection | 4-1 |
| | The three levels of parameter setting | 4-1 |
| | Factory setting | 4-3 |
| | Measurement display | 4-3 |
| | Input filter | 4-4 |
| | Temperature compensation of the process medium | 4-4 |
| | Calibration solution | 4-6 |
| | Concentration | 4-6 |
| | Sensor selection | 4-8 |
| | Output 1 | 4-10 |
| | Output 2 | 4-15 |
| | Alarm settings | 4-23 |
| | Alarm processing / NAMUR signals | 4-24 |
| | HART [®] Communication | 4-25 |
| | Setting the clock | 4-26 |
| | Point of measurement/note | 4-27 |
| | Device diagnostics | 4-27 |
| | Measurement recorder | 4-27 |
| | Passcode entry | 4-29 |
| | Release of options | 4-30 |
| 5 | Calibration | 5-1 |
| | Why do you have to calibrate? | 5-1 |
| | Monitoring functions for calibration | 5-1 |
| | Calibration menu | 5-2 |
| | Temperature detection during calibration | 5-3 |
| | Automatic calibration with standard calibration solution | 5-4 |
| | Calibration with manual entry of conductivity | 5-5 |
| | Calibration by entering data from premeasured sensors | 5-7 |
| | Calibration with sampling | 5-7 |

| | | |
|-----------|---|-------------|
| 6 | Diagnostics menu | 6-1 |
| | Message list | 6-1 |
| | Cal record | 6-1 |
| | Logbook | 6-2 |
| | Device description | 6-2 |
| | Device diagnostics | 6-3 |
| | Measurement recorder (listing) | 6-4 |
| 7 | Maintenance menu | 7-1 |
| | Measurement point maintenance | 7-1 |
| | Resistance measurement | 7-2 |
| | Current source function | 7-2 |
| | Temperature probe adjustment | 7-2 |
| | Manual entry of controller output | 7-3 |
| 8 | Error messages | 8-1 |
| 9 | Product line and accessories | 9-1 |
| 10 | Specifications | 10-1 |
| | Concentration ranges | 10-4 |
| | Sensors | 10-5 |
| 11 | Concentration curves | 11-1 |
| 12 | Calibration solutions | 12-1 |
| 13 | Glossary | 13-1 |
| 14 | Index | 14-1 |

This page has been left empty for technical reasons.

Package contents and unpacking

Unpack the Transmitter carefully.
Check the shipment for transport damage and completeness.

The package should contain:

- Transmitter 7220X
- This instruction manual
- Any accessories ordered with the Transmitter
(For available accessories, see Chap. 9)

Information on this instruction manual

Warnings and notes



Warning

Warning means that ignoring the given instructions may lead to a malfunction of or damage to the Transmitter and to property damage or personal injuries.

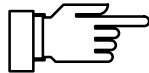

Note

Notes provide important information that should be followed when using the Transmitter.

Typical representations

The keys of the Transmitter 7220X are shown like this in the text:

meas , **cal** , **maint** , **par** , **diag**

◀ , **▶** , **▲** , **▼** , **enter**

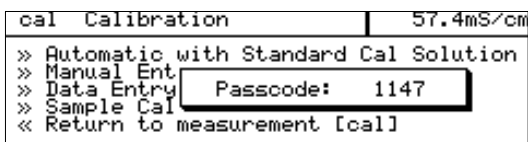

Menus shown in the instruction manual may differ somewhat from the display of your Transmitter. This depends on which options your Transmitter is equipped with.

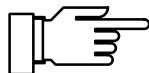

If the behavior of your Transmitter deviates from the description in this manual, check whether the manual corresponds to the software version of your Transmitter: see Pg 6-2, Device description.

Safety information

Be sure to read and observe the following instructions!



The safety instructions must always be followed for your own safety.

Failure to follow these instructions may result in injuries.

The instrument has been designed in accordance with the state of the art and complying with the applicable safety regulations. When operating the instrument, certain conditions may nevertheless lead to danger for the operator or damage to the instrument.



Whenever it is likely that the protection has been impaired, the instrument shall be made inoperative and secured against unintended operation.

The protection is likely to be impaired if, for example:

- the instrument shows visible damage
- the instrument fails to perform the intended measurements
- after prolonged storage at temperatures above 70 °C
- after severe transport stresses

Before recommissioning the instrument, a professional routine test in accordance with EN 61010-1 must be performed. This test should be carried out by the manufacturer.

The Transmitter 7220X is approved for operation in hazardous locations. It has been developed and manufactured in compliance with the applicable European guidelines and standards. The Declaration of Conformity confirms the compliance with the applicable European guidelines and standards.

The stipulations of EN 60 079-14:1996 and the following must be observed when installing the instrument in a hazardous location. The Transmitter 7220X may only be connected to certified intrinsically safe circuits. The electrical data are listed in the EC-Type-Examination Certificate (see Pg XII).

Before commissioning it must be proved that the intrinsic safety is maintained when connecting the instrument to other equipment, such as supply units including cables and lines.

When commissioning, a complete configuration must be carried out.

Manipulations of the instrument other than described in this manual are not permitted.

Assembly/dismantling, installation, operation, and maintenance may only be carried out by qualified personnel as defined by the automation industry in compliance with the applicable regulations and this instruction manual. Be sure to observe the specified ambient conditions and installation instructions.

Proper use

The Transmitter 7220X is a 2-wire transmitter. It is supplied with power from the 4 to 20 mA loop current, which also transmits the measured variable.

The Transmitter 7220X is used for continuous determination of conductivity and concentration and for temperature measurement in liquids. The Transmitter is designed for industrial use. The enclosure is protected to IP 65 and allows direct wall mounting on the site.



The instrument shall not be used in a manner not specified by this manual. Any applications not specified in this manual are inadmissible.

Mettler-Toledo GmbH

Process Analytics

Adresse Im Hackacker 15 (Industrie Nord), CH-8902 Urdorf, Schweiz
Briefadresse Postfach 76, CH-8902 Urdorf
Telefon 01-736 22 11
Telefax 01-736 26 36
Internet www.mt.com
Bank Credit Suisse First Boston, Zürich (Acc.-No. 0835-370501-21)

Declaration of conformity Konformitätserklärung Déclaration de conformité



We/Wir/Nous

Mettler-Toledo GmbH, Process Analytics
Im Hackacker 15
8902 Urdorf
Switzerland

declare under our sole responsibility that the product,
erklären in alleiniger Verantwortung, dass dieses Produkt,
déclarons sous notre seule responsabilité que le produit,

Description

Beschreibung/Description

7220X

to which this declaration relates is in conformity with the following standard(s) or
other normative document(s).

auf welches sich diese Erklärung bezieht, mit der/den folgenden Norm(en) oder
Richtlinie(n) übereinstimmt.

auquel se réfère cette déclaration est conforme à la (aux) norme(s) ou au(x)
document(s) normatif(s).

Explosion Protection

Explosionsschutzrichtlinie

Protection contre les

explosions

94/9/EG

Standard/ Norm/ Standard

EN 50 014: 1997 + A1 + A2
EN 50 020: 1994

EMC Directive/EMV-

Richtlinie

Directive concernant la CEM

89/336/EWG
SR 734.5, VEMV

Standard/ Norm/ Standard

DIN EN 61326 / VDE 0843 Teil 20: 1998-01
DIN EN 61326 / A1 / VDE 0843 Teil 20 / A1: 1999-05

Place and Date of issue

Ausstellungsort / - Datum

Lieu et date d'émission

Urdorf, 13.12.2001

Nr. 52 999 999C FL

Artikel Nr. 52960202 KE

52960202.DOC

METTLER TOLEDO

Version b



(1) **EC-TYPE-EXAMINATION CERTIFICATE**
(Translation)

- (2) Equipment and Protective Systems Intended for Use in Potentially Explosive Atmospheres - **Directive 94/9/EC**
(3) EC-type-examination Certificate Number:



PTB 00 ATEX 2189

- (4) Equipment: Conductivity Transmitter type 7220X Opt. ...
(5) Manufacturer: Mettler Toledo AG
(6) Address: Im Hackacker 15, CH-8902 Urdorf
(7) This equipment and any acceptable variation thereto are specified in the schedule to this certificate and the documents therein referred to.
(8) The Physikalisch-Technische Bundesanstalt, notified body No. 0102 in accordance with Article 9 of the Council Directive 94/9/EC of 23 March 1994, certifies that this equipment has been found to comply with the Essential Health and Safety Requirements relating to the design and construction of equipment and protective systems intended for use in potentially explosive atmospheres, given in Annex II to the Directive.
The examination and test results are recorded in the confidential report PTB Ex 00-20246.
(9) Compliance with the Essential Health and Safety Requirements has been assured by compliance with:
EN 50014:1997 + A1 + A2 **EN 50020:1994**
(10) If the sign "X" is placed after the certificate number, it indicates that the equipment is subject to special conditions for safe use specified in the schedule to this certificate.
(11) This EC-type-examination Certificate relates only to the design and construction of the specified equipment in accordance with Directive 94/9/EC. Further requirements of this Directive apply to the manufacture and supply of this equipment.
(12) The marking of the equipment shall include the following:

II 2 (1) G EEx ib [ia] IIC T6

Zertifizierungsstelle Explosionsschutz
By order:

Braunschweig, January 24, 2001

Dr.-Ing. U. Johannsmeyer
Regierungsdirektor



sheet 1/3

EC-type-examination Certificates without signature and official stamp shall not be valid. The certificates may be circulated only without alteration. Extracts or alterations are subject to approval by the Physikalisch-Technische Bundesanstalt. In case of dispute, the German text shall prevail.

Physikalisch-Technische Bundesanstalt • Bundesallee 100 • D-38116 Braunschweig

SCHEDULE

(13)

(14) **EC-TYPE-EXAMINATION CERTIFICATE PTB 00 ATEX 2189**

(15) Description of equipment

The conductivity-transmitter type 7220X Opt. is used preferably for detecting and processing electrochemical quantities and is equipped with an input for electric conductivity (EC) measurement and an input for the measurement of temperature.

The application occurs within the hazardous area.

The maximum permissible ambient temperature is 50 °C.

Electrical data

Loop measuring circuit..... type of protection Intrinsic Safety EEx ib IIC
(KL 9, 10) only for connection to a certified intrinsically safe circuit

maximum values:

$U_i = 30 \text{ V}$
 $I_i = 100 \text{ mA}$
 $P_i = 0.8 \text{ W}$
 $C_i = 22 \text{ nF}$
 L_i negligibly low

Output circuit 2 type of protection Intrinsic Safety EEx ib IIC
(KL 11, 12) only for connection to a certified intrinsically safe circuit

maximum values:

$U_i = 30 \text{ V}$
 $I_i = 100 \text{ mA}$
 $P_i = 0.8 \text{ W}$
 $C_i = 48 \text{ nF}$
 L_i negligibly low

EC-measuring circuit type of protection Intrinsic Safety EEx ia IIC
(KL 1, 3, 4, 5)

maximum values:

$U_o = 10 \text{ V}$
 $I_o = 145 \text{ mA}$
 $P_o = 150 \text{ mW}$
 $R = 34.5 \text{ } \Omega$

linear characteristic

$C_o = 680 \text{ nF}$
 $L_o = 1 \text{ mH}$

sheet 2/3

EC-type-examination Certificates without signature and official stamp shall not be valid. The certificates may be circulated only without alteration. Extracts or alterations are subject to approval by the Physikalisch-Technische Bundesanstalt. In case of dispute, the German text shall prevail.

Physikalisch-Technische Bundesanstalt • Bundesallee 100 • D-38116 Braunschweig

Physikalisch-Technische Bundesanstalt



Braunschweig und Berlin

SCHEDULE TO EC-TYPE-EXAMINATION CERTIFICATE PTB 00 ATEX 2189

$C_i = 3 \text{ nF}$
 L_i negligibly low

Temperature measuring circuit type of protection Intrinsic Safety EEx ia IIC
(KL 6, 7, 8) maximum values:

$U_o = 10 \text{ V}$
 $I_o = 3 \text{ mA}$
 $P_o = 4 \text{ mW}$
 $R = 1.6 \text{ k}\Omega$

linear characteristic

$C_o = 475 \text{ nF}$
 $L_o = 1.8 \text{ mH}$
 $C_i = 50 \text{ nF}$
 L_i negligibly low

PA for connection to the equipotential bonding system

The loop measuring circuit is safely electrically isolated from the other intrinsically safe circuits up to a voltage of 60 V.

The output circuit 2 is safely electrically isolated from the EC- and from the temperature measuring circuit up to a voltage of 60 V.

The EC-measuring circuit and the temperature measuring circuit are electrically interconnected.

(16) Test report PTB Ex 00-20246

(17) Special conditions for safe use

none

(18) Essential health and safety requirements

met by the standards mentioned above

Zertifizierungsstelle Explosionsschutz

By order:

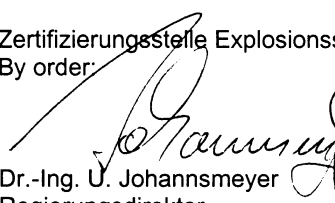
Dr.-Ing. U. Johannsmeyer
Regierungsdirektor



Braunschweig, January 24, 2001

sheet 3/3

EC-type-examination Certificates without signature and official stamp shall not be valid. The certificates may be circulated only without alteration. Extracts or alterations are subject to approval by the Physikalisch-Technische Bundesanstalt. In case of dispute, the German text shall prevail.

Physikalisch-Technische Bundesanstalt • Bundesallee 100 • D-38116 Braunschweig

1 Assembly, installation, and maintenance

Assembly



- The weatherproof enclosure allows direct wall mounting. See dimension drawing, Fig. 1-1.
- With the ZU 0136 mounting plate and the ZU 0125 bracket kit, the Transmitter can also be mounted on a post or pipe. See dimension drawing, Fig. 1-2.



- The ZU 0157 protective hood provides additional protection against direct weather exposure and mechanical damage. See dimension drawing, Fig. 1-2. For mounting the protective hood, you require the ZU 0136 mounting plate.



- The ZU 0158 protective case provides optimum protection against dust, moisture, and mechanical damage. See dimension drawing, Fig. 1-3. With the ZU 0220 bracket kit, the protective case can also be mounted on a post or pipe.

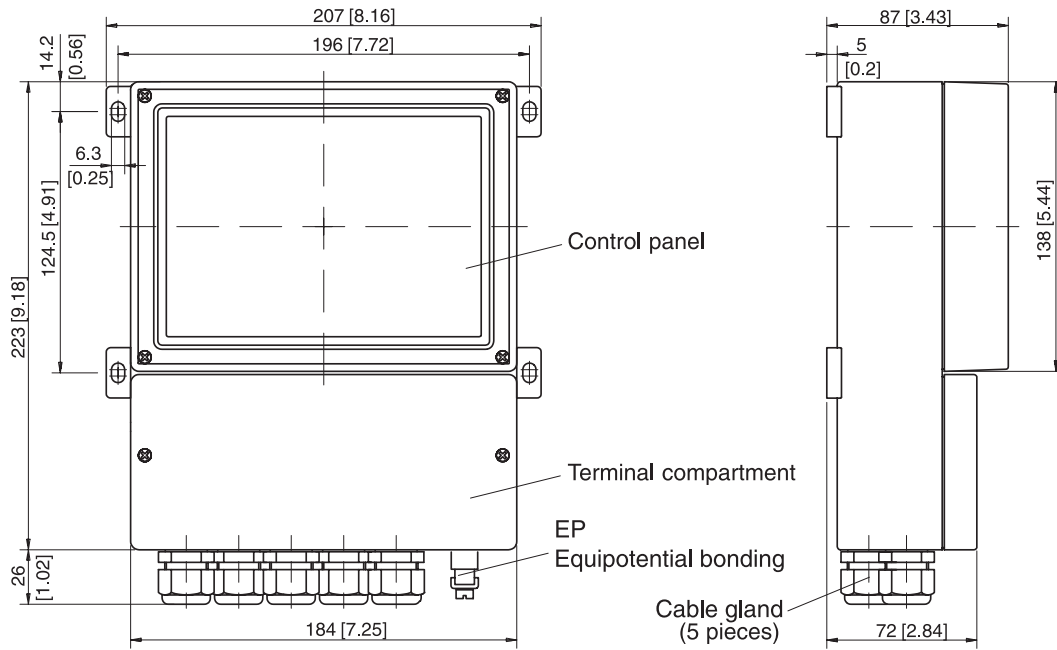

Note: All dimensions in mm [inches].

Fig. 1-1 Dimension drawing of Transmitter 7220X

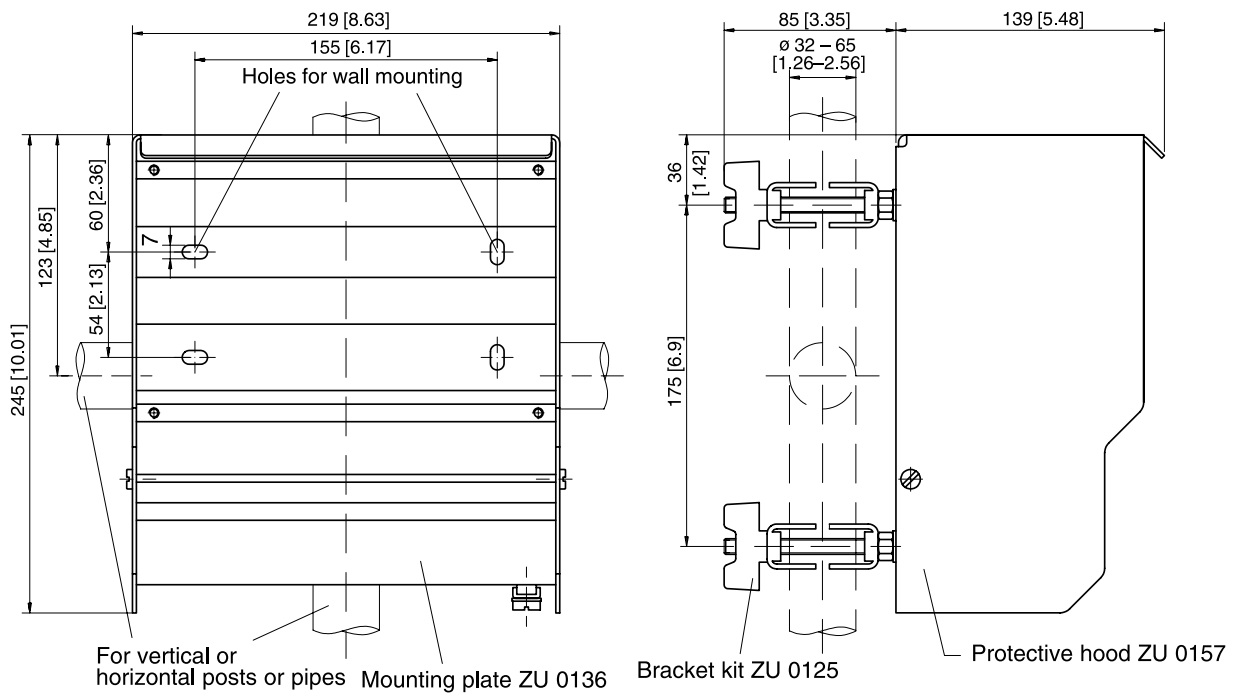

Note: All dimensions in mm [inches].

Fig. 1-2 ZU 0136 mounting plate, ZU 0157 protective hood and ZU 0125 bracket kit

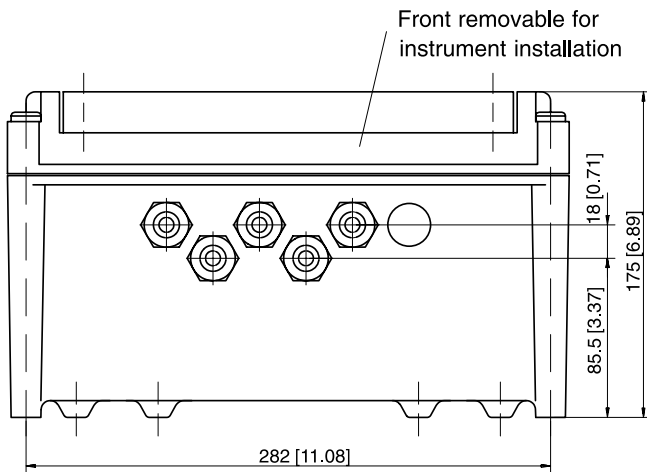

Observe ESD!
Clean with moistened cloth only!

Protective panel polycarbonate, transparent

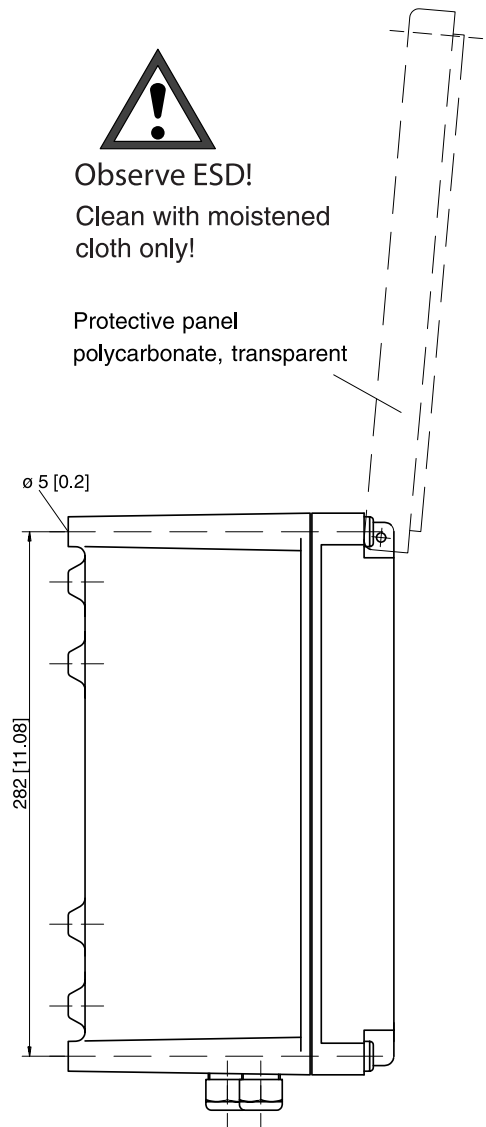
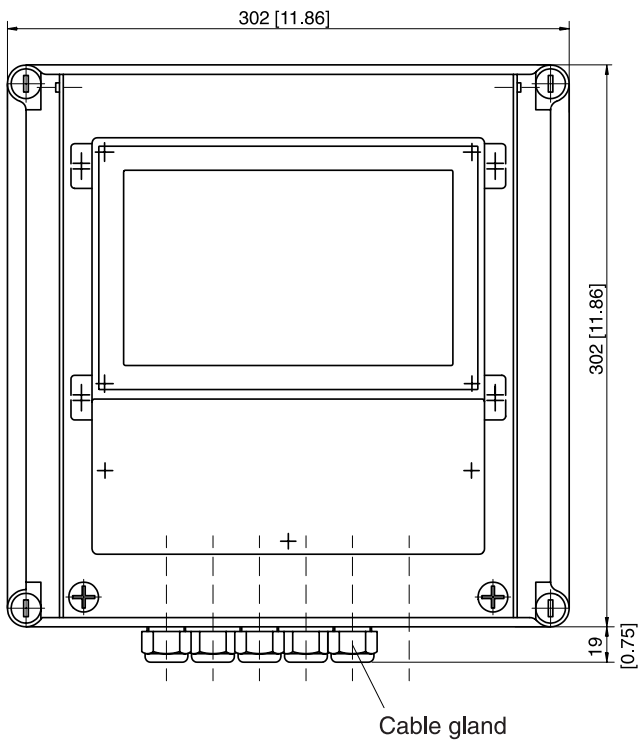

Note: All dimensions in mm [inches].

Fig. 1-3 Dimension drawing of ZU 0158 protective case

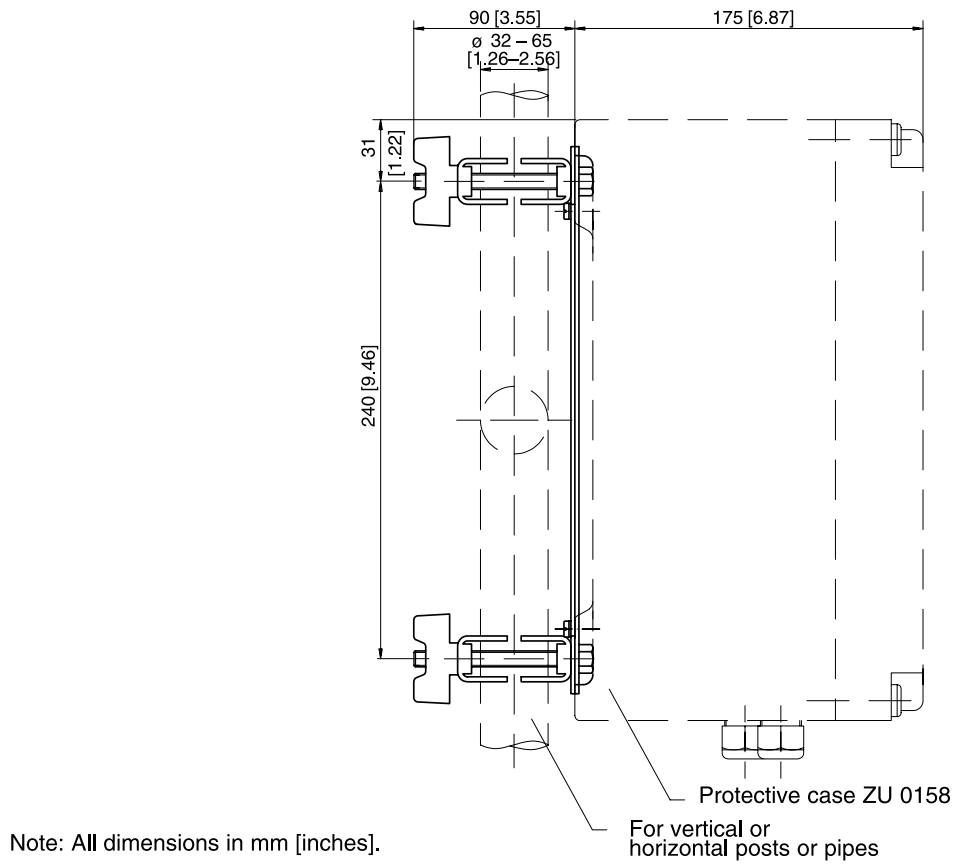

Note: All dimensions in mm [inches].

Fig. 1-4 ZU 0220 bracket kit for ZU 0158 protective case

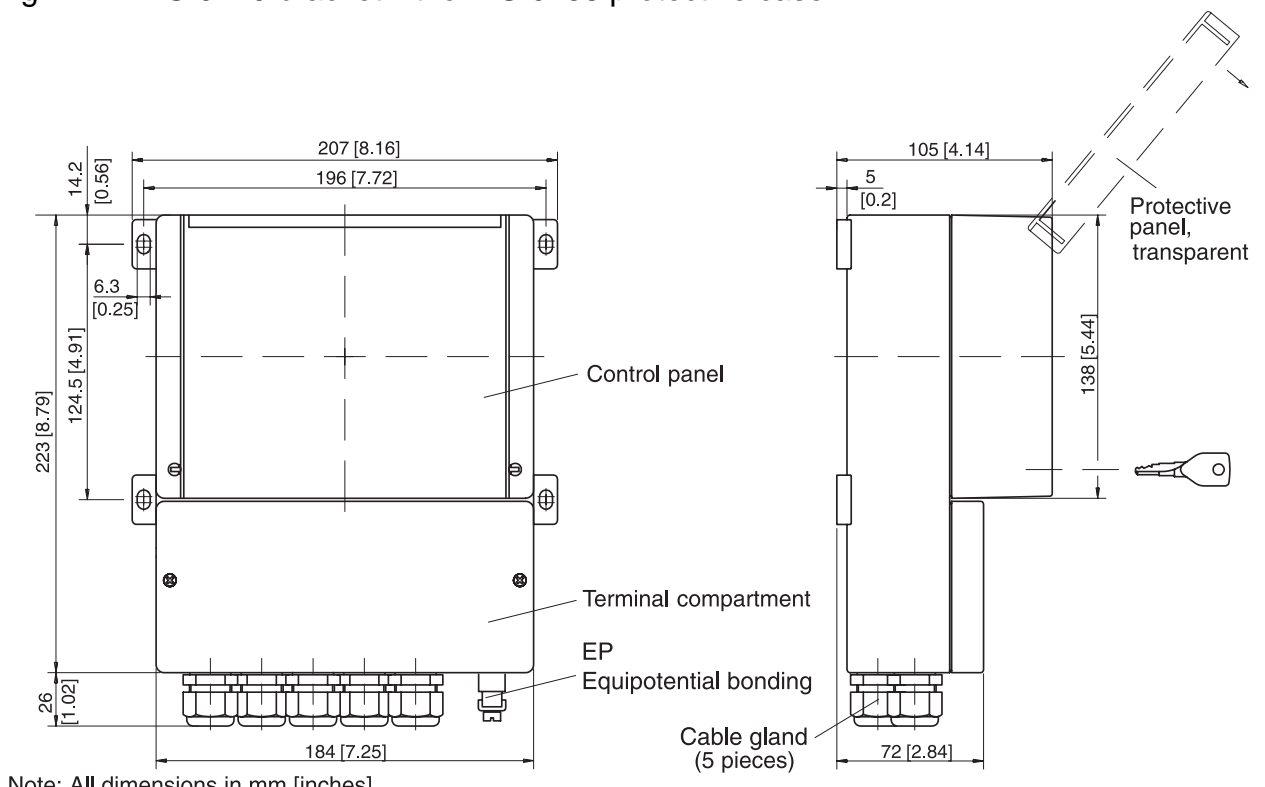

Note: All dimensions in mm [inches].

Fig. 1-5 Transmitter with lockable protective panel (Opt. 432)

Installation and commissioning



- Installation and commissioning of the Transmitter 7220X may only be carried out by trained experts in accordance with this instruction manual and as per applicable local and national codes. Be sure to observe the technical specifications and input ratings.
- All parameters must be set by a system administrator prior to commissioning.
- Be sure to observe the safety precautions on Page VIII and the following!



Before connecting the Transmitter 7220X to a supply unit, make sure that it cannot output more than 30 V DC, 100 mA and 0.8 W

To connect the Transmitter 7220X, open the cover of the terminal compartment (lower part of the Transmitter) by removing the two screws. The terminals are suitable for single wires and flexible leads up to 2.5 mm² (AWG 14). On the right-hand side next to the terminals there are two contact holes for connecting a HART[®] hand-held terminal.



As delivered, all terminals are open to allow easy insertion of the connecting wires. If the terminals are only half open, it may occur that the wire is pushed below the contacting element and does not make contact when the terminal is closed.

For wiring examples, see Pg 2-5 and the following.



The outer EP (PA) terminal must be connected with equipotential bonding to divert electrostatic charges from the front panel overlay.

Notes concerning performance



At ambient temperatures below 0 °C the readability of the LC display may be reduced. This does not impair the instrument functions.



The real-time clock, logbook, cal record and sensor statistics are battery-backed for approx. 1 year. After longer power outages these data can be lost. The Transmitter then displays the message “Warn Time/Date”, and the date is reset to 01/01/1990. Time and date must be reentered.

Maintenance and cleaning

The Transmitter 7220X contains no user repairable components.

To remove dust, dirt and spots, the external surfaces of the Transmitter may be wiped with a damp, lint-free cloth. A mild household cleaner may also be used if necessary.



When operating the Transmitter in a hazardous area, pay attention to electrostatic discharge!



Only clean the Transmitter with a moistened cloth!

Also the ZU 0158 protective case and the lockable protective panel (Opt. 432) may only be cleaned with a moistened cloth!

2 Capabilities of Transmitter 7220X

Overview of Transmitter 7220X



Commissioning of the Transmitter 7220X may only be carried out by trained experts in accordance with this instruction manual. Be sure to observe the technical specifications and input ratings during installation.

All parameters must be set by a system administrator prior to commissioning.

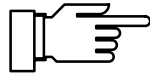

The Transmitter 7220X is approved for operation in hazardous locations.

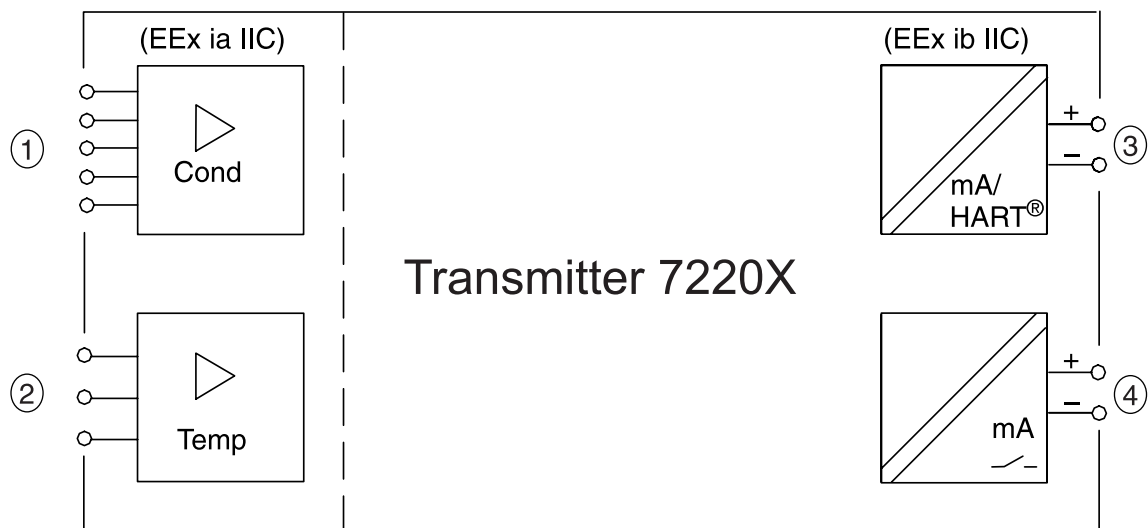

Fig. 2-1 System functions of Transmitter 7220X

Fig. 2-1 shows the system functions. 2-electrode and 4-electrode sensors ① and a temperature probe ② can be connected.

With the optional concentration function, substance concentrations for certain process solutions can be calculated and displayed.

Output 1 ③ is galvanically isolated and operates as a current sink for the 4 to 20 mA (22 mA) loop current (supply unit required).

It supplies the Transmitter with power from the loop current and simultaneously transmits the configured process variable.

The galvanically isolated output 2 ④ also operates as a current sink for the 0 (4) to 20 mA (22 mA) loop current (supply unit required). It can transmit a further user-defined process variable or can be used as a switching or controller output.



Outputs 1 and 2 are additionally capable of transmitting alarm and warning messages as 22 mA signals. Parameter setting is described from Page 4-24 on in the “Alarm processing / NAMUR signals” chapter.

Sensocheck® sensor monitoring

If the measured value is significantly out of range, Sensocheck delivers the “Warn Sensocheck” signal. Especially when using 2-electrode cells, the signal is generated when decisive measurement errors (10 - 30 %) occur due to polarization or contamination. At the same time, Sensocheck monitors the cable influence. The warning signal is generated, for example, when unsuitable cables or cables which are too long for the measurement range have been laid. Sensocheck can be switched off.

Temperature detection

The InPro sensors have an integrated temperature probe which automatically detects the temperature and makes it available for calculating the measured value.

The Transmitter 7220X also allows to work with manual temperature specification or using separate temperature probes (Pt 100, Pt 1000, Ni 100, or NTC 30 kΩ).

Why temperature compensation?

The detection of the temperature of the process or calibration solution is important for two reasons:

- Compensation of the temperature dependence of the process solution:
The conductivity of the process solution is temperature-dependent. By entering a temperature coefficient for the process solution and a reference temperature, all conductivity values can be converted to the reference temperature (usually 20 or 25 °C).
- The conductivity of the calibration solution is temperature-dependent. Therefore, during calibration the temperature of the calibration solution must be known in order to determine its temperature-corrected conductivity value from the table stored in the Transmitter.

Automatic temperature compensation

For automatic temperature compensation, the Transmitter 7220X detects the process temperature with a temperature probe (Pt 100 / Pt 1000 / Ni 100 / NTC 30 k Ω).

3-wire configuration of the temperature probe eliminates the temperature measurement error caused by the lead resistance.

The lines to terminals 6 and 7 must have the same cross section. (Important for Pt 100 or Ni 100!)

3-wire connection

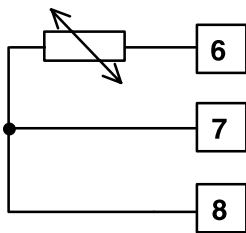

2-wire connection

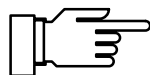
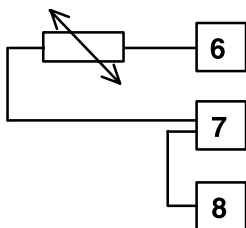

For 2-wire connection, connect the temperature probe to terminals 6 and 7. A jumper must be set across terminals 7 and 8.

Passive output 2

If your Transmitter is equipped with Option 487 (second current output, passive), an additional output is available to you.

This output is passive. It must be supplied by an additional power supply (e.g. WG 20 isolated supply).

Output 2 can be used either as 0 – 20 mA (22 mA) current output or as switching output (alarm contact or limit contact).

As a current output it can be defined for the various process variables. In addition, a message for failure, warning and functional check can be output as 22 mA signal.

If your Transmitter is also equipped with Option 353 (Controller function), you can use the output as an analog or switching controller output.

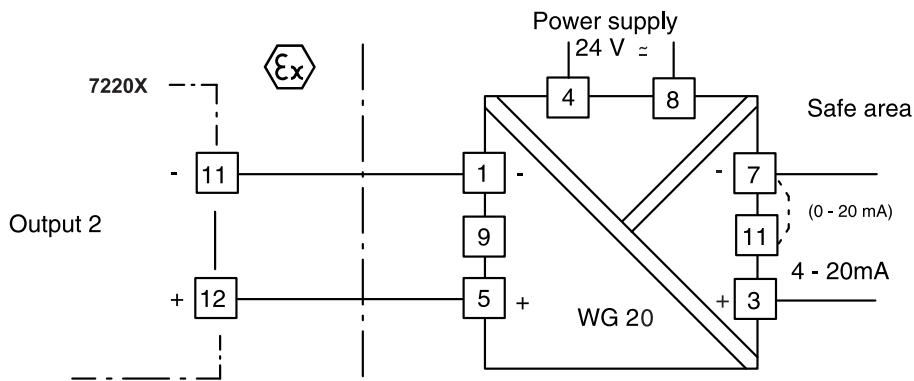

Fig. 2-2 Connection of output 2 as current output with WG 20

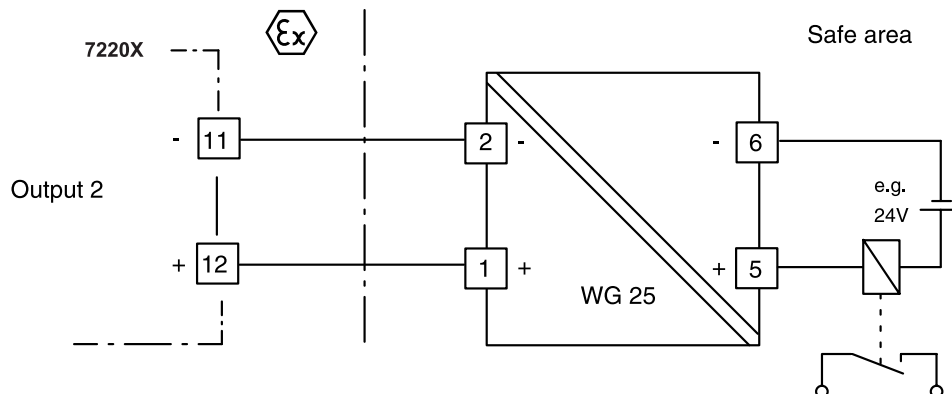
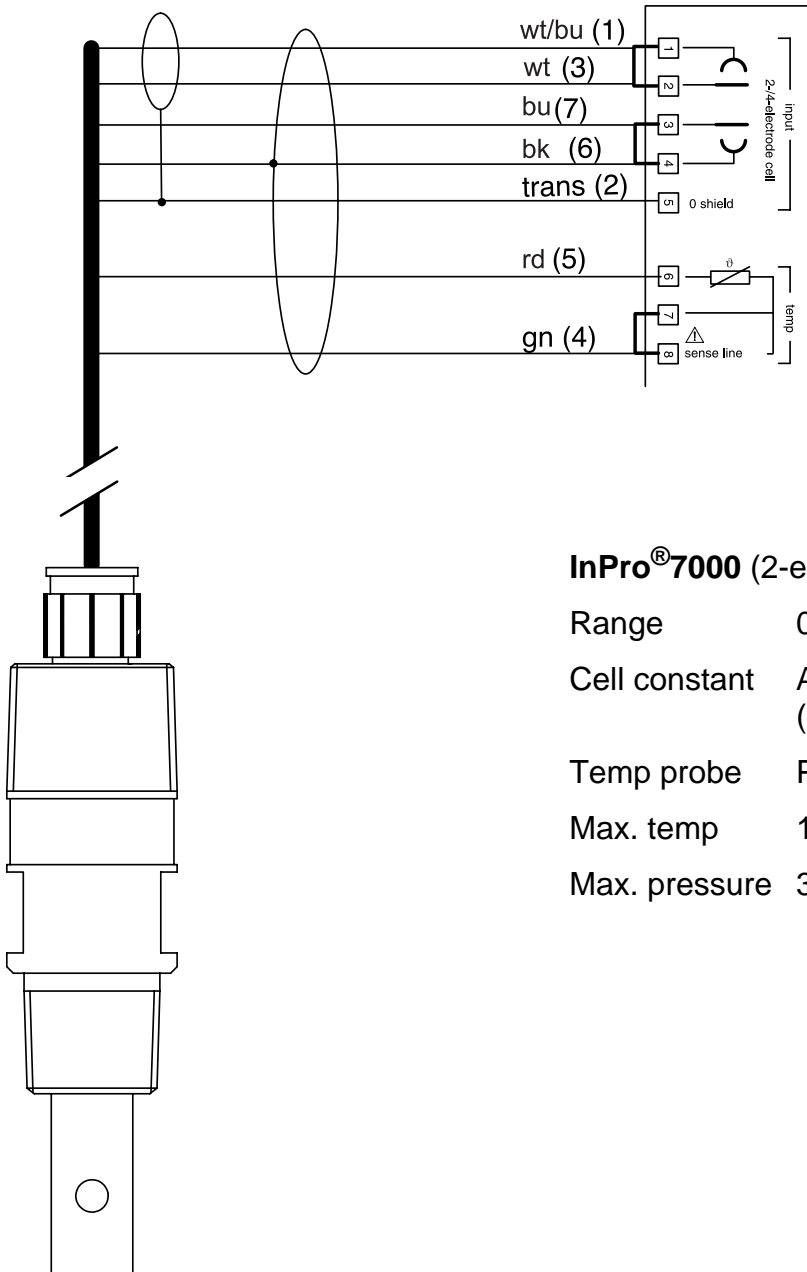

Fig. 2-3 Connection of output 2 as switching output with WG 25 (Observe the technical specifications of WG 25.)

Typical wirings

Conductivity measurement with InPro[®]7000 2-electrode sensor



InPro[®]7000 (2-electrode sensor)

| | |
|---------------|--|
| Range | 0.02 to 2000 $\mu\text{S}/\text{cm}$ |
| Cell constant | Approx. 0.1 cm^{-1} (exact value on rating plate) |
| Temp probe | Pt 1000 |
| Max. temp | 100 °C |
| Max. pressure | 34 bars (25 °C) |

Conductivity measurement with InPro[®] 7001 2-electrode sensor

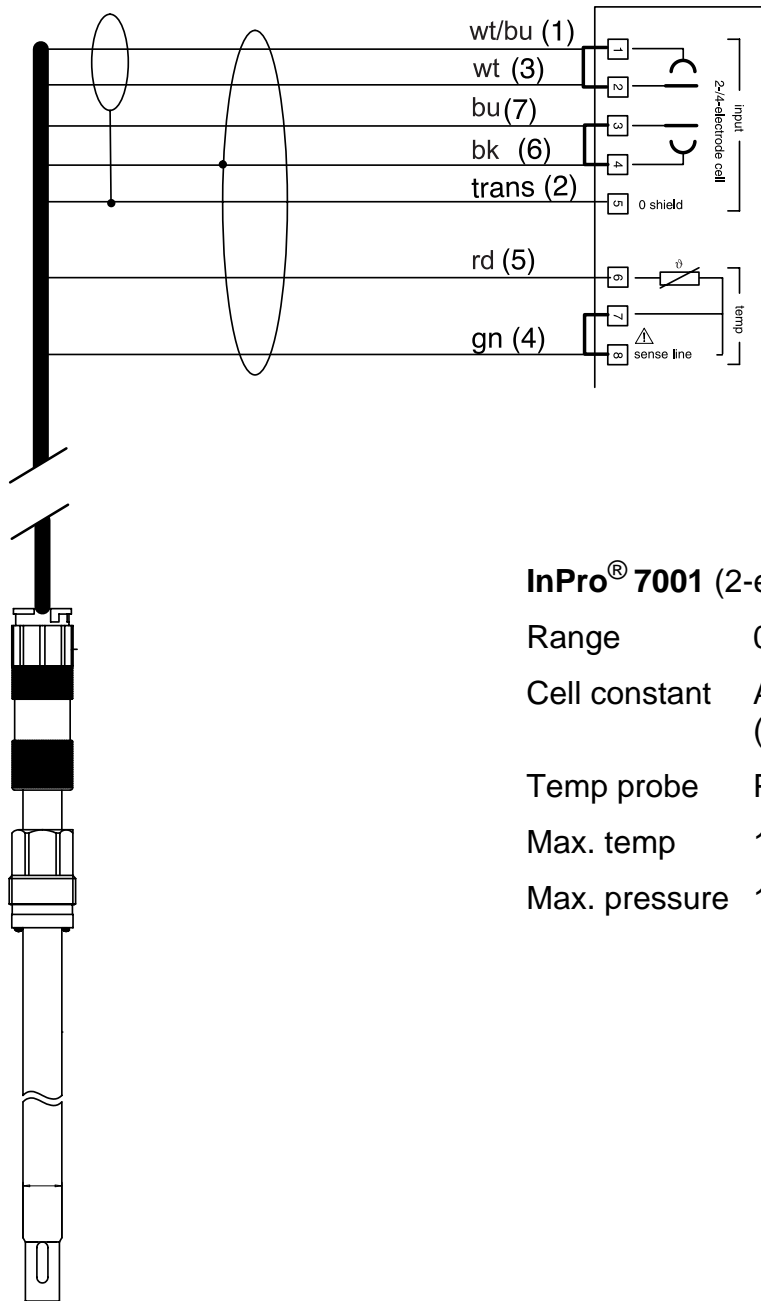

InPro[®] 7001 (2-electrode sensor)

| | |
|---------------|--|
| Range | 0.02 to 200 $\mu\text{S/cm}$ |
| Cell constant | Approx. 0.1 cm^{-1} (exact value on rating plate) |
| Temp probe | Pt 1000 |
| Max. temp | 100 °C |
| Max. pressure | 14 bars (25 °C) |

Conductivity measurement with InPro[®] 7002/7003 2-electrode sensors

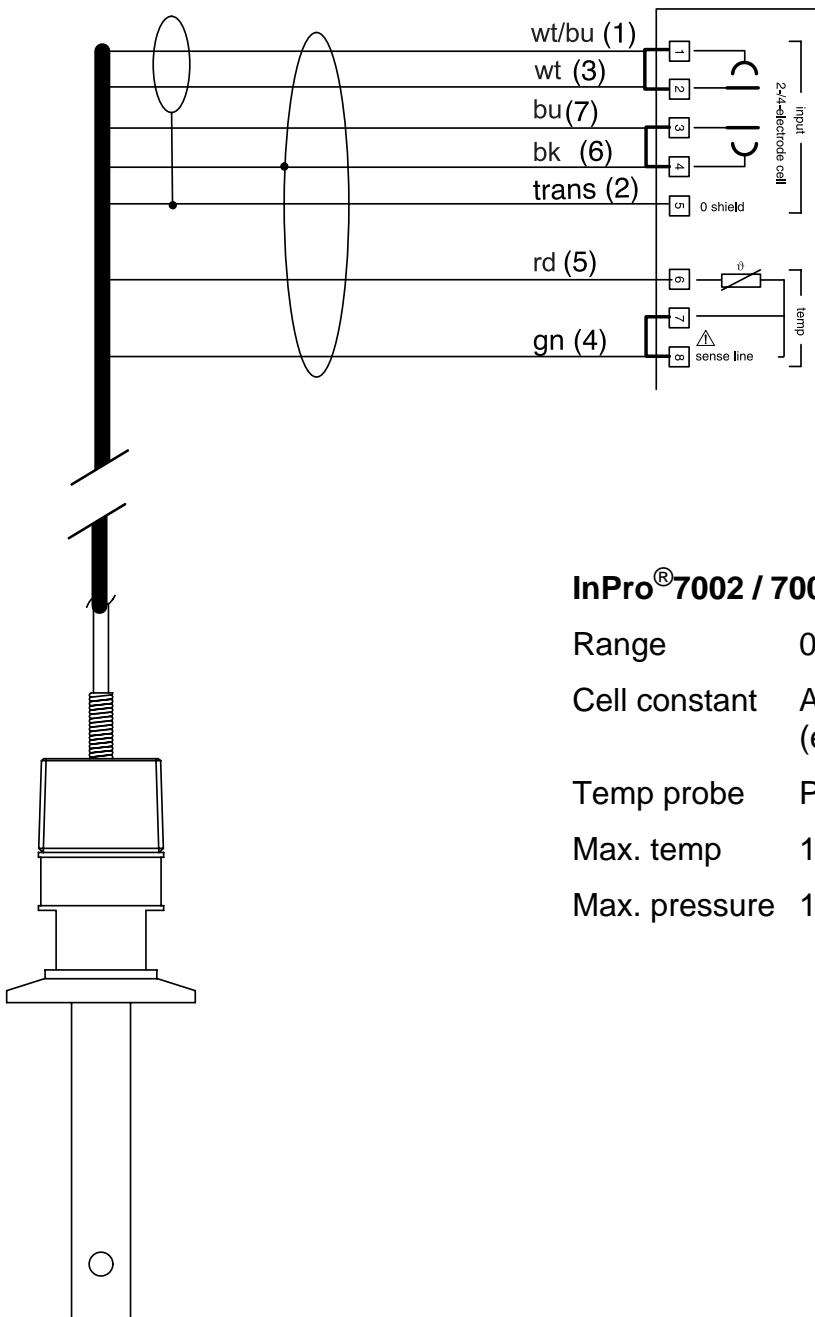

InPro[®] 7002 / 7003 (2-electrode sensors)

| | |
|---------------|--|
| Range | 0.02 to 1000 $\mu\text{S}/\text{cm}$ |
| Cell constant | Approx. 0.1 cm^{-1} (exact value on rating plate) |
| Temp probe | Pt 1000 |
| Max. temp | 100 °C |
| Max. pressure | 14 bars (25 °C) |

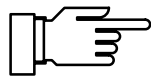
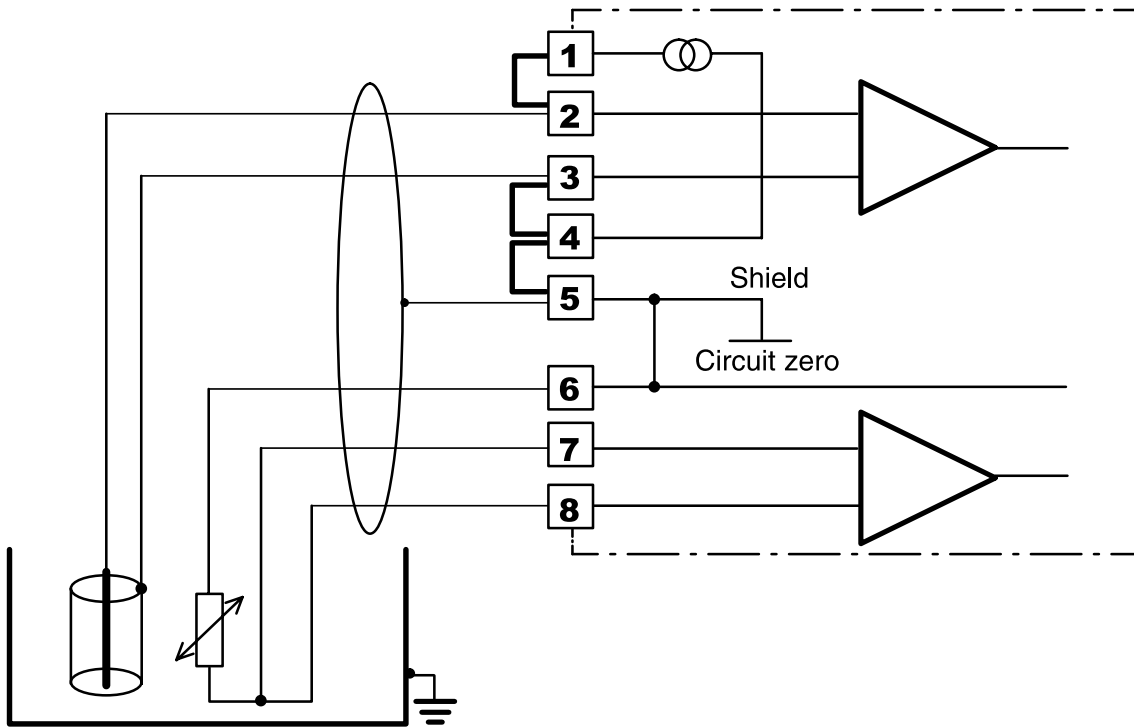

With a 2-electrode coaxial sensor, the outer electrode can simultaneously be used for equipotential bonding. Then, terminals 3, 4, and 5 must be jumpered.

Fig. 2-4 Wiring example for other 2-electrode coaxial sensor

Conductivity measurement with InPro[®] 7100/7104 4-electrode sensors

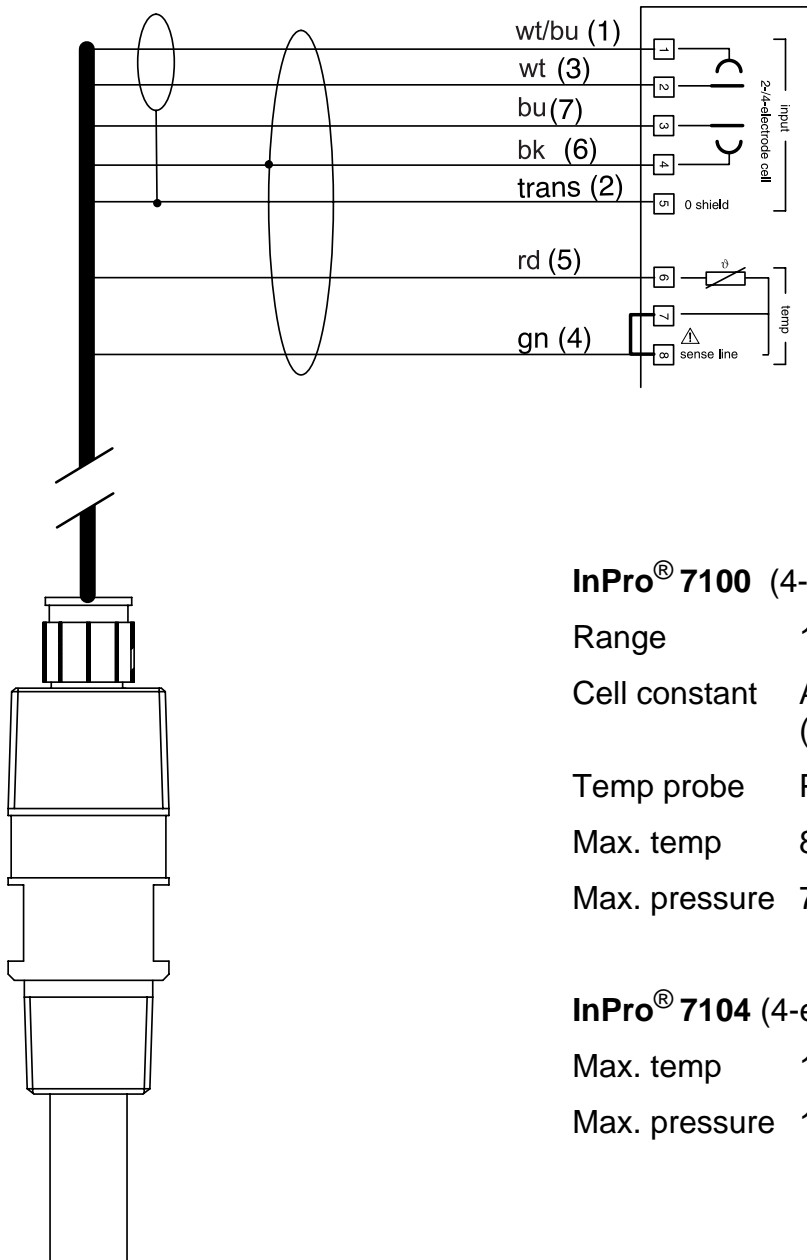

InPro[®] 7100 (4-electrode sensor)

| | |
|---------------|---|
| Range | 10 μ S/cm to 300 mS/cm |
| Cell constant | Approx. 0.6 cm ⁻¹ (exact value on rating plate) |
| Temp probe | Pt 1000 |
| Max. temp | 80 °C |
| Max. pressure | 7 bars (25 °C) |

InPro[®] 7104 (4-electrode sensor)

| | |
|---------------|---------------|
| Max. temp | 120°C |
| Max. pressure | 14 bar (25°C) |

4-electrode sensor

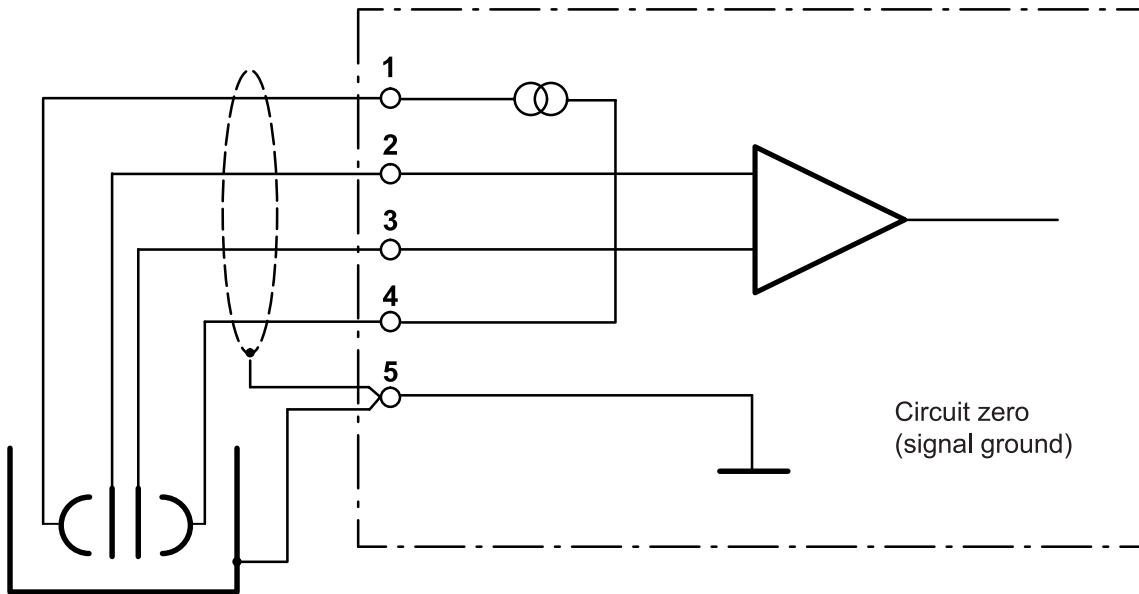

Fig. 2-5 Wiring example with a 4-electrode sensor and equipotential bonding

Example of complete wiring

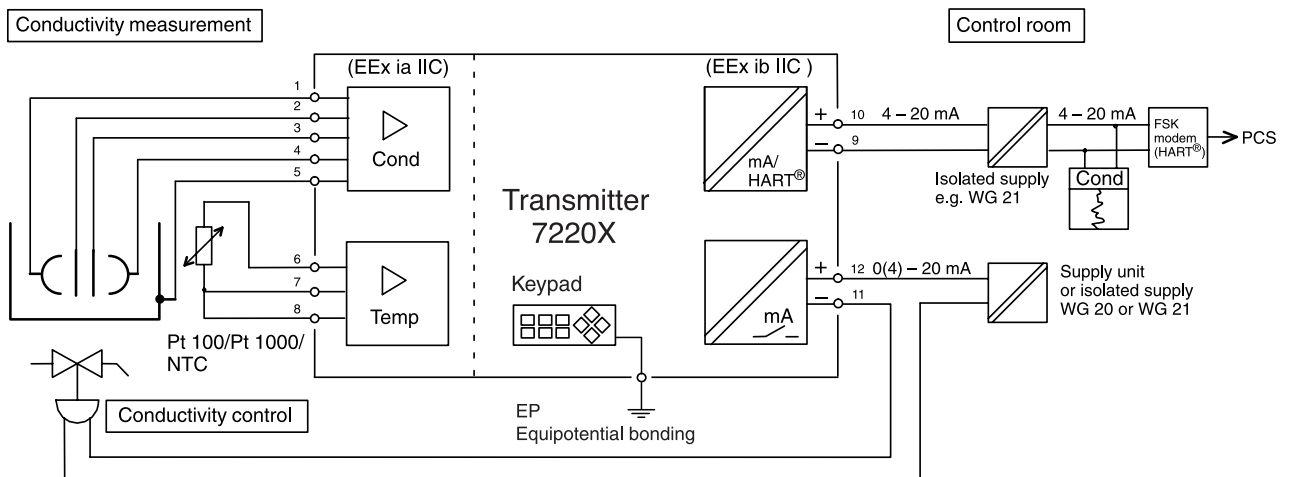
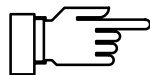

Fig. 2-6 Conductivity measurement with recorder evaluation, control, and connection to a process control system



Connect EP terminal to equipotential bonding!
 See Fig. 1-1 and Fig. 1-5 on Pg 1-2 and the following.

Terminal assignments

Insert jumper if necessary (also see Pg 2-8)!

Insert jumper if necessary (also see Pg 2-8)!

Insert jumper 7, 8 if necessary (also see Pg 2-3)!

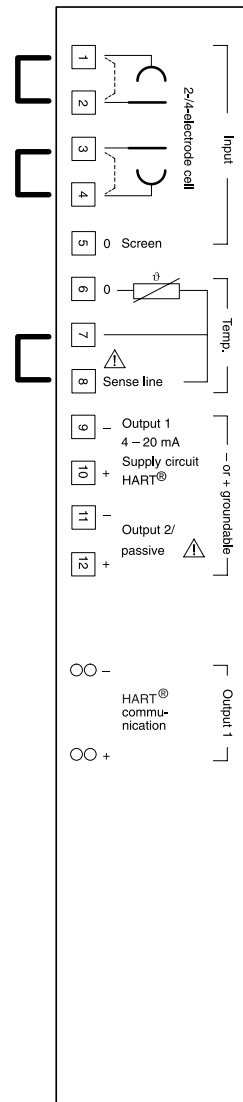

Fig. 2-7 Terminal assignments

This page has been left empty for technical reasons.

3 Operating Transmitter 7220X



Commissioning of the Transmitter 7220X may only be carried out by trained experts in accordance with this instruction manual.

All parameters must be set by a system administrator prior to commissioning.

User interface

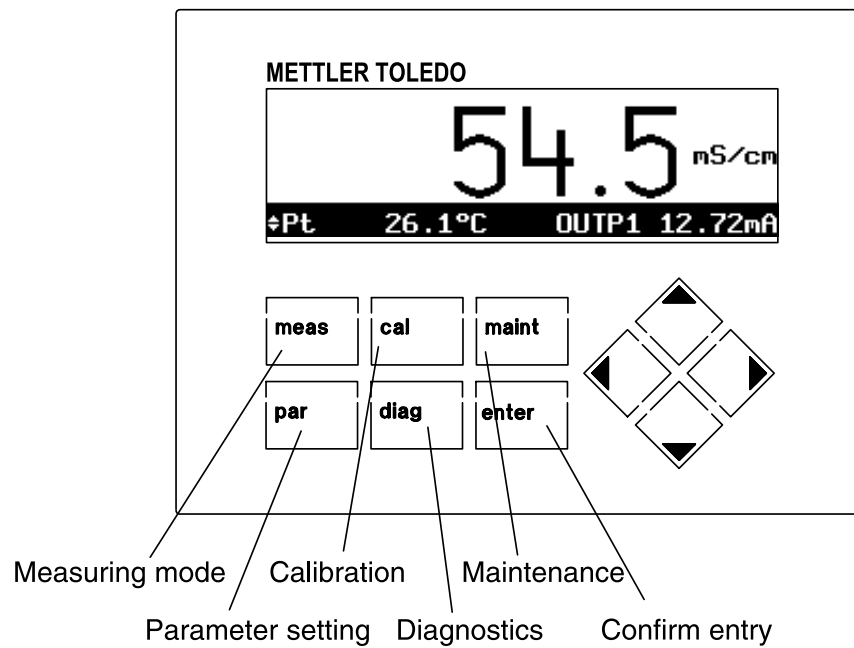
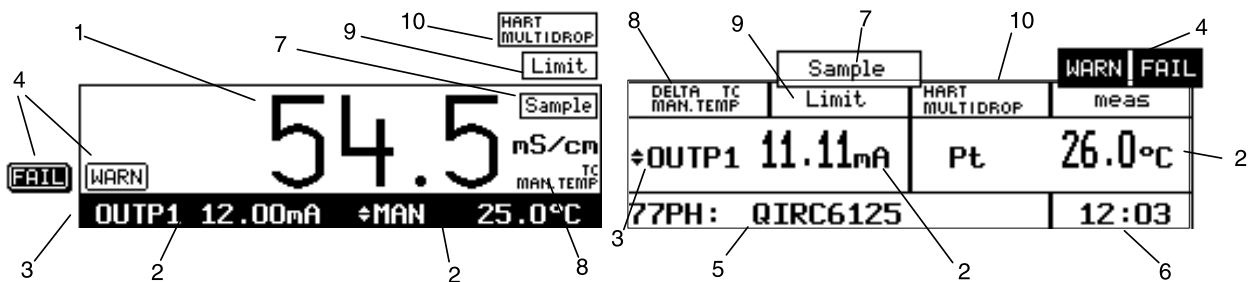

Fig. 3-1 User interface of Transmitter 7220X

Measuring mode











In the measuring mode, two different types of numerical displays are available. If your Transmitter is equipped with Option 448 (Measurement recorder), the variation of any two measured values can also be represented graphically. By pressing **meas** you can switch between the different display types.



The display consists of the following elements:

- 1 The measured value in the main display is selected during Parameter Setting (see Pg 4-3)
- 2 The measured values in the secondary displays are selected using ▲ and ▼ .
- 3 The selection symbol ◆ indicates which secondary display can be edited. By pressing ◀ or ▶ you can switch between the two secondary displays.
- 4 NAMUR messages: Warning (maintenance required) and failure
- 5 Tag number or note (Switch with **enter**)
- 6 Current time
- 7 Sampling for calibration
- 8 Reference to dependencies of process variables
- 9 Limit values exceeded
- 10 HART® Multidrop mode is active. Output current 1 is permanently set to 4 mA. The measured value is digitally modulated onto the current.

Keypad assignment in measuring mode

| | | | | |
|---|---|---|---|---|
| |  | switches between the two different types of measured value display. With Option 448 also to the measurement recorder. | | |
|  |  |  |  | activate Calibration, Parameter Setting, Maintenance, or Diagnostics. |
| |  | switches between tag number and note. | | |
| |  |  | select secondary display for changing the process variable. | |
| |  |  | change process variable in the secondary display. | |
| |  | Refer to Page 4-3 for an overview of the process variables that can be displayed. | | |

Measurement recorder

With the integrated measurement recorder (Option 448), the Transmitter 7220X provides you with a two-channel “on-site recorder”. For process visualization or, for example, for controller optimizing, the measurement recorder continuously registers two user-defined process variables and simultaneously displays them graphically next to each other in the system display. Process variable, measurement range, recording method and time feed (scanning interval) parameters can be set within broad limits (see Pg 4-27). The last 500 measured values are stored with time and date in the recorder memory of your Transmitter. You can also display them numerically (see Pg 6-4).



This option (Measurement recorder) can be retrofitted via TAN (see Pg 4-30).

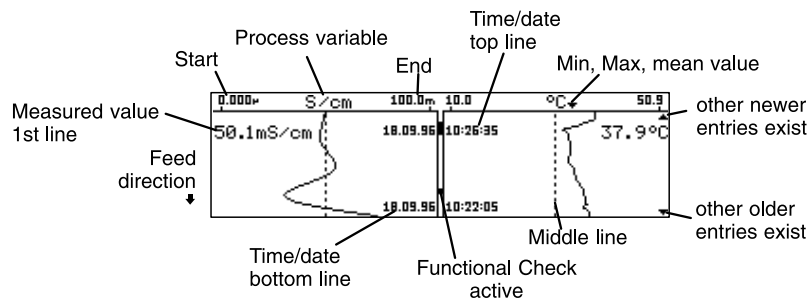

Keypad assignment for measurement recorder

- meas** switches to measurement display
- cal** **par** **maint** **diag** activate Calibration, Parameter Setting, Maintenance or Diagnostics.
- enter** jumps to current entry.
- scroll to next or previous page.
- scroll to next or previous line.
- + **enter** jumps to current entry.
- + **enter** jumps to oldest entry.

Menu structure

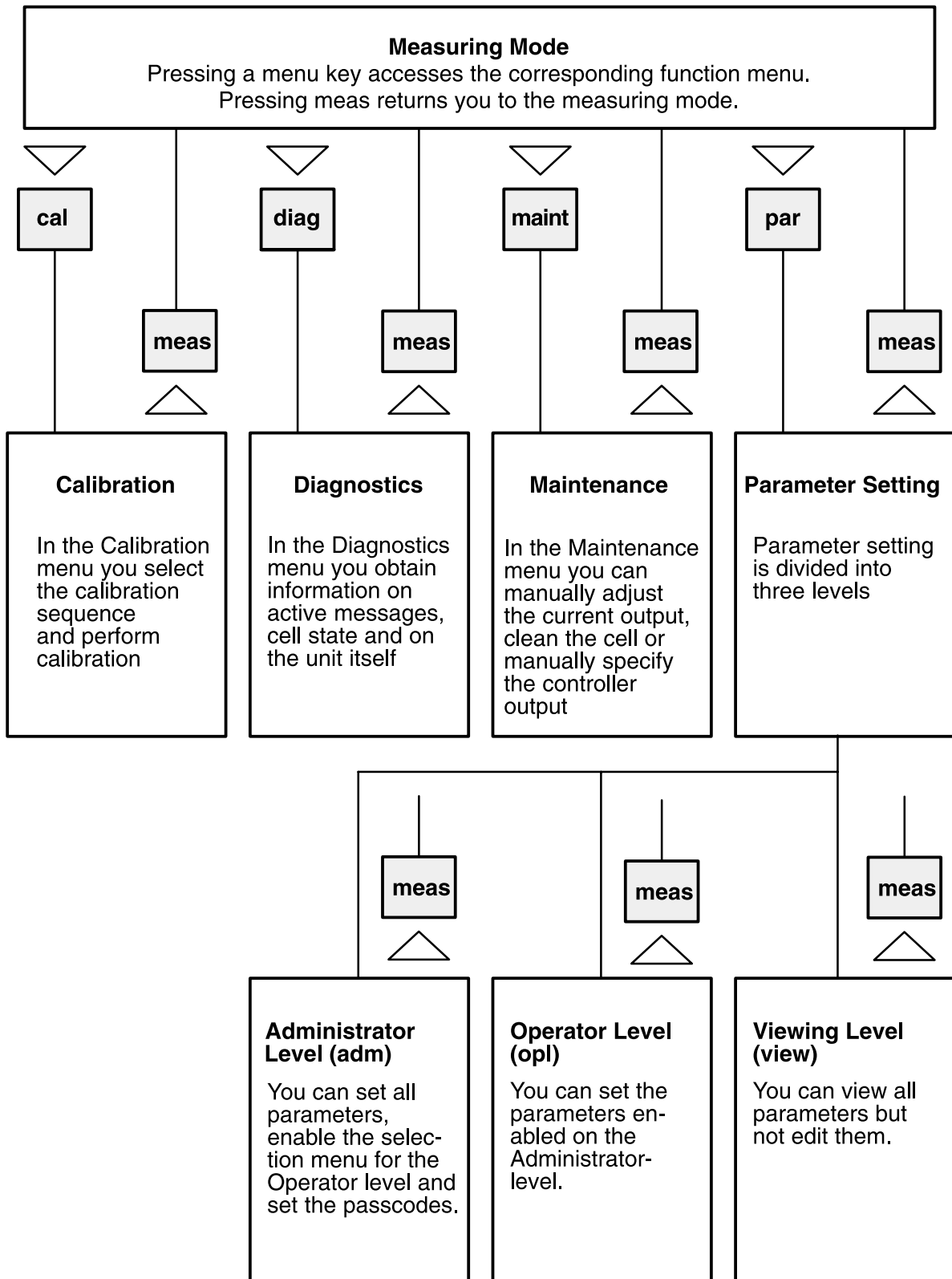
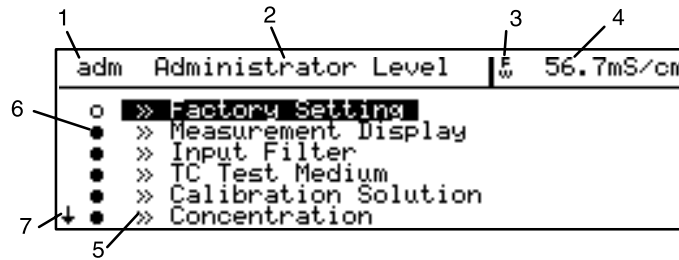

Fig. 3-2 Menu structure

Menu operation

When Calibration, Maintenance, Parameter Setting or Diagnostics are active, the display shows the respective menu for operating the functions.

Operator guidance is supported by a 7-line plaintext display with information texts. During operation, the measured value display (4) and the active status messages (3) remain visible.



The menu display consists of the following elements:

- 1 The abbreviation shows you which menu you are in:

| | |
|-------|--|
| cal | Calibration menu |
| maint | Maintenance menu |
| view | Parameter Setting, Viewing level |
| opl | Parameter Setting, Operator level |
| adm | Parameter setting, Administrator level |
| diag | Diagnostics menu |
| par | Parameter setting, language selection |
- 2 The menu heading indicates the current menu level.
- 3 The status display shows active warning (W) and/or failure messages (F).
- 4 The measured value is also visible in the menus.
- 5 The » symbol indicates that this menu item contains a submenu.
- 6 The marker setting is only visible in the Parameter Setting menu. At the Administrator level you can block individual menu items for the Operator level (see Pg 4-2).
- 7 In longer menus it is not possible to display all lines at the same time. The ↑ and ↓ symbols indicate that there are further menu lines.

Keypad assignment for menu operation:

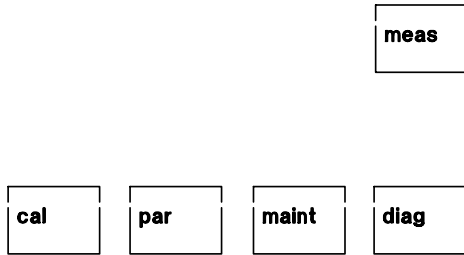

exits the menu system and returns to measuring mode. In the Calibration or Maintenance menus you are prompted to confirm that your equipment is ready for measurement.

Cancel: To cancel an entry (without storing) or to exit a submenu, you can use the corresponding menu key.

That means: Parameter Setting can be canceled by pressing **par** , Diagnostics by pressing **diag** , etc.



How to select a menu item:

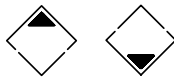

Select the desired menu item using the scrolling keys. The selected line is marked by a dark bar (reverse video).

The scrolling keys provide a repeat function: When a key is held down, the lines are scrolled through.



Pressing ► or **enter** accesses the next (lower) menu level.

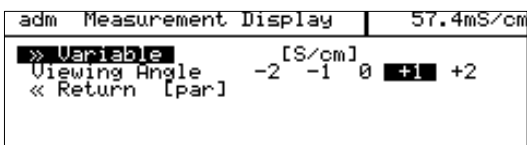

How to change a setting:

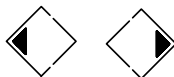

Pressing a cursor key changes the setting. The selected position is shown in reverse video.

The entry position flashes, as it has been modified but not yet stored.



Pressing **enter** stores the new setting. Flashing stops.

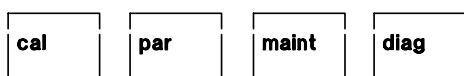

Pressing the menu key (e.g. **par**) instead of **enter** restores the old setting.

| | |
|--------------------|-------------|
| adm Alarm 0 [S/cm] | 57.4mS/cm |
| » Alarm 0 | [S/cm] |
| Alarm 0 [S/cm] | On Off |
| Failure Limit Lo | 10.00 mS/cm |
| Warning Limit Lo | 15.00 mS/cm |
| Warning Limit Hi | 85.00 mS/cm |
| Failure Limit Hi | 90.00 mS/cm |

How to change numerical values:

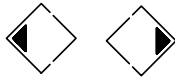

Moves the cursor within the entry area. With these keys, you select the entry position.

When the entry value has a sign, it can be selected by pressing ◀.

If you edit a numerical value with an entry area covering several decades (e.g. conductivity), the ⇆ symbol appears in front of the numerical value.

Now you can displace the decimal point using the cursor keys.

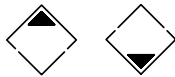

Pressing a scrolling key scrolls the numbers from 0 through 9 or changes the sign.



Pressing **enter** stores the edited setting.



Pressing the menu key (e.g. **par**) instead of **enter** restores the old setting.

| | |
|--------------------|-------------|
| adm Alarm 0 [S/cm] | 57.4mS/cm |
| » Alarm 0 | ⇆ S/cm Off |
| Alarm 0 [S/cm] | ⇆ S/cm Off |
| Failure Limit Lo | 10.00 mS/cm |
| Warning Limit Lo | 15.00 mS/cm |
| Warning Limit Hi | 85.00 mS/cm |
| Failure Limit Hi | 90.00 mS/cm |

How to select parameters in a pull-down menu:



Pressing ▶ or **enter** accesses pull-down selection. An inverted menu is displayed.

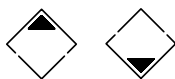

Select the desired menu line using the scrolling keys. The selected line is highlighted.

The entry line flashes, as it has been modified but not yet stored.



Pressing **enter** stores the new setting. Flashing stops.



Pressing the menu key (e.g. **par**) instead of **enter** restores the old setting.

4 Parameter setting



Commissioning of the Transmitter 7220X may only be carried out by trained experts in accordance with this instruction manual.

All parameters must be set by a system administrator prior to commissioning.

Language selection

When you access the Parameter Setting level, you can select the language for the displays and menu texts. German, English, French, Italian, and Spanish are available.

(Optionally Swedish instead of Spanish)

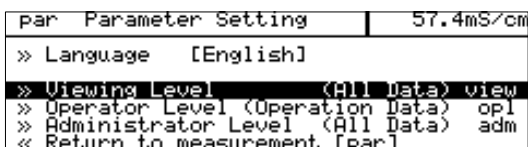

The three levels of parameter setting

The Parameter Setting menu is divided into the Viewing, Operator, and Administrator levels according to the user's degree of specialization.

- At the Viewing level the settings can be displayed but not edited.
- At the Operator level only the marked menu items can be edited.
- At the Administrator level all parameter setting functions can be accessed. In addition, markers can be set for each menu item to create an optimal user menu for the Operator level. Passcodes protect the Operator and Administrator level against unauthorized access. The passcode protection for the Operator level can be switched off if required.

The levels are identified by abbreviations in the upper left corner of the display.

view – Viewing level
opl – Operator level
adm – Administrator level

Access to the Operator level can be protected with a passcode if necessary. Access to the Administrator level is always protected with a passcode.

Viewing level

At the Viewing level you can have a look at all settings of the unit.

The settings cannot be edited!

Operator level

At the Operator level you can only edit those parameters (menu items) which have been enabled at the Administrator level.

Whether a menu item has been enabled is indicated by the dot preceding the corresponding menu line.

- This menu item can be edited.
- This menu item is locked: It cannot be edited. The menu item is skipped during scrolling. However, it can be accessed at the Viewing level.

Access to the Operator level can be protected with a passcode if necessary.

Administrator level

At the Administrator level you can edit all unit settings including the passcodes. In addition, the marker function allows you to lock individual menu items to prevent access from the Operator level.

As delivered, all menu items are enabled.

Access to the Administrator level is always protected with a passcode.

Marker setting

An information text explains the marker setting at the Administrator level.

By setting markers you can enable or lock individual menu items at the highest level of the Parameter Setting menu (except "Passcode Protection") for the Operator level:

- This menu item has been enabled: It can be edited at the Operator level.
- This menu item is locked: It cannot be edited at the Operator level. However, it can be accessed at the Viewing level.

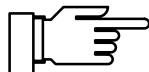

```
adm Administrator Level | 56.7mS/cm
o » Factory Setting
● » Measurement Display
● » Input Filter
● » IC Test Medium
● » Calibration Solution
↓ ● » Concentration
```

How to set a marker

Press ◀ to select the marker.

Press ▼ or ▲ to enable (●) or lock (○) the menu item.

Confirm the setting with **enter**.

```
adm Factory Setting | 57.5mS/cm
● The factory setting erases
! all your set parameters!
» Parameter Set [7220X]
Set factory settings Yes No
« Return [par]
```

Factory setting

At the Administrator level, you can reset all settings to the initial factory setting.



Before the Transmitter 7220X is started again, a complete parameter setting procedure must be performed by a system administrator.

```
54.5 mS/cm
+Pt 26.1°C OUTPUT 12.72mA
```

Measurement display

During parameter setting you can define which measured value is to appear in the large display in measuring mode. The following process variables can be displayed:

- Conductivity value
- Resistivity
- Concentration (Options 359, 360, 502 only)
- Measured temperature (°C)
- Time

```
adm Measurement Display | 56.7mS/cm
» Variable =====>
Viewing Angle - S/cm +1 +2
« Return [par] S/cm
                °C
                Time
```

The following variables can be shown in the secondary displays:

- MAN Manual measuring temperature (°C)
- OUTP1 Output current 1
- OUTP2 Output current 2 (with Option 487 only)
- Xw Controller setpoint (with Option 353 and active controller only)
- CTL-Y Controller output (with Option 353 and active controller only)
- DATE Date

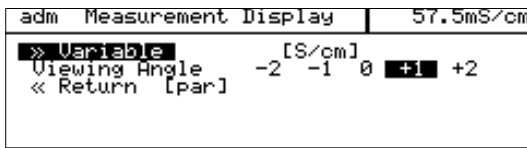
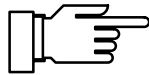

See Pg 3-2 for how to select the process variables for the secondary displays.

The “Viewing Angle” menu item allows you to adjust the viewing angle of the display.

When the Transmitter is mounted at a very high or a very low position, you can adjust the viewing angle for optimum display readability.

Select the desired viewing angle using ◀ and ▶ (+ means viewing angle upwards and – means viewing angle downwards) and confirm your choice by pressing **enter**.

You see the change immediately in the display.

Input filter

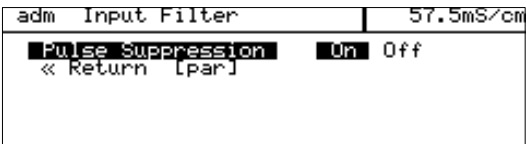

To increase the immunity to interference during measurement, an input filter can be switched on. When the filter is switched on, momentary interference pulses will be suppressed, slow changes in the measured value will be detected.



If fast measured-value changes are to be detected, you must switch off the input filter.

Temperature compensation of the process medium

The conductivity of the process solution is temperature-dependent. By setting a temperature coefficient for the process solution and a reference temperature, all conductivity values can be converted to the reference temperature.

The dependency of the conductivity on the temperature is more or less nonlinear.

Therefore, select a reference temperature near the process temperature. There, the linearly compensated measured value deviates least from the “true” conductivity.

When the TC correction for process medium is switched on, “TC” appears in the display in measuring mode.

In the Parameter Setting menu, you can select the type of temperature compensation:

- Off
No temperature compensation

- Linear
Linear temperature compensation with entry of temperature coefficient and reference temperature.
The unit converts the conductivity of the process solution to the reference temperature.
- EN 27888
Temperature compensation for natural waters to EN 27888. Compensation is effective in the range 0 to 35 °C. Reference temperature is 25 °C.
- Ultrapure water
With Option 392 also: temperature compensation for ultrapure water with traces of impurity (boiler feed water etc.) down to ultrapure H₂O with 0.055 µS/cm (25 °C). Compensation is effective in the range 0 to 158 °C.
Reference temperature is 25 °C.

How to set the temperature compensation parameters.

Open a Parameter Setting menu and select “TC Test Medium” using ▼. Select “Temp Comp Off”, “Linear”, or “EN 27888” (with Option 392 also “Ultrapure”).

When “Temp Comp Linear” has been selected, you can enter the temperature coefficient of the solution and the reference temperature.

When “Temp Comp Ultrapure” has been selected (with Option 392 only), you can select the type of impurity.

- Alkaline ultrapure water (NaOH)
- Neutral ultrapure water (NaCl), for conductivity measurement in water processing behind gravel bed filter.
- Acidic ultrapure water (HCl), for conductivity measurement **behind** cation filter
- Ammoniacal ultrapure water (NH₃)

If one of the above mentioned types of TC correction has been set, the menu line “Sample Cal” is added. Here, you can select whether sample calibration is to be performed with or without TC correction (see Pg 5-8).

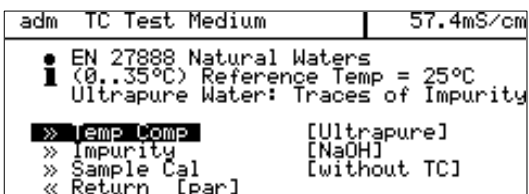
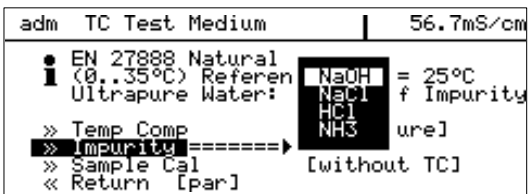
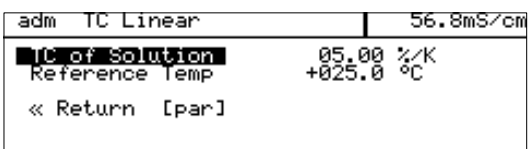
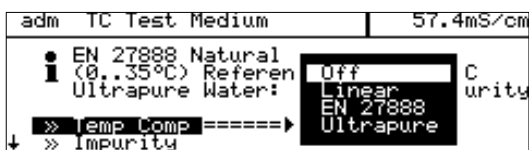



Calibration solution

For automatic sensor calibration, you must specify the calibration solution used.

Select your calibration solution from the pull-down menu.

(For tables, see Pg 12-1 and the following.)

Concentration



You can only make use of the concentration determination function if your unit is equipped with Option 359, 360, or 502.

The Transmitter 7220X determines the substance concentration from the measured conductivity and temperature values in percent by weight (% by wt) for H₂SO₄, HNO₃, HCl, NaOH, or NaCl (with Option 360: customer-specific substance mixtures, with Option 502: user-defined concentration table).

Conditions for concentration determination

The following conditions (among others) are required for reliable concentration determination:

- For calculation of concentration, the medium to be measured must be a purely binary mixture (e.g. water–hydrochloric acid). Presence of other dissolved substances (e.g. salts) leads to incorrect concentration values.
- In the region of small slopes (e.g. at the range limits) small conductivity changes can correspond to great concentration changes. This may lead to an unsteady display of the concentration value.
- As the concentration value is calculated from the measured conductivity and temperature values, accurate temperature measurement is very important. Therefore, you should make sure that sensor and process medium are in thermal equilibrium.

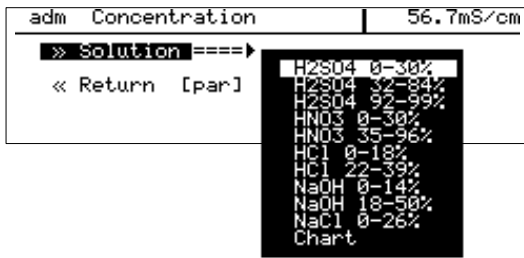

Concentration determination of preset substances

Page 10-4 shows a table with the concentration ranges of the preset substances.

On Page 11-2 and the following the conductivity curves are provided for the five substances in dependency on the substance concentration and the process temperature.

Concentration determination via user-defined chart (Option 502)

The chart is built up as 5 x 5 matrix. Temperatures, concentrations and the corresponding conductivity values can be defined as desired.

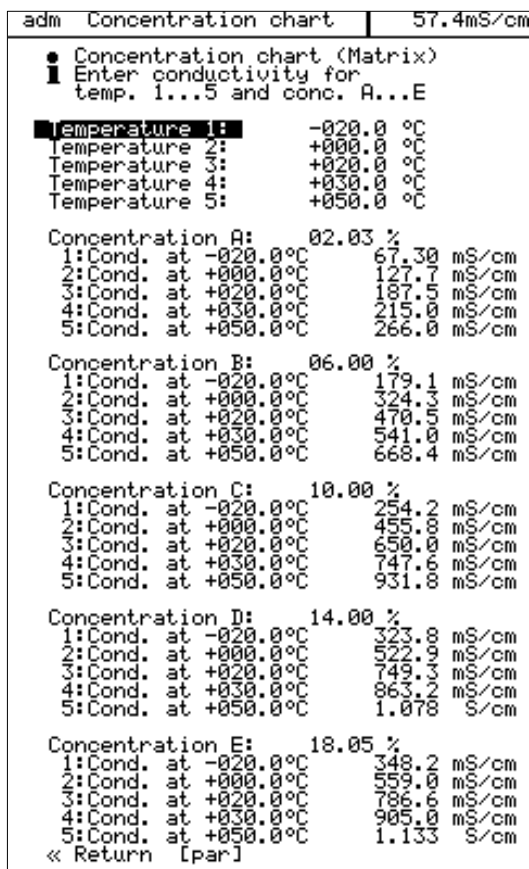

| | Conc. A | Conc. B | Conc. C | Conc. D | Conc. E |
|--------|---------|---------|---------|---------|---------|
| Temp 1 | A1 | B1 | C1 | D1 | E1 |
| Temp 2 | A2 | B2 | C2 | D2 | E2 |
| Temp 3 | A3 | B3 | C3 | D3 | E3 |
| Temp 4 | A4 | B4 | C4 | D4 | E4 |
| Temp 5 | A5 | B5 | C5 | D5 | E5 |

Conditions for the chart:

- The temperatures “Temp. 1” - “Temp. 5” must be rising, i.e. “Temp. 1” is the lowest and “Temp. 5” the highest temperature.
- The concentrations “Conc. A” - “Conc. E” must be rising, i.e. “Conc. A” is the lowest and “Conc. E” the highest concentration.
- The chart values for the conductivity “A1” - “E1”, “A2” - “E2”, etc. must all be rising within the chart or all falling. Points of inflection are not allowed!

The Transmitter automatically checks the chart values. Erroneous entries are reported in the information text and are marked at the chart margin.

To increase the accuracy of concentration determination, it is particularly advisable to adjust the temperature probe (see Pg 7-2).



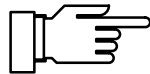

Concentration determination not in use:

The range limits (0 - 100 %) for concentration determination will only be monitored by the Transmitter 7220X if the concentration alarm is switched on.

If the concentration determination is not used on units with Option 359, 360, or 502, the concentration alarm should be switched off, as otherwise the error message "Fail Concentration" would be produced at certain conductivities (e.g. > 800 mS/cm).

Sensor selection

In this menu, you select the sensor type and set all parameters of the sensor and temperature probe, if required.

Sensor type

When you select an InPro[®] sensor, the temperature probe and nominal cell constant are automatically preset. When you select another 2- or 4-electrode sensor, you must specify the respective cell constant and which temperature probe you use.

When changing the sensor type, the value of the nominal cell constant is taken over as default setting for the cell constant. The new cell constant is entered as Data Entry in the cal record. The data for the setting "Other 2-electr." or "Other 4-electr." is retained when the sensor type is changed once more.

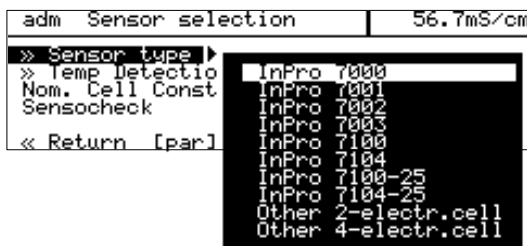

Temperature detection

In the "Temp Detection" submenu, you select the temperature probe used, choose between automatic and manual temperature detection, and enter the manual measuring and calibration temperatures, if required.

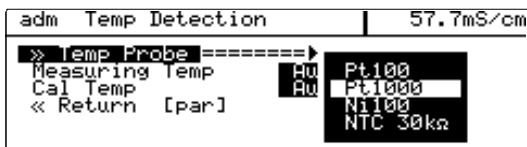

Temperature probe

When “Other 2-electr.” or “Other 4-electr.” has been set in the Sensor Selection menu, you can select the temperature probe from this pull-down menu. You can choose from: Pt 100 / Pt 1000 / Ni 100 / NTC 30 kΩ.

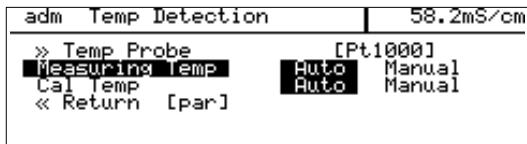

Automatic temperature compensation

With automatic temperature selection the Transmitter 7220X measures the process temperature using the selected temperature probe.



If you work with automatic temperature compensation, a temperature probe connected to the temperature input of the Transmitter 7220X must be in the process medium!

If no temperature probe is connected to the Transmitter 7220X, the measuring temperature must be entered manually.

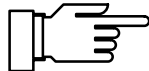

Manual temperature compensation

Manual temperature compensation only makes sense if the process is running at a constant temperature!

If “Measuring Temp Manual” is selected, this is indicated by “MAN.TEMP” in the lower right corner of the display. The “MAN.TEMP” message does not appear if the measuring temperature is shown on the measurement display. You can show the manually defined temperature on the secondary display (see Pg 3-2).

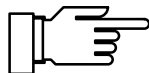

When “Measuring Temp Manual” is set, the automatic temperature measurement continues to run and the display, limits, and alarm messages are controlled by the measured value.

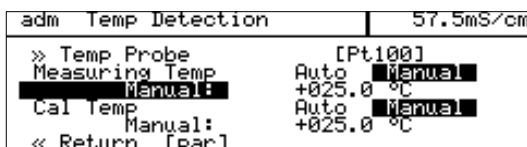

Enter the process temperature:

Measure the temperature of the process medium, e.g. with a glass thermometer, or make sure that the process medium is at a constant temperature, e.g. with a thermostat. Enter the measured temperature and confirm.



Manual compensation of the calibration temperature should be selected if the temperature probe remains in the process during calibration.

Sensocheck®

Here, you switch sensor monitoring for the conductivity sensor on or off.

If the measured value is significantly out of range, Sensocheck® delivers the “Warn Sensocheck” message. Especially when using 2-electrode sensors, the message is generated when decisive measurement errors (10 - 30 %) occur due to polarization or contamination.

At the same time, Sensocheck® monitors the cable influence. The warning signal is generated, for example, when unsuitable cables or cables which are too long for the measurement range have been laid.

As delivered, Sensocheck® is switched off.



Output 1

| | | |
|-------------------|------------------|-----------|
| adm | Output Current 1 | 57.4mS/cm |
| » Variable =====> | | |
| » Curve | | |
| Output | 0...20m | S/cm 0mA |
| Value at 00mA: | 0 | cm |
| Value at 01mA: | 1 | °C |
| Value at 02mA: | 2 | cm |

- Output 1 is galvanically isolated and operates as a current sink for the 4 to 20 mA loop current (supply unit required).

It supplies the unit with power from the loop current and analogously transmits the configured process variable.

The output current can be shown in a secondary display (see Pg 3-2).

The output current can be assigned to one of the following process variables:

- Conductivity value
- Resistivity
- Concentration (Options 359, 360, 502)
- Measured temperature (°C)

The output current is frozen at its last value:

- during calibration
- in the current source function (manual entry)
- in the “**maint** Meas. Point Maint.” menu
- during a wash cycle

| | | |
|------------------|--------------|-----------|
| adm | 22mA Message | 57.5mS/cm |
| Failure | On | Off |
| Warning | On | Off |
| Functional Check | On | Off |
| « Return [par] | | |

Current output 1 can be defined for output of the NAMUR signals Failure, Warning and Functional check (22 mA message). The output current is then set to 22 mA in the case of a message (also see Alarm processing on Pg 4-24).



During Multidrop mode of the HART[®] interface output current 1 is permanently set to 4 mA. In Multidrop mode the unit momentarily draws a current of approx. 22 mA when switched on.

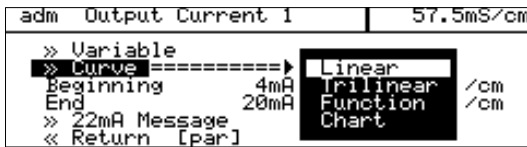

Output curves of the current output

There are four output curves to choose from for the current output:

- Linear
- Trilinear (bilinear)
- Function
- Chart (Option 449)

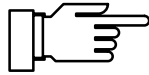

If the initial value is lower than the end value, a rising output curve will result. To define a falling output curve, set the lower value as the end value and the higher value as the initial value of the process variable.

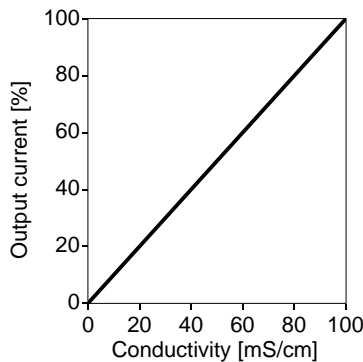
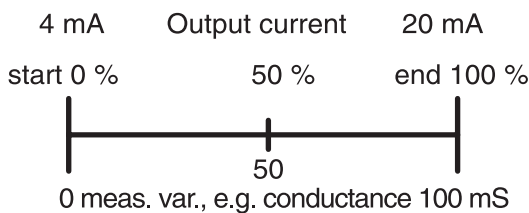

Linear output curve

To determine the span corresponding to the current range 4 – 20 mA, set an initial and an end value for the process variable.

For permissible spans, refer to the Specifications, Chapter 10.

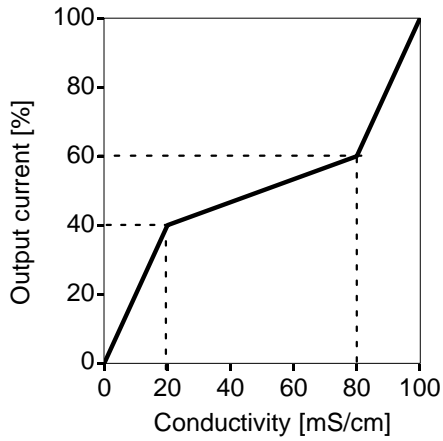

Trilinear output curve

To determine the span corresponding to the current range 4 – 20 mA, set an initial and an end value for the process variable.

In addition, you can define two corner points. They divide the output curve into three regions of different slopes.

Example:

| | |
|---------------|-----------|
| Beginning: | 0 mS/cm |
| 1st corner X: | 20 mS/cm |
| 1st corner Y: | 40 % |
| 2nd corner X: | 80 mS/cm |
| 2nd corner Y: | 60 % |
| End: | 100 mS/cm |

Bilinear output curve

To define a bilinear output curve, set the same X and Y values for the two corner points of a trilinear curve.

To determine the span corresponding to the current range 4 – 20 mA, set an initial and an end value for the process variable.

In addition, you can define a corner point. It divides the output curve into two regions of different slopes.

Example:

| | |
|---------------|-----------|
| Beginning: | 0 mS/cm |
| 1st corner X: | 20 mS/cm |
| 1st Corner Y: | 40 % |
| 2nd corner X: | 20 mS/cm |
| 2nd corner Y: | 40 % |
| End: | 100 mS/cm |

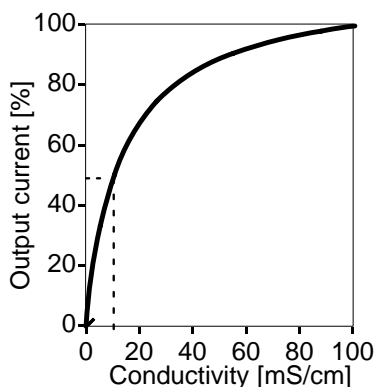
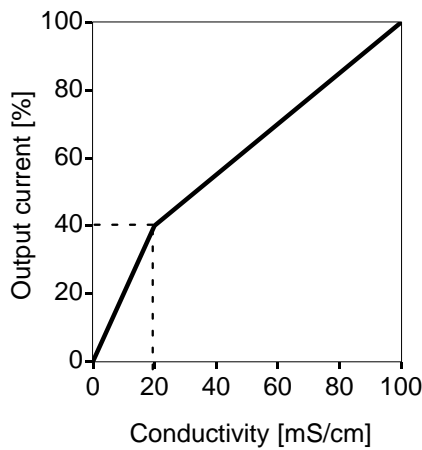

Output curve “function”

Particularly when measuring low conductivities, it is useful to measure over several decades while at the same time maintaining a high resolution for the low values.

With the output curve “function”, a nonlinear output current characteristic can be implemented. By defining a 50% point, you can spread the beginning and compress the end of the range as required.

This allows you to create a good approximation of a logarithmic output curve.

To determine the span corresponding to the current range 4 – 20 mA, set an initial and an end value for the process variable. In addition, you can define a 50% point (at 10 or 12 mA, resp.).

Between the initial and end value, the output current is calculated from the following equations:

$$\text{Output current (4 to 20 mA)} = \frac{(1 + K) x}{1 + K x} 16 \text{ mA} + 4 \text{ mA}$$

$$K = \frac{E + I - 2 \times 50\%}{50\% - I} \quad x = \frac{M - I}{E - I}$$

| | | |
|-------|------------------|------------|
| I: | Initial value at | 4 mA |
| X50%: | 50% value at | 10 (12) mA |
| E: | End value at | 20 mA |
| M: | Measured value | |

**Example:
logarithmic output curve over one decade**

Approximation of a logarithmic output curve in the range 10 to 100 µS/cm (one decade):

| | |
|-------------|-------------|
| Beginning: | 10.0 µS/cm |
| 50 % point: | 31.6 µS/cm |
| End: | 100.0 µS/cm |

**Example:
logarithmic output curve over two decades**

Approximation of a logarithmic output curve in the range 1 to 100 µS/cm (two decades):

| | |
|-------------|-------------|
| Beginning: | 1.00 µS/cm |
| 50 % point: | 10.0 µS/cm |
| End: | 100.0 µS/cm |

| adm | Output Current 1 | 57.5mS/cm |
|-----|------------------|-------------|
| >> | Variable | [S/cm] |
| >> | Curve | [Chart] |
| >> | 22mA Message | |
| | Value at 04mA: | 40.00 mS/cm |
| | Value at 05mA: | 500.0 mS/cm |
| | Value at 06mA: | 600.0 mS/cm |
| | Value at 07mA: | 700.0 mS/cm |
| | Value at 08mA: | 800.0 mS/cm |
| | Value at 09mA: | 900.0 mS/cm |
| | Value at 10mA: | 1.000 S/cm |
| | Value at 11mA: | 1.100 S/cm |
| | Value at 12mA: | 1.200 S/cm |
| | Value at 13mA: | 1.300 S/cm |
| | Value at 14mA: | 1.400 S/cm |
| | Value at 15mA: | 1.500 S/cm |
| | Value at 16mA: | 1.600 S/cm |
| | Value at 17mA: | 1.700 S/cm |
| | Value at 18mA: | 1.800 S/cm |
| | Value at 19mA: | 1.900 S/cm |
| | Value at 20mA: | 2.000 S/cm |
| << | Return LparJ | |

**Output curve via user-defined chart
(Option 449)**

If your Transmitter 7220X is equipped with Option 449, you can enter the parameters of the current output curve in this chart in 1 mA steps. The slope of the entered curve must be either positive (rising) or negative (falling) throughout its whole length. The Transmitter 7220X checks whether there are points of inflection in the curve.

Error messages for output settings

The output current is linearly output (determined only by initial and end value). The alarm message “Warn Current Para” is generated if the settings fulfil one of the following conditions:

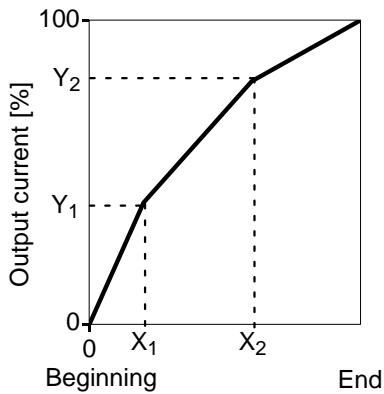

Trilinear (bilinear) curve
(rising, beginning < end):

- 1st corner $X \leq \text{beginning}$
- 2nd corner $X \geq \text{end}$
- 1st corner $X > 2\text{nd corner } X$
- 1st corner $Y \leq 0 \%$
- 2nd corner $Y \geq 100 \%$
- 1st corner $Y > 2\text{nd corner } Y$

Bilinear curve (rising, beginning < end):

- 1st corner $X = 2\text{nd corner } X$ and
1st corner $Y \neq 2\text{nd corner } Y$

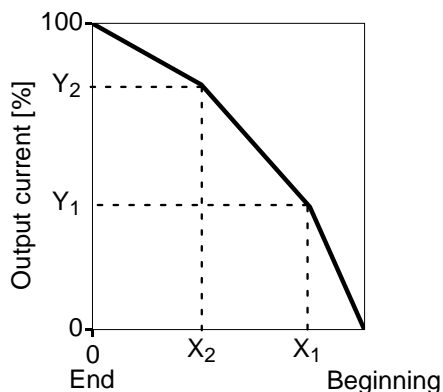

Trilinear (bilinear) curve
(falling, beginning > end):

(Beginning is always at 0 %
End is always at 100 %
1st corner X is always at beginning
2nd corner X is always at end)

- 1st corner $X \geq \text{beginning}$
- 2nd corner $X \leq \text{end}$
- 1st corner $X < 2\text{nd corner } X$
- 1st corner $Y \leq 0 \%$
- 2nd corner $Y \geq 100 \%$
- 1st corner $Y < 2\text{nd corner } Y$

Bilinear curve (falling, beginning > end):

- 1st corner $X = 2\text{nd corner } X$ and
1st corner $Y \neq 2\text{nd corner } Y$

Curve “function” (rising, beginning < end):

- 50% point $\leq \text{beginning}$
- 50% point $\geq \text{end}$

Curve “function” (falling, beginning > end):

- 50% point $\geq \text{beginning}$
- 50% point $\leq \text{end}$

Output 2

```
adm Output 2 | 56.5mS/cm
>> Usage =====>
>> Wash contact
<< Return [par]
  Current
  Limit
  Alarm Contact
  Controller
  Wash contact
```

If your unit is equipped with Option 487, you can use an additional output. The galvanically isolated output 2 also functions as a 0 (4) – 20 mA current sink (supply unit required). It serves to transmit an additional definable process variable or can be used as a switching output for limits or alarms or as wash contact. If your unit is also equipped with Option 353 (Controller function), you can use the output as a controller output.

Set as a current output

```
adm Current Output 2 | 56.7mS/cm
>> Variable =====>
>> Curve
Output 0...20mA
Beginning 0(4)mA
End 20mA
>> 22mA Message
  S/cm
  %
  °C
  0mA
  00 µS/cm
  00 S/cm
```

If output 2 is set as a current output, one of the following process variables can be output:

- Conductivity
- Resistivity
- Concentration (Options 359, 360, 502)
- Measured temperature

```
adm Current Output 2 | 57.5mS/cm
>> Variable
>> Curve =====>
Output 0...20mA
Beginning 0(4)mA
End 20mA
>> 22mA Message
  Linear
  Trilinear
  Function /cm
  /cm
```

You can define the curve as linear, trilinear, or as a function (also see Pg 4-11 and the following).

```
adm Current Output 2 | 57.5mS/cm
>> Variable [S/cm]
>> Curve [Linear]
Output 0...20mA 4...20mA
Beginning 0(4)mA 0.000 µS/cm
End 20mA 2.000 S/cm
>> 22mA Message
```

Besides the process variable and curve, you can set the output current (0 – 20 mA or 4 – 20 mA), and the beginning and end of scale.

```
adm 22mA Message | 57.4mS/cm
Failure On Off
Warning On Off
Functional Check On Off
<< Return [par]
```

Current output 2 can be defined for output of the NAMUR signals Failure, Warning, and Functional check (22 mA message). The output current is then set to 22 mA in the case of a message. (Also see Alarm processing on Pg 4-24)



Output 2 is passive. It must be supplied by an additional power supply (e.g. WG 21 isolated supply).

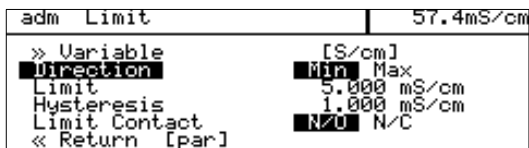
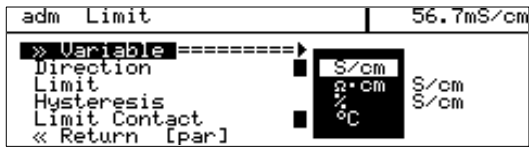

Limits and Hysteresis

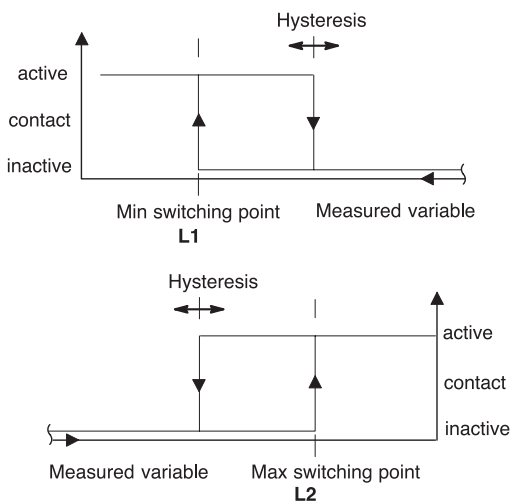

Set as a limit contact

If output 2 is set as a limit contact, it can be controlled by the following process variables:

- Conductivity
- Resistivity
- Concentration (Options 359, 360, 502)
- Measured temperature

You can define the contact as follows:

- The variable controls the limit contact.
- The effective direction specifies whether the contact will be activated when the measured value falls below (Min) or exceeds (Max) the limit value.
- The limit defines the switching threshold.
- The hysteresis specifies how far the measured value must fall below (Max) or exceed (Min) the limit value before the contact switches back.
- N/O or N/C contact defines whether the active contact is closed (N/O) or open (N/C).

When the measured value falls below or exceeds the set limit, "Limit" appears in the display. Output 2 is active.

During calibration the limit contact is inactive! During sample calibration the "Limit" display is covered up by "Sample"!

| adm Alarm Contact | | 57.4mS/cm |
|-------------------|-----|-----------|
| Failure | On | Off |
| Warning | On | Off |
| Functional Check | On | Off |
| Alarm Contact | N/O | N/C |
| « Return [par] | | |

Set as an alarm contact

The alarm contact is used to output the NAMUR signals Failure, Warning, and Functional check. These are triggered by alarm processing. You can choose between a normally-open and a normally-closed contact.

(Also see Alarm processing on Pg 4-24)

Set as a controller

You can only make use of the controller function if your unit is equipped with Option 353.

You can choose from pulsed digital controllers and analog PI controllers. The controllers can only operate unilaterally because only output 2 is available for outputting the manipulated variable. Therefore, you must select the range in which the controller is to operate:

- Range below setpoint: 0 ... +100 %
- Range above setpoint: 0 ... -100 %

The controller only operates bilaterally when actuating a 3-way mixing valve.

For a pure P controller (reset time = 0), you only need to define the control range used. For the range not used, however, it is necessary to enter reasonable parameters as otherwise the error message "Warn Control Para" will be output.

When using the controller as a PI controller (reset time ≠ 0), it is absolutely necessary to define the unused range. The manipulated variable (controller output) is influenced by both control ranges due to the integration time.

| adm Controller | | 57.4mS/cm |
|----------------|-----------|----------------------|
| i | Output 2: | Pulse Length Control |
| | | Pulse Freq Control |
| » Type =====> | | 3-Way Mixing Valve |
| » Control Va | | Straightway Valve |
| Setpoint Xw | | |

The following four controller types are available:

- Pulse length controller (digital)
- Pulse frequency controller (digital)
- 3-way mixing valve (analog)
- Straightway valve (analog)

| adm Controller | | 57.5mS/cm |
|-----------------------|-----------|-----------|
| i | Output 2: | -100... |
| » Type | [3-Way M | S/cm |
| » Control Variable => | | lve] |
| Setpoint Xw | | S/cm |

The following **controlled variables** can be defined:

- Conductivity
- Resistivity
- Measured temperature (°C)

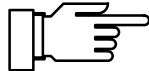



The current value of the controller output (CTL-Y [%]) and the controller setpoint (X_w) can be shown in the secondary display in measuring mode.

With the definable **feed time alarm**, you can monitor the time during which the controller output is at +100 % or -100 %, i.e. how long the valve is fully open.

If this time is exceeded, this may be due to a shortage of feed chemical or a defective valve, for example.

Control characteristic

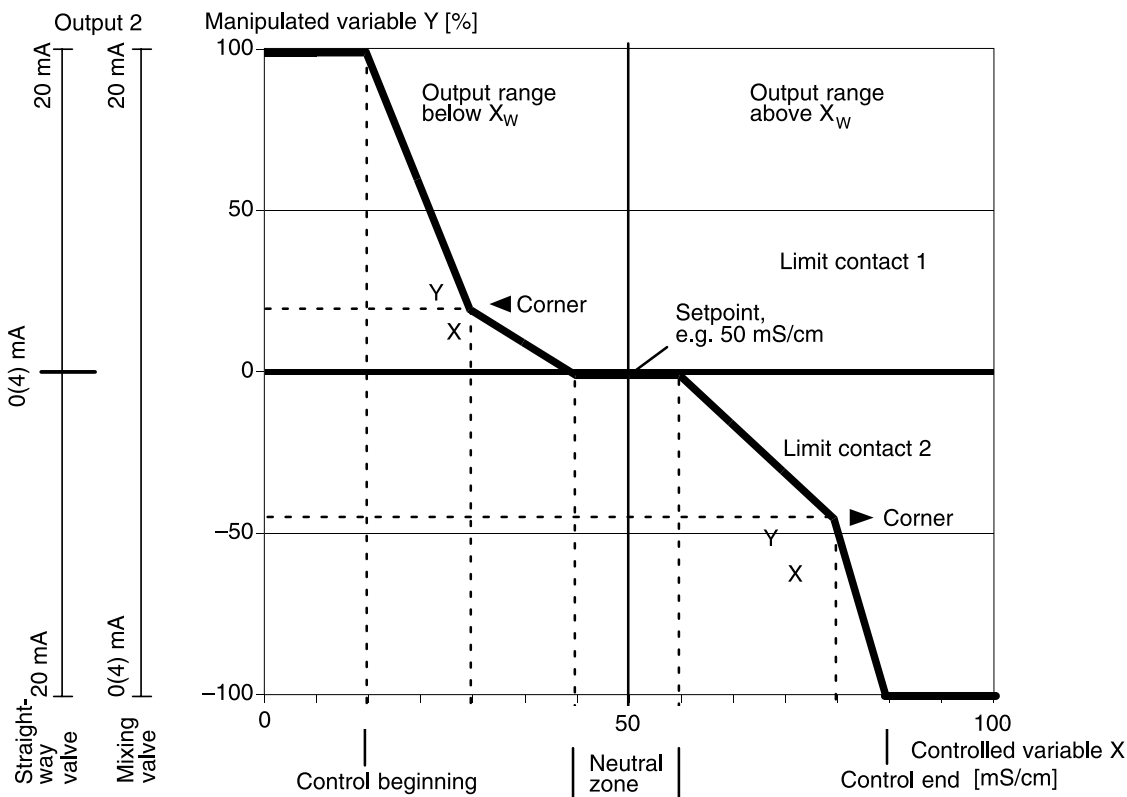

Fig. 4-1 Control characteristic



Fig. 4-1 shows the characteristic of the controller in the Transmitter 7220X. All points of the curve can be defined.

- The control range specifies the range in which the controller is active: above or below the setpoint X_w (not for 3-way mixing valve).
- Values are adjusted toward the setpoint.
- Beginning of control and

- End of control
define the control range.
Outside the control range the controller output remains at +100 % or -100 %.
- In the neutral zone no control takes place.
The neutral zone is symmetrical to the setpoint and its width can be defined.
- With corner X and corner Y you can define a corner point for each control range (◀ : controlled variable < setpoint and ▶ : Controlled variable > setpoint). This allows you to define two different slopes to obtain an optimal control characteristic for strongly nonlinear titration curves, for example.
- The reset time specifies the I-action component of the controller. If you set "Reset Time 0000 s", the I-action component is turned off. The reset time can be defined separately for both control ranges (◀ : controlled variable < setpoint and ▶ : Controlled variable > setpoint).
- With Cal/Maint active, you select whether the controller output is frozen at its last value ($Y = \text{const}$) or whether it goes to 0 % ($Y = 0 \%$) during calibration and maintenance.



For test purposes, you can manually enter the controller output Y in the Maintenance menu (see Pg 7-3).

Controller output (manipulated variable)

The manipulated variable is output via output 2. For the pulse length or pulse frequency controller or for control with an analog straightway valve, you must select the output range:

- Control range below setpoint X_W :
Controller output range 0 to +100 %
corresponds to [0 (4) to 20 mA]
- Control range above setpoint X_W :
Controller output range 0 to -100 %
corresponds to [0 (4) to 20 mA]

With the 3-way mixing valve, output 2 operates over the entire control range:

- $Y = -100$ to +100 %
corresponds to [0 (4) to 20 mA]

When set as a digital controller, output 2 is used as a contact. It can be used, for example, to control

valves or metering pumps.

Contact ON time or switching frequency vary in accordance with the controller output.

When set as an analog controller, output 2 is used as a current output, either 0 to 20 mA or 4 to 20 mA. The valve type determines the behavior of the output current. You can choose between a 3-way mixing valve or a straightway valve.

The current controller output and the setpoint can be shown in the secondary display (see Pg 3-2).

Pulse length controller

The pulse length controller is used to operate a valve as an actuator.

It switches the contact on for a time that depends on the controller output.

The period is constant.

A minimum ON time is maintained even if the controller output takes corresponding values. This allows, for example, to take the reaction time of a valve into consideration.

If you set the minimum ON time to 0, the actual minimum ON time will be 0.25 sec for technical reasons.

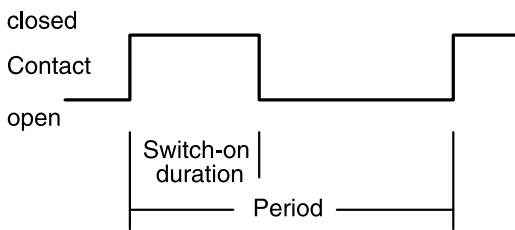

Pulse frequency controller

The pulse frequency controller is used to operate a (frequency-controlled) metering pump as an actuator.

It varies the frequency with which the contacts are switched on.

The maximum pulse frequency [pulses/min] can be defined. It depends on the metering pump used.

The maximum value to be entered is 120 pulses/min.

The Contact ON time is constant.

It is automatically calculated from the user-defined maximum pulse frequency:

$$\text{ON time [s]} = \frac{30}{\text{max. pulse frequency [pulses/min]}}$$

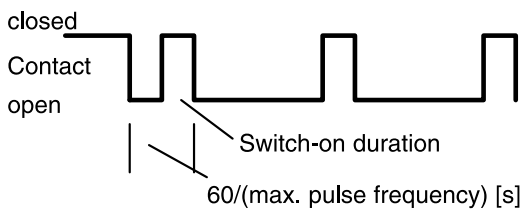

Straightway valve

In the straightway valve mode an analog control valve is actuated with 0 (4) to 20 mA. You define the output range in the Parameter Setting menu.

Output range below setpoint X_W

For the straightway valve, the analog controller output operates in the manipulated variable range 0 to +100 %. Here +100 % correspond to a current of 20 mA. The controller only outputs the manipulated variable below the setpoint. Above the setpoint the manipulated variable cannot be output and the output remains at 0 (4) mA.

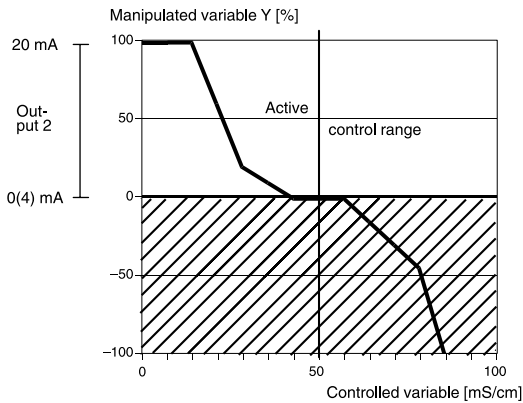

Output range above setpoint X_W

For the straightway valve, the analog controller output operates in the manipulated variable range 0 to -100 %. Here -100 % correspond to a current of 20 mA. The controller only outputs the manipulated variable above the setpoint. Below the setpoint the manipulated variable cannot be output and the output remains at 0 (4) mA.

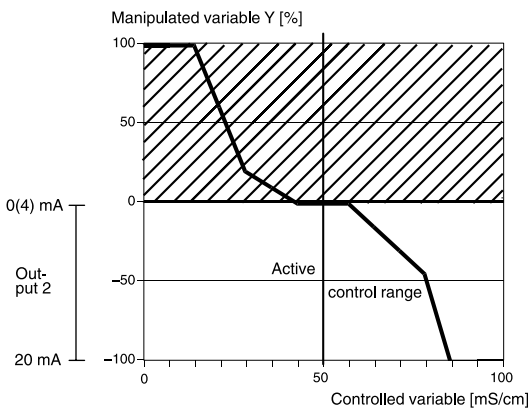

3-way mixing valve

For the 3-way mixing valve, output 2 is used for the entire control range. A controller output $Y = 0$ % then corresponds to a current of 10 or 12 mA, resp.

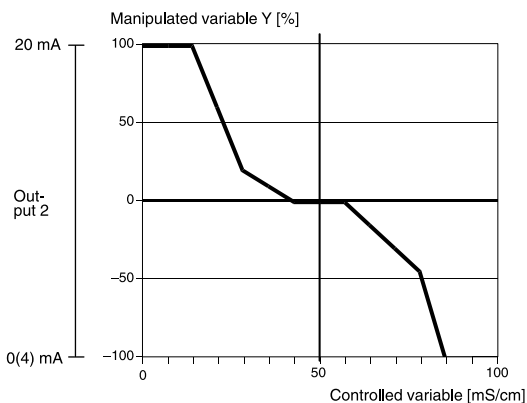

Error messages for controller settings

The controller will be switched off (manipulated variable $Y = 0\%$) and the alarm message "Warn Control Para" will be activated if any of the following conditions applies:

All controller types:

- Beginning \geq setpoint – neutral zone / 2
- ◀ Corner X < beginning
- ◀ Corner X > setpoint – neutral zone / 2
- End \leq setpoint + neutral zone / 2
- ▶ Corner X < setpoint + neutral zone / 2
- ▶ Corner X > end
- ◀ Corner Y > 100 %
- Neutral zone < 0
- ▶ Corner Y > 100 %

Pulse length controller only:

- ▶ Period < min. ON time x 2
- ◀ Period < min. ON time x 2

Pulse frequency controller only:

- Max. pulse frequency ≤ 0 pulses/min
- Max. pulse frequency > 120 pulses/min

With the definable **feed time alarm** (see Pg 4-23), you can monitor the time during which the controller output is at +100 % or -100 %, i.e. how long the valve is fully open. If this time is exceeded, this may be due to a shortage of feed chemical or a defective valve, for example.

Set as a wash contact

If output 2 is set as a wash contact, the conductivity sensor can be automatically cleaned using an appropriate probe.

| | |
|------------------|-----------|
| adm Wash contact | 56.5mS/cm |
| Wash interval | 002.0 h |
| Wash time | 0010 s |
| « Return [par] | |

Wash interval and wash time are freely definable. If either of the two parameters is set to 0, the function is disabled.



During calibration and maintenance a wash interval is not started.



During the wash time the NAMUR Functional Check signal is active, the output currents are frozen at their last values or set to 22 mA.

Alarm settings

```
adm Alarm Settings | 57.4mS/cm
>> Alarm 0 [S/cm] (On) (Off)
>> Alarm 1 [%] (On) (Off)
>> Alarm 2 [°C] (On) (Off)
>> Alarm 3 [CELL] (On) (Off)
>> Alarm 4 [FeedTime] (On) (Off)
>> Alarm 5 [ ]
>> Alarm 6 [ ]
>> Alarm 7 [ ]
>> Alarm 8 [ ]
>> Alarm 9 [ ]
<< Return [par]
```

The Transmitter 7220X allows you to monitor up to 10 different measured values by warning and failure messages. These alarms are numbered from 0 through 9. For each alarm, you can separately define the process variable and the high and low limits for warning and failure messages. In addition, each alarm can be switched on or off. The alarm limits remain stored even when the alarm is switched off.

```
adm Alarm 0 [S/cm] | 56.7mS/cm
>> Alarm 0 =====>
Alarm 0 [S/cm] S/cm
Failure Limit Lo %
Warning Limit Lo °C
Warning Limit Hi CELL
Failure Limit Hi FeedTime
<< Return [par]
```

You can set warning and failure limits for each of the following process variables:

- Conductivity
- Concentration
- Measured temperature
- Cell constant
- Feed time

```
adm Alarm 0 [S/cm] | 57.4mS/cm
↑ Alarm 0 [S/cm] On Off
Failure Limit Lo 10.00 mS/cm
Warning Limit Lo 20.00 mS/cm
Warning Limit Hi 85.00 mS/cm
Failure Limit Hi 90.00 mS/cm
<< Return [par]
```

You can define four independent alarm limits for each of these variables:

- Failure Limit Lo
If the measured value falls below the defined limit, "FAIL" appears in the display.
- Warning Limit Lo
If the measured value falls below the defined limit, "WARN" appears in the display.
- Warning Limit Hi
If the measured value exceeds the defined limit, "WARN" appears in the display.
- Failure Limit Hi
If the measured value exceeds the defined limit, "FAIL" appears in the display.



You can view the currently active alarm messages in the "Message List" of the Diagnostics menu (see Pg 6-1).

Alarm processing / NAMUR signals

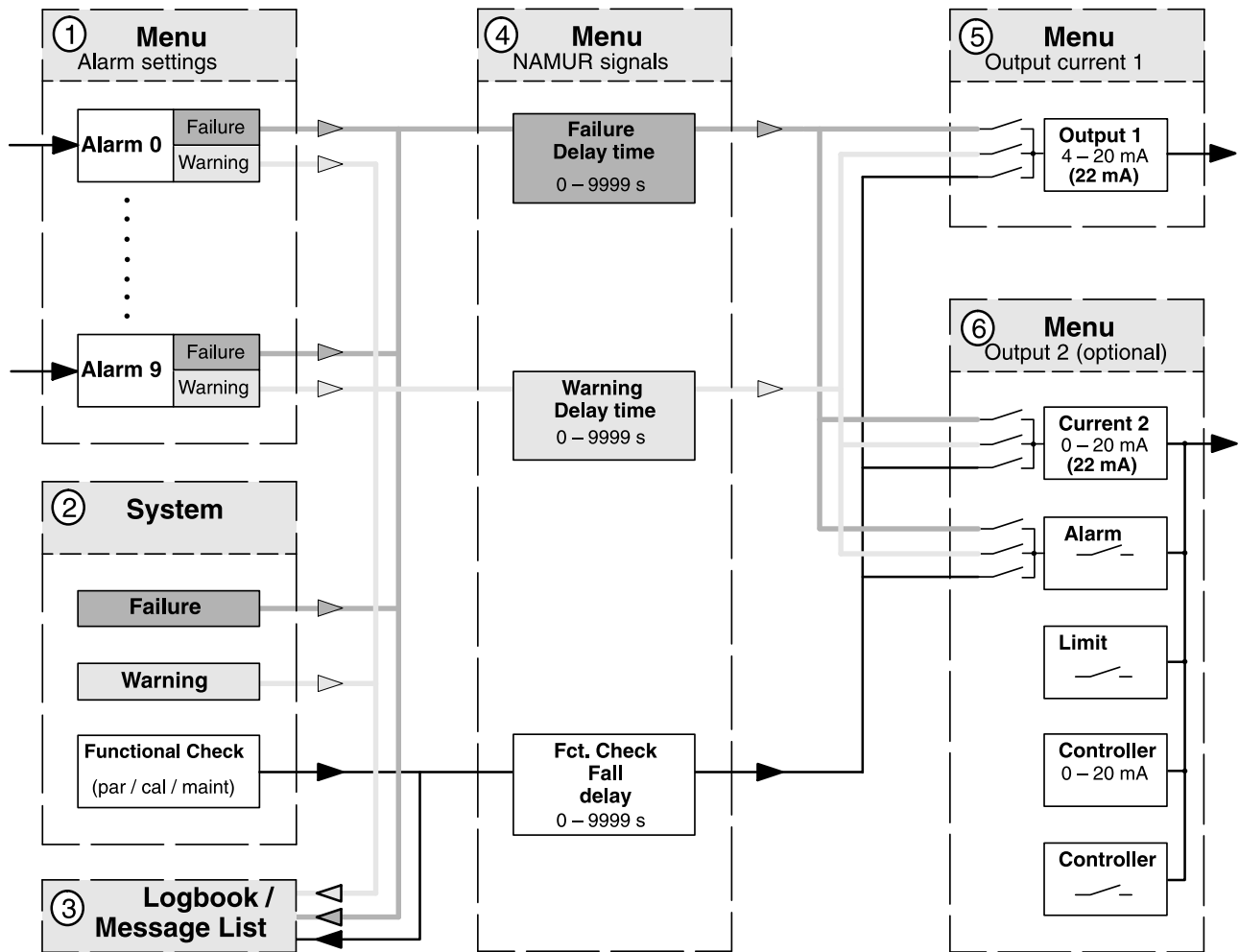

Fig. 4-2 Alarm processing

The defined alarms 0 to 9 ① and the system ② generate the NAMUR signals Failure and Warning. In addition, the system ② also generates the Functional Check signal during parameter setting, calibration, and maintenance.

These signals are immediately entered in the message list and logbook ③ (Opt. 354).

In the NAMUR Signals menu ④, you can define individual delay times for these messages.

```
adm NAMUR Signals | 57.4mS/cm
3 signals: Functional Check,
Warning (Maintenance!), Failure
Failure Delay 0000 s
Warning Delay 0000 s
Fct Check Fall delay 0000 s
<< Return [par]
```



For functional check, the defined delay time acts as a fall delay!

This has the advantage that, for example, any temperature or measurement settling times following a sensor calibration can be bridged with a correspondingly defined fall delay time.

```
adm Output Current 1 | 57.4mS/cm
>> Variable          [S/cm]
>> Curve             [Linear]
Beginning           4mA   0.000 µS/cm
End                 20mA  2.000 S/cm
>> 22mA Message
<< Return [par]
```

```
adm 22mA Message | 57.4mS/cm
Failure            On Off
Warning            On Off
Functional Check   On Off
<< Return [par]
```

```
adm Output 2 | 57.4mS/cm
>> Usage            [Alarm Contact]
>> Alarm Contact
<< Return [par]
```

The messages can be output via output current 1 ⑤ or output 2 ⑥ (if current 2 is active) as a 22 mA signal.

To do so, all three messages can be activated separately or in any combination in the 22 mA Message submenu.

If output 2 is set as an alarm contact, it can be used to output these messages. In this menu the alarm contact can be set as a normally open or a normally closed contact.

HART® Communication

With Option 467 “HART® Communication” you can, for example, communicate with the Transmitter 7220X via the loop current using a handheld terminal or from the control room. Device data, measured values, messages, and parameters are retrievable.

The Transmitter 7220X can be addressed from the master in two different ways: via a long, permanent address, which is unique world-wide, or via a selectable short address.

The device address is unique world-wide for each device. It is composed of the manufacturer ID, the device type and the serial number.

The short address has two functions. You select the address 00 for a **point-to-point connection**. The output current then continues to be controlled by the measurement signal. In the **bus mode** (multi-drop) each connected device must have a unique short address. The addresses 01 to 15 are used for this purpose. All devices supply a constant 4 mA at the current output. The data are transmitted completely via the HART® signal.

Device address

Short address

Write protection



```

adm HART Communication | 56.6mS/cm
● Device Address : 21EE000000
● Short Address 00: Point to Point
  01...15: Multidrop Mode
Short Address 00
Write Protection On Off
  >> Primary Variable [S/cm]
  >> Secondary Variable [%]
  >> Tertiary Variable [°C]
  >> 4th Variable [CELL]
  << Return [par]
    
```

The write protection protects the settings from being changed via the HART® interface. The write protection can only be switched on or off via the menu.

When activated, the write protection also prevents the short address from being changed with the HART® commands.

You can select the short address of the unit and activate or deactivate the write protection.

From pull-down menus, you can select the respective process variables for the HART® “Secondary Variable”, “Tertiary Variable”, and “4th Variable”. The “Primary Variable” is always assigned to the process variable of output current 1.

The selected process variables can be read out with the HART® command #3 (Read Dynamic Variables and P.V. Current). This allows to transmit and evaluate up to four process variables using standard HART programs (without Device Description).

A list of the HART® commands for the Transmitter 7220X can be found in the enclosed “Transmitter-Specific Command Specification” (with Option 467 only).

HART® commands

HART® is a registered trademark of HART Communication Foundation

Setting the clock

```

adm Set Clock | 57.4mS/cm
  >> Date Format =====>
  Time 09:11:39 [DD.MM.YY]
  Date 18.11.96 [DD/MM/YY]
  << Return [par]
    
```

```

adm Set Clock | 57.4mS/cm
  >> Date Format [DD.MM.YY]
  Time 09:12:06
  Date 18.11.96
  << Return [par]
    
```

In the Date Format pull-down menu, you can select the desired type of display.

On pressing **enter**, the clock starts running at the entered value.

Pressing **par** cancels the entry (Undo). The clock then keeps the old time.

Point of measurement/note

```
adm Point of Measurement 57.4mS/cm
i Enter 0...9A...Z-+/-
  using [↑][↓]
Measurement Point 0IRC6177.....
Note 77LF:.....
<< Return [par]
```



| Unit | HART® | Character length |
|------------|------------|------------------|
| Meas.point | TAG | 16 (HART®: 8) |
| Note | DESCRIPTOR | 16 |
| - | MESSAGE | 32 |

```
adm Device Diagnostics 57.4mS/cm
Self test On Off
Interval time 0024 h
<< Return [par]
```

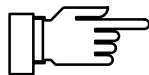

“On-site recorder”

In the Point of Measurement menu, you can specify the point of measurement according to DIN 19227 (ISO 3511) by entering a tag number. In addition, you can enter a note.

Each entry may be up to 16 characters long. In measuring mode, there is a display with the tag number or note beneath the secondary displays. Pressing **enter** switches between the displays.

With the “HART® Descriptor” you can, for example, enter operating instructions as a note, which is then shown in the display. With HART® communication, only the first 8 characters of the tag number are used (HART® Specification).

Device diagnostics

The Transmitter 7220X can perform an automatic self test (memory test) at regular intervals. In the case of a defective memory, the “Warn Device Diagnostics” message is output.

The automatic self test is only carried out when the unit is in measuring mode and the interval time is not set to 0000 h. During the testing, measurement is continued in the background. All outputs remain active.

The device tests can be executed manually in the “Device Diagnostics” menu. The respective results are displayed (see Pg 6-3).

Measurement recorder

If you want to use the measurement recorder, but your unit is not equipped with Option 448, you can retrofit the option. See Release of options on Page 4-30.

For process visualization or, for example, for controller optimizing, the measurement recorder continuously registers two user-defined process variables and simultaneously displays them graphically next to each other in the system display.

Process variable, measurement range, recording method and time feed (scanning interval) parameters can be set within broad limits. The last 500 measured values are available with time and date in the form of a graph and as numerical values.

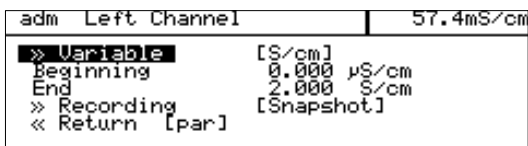
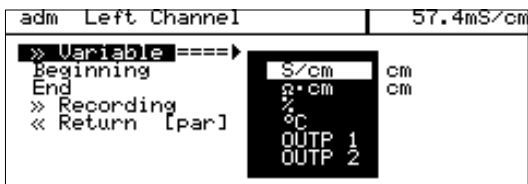
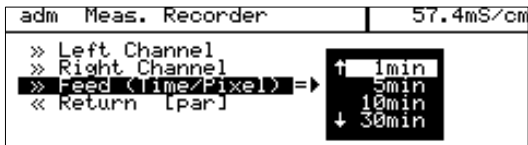
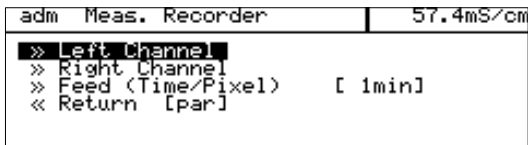

The measurement recorder can be adjusted like an ordinary recorder: The right and left channel can be separately defined. The feed (scanning interval) applies to both channels.

You can choose feed rates from 2 seconds up to 10 hours per recorder entry. With a rate of 2 seconds, the recorder shows the data of the last 16 minutes, with a 10 hour rate, it shows the data of the last 7 months.

Right and left channel:

Select the controlling process variable from the Variable pull-down menu. The following process variables are available:

- Conductivity (S/cm)
- Resistivity ($\Omega \cdot \text{cm}$)
- Concentration (% by wt)
- Measured temperature ($^{\circ}\text{C}$)
- OUTP1 Output current 1
- OUTP2 Output current 2
(with Option 487 only)

Beginning and End define the recorder range.

These value only refer to the graphic representation in the display. All measured values are stored with their complete number of digits.

In the Recording pull-down menu, you can choose between four methods:

- **Snapshot**
The currently measured value is recorded after expiration of the feed time.
- **Min Value**
Each measured value is checked in the measurement recorder. The lowest value within the feed time is entered in the recorder memory.
- **Max Value**
Each measured value is checked in the measurement recorder. The highest value within the feed time is entered in the recorder memory.
- **Average**
The measurement recorder calculates a mean value of all values measured, i.e. the value entered in the recorder memory is the arithmetical average of all values measured within the feed time.

Passcode entry

Access to the Calibration and Maintenance menus and to parameter setting at the Operator and Administrator levels can be protected with passcodes. You can set or disable each passcode individually (the Administrator passcode cannot be disabled).



When a passcode is disabled, there is no protection against unauthorized access to the corresponding menu!

For safety reasons, you should not use the standard passcodes!

The factory-set passcodes are the same for all units. Therefore, you should define your own passcodes.

| | | |
|-------|-------------------------|-----------|
| adm | Passcode Entry | 57.4mS/cm |
| cal | Calibration | On Off |
| maint | Maintenance | On Off |
| opl | Operator Level | On Off |
| | Change passcode | 1246 |
| >> | adm Administrator Level | |
| << | Return [par] | |

The "Change passcode" line only appears when a passcode is enabled. The passcode remains stored even if it has been disabled.

Setting the Administrator passcode

If you have lost the Administrator passcode, system access is locked! The Administrator level cannot be accessed for parameter setting. All menu items locked for the Operator level can no longer be edited.



| | | |
|-----|---|-----------|
| adm | Passcode Entry | 57.4mS/cm |
| ! | If you lose your adm passcode, system access will be locked! | |
| adm | Administrator Level | 1989 |
| << | Return [par] | |

In this case, please contact:

Mettler-Toledo GmbH
Process Analytics
Hotline
Im Hackacker 15
8902 Urdorf/Switzerland
Phone: +41-1-736 22 14
Telefax: +41-1-736 26 36

| | | |
|-----|---|-----------|
| adm | Passcode Entry | 57.4mS/cm |
| ! | If you lose your adm passcode, system access will be locked! | |
| | Repeat entry: | 1989 |

After having entered the Administrator passcode, you are prompted to repeat the input for safety reasons.

If the second entry does not correspond to the first entry or if you cancel by pressing **par**, the Administrator passcode will not be changed.



When you set the Administrator passcode to “0000”, the Administrator level can be accessed without passcode entry by pressing **enter** at the passcode prompt.



When you set the Administrator passcode to “0000”, menus and device settings will not be protected against unauthorized access! Improper changing of the device settings may lead to malfunctions of the Transmitter 7220X and to incorrect measured-value outputs!

Factory-set passcodes

As delivered, the following passcodes are set in the Transmitter 7220X:

- Calibration passcode: 1147
- Maintenance passcode: 2958
- Operator passcode: 1246
- Administrator passcode: 1989

Release of options



You can retrofit software options at any time on the site without dismantling the unit. To do so, you require a device-specific, unique transaction number (TAN).

- To release an option, you require:
- the desired option number,
- the model designation (Transmitter 7220X)
- and the serial number of your Transmitter.

Please refer to the Diagnostics/Device Description menu (see Pg 6-2) for this information. The price of the option depends on the currently valid price list.

A list of available options is provided on Page 9-2.

The transaction number (TAN) can be obtained from your Mettler Toledo representative.

Option release with transaction number (TAN):

```
adm Release of Options | 57.5mS/cm
● Release of options only with
i valid transaction number (TAN)
>> Option => 353 Controller
              354 Logbook
              359 Concentration
TAN          ↓ 392 UI Water
<< Return [ ]
```

1. Select the desired option from the Option pull-down menu. Contact the address above specifying the option number, model designation and serial number.

```
adm Release of Options | 57.4mS/cm
● Release of options only with
i valid transaction number (TAN)
>> Option [354 Logbook]
TAN      ED878781
<< Return [par]
```

2. Enter the transaction number you have received and confirm your entry by pressing **enter**.

```
adm Release of Options | 57.4mS/cm
● Release of options only with
i valid transaction number (TAN)
>> Option [354 Logbook]
TAN      ED878781
<< Return [par]
```

3. With the correct TAN you can enable or disable the option. The transaction number can be used repeatedly with this Transmitter 7220X to enable or disable the option at any time.

This page has been left empty for technical reasons.

5 Calibration

Why do you have to calibrate?

Every **conductivity sensor** has its individual **cell constant**. Depending on the sensor design, the cell constant may vary over a wide range. As the conductivity is calculated from the measured conductance and the cell constant, this must be known to the Transmitter 7220X.

For **calibration** or **sensor standardization**, either the known (stamped on) cell constant of the conductivity sensor used is entered in the Transmitter 7220X or it is determined automatically by measuring a calibration solution with a known conductivity.



Without calibration every conductivity meter delivers an incorrect output value!
Especially after replacing the sensor, you should perform a calibration if the cell constants of the two sensors differ more than tolerable.

Monitoring functions for calibration

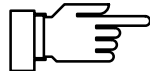

The Transmitter 7220X provides functions for monitoring proper calibration performance and the sensor condition. This allows documentation for quality management to ISO 9000 and GMP.

- If the measured value is significantly out of range, **Sensocheck** delivers the “Warn Sensocheck” signal. Especially when using 2-electrode sensors, the signal is generated when decisive measurement errors (10 - 30 %) occur due to polarization or contamination.
At the same time, Sensocheck monitors the cable influence. The warning signal is generated, for example, when unsuitable cables or cables which are too long for the measurement range have been laid.
- The **logbook** provides time and date stamped records of calibrations performed within the last 200 events (see Pg 6-2).

- You can define limits for warning and failure messages for the cell constant (see Pg 4-23). This permits automatic monitoring of the cell constant values determined during calibration.

Calibration menu

Pressing **cal** accesses the Calibration menu.

```
cal Calibration | 57.4mS/cm
» Automatic with Standard Cal Solution
» Manual Ent
» Data Entry | Passcode: 1147
» Sample Cal
« Return to measurement [cal]
```

If calibration is protected with a passcode, you must enter the correct passcode to access the Calibration menu. The calibration passcode can be defined or disabled at the Administrator level (see Pg 4-29).

```
cal Calibration | 57.4mS/cm
» Automatic with Standard Cal Solution
» Manual Entry of Cal Solution
» Data Entry - Premeasured Cell
» Sample Cal
« Return to measurement [cal]
```

Four different calibration methods are available:

- Automatic determination of the cell constant with a standard calibration solution
- Automatic determination of the cell constant by manual input of the conductivity value of the calibration solution
- Data entry (cell constant) from pre-measured conductivity sensors
- Calibration with sampling

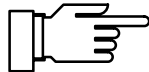

The NAMUR “functional check” signal is active during calibration.

```
cal Automatic | 57.4mS/cm
i Cal Solution [NaCl 0.01 mol/l]
! Abort function: Installation
! ready for measurement ?
En Yes No
```

If you press **meas** before having performed a calibration, you are prompted to confirm your decision to abort calibration.

If you abort, the old cell constant remains valid.

Temperature detection during calibration

The InPro[®] sensors have an integrated temperature probe which automatically detects the temperature and makes it available for calculating the measured value.

The Transmitter 7220X also allows to work with manual temperature specification or using separate temperature probes (Pt 100, Pt 1000, Ni 100, or NTC 30 k Ω).

What is temperature detection used for?

Detection of the calibration solution temperature is important because the conductivity of the calibration solution is temperature-dependent.

- For automatic calibration, the temperature of the calibration solution must be known to select the correct conductivity value from the table.
- For manual calibration and sampling, you must enter the temperature-corrected conductivity value.



During parameter setting you define whether cal temperature is measured automatically or must be entered manually (see Pg 4-9).

Automatic temperature detection

For automatic cal temp detection, the Transmitter 7220X measures the temperature of the calibration solution with a temperature probe (Pt 100, Pt 1000, Ni 100, or NTC 30 k Ω).



When “Cal Temp automatic” is set, “Measured Cal Temp” appears in the menu.
When “Cal Temp manual” is set, “Enter Cal Temp” appears in the menu.

Automatic calibration with standard calibration solution

For automatic calibration, the sensor is immersed in a standard calibration solution stored in the Transmitter.

From the measured conductance and temperature, the Transmitter 7220X automatically calculates the cell constant. The temperature dependence of the calibration solution's conductance is taken into account by the Transmitter 7220X.

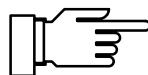

During calibration, the output currents are frozen at their last values, the limit contacts are inactive, the controller output can either be frozen or set to zero (see Pg 4-19), a wash interval is not started. The NAMUR "functional check" signal is active.

What you have to know for calibration

Use only fresh calibration solutions! The calibration solution used must have been selected during parameter setting (see Pg 4-6).

Calibration accuracy decisively depends on the exact detection of the calibration solution's temperature. Using the measured or entered temperature, the Transmitter 7220X determines the nominal value for the calibration solution from a stored table. Observe the response time of the temperature probe!

For exact determination of the cell constant, wait until the temperature probe and calibration solution have the same temperature.



Calibration sequence

Select the "Automatic with Standard Cal Solution" submenu. The selected calibration solution is displayed.

Confirm "Calibration Proceed".

```

cal Automatic | 57.4mS/cm
● Cal Solution [NaCl 0.01 mol/l]
i TC automatically considered
Enter cal temp +025.0 °C
Calibration Proceed Return
    
```

Immerse the sensor in the calibration solution and confirm "Calibration Start".

```

cal Automatic | 57.4mS/cm
● Immerse cell in calibration solution
i Output current frozen,
  controller: V=0%
Calibration Start Return
    
```

| | |
|-------------------------------|-------------|
| cal Automatic | 57.4mS/cm |
| ● Calibration running | |
| ■ Correction of Cell Constant | |
| ● Calibration Temp | +025.0 °C |
| ○ Solution Chart Value | 1.183 mS/cm |
| Response Time | 0005 s |

From the **response time**, you see how much time the sensor needs for the measured value to stabilize.



If the measured conductance or the measured temperature fluctuate greatly, the calibration procedure is aborted after 2 min.

| | |
|-------------------|--------------|
| cal Automatic | 1.183mS/cm |
| ● Cal Temperature | +025.0 °C |
| ■ Conductivity | 1.183 mS/cm |
| Cell Constant | 0.021 /cm |
| ■ Calibration | ■ End Repeat |

When calibration has been successfully completed, the determined cell constant is displayed. In the case of a calibration error an error message is displayed. The calibration must then be repeated.

Calibration with manual entry of conductivity

For calibration with manual entry of the calibration solution's conductivity, the sensor is immersed in a calibration solution. The Transmitter 7220X determines a conductivity/calibration temperature value pair.

Then, the temperature-corrected conductivity value of the solution must be entered. To do this, read off the conductivity for the temperature displayed from the TC table of the calibration solution. Intermediate temperature values must be interpolated. The Transmitter 7220X then automatically calculates the cell constant.



During calibration, the output currents are frozen at their last values, the limit contacts are inactive, the controller output can either be frozen or set to zero (see Pg 4-19), a wash interval is not started. The NAMUR "functional check" signal is active.



Use only fresh calibration solutions!

For exact determination of the cell constant, wait until the temperature probe and calibration solution have the same temperature.

Calibration sequence

```

cal Manual Entry | 1.183mS/cm
● Immerse cell in calibration solution
I Output current frozen,
  controller: V=0%
[Calibration] [Start] Return
    
```

Select the “Manual Entry of Cal Solution” submenu. Immerse the sensor in the calibration solution and confirm “Calibration Start”.

```

cal Manual Entry | 1.183mS/cm
● Calibration running
I Determine pair of cond/°C values
○ Calibration Temp      +025.0 °C
● Response Time        0004 s
    
```

From the **response time**, you see how much time the sensor needs for the measured value to stabilize.



If the measured conductance or the measured temperature fluctuate greatly, the calibration procedure is aborted after 2 min.

```

cal Manual Entry | 1.183mS/cm
● Enter calibration solution
I for correct temperature!
  Cal Temperature      +025.0 °C
[Conductivity] ± 1.183 mS/cm
[Calibration] [End] Repeat
    
```

After expiration of the response time the measured conductivity is displayed.

Enter the conductivity value of the calibration solution.

```

cal Manual Entry | 1.183mS/cm
● Enter calibration solution
I for correct temperature!
  Cal Temperature      +025.0 °C
  Cell Constant        0.021 /cm
[Calibration] [End] Repeat
    
```

When calibration has been successfully completed, the calculated cell constant is displayed. In the case of a calibration error an error message is displayed. The calibration must then be repeated.

Calibration by entering data from pre-measured sensors

You can directly enter the cell constant of the sensor used. The cell constant is usually printed on the sensor.

The printed-on cell constant is a nominal value. Due to production-related scatter, the actual value deviates from the nominal one. For some types of conductivity sensors, it may also change due to the installation conditions.



For exact measurements, the sensor should therefore be calibrated (automatic, manual, or sample calibration).

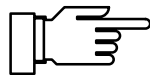

During calibration, the output currents are frozen at their last values, the limit contacts are inactive, the controller output can either be frozen or set to zero (see Pg 4-19), a wash interval is not started.

The NAMUR functional check signal is active.

```
cal  Data Entry      10.72mS/cm
i  Output current frozen,
   controller: V=0%
Cell Constant      0.187 /cm
« Return  Local
```

Select the “Data Entry” submenu and enter the cell constant.

Calibration with sampling

When the sensor cannot be removed, e.g. for sterility reasons (for biotechnical processes), its cell constant can be determined with “sampling”.

To do so, the currently measured process value is stored by the Transmitter 7220X. Immediately afterwards, you take a sample from the process. The sample value is measured in the lab.

Enter the sample value in the Transmitter 7220X. From the difference between process value and sample value, the Transmitter 7220X calculates the cell constant of the conductivity sensor.

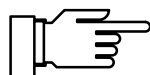

During calibration, the output currents are frozen at their last values, the limit contacts are inactive, the controller output can either be frozen or set to zero (see Pg 4-19), a wash interval is not started.

The NAMUR “functional check” signal is active.

Calibration sequence

| | | |
|----------------|---------------------------|-------------|
| cal | Sample Cal | 10.7mS/cm |
| • | Sample Temp | +025.1 °C |
| i | Stored Sample | 10.72 mS/cm |
| | without temp compensation | |
| « Return [CAL] | | |

Select the “Sample Cal” submenu.

The measured sample temperature and the current conductivity value of the process medium are displayed and stored.

In addition, you can see whether calibration is to be performed with or without TC correction (for parameter setting, see Pg 4-5).

| | | |
|-------|----------|------------|
| 10.72 | | Sample |
| | | mS/cm |
| | | MAN. TEMP |
| DATE | 18.11.96 | MAN 25.0°C |

In measuring mode the word “Sample” in the upper right corner of the display indicates that a sample value has been stored for calibration. The Transmitter expects entry of the comparative value, however continues to measure using the old cell constant.

| | | | |
|-----------|----------|-------|--------|
| MAN. TEMP | Sample | | meas |
| DATE | 18.11.96 | MAN | 25.0°C |
| QIRC6177 | | 10:39 | |

Without TC correction

Take a sample from the process and measure its value at the temperature at which the sample has been taken (“Sample Temp”, see display). To do so, it may be necessary to thermostat the sample correspondingly in the lab. Temperature compensation must be turned off at the lab meters (TC = 0 %/K).

With TC correction

$T_{ref} = 25\text{ °C}$

Take a sample from the process. The sample value can be measured using a portable meter or in the lab. Be sure that the same values are set for reference temperature and temperature coefficient in the comparison meter and in the Transmitter 7220X. Furthermore, the measuring temperature should correspond to the sample temperature (see display). Therefore, you should transport the sample in an insulated container (Dewar).

With TC correction

$T_{ref} \neq 25\text{ °C}$

Take a sample from the process. The sample value can be measured using a second Transmitter 7220X (installed in the lab). Be sure that the same values are set for reference temperature and temperature coefficient in the comparison meter and in the Transmitter 7220X. Furthermore, the measuring temperature should correspond to the sample temperature (see display). Therefore, you should transport the sample in an insulated container (Dewar).



Sample calibration can only be performed if the process medium is stable. That means, for example, that there are no chemical reactions which have an effect on the process conductivity.

At higher temperatures, the sample values can also be invalidated due to evaporation.

```
cal Sample Cal | 10.7 mS/cm
├── Sample Temp | +025.1 °C
├── Stored Sample | 10.72 mS/cm
│   without temp compensation
├── Lab Value | 10.72 mS/cm
└── << Return [call]
```

When you have determined the sample value, open the “Sample Cal” submenu again.

The measured sample temperature and the stored value are displayed.

In addition, you can see whether calibration is to be performed with or without TC correction. Enter the measured sample value (“Lab Value”). The new cell constant is automatically calculated and stored.

This page has been left empty for technical reasons.

6 Diagnostics menu

```
diag Diagnostics      56.7mS/cm
>> Message List      2 Messg.
>> Cal Record
>> Logbook
>> Device Description
>> Device Diagnostics
>> Meas. Recorder (List)
<< Return to measurement [diag]
```

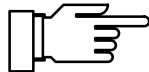

The Diagnostics menu provides all relevant information on the instrument status. During diagnostics all measuring functions of the Transmitter 7220X continue to be active. All outputs continue to be operated and warning and failure message are output.

If no key is pressed within **20 minutes**, the Diagnostics menu is automatically exited.

Message list

```
diag Message List    56.7mS/cm
Fail Hi Conduct Value
Warn Hi Conduct Value
<< Return [diag]
```

The Message List shows the number of currently activated messages and the individual warning or failure messages in plain text.

For explanations of the individual messages please refer to Chapter 8.

Cal record

```
diag Cal Record      56.7mS/cm
Last Calibration      18.11.96 10:43
Cal Mode              Manual Entry
Cell Constant         +0.988 /cm
Solution Chart Value +10.72 mS/cm
Cal Temp              +025.0 °C
Response Time         +0008 s
<< Return [diag] [↑][↓] Scrolling
```

The Cal Record displays all relevant data of the last sensor calibration for preparing documentation in accordance with ISO 9000 and GMP.

- Date and time of last calibration
- Calibration mode (e.g. Automatic)
- Cell constant
- Chart value of calibration solution used
- Calibration temperature
- Response time of sensor until stabilization of measured value



For some calibration procedures, such as Data Entry, not all measured values are available. The respective positions are then covered with a gray bar.

Logbook

This option (Logbook) can be retrofitted via TAN (see Pg 4-30).



| diag | Logbook | 56.7mS/cm |
|--------------------------------|---------|-----------------------|
| 18.11.96 | 10:51 | Diagnostics Active |
| 18.11.96 | 10:51 | Warn Hi Conduct Value |
| 18.11.96 | 10:51 | Fail Hi Conduct Value |
| 18.11.96 | 10:51 | Measurement Active |
| 18.11.96 | 10:51 | adm Setting |
| « Return [diag] [F1] Scrolling | | |

The logbook contains the last 200 events with date and time and displays them. Error messages occurring during parameter setting, calibration or maintenance are ignored. The following events are recorded:

- Transmitter in measuring mode
- Transmitter turned on/off
- ■ : Start of warning and failure messages
- □ : End of warning and failure messages
- Calibration messages
- Parameter setting, calibration, maintenance or diagnostics active
- Entry of a wrong passcode

The logbook entries can be used for quality management documentation to ISO 9000 and GMP.

Logbook entries cannot be edited!

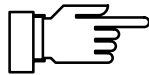

Device description

| diag | Device Description | 56.7mS/cm |
|--------------------------------|--------------------|-------------------------|
| | Model | 7220X |
| | Serial No. | 0000927 |
| | Version | Hardw: 2 Softw: 3.0 |
| | PRG Module | SL15230000/0 |
| | Options | 353;354;359;392;448;449 |
| « Return [diag] [F1] Scrolling | | |

The Device Description contains information on the model designation, serial number and instrument options.

The display indicates:

- Model designation
- Serial number
- Hardware and software version
- Program module code
- Instrument options

The software version must correspond to the version indicated at the bottom right of the second page of this manual.

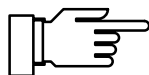

Device diagnostics

The Device Diagnostics feature allows you to perform extensive tests to check the function of the Transmitter 7220X.

This permits quality management documentation to ISO 9000.

Instrument settings and parameters are not affected.

In the Device Diagnostics menu you see when each test was performed and what the result was.

Start the selected test with **enter**.

```
diag Device Diagnostics | 56.7mS/cm
RAM Test      15.11.96 16:07 ok
EPROM Test   15.11.96 16:08 ok
EEPROM Test  15.11.96 16:09 ok
Display Test 12.07.90 15:38 executed
Keypad Test  01.01.90 00:00 ok
<< Return [diag]
```

```
diag RAM Test
i Non-Destructive RAM Test
55% 0 50 100
```



```
diag Keypad Test
i Press each key once
  Abort: [diag] [diag]
[meas] [cal] [maint] [par] [diag] [enter]
```



Memory test

Select “RAM Test”, “EPROM Test”, or “EEPROM test”.

The Transmitter forms a CRC checksum for the calculated data and compares it with the setpoint.

If “Failure” appears in the menu after the test is completed, the Transmitter must be sent in to the manufacturer for repair.

Display test

Several test patterns will be displayed allowing you to check whether all pixels, lines and columns function properly.

If there are disturbances in the test patterns, the Transmitter should be sent in to the manufacturer for repair.

Keypad test

Each key must be pressed once during keypad testing. Keys that have been pressed are highlighted.

If “Keypad Test Failure” appears in the menu after the test, the Transmitter must be sent in to the manufacturer for repair.

Measurement recorder (listing)



This option (Measurement recorder) can be retrofitted via TAN (see Pg 4-30).

| diag | Meas. Recorder | 56.7mS/cm |
|---------------------------------------|----------------|-------------------|
| ↑ | 18.11.96 10:59 | +056.7mS +026.1°C |
| | 18.11.96 10:58 | +056.7mS +026.1°C |
| | 18.11.96 10:57 | +056.7mS +026.1°C |
| | 18.11.96 10:56 | +056.7mS +026.1°C |
| ↓ | 18.11.96 10:55 | +056.7mS +026.1°C |
| « Return [diag] [F1] [F2] scrolling » | | |

In addition to the graphic display of the measurement recorder (see Pg 3-4), the Diagnostics menu provides the last 500 measured value pairs from the recorder memory as a listing. Each recorder entry occupies one display line. The measured values of both channels are recorded with date and time. The symbols for min (▼), max (▲) or mean value (~) are displayed after the measurement symbol, if applicable.



Entries in the measurement recorder cannot be edited!

7 Maintenance menu

```
maint Maintenance | 56.7mS/cm
├── Meas. Point Maint.
│   ├── Measure Resistance
│   ├── Current Source
│   ├── Adjust Temp Probe
│   ├── Manual Controller
│   └── Return to measurement [maint]
```

The Maintenance menu provides all functions for sensor maintenance and adjustment of connected devices. Access to the Maintenance level can be protected with a passcode.

- The current source allows manual adjustment of all active output currents for configuring and checking connected peripheral devices (such as indicators or recorders).
- Temperature probe adjustment allows individual calibration of the connected temperature probe.
- If the Transmitter is equipped with the controller function (Option 353) and the controller has been activated, you can manually enter the controller output (manipulated variable Y).

Measurement point maintenance

```
maint Meas. Point Maint. | 56.7mS/cm
├── Output current frozen,
│   │ controller: Y=0%
│   └── Message List
│       ├── Current Source
│       ├── Calibration
│       └── Return [maint]
```

Measurement point maintenance allows you to remove the sensor. While the Transmitter is in measurement point maintenance mode, you can clean or replace the sensors. The output current is frozen at its last value, the controller output is either frozen or set to zero and the NAMUR “functional check” signal is active.

In the measurement point maintenance mode you can view the message list, activate the current source or start calibration.

- Message list
In this submenu you can view the message list containing all active messages (without releasing the outputs) (see Pg 6-1).
- Current source
In this submenu you can manually specify the output currents during maintenance (for current source function, see Pg 7-2).
- Calibration
In this submenu you can start a calibration directly from the Maintenance menu without having to release the outputs (for calibration, see Pg 5-1 and the following).

Resistance measurement

```

maint Measure Resistance | 56.7mS/cm
● Value without TC
  i and cell constant
Resistance           017.4 Ω
<< Return [maint]
    
```



In the “Measure Resistance” menu, the resistance connected to the measuring input is displayed directly. This allows to check the measuring equipment by connecting a known ohmic resistor in place of the conductivity sensor, for example. When doing so, note the conductivity input range.

Cell constant and TC are not included in the calculation of the displayed resistance! However, the output values continue to be output with the entered cell constant and, if applicable, with the defined TC correction.

Current source function



During current source function the output currents do not follow the measured value! The values can be entered manually.

Therefore, you must make sure that the connected devices (control room, controllers, indicators) do not interpret the current value as a measured value!

```

maint Current Source | 56.7mS/cm
● Output current definable 0/4..22mA
  i Confirm with [enter]
Output Current 1    04.45 mA
Current Output 2   14.45 mA
<< Return [maint]
    
```

In the Current Source menu you can manually adjust the values for the output currents, for example to check connected peripheral devices.

```

maint Current Source | 56.7mS/cm
● Output current definable 0/4..22mA
  i Confirm with [enter]
Output Current 1    04.45 mA   HART
Current Output 2   14.45 mA
<< Return [maint]
    
```

During Multidrop mode the output current 1 is permanently set to 4 mA. This is indicated by the word “HART”.

Temperature probe adjustment

During temperature probe adjustment you compensate for the individual tolerance of the temperature probe and the influence of the lead resistances. This increases the accuracy of the temperature measurement.



Adjustment may only be carried out after the process temperature has been precisely measured using a calibrated reference thermometer! The measurement error of the reference thermometer should be less than 0.1 °C.

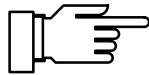

```

maint Adjust Temp Probe | 27.0 °C
i Probe Tolerance and Lead Adjustment
  Enter measured process temp
Installation Adjustment  On  Off
« Return [maint]

```

To simplify the adjustment procedure, set “Measurement Display: Variable °C” (see Pg 4-3).

When the measurement display has been set accordingly, the temperature measured by the temperature probe is displayed in the upper right corner.

```

maint Adjust Temp Probe | 26.1 °C
i Probe Tolerance and Lead Adjustment
  Enter measured process temp
Installation Adjustment  On  Off
Process Temp:          +026.1 °C
« Return [maint]

```

Switch on Installation Adjustment and enter the process temperature measured by the reference thermometer.

Now the compensated temperature from the temperature probe is displayed in the upper right corner.

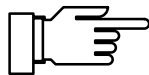

The permissible adjustment range is ± 5 °C from the value measured by the temperature probe.

Manual entry of controller output

If the Transmitter is equipped with the controller function (Option 353) and the controller has been activated, you can manually adjust the controller output (manipulated variable Y) for test purposes or to start a process.

When you manually adjust the controller output, it no longer follows the controlled variable!

Therefore, you must make sure that the connected actuators and the control loop are monitored accordingly!



```

maint Manual Controller | 56.7mS/cm
i ▶Output 2: -100...0 %
Controller Output      -032.0 %
« Return [maint]

```

You can enter the controller output in the range from -100% to $+100\%$, for example to check connected actuators. When you exit manual controller entry, the Transmitter switches back to automatic controller operation.

With a PI controller (reset time $\neq 0$), switchover is smooth. This allows you to rapidly start processes with large time constants or dead times.



With the definable **feed time alarm**, you can monitor the time during which the controller output is at $+100\%$ or -100% , i.e. how long the valve is fully open. If this time is exceeded, this may be due to a shortage of feed chemical or a defective valve, for example.

This page has been left empty for technical reasons.

8 Error messages

| Error message | Cause |
|--|--|
| No message | No errors |
| Fail Hi Cond Value Warn Hi Cond Value Warn Lo Cond Value Fail Lo Cond Value | Conductivity > 2 S/cm or above failure limit Conductivity above warning limit Conductivity below warning limit Conductivity below failure limit |
| Fail Hi Conc Value Warn Hi Conc Value Warn Lo Conc Value Fail Lo Conc Value | Concentration > 100 % by wt or above failure limit Concentration above warning limit Concentration above warning limit Concentration < 0 % by wt or below failure limit |
| Fail Hi Cell Const Warn Hi Cell Const Warn Lo Cell Const Fail Lo Cell Const | Cell constant > 200 1/cm or above failure limit Cell constant above warning limit Cell constant below warning limit Cell constant < 0.0050 1/cm or below failure limit |
| Fail Concentration Warn Ref Temp Warn TC | Out of range Reference temperature < -50 °C or > 250 °C TC calculation out of range |
| Warn Current Par | Current parameter error 1, 2 |
| Warn Cell Const | Cell constant during calibration < 0.0050 or > 200 1/cm |
| Fail TC range | Temperature outside TC tables for natural waters or ultrapure water (see Pg 4-4) |
| Fail Hi Conductance Fail Lo Conductance | Measured conductance too high Measured conductance too low |
| Fail Hi Temp Warn Hi Temp Warn Lo Temp Fail Lo Temp | Measured temperature above failure limit or outside measurement range (depending on probe) Measured temperature above warning limit Measured temperature below warning limit Measured temperature below failure limit or outside measurement range (depending on probe) |
| Warn Current1 Span Warn Current1 < 0/4 mA Warn Current1 > 20 mA | Current output 1: Start and end value too close Current output 1: Output current below defined start value Current output 1: Output current above defined end value |
| Warn Current2 Span Warn Current2 < 0/4 mA Warn Current2 > 20 mA | Current output 2: Start and end value too close Current output 2: Output current below defined start value Current output 2: Output current above defined end value |
| Warn Cal Temp | Calibration temperature out of range |

| Error message | Cause |
|---|--|
| Warn Sensor Unstable Fail Sensor Failure | Measured value not stable for > 10 sec (during calibration only) Measured value not stable for > 60 sec (during calibration only) |
| Warn Time/Date | Time had to be automatically initialized: The clock must be reset! |
| Warn Control Para | Parameter error in controller, see Pg 4-22 |
| Fail CRC Error par | CRC data error during parameter setting: Check all settings at the Administrator level! |
| Fail Hi Feed Time Warn Hi Feed Time | Controller: Feed time above failure limit Controller: Feed time above warning limit |
| Warn Write Protection | Write protection violation at "WriteProtect" (for HART® only) |
| Warn Device Diag Fail System Failure | Diagnostics error: Instrument self-test defective Clock failure, CRC error in factory settings |

9 Product line and accessories

| Devices | Ref. No. |
|---|-------------------|
| Transmitter 7220X | 7220X |
| Mounting accessories | |
| Mounting plate, extruded profile AlMg3, 20 µm anodized (not required for direct wall mounting) | ZU 0136 |
| Bracket kit, brackets hot galvanized, screws stainless steel, wing nuts aluminum anodized, (only in conjunction with ZU 0136 mounting plate) | ZU 0125 |
| Protective hood, aluminum AlMg1, 25 µm anodized (only in conjunction with ZU 0136 mounting plate) | ZU 0157 |
| Protective polyester case, IP 65, protective macrolon panel, complete with mounting kit | ZU 0158 |
| Bracket kit for protective case, brackets hot galvanized, screws stainless steel, wing nuts aluminum anodized (only in conjunction with ZU 0158) | ZU 0220 |
| Further accessories | |
| Power supply/isolator for 24 V AC/DC | WG 20 A2 |
| Repeater power supply for 90 to 253 V AC (optional 24 V AC/DC) | WG 21 A7 |
| Repeater power supply with HART [®] transmission | WG 21 A7 Opt. 470 |
| IS repeater power supply with HART [®] transmission | WG 25 A7 |
| Sensors | |
| InPro [®] 7000 (2-electrode sensor) | 52 000 230 |
| InPro [®] 7001/120 (2-electrode sensor) | 52 000 231 |
| InPro [®] 7001/225 (2-electrode sensor) | 52 000 232 |
| InPro [®] 7002 (2-electrode sensor) | 52 000 233 |
| InPro [®] 7003 (2-electrode sensor) | 52 000 234 |
| InPro [®] 7100 (4-electrode sensor) | 52 000 235 |
| InPro [®] 7104 (4-electrode sensor) | 52 000 236 |

For technical specifications refer to Pg 10-5 and the following.

The InPro[®]7001 sensors can be combined with various housings.

| Options | TAN | Ref. No. |
|---|------------|-----------------|
| Controller function (only in conjunction with Opt. 487) | x | 353 |
| Logbook | x | 354 |
| Concentration determination H ₂ SO ₄ , HCl, HNO ₃ , NaOH, NaCl | x | 359 |
| Concentration determination to customer requirements | | 360 |
| TC for solutions to customer requirements | | 361 |
| TC for ultrapure water with traces of impurity NaOH, NaCl, HCl, NH ₃ | x | 392 |
| Key-lockable cover | | 432 |
| Measurement recorder | x | 448 |
| Current characteristic via enterable table | x | 449 |
| HART [®] communication | | 467 |
| Language selection German, English, French, Italian and Swedish instead of German, English, French, Italian and Spanish | | 477 |
| Second current output (passive) | x | 487 |
| Concentration table user-defined | x | 502 |

10 Specifications

| | | |
|---|---|--|
| Inputs EEx ia IIC | 1 input for conductivity sensor either 4-electrode or 2-electrode sensors | |
| | 1 input for Pt 100 / Pt 1000 / NTC 30 kΩ / Ni 100 2 or 3-wire connection | |
| Ranges | Conductivity | 0.000 μS/cm to 2000 mS/cm |
| | Concentration | 0.0 to 200 % by wt |
| | Resistivity (1/κ) | 0.5 Ω·cm to 1 MΩ·cm |
| | Temperature | -50.0 to +250.0 °C |
| | with NTC 30 kΩ | -20.0 to +130.0 °C |
| | with Ni 100 | -50.0 to +180.0 °C |
| Display | Graphic LCD, 240 x 64 matrix | |
| | Main display | character height approx. 20 mm |
| | Secondary display | character height approx. 6 mm |
| | Dialog display | 7 lines, character height approx. 4 mm |
| Display options | <u>Main display:</u> | <u>Secondary display:</u> |
| | Conductivity | Conductivity [mS/cm] |
| | Resistivity (1/κ) | Resistivity (1/κ) [Ω·cm] |
| | Concentration | Concentration [% by wt] |
| | Temperature | Temperature [°C] |
| | Time | Time [h,min] |
| | | Date [d,m,y] |
| | | Current output 1 [mA] |
| | | Current output 2 [mA] |
| | | Man. temperature [°C] |
| | | Controller output [%] |
| | | Controller setpoint X _w |
| 2-channel measurement recorder * (Option 448) | Graphic representation of two process variables in the display user-defined for conductivity, concentration, Ω·cm, °C, output 1, output 2, Span and time base definable, Recording of: Snapshot, min, max or mean value, 500 measurement points with time and date | |
| Languages * | German, English, French, Italian, Spanish Option 477: Swedish instead of Spanish | |
| Conductivity input | For 2-electrode or 4-electrode sensors | |
| Display range | Conductivity | 0.000 μS/cm to 1.999 S/cm |
| | Resistivity | 0.5 Ω·cm to 999 MΩ·cm |
| | Concentration | 0.00 to 200.0 % by wt |
| Measurement range | 0.001 mS · c to 1000 mS · c (c = 0.0050 to 200.0 cm ⁻¹) | |
| Cond measurement error | < 1 % meas. value ± 2 counts | |
| Resolution | 0.000 μS/cm | c = 0.0050 to 0.1199 cm ⁻¹ |
| | 0.00 μS/cm | c = 0.1200 to 1.199 cm ⁻¹ |
| | 0.0 μS/cm | c = 1.200 to 11.99 cm ⁻¹ |
| | 0.000 mS/cm | c = 12.00 to 119.9 cm ⁻¹ |
| | 0.00 mS/cm | c = 120.0 to 200.0 cm ⁻¹ |
| Concentration determination (Options 359, 360, 502) | Calculation and display of the concentration [% by wt] from the measured conductivity and temperature values for specified substance solutions (see tables on Pg 10-4) Option 360: Customer-specific tables on request Option 502: Concentration table user-defined | |

* User-defined

| | |
|---|--|
| Sensor standardization | Operating modes * <ul style="list-style-type: none"> • Automatic by cell constant determination with NaCl or KCl solution • Entry of individual conductivity values for cell constant determination • Direct entry of cell constant • Sample calibration |
| Adm. cell constant | 0.0050 to 200.0 cm ⁻¹ |
| Sensor monitoring | Sensocheck [®] : Polarization detection and monitoring of cable capacitance (can be switched off) |
| Temperature input | Pt 100 / Pt 1000 / Ni 100 / NTC 30 kΩ 2 or 3-wire connection |
| Range | -50 to +250 °C; with Ni 100: -50 to +180 °C; with NTC 30 kΩ: -20 to +130°C |
| Temp measuring error (± 1 count) | < 0.2 % meas. value + 0.3 K |
| Temperature compensation media-dependent * | Automatic with Pt 100 / Pt 1000 / NTC 30 kΩ / Ni 100 Manual -50.0 to +250.0 °C Operating modes: <ul style="list-style-type: none"> • none • linear 0.00 to 20.00 %, reference temp user-defined • natural waters to EN 27888 • optional <ul style="list-style-type: none"> - ultrapure water with traces of impurity NaOH, NaCl, HCl, NH₃ (Option 392) - to customer requirements (Option 361) |
| Output 1 * (current loop) | 4 ... to 20 mA (22 mA), floating, supply unit required definable for conductivity, resistivity, concentration, temp Current characteristic definable: linear, bilinear, trilinear, function or as table (with Option 449) |
| Start/end of scale * | As desired within range |
| Spans * | Conductivity ≥ 0.20 μS/cm, min. 20 % full scale Resistivity ≥ 100 Ω·cm, min. 20 % full scale Concentration 1.0 to 200 % by wt Temperature 10.0 to 300.0 °C |
| Output current error | < 0.3 % meas. value + 20 μA |
| Current source function | 4.00 mA to 22.00 mA |
| Supply voltage EEx ib IIC | 16 to 30 V; I _{max} = 100 mA; P _{max} = 0.8 W |
| Output 2 (passive) * (Option 487) | 0(4) ... to 20 mA (22 mA), floating, supply unit required definable for conductivity, resistivity, concentration, temp, or as an analog controller output |
| Start/end of scale * | As desired within range |
| Spans * | Conductivity ≥ 0.20 μS/cm, min. 20 % full scale Resistivity ≥ 100 Ω·cm, min. 20 % full scale Concentration 1.0 to 200 % by wt Temperature 10.0 to 300.0 °C |
| Output current error | < 0.3 % meas. value + 20 μA |
| Current source function | 0.00 mA to 22.00 mA |
| Supply voltage EEx ib IIC | 1.3 to 30 V; I _{max} = 100 mA; P _{max} = 0.8 W |
| Defined as switching output Loadability (EEx ib IIC) | Switching controller, limit, or alarm output DC V _{max} = 30 V; I _{max} = 100 mA; P _{max} = 0.8 W, voltage drop: < 1.3 V |

* User-defined

| | | |
|--|---|--|
| HART® Communication (Option 467) | Digital communication by FSK** modulation of loop current (output 1 only), HART protocol (Version 5.2) point-to-point connection or Multidrop (bus) | |
| PI controller (Option 353) | Quasi continuous switching controller via output 2 (Option 487) Pulse duration or pulse frequency definable or continuous controller via output 2 (Option 487) definable for S/cm and °C | |
| Clock | Real-time clock with date, self-contained, date format user-definable | |
| Records | For quality management documentation to ISO 9000. | |
| Logbook (Option 354) | Recording of | function activations, appearance and disappearance of warning and failure messages, with date and time |
| | Storage capacity | 200 entries available |
| Unit self-test | Test of RAM, EPROM, EEPROM, display and keypad | |
| Calibration record | All relevant data of the last calibration for documentation to GMP | |
| Data retention in case of power failure | Parameters and factory settings | > 10 years (EEPROM) |
| | Logbook, cal record | > 1 year (lithium battery) |
| | Clock (reserve power) | > 1 year (lithium battery) |
| | No battery replacement required according to NAMUR NE 32 | |
| Explosion protection | II 2 (1) G EEx ib [ia] IIC T6 PTB 00 ATEX 2185 | |
| EMC | EN 61326 | / VDE 0843 Part 20: 1998-01 |
| | EN 61326 /A1 | / VDE 0843 Part 20/A1:1999-05 |
| | Interference immunity to NAMUR EMC recommendation for process and laboratory control equipment | |
| Ambient temperature | Operation *** | -20 to +50 °C |
| | Transport and storage | -20 to +70 °C |
| Enclosure | Case with separate terminal compartment, suitable for outdoor mounting Material: acrylonitrile butadiene styrene, Front: polyester Ingress protection: IP 65 | |
| Cable glands | Metric cable glands | |
| Dimensions | See dimension drawing | |
| Weight | Approx. 1.5 kg | |

* User-defined

** Frequency shift keying

*** At ambient temperatures below 0 °C the readability of the display may be reduced. This does not impair the unit functions.

Concentration ranges

| Substance | Concentration ranges | | | |
|----------------------------------|----------------------------------|-----------------------------|----------------------------|---------------|
| HNO ₃ | 0 to 30 -20 to +50 | 35 to 96 -20 to +50 | | % by wt °C |
| HCl | 0 to 18 -20 to +50 | 22 to 39 -20 to +50 | | % by wt °C |
| H ₂ SO ₄ * | 0 to 30 -17.8 to +110 | 32 to 84 -17.8 to +115.6 | 92 to 99 -17.8 to +15.6 | % by wt °C |
| NaOH ** | 0 to 14 0 to 100 | 18 to 50 0 to 100 | | % by wt °C |
| NaCl | 0 to 26 (saturation) 0 to 100 | | | % by wt °C |

* Range limits based on 27 °C.

** Range limits based on 25 °C.

Sensors

InPro[®] 7000

(2-electrode sensor)

| | |
|-------------------|--|
| Cell constant | Approx. 0.1 cm ⁻¹ (exact value printed on rating plate) |
| Range | 0.02 to 2000 µS/cm |
| Material | Body PVDF Electrodes titanium |
| Max. temperature | 100 °C |
| Max. pressure | 34 bars (25°) |
| Temperature probe | Pt 1000 (IEC Class A) |
| Dimensions | See dimension drawing Fig. 10-1 |

InPro[®] 7001

(2-electrode sensor)

| | |
|-------------------|--|
| Cell constant | Approx. 0.1 cm ⁻¹ (exact value printed on rating plate) |
| Range | 0.02 to 200 µS/cm |
| Material | Body stainless steel 1.4404 / AISI 316L Electrodes stainless steel 1.4404 / AISI 316L |
| Max. temperature | 100 °C |
| Max. pressure | 14 bars (25°) |
| Temperature probe | Pt 1000 (IEC Class A) |
| Dimensions | See dimension drawing Fig. 10-2 |

InPro[®] 7002 / 7003

(2-electrode sensor)

| | |
|-------------------|--|
| Cell constant | Approx. 0.1 cm ⁻¹ (exact value printed on rating plate) |
| Range | 0.02 to 1000 µS/cm |
| Material | Body stainless steel 1.4404 / AISI 316L Electrodes stainless steel 1.4404 / AISI 316L |
| Max. temperature | 100 °C |
| Max. pressure | 14 bars (25°) |
| Temperature probe | Pt 1000 (IEC Class A) |
| Dimensions | See dimension drawing Fig. 10-3 |

InPro[®] 7001 and InPro[®] 7002 / 7003 sensors are steam-sterilizable up to 135 °C.

InPro® 7100

(4-electrode sensor)

| | |
|-------------------|--|
| Cell constant | Approx. 0.6 cm ⁻¹ (Exact value printed on rating plate) |
| Range | Approx. 10 µS/cm to 300 mS/cm |
| Material | Body CPVC Electrodes stainless steel 1.4404 / AISI 316L |
| Max. temperature | 80 °C |
| Max. pressure | 7 bars (25 °C) |
| Temperature probe | Pt 1000 (IEC Class A) |
| Dimensions | See dimension drawing Fig. 10-4 |

InPro® 7104

(4-electrode sensor)

| | |
|-------------------|--|
| Cell constant | Approx. 0.6 cm ⁻¹ (Exact value printed on rating plate) |
| Range | Approx. 10 µS/cm to 300 mS/cm |
| Material | Body PVDF Electrodes stainless steel 1.4404 / AISI 316L |
| Max. temperature | 120 °C |
| Max. pressure | 14 bars (25 °C) |
| Temperature probe | Pt 1000 (IEC Class A) |
| Dimensions | See dimension drawing Fig. 10-4 |

Fig. 10-1 Dimensions InPro® 7000

Fig. 10-2 Dimensions InPro® 7001

Fig. 10-3 Dimensions InPro® 7002 / 7003

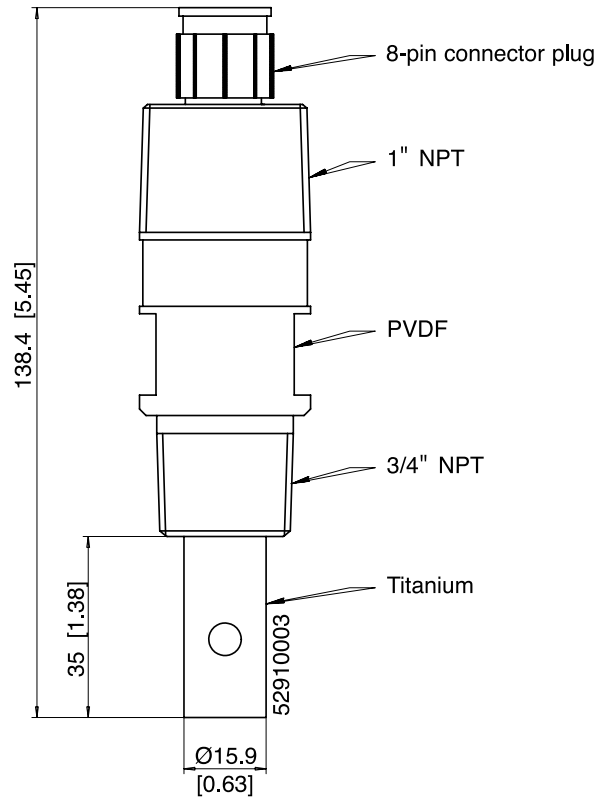

Figure 10-1

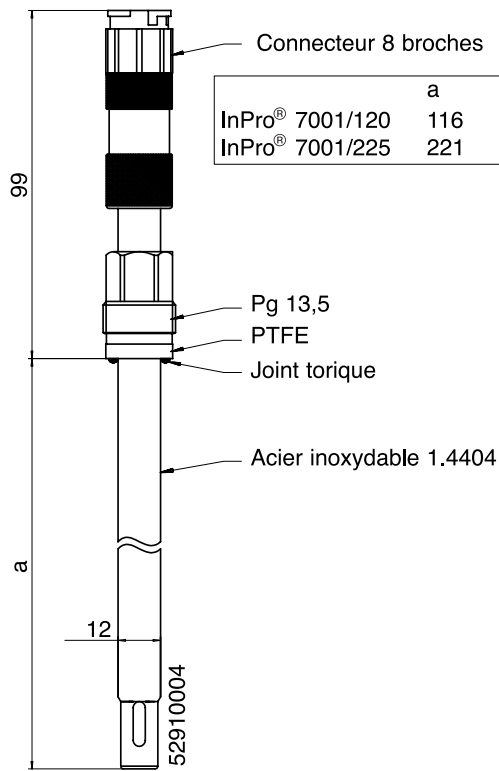

Figure 10-2

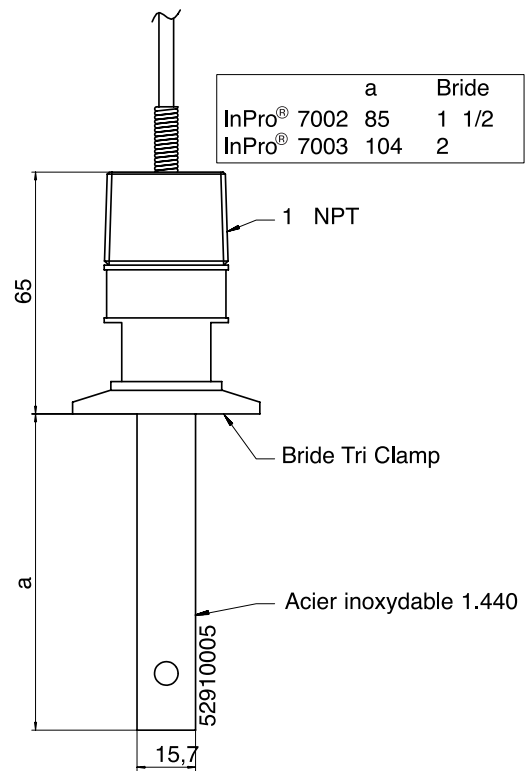

Figure 10-3

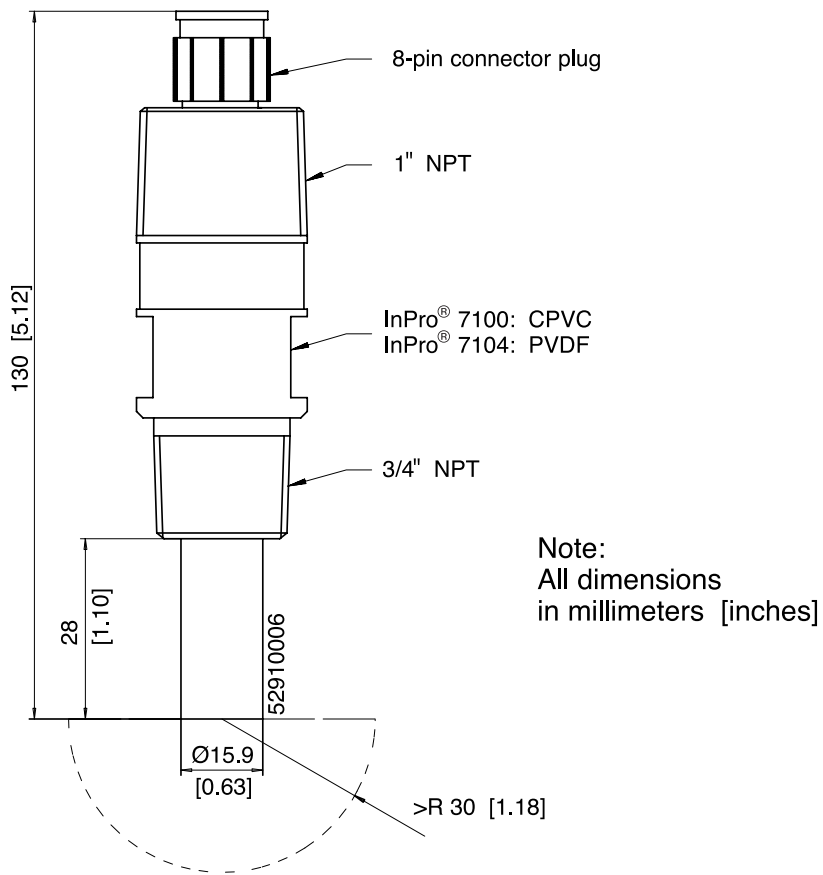

Fig. 10-4 Dimensions InPro[®] 7100 / 7104

11 Concentration curves

On the following pages the conductivity curves are provided for the five substances in dependency on the substance concentration and the process temperature.

- The concentration curves of many substances show a maximum. This means that if the substance concentration continues to increase and the temperature remains constant, the conductivity will drop.
- The curve is temperature-dependent.
- For sulfuric acid, the position of the maximum concentration shifts in dependence on the temperature.
- Near the maximum (or near the minimum as for sulfur) the curve is so flat that the conductivity hardly changes over a large concentration range.

This means that practical concentration determination is only possible in some areas:

- Concentration calculation is not possible in the shaded areas of the concentration curves.
- Due to the ambiguity of the curves (the same conductivity may correspond to several concentration values), the measuring range of the concentration must be defined.

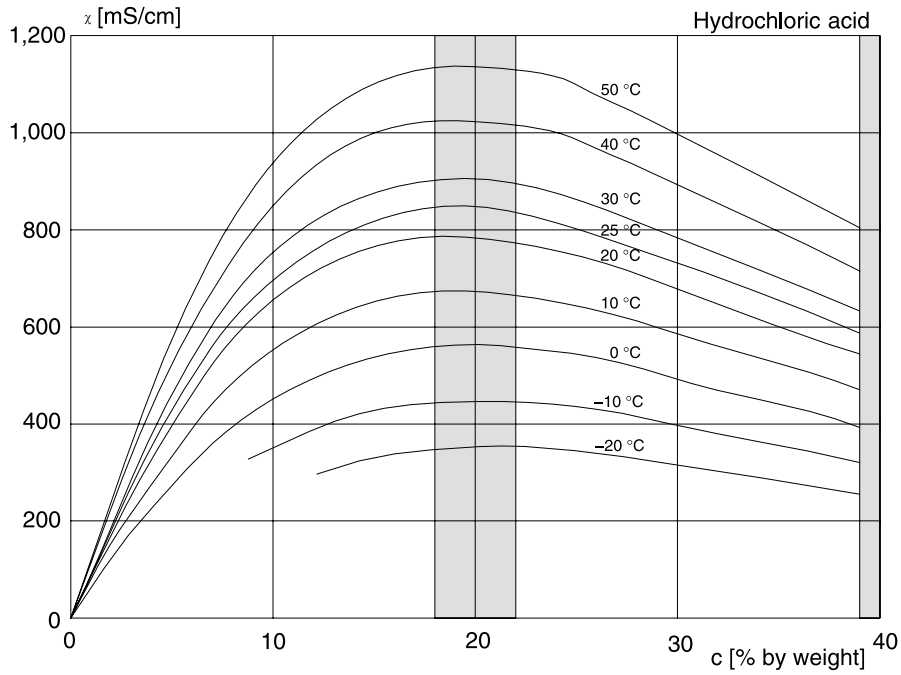

Fig. 11-1 Conductivity in dependence on substance concentration and process temperature for hydrochloric acid (HCl), Source: Haase/Sauermann/Dücker; Z. phys. Chem. New Edition, Vol. 47 (1965)

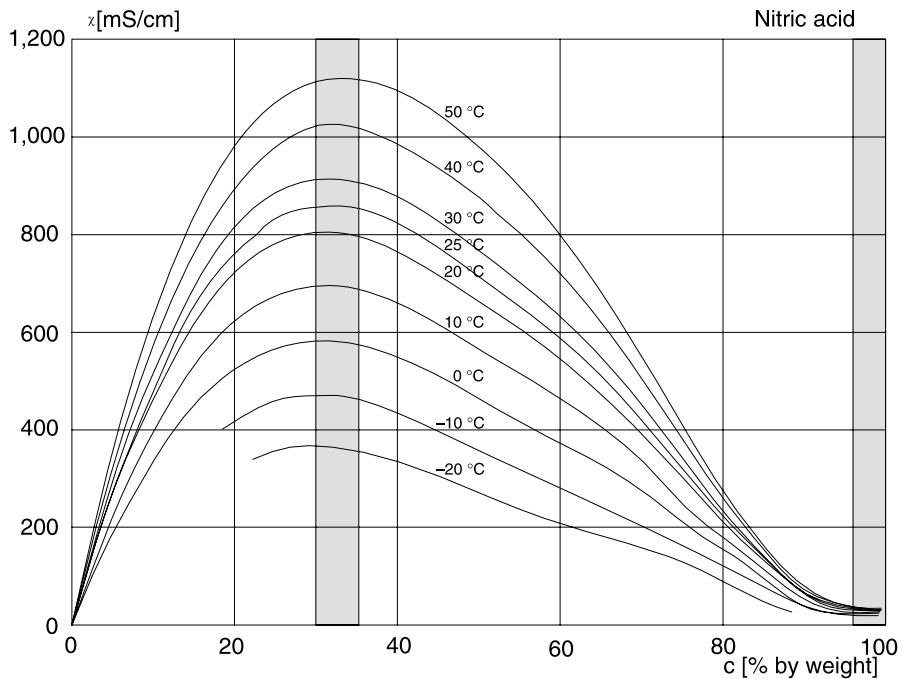

Fig. 11-2 Conductivity in dependence on substance concentration and process temperature for nitric acid (HNO₃), Source: Haase/Sauermann/Dücker; Z. phys. Chem. New Edition, Vol. 46 (1965)

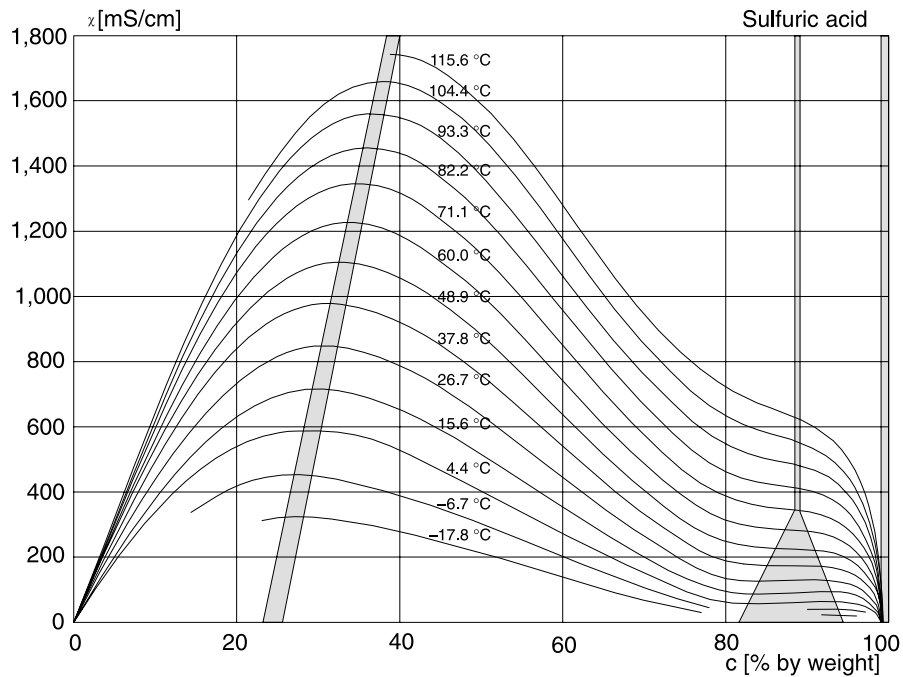

Fig. 11-3 Conductivity in dependence on substance concentration and process temperature for sulfuric acid (H_2SO_4), Source: Darling; Journal of Chemical and Engineering Data; Vol. 9 No. 3, July 1964

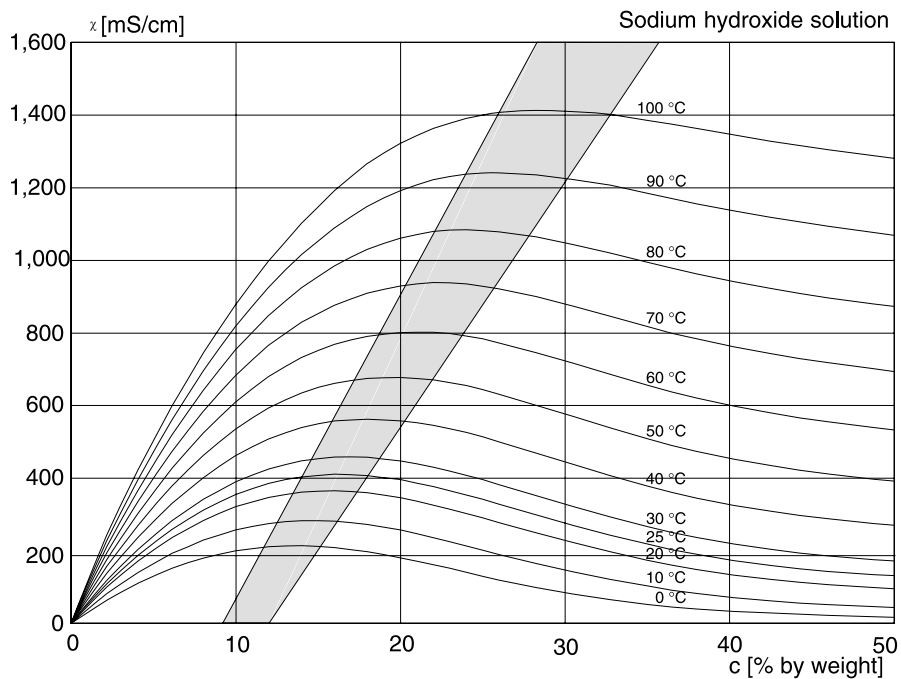

Fig. 11-4 Conductivity in dependence on substance concentration and process temperature for sodium hydroxide solution (NaOH)

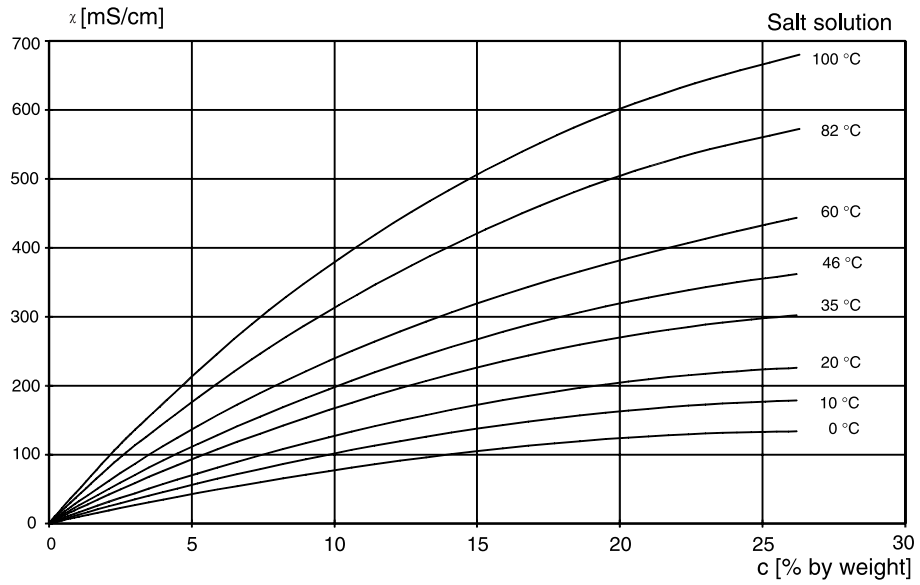

Fig. 11-5 Conductivity in dependence on substance concentration and process temperature for salt solution (NaCl)

12 Calibration solutions

Potassium chloride solutions Electrical conductivity in mS/cm

| Temperature [°C] | Concentration | | |
|---------------------|---------------|-----------|---------|
| | 0.01 mol/l | 0.1 mol/l | 1 mol/l |
| 0 | 0.776 | 7.15 | 65.41 |
| 5 | 0.896 | 8.22 | 74.14 |
| 10 | 1.020 | 9.33 | 83.19 |
| 15 | 1.147 | 10.48 | 92.52 |
| 16 | 1.173 | 10.72 | 94.41 |
| 17 | 1.199 | 10.95 | 96.31 |
| 18 | 1.225 | 11.19 | 98.22 |
| 19 | 1.251 | 11.43 | 100.14 |
| 20 | 1.278 | 11.67 | 102.07 |
| 21 | 1.305 | 11.91 | 104.00 |
| 22 | 1.332 | 12.15 | 105.94 |
| 23 | 1.359 | 12.39 | 107.89 |
| 24 | 1.386 | 12.64 | 109.84 |
| 25 | 1.413 | 12.88 | 111.80 |
| 26 | 1.441 | 13.13 | 113.77 |
| 27 | 1.468 | 13.37 | 115.74 |
| 28 | 1.496 | 13.62 | |
| 29 | 1.524 | 13.87 | |
| 30 | 1.552 | 14.12 | |
| 31 | 1.581 | 14.37 | |
| 32 | 1.609 | 14.62 | |
| 33 | 1.638 | 14.88 | |
| 34 | 1.667 | 15.13 | |
| 35 | 1.696 | 15.39 | |
| 36 | | 15.64 | |

Data source:

K. H. Hellwege (Editor), H. Landolt, R. Börnstein: Zahlenwerte und Funktionen ..., volume 2, part. volume 6

Sodium chloride solutions

Electrical conductivity in mS/cm

| Temperature [°C] | Concentration | | |
|---------------------|---------------|-------------|------------|
| | 0.01 mol/l** | 0.1 mol/l** | Saturated* |
| 0 | 0.631 | 5.786 | 134.5 |
| 1 | 0.651 | 5.965 | 138.6 |
| 2 | 0.671 | 6.145 | 142.7 |
| 3 | 0.692 | 6.327 | 146.9 |
| 4 | 0.712 | 6.510 | 151.2 |
| 5 | 0.733 | 6.695 | 155.5 |
| 6 | 0.754 | 6.881 | 159.9 |
| 7 | 0.775 | 7.068 | 164.3 |
| 8 | 0.796 | 7.257 | 168.8 |
| 9 | 0.818 | 7.447 | 173.4 |
| 10 | 0.839 | 7.638 | 177.9 |
| 11 | 0.861 | 7.831 | 182.6 |
| 12 | 0.883 | 8.025 | 187.2 |
| 13 | 0.905 | 8.221 | 191.9 |
| 14 | 0.927 | 8.418 | 196.7 |
| 15 | 0.950 | 8.617 | 201.5 |
| 16 | 0.972 | 8.816 | 206.3 |
| 17 | 0.995 | 9.018 | 211.2 |
| 18 | 1.018 | 9.221 | 216.1 |
| 19 | 1.041 | 9.452 | 221.0 |
| 20 | 1.064 | 9.631 | 226.0 |
| 21 | 1.087 | 9.839 | 231.0 |
| 22 | 1.111 | 10.047 | 236.1 |
| 23 | 1.135 | 10.258 | 241.1 |
| 24 | 1.159 | 10.469 | 246.2 |
| 25 | 1.183 | 10.683 | 251.3 |
| 26 | 1.207 | 10.898 | 256.5 |
| 27 | 1.232 | 11.114 | 261.6 |
| 28 | 1.256 | 11.332 | 266.9 |
| 29 | 1.281 | 11.552 | 272.1 |
| 30 | 1.306 | 11.773 | 277.4 |
| 31 | 1.331 | 11.995 | 282.7 |
| 32 | 1.357 | 12.220 | 288.0 |
| 33 | 1.382 | 12.445 | 293.3 |
| 34 | 1.408 | 12.673 | 298.7 |
| 35 | 1.434 | 12.902 | 304.1 |
| 36 | 1.460 | 13.132 | 309.5 |

Data sources:

* K. H. Hellwege (Editor), H. Landolt, R. Börnstein: Zahlenwerte und Funktionen ..., volume 2, part. volume 6

** Test solutions calculated according to DIN IEC 746-3

13 Glossary

| | |
|-------------------------------|--|
| 3-wire connection | Connection of the Pt 100/Pt 1000 temperature probe with a (third) sense line for compensating for the supply lead resistances. Required for exact temperature measurement with long wires. |
| Administrator level | “adm”, menu level of the Parameter Setting menu. All device settings and the passcodes can be defined. |
| Administrator passcode | Protects access to the Administrator level. Can be set at the Administrator level. |
| Alarm limit | For each process variable, you can define high and low warning and failure limits. The alarm can be activated individually for each variable. If an alarm limit is exceeded, an error message appears. |
| Alarm processing | In the alarm processing function, delay times can be set for the NAMUR Failure, Warning and Functional Check signals. The delay times are treated separately. Alarms can be output as 22 mA signals via outputs 1 and 2 (see Alarm processing, Pg 4-24). |
| cal | Menu key for the Calibration menu |
| Calibration menu | For calibrating the Transmitter |
| Calibration method | Four different methods are available for calibration: Automatic by determining the cell constant with NaCl or KCl solution, entry of individual conductivity values, direct entry of cell constant, sample calibration. |
| Calibration passcode | Protects access to calibration. Can be set or disabled at the Administrator level. |
| Calibration record | The calibration record shows all relevant data of the last calibration for documentation to GMP. |
| Calibration solution | See Standard calibration solution |
| Controlled variable | User-defined variable that acts on the controller. |
| Cursor keys | ◀ and ▶ , serve to select entry positions or digits during number entry. |
| diag | Menu key for the Diagnostics menu |
| Diagnostics menu | Display of all relevant information on the device status. |
| enter | Key for confirming entries |

| | |
|-----------------------------|---|
| Failure | Failure is a NAMUR signal. The limits are set in the Alarm Settings menu. Failure means that the equipment no longer operates properly or that a process parameter has reached a critical value. |
| Feed time alarm | Monitors the time during which the controller output is at 100 %. |
| Functional check | Functional check is a NAMUR signal. This signal is active during parameter setting, calibration and maintenance (see Alarm processing, Pg 4-24). |
| GMP | Good Manufacturing Practice: Rules for performance and documentation of measurements. |
| HART® | Digital communication by superimposing digital signals on the loop current |
| Information display | Information text for operator guidance or indication of device status. Marked with i . |
| Language selection | In the Parameter Setting menu, you can select the user interface language: The language can be selected without entering a passcode. |
| Limit contact | Is controlled by a user-definable process variable. The limit contact is activated if the measured value falls below or exceeds an alarm limit, depending on the user-defined effective direction. |
| Logbook | The logbook shows the last 200 events with date and time, e.g. calibrations, warning and failure messages, power failure etc. This permits quality management documentation to ISO 9000. |
| Main display | Large measured-value display in the measuring mode. You can select which process variable is to be displayed. The process variable of the main display is shown in the menus in the upper right corner. |
| maint | Menu key for the Maintenance menu |
| Maintenance menu | The Maintenance menu provides all functions for sensor maintenance and adjustment of connected devices. |
| Maintenance passcode | Protects access to Maintenance. Can be set or disabled at the Administrator level. |
| Manipulated variable | Output variable of the controller, controls output 2. |
| meas | Menu key. Pressing meas allows return to measuring mode from all other menus. |

| | |
|-------------------------------|---|
| Measurement recorder | Two-channel recorder for optical display of the process development on the system display. One process variable can be assigned to each channel. |
| Measuring mode | When no menu function is activated, the Transmitter is in measuring mode. The selected measured value is displayed. You can always return to the measuring mode by pressing meas . |
| Menu | Pressing a menu key (cal, diag, maint, par), gives access to a menu from which you can select the corresponding functions. |
| Menu level | The menu is divided into several menu levels. You can switch between the different levels by pressing the corresponding menu key or a cursor key (◀ or ▶). |
| Message list | The message list shows the number of currently activated messages and the individual warning or failure messages in plain text. |
| NAMUR | German committee for measurement and control standards in the chemical industry |
| NAMUR signals | Failure, warning and functional check are NAMUR signals. They can be assigned to outputs 1 and 2 as 22 mA signals. The limits for failure and warning are set in the Alarm Settings menu. |
| Operator level | “opl”, menu level of the Parameter Setting menu. You can edit the device settings that have been enabled at the Administrator level. |
| Operator passcode | Protects access to the Operator level. Can be set or disabled at the Administrator level. |
| par | Menu key for the Parameter Setting menu. |
| Parameter Setting menu | The Parameter Setting menu is divided into three submenus: Viewing level (view), Operator level (opl) and Administrator level (adm). |
| Passcode protection | Access to the Calibration, Maintenance, Operator and Administrator levels is protected by passcodes. The passcodes can be defined or disabled at the Administrator level. |
| Pulse suppression | To increase immunity to interference, a disconnectable input filter suppresses transient interference pulses while slow changes of the measured value are detected immediately. |
| Recorder | See Measurement recorder. |

| | |
|---------------------------------------|--|
| Scrolling key | ▲ and ▼ : Keys for selecting menu lines or entering numbers. |
| Secondary display | Two small displays located below the main display in measuring mode. The process variables to be displayed can be selected using ▲ / ▼ and ◀ / ▶ . |
| Standard calibration solution | Calibration solution stored in the Transmitter KCl 0.01 mol/l, 0.1 mol/l, 1 mol/l NaCl 0.01 mol/l, 0.1 mol/l, saturated (see Chapter 12) |
| Tag number | Can be defined to identify the Transmitter and can be displayed in the diag menu or read out via the interface. For HART [®] transmission, the first 8 characters are used as "TAG". |
| TAN | Transaction number for later installation of software options. |
| Temperature coefficient | With temperature compensation activated, the measured value is calculated to the value at the reference temperature using the temperature coefficient. |
| Temperature compensation | Calculates the measured value for a reference temperature. |
| Viewing level | "view", menu level of the Parameter Setting menu. Display of all device settings, however no editing possible. |
| Warning (maintenance required) | Alarm message, means that the equipment is still operating properly but should be serviced, or that process parameters have reached a value requiring intervention. |

14 Index

3-way mixing valve, 4-21

3-wire connection, Explanation, 13-1

4-electrode sensor
Wiring, 2-10

A

Accessories, 9-1

Administrator level, 4-2
Explanation, 13-1

Administrator passcode, 4-29
Explanation, 13-1

Alarm contact, 4-17

Alarm limit, Explanation, 13-1

Alarm processing, 4-24
Explanation, 13-1

Alarm settings, 4-23

Assembly, 1-1

ATEX Certificate, XII

Automatic calibration, 5-4

B

Bracket kit, 1-1

C

cal, Explanation, 13-1

Calibration, 5-1
Automatic, 5-4
Data entry of premeasured sensors, 5-7
Freeze outputs, 5-4, 5-5, 5-7
Manual entry of conductivity, 5-5
Monitoring functions, 5-1
Sampling, 5-7

Calibration menu, 5-2
Explanation, 13-1

Calibration method, Explanation, 13-1

Calibration passcode, Explanation, 13-1

Calibration record, Explanation, 13-1

Calibration solution
Explanation, 13-1
Setting, 4-6
Temperature tables, 12-1

Cell constant alarm, 4-23, 5-2

Cleaning, 1-6

Clock, Setting, 4-26

Concentration
Parameter setting, 4-6

Concentration alarm, 4-23

Concentration curve
Hydrochloric acid, 11-2
Nitric acid, 11-2
Salt solution, 11-4
Sodium hydroxide solution, 11-3
Sulphuric acid, 11-3

Concentration determination
Chart, 4-7
Conditions, 4-6
Not in use, 4-8
Preset substances, 4-7

Concentration ranges, 10-4

Concentration table, 10-4

Conductivity alarm, 4-23

Control beginning, 4-18

Control end, 4-19

Controlled variable, Explanation, 13-1

Controller, 4-17
Control characteristic, 4-18
Controlled variable, 4-17
Manipulated variable, 4-19
Manual, 7-3
Parameter setting, Error
messages, 4-22
Pulse frequency controller, 4-20

- Pulse length controller, 4-20
- Corner point, 4-19
 - Bilinear output curve, 4-12
 - Trilinear output curve, 4-12
- Current output
 - Falling curve, 4-11
 - Output curve, 4-11
 - Parameter setting, Error messages, 4-14
 - Span, 4-11, 4-12, 4-13
- Current output 1, 4-10
- Current output 2, 4-15
- Current source function, 7-2
- Cursor keys, Explanation, 13-1
- D**
- Date format, 4-26
- Declaration of Conformity, XI
- Device description, 6-2
- Device diagnostics, 4-27, 6-3
- diag, Explanation, 13-1
- Diagnostics menu, Explanation, 13-1
- Display, Viewing angle, 4-4
- E**
- EC Declaration of Conformity, XI
- EC-Type-Examination Certificate, XII
- Effective direction, 4-16
- enter, Explanation, 13-1
- Error messages, 8-1
- F**
- Factory setting, reset to, 4-3
- Failure, Explanation, 13-2
- Feed time alarm, 4-18, 4-22, 4-23
 - Explanation, 13-2
- Functional check, Explanation, 13-2
- G**
- Glossary, 13-1
- GMP, Explanation, 13-2
- H**
- HART communication, 4-25
- Hysteresis, 4-16
- I**
- InPro 7000 sensor
 - Dimension drawing, 10-7
 - Specifications, 10-5
 - Wiring, 2-5
- InPro 7001 sensor
 - Dimension drawing, 10-7
 - Specifications, 10-5
 - Wiring, 2-6
- InPro 7002/7003 sensor
 - Dimension drawing, 10-7
 - Specifications, 10-5
 - Wiring, 2-7
- InPro 7100 sensor
 - Dimension drawing, 10-8
 - Specifications, 10-6
 - Wiring, 2-9
- InPro 7104 sensor
 - Dimension drawing, 10-8
 - Specifications, 10-6
 - Wiring, 2-9
- Input filter, 4-4
- Installation, 1-5
- L**
- Language selection, 4-1
- Limit contacts, 4-16
 - Effective direction, 4-16
 - Explanation, 13-2

Hysteresis, 4-16
Logbook, 6-2
Explanation, 13-2

M

Main display, Explanation, 13-2
maint, Explanation, 13-2
Maintenance, 1-6
Maintenance menu, Explanation, 13-2
Maintenance passcode, Explanation, 13-2
Manipulated variable, Explanation, 13-2
Marker setting, 4-2
meas, Explanation, 13-2
Measured value display, 4-3
Measurement point maintenance, 7-1
Measurement recorder, 4-27, 13-3
Average, 4-28
Max Value, 4-28
Min Value, 4-28
Snapshot, 4-28
Measuring mode, 3-2
Explanation, 13-3
Memory test, 4-27
Menu level, Explanation, 13-3
Menu operation, 3-6
Keypad assignment, 3-7
Menu structure, 3-5
Menu, Explanation, 13-3
Message list, 6-1, 7-1
Explanation, 13-3
Mounting plate, 1-1

N

NAMUR signals, 4-24
Explanation, 13-3
NAMUR, Explanation, 13-3

Neutral zone, 4-19
Note, 4-27

O

Operator level, 4-2
Explanation, 13-3
Operator passcode, Explanation, 13-3
Options, 9-2
Output 2, 4-15
Alarm contact, 4-17
Typical wiring, 2-4
Wash contact, 4-22
Output curve
Bilinear, 4-12
Function, 4-12
Linear, 4-11
Logarithmic, 4-13
Trilinear, 4-12
User-defined chart, 4-13

P

par, Explanation, 13-3
Parameter setting, 4-5
Administrator level, 4-2
Marker setting, 4-2
Factory setting, 4-3
Language selection, 4-1
Operator level, 4-2
Viewing level, 4-2
Parameter Setting menu, Explanation, 13-3
Passcode entry, 4-29
Passcode protection, Explanation, 13-3
Passcode, factory set, 4-30
Product line, 9-1
Proper use, X
Protective case, 1-1
Protective hood, 1-1

Pulse suppression, 13-3

R

Recorder, 13-3

Release of options, 4-30

Reset time, 4-19

Resistance measurement, 7-2

S

Scrolling key, Explanation, 13-4

Secondary display

Explanation, 13-4

Process variables, 4-3

Self test, 4-27

Sensocheck, 4-10

Sensor monitoring, 2-2

Sensor selection, 4-8

Sensor type, 4-8

Sensors, 9-1

Setpoint, 4-18

Software retrofitting, 4-30

Span, 4-11

Specifications, 10-1

Standard calibration solution,

Explanation, 13-4

Straightway valve, 4-21

T

Tag note, 4-27

Tag number, 4-27

Explanation, 13-4

TAN, 4-31, 13-4

TC process medium, 4-4

Temperature alarm, 4-23

Temperature coefficient, 13-4

Temperature compensation, 2-3, 13-4

Automatic, 2-3, 4-9

Manual, 4-9

Parameter setting, 4-5

Process medium, 4-4

Temperature detection, 2-2, 4-8

Temperature probe, 4-8

Temperature probe adjustment, 7-2

Terminal assignments, 2-11

Transaction number, 4-31

Type Examination Certificate, XII

U

User interface, 3-1

V

Viewing level

Explanation, 13-4

W

Warning, Explanation, 13-4

Wash contact, 4-22