

METTLER TOLEDO

Operating Instructions

METTLER TOLEDO SQC16

Compact Scales BBA462 / BBK462 Terminal IND469

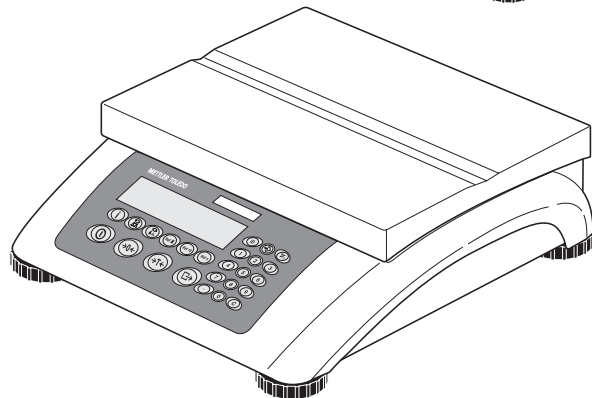
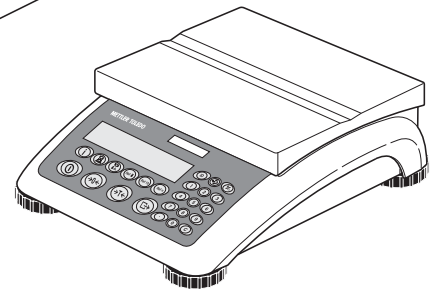
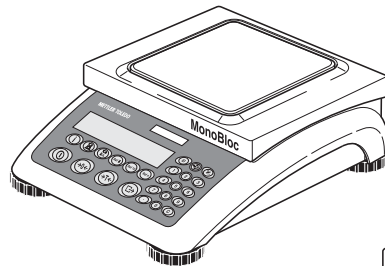

Overview

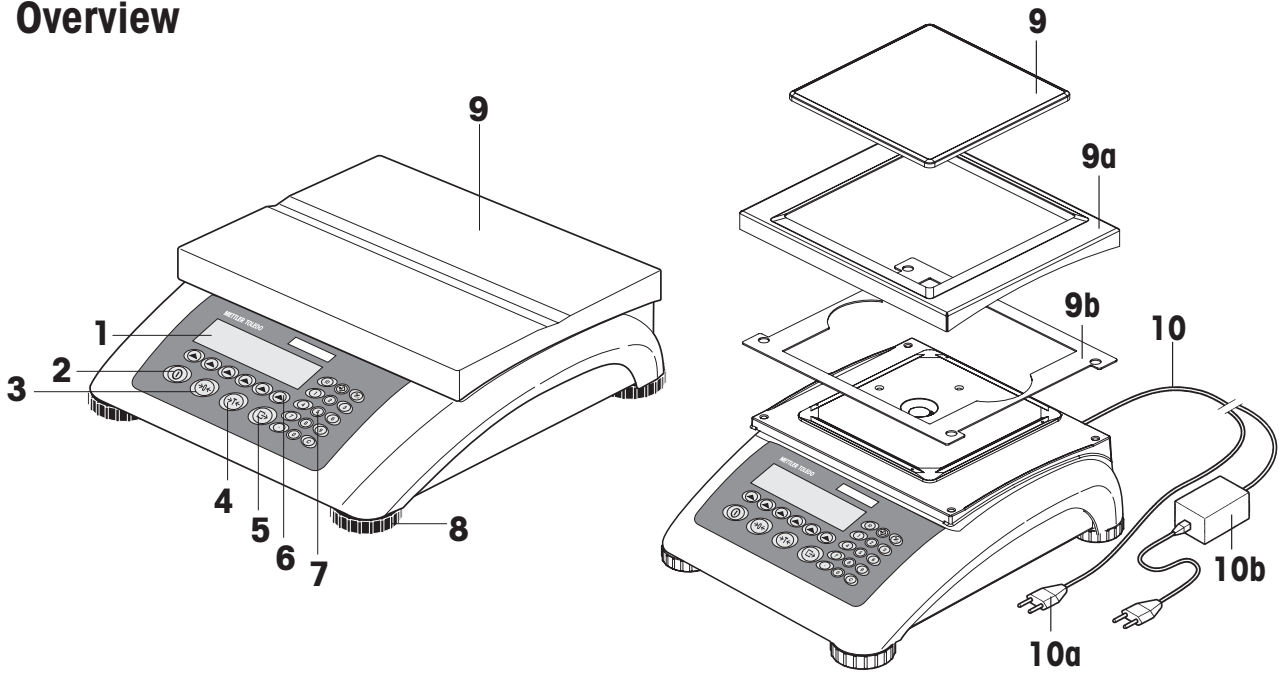

Rear of Scale

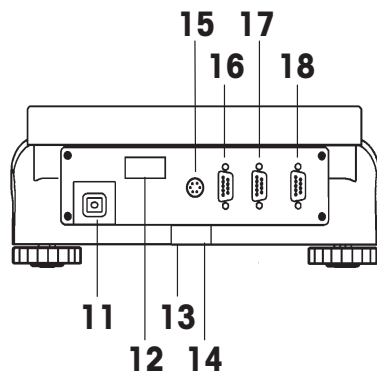

Keypad

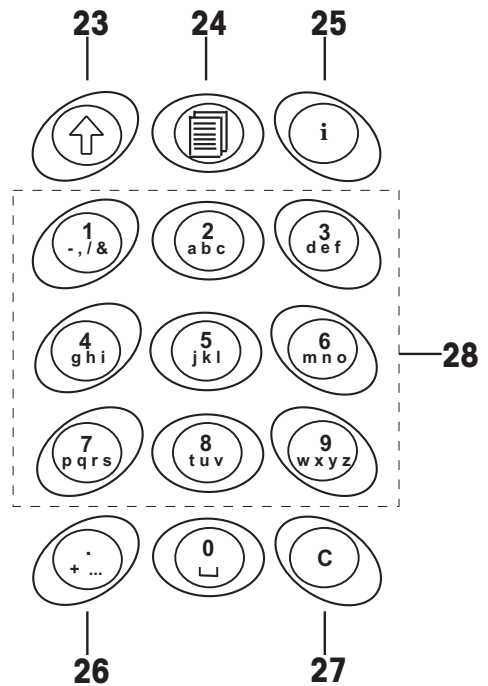

Scale specifications (example)

19	20	21	22
Max1: 3kg	Min1: 20g	e1: 1g	d1: 1g
Max2: 6kg	Min2: 40g	e2: 2g	d2: 2g

Overview

- 1** Display
- 2** On/Off key
- 3** Zero key
- 4** Tare key
- 5** Enter or print key
- 6** Command softkeys (6)
- 7** Keypad
- 8** Adjustable feet
- 9** Weighing pan
 - 9a: wind protector
 - 9b: shield
- 10** Power supply:
 - 10a: power cord (scale w/o battery)
 - 10b: AC adapter (scale with battery)

Rear of scale

- 11** Power supply
- 12** Model plate
- 13** Hole for anti-theft device
- 14** Spirit level (only on certified scales and those with MonoBloc weighing cells)
- 15** PS2 connector for keyboard and/or BCR (Barcode reader)
- 16** COM3 (RS232C interface)
- 17** COM2 (RS232C interface)
- 18** COM1 (RS232C interface)

Scale specifications

- 19** Maximum load
- 20** Minimum load
- 21** Verification scale interval (certified scale)
- 22** Max. resolution

Keypad

- 23** Shift key (ABC→abc→123→ABC ...)
- 24** Database key
- 25** Info key
- 26** Special characters key
- 27** Clear key
- 28** Numeric keys

Contents

Page

1	Setting up the scale	8
1.1	Safety and environment	8
1.2	Positioning and leveling the scale	9
1.3	Connecting to power supply	9
2	Basic functions	10
2.1	Switching on and off and zeroing	10
2.2	Setting date and time	10
2.3	Language settings	11
2.4	Simple weighing	12
2.5	Weighing with tare	13
2.6	Recording weighing results.....	14
3	User setup and password	15
3.1	Defining a user name	15
3.2	Creating a password.....	16
4	Getting to know the SQC16 software	17
5	The SQC16 Application	18
5.1	Overview of article definition	20
5.2	Creating an article for the first time	22
5.3	The database	25
5.3.1	Creating a new article	26
5.3.2	The 'Search' softkey	27
5.3.3	Editing the parameters of an existing article.....	27
5.3.4	Copying the parameters of an existing article to a new article	28
5.3.5	Deleting an article.....	28
5.3.6	Printing the parameters of an article	28
5.4	Sampling of articles	29
5.5	Test series	30
5.6	Taring	31
5.6.1	Manual tare	31
5.6.2	Tare series	32
5.6.3	Bulk tare.....	32
5.7	Density	33
5.8	Printing/Clearing statistics.....	33

Contents

Page

5.9	The System settings	34
5.9.1	Tolerance specifications	36
5.9.2	Global density	36
5.9.3	Sample messages	37
5.9.4	Tare configuration.....	37
5.10	The Function settings.....	38
5.10.1	Violation check.....	39
5.10.2	2 nd Tolerance System	40
5.10.3	Shared Statistics	41
5.10.4	Test.....	41
5.10.5	Supplement	41
5.10.6	Adjust.....	41
5.11	The Report settings.....	42
5.11.1	Statistics and Sample reports	44
5.11.2	Define contents of the report.....	45
5.11.3	\bar{x} -chart (Mean value trace)	48
5.11.4	Marginals	48
5.11.5	Linefeeds	48
5.11.6	A4 Printout.....	49
5.12	Printing summary of database	50
6	Special features of SQC16	51
6.1	Working with barcodes	51
6.2	Individual tare sampling	51
6.2.1	Preweighing and backweighing in two samples	51
6.2.2	Preweighing and backweighing in one sample	53
6.3	Sampling with batch.....	54
6.4	Transfer key	55
7	Vision Setup.....	57
7.1	Overview and operation.....	57
7.2	Calling up the menu and entering the password	58
7.3	Menu overview.....	59
7.3.1	Scale.....	59
7.3.2	SQC16	60
7.3.3	Terminal	61
7.3.4	Communication.....	62
7.3.5	Diagnostics.....	63

Contents

Page

7.4	Scale settings (SCALE)	63
7.4.1	Adjust/calibrate (SCALE → Calibration).....	64
7.4.2	Display resolution and weighing unit (SCALE → Display).....	64
7.4.3	Automatic zero point correction (SCALE → Tare).....	65
7.4.4	Automatic zero point correction (SCALE → Zero).....	65
7.4.5	Automatic save of tare and zero values (SCALE → Restart).....	66
7.4.6	Adaptation to environmental conditions and weighing mode (SCALE → Filter).....	66
7.4.7	Automatic adjustment (SCALE → FACT).....	67
7.4.8	Minimum weight (SCALE → Min Weigh).....	68
7.4.9	Resetting scale to factory default settings (SCALE → Reset).....	69
7.5	SQC16 settings (SQC16)	69
7.5.1	User Login (SQC16 → User Login).....	69
7.5.2	Auto Log Out (SQC16 → Auto Log Out).....	70
7.5.3	Minimum Password Length (SQC16 → Minimum PW Length).....	70
7.5.4	User Setup (SQC16 → User Setup).....	70
7.6	Terminal settings for device (TERMINAL → Device)	71
7.6.1	Language settings (TERMINAL → Device → Language).....	72
7.6.2	Sleep function (TERMINAL → Device → Sleep).....	72
7.6.3	Adjusting the contrast of the display (TERMINAL → Device → Contrast).....	72
7.6.4	Invert (TERMINAL → Device → Invert).....	73
7.6.5	Changing the size of weight display (TERMINAL → Device → Weight display).....	73
7.6.6	Adjusting the date and time (TERMINAL → Device → Date Time).....	73
7.6.7	Adjusting the date and time (TERMINAL → Device → Beep).....	74
7.7	Define supervisor password (TERMINAL → Access)	74
7.8	Reset terminal settings to factory settings (TERMINAL → Reset)	75
7.9	Communication settings (COMMUNICATION)	75
7.9.1	Mode (COMMUNICATION → Mode).....	76
7.9.2	Parameters (COMMUNICATION → Parameters).....	76
7.9.3	Printer type (COMMUNICATION → Printer type).....	77
7.9.4	Header (COMMUNICATION → Define Header).....	77
7.9.5	Add LineFeed (COMMUNICATION → Add LineFeed).....	77
7.9.6	Reset communication (COMMUNICATION → Comx → Reset Com).....	78
7.9.7	PS2 Settings (COMMUNICATION → PS2).....	78
7.10	Diagnostic settings (DIAGNOSTICS)	79
7.10.1	Keyboard (DIAGNOSTICS → Keyboard Test).....	79
7.10.2	Display (DIAGNOSTICS → Display Test).....	80
7.10.3	Serial Number 1 (DIAGNOSTICS → SNR1).....	80
7.10.4	Serial Number 2 (DIAGNOSTICS → SNR2).....	80

Contents

Page

7.10.5	List 1 (DIAGNOSTICS→ List 1).....	81
7.10.6	List 2 (DIAGNOSTICS→ List 2).....	81
7.10.7	Reset All (DIAGNOSTICS→ Reset All)	81
8	Other important information	82
8.1	Error messages in display	82
8.2	Messages on printer.....	83
9	APPENDIX: Tolerance systems.....	86
9.1	Entry of tolerances	86
9.2	Legal tolerance systems	86
9.3	Free tolerance systems with one tolerance	87
9.4	Free tolerance systems with two tolerances.....	87
9.5	Free tolerance systems with three tolerances	87
10	APPENDIX: Optional equipment	88
10.1	LC-I/O Relay Interface.....	88
10.2	Attachment of peripheral devices	89
10.3	Accessories.....	90
11	Technical data.....	91
11.1	General data and delivered items	91
11.1.1	BBA/BBK462	91
11.1.2	IND469	92
11.2	Dimensions.....	93
11.2.1	BBA/BBK462	93
11.2.2	IND469	94
11.3	Interface technical data	94
11.3.1	BBA/BBK462	94
11.3.2	IND469	95
11.4	Interface commands	95
11.4.1	Preconditions.....	95
11.4.2	SICS Command set.....	95
11.5	Table of Geo Values	99
11.5.1	GEO VALUES 3000e, OIML Class III (European Countries)	99
11.5.2	GEO VALUES 6000e/7500e OIML Class III (Height ≤ 1000 m)	100
11.6	Declaration of Conformity	101

1 Setting up the scale

Please read through these operating instructions carefully and adhere to them at all times. If you discover that materials are missing or that the wrong ones have been supplied, or if you have any other problems with your scale, please refer to the dealer and salesperson concerned, or if necessary to the METTLER TOLEDO representative responsible.

1.1 Safety and environment

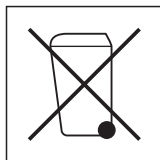
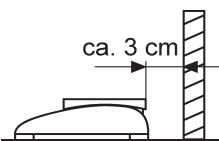

- Do not use the scale in **hazardous areas** (unless it is clearly identified as being approved for these areas).
- If the **power cord** is damaged, the scale must no longer be operated. Therefore check the cable regularly and ensure that a free space of about 3 cm is left at the rear of the scale, so that the cable is not kinked too severely.
- Never tamper with the **retaining screws for the load plate support** underneath the weighing pan.
- When the weighing pan is removed, **never insert a solid object underneath the load plate support**.
- Never open the scale by removing the **screws in its base**.
- Use only **approved accessories and peripherals**.
- Handle the scale with **utmost care**; it is a precision instrument. Blows on the weighing pan must be avoided, and heavy overloads must not be placed on it.
- Important instructions when using scales in the **food sector**: those parts of the scale can come into contact with food products have smooth surfaces and are easy to clean. The materials used do not splinter and are free from contaminants. In food processing areas, it is recommended that a **protective cover** (accessory) is used. This must be cleaned regularly, just like the scale itself. Damaged or heavily contaminated protective covers must be replaced immediately.
- When the scale is finally **taken out of service**, observe the current environmental regulations. The scale is equipped with a **battery** that contains heavy metals and therefore must not be treated as normal refuse! Local regulations for disposing of environmentally hazardous substances must be complied with.

1.2 Positioning and leveling the scale

The correct location is a decisive factor in ensuring accurate weighing results.

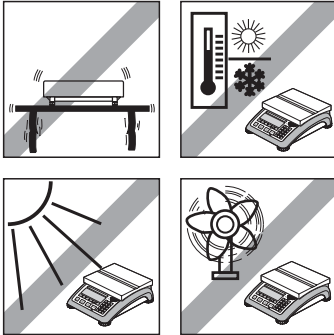

- Choose a stable and vibration-free location (particularly important for high-resolution scales using METTLER TOLEDO MonoBloc technology). Place the scale on a surface that is as horizontal as possible and strong enough to bear its weight when fully loaded.
- Check the ambient conditions.
- Avoid:
 - Direct sunlight
 - Strong drafts (e.g. from fans or air conditioning systems)
 - Excessive temperature fluctuations.

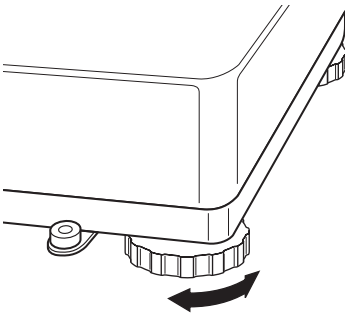

- Turn the adjustable feet so that the scale is horizontal. If a spirit level is filled, the bubble must be located within the inner circle.

Note: The SQC16 has a special filter that accelerates certain procedures (zeroing, taring) in a non-tranquil environment. This inevitably means that there is a slight loss of accuracy with the results. For high-precision results, care must be taken to ensure as tranquil and stable an environment as possible, so that the filter is not activated.

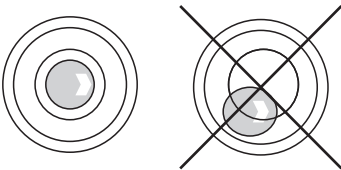

Major changes in geographical location:

Every scale is set by the manufacturer to suit the local gravitational conditions (geographical adjustment value) in the geographical zone to which the instrument is supplied. If a major change of geographical location takes place, this setting must be adjusted by a service technician or a new setting made. Certified scales must, in addition, be recalibrated in accordance with national certification regulations.

1.3 Connecting to power supply

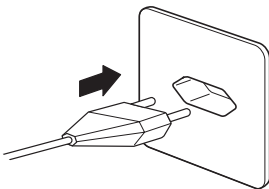

- Before connecting the power supply plug, verify that the voltage stated on the model plate is the same as the local power line voltage.
- For maximum possible precision, adjust the scale after installing it (Chapter 7.4.1). **Note:** Certified scales must be adjusted by an authorized organization. Please consult your dealer.

2 Basic functions

This Chapter describes how to switch the scale on and off, zero and tare it, weigh materials and record the results.

2.1 Switching on and off and zeroing



Briefly pressing «  » key switches the scale on or off.

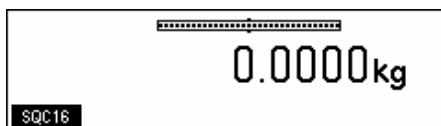

The scale carries out a display test, and then the software version is briefly displayed. Once the weight display appears, the scale is ready to operate and automatically zeroed.

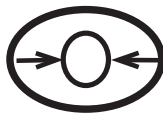

Note: If necessary, the scale can be zeroed at any time with the line «  » key.

2.2 Setting date and time

Time can be set in 24 hours format, and the date in European or US format.

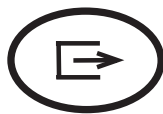

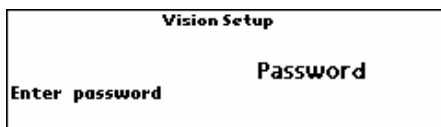

Press the «  » key continuously for about 2 seconds.

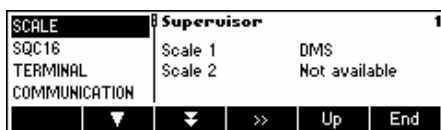

...appears on the screen and then briefly press the «  » key again.



Select **TERMINAL** by pressing «  » and press «  ».



...appears on the screen. Select **Device** and press «  ».





...appears on the screen. Select **Date Time** by pressing «**▼**» and press «**▶▶**».



...appears on the screen. Select **Date** by pressing the «**▼**» and press «**Edit**».



...appears on the screen. Use the numeric keypad to enter the date (e.g. 11022005) and confirm with «**OK**». Incorrect inputs can be deleted with «**Erase**». «**→**» and «**←**» can be used to move the cursor.

To set the correct time, do the same procedure but select **Time** instead of **Date**.

Note: Only the Supervisor has access rights to modify the Date/Time.

2.3 Language settings

Language can be set: English, German, French, Spanish or Italian.



Press the «» key continuously for about 2 seconds.

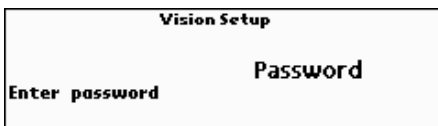

...appears on the screen and then briefly press the «» key again.

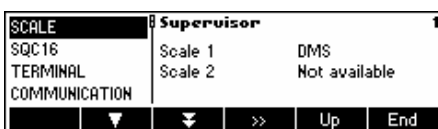

Select **TERMINAL** using «**▼**» and press «**▶▶**».



...appears on the screen. Select **Device** and press «**▶▶**».



...appears on the screen. On **Language** press «**Edit**».



...appears on the screen. Choose the desired language and then press «**OK**».



2.4 Simple weighing

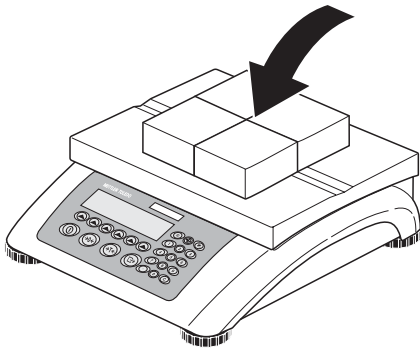

Place the object to be weighed on the scale.

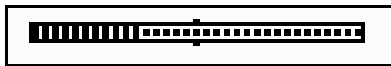

The bar graph at the top of the display shows how much of the weighing range is being used and how much is still available (as % of total scale capacity).

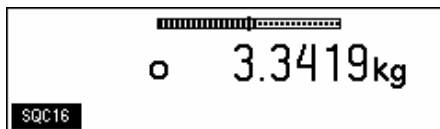

Wait until the stability detector (a small ring at the left edge of the display) disappears, then...

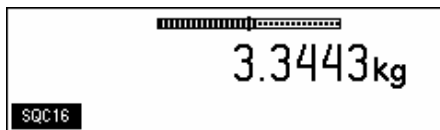

... read the indicated net weight.

2.5 Weighing with tare

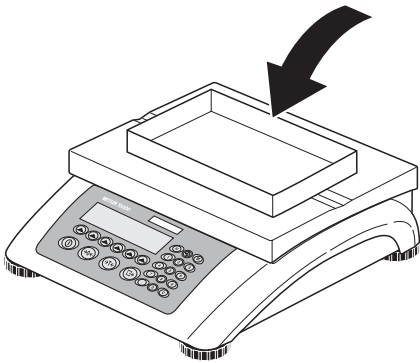

Place the **empty** weighing container or packaging on the scale.



Press the «  » key briefly to tare the scale.

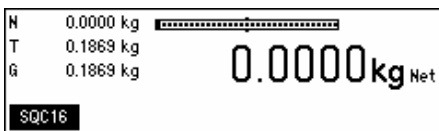

The zero display and the '**Net**' (net weight) symbol appear.

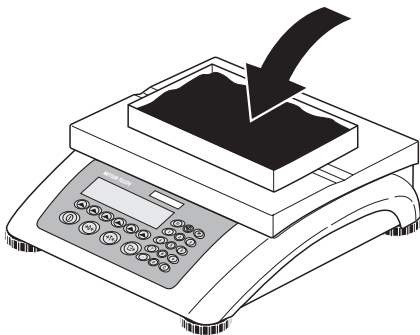

Place the material to be weighed in the container, then...

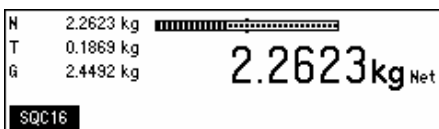

... read the net weight of the weighing sample.

Note: The tare weight is retained until either a new tare is determined, or the scale is zeroed or switched off.

2.6 Recording weighing results

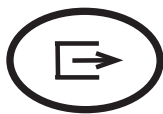

Press the «  » key to send the current weighing result to the peripheral device (usually a printer) via a COM port which has to be set up as 'Printer'.

Please refer to Chapter 7.9 for instructions on configuring the interface(s).

3 User setup and password

To avoid incorrect operation of the scale in normal use, the vision setup menu can be protected with a password. The scale differentiates between users and a supervisor. When the scale leaves the factory, the entire menu can be accessed by anyone. **We therefore recommend you to define your own supervisor password as soon as you set up the scale.** This limits access by the users to a smaller number of vision setup menu items (settings for language, sleep mode, contrast, invert, weight display and date/time).

Note:

Please be aware that the term 'Supervisor' (valid for Vision Setup; i.e. general scale operations and SQC16 operator/administrator setup) is different from 'Operator' and 'Administrator' (valid for SQC16 specific operations).

There should be only one (unnamed) Supervisor who has access to the Supervisor password and therefore, can setup several (named) administrators and several (named) operators, including resetting of their passwords.

Please refer to Chapter 7.2 on how to navigate within the 'Vision Setup'-menu and thus reach the menu position 'Vision Setup → TERMINAL → Access' (Chapter 7.7) for defining the Supervisor password.

3.1 Defining a user name

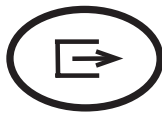

Press the «  » key continuously for about 2 seconds.

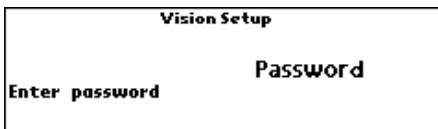

...appears on the screen, enter Supervisor password (if any; → Chapter 7.7) and then briefly press the «  » key again.

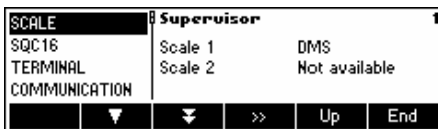

...appears on the screen.



Select **SQC16** by pressing «  » and then press «  ».



If you want to work with operator login, **User Login** should be activated.

Select **User Setup** and press «**Edit**».



...appears on the screen.



Define the user (User name, Number, Access Rights) by pressing «**Edit**» again.

16



Using the alphanumeric keypad of the scale, type the name of the user and then press **«OK»**. Up to 16 different users can be defined. Specify also 'Number' and 'Access Rights' of user, i.e. whether only as operator (who cannot enter **«»** menu within SQC16 mode) or as administrator.

Note: Password menu here is only meant to delete existing passwords in case it was forgotten (the supervisor can erase passwords of operators and administrators). For defining → Chapter 3.1. Please see also Chapter 7.5 for more detailed information about **SQC16** vision menu.

3.2 Creating a password

Once operator and administrator names are defined, a password has to be defined, as soon as the specific user enters 'SQC16' for the first time.

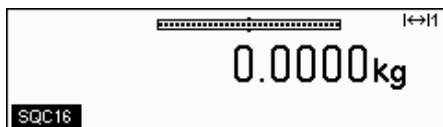

In weighing mode, press **«SQC16»**.



Select the user name and then press **«OK»**.



Using the numeric keypad of the scale, type the password and then press **«OK»**.

Note: The first time it will ask 'Create password' and then 'Re-type password'. Enter the same new password twice.

4 Getting to know the SQC16 software

SQC16 is an application for the 4-Series Compact Scales / Terminals. It is a convenient SQC compact system.

This chapter describes working with the SQC16 application. You might consider consulting Chapter 0 first about how to specify the behavior of the scale during weighing to match the surroundings. Further, you can specify general options such as scale identification, date, time, etc.

The SQC16 compact system offers evaluation and monitoring possibilities to statutory requirements for the fields of filling process control. It is suggested to attach a suitable METTLER TOLEDO strip printer or A4/Report printer.

Note: For more information about the meaning of the expressions 'Adjustment', 'Batch Statistics', 'Global Density', 'Individual Tare', 'Plausibility Limits', 'Mean Value Requirements', 'Shared Statistics', 'Supplement', 'Test', 'Tolerance System', 'Violation Check', 'Weighing Mode' and '2nd Tolerance System' please consult the included CD and select 'Appendix' of the 'SQC16 Training'. Alternatively, open the file Appendix_E.pdf on the root of the CD.

Special features of the system:

Internal calibration weight	available as option
Language	a choice of 11 languages
Max. number of articles	300
Data backup/restore/edit	
Statistics printing	convenient also under MS Windows 98/ME/NT/2000/XP
Bar code	for simple and effortless article selection
Tolerance systems	EU, Free1, Free2, Free3
Units	g, kg, lb, oz, ml, l, fz
Statistics per article	2 sets of statistics closed manually, e.g. for hourly and daily statistics
Batch statistics	printed and closed automatically at end of batch
A4/Letter report printing	choose between the Complete or Compact printing
Histogram	in sample record and statistics
Class table	in sample record and statistics
Graphics	\bar{x}/R (mean value/range) or \bar{x}/s (mean value/standard deviation) in sample record and statistics
Additive or subtractive weighing	for simple handling
Minimum nominal support	checking of the nominal value (warning if less than 100 resolution steps are defined)
Individual tare	for tare weights with high standard deviation (i.e. wide scatter)
Mean tare	enter manually or by weighing a tare series or bulk tare
Sample size	max. 999 (Note: with individual tare, there are 50 pre-weighing values available for each of max. 20 articles simultaneously)
Plausibility check	selectable (for nominal: for each article / for tare: system wide)
Adjustment	to get suitable adjustment messages for the filling machine
Violation check	for alarms after various defined events (T1-, T2-Violators below defined amount, etc.)

5 The SQC16 Application

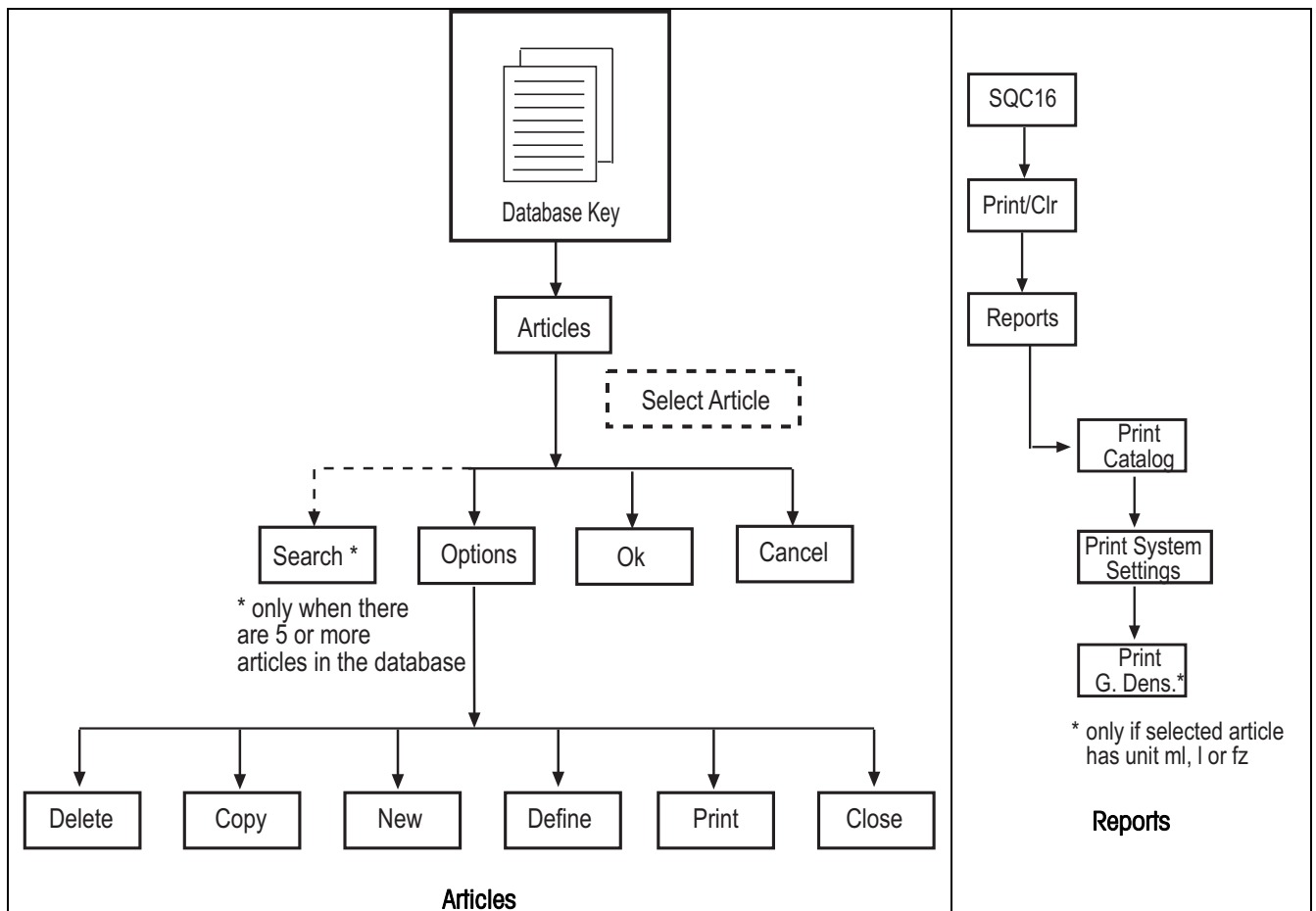
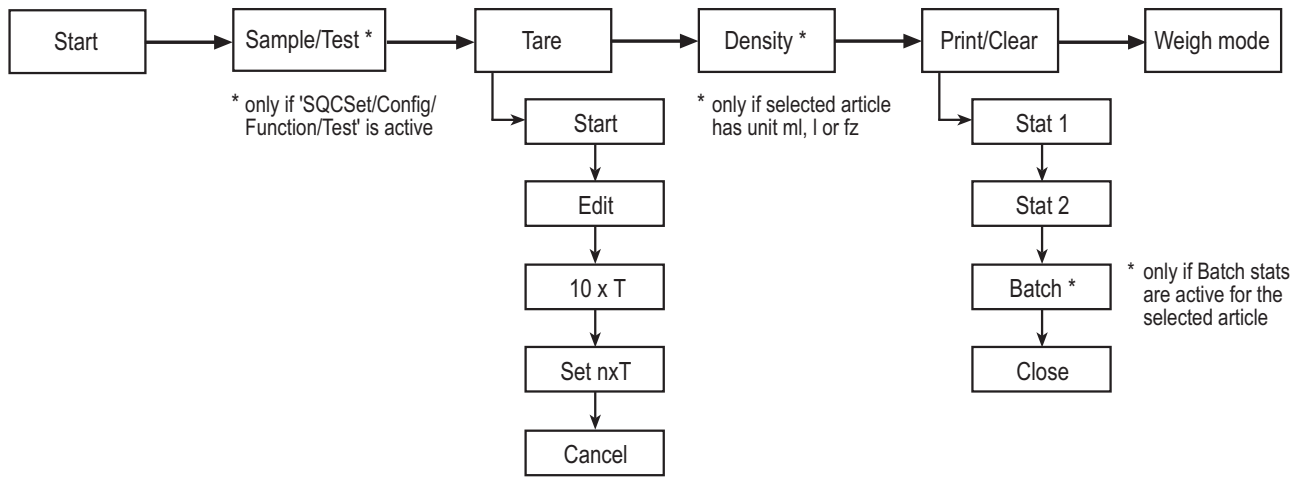

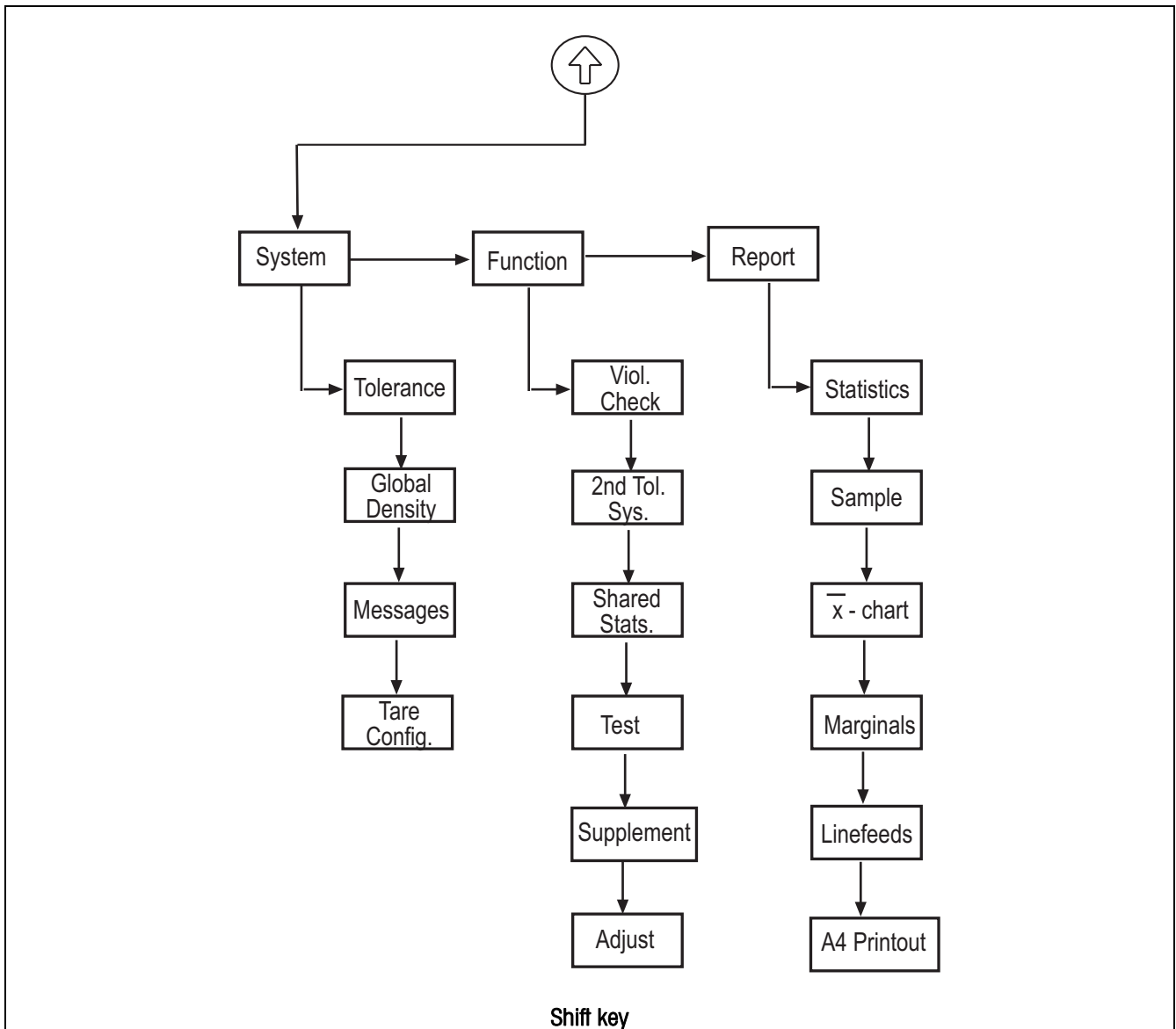

Before sampling, it is necessary to define at least one article.

5.1 Overview of article definition

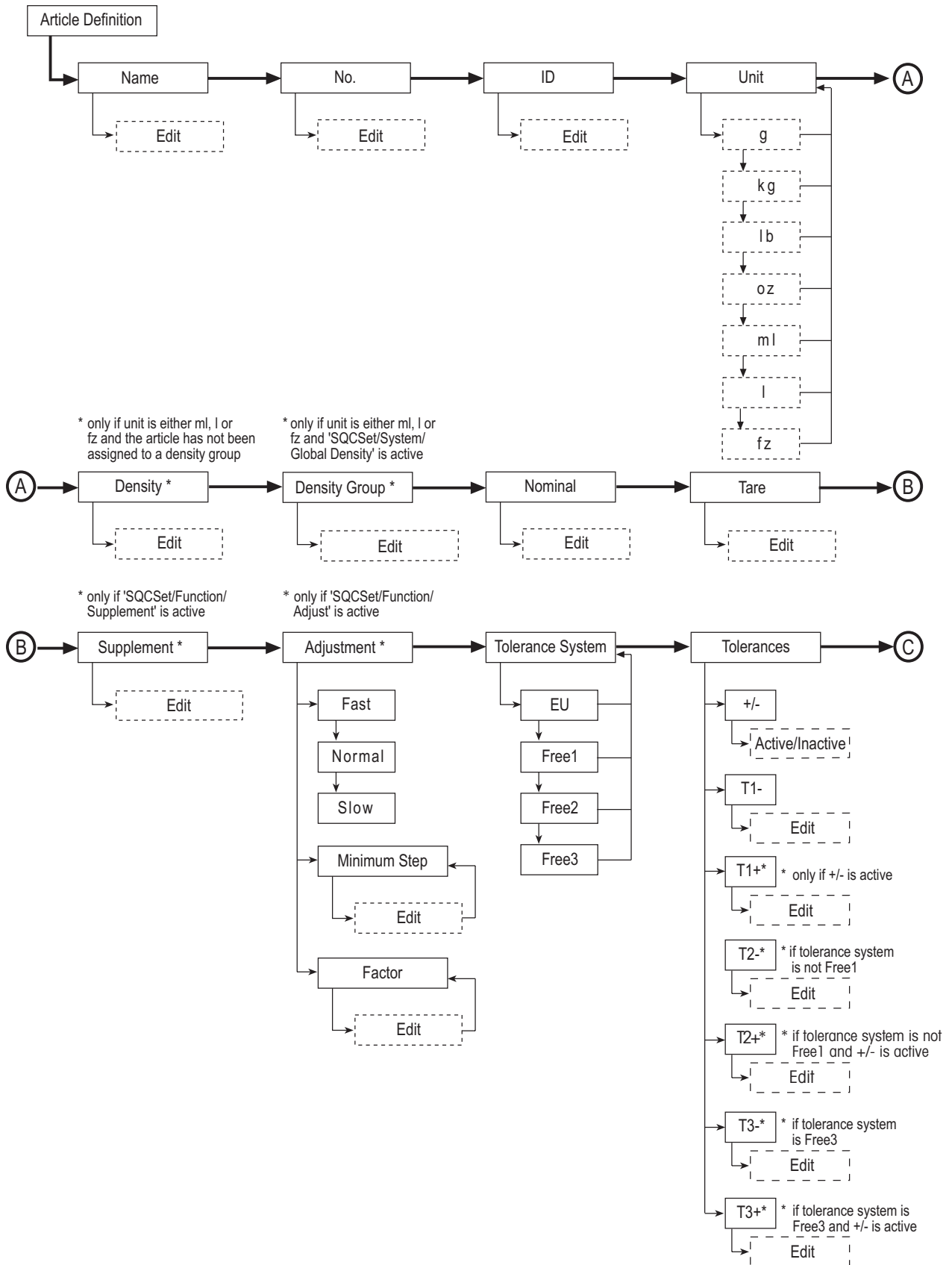

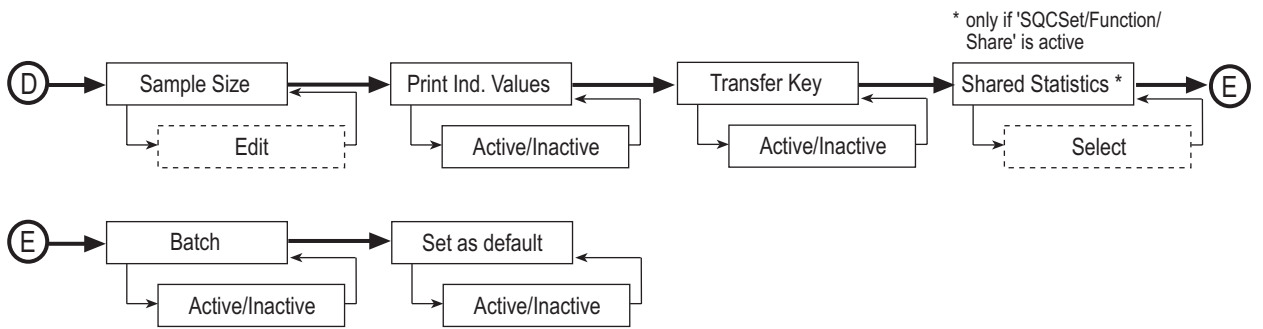
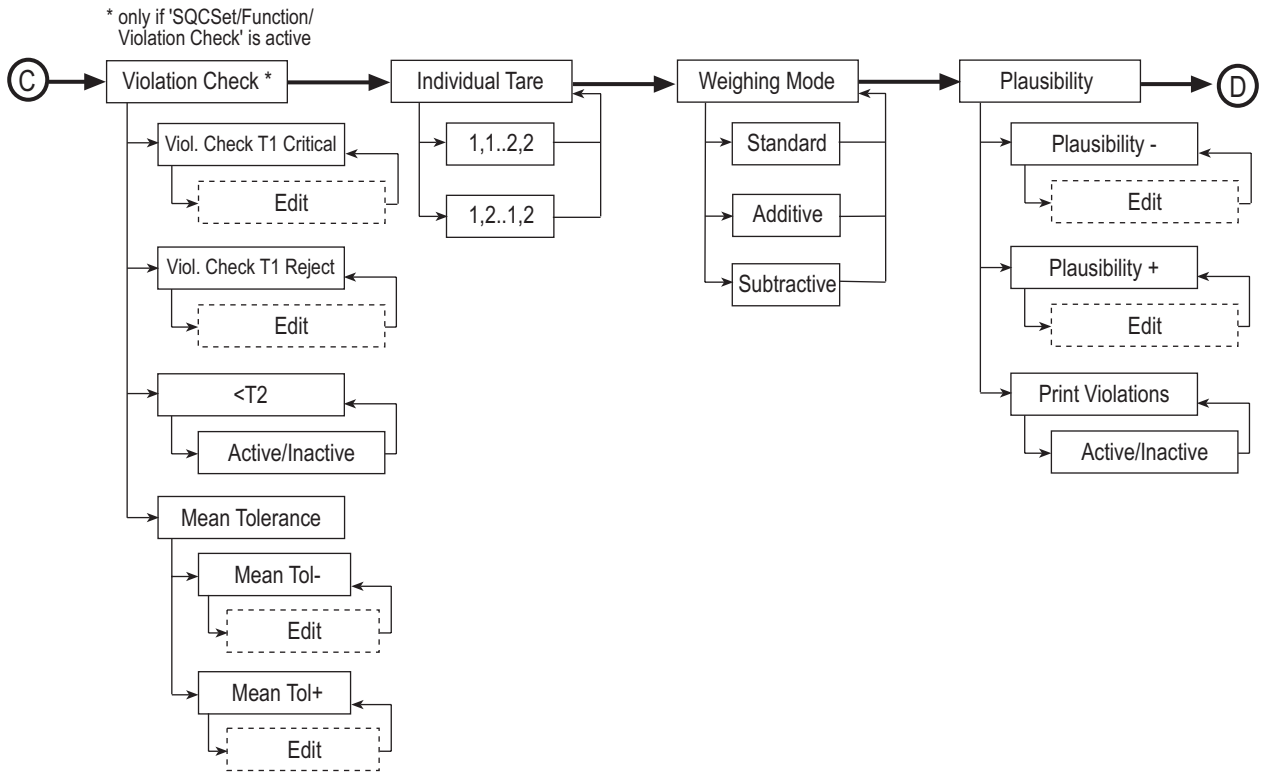

5.2 Creating an article for the first time

You must define at least the name and nominal fill quantity of one or more articles. Furthermore, you can define, e.g. the weighing mode, the weighing unit and the number of weighing per sample as well as the tolerance system to be used for the evaluation.

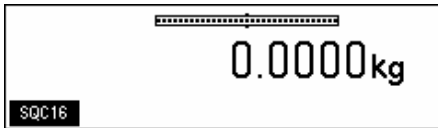

In weighing mode, press «**SQC16**».

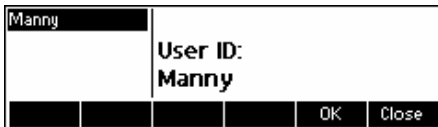

If 'User Login' is activated then select the user name and press «**OK**».

Note: This step can be skipped if "Vision Setup" → "SQC16" → "User Log-in" is set to **Off**.



Using the alphanumeric keypad of the scale, type the password and then press «**OK**».

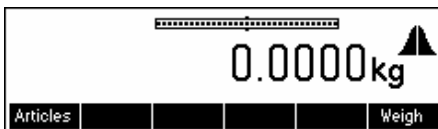

Press «**Articles**».

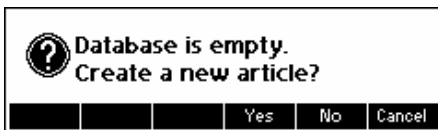

Since there is no existing database yet, press «**Yes**» to create one.



Using the keypad, type in the article name and then press «**OK**». Continue with the next parameter (Article No.) by pressing «**▼**».



Press «**Edit**». Using the keypad, type in the article number and then press «**OK**». Continue with the next parameter (ID) by pressing «**▼**».



Press «**Edit**». Using the keypad, type in the identification number and then press «**OK**». Continue with the next parameter (Unit) by pressing «**▼**».



Press «**▶▶**» to change the unit. As soon as the choices appear, use «**▼**» to choose the desired unit and press «**▶**». Continue with the next parameter (Density if liquid was chosen, otherwise Nominal) by pressing «**▼**».

No.	OTELLO12	5
ID		
Unit		
Density	Density: 1.0000 g/ml	
▲	▼	▼
	Edit	Close

Press «**Edit**». Using the keypad, type in the density weight value and then press «**OK**». This parameter appears only if **Unit** selected is ml (milliliter), l (liter) or fz (fluid ounce). Continue with the next parameter (Density Group) by pressing «**▼**».

ID	OTELLO12	6
Unit		
Density		
Dens. Group	Density Group: 0	
▲	▼	▼
	Edit	Close

Press «**Edit**». Using the keypad, type in the number of density group and then press «**OK**». This parameter appears only if **Unit** selected is ml, l or fz and if "SQC Config" → "Function" → "Global Density" is active. Continue with the next parameter (Nominal) by pressing «**▼**».

Unit	OTELLO12	123	7
Density			
Dens. Group			
Nominal	Nominal: 100.00 ml		
	Erase	←	→
		OK	Cancel

Press «**Edit**». Using the keypad, type in the nominal weight value and then press «**OK**». Continue with the next parameter (Tare) by pressing «**▼**».

In order to work with reasonable weighing results, it is recommended not to enter Nominal values lower than 100 times the scale resolution. Nevertheless, the system allows entries with a minimum of 30 times the resolution.

Example BBK462SQC-3XS:

Scale resolution $d = 0.01g$

Minimum recommended Nominal value = $100 \times 0.01g = 1g$

Minimum allowed Nominal value = $30 \times 0.01g = 0.3g$

ID	OTELLO12	
Unit		
Density		
Nominal	Input is < than the recommended min. value for this scale. Set 10.0ml?	
		Yes No Cancel

This warning message appears if the entered Nominal value is lower than 100 times the scale resolution.

By pressing «**Yes**», the minimum recommended Nominal value automatically suggested by the system, i.e. 10 ml, is being set.

By pressing «**No**», the entered value is set as Nominal if it is not lower than 30 x resolution

NOTE: The minimum recommended Nominal value varies depending on the scale resolution and article unit.

Unit	OTELLO12	
Density		
Dens. Group		
Nominal	Invalid input.	
	Erase	←
		→
		OK
		Cancel

This error message appears if the entered Nominal value is lower than 30 times the scale resolution.

Density	OTELLO12	123	8
Dens. Group			
Nominal			
Tare	Tare: 0.143 g		
	Erase	←	→
		OK	Cancel

Press «**Edit**». Using the keypad, type in the tare weight and then press «**OK**». Continue with the next parameter (Supplement) by pressing «**▼**».

Dens. Group	OTELLO12	123	9
Nominal			
Tare			
Supplement	Supplement: 0.568 ml		
	Erase	←	→
		OK	Cancel

Press «**Edit**». Using the keypad, type in the supplement value and then press «**OK**». This parameter appears only if "SQC Config" → "Function" → "Supplement" is active. Continue with the next parameter (Adjustment) by pressing «**▼**».

Nominal	OTELLO12	10
Tare	Adjustment:	
Supplement	Not selected	
Adjustment		
▲	▼	Close

To select adjustment, press **OK**. This parameter appears only if "SQC Config" → "Function" → "Adjustment" is active.

Fast	OTELLO12	10-1
Normal	Adjustment:	
Slow	Fast	
Min. Step		
▼	▼	Up
▲	▼	Close

Select the speed of adjustment (Fast, Normal or Slow) by pressing **OK**. Also, define the minimum step value by selecting the parameter **Min. Step** and then pressing **Edit**. Using the keypad, type in the minimum step value and then **OK**. The parameter **Min. Step** sets the threshold, i.e. smaller adjustment messages will not be given.

Normal	OTELLO12	10-5
Slow	Factor:	
Min. Step	1.0000	
Factor		
▲	▼	Close

Furthermore, define **Factor** using **Edit**. Using the keypad, type in the factor value and then press **OK**. The computed adjustment value will be multiplied with the factor value in order to determine the final adjustment message. Continue with the next parameter (Tol. System) by pressing **OK**.

Tare	OTELLO12	11
Supplement	Tolerance System:	
Adjustment	EU	
Tol. System		
▲	▼	Close

Press **OK** to change tolerance system (EU, Free1, Free2 or Free3). Continue with the next parameter (Tolerance settings) by pressing **OK**.

Supplement	OTELLO12	12
Adjustment	T1-: 4.5 ml	T1+: 4.5 ml
Tol. System	T2-: 9.0 ml	T2+: 9.0 ml
Tolerances		
▲	▼	Close

Press **OK** to change the positive and negative tolerance settings. Continue with the next parameter (Violation Check) by pressing **OK**.

Adjustment	OTELLO12	13
Tol. System	Violation Check:	
Tolerances	Not selected	
Viol. Check		
▲	▼	Close

Press **OK** to select violation checking. This parameter appears only if "SQC Config" → "Function" → "Violation Check" is active. Continue with the next parameter (Individual Tare) by pressing **OK**.

Tol. System	OTELLO12	14
Tolerances	Individual Tare:	
Viol. Check	Not selected	
Ind. Tare		
▲	▼	Close

Press **OK** to select individual tare mode. Continue with the next parameter (Weighing mode) by pressing **OK**.

Tolerances	OTELLO12	15
Viol. Check	Weighing Mode:	
Ind. Tare	Standard	
W Mode		
▲	▼	Close

Press **OK** to change weighing mode (Standard, Additive or Subtractive). After selecting, continue with the next parameter (Plausibility) by pressing **OK**.

Viol. Check	OTELLO12	16
Ind. Tare	Plausibility Minus:	30.00 %
W Mode	Plausibility Plus:	30.00 %
Plausibility	Print Violations:	Not selected
▲	▼	Close

Press **OK** to change plausibility settings. Continue with the next parameter (Sample Size) by pressing **OK**.

Ind. Tare	OTELLO12	17
W Mode	Sample Size:	
Plausibility	5	
- n -		
▲	▼	Close

Change sample size (-n-) by pressing **Edit** and then type in the desired number of individual values per sample. Continue with the next parameter (Print Individual Value) by pressing **OK**.



Each individual value will be printed out in the sampling report if this function is selected. Press **◀▶** to unselect (or **◀▶** to select). Continue with the next parameter (Transfer Key) by pressing **▶**.



If selected (press **◀▶**), the weighing result will not be automatically sampled once stability is reached. You will have to press **Accept** for each individual value. Continue with the next parameter (Shared Statistics) by pressing **▶**.



If selected (press **◀▶**), you will be asked to select the common article. With this function, you will be able to combine the sampling data of two or more articles into one common article, enabling you to monitor overall production.

In order to share an article's data with a common article, the following parameters have to be identical: Unit, Nominal, Tolerance System and Tolerances.

This parameter appears only if "System" → "Function" → "Shared Statistics" is active. **When defining an article for the very first time**, this parameter will not be available and will therefore jump to the next parameter, since there are no other existing articles yet to share statistics with. Continue with the next parameter (Batch) by pressing **▶**.



If selected (press **◀▶**), batch statistics are calculated and printed out for each batch. At the start of sampling, you will be asked to enter the batch name. Continue with the next parameter (Set as default) by pressing **▶**.



If selected (press **◀▶**), the parameter settings of this article will be set as default for defining new articles. The default article will appear within square brackets in the article list: [Article name].

Press **Close** (and confirm with **Yes**) to save the new article in the database. The article parameter will be printed.

5.3 The database

The following describes the use of the article database.



Briefly press the **☰** key.



...appears on the screen. You can now see the articles in your database.

26

NER013	<Article No.>	13/13
NOCCIOLAT06	ID:	
NOISETTE2	Nominal:	100.0 g
OTELLO10	Tare:	0.0 g
▲	Search	Options OK Cancel

Scroll on the articles using «▲» and «▼», and press «OK» to choose the desired article to be used in the sampling. Press «Options» to go to the Options menu, or press «Search» to search articles in the database (see also Chapter 5.3.2). Otherwise, press «Cancel» to abort operation.

NER013	<Article No.>	13/13			
NOCCIOLAT06	ID:				
NOISETTE2	Nominal:	100.0 g			
OTELLO10	Tare:	0.0 g			
Delete	Copy	New	Define	Print	Close

... appears on the screen if «Options» is pressed. This function is used to delete or copy the highlighted article or to change («Define») or print out its parameters. «New» will create a new article based on the default article.

5.3.1 Creating a new article

The following describes the operations for creating a new article in the database.

Act	0.0 g	Sample		
T	0.0 g	0.0 g ▲		
Norm	100.0 g			
OTELLO10				
Start	Test	Tare	Print/Clr	Weigh

Briefly press the «☰» key.

AQUA VIDA	<Article No.>	8/13			
LATTE7	ID:				
NER013	Nominal:	65. ml			
NOCCIOLAT06	Tare:	0. g			
▲	▼	Search	Options	OK	Cancel

...appears on the screen. You can now see the articles in your database.

NER013	<Article No.>	13/13		
NOCCIOLAT06	ID:			
NOISETTE2	Nominal:	100.0 g		
OTELLO10	Tare:	0.0 g		
▲	Search	Options	OK	Cancel

...appears on the screen. Press «Options».

NER013	<Article No.>	13/13			
NOCCIOLAT06	ID:				
NOISETTE2	Nominal:	100.0 g			
OTELLO10	Tare:	0.0 g			
Delete	Copy	New	Define	Print	Close

...appears on the screen. Press «New».

Name	ABC			
No.	1			
ID				
Unit				
Article Name:				
Erase	←	→	OK	Cancel

...appears on the screen. Using the keypad, type in the name of the new article and then press «OK». In order to define the parameters of this new article, follow the same procedures as described in Chapter 5.2 for Article Number, ID, Unit, Density, Density Group, Nominal, Tare, Supplement, Adjustment, Tolerance System, Tolerances, Violation Check, Individual Tare, Weighing Mode, Plausibility, Sample Size, Print Individual Values, Transfer Key, Shared Statistics, Batch and Set as Default.

5.3.2 The 'Search' softkey

The following describes the operations for searching articles in the database.

Follow the first three steps as described in Chapter 5.3.

NER013	<Article No.>	13/13
NOCCIOLAT06	ID:	
NOISETTE2	Nominal:	100.0 g
OTELLO10	Tare:	0.0 g
▲	Search	Options OK Cancel

...when this screen appears, press «**Search**».

NOTE: Search button only appears when there are more than four articles in the database.

LATTE7	<Article No.>	ABC
NER013		9/13
NOCCIOLAT06	Search:	
NOISETTE2	L	
Erase	←	→ OK Cancel

Press «**Erase**» to clear the article name and using the keypad, type in the first letter of the article you are searching for. The articles corresponding to the letter you typed in will be shown on the left side of the screen.

5.3.3 Editing the parameters of an existing article

The following describes the operations for editing the parameters of an existing article in the database.

Follow the first four steps as described in Chapter 5.3. Use the «**Search**» if necessary.

LATTE7	<Article No.>	9/13
NER013	ID:	
NOCCIOLAT06	Nominal:	100.0 g
NOISETTE2	Tare:	0.0 g
Delete	Copy	New Define Print Close

...when this screen appears, press «**Define**».

Name	LATTE7	1
No.	Article Name:	
ID	LATTE7	
Unit▶		
▼	▼	Edit Close

...appears on the screen. Change the parameters of the article name by pressing «**Edit**».

Name	LATTE7	ABC
No.	Article Name:	1
ID	LATTE7	
Unit▶		
Erase	←	→ OK Cancel

...appears on the screen. Press «**Erase**» to delete the existing article name. Change it by typing in a new name using the keypad. Press «**→**» and «**←**» to move cursor from left to right and vice-versa. Press «**OK**» when input is done. Otherwise, press «**Cancel**» to abort operation.

Continue editing the rest of the parameters by following the same procedures as described in Chapter 5.2.

Note: Once SQC16 has generated a statistics, you can no longer edit the following parameters of that article: Name, Unit, Nominal Tolerance system and Tolerance. If you wish to edit the parameters of an article that already has a statistics, you have to print and clear the statistics first by pressing «**Print/Clr**» in standby mode (see also Chapter 5.8).

5.3.4 Copying the parameters of an existing article to a new article

Sometimes, when creating a new article, it may be easier to copy the parameters of an existing article and then editing only the parameters that need to be changed. The following describes the operations for copying the parameters of an existing article on to a new one.

Follow the first four steps as described in Chapter 5.3. Use «**Search**» if necessary.

LATTE7	<Article No.>	9/13
NER013	ID:	
NOCCIOLAT06	g Nominal:	100.0 g
NOISETTE2	Tare:	0.0 g
Delete	Copy	New
Define	Print	Close

...when this screen appears, press «**Copy**». After copying and making necessary changes, you can select a particular article for you to set as default so that next time you copy, the default article will be selected first.

Name	ABC
No.	1
ID	
Unit	
Article Name: SUGAR	
Erase	←
→	OK
Cancel	

Using the keypad, type in the new article name and then press «**OK**». The parameters of the article chosen are now copied on to the new article. Continue with the other parameters by following the same procedures as described in Chapter 5.2.

5.3.5 Deleting an article

The following describes the operations for deleting an article from the database.

Follow the first four steps as described in Chapter 5.3.

LATTE7	<Article No.>	9/13
NER013	ID:	
NOCCIOLAT06	g Nominal:	100.0 g
NOISETTE2	Tare:	0.0 g
Delete	Copy	New
Define	Print	Close

...when this screen appears, press «**Delete**».

LATTE7	<Article No.>	9/13
NER013	?	Are you sure you want to delete this article?
NOCCIOLAT06		
NOISETTE2	Yes	No
Cancel		

...appears on the screen. Press «**Yes**» to delete. Otherwise, press «**Cancel**» to abort operation.

Note: Articles that have existing statistics values cannot be deleted, until these statistics are cleared as described in Chapter 5.8.

5.3.6 Printing the parameters of an article

The following describes the operations for printing out the parameters of an article on an attached printer.

Follow the first four steps as described in Chapter 5.3. Use «**Search**», if necessary.

LATTE7	<Article No.>	9/13
NER013	ID:	
NOCCIOLAT06	g Nominal:	100.0 g
NOISETTE2	Tare:	0.0 g
Delete	Copy	New
Define	Print	Close

...when this screen appears, press «**Print**».

LATTE7	<Article No.>	9/13
NER013	i	Printing article data ...
NOCCIOLAT06		
NOISETTE2	Define	Print
Close		

...appears on the screen. SQC16 will print out all the parameters of the chosen article.

5.4 Sampling of articles

The following describes the operations on how sampling of articles is performed.



Press «Start» to commence sampling.

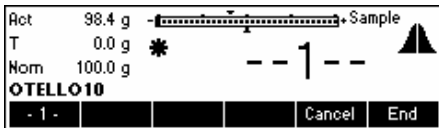

...appears after placing the first item on the scale.

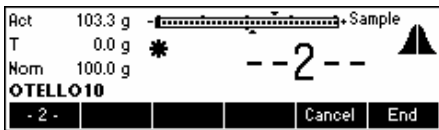

...appears after placing the second item on the scale.

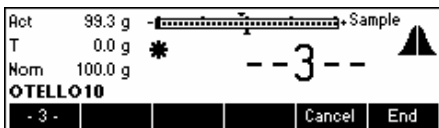

...appears after placing the third item on the scale.

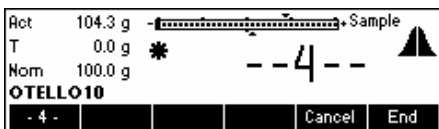

...appears after placing the fourth item on the scale.

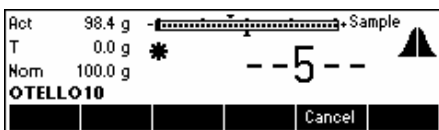

...appears after placing the fifth item (default setting) on the scale.



...appears on the screen. A report will be printed out.

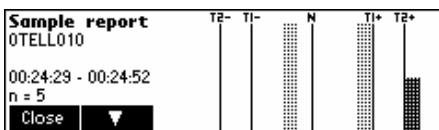

...appears on the screen. Press «Close» to close the Sample Report. Press «▼» to scroll down to see the rest of the statistics.

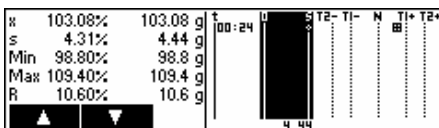

30

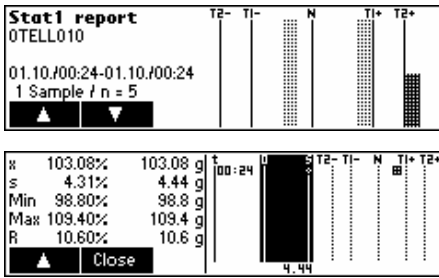

...end of statistics report. Press «» or «C» to close the end of sampling messages (see also «»/System/Messages). Press «Close» to close the Sample Report.

5.5 Test series

A test series is a sample for the simple determination of mean and standard deviation. Therefore, the test series results are not saved in the statistics of the article, but are merely printed out for testing purposes. It serves e.g. to set a filling machine after a product change.

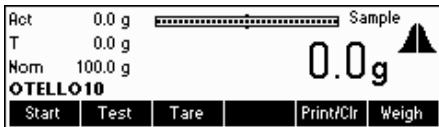

Press «Test» to activate the test series function (if selected in System/Function/Test)

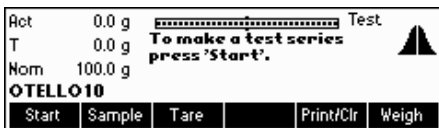

...appears on the screen. Press «Start» to commence test sampling.

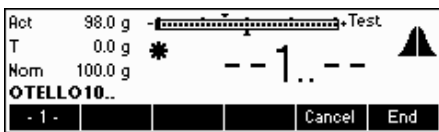

...appears after placing the first item on the scale.

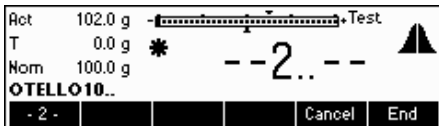

...appears after placing the second item on the scale.

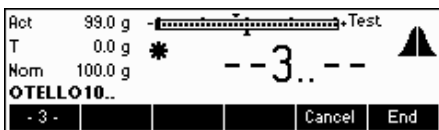

...appears after placing the third item on the scale.

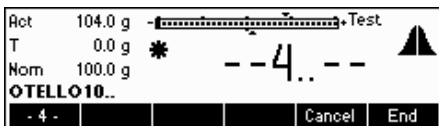

...appears after placing the fourth item on the scale.

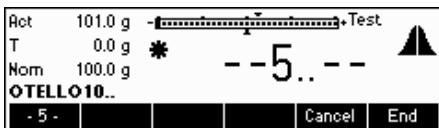

...appears after placing the fifth item on the scale. You may go on until the maximum sampling of 999 is reached or press «End» to finish sampling.



...appears on the screen. A report will be printed out.

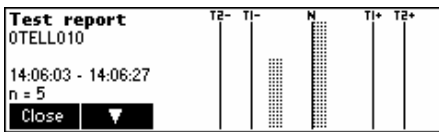

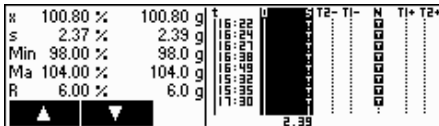

...appears on the screen. Press «Close» to close the Sample Report. Press «▼» to scroll down to see the rest of the statistics.

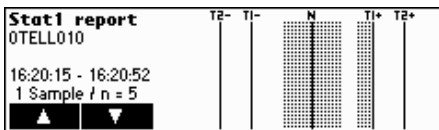

Note: 'T' appears to indicate a test series within the mean value trace.



...end of statistics report. Press «» or «C» to close the end of sampling messages (see also «»/System/Messages). Press «Close» to close the Sample Report.

5.6 Taring

The following describes the three ways of entering tare values within SQC16.



Press «Tare» to activate the tare function.

5.6.1 Manual tare



Press «Edit» to change the tare weight of an article manually to a known value.



...appears on the screen. Using the keypad of the scale, type in the tare value and then press «OK».



...appears on the screen. SQC16 is now ready to start sampling using the new tare value.

5.6.2 Tare series

A tare series is a procedure, by which individual tare items are placed on the scale, in order to determine the mean tare value to be used in the sampling of an article.



Press «**Start**» to commence tare series.

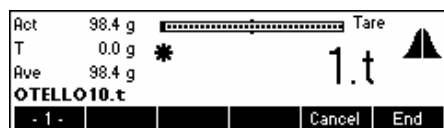

...appears after placing the first tare item on the scale.

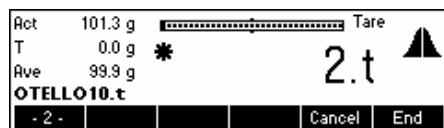

...appears after placing the second sample on the scale.

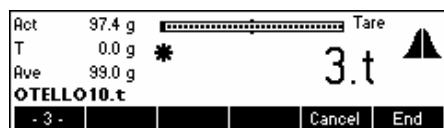

...appears after placing the third sample on the scale.

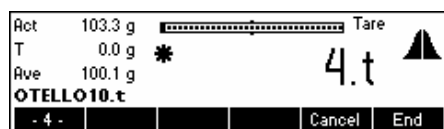

...appears after placing the fourth sample on the scale.

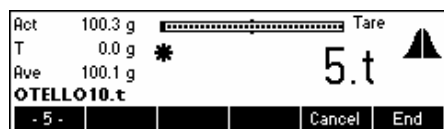

...appears after placing the fifth sample on the scale.

A tare series does not end automatically. It needs to be ended by pressing «**End**».

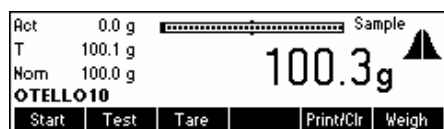

...appears on the screen. SQC16 has generated a mean value and is now ready for sampling.

5.6.3 Bulk tare

The bulk tare softkey «**10xT**» is used to determine the mean tare value, based on the number of tare items in the settings. You can change the number of tare items by pressing «**Set n:T**». The default setting is n=10 (→ «**10xT**»).



Press «**10xT**» to switch to bulk taring function.



...appears on the screen. Press «**Start**» to commence bulk taring.

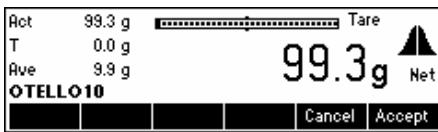

Place 10 tare items on the scale and then press «**Accept**».

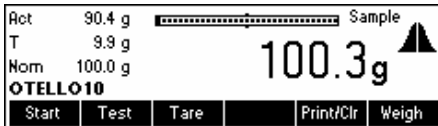

...appears on the screen. SQC16 has generated a mean value and is now ready for sampling.

5.7 Density

This function makes it possible for the user to conveniently change the density value, without having to go to the menu of the article definition. However, this function appears **only** if a liquid unit is selected in the article definition, i.e. "ml", "l" or "fz".



Press «**Density**».

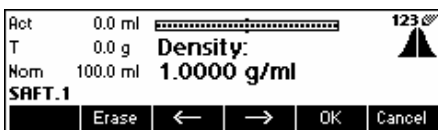

Press «**Erase**» to delete the existing value and, using the keyboard, type in the desired value and then press «**OK**». Please refer to Chapter 5.9.2 Global Density for more information.

5.8 Printing/Clearing statistics

The following describes the operations on how to print and/or clear statistics. Note the difference between «**Print**» (printing only) and «**Prt/Clr**» (print first and erase after printing). SQC16 will always print the statistics before permanently erasing it from the database. Of course, it should be checked first, if enough paper is available, otherwise the data will be lost. Consider backing up your data with BR16 PC-program before erasing important data.



Press «**Print/Clr**» while the article whose statistics should be printed (and cleared in case of Prt/Clr) is the current one.



Choose the statistics that you wish to delete («**Stat1**», «**Stat2**» or «**Batch**»).

Note: «**Batch**» appears only if "Batch" is activated under "Articles" → "Options" → "Define" → "Batch". See also Chapter 6.3.

34

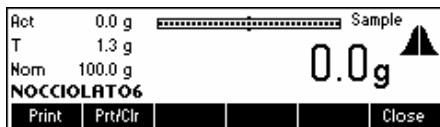

...appears on the screen. Press «**Prt/Clr**» if the selected statistics should be erased after printing. Press «**Print**» to leave data untouched after printing.



SQC16 prints out the selected statistics. Wait until printing is done.



...appears on the screen. Press «**Close**» to go back to sampling screen.

5.9 The System settings

You can press «» then select System to set general SQC parameters (tolerance unit mode; global density; end of sample messages, tare plausibility), valid for all articles.



Press «».



Three sub-menus appear on the screen, namely: System, Function and Report. The following is an overview of the System Settings menu.

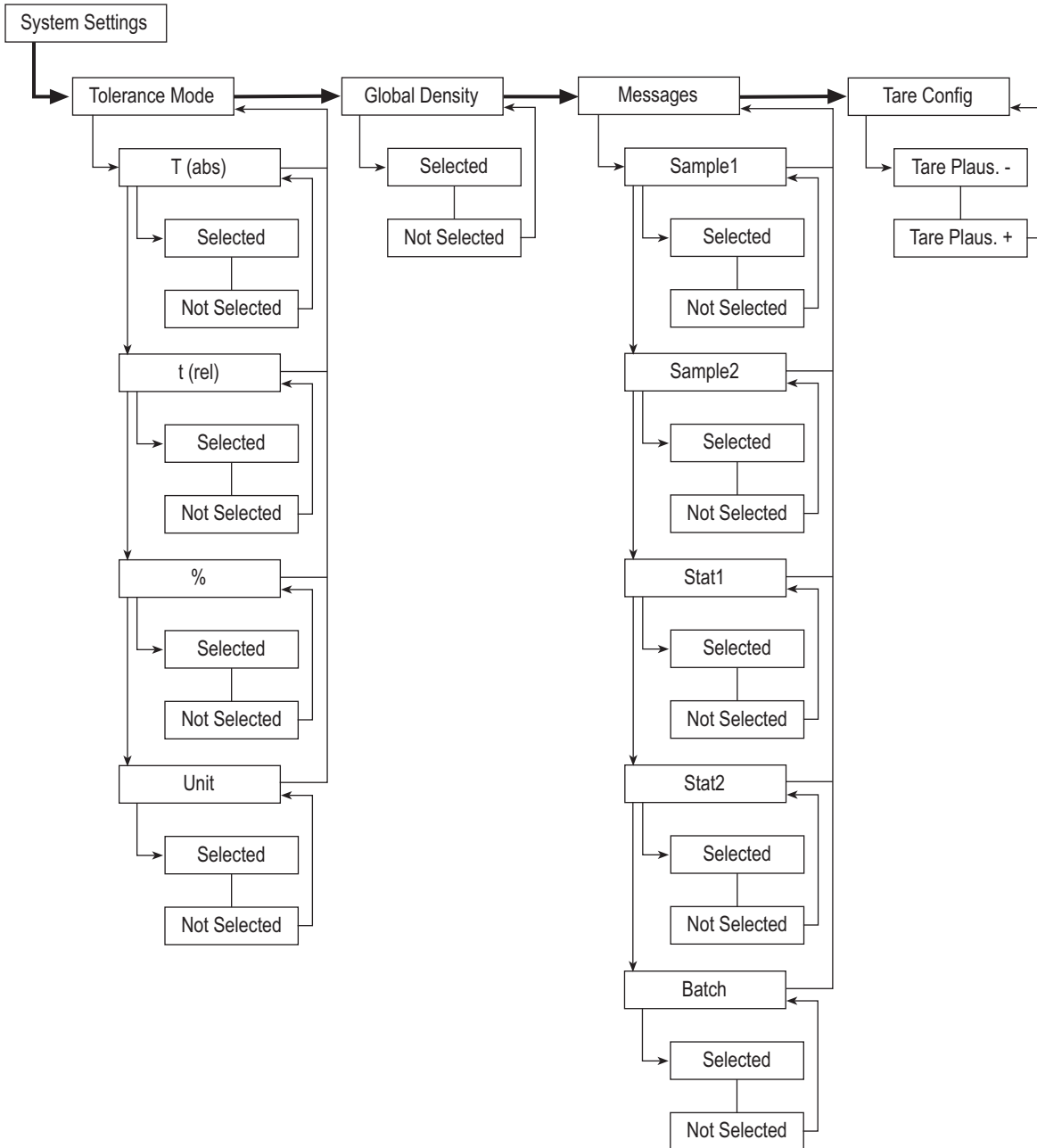

Press «>>» to enter the System settings sub-menu.

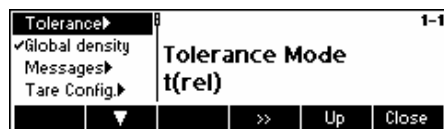

The following selection appears:

"Tolerance"	Define tolerance entries (menu)
"Global density"	Global density (same for all articles)
"Messages"	Define messages at the end of samples
"Tare Config"	Define minimum and maximum tolerances in percentage

5.9.1 Tolerance specifications

With the factory setting, the tolerances are entered and displayed relative to the nominal fill quantity and in the selected unit. If you wish to change this setting, select the parameter "Tolerance" and then press **<>>**.

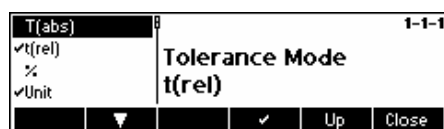

"T (abs)"	Representation of the tolerances relative to zero
"t (rel)"	Representation of the tolerances relative to the nominal fill quantity
"%"	Tolerance specifications in percentage
"Unit"	Tolerance specifications in the unit applicable to the article

5.9.2 Global density

With Global density active, articles with liquid units can be one in one of among 30 Density Groups, selectable in the article definition menu. If the density of an article belonging to a specific Density Group was modified, all articles belonging to the same group will have their density parameters modified as well.



Press **<F1>** or **<F2>** to select or unselect Global Density.

5.9.3 Sample messages

Selecting "Messages" will display relevant information at the end of the sampling, such as Article Name, Article ID, Date, Number of Samples, Total Number of Samples, Mean Value, Standard Deviation, Minimum Value, Maximum Value and Range.



Press **«>>»** to activate sample messages.



Sample 1/2, Sample 2/2, Stat1, Stat2 and Batch are all selected by default. To deactivate, simply press **«<<»**.

Below are examples of sample messages that may appear on the display:

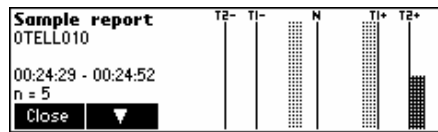

Sample 1/2

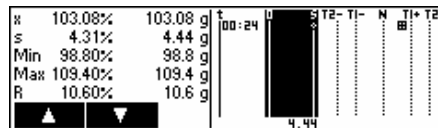

Sample 2/2

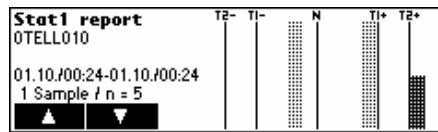

Statistics 1

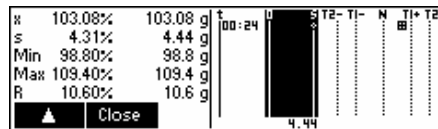

Press **«Close»** to close the Sample Report.

5.9.4 Tare configuration

This function will allow to set a +/- plausibility for the individual values of a tare series. It refers to the current tare value.

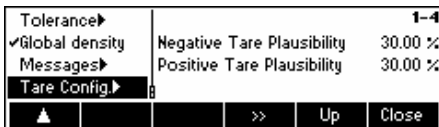

Press **«>>»** to enter the Tare Configuration menu.

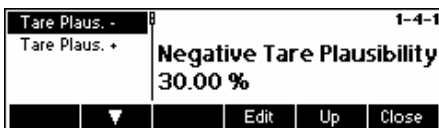

Enter desired Minimum and Maximum Tolerances by pressing the **«Edit»** and typing in the value using the numeric keypad of the scale.

5.10 The Function settings

You can use the menu option "«»\Function" to switch several special SQC functions on or off.



The following is an overview of the Function Settings menu.

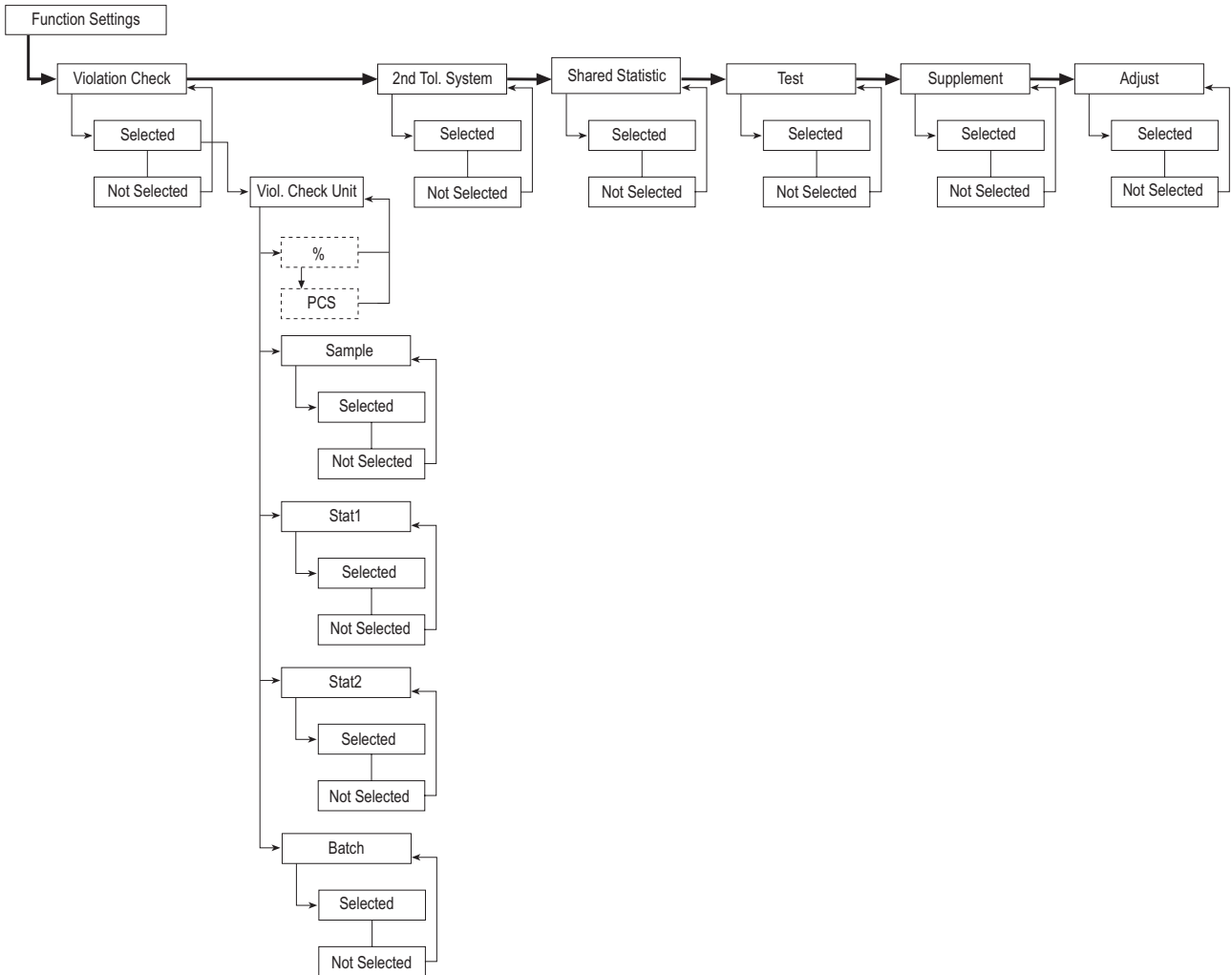



Press «**▶▶**» to enter the Function settings sub-menu.



The following selection appears:

- "Viol. Check" Check if a certain number of toleration violations has been exceeded
- "2nd Tol. System" Evaluate each sample of an article using an additional, to be defined, 2nd tolerance system.
- "Shared Statistics" Share a common set of statistics for various articles
- "Test" Sample without influence on the statistics, for simple determination of mean value and standard deviation
- "Supplement" May be necessary if a filling process is not stable with time
- "Adjust" To activate the adjustment algorithm with resulting numeric messages that serve to optimize the filling process

5.10.1 Violation check

If you wish to have an alarm message when a certain number of tolerance violations has been exceeded, select the parameter "Viol. check".



Press «**☑**» to activate Violation check.



The following selection appears:

- "%" Check if unit should be percentage instead of PCS
- "PCS" Check if unit should be pieces instead of %

Press «**☑**» to check the desired unit.

- "Sample" Select to monitor tolerance violations in Sample
- "Stat1" Select to monitor tolerance violations in Statistics 1
- "Stat2" Select to monitor tolerance violations in Statistics 2
- "Batch" Select to monitor tolerance violations in Batch

Press «**☑**» or «**☐**» to select or unselect any of the above 4 items.



When no article has the Violation Check activated, you can select either "%" or "PCS" as its unit. Then you can select an article wherein you want to activate the Violation Check and define the values for VC T1 Critical, VC T1 Reject, <T2 and make the Mean Tolerance active or inactive.

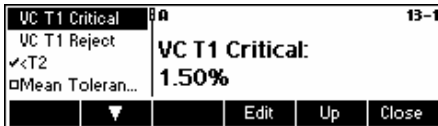
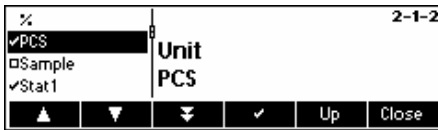

"VC T1 Critical" If during the sampling, the specified amount of Tolerance Violators for T1 +/- reaches the specified Critical values, an alarm will set off informing the user that there is a certain number of samples that are "T1 Critical (Pcs or %)".

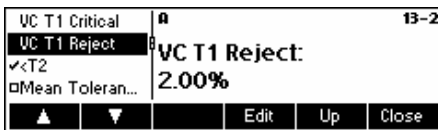

"VC T1 Reject" If during the sampling, the specified amount of Tolerance Violators for T1 +/- reaches the specified Reject values, an alarm will set off informing the user that there is a certain number of samples that are "T1 Reject (Pcs or %)", and the whole sampling will then be rejected.



"<T2" this refers to the amount of T2- violators; this function can be enabled or disabled.

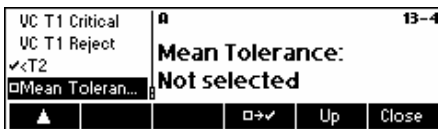

"Mean Tolerance" The check for mean tolerances (*tm-* and *tm+*) is a check on the deviation of the mean value from target value

5.10.2nd Tolerance System

If you desire evaluations of the same article using different tolerance systems, e.g. according to a free tolerance system to improve the filling accuracy, select the parameter "2nd Tol. System".

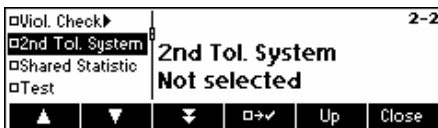

Press «» to activate 2nd tolerance system, then the correlations and relationships under the article definition.

Before you can define an article as a slave, you need to define an article as a master (reference) first. This master is a normal article. It has at least the following parameters defined:

- a. Name
- b. Nominal value
- c. Tolerance system
- d. Tolerances

If you define a slave of a master, all data defined in the master-article will be copied to the slave. Now you can only change a few parameters on the slave-article:

- a. Tolerance system
- b. Tolerances
- c. Violation check
- d. Individual values printout

5.10.3 Shared Statistics

If you wish to have a common set of statistics for various articles, select the parameter "Shared Statistics". To perform the shared statistics and for every common article, an article must be defined.



Press «**Enter**» to activate Share, then define the relationships under the article definition.

5.10.4 Test

If you wish to perform sampling for simple determination of mean value and standard deviation, without influence on the statistics, select the parameter "Test".



Press «**Enter**» to activate Test.

5.10.5 Supplement

It may sometimes be necessary to switch on Supplement, if a filling process is not stable. To do so, select the parameter "Supplement".



Press «**Enter**» to activate Supplement.

5.10.6 Adjust

To work with adjustment messages, select the parameter "Adjustment". If selected, then the parameter 'Adjustment', as well as its sub parameters 'Speed', 'Min. Step' and 'Factor' will become available in the article definition of each article.



Press «**Enter**» to activate Adjustment.

5.11 The Report settings

This function allows you to generate reports according to your specific needs. If you wish to change this setting, select the parameter "Report".



Using **▲** and **▼**, choose **Report**. The following is an overview of the Report Settings menu.

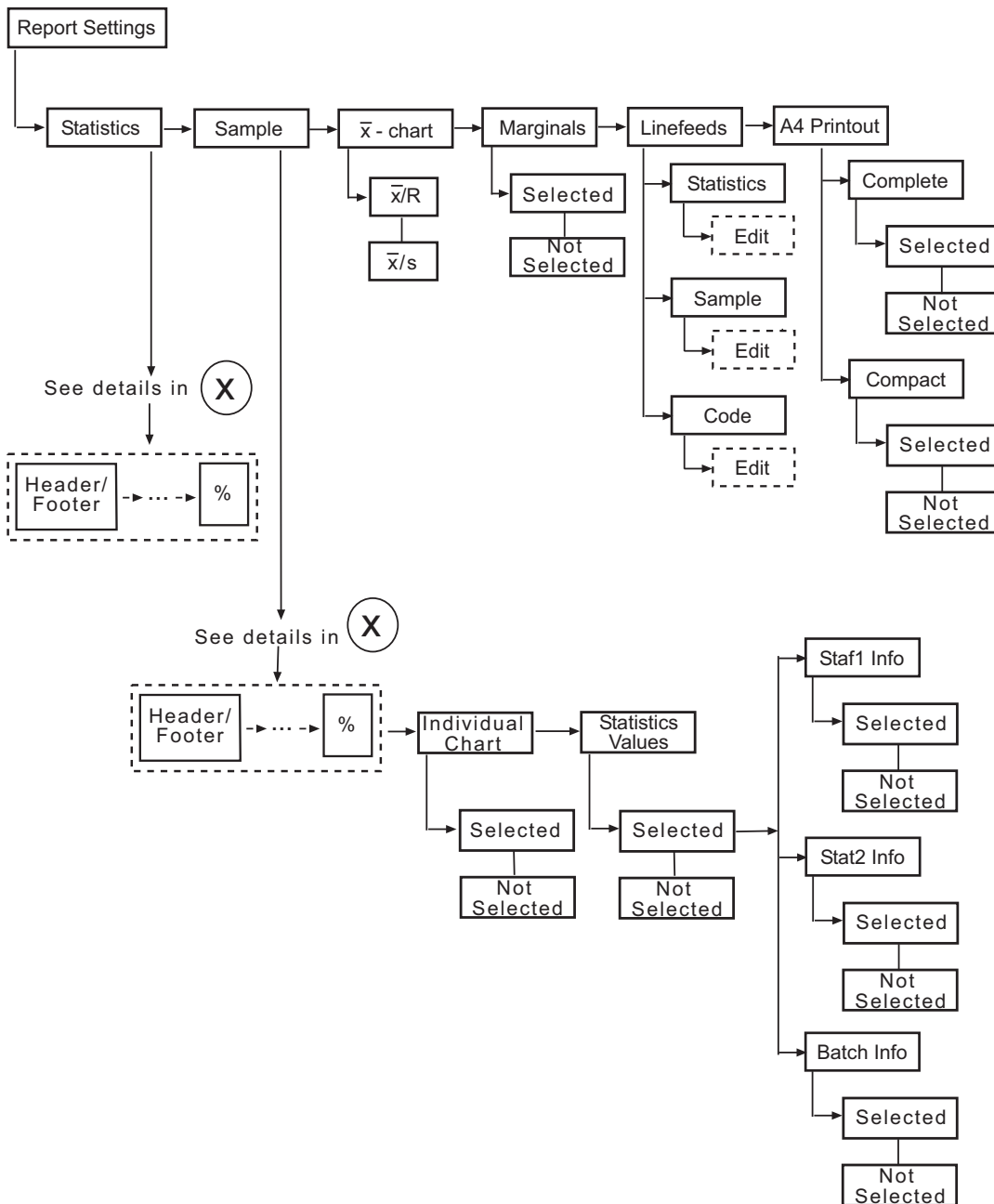

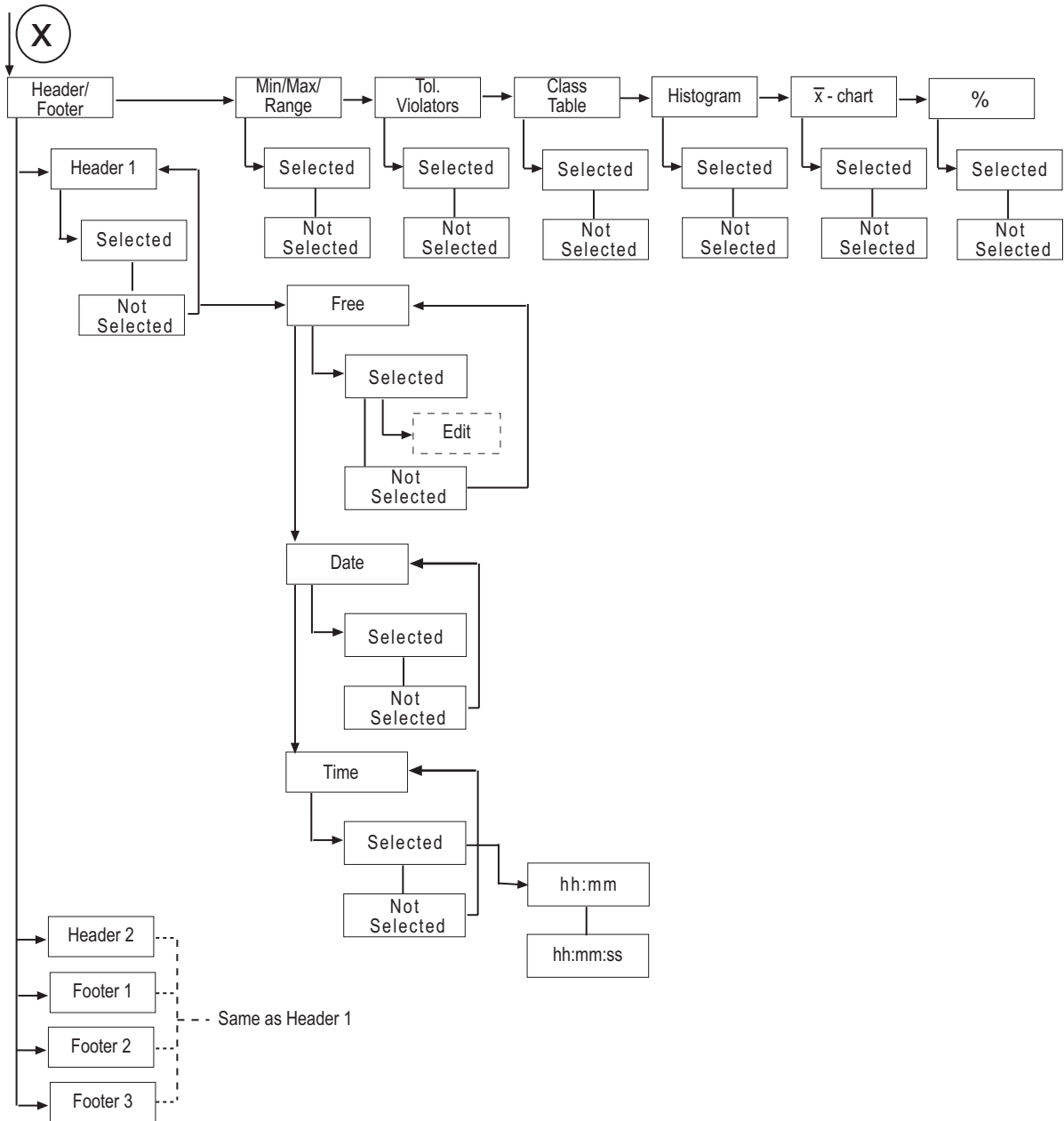

Press «>>» to enter the Report settings sub-menu.



The following selection appears:

"Statistics"

Define the content of the statistics report

"Sample"

Define the content of the sample report

"x-chart"

R(ange) or s in the mean value trace

"Marginals"

Switch reporting of marginals on or off

"Linefeeds"

Define number of linefeeds at the end of report

"A4 printout"

Switch report printing between Complete and Compact





5.11.1 Statistics and Sample reports

Both statistics and sample reports menu contain the same parameters except for the "Individual Chart" and "StatVal" parameters which are only available in the sample reports. To change settings, select the parameter "Statistics" or "Sample" accordingly, then press «».



Press «» to change Header/Footer settings.



Using «» and «», choose a header or a footer you wish to include in the printout and then press «».



...appears on the screen. Press «» to activate type of header or footer. The parameter "Free" is used to enter a text, and the parameter "Date" and/or "Time" is used to print date and time.

- "Free" Text entry using the alphanumeric/numeric keypad of the scale. Maximum 24 characters are possible, additional characters will be truncated.
- "Date" Switch date in the selected line on or off
- "Time" Format time printout in the selected line or switch off

If you wish to have the time in the selected line, you must define the format.

- "hh:mm" Time printout in the selected line in hours and minutes
- "hh:mm:ss" Time printout in hours, minutes and seconds

Note: In one line, you can print only a free text **or** date and/or time.

Notes: It is possible to print out the identification of the scale in the header or footer of a report by entering:

Example: Header 3 → Free → .I.	METTLER TOLEDO SQC16
Example: Footer 2 → Free → .S.	SNR: 2511378

If the printer connected to the scale is an EPSON LX-300 printer, the report can only be customized by setting Header1, Header2 and Footer1 as "Free".

5.11.2 Define contents of the report

The following information can be printed out in the statistics and sample reports:

- "Min/Max/Range" Minimum value/maximum value/range (=Max-Min) in the report
- "Tolerance" Tolerance violators in the report
- "Class table" Class table in the report
- "Histogram" Histogram in the report
- " \bar{x} -chart" Mean value trace in the report
- "%" \bar{x} /s/R/Min/Max/R in percent in the report
- "Individual Chart" Individual chart in the report (only in sample reports)
- "StatVal" Statistics values in the report (only in sample reports)

Select or unselect the desired information using «+✓» or «+□».



To print out minimum value, maximum value and difference in the report. The report will appear as follows:

Min	90.81%	72.65 g
Max	100.27%	80.22 g
R	9.46%	7.57 g



To print tolerance violators in the report. The report will appear as follows:

<T2-	0	0.00 %
<T1-	1	20.00 %
>T1+	0	0.00 %
>T2+	0	0.00 %

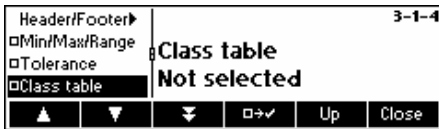

To print class table in the report. The report will appear as follows:

<T2-	0	0.00	%
<T1-	0	0.00	%
<T1-	1	3.33	%
-4	1	3.33	%
-3	2	6.66	%
-2	3	9.99	%
-1	4	13.32	%
+1	7	23.31	%
+2	8	26.64	%
+3	5	16.65	%
+4	2	6.66	%
>T1+	0	0.00	%
>T1+	0	0.00	%
>T2+	0	0.00	%



To print the histogram in the report. A histogram is a graphical representation of the distribution. The area of the rectangle is proportional to the number of individual values in the classes.

The range from Nominal to T1 is divided into 4 classes, from T1 to T2 (if used) into 2 classes, and from T2 to T3 (if used) into one class. The histogram will appear as follows:

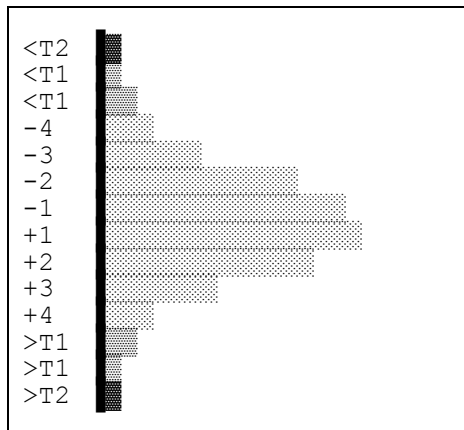

To print \bar{x} -chart (mean value trace) in the report.

The standard deviation (s trace) or the range of the values (R trace) of the last 10 samples can be shown in the left trace (selectable in the menu "x-Chart", see below), the right trace shows the mean values of the last 10 samples.

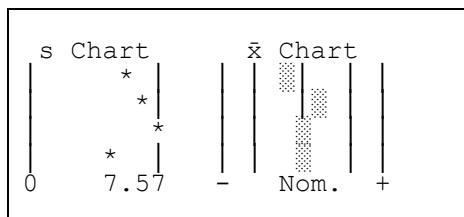



To print \bar{x} /s/Min/Max/R in percentage in the report.

Mean value, standard deviation, minimum value, maximum value and difference are also printed out relative to the nominal value. The report will appear as follows:

\bar{x}	96.68 %	77.350 g
s	3.71 %	2.965 g
Min	90.81 %	72.65 g
Max	100.27 %	80.22 g
R	9.46 %	7.57 g

The following information can be printed out **only** in the Sample report.

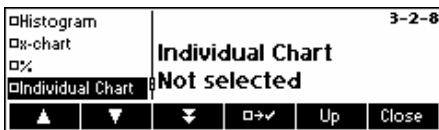

To print individual trace in the report.

The individual values of a sample are also shown graphically with the tolerances and violations. The report will appear as follows:

1	77.93				
2	76.61				
3	72.65				
4	79.34				
5	80.22				



To print some statistics values in the sample report.

"Stat1" Summary information of Statistics 1

"Stat2" Summary information of Statistics 2

"Batch" Summary information of Batch

Select or unselect the desired information using «» or «».

The report will appear e.g. as follows:

Stat.1: Sample#		3
\bar{x}	98.48%	78.784 g
s	3.71%	2.965 g
<T1-	1	6.67 %

5.11.3 \bar{x} -chart (Mean value trace)

In addition to the mean value ' \bar{x} ', either the 'Range' (heaviest individual value minus the lightest individual value) or the standard deviation 's' will be shown.



Press «**→**»

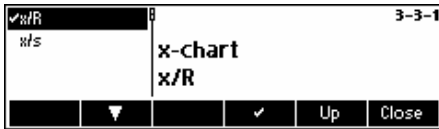

... select either \bar{x}/R (to show range) or \bar{x}/s (to show standard deviation) by «**☑**».

5.11.4 Marginals

Marginals are values less than the nominal value and greater than or equal to the negative tolerance limits. This can be switched on or off in the reports. They will only appear in the free tolerance systems.



Select or unselect Marginals using «**☑**» or «**☐**».

5.11.5 Linefeeds

For aesthetic purposes, empty lines (called linefeeds) may also be added at the end of the report.



Press «**→**» to add a linefeed in statistics, sample or code.



- "Statistics" Linefeeds at the end of statistics reports (1..3..99).
- "Sample" Linefeeds at the end of sample reports (1..3..99).
- "Code" Linefeeds at the end of the entry of codes (1..3..99).

5.11.6 A4 Printout

The operator has the option whether to print in Complete or Compact. The Complete version prints the whole report, while the Compact version prints only a selection of the report, and the font is much smaller.



Press «**3>>**» to define the printing settings.

- "Complete" Whole sample report will be printed, using normal font size
- "Compact" Selected parts of the sample report will be printed, using smaller font size reports

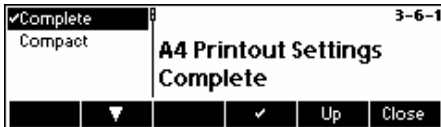

...appears when "Complete" is selected.

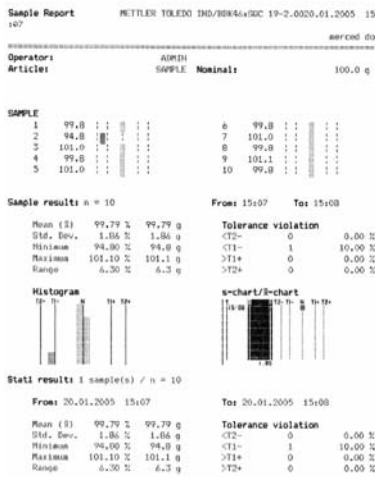

This is an actual report printed in "Complete" mode.

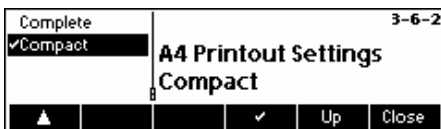

...appears when "Compact" is selected.

This is an actual report printed in "Compact" mode.

Note: The only added information not included in the compact printing are: Individual sample with charts, Tolerance System, Class Table, Violation Check, Histogram and s-chart/ \bar{x} -chart.

Sample result	Date: 20.01.2005	Time: 13:39	Operator: JA																											
SAMPLE 01	Nominal 100.0 ml	Tare (x,-) 14.8 g	Density 1.2500 g/ml																											
Qty Mean (x,-)	Std. Dev	Min.	Max.																											
10 100.14 ml	4.68 ml	93.00 ml	107.60 ml																											
Range	<T3-	<T2-	<T1-																											
14.60 ml	0	0	2																											
Marg	>T1+	>T2+	>T3+																											
3	1	0	0																											
<table border="1"> <thead> <tr> <th>Stat1</th> <th>From: 20.01.2005 - 13:39</th> <th>To: 20.01.2005 - 13:40</th> </tr> </thead> <tbody> <tr> <td>Qty Mean (x,-)</td> <td>Std. Dev</td> <td>Min.</td> <td>Max.</td> </tr> <tr> <td>10 100.14 ml</td> <td>4.68 ml</td> <td>93.00 ml</td> <td>107.60 ml</td> </tr> <tr> <td>Range</td> <td><T3-</td> <td><T2-</td> <td><T1-</td> </tr> <tr> <td>14.60 ml</td> <td>0</td> <td>0</td> <td>2</td> </tr> <tr> <td>Marg</td> <td>>T1+</td> <td>>T2+</td> <td>>T3+</td> </tr> <tr> <td>3</td> <td>1</td> <td>0</td> <td>0</td> </tr> </tbody> </table>				Stat1	From: 20.01.2005 - 13:39	To: 20.01.2005 - 13:40	Qty Mean (x,-)	Std. Dev	Min.	Max.	10 100.14 ml	4.68 ml	93.00 ml	107.60 ml	Range	<T3-	<T2-	<T1-	14.60 ml	0	0	2	Marg	>T1+	>T2+	>T3+	3	1	0	0
Stat1	From: 20.01.2005 - 13:39	To: 20.01.2005 - 13:40																												
Qty Mean (x,-)	Std. Dev	Min.	Max.																											
10 100.14 ml	4.68 ml	93.00 ml	107.60 ml																											
Range	<T3-	<T2-	<T1-																											
14.60 ml	0	0	2																											
Marg	>T1+	>T2+	>T3+																											
3	1	0	0																											
<table border="1"> <thead> <tr> <th>Stat2</th> <th>From: 20.01.2005 - 13:39</th> <th>To: 20.01.2005 - 13:40</th> </tr> </thead> <tbody> <tr> <td>Qty Mean (x,-)</td> <td>Std. Dev</td> <td>Min.</td> <td>Max.</td> </tr> <tr> <td>10 100.14 ml</td> <td>4.68 ml</td> <td>93.00 ml</td> <td>107.60 ml</td> </tr> <tr> <td>Range</td> <td><T3-</td> <td><T2-</td> <td><T1-</td> </tr> <tr> <td>14.60 ml</td> <td>0</td> <td>0</td> <td>2</td> </tr> <tr> <td>Marg</td> <td>>T1+</td> <td>>T2+</td> <td>>T3+</td> </tr> <tr> <td>3</td> <td>1</td> <td>0</td> <td>0</td> </tr> </tbody> </table>				Stat2	From: 20.01.2005 - 13:39	To: 20.01.2005 - 13:40	Qty Mean (x,-)	Std. Dev	Min.	Max.	10 100.14 ml	4.68 ml	93.00 ml	107.60 ml	Range	<T3-	<T2-	<T1-	14.60 ml	0	0	2	Marg	>T1+	>T2+	>T3+	3	1	0	0
Stat2	From: 20.01.2005 - 13:39	To: 20.01.2005 - 13:40																												
Qty Mean (x,-)	Std. Dev	Min.	Max.																											
10 100.14 ml	4.68 ml	93.00 ml	107.60 ml																											
Range	<T3-	<T2-	<T1-																											
14.60 ml	0	0	2																											
Marg	>T1+	>T2+	>T3+																											
3	1	0	0																											
<table border="1"> <thead> <tr> <th>Batch</th> <th>From: 20.01.2005 - 13:39</th> <th>To: 20.01.2005 - 13:40</th> </tr> </thead> <tbody> <tr> <td>Qty Mean (x,-)</td> <td>Std. Dev</td> <td>Min.</td> <td>Max.</td> </tr> <tr> <td>10 100.14 ml</td> <td>4.68 ml</td> <td>93.00 ml</td> <td>107.60 ml</td> </tr> <tr> <td>Range</td> <td><T3-</td> <td><T2-</td> <td><T1-</td> </tr> <tr> <td>14.60 ml</td> <td>0</td> <td>0</td> <td>2</td> </tr> <tr> <td>Marg</td> <td>>T1+</td> <td>>T2+</td> <td>>T3+</td> </tr> <tr> <td>3</td> <td>1</td> <td>0</td> <td>0</td> </tr> </tbody> </table>				Batch	From: 20.01.2005 - 13:39	To: 20.01.2005 - 13:40	Qty Mean (x,-)	Std. Dev	Min.	Max.	10 100.14 ml	4.68 ml	93.00 ml	107.60 ml	Range	<T3-	<T2-	<T1-	14.60 ml	0	0	2	Marg	>T1+	>T2+	>T3+	3	1	0	0
Batch	From: 20.01.2005 - 13:39	To: 20.01.2005 - 13:40																												
Qty Mean (x,-)	Std. Dev	Min.	Max.																											
10 100.14 ml	4.68 ml	93.00 ml	107.60 ml																											
Range	<T3-	<T2-	<T1-																											
14.60 ml	0	0	2																											
Marg	>T1+	>T2+	>T3+																											
3	1	0	0																											

5.12 Printing summary of database

This function allows you to print out the summary of all articles stored in the database.



Press «**Print/Clr**»



...appears on the screen. Press «**Reports**».

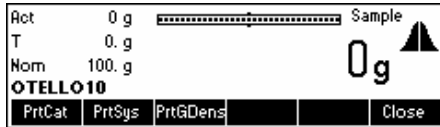

...appears on the screen. Press «**PrtCat**» to print out the catalog, «**PrtSys**» to print all parameter of 'System' or «**PrtGDens**» to print a list with the values of the 30 density groups.



...appears on the screen. The attached printer will print out the following information of all articles stored in the database:

Article index

Article Name

Name of 2nd tol.sys article (only if defined)

Article number (only if defined)

Article ID (only if defined)

Nominal

Supplement (only if defined)

Target (only if supplement and adjustment are defined)

Tare

Density (only if unit is for liquid)

Tolerance system

Individual tare (only if active)

Common article (only if defined)

6 Special features of SQC16

6.1 Working with barcodes

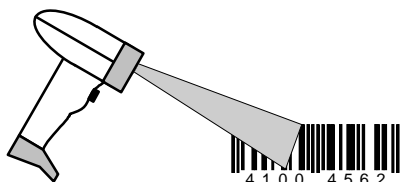

The SQC16 system can be equipped with a bar code reader. When the article data are defined, e.g. the following parameters can be read in: Article name, article number, identification, user name, text for header and footers in the printout.

If you wish to select the articles for sampling, using the bar code reader, you must define the number of the bar code (e.g. EAN) as article number.

To activate, the desired article can be selected directly by reading in the bar code.

In sampling mode, also the batch number can be read in with the bar code.

6.2 Individual tare sampling





There are two possible ways to work with individual tare:

- 1,1..2,2 Preweighing and backweighing are in two samples. First, all preweighings are done in one sample and afterwards, the backweighings are done in the same order as the preweighings in a second sample.
- 1,2..1,2 Preweighings and backweighings are in one sample. After every preweighing, the backweighing follows immediately.

Preweighings can be gross values (→ backweighing: tare value) or tare values (→ backweighing: gross value). Any defined mean tare value from the database will have its effect to calculate the net value as well.

Note: When you are done with preweighing but not with backweighing, you will not be able to delete the sampling unless you press «**Start**» and then «**End**».

6.2.1 Preweighing and backweighing in two samples

Activate individual tare sampling by defining an article with its "Ind. Tare" parameter selected. Press the «» and select the article you wish to use. Press "Options", then "Define" then press «» until the parameter "Ind. Tare" is highlighted. Press «» and choose mode "1,1 .. 2,2" and then press «» to activate this individual tare mode.

Act	0.0 g	Sample
T	0.0 g	
Nom	100.0 g	0.0 g 
AQUA VIDA.1		
Start	Test	Tare
	Print/Clr	Weigh

".1" appears immediately after the article name, indicating that SQC16 is now ready for preweighing. Press «**Start**» to commence sampling.



...appears on the screen. SQC16 is now ready to perform the preweighing.

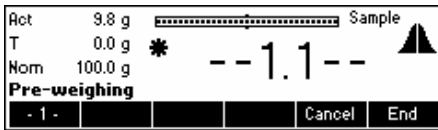

First container was placed on the scale.



Continue procedure until the fifth container has been placed on the scale.

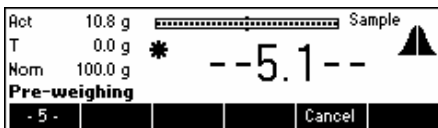

Fifth (which is here also the last) container was placed on the scale.

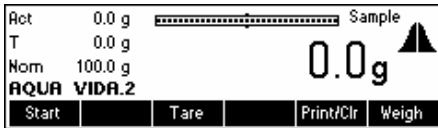

".2" appears immediately after the article name, indicating that SQC16 is now ready for backweighing. Press «Start» to commence sampling.

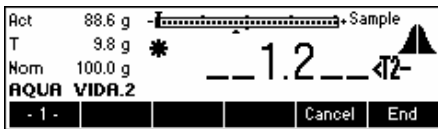

Place the first sample together with the first container on the scale.



Then, place second sample and second container on the scale. Continue procedure until the fifth sample has been placed.



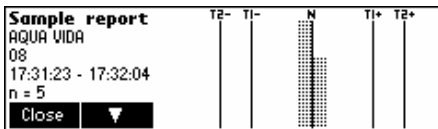

...appears on the screen. Wait until the printout of the sample report is done.

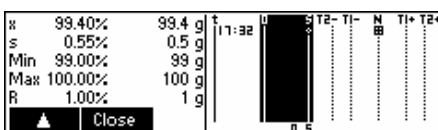
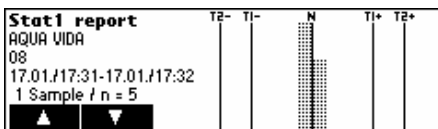
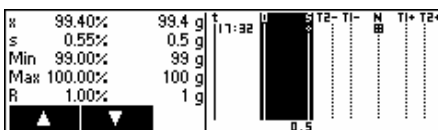

...appears on the screen. SQC16 has generated a report. Press «Close» to close the Sample Report. Press «▼» to scroll down to see the rest of the statistics.



...end of statistics report. Press «» or «C» to close the end of sampling messages (see also «»/System/Messages). Press «Close» to close the Sample Report.

6.2.2 Preweighing and backweighing in one sample

Activate individual tare sampling by defining an article with its "Ind. Tare" parameter selected. Press the and select the article you wish to use. Press "Options", then "Define", then press until the parameter "Ind. Tare" is highlighted. Press and choose mode "1,2 .. 1,2" and then press again to activate this individual tare mode.

Note: When you are done with preweighing but not with backweighing, you will not be able to delete the sampling unless you press **«Start»** and then **«End»**.



".1" appears immediately after the article name, indicating that SQC16 is now ready for preweighing. Press **«Start»** to commence sampling.

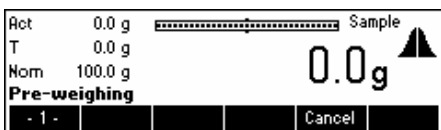

...appears on the screen. SQC16 is now ready to perform the preweighing.

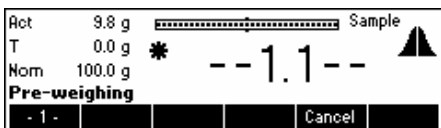

Place the first container on the scale (In this example: Pre-weighing of tare values, not gross values).

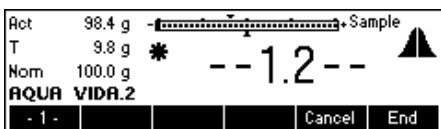

Place the first sample, incl. container, on the scale. The container's weight value becomes the tare weight and is subtracted from the gross weight. Actual weight is shown on the upper left-hand corner of the screen (Act).

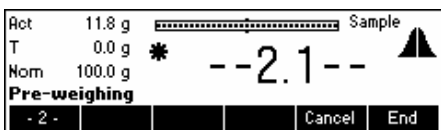

Place the second container on the scale.

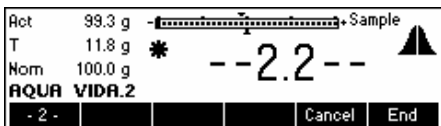

Place the second sample, incl. container, on the scale.

•
•
•

Continue procedure until the fifth container and fifth sample have been placed on the scale accordingly (in this example: -n- = 5).



...appears on the screen. Wait until the printout of the sample report is done.

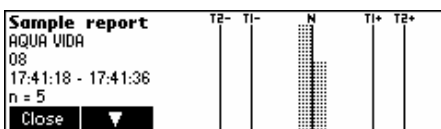

...appears on the screen. SQC16 has generated a report. Press **«Close»** to close the Sample Report. Press to scroll down to see the rest of the statistics.

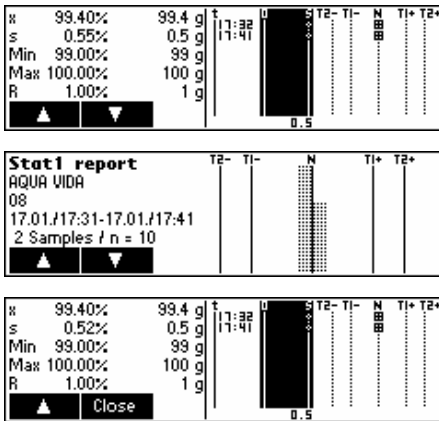

54



...end of statistics report. Press «» or «C» to close the end of sampling messages (see also «»/System/Messages). Press «Close» to close the Sample Report.

6.3 Sampling with batch

Batch sampling means to have a batch identification for sampling data. Each batch has its own batch statistics.

Activate batch sampling by pressing the «» and select the article you wish to use. Press "Options", then "Define", then press «» until the parameter "Batch" is highlighted. Press «» to activate batch sampling mode.



Press «Start» to commence sampling.



...appears on the screen. Using the keypad, type in the name of the batch and then press the «OK»

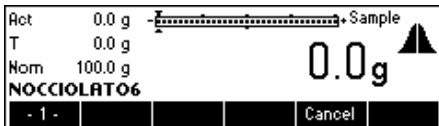

...appears on the screen. SQC16 is now ready for batch sampling.

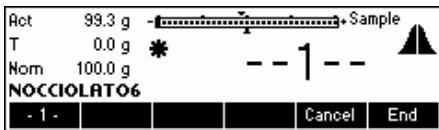

Place first sample on the scale.

•
•
•

Continue procedure until the fifth sample has been placed on the scale



Continue procedure until the fifth sample has been placed on the scale

....appears on the screen. Wait until the printout of the sample report is done.

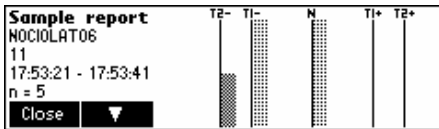

...appears on the screen. SQC16 has generated a report. Press «Close» to close the Sample Report. Press «▼» to scroll down to see the rest of the statistics.

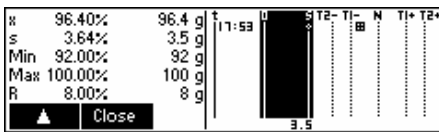
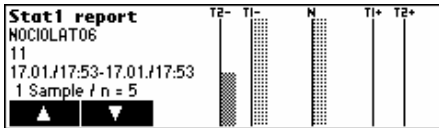
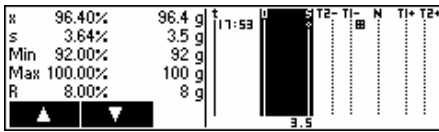



...end of statistics report. Press «» or «C» to close the end of sampling messages (see also «»/System/Messages). Press «Close» to close the Sample Report.

Note: When a new batch name is defined, SQC16 will automatically print and then clear the previous batch statistics. You may then commence with a new batch statistics.

6.4 Transfer key

Using the transfer key enables you to control the weighing procedure especially for items that require filling or dosing.

Activate transfer key by pressing the «» and select the article you wish to use. Press "Options", then "Define", then press «▼» until the parameter "Transfer key" is highlighted. Press «» to activate transfer key mode.



Press «Start» to commence sampling.

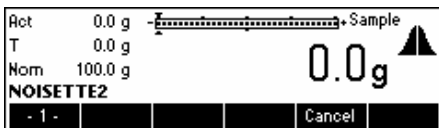

...appears on the screen.

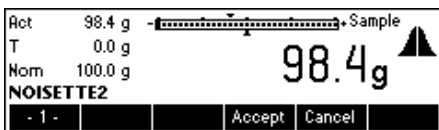

Place first sample on the scale. Press «Accept» to accept the value.

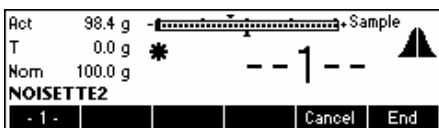

...appears on the screen.



Continue procedure until the fifth sample has been placed on the scale



...appears on the screen. Wait until the printout of the sample report is done.

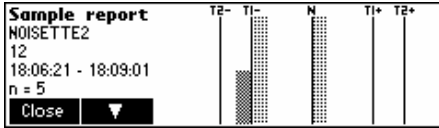

...appears on the screen. SQC16 has generated a report. Press «Close» . to close the Sample Report. Press «▼» to scroll down to see the rest of the statistics.

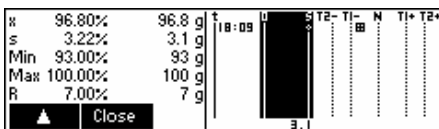
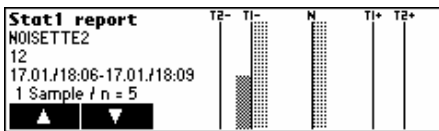
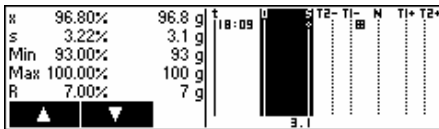

...end of statistics report. Press «» or «C» to close the end of sampling messages (see also «»/System/Messages). Press «Close» to close the Sample Report.

7 Vision Setup

Vision Setup can be used to change the settings of the scale and to activate functions, thereby allowing the scale to be adapted to individual weighing needs.

Important: We recommend defining your own supervisor password (→ Chapter 3.2).

7.1 Overview and operation

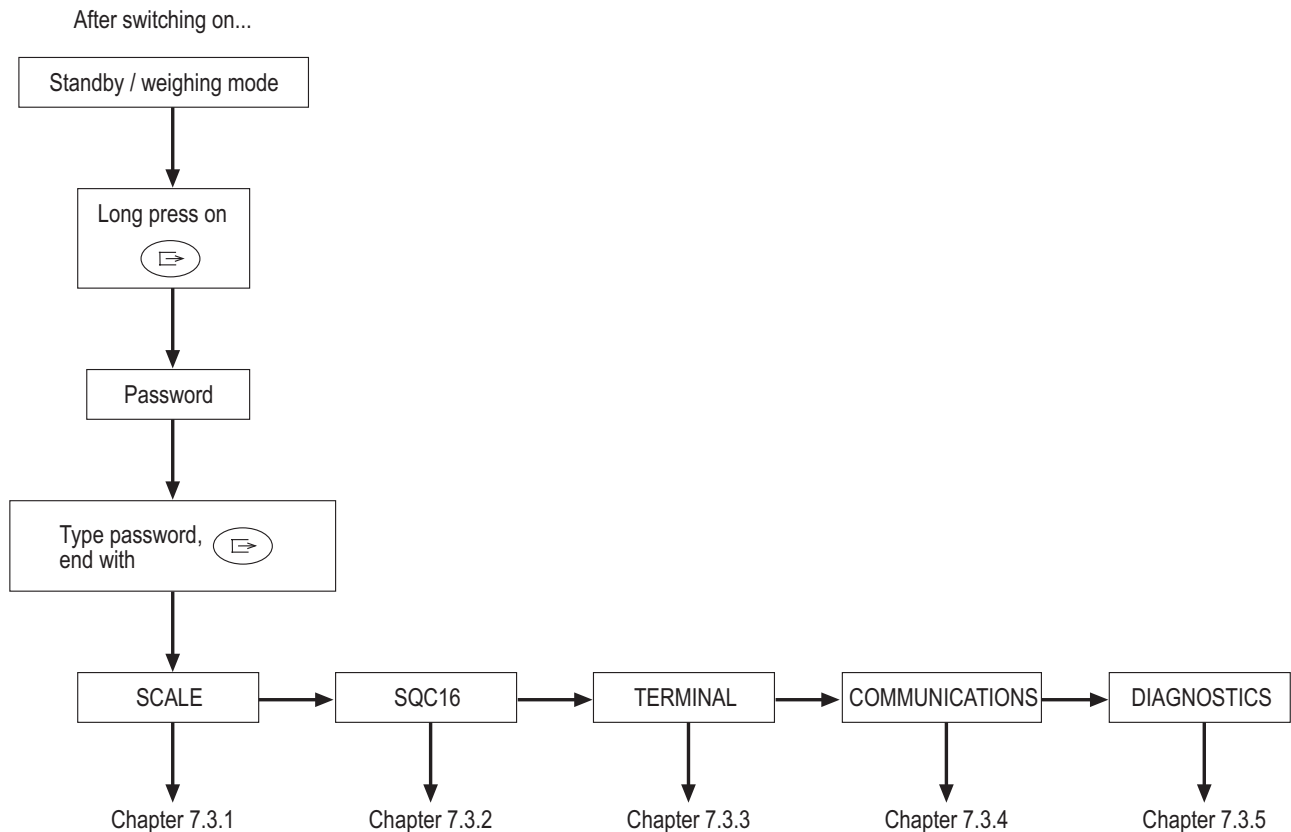

Navigating through the Vision Menu is done through the six softkeys found at the bottom of the display. The softkeys change depending on the currently selected menu item to allow the user to perform the appropriate action for the selected item.



This softkey selects the previous item listed on the current menu.



This softkey selects the next item listed on the current menu.



This softkey selects the first item on the next "page" of the menu. If all the items for the current menu are visible (i.e. there are four or less items for the current menu), this softkey is not visible.

- >>** This softkey enters the submenu of the currently selected item. If the currently selected item does not have a submenu, this softkey is not visible.
- Up** This softkey leaves the current submenu and goes one level up. If the Vision Menu is already at the top level, pressing this softkey is similar to pressing «**End**» (see below).
- Edit** This softkey allows the user to edit the value or setting of the currently selected item. If the currently selected item contains a submenu, this softkey is not visible.
- Yes** Some menu items perform specific actions rather than editing. Pressing this softkey directs the Vision Menu to perform the action specified by the currently selected menu item.
- End** This softkey can be pressed at any time to leave the Vision Menu. The Vision Menu will then prompt the user to save or discard the changes the user has made. The user may also press «**Cancel**» at this time to go back to the Vision Menu.

7.2 Calling up the menu and entering the password

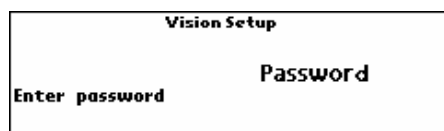



Press «  » key and hold it down until the prompt to enter the password appears.



User: No password required, just press «  » key.

Supervisor: Enter password (sequence of keystrokes, Chapter 7.7)

immediately and confirm with the «  » key. Otherwise, after a few seconds, the scale returns to weighing mode. If an incorrect password is entered, the menu cannot be called up. **Note:** When the scale leaves the factory, no supervisor password is defined, so when the password is requested, just press «  » key.

7.3 Menu overview

7.3.1 Scale

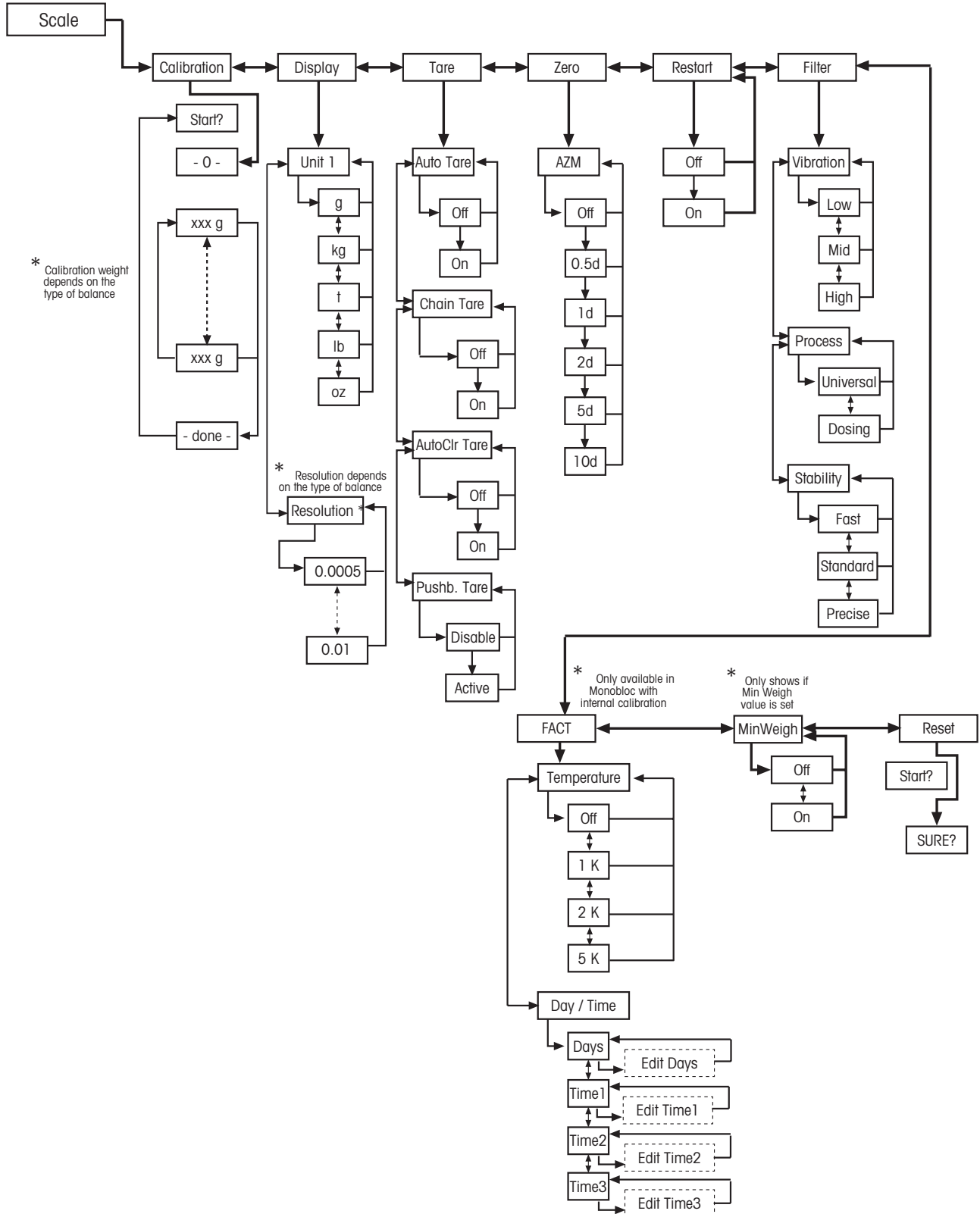

7.3.2 SQC16

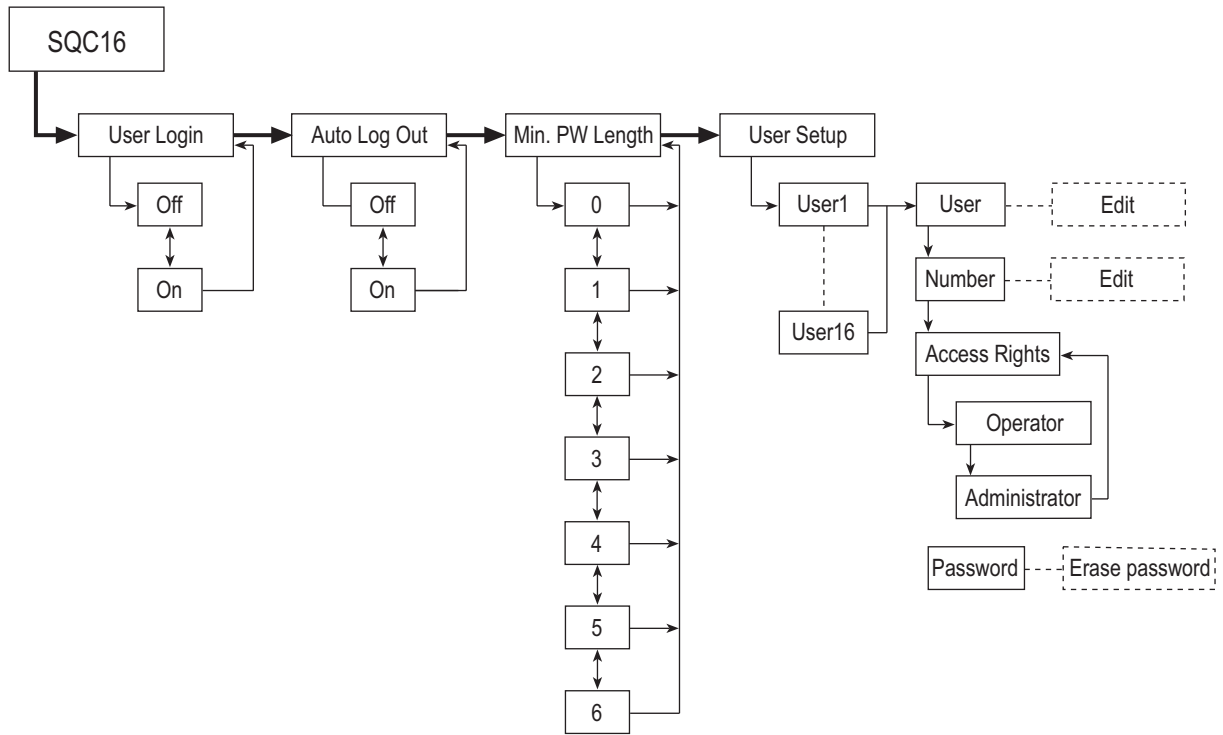

7.3.3 Terminal

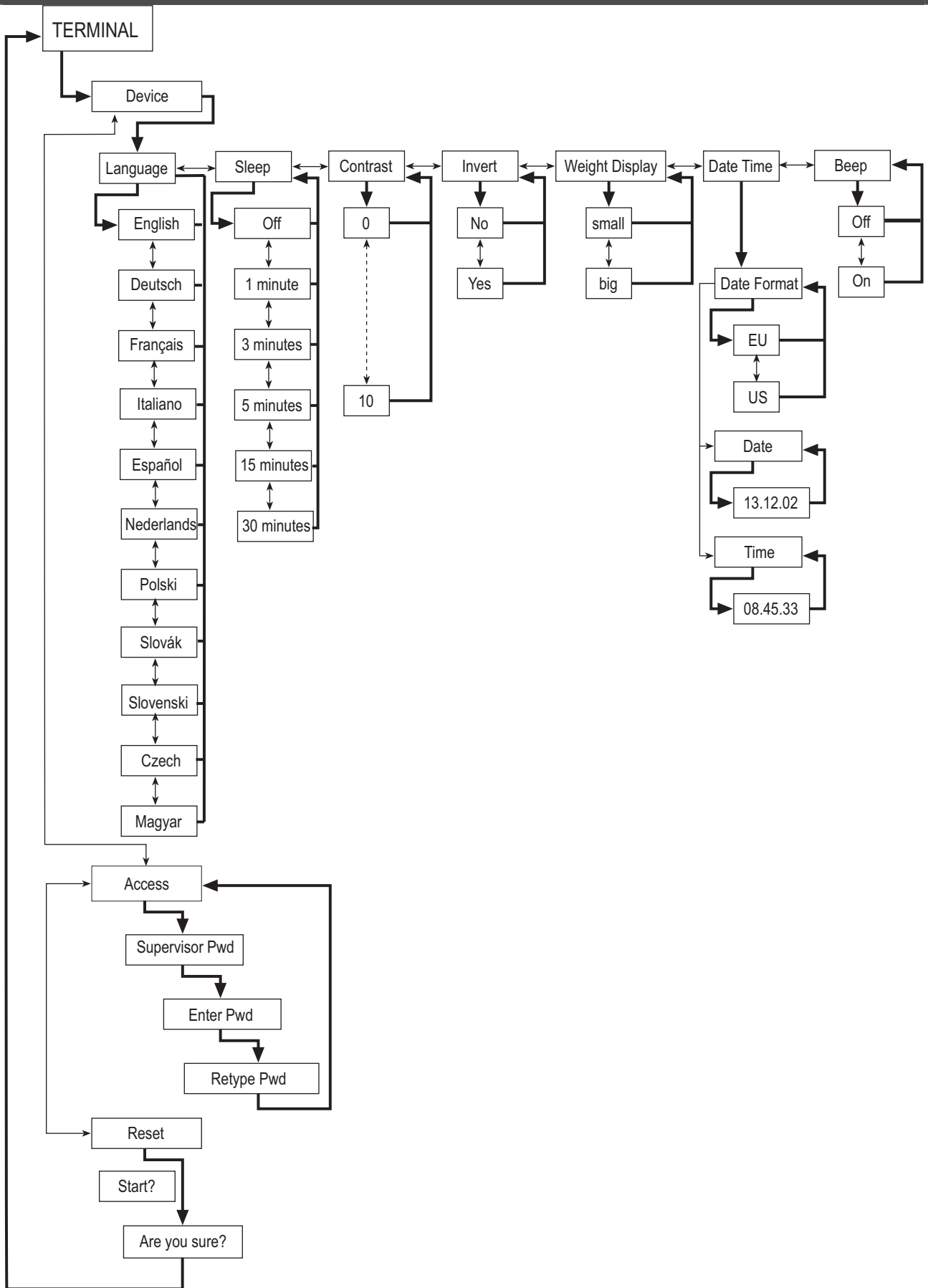

7.3.4 Communication

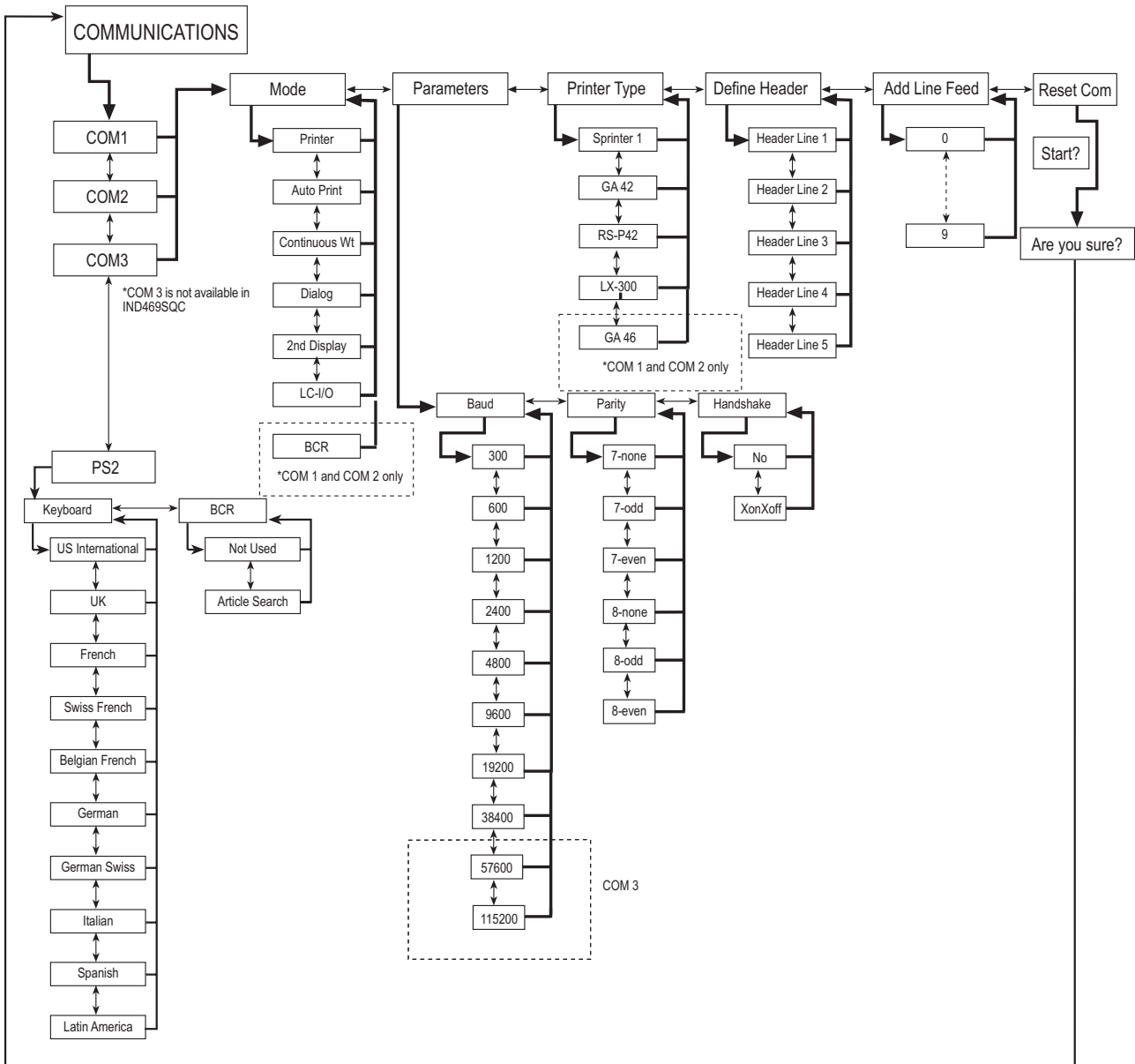

7.3.5 Diagnostics

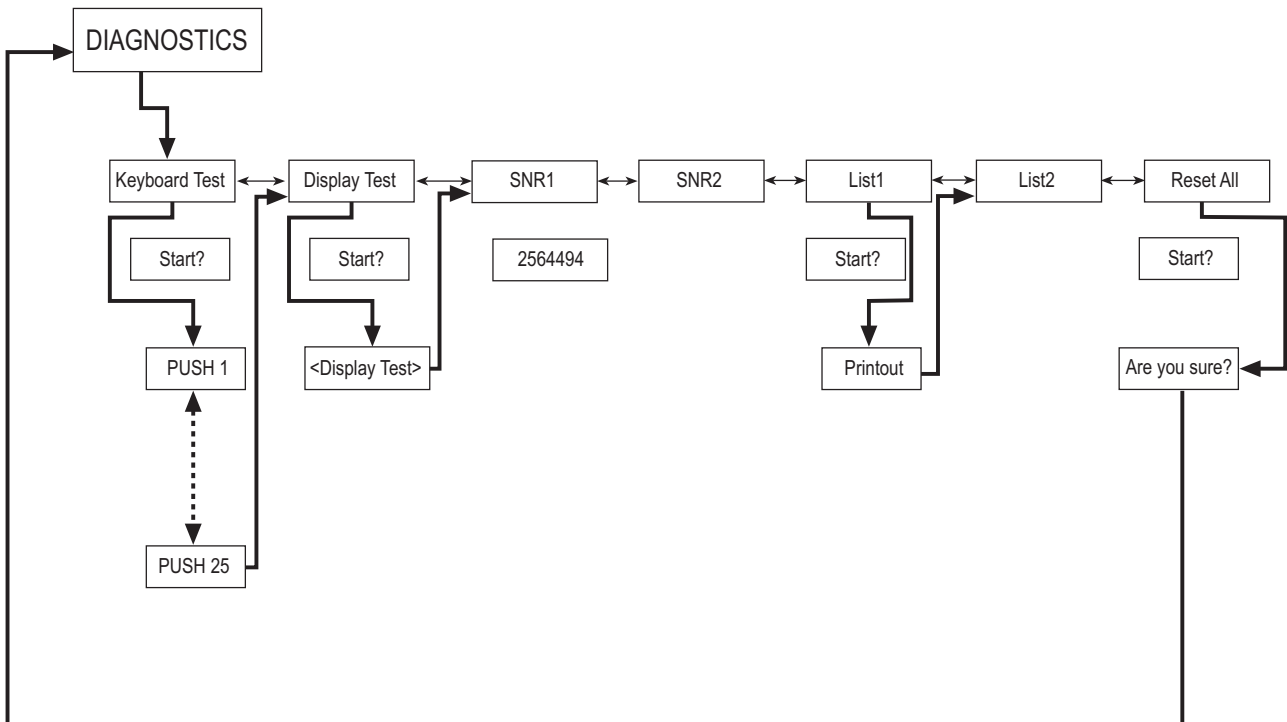

7.4 Scale settings (SCALE)

This function block allows the user to change general scale functionality.

Please refer to Chapter 7.3.1 on how to reach the menu position 'Vision Setup → SCALE' and how to navigate within the 'Vision Setup'-menu.

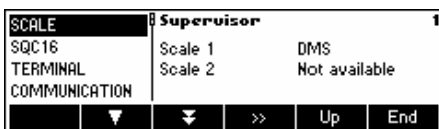

The screen on the right hand side shows the most important scale settings as a preview.

Enter the SCALE menu (◀▶▶▶) and choose one of the functions listed below.

Available functions and settings:

- Adjust/calibrate the scale → Chapter 7.4.1
- Display accuracy and weighing unit → Chapter 7.4.2
- Tare settings → Chapter 7.4.3
- Automatic zero point correction → Chapter 7.4.4
- Automatic storage of tare and zero values → Chapter 7.4.5
- Adaptation to environmental conditions and weighing mode → Chapter 7.4.6
- Automatic adjustment(FACT) → Chapter 7.4.7
- Minimum weight → Chapter 7.4.8
- Reset 'SCALE' settings to factory settings → Chapter 7.4.9

7.4.1 Adjust/calibrate (SCALE → Calibration)

This function enables the scale to be adjusted/calibrated (weighing pan must be empty). **Not available on certified scales!**

Please refer to Chapter 7.3.1 on how to reach the menu position 'Vision Setup → SCALE → Calibration' and how to navigate within the 'Vision Setup'-menu.



Press «**Yes**» and follow the instructions given on the screen.

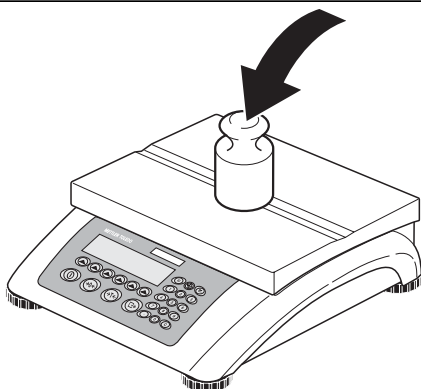

After choosing the calibration weight, place the weight on the weighing pan and then press «**OK**».

It is recommended to use the maximum calibration weight from the list. If it is not possible to use the maximum weight, at least do not use less than one-third of the maximum load to ensure reliable weighing values.



Calibration is done. Continue with other functions or press «**End**» and confirm with «**Yes**» to save the changes.

Note: Abort calibration at any given time by pressing «**Cancel**».

7.4.2 Display resolution and weighing unit (SCALE → Display)

This function allows the user to change the weighing unit, and to set the resolution of the weight.

Please refer to Chapter 7.3.1 on how to reach the menu position 'Vision Setup → SCALE → Display' and how to navigate within the 'Vision Setup'-menu.



Press «**>>**» and select e.g. '**Unit 1**', then «**Edit**» to change the unit.

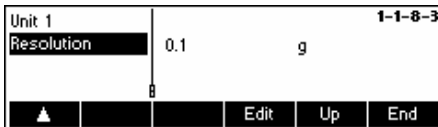

In order to change the settings of the resolution of the scale, select **'Resolution'**.



Use «▲» and «▼» to select the desired resolution and press «OK».

7.4.3 Automatic zero point correction (SCALE → Tare)

This function allows the user to configure all the available tare function of the scale.

Please refer to Chapter 7.3.1 how to reach the menu position 'Vision Setup _ SCALE _ Tare' and how to navigate within the 'Vision Setup'-menu.



Switch the available functions **Auto Tare, Chain Tare, AutoClr Tare or Pushb. Tare** either On or Off.

Automatic tare automatically tares the scale once a load ($\geq 9d$) is placed on the weighing pan. If this is active, the icon AT flashes on the lower right side of the display.

Chain tare allows several tare actions without clearing the tare memory. If this is not active, the tare memory has to be cleared by pressing the «C» softkey. The tare memory has to be cleared before a new tare can be performed.

Automatic clear tare automatically clears the tare memory once the load is removed from the weighing pan.

Push button tare enables/disables the use of the «→T←» key to perform manual taring.

7.4.4 Automatic zero point correction (SCALE → Zero)

With Auto Zero, small deviations in the weight (in the range of 50% of 1d) are automatically zeroed. **Always active for certified scales!**

Please refer to Chapter 7.3.1 on how to reach the menu position 'Vision Setup → SCALE → Zero' and how to navigate within the 'Vision Setup'-menu.



Press «>>» to go to the Auto Zero settings.

Press «Edit» to assign the zero setting range or to switch the function off.

7.4.5 Automatic save of tare and zero values (SCALE → Restart)

This function allows the user to set the scale so that it is able to automatically save the tare and zero values after switching off or when a power outage occurs. **Not available on certified scales. Automatic save switched off is the factory setting.**

Block can only be accessed by a supervisor.

Please refer to Chapter 7.3.1 on how to reach the menu position 'Vision Setup → SCALE → Restart' and how to navigate within the 'Vision Setup'-menu.



Press «**Edit**» to switch the automatic save switch function on or off.

7.4.6 Adaptation to environmental conditions and weighing mode (SCALE → Filter)

Vibration function allows the user to set the scale so that it is able to adapt itself to the existing environmental conditions.

Process function allows the user to set the weighing mode of the scale (weighing process adapter).

Stability function allows the use to adjust the weighing speed.

Please refer to Chapter 7.3.1 on how to reach the menu position 'Vision Setup → SCALE → Filter' and how to navigate within the 'Vision Setup'-menu.

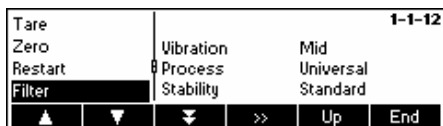

Press «**>>**» to go to the vibration and process settings menu.

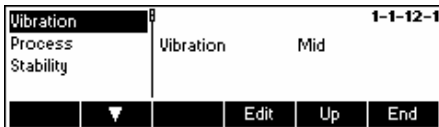

Vibration:

Low: For very stable and stable environment. Scale operates very quickly but is more sensitive to external influences.

Mild: For normal environment conditions. Scale operates at medium speed (**factory setting**).

High: For unstable environment. Scale operates more slowly but is less sensitive to external influences.

Process:

Universal: Setting for all weighing types and normal weighing goods (**factory setting**)

Dosing: Setting for dispensing liquids or powdery substances.

Stability:

Fast: The scale operates very fast.

Standard: The scale operates of medium speed.

Precise: The scale operates with the greatest possible reproducibility. The slower the scale works, the greater the reproducibility.

7.4.7 Automatic adjustment (SCALE → FACT)

FACT function allows the user temperature or time dependent adjustment. This menu item only appears on scales with an internal adjustment weight.

Please refer to Chapter 7.3.1 on how to reach the menu position 'Vision Setup → SCALE → FACT' and how to navigate within the 'Vision Setup'-menu.



Press «>>» to go to the FACT settings.

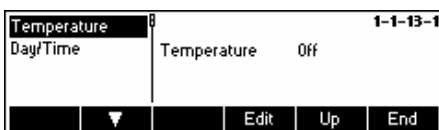

Press «Edit» to select the menu item temperature.

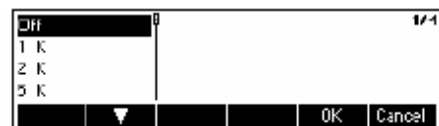

Use the «▼» softkey to select the desired temperature difference for the automatic adjustment.

Press «OK».



Defining up to 7 days of the week and up to 3 times for automatic adjustment.

- Select day of the week for automatic adjustment. 7 zeros appear in the display. The first zero stands for Monday, the second for Tuesday, the third for Wednesday etc.

- Use the key to go to the desired day of the week and enter 1. The display 0100100 means that Tuesday and Friday are selected as calibration days.

- Press «OK». Time 1 appears in the display.

- Enter the time(s) for the calibration (hours, minutes). The format for entering the time (EU or US) depends on the settings in the menu item TERMINAL-> Device.

- Press «OK».

Note: apart from the calibration days at least one time has to be defined in order to activate the time controlled calibration!

7.4.8 Minimum weight (SCALE → Min Weigh)

Min Weigh function allows the user to switch the minimum weight on and off. If the weight on the scale falls below the stored minimum value, an * appears on the display in front of the weight indicator. This menu item only appears if the service technician has saved a minimum weight.

Please refer to Chapter 7.3.1 on how to reach the menu position 'Vision Setup → SCALE → Min Weigh' and how to navigate within the 'Vision Setup'-menu.



Press «>>» to go to the Min Weigh settings.



Press «Edit» to switch the minimum weight monitoring on/off.



7.4.9 Resetting scale to factory default settings (SCALE → Reset)

This function resets the 'SCALE' block to its original factory settings. Can only be accessed by a supervisor.

Please refer to Chapter 7.3.1 on how to reach the menu position 'Vision Setup → SCALE → Reset' and how to navigate within the 'Vision Setup'-menu.



Press «**Yes**» to reset the scale settings. 'SURE?' will appear, press «**Yes**» to confirm. The scale settings are now reset to its original factory settings.

7.5 SQC16 settings (SQC16)

This function block allows the user to change the SQC16 application specific settings of the scale. Can only be accessed by a supervisor.

Please refer to Chapter 7.3.2 on how to reach the menu position 'Vision Setup → SQC16' and how to navigate within the 'Vision Setup'-menu.



Enter the SQC16 menu («>>>») and choose one of the functions listed below.

Available functions and settings:

- User Login → Chapter 7.5.1
- Auto Log Out → Chapter 7.5.2
- Minimum Password Length → Chapter 7.5.3
- User Setup → Chapter 7.5.4

The screen shows the most important application settings as a preview.

7.5.1 User Login (SQC16 → User Login)

If this function is turned off, SQC16 will allow the application to operate without the user having to log in.

Please refer to Chapter 7.3.2 on how to reach the menu position 'Vision Setup → SQC16 → User Login' and how to navigate within the 'Vision Setup'-menu.



Press «**Edit**» to switch User Login on or off.



Confirm selection by pressing «**OK**».

7.5.2 Auto Log Out (SQC16 → Auto Log Out)

This function, if activated, automatically logs you out after each sampling procedure.

Please refer to Chapter 7.3.2 on how to reach the menu position 'Vision Setup → SQC16 → Auto Log Out' and how to navigate within the 'Vision Setup'-menu.

User Login		2-2
Auto Log Out	Auto Log Out Off	
Min. PW Length		
User Setup		
▲	▼	Edit Up End

Press «**Edit**» to switch on or off.

Off	0	1/2
On		
▼		OK Cancel

Confirm selection by pressing «**OK**».

7.5.3 Minimum Password Length (SQC16 → Minimum PW Length)

With this function, you can specify the minimum length of the passwords to be defined. If the user defines a password that has less than the specified number of digits, SQC16 will give a message that the password is invalid.

Please refer to Chapter 7.3.2 on how to reach the menu position 'Vision Setup → SQC16 → Minimum PW Length' and how to navigate within the 'Vision Setup'-menu.

User Login		2-3
Auto Log Out	Min PW Length 0	
Min. PW Length	0	
User Setup		
▲	▼	Edit Up End

Press «**Edit**» to change the minimum length of password.

0	0	1/7
1	Min PW Length	
2		
3		
▼	▼	OK Cancel

Select the desired number of length and confirm selection by pressing «**OK**».

7.5.4 User Setup (SQC16 → User Setup)

This function allows you to define and set up a maximum of 16 users that can work with SQC16 if "User Login" (Chapter 7.5.1) is switched on. You can define their name, ID number, type of access rights and reset their passwords from this function.

Please refer to Chapter 7.3.2 on how to reach the menu position 'Vision Setup → SQC16 → User Setup' and how to navigate within the 'Vision Setup'-menu.

User Login		2-4
Auto Log Out		
Min. PW Length		
User Setup		
▲	▼	Edit Up End

Press «**Edit**» to set up a new user or modify the settings of an existing user.



Use «▲» and «▼» to select the user you wish to modify. To define a new user, select "<EMPTY>" from the user list and press «Edit» to modify the settings of the selected user.



Use «▲» and «▼» to select the parameter you wish to modify and press «Edit».

- User** User name (must be unique)
- Number** User ID number
- Access Rights** Select whether the user has Administrator or Operator access rights. An Operator cannot enter the «⬆».
- Password** Reset the user's password.

7.6 Terminal settings for device (TERMINAL → Device)

This function block allows the user to change display and peripheral oriented settings of the scale. Only the "Device" block is available to the user.

Please refer to Chapter 7.3.3 on how to reach the menu position 'Vision Setup → TERMINAL → Device' and how to navigate within the 'Vision Setup'-menu.



The screen shows the most important terminal settings as a preview.



The screen shows a preview of the most important settings of the active item, e.g. those of device if 'Device' is active (i.e. highlighted).

Enter the TERMINAL menu («>>>») and choose one of the functions listed below.

Available functions and settings:

- Language settings → Chapter 7.6.1
- Sleep function → Chapter 7.6.2
- Contrast → Chapter 7.6.3
- Invert → Chapter 7.6.4
- Weight display → Chapter 7.6.5
- Date and time → Chapter 7.6.6
- Beep → Chapter 7.6.7

7.6.1 Language settings (TERMINAL → Device → Language)

This function allows the user to change the language settings of the scale.

Please refer to Chapter 7.3.3 on how to reach the menu position 'Vision Setup → TERMINAL → Device → Language' and how to navigate within the 'Vision Setup'-menu.



Press «**Edit**» to go to the Language settings menu.



Use «**▲**» and «**▼**» to select the desired language setting and press «**OK**».

7.6.2 Sleep function (TERMINAL → Device → Sleep)

This function is useful to enhance the lifetime of the display backlight.

Please refer to Chapter 7.3.3 on how to reach the menu position 'Vision Setup → TERMINAL → Device → Sleep' and how to navigate within the 'Vision Setup'-menu.



Press «**Edit**» to go to the Sleep settings menu.



The display backlight will turn itself off automatically when the selected time elapses.

7.6.3 Adjusting the contrast of the display (TERMINAL → Device → Contrast)

This function allows the user to adjust the contrast of the screen display.

Please refer to Chapter 7.3.3 on how to reach the menu position 'Vision Setup → TERMINAL → Device → Contrast' and how to navigate within the 'Vision Setup'-menu.



Press «**Edit**» to go to the Contrast settings menu.



Select the degree of contrast using «**▲**» or «**▼**». Press «**OK**» to confirm selection.

7.6.4 Invert (TERMINAL → Device → Invert)

This function allows the user to select either a white or a black background of the screen display.

Please refer to Chapter 7.3.3 on how to reach the menu position 'Vision Setup → TERMINAL → Device → Invert' and how to navigate within the 'Vision Setup'-menu.



Press «**Edit**» to go to the Invert settings menu.



Choose the desired setting (Yes or No) and then press «**OK**» to confirm selection.

7.6.5 Changing the size of weight display (TERMINAL → Device → Weight display)

This function allows the user to select either a small or a big weight display on the screen.

Please refer to Chapter 7.3.3 on how to reach the menu position 'Vision Setup → TERMINAL → Device → Weight display' and how to navigate within the 'Vision Setup'-menu.



Press «**Edit**» to go to the Weight Display settings menu. Default setting is 'Small'.



Choose the desired size and then press «**OK**» to confirm selection.

7.6.6 Adjusting the date and time (TERMINAL → Device → Date Time)

This function allows the user to set date and time of the scale.

Please refer to Chapter 7.3.3 on how to reach the menu position 'Vision Setup → TERMINAL → Device → Date Time' and how to navigate within the 'Vision Setup'-menu.



Press «**Right Arrow**» to go to the Date and Time settings menu.



Press «**Edit**» to change format either from US or EU format. Select 'Date' to change the date and 'Time' to adjust the internal clock of the scale. Press «**OK**» to confirm selection.

7.6.7 Adjusting the date and time (TERMINAL → Device → Beep)

This function allows the user to switch the beep on or off, that is appearing on each key press.

Please refer to Chapter 7.3.3 on how to reach the menu position 'Vision Setup → TERMINAL → Device → Beep' and how to navigate within the 'Vision Setup'-menu.



Press the «**Edit**» key to go to the Beep settings menu.

Choose the desired setting (On or Off) and then press «**OK**» to confirm selection.

7.7 Define supervisor password (TERMINAL → Access)

This function allows the user to change the supervisor password of the scale. Can only be accessed by a supervisor.

Please refer to Chapter 7.3.3 on how to reach the menu position 'Vision Setup → TERMINAL → Access' and how to navigate within the 'Vision Setup'-menu.







Press «**>>**» ...

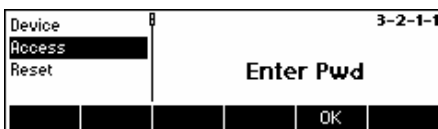

... and then press «**Edit**» to enter a new password.



Enter the password using the keypad, press «**OK**» to confirm. 'Retype Pwd' appears. Retype the new password and press «**OK**» again.

In case you forgot the password, you may press «», «», «», «» keys in sequence to access the Vision Setup.

7.8 Reset terminal settings to factory settings (TERMINAL → Reset)

This function resets the 'TERMINAL' block to its original factory settings. The supervisor password ('TERMINAL → Access') will not be reset, only "Device" block.

Please refer to Chapter 7.3.3 on how to reach the menu position 'Vision Setup → TERMINAL → Reset' and how to navigate within the 'Vision Setup'-menu.

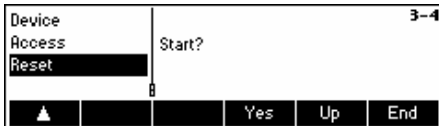

Press «**Yes**» to reset the terminal settings. 'SURE?' will appear, press «**Yes**» to confirm. The terminal settings are now reset to its original factory settings.

7.9 Communication settings (COMMUNICATION)

This function block allows the user to change the peripheral settings of the scale. Differences will appear depending on the option pack installed. Can only be accessed by a supervisor.

Please refer to Chapter 7.3.4 on how to reach the menu position 'Vision Setup → COMMUNICATION' and how to navigate within the 'Vision Setup'-menu.

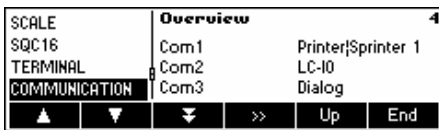

Enter the COMMUNICATION menu («**COMMUNICATION**»), select a port and choose one of the functions listed below.

Available functions and settings:

The screen shows the most important communication settings as a preview.

- Mode → Chapter 7.9.1
- Parameters → Chapter 7.9.2
- Printer type → Chapter 7.9.3
- Define Header → Chapter 7.9.4
- Add Linefeed → Chapter 7.9.5
- Reset 'COMMUNICATION' settings to factory settings → Chapter 7.9.6
- PS2 settings → Chapter 7.9.7



The screen shows a preview of the most important settings of the active item, e.g. those of COM1 if 'Com1' is active (i.e. highlighted).

Note: COM3 is not available for IND469SQC. COM2 is used for ETHERNET or WLAN (IND469 only) in case such option is installed.

7.9.1 Mode (COMMUNICATION → Mode)

This function enables the user to set the input/output mode of a COM port.

Please refer to Chapter 7.3.4 on how to reach the menu position 'Vision Setup → COMMUNICATION → Mode' and how to navigate within the 'Vision Setup'-menu.

Mode	Com1	4-1-1
Parameters	Mode	Printer
Printer Type		
Define Header		
▼	▼	Edit Up End

Press «**Edit**» to go to the Mode settings menu.

Printer	Com1	1/6
Auto Print		
Cont Weight		
Dialog		
▼	▼	DK Cancel

The mode setting can be changed to either **Printer, Auto Print, Continuous Weight, Dialog, 2nd Display, or LC-I/O**. In this example, Com1 was set to Printer.

Press «**End**» and confirm with «**Yes**» to save the changes.

7.9.2 Parameters (COMMUNICATION → Parameters)

Please refer to Chapter 7.3.4 on how to reach the menu position 'Vision Setup → COMMUNICATION → Parameters' and how to navigate within the 'Vision Setup'-menu.

Mode	Com1	4-1-2
Parameters	Baud	9600
Printer Type	Parity	8-none
Define Header	Handshake	XonXoff
▲	▼	▼ >> Up End

The current Baud Rate, Parity and Handshake settings are displayed on the screen. Press «**▼**» and ...

Baud	Com1	4-1-2-1
Parity	Baud	9600
Handshake		
▼	▼	Edit Up End

... «**Edit**» to change settings of Baud, Parity or Handshake.

Baud:	Parity:	Handshake:
300	7-none	No
600	7-odd	XonXoff
1200	7-even	
2400	8-none	
4800	8-odd	
9600	8-even	
19200		
38400		
57600 (Only for COM3)		
115200 (Only for COM3)		

7.9.3 Printer type (COMMUNICATION → Printer type)

This function allows you to choose the type of printer to be used in printing out reports.

Please refer to Chapter 7.3.4 on how to reach the menu position 'Vision Setup → COMMUNICATION → Printer Type' and how to navigate within the 'Vision Setup'-menu.



Press «**Edit**» to go to the Printer Type settings menu.



Choose the desired type of printer and then press «**OK**».

7.9.4 Header (COMMUNICATION → Define Header)

This feature is basically used to add header lines on the printouts during weighing mode. Up to 5 lines can be added. If defined for an A4/Report printer, line 1,2 and 3 will be used for header information in SQC mode print-outs as well.

Please refer to Chapter 7.3.4 on how to reach the menu position 'Vision Setup → COMMUNICATION → Define Header' and how to navigate within the 'Vision Setup'-menu.



... when this screen appears, press «**→**» enter the header settings menu.



Press «**Edit**» to edit a header line.



Using the keypad, type a header line text. Up to a maximum of 24 characters are allowed. Press «**OK**» when done. Identification information '.T.' and '.S.' (see 5.11.1) can be used as well.

7.9.5 Add LineFeed (COMMUNICATION → Add LineFeed)

This feature is used to add an empty Linefeed on the printout right after each report. The default is '4', meaning 4 empty lines are generated right after each report, to make it more convenient for the user to detach the printed output from the printer.

Please refer to Chapter 7.3.4 on how to reach the menu position 'Vision Setup → COMMUNICATION → Add LineFeed' and how to navigate within the 'Vision Setup'-menu.

78

Parameters	Com1	4-1-5
Printer Type	4	
Define Header		
Add LineFeed		
▲	▼	▼ Edit Up End

... when this screen appears, press «**Edit**» to change the Add LineFeed settings menu.

1	Com1	5/10
2		
3		
4		
▲	▼	▼ OK Cancel

Use «**▲**» and «**▼**» to choose the desired number of lines and then press «**OK**» to confirm changes.

7.9.6 Reset communication (COMMUNICATION → Comx → Reset Com)

This function resets the 'COMMUNICATION' block to its original factory settings.

Please refer to Chapter 7.3.4 on how to reach the menu position 'Vision Setup → COMMUNICATION → Comx → Reset Com' and how to navigate within the 'Vision Setup'-menu.

Printer Type	Com1	4-1-5
Define Header	Start?	
Add LineFeed		
Reset Com		
▲	▼	Yes Up End

Press «**Yes**» to reset the settings of the current Com port. 'SURE?' will appear, press «**Yes**» to confirm. The chosen Com port is now reset to its original factory settings.

7.9.7 PS2 Settings (COMMUNICATION → PS2)

This function allows setting up of the peripherals that are attached via the PS2 Interface.

Please refer to Chapter 7.3.4 on how to reach the menu position 'Vision Setup → COMMUNICATION → PS2' and how to navigate within the 'Vision Setup'-menu.

Com2	Keyboard	US Internat.	4-5
Com3	BCR	Article search	
Option			
PS2			
▲	▼	>>	Up End

Press «**>>**» to go to the PS2 settings menu.

Keyboard	Keyboard	US Internat.	4-5-1
BCR			
▼	Edit	Up	End

Select the item you wish to configure.

US Internat.		1/10
UK		
French		
Swiss French		
▼	▼	OK Cancel

Keyboard

It is possible to attach a PS2 keyboard to the scale via the PS2 Interface. This function enables you to specify the layout of the keyboard that you are using.

Note: When a PS2 keyboard is attached, it is possible to work with SQC16 using only this keyboard. The keys F1-F6 simulate the softkeys, F9-F11 simulate the top 3 function keys of the scale. You can press «**Enter**» and «**Esc**» keys to simulate the «**OK**» and «**Cancel**» softkeys respectively. The «**Backspace**» key simulates the «**C**» key.



BCR

Aside from a keyboard, it is also possible to attach a barcode reader via the PS2 Interface. This function enables you to specify the designation of the data coming from the barcode reader used for Direct Input (i.e. when the scale is in weighing or SQC mode).

- Not Used Ignore data coming from the barcode reader.
- Article search Use the data for searching through the article database.

Note: Whenever the scale is asking for user input, the barcode reader can **always** be used to scan in data in the context of the user input.

7.10 Diagnostic settings (DIAGNOSTICS)

This function block allows the user to verify if all keys are functioning properly. Can only be accessed by a supervisor.

Please refer to Chapter 7.3.5 on how to reach the menu position 'Vision Setup → DIAGNOSTICS' and how to navigate within the 'Vision Setup'-menu.



Enter the DIAGNOSTICS menu («>>>») and choose one of the functions listed below.

Available functions and settings:

- Keyboard Test → Chapter 7.10.1
- Display Test → Chapter 7.10.2
- Serial Number 1 → Chapter 7.10.3
- Serial Number 2 → Chapter 7.10.4
- List1 → Chapter 7.10.5
- List2 → Chapter 7.10.6
- Reset All → Chapter 7.10.7

7.10.1 Keyboard (DIAGNOSTICS → Keyboard Test)

Please refer to Chapter 7.3.5 on how to reach the menu position 'Vision Setup → DIAGNOSTICS → Keyboard Test' and how to navigate within the 'Vision Setup'-menu.



In order to check if all the keys are functioning properly, press «Yes» to start the keyboard test. Note: The test cannot be cancelled after starting ('End' has no function during test).



Press all 25 keys in sequence. If a key is functioning, the scale jumps to the next key. The keys are numbered as follows:

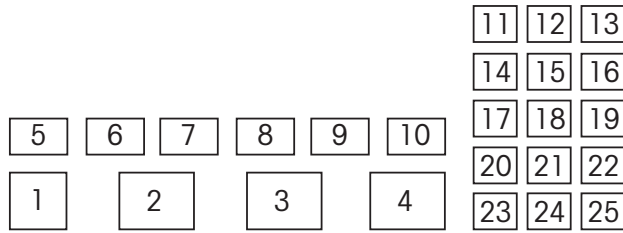

7.10.2 Display (DIAGNOSTICS → Display Test)

Please refer to Chapter 7.3.5 on how to reach the menu position 'Vision Setup → DIAGNOSTICS → Display Test' and how to navigate within the 'Vision Setup'-menu.



In order to check if the screen is functioning properly, press «Yes» and...

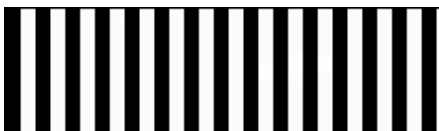

... appears on the screen.

7.10.3 Serial Number 1 (DIAGNOSTICS → SNR1)

Please refer to Chapter 7.3.5 on how to reach the menu position 'Vision Setup → DIAGNOSTICS → SNR1' and how to navigate within the 'Vision Setup'-menu.

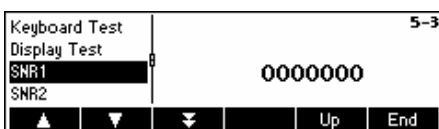

The serial number of the scale is displayed

7.10.4 Serial Number 2 (DIAGNOSTICS → SNR2)

'SNR2' cannot be chosen within SQC16 (no analog option support)

7.10.5 List 1 (DIAGNOSTICS → List 1)

Please refer to Chapter 7.3.5 on how to reach the menu position 'Vision Setup → DIAGNOSTICS → List 1' and how to navigate within the 'Vision Setup'-menu.



Press «**Yes**» to print out the current settings of the whole Vision Setup menu.

7.10.6 List 2 (DIAGNOSTICS → List 2)

'List 2' cannot be chosen within SQC16 (no analog option support)

7.10.7 Reset All (DIAGNOSTICS → Reset All)

This function resets all blocks of the whole Vision Setup Menu to its original factory settings. The supervisor password ('TERMINAL → Access') will not be reset.

Please refer to Chapter 7.3.5 on how to reach the menu position 'Vision Setup → DIAGNOSTICS → Reset All' and how to navigate within the 'Vision Setup'-menu.



Press «**>>**» to go to the List Memory settings menu and press «**Yes**» to reset all.

8 Other important information

This Chapter gives information on error messages and instructions for cleaning your scale. It also includes the declaration of conformity and technical data.

8.1 Error messages in display

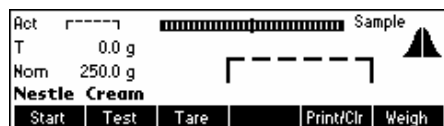

Overload

Reduce the load on the scale or the preload.



Underload

Place weighing pan on the scale and ensure that it can move freely.



Weight reading does not stabilize

- Ensure a tranquil environment.
- Ensure that the weighing pan is free to move.

Change the setting of the vibration adapter (Chapter 7.4.6)



Not possible to zero scale

Ensure that the zeroing is only carried out in the permissible range and not under overload or underload conditions.



Timeout occurred

The scale was not able to attain a stable weight value within the time out period (15 seconds) after «Start» was pressed.



Value is out of range

The scale is in an underload or overload condition. Thus, it is not possible to perform sampling.

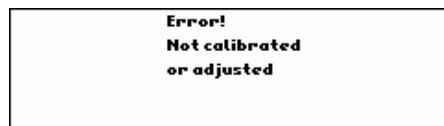

No calibration/adjustment

Disconnect the power cord plug and then plug it in again. If the error message reappears, calibrate/adjust the scale (Chapter 7.4.1). If this does not help, contact your dealer or local representative.



Cannot save article

No nominal or tolerance values are defined. Define nominal and tolerance values in article definition.

```

Error!
EAROM checksum error
    
```

EAROM checksum error

Disconnect the power cord plug and then plug it in again. If the error message reappears, contact your dealer or local representative.

8.2 Messages on printer

```

1      48.20 | | | |
Not plaus: | | 33.10 g
2      50.91 | | | |
3      50.91 | | | |
4      48.37 | | | |
5      50.90 | | | |
    
```

Not plausible

Weight of sample is not within the plausible limits.

```

1      48.20 | | | |
----- ABORT -----
    
```

Abort

«**Abort**» softkey was pressed during sampling.

```

<T2-      0      0.00 %
<T1-      1      20.00 %
>T1+      0      0.00 %
>T2+      0      0.00 %
Report cancelled.
    
```

Report Cancelled

«**Cancel**» softkey was pressed during printing of sampling report.

```

----- SAMPLE -----
----20.03.80 - 03:21----
-- THE QUALITY COMPANY -
Operator          RIZA

Name              AAA

IndTare <---
Nominal          100.00 g

Prewrite values rejected
----- ABORT -----
    
```

Prewrite values rejected

«**End**» softkey was pressed before the first sample was weighed.

```

1      99.83 | | | |
2      97.28 | | | |
Skipped
4      99.83 | | | |
5      50.90 | | | |
    
```

Skipped

«**Skip**» softkey was pressed during backweighing. If a tare sample is not successfully carried out, it can be skipped by pressing the «**Skip**» softkey. Therefore, its corresponding preweigh values will be omitted.

84

T1 Critical	3.00 %
T1 Reject	2.00 %
<T2 Viols	1

T1 Critical Violator

Number or percentage of critical amount of T1 - violators in the sample.

T1 Rejected Violator

Number or percentage of rejected amount of T1 - violators in the sample.

<T2 Violators

Number of <T2 violators in the sample.

Stat1 T1 Critical	3.00 %
Stat1 T1 Reject	2.00 %
Stat1 <T2 Viols	1

Stat1 T1 Critical Violator

Number or percentage of critical amount of T1 - violators in Stat1.

Stat1 T1 Rejected Violator

Number or percentage of rejected amount of T1 - violators in Stat1.

Stat1 <T2 Violators

Number of <T2 violators in Stat1.

Stat2 T1 Critical	3.00 %
Stat2 T1 Reject	2.00 %
Stat2 <T2 Viols	1

Stat2 T1 Critical Violator

Number or percentage of critical amount of T1 - violators in Stat2.

Stat2 T1 Rejected Violator

Number or percentage of rejected amount of T1 - violators in Stat2.

Stat2 <T2 Violators

Number of <T2 violators in Stat2.

Batch T1 Critical	3.00 %
Batch T1 Reject	2.00 %
Batch <T2 Viols	1

Batch T1 Critical Violator

Number or percentage of critical amount of T1 - violators in Batch.

Batch T1 Rejected Violator

Number or percentage of rejected amount of T1 - violators in Batch.

Batch <T2 Violators

Number of <T2 violators in Batch.

Stat1: Sample	1
x	93.57 % 93.570 g
<TM- : x-Nom	-6.430 g
s	7.32 % 6.850 g
<T1-	3 60.00 %

Mean Tolerance Violator

Difference: Mean value minus Nominal value

```
Signature:
.....
-----03:51-----
Batch cleared

New batch statistics
----- SAMPLE -----
----20.03.80 - 03:51----
```

Batch cleared

When changing batch name at the start of sampling, statistics of old batch will be printed and cleared. A new batch statistics will be generated.

```
Signature:
.....
-----03:51-----
Stat1 cleared
```

Stat1 cleared

«PrtClr» softkey was pressed in standby mode. All contents of Stat1 will be deleted.

```
Signature:
.....
-----03:51-----
Stat2 cleared
```

Stat2 cleared

«PrtClr» softkey was pressed in standby mode. All contents of Stat2 will be deleted.

```
Stat1: Samples      2
x      96.74 %    48.370 g
s       0.01 %     0.007 g

Δx =                1.64 g
-----03:56-----
```

Adjustment message

An adjustment message was printed due to steadily increasing or decreasing mean values over several samples.

9 APPENDIX: Tolerance systems

The tolerance system depends on the legal regulations applicable to the filling operations. All tolerance systems can be plus/minus or minus systems. Toggle with "+/-" in the article definition under "Tolerances".

9.1 Entry of tolerances

Entry of tolerances as a difference to the nominal value (N), in absolute value or in %, selectable in the menu "System" under "Tolerance Mode".

Example: N = 200 g, lower limit = 195 g

Entry in "Tolerances"	Entry in "Tolerance Mode"
5 g	t(rel) and Unit
2.5 %	t(rel) and %
195 g	T(abs) and Unit
97.5 %	T(abs) and %

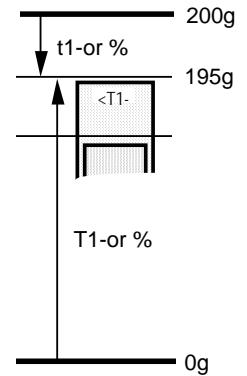

9.2 Legal tolerance systems

<p>EU +/-</p>	<p>European Union and Switzerland</p> <p>Tolerances: t1-, t1+, t2+ selectable, t2- fixed: t2- := 2*t1-</p> <p>Default values: t1- statutory, t1+ := t1- t2+ := t2-</p>		<p>EU -</p>	<p>European Union and Switzerland</p> <p>Tolerances: t1- selectable, t2-</p> <p>t2- := 2*t1-</p> <p>Default values: t1- statutory</p>	
----------------------	--	--	--------------------	---	--

9.3 Free tolerance systems with one tolerance

<p>Free 1+/-</p>	<p>Free tolerance system, e.g. for USA handbook 133 test plans A and B Canada Australia</p> <p>Tolerances: t⁻, t⁺ selectable. default value: t⁺ := t⁻</p>		<p>Free 1-</p>	<p>Free tolerance system, e.g. for USA handbook 133 test plans A and B Canada Australia</p> <p>Tolerances: t⁻ selectable, (t⁻ := t¹⁻)</p>	
-------------------------	---	--	-----------------------	--	--

9.4 Free tolerance systems with two tolerances

<p>Free 2+/-</p>	<p>Free tolerance system</p> <p>Tolerances: t¹⁺, t²⁺, t¹⁻, t²⁻ selectable.</p> <p>Default values: t²⁻ := 2*t¹⁻, t⁺ := t⁻.</p>		<p>Free 2-</p>	<p>Free tolerance system</p> <p>Tolerances: t¹⁻, t²⁻ selectable.</p> <p>Default values: t²⁻ := 2*t¹⁻</p>	
-------------------------	---	--	-----------------------	--	--

9.5 Free tolerance systems with three tolerances





<p>Free 3+/-</p>	<p>Free tolerance system</p> <p>Tolerances: t¹⁺, t²⁺, t³⁺ t¹⁻, t²⁻, t³⁻ selectable.</p> <p>Default values: t²⁻ := 2*t¹⁻, t³⁻ := 3*t¹⁻, t⁺ := t⁻.</p>		<p>Free 3-</p>	<p>Free tolerance system</p> <p>Tolerances: t¹⁻, t²⁻, t³⁻ selectable.</p> <p>Default values: t²⁻ := 2*t¹⁻ t³⁻ := 3*t¹⁻</p>	
-------------------------	--	--	-----------------------	---	--

10 APPENDIX: Optional equipment

10.1 LC-I/O Relay Interface

The LC-I/O Relay Interface allows adjustment messages to be relayed to an attached machine and peripheral devices such as warning lamps, control motors or valves to be controlled and switched by the SQC16.

Output signals: The outputs are controlled as follows:

Function	Output †	On period	
Violator check T1: critical	1	until confirmed with «  » key	
Violator check T1: rejected	1	flashes until confirmed with «  » key	0.5 s/0.5 s
Violator check TM+	2	until confirmed with «  » key	
Violator check TM-	2	flashes until confirmed with «  » key	0.5 s/0.5 s
Adjustment-	3	adjustment * factor ¹⁾	10 ... 65000 ms, steps of 1 ms
Adjustment+	4	adjustment * factor ¹⁾	10 ... 65000 ms, steps of 1 ms
Tolerance violator T1-	5	until sample removed	
Tolerance violator T2-	6	until sample removed	
Tolerance violator T3-	5+6	until sample removed	
Tolerance violator T1+	7	until sample removed	
Tolerance violator T2+	8	until sample removed	
Tolerance violator T3+	7+8	until sample removed	

¹⁾ See also "Adjustment" and "Factor" in Chapter 5.2

Example: Adjustment = 0.45 g Factor = 1.0 † = 0.45 sec
 Adjustment = 3.52 oz Factor = 0.1 † = 0.352 sec

Input signals: No input signals are relayed to SQC16.

10.2 Attachment of peripheral devices

The following peripheral devices can be controlled:

- Bar-code reader and/or keyboard (PS2, fixed)
- Host PC for Backup/Restore/Edit program BR16 (**COM1, 3**)
- Strip printer (**COM2/RS-P42**)
- A4/Report printer
- Relay interface LC-I/O

Boldface = standard connection

The following devices (max. 3 at the same time) can be controlled via COM ports:

LC-I/O	If the relay interface has to be controlled, it must be attached to one of the scale's COM ports and that port must be set to "LC-I/O".
Host (PC)	If the host has to be controlled, it must be attached to one of the scale's COM ports and that port must be set to "Dialog".
Strip printer	If a strip printer has to be controlled, it must be attached to one of the scale's COM ports and that port must be set to "Printer" with the printer type set to the appropriate printer.
A4/Report printer (Epson LX-300)	If an A4/Report printer has to be controlled, it must be attached to one of the scale's COM ports and that port must be set to "Printer" with the printer type set to "LX-300".

Note: The bar-code reader and the keyboard must be plugged to the PS/2 connector.

10.3 Accessories

BBA462, BBK462 (IND469, GA46 → CD / Datasheet) accessories:

Printer with normal paper	Strip Printer RS-P42, incl. RS232 cable	RS-P42	229265
	• Strip Printer 'Sprinter 1', EURO version		21253399
	• Strip Printer 'Sprinter 1', UK version		21253745
	RS232 cable for 'Sprinter 1' 1.8m (25/9-pin D-Sub, m/m crossover)		21253677
Accessories for RS-P42 or Sprinter 1	Paper rolls, 5 pcs		72456
	Ribbon cartridges, black, 2 pcs		65975
Auxiliary display	Auxiliary display (not incl.: RS232 cable 410024)	RS-PD/PASM	21302875
Barcode scanner (PS/2)	For attachment of barcode reader	DATALOGIC DLC7070-M1	21900880
Barcode scanner (PS/2Y)	For attachment of barcode reader and keyboard	DATALOGIC DLC7070-M1	21900881
Barcode scanner (wireless)	For attachment of barcode reader	DATALOGIC Gryphon M100-CS	21900949
Protective covers (1 incl.)	• Protective cover for small platform scale		21203207
	• Protective cover for large platform scale		21203206
Antitheft device	Mechanical antitheft device		229175
Operating instructions (1 incl.)	• German		21901253
	• English		21901254
	• French		21901255
	• Italian		21901256
	• Spanish		21901257
Relay interface, digital outputs	8x220V (not incl.: RS232 cable 410024)	LC-I/O	21202217
Keyboard	PC compatible Mini-Keyboard (US Layout)		21900944
Protective cover	For keyboard 21900944		21900945
PC program	BR16 Backup/Restore/Edit SQC16 Data	BR16	21901246
	RS232 cable 1.8m (9-pin D-Sub, m/f, parallel)		410024

11 Technical data

11.1 General data and delivered items

Standard delivery package:

- Complete scale
- Operating instructions
- Quick Guide (with included CD)

11.1.1 BBA/BBK462

Applications	Weighing SQC														
Settings	Vibration adapter Weighing process adapter Automatic zero correction Power-saving shutoff Display backlighting														
Display	Active point-matrix display, 35 mm high, with CFL backlit (235 x 64 pixel)														
Interface	3 built-in RS232C interface (COM1, COM2, COM3; see 11.3) PS2 interface for keyboard and barcode reader Optional interfaces (Ethernet; instead of COM2)														
Ambient conditions	<table> <tr> <td>▪ Use</td> <td>Indoor use only</td> </tr> <tr> <td>▪ Altitude</td> <td>up to 2000 m</td> </tr> <tr> <td>▪ Temperature range BBA4..</td> <td>-10 .. +40 °C / 14 .. 104 °F</td> </tr> <tr> <td>▪ Temperature range BBK4..</td> <td>+10 .. +30 °C / 50 .. 86 °F</td> </tr> <tr> <td>▪ Over voltage category</td> <td>II</td> </tr> <tr> <td>▪ Contamination level</td> <td>2</td> </tr> <tr> <td>▪ Relative humidity</td> <td>Maximum relative humidity 80 % for temperatures up to 31 °C / 88 °F, decreasing linearly to 50 % relative humidity at 40 °C / 104 °</td> </tr> </table>	▪ Use	Indoor use only	▪ Altitude	up to 2000 m	▪ Temperature range BBA4..	-10 .. +40 °C / 14 .. 104 °F	▪ Temperature range BBK4..	+10 .. +30 °C / 50 .. 86 °F	▪ Over voltage category	II	▪ Contamination level	2	▪ Relative humidity	Maximum relative humidity 80 % for temperatures up to 31 °C / 88 °F, decreasing linearly to 50 % relative humidity at 40 °C / 104 °
▪ Use	Indoor use only														
▪ Altitude	up to 2000 m														
▪ Temperature range BBA4..	-10 .. +40 °C / 14 .. 104 °F														
▪ Temperature range BBK4..	+10 .. +30 °C / 50 .. 86 °F														
▪ Over voltage category	II														
▪ Contamination level	2														
▪ Relative humidity	Maximum relative humidity 80 % for temperatures up to 31 °C / 88 °F, decreasing linearly to 50 % relative humidity at 40 °C / 104 °														
Mains connection	<p>Direct connection to the mains (MAINS supply voltage fluctuations up to $\pm 10\%$ of the nominal voltage):</p> <ul style="list-style-type: none"> ▪ 230 V, 50 Hz, 70 mA ▪ 240 V, 50 Hz, 70 mA ▪ 120 V, 60 Hz, 90 mA ▪ 100 V, 50/60 Hz, 90 mA <p>For battery operation:</p> <ul style="list-style-type: none"> ▪ Connection via mains adapter: 90 – 264 V, 47 – 63 Hz, 300 mA ▪ In feed on the unit: 24 V, 1.3 A 														

92

Battery operation If the voltage supply is interrupted, the unit automatically switches over to battery operation.

Net weight

Model	Without battery	With battery	With internal calibration weight (without battery)
BBA4.. – .. SM	4,6 kg	5,3 kg	–
BBA4.. – .. LA	8,2 kg	8,9 kg	–
BBK4.. – .. XS	4,9 kg	5,6 kg	5,4 kg
BBK4.. – .. SM	4,7 kg	5,4 kg	5,2 kg
BBK4.. – .. LA	10,5 kg	11,2 kg	11,7 kg

Protection Class (IEC 529, DIN 40050, EN60529) IP43 (not with Ethernet interface)

Resolution of the analog second scale interface

- 300.000 points in non certified configuration
- 7.000 points in certified configuration

11.1.2 IND469

Applications

Weighing
SQC

Settings

Automatic zero compensation mode during switching on and during operation
Filter for adapting to the environmental conditions (vibration adapter)
Filter for adapting to the weighing mode, e.g. dispensing (weighing process adapter)
Switch-off function, sleep mode for power-operated devices, energy saving mode for storage battery operation
Display illumination

Display

Active point-matrix display, 35 mm high, with CFL backlit (235 x 64 pixel)

Keyboard

Tactile-touch membrane keypad
Scratch-resistant labeling

Housing

Stainless steel 1.4301 or AISI 304

Net weight

IND469 with AC power Supply unit	approx. 2.6 kg
IND469 with storage battery	approx. 3.2 kg

Protection type
(DIN 40050)

IP69k

Mains connection

Direct connection to power supply (supply voltage fluctuation not exceeding ± 10 % of the rated voltage)

- IND469 weighing terminal: Rated voltage 100 ... 240 VAC / 47 ... 63 Hz / 300 mA
- IND469xx weighing terminal: Rated voltage 230 VAC ± 10 % / 47 ... 63 Hz / 300 mA
- BBA469 compact scale: Rated voltage 100 ... 240 VAC / 47 ... 63 Hz / 300 mA

Storage battery operation Supply at device: 24 VDC / 1.0 A
 If the supply voltage is interrupted, the scale switches automatically over to storage battery operation

Ambient conditions

▪ Application	In interiors
▪ Height	up to 2000 m
▪ Temperature range Class III	-10 .. +40 °C / 14 .. 104 °F
▪ Temperature range Class II	0 .. +40 °C / 32 .. 104 °F
▪ Over voltage category	II
▪ Degree of soiling	2
▪ Relative humidity	Up to max. 80%, non condensing

Interface 2 built-in RS232C interface (COM1, COM2; see 11.3)
 PS2 interface for keyboard and barcode reader
 Optional interfaces (Ethernet or WLAN; instead of COM2)

11.2 Dimensions

11.2.1 BBA/BBK462

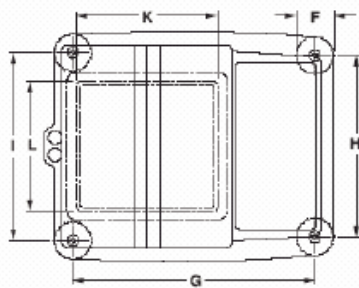
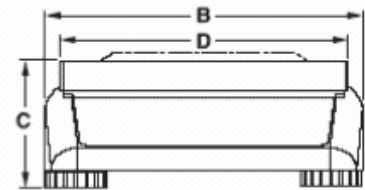
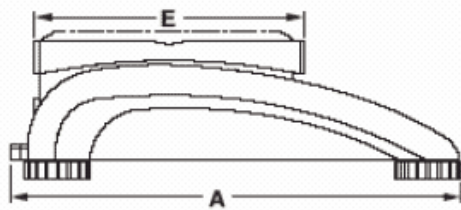

	A	B	C	D	E	F	G	H	I	K	L
XS	335	265	100	240	200	46	276	208	216	165	165
SM	335	265	100	240	200	46	276	208	216		
LA	370	360	115	350	240	52	310	304	310		

¹⁾All dimensions in mm
 * with adjustable feet fully screwed in

11.2.2 IND469

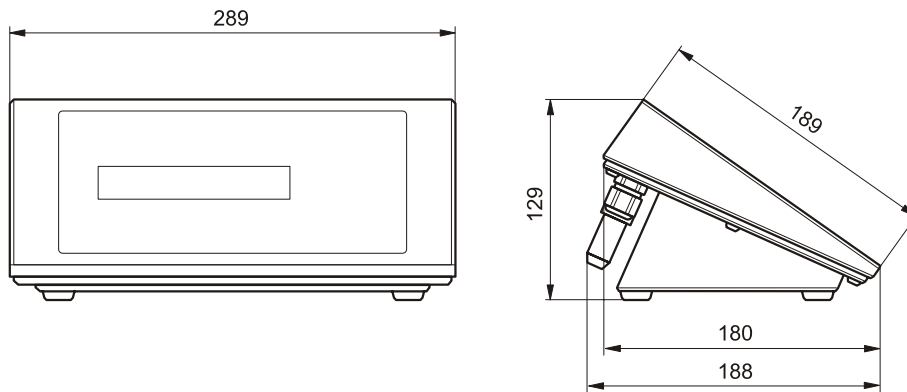

Dimensions in mm

11.3 Interface technical data

11.3.1 BBA/BBK462

The scale is provided with an EIA RS-232C (CCITT V24/V.28) voltage-controlled interface as standard. Maximum cable length is 15 m. All interfaces are in the form of a 9-pin D-sub female connector. Instructions for configuring the interfaces are given in Chapter 7.9.2.

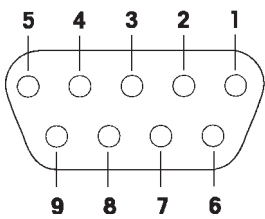
Interface		1 (standard)	2 (standard)	3 (standard)
Type		RS232C	RS232C	RS232C
Pin assignment 	Pin 1	---	---	---
	Pin 2	TxD	TxD	TxD
	Pin 3	RxD	RxD	RxD
	Pin 4	---	---	---
	Pin 5	GND	GND	GND
	Pin 6	---	---	---
	Pin 7	---	---	---
	Pin 8	---	---	---
	Pin 9	VCC	VCC	VCC

TxD: Transmit data

GND: Signal ground

RxD: Receive data

VCC: Power supply +5V

11.3.2 IND469

The device is equipped with 2 communication interfaces. The following combinations are possible:

	COM1	COM2
Standard	RS232	RS232
Ethernet	RS232	Ethernet
WLAN	RS232	WLAN

11.4 Interface commands

Your scale can be configured and operated, and can communicate with a PC via RS232C interface.

11.4.1 Preconditions

The following preconditions must be fulfilled to achieve communication between the scale and a PC:

- The scale must be connected to the RS232C interface of the PC using the necessary cable (e.g. 410024).
- The scale interface must be set in "Dialog" mode (see Chapter 7.9.1).
- A terminal program must be available on the PC (e.g. "Hyper Terminal").
- The communication parameters (protocol, bits and parity, data transfer rate) must be set using the same values in the terminal program and in the scale (see Chapter 7.9.2).

11.4.2 SICS Command set

Your scale basically supports the **Mettler Toledo Standard Interface Command Set (MT-SICS)**. The SICS command set used are "**Level 0**", "**Level 1**", and some "**Level 2**" commands. Detailed information on the interface commands is given in the "MT SICS Reference Manual" (No. 705184, only available in English).

Notes:

- Every command line must be terminated with **<CR><LF>** (corresponding to the "Enter" or "Return" key on the PC keyboard). The command is then executed immediately. To correct a line, this needs to be entered again completely.
- For commands with parameters, the "_" symbol signifies an empty space, and in the examples given, serves solely to clarify the syntax.
- For commands that require text parameters, the quotation marks must be entered, as they indicate to the scale that they enclose a text string and not another parameter.

The following lists the supported MT-SICS commands:

I0	Inquiry of all implemented MT-SICS commands.
I1	Inquiry of MT-SICS level and MT-SICS versions.
I2	Inquiry of scale data.
I3	Inquiry of scale software version.
I4	Inquiry of serial number.
S	Send stable weight value.
SI	Send weight value immediately irrespective of scale stability.
SIR	Send weight values repeatedly irrespective of scale stability.
Z	Zero the scale.
ZI	Zero the scale immediately irrespective of scale stability.
@	Reset the scale to condition after switching on but without a zero setting being performed.
D	Write text into scale display. (E.g. D_`text`).
DW	Switch back to weight display after D command.
K	Configure key control.
SR	Send current stable weight value and then continuously on weight change equal to or greater than the preset value. (E.g. SR_10.00_g).
T	Tare the scale.
TA	Inquire or preset the tare weight value.
TAC	Clear the tare value.
TI	Tare immediately regardless of whether the current value is stable or not.
C2	Initiate calibration.
I10	Inquire or set the scale ID.
I11	Inquiry of scale type.
DAT	Inquire or set the date on the scale.
P100	Print out text on the printer. (E.g. P100_`text`).
P101	Print out current stable weight value.
P102	Print out current weight value irrespective of scale stability.
PWR	Switch the scale on or off.
ST	Send stable weight after pressing the «  » key.
TIM	Inquire or set the time on the scale.
SU	Send stable weight value with currently displayed unit.
SIU	Send weight value with currently displayed unit immediately irrespective of scale stability.
SIRU	Send weight value with currently displayed unit immediately and repeat.
SRU	Send stable weight value with currently displayed unit and repeat on weight change greater than or equal to preset value.

Aside from the standard MT-SICS commands, SQC16 also provides the following commands for working with the scale:

M01 Inquire or set the weighing mode ('Vision Setup → SCALE → Filter → Process': Chapter 7.4.6).

M01	Inquiry of weighing mode.
M01_0	Set weighing mode to "Universal".
M01_1	Set weighing mode to "Filling".

M03	Inquiry or setting of AutoZero ('Vision Setup → SCALE → Zero → Auto Zero': Chapter 7.4.4).	
	M03	Inquiry of AutoZero mode.
	M03_0	Set "AutoZero" to off.
	M03_1	Set "AutoZero" to on.
M09	Inquiry or setting of display contrast ('Vision Setup → TERMINAL → Device → Contrast': Chapter 7.6.3)	
	M09	Inquiry of display contrast.
	M09_x	Set the display contrast to x% where x can have a value of 0-100.
M14	Inquiry of available languages	
	M14	
	-->	
	M14_B_x_	"<First Language>"
	...	
	M14_A_x_	"<Last Language>"
		Example:
	where x (all these terms are in English):	M14
		-->
	0 = English	M14_B_0_ "English"
	1 = German	M14_B_1_ "German"
	2 = French	M14_B_2_ "French"
	3 = Spanish	M14_B_3_ "Spanish"
	4 = Italian	M14_B_4_ "Italian"
	8 = Polish	M14_B_8_ "Polish"
	10 = Czech	M14_B_10_ "Czech"
	11 = Hungarian	M14_B_11_ "Hungarian"
	12 = Slovak	M14_B_12_ "Slovak"
	13 = Slovenian	M14_B_13_ "Slovenian"
	14 = Dutch	M14_A_14_ "Dutch"
M15	Inquiry/setting of language (see also chapter 7.6.1).	
	M15	Inquiry of actual language.
		Examples:
		M15
		-->
	M15_A_0	<English is currently set>
	M15_x	Setting of language.
		x: Number according to
		available languages (see
		command M14).
		M15_1
		-->
	M15_A	<German is set now>

M16 Inquiry or setting of the sleep status ('Vision Setup → TERMINAL → Device → Sleep': Chapter 7.6.2)

M16 Inquiry of "Sleep" status.
 M16_x Set the "Sleep" status to the value of x where x can be:
 0 = Off
 1 = 1 minute
 2 = 3 minutes
 3 = 5 minutes

M19 Inquiry of adjustment weight.

M21 Inquiry or setting of "Unit1" ('Vision Setup → SCALE → Display': Chapter 7.4.2) and display unit.

M21 Inquiry of "Unit1" and display unit.
 M21_Des_x Set the "Des" (designation) unit to the value of x where
 Des: x:
 0 = Unit 1 0 = g
 1 = Display unit 1 = kg
 2 = t
 7 = lb
 8 = oz

I31 Inquire or define the record header for printouts in 'Weighing mode'. For SQC, see special header and footer lines in system setup.

I31_x Inquiry the definition for the x header line.
 I31_x_"text" Define the text for a specific header line where:
 x 1..5
 text String of characters with a maximum of 24 characters.

Example:
 I31_1_"Mettler Toledo GmbH"
 I31_2_"Heuwinkelstrasse"
 I31_3_"CH-8606 Naenikon"
 I31_4_"Telefon 01/944 22 11"
 I31_5_"Internet www.mt.com"

The header can be viewed in 'Vision Setup → COMMUNICATION → Define Header'.

11.5 Table of Geo Values

For weighing instruments verified at the manufacturer's, the geo value indicates the country or geographical zone for which

the instrument is verified. The geo value set in the instrument (e.g. "Geo 18") appears briefly after switch-on or is specified on a label.

Table GEO VALUES 3000GEO 3000e shows the geo values for European countries.

Table GEO VALUES 6000e/7500e shows the geo values for different gravitation zones.

11.5.1 GEO VALUES 3000e, OIML Class III (European Countries)

Geographical latitude	Geo Value	Country
46°22' - 49°01'	18	Austria
49°30' - 51°30'	21	Belgium
41°41' - 44°13'	16	Bulgaria
42°24' - 46°32'	18	Croatia
48°34' - 51°03'	20	Czech Republic
54°34' - 57°45'	23	Denmark
57°30' - 59°40'	24	Estonia
59°48' - 64°00'	25*	Finland
64°00' - 70°05'	26	
41°20' - 45°00'	17	France
45°00' - 51°00'	19*	
47°00' - 55°00'	20	Germany
34°48' - 41°45'	15	Greece
45°45' - 48°35'	19	Hungary
51°05' - 55°05'	22	Ireland
63°17' - 67°09'	26	Iceland
35°47' - 47°05'	17	Italy
55°30' - 58°04'	23	Latonia
49°27' - 50°11'	20	Luxembourg
47°03' - 47°14'	18	Liechtenstein
53°54' - 56°24'	22	Lithuania
50°46' - 53°32'	21	The Netherlands
57°57' - 64°00'	24*	Norway
64°00' - 71°11'	26	
49°00' - 54°30'	21	Poland
36°58' - 42°10'	15	Portugal
43°37' - 48°15'	18	Romania
55°20' - 62°00'	24*	Sweden
62°00' - 69°04'	26	
45°49' - 47°49'	18	Switzerland
47°44' - 49°46'	19	Slovak Republic
45°26' - 46°35'	18	Slovenia
36°00' - 43°47'	15	Spain
35°51' - 42°06'	16	Turkey
49°00' - 55°00'	21*	Great-Britain
55°00' - 62°00'	23	

*factory setting

11.5.2 GEO VALUES 6000e/7500e OIML Class III (Height £ 1000 m)

Geographical latitude	Geo Value
00°00' - 12°44'	5
05°46' - 17°10'	6
12°44' - 20°45'	7
17°10' - 23°54'	8
20°45' - 26°45'	9
23°54' - 29°25'	10
26°45' - 31°56'	11
29°25' - 34°21'	12
31°56' - 36°41'	13
34°21' - 38°58'	14
36°41' - 41°12'	15
38°58' - 43°26'	16
41°12' - 45°38'	17
43°26' - 47°51'	18
45°38' - 50°06'	19
47°51' - 52°22'	20
50°06' - 54°41'	21
52°22' - 57°04'	22
54°41' - 59°32'	23
57°04' - 62°09'	24
59°32' - 64°55'	25
62°09' - 67°57'	26
64°55' - 71°21'	27
67°57' - 75°24'	28
71°21' - 80°56'	29
75°24' - 90°00'	30

11.6 Declaration of Conformity

Declaration of Conformity / Important notice for verified weighing instruments in EC countries:

→ 22013175 (document, included with shipment)

USA/Canada:

This equipment has been tested and found to comply with the limits for a Class A digital device, pursuant to both Part 15 of the FCC Rules and the radio interference regulations of the Canadian Department of Communications. These limits are designed to provide reasonable protection against harmful interference when the equipment is operated in a commercial environment. This equipment generates, uses and can radiate radio frequency energy and, if not installed and used in accordance with the instruction manual, may cause harmful interference to radio communications. Operation of this equipment in a residential area is likely to cause harmful interference, in which case the user will be required to correct the interference at his own expense.

Cet appareil a été testé et s'est avéré conforme aux limites prévues pour les appareils numériques de classe A et à la partie 15 des règlements FCC et à la réglementation des radio-Interférences du Canadian Department of Communications. Ces limites sont destinées à fournir une protection adéquate contre les interférences néfastes lorsque l'appareil est utilisé dans un environnement commercial. Cet appareil génère, utilise et peut radier une énergie à fréquence radioélectrique ; il est en outre susceptible d'engendrer des interférences avec les communications radio, s'il n'est pas installé et utilisé conformément aux instructions du mode d'emploi. L'utilisation de cet appareil dans les zones résidentielles peut causer des interférences néfastes, auquel cas l'exploitant sera amené à prendre les dispositions utiles pour palier aux interférences à ses propres frais.

Este equipo ha sido probado y observa los límites establecidos para los equipos digitales de Clase A, de conformidad con la Sección 15 de las Normas de la FCC y las normas de radiointerferencia del Departamento de Comunicaciones Canadiense. Estos límites se establecen para proporcionar una protección razonable contra interferencias perjudiciales cuando el equipo funciona en un entorno comercial. Este equipo genera, utiliza y puede radiar energía de radiofrecuencia y, si no se instala y emplea según el manual de instrucciones, podría provocar interferencias perjudiciales para las comunicaciones por radio. El funcionamiento de este equipo en una zona residencial podría causar interferencias perjudiciales, en cuyo caso se le exigirá al usuario que corrija la interferencia y corra con los gastos derivados de dicha corrección.

Dieses Gerät wurde getestet und ist in Übereinstimmung mit den Grenzwerten für digitale Geräte der Klasse A entsprechend den FCC-Vorschriften, Teil 15 und den Bestimmungen bezüglich Hochfrequenzstörungen des Canadian Department of Communications. Diese Grenzwerte sind aufgestellt, um einen ausreichenden Schutz vor Störungen bei Nutzung der Geräte in einer gewerblichen Umgebung zu bieten. Dieses Gerät erzeugt, nutzt und kann elektromagnetische Energie abgeben und bei Nichtbeachtung der Aufbau- und Nutzungshinweise der Betriebsanleitung den Funkverkehr beeinträchtigen. Der Betrieb in Wohngebieten kann zu Interferenzen führen, die der Betreiber auf eigene Kosten korrigieren muss.

In base alle prove a cui è stato sottoposto, si è rilevato che questo apparecchio è conforme ai limiti stabiliti per i dispositivi digitali di Classe A secondo il Punto 15 delle norme FCC e le norme sull'interferenza radio del Ministero delle Comunicazioni canadese. Questi limiti sono stati concepiti per fornire una protezione adeguata contro interferenze dannose quando l'apparecchio viene utilizzato in ambito commerciale. Questo apparecchio genera, impiega e può irradiare energia a radiofrequenza e, se non è installato e utilizzato seguendo il manuale di istruzioni, può causare interferenze dannose per le comunicazioni radio. Il funzionamento di questo apparecchio in zone residenziali può facilmente causare interferenze dannose; in questo caso all'utente verrà richiesto di eliminare le interferenze a proprie spese.

INDEX

- <**
 <T2 40
- 2**
 2nd display 76
 2nd tolerance system 17, 40
- A**
 A4 printout 49
 accept softkey 33
 access rights 71
 adjustment 17, 24
 adjustment message 41, 85, 88
 adjustment speed 24
 ambient conditions 9
 Appendix_E.pdf 17
 article name 26
 article number 22
 auto print 76
 auto zero 65
 automatic save 66
 auxiliary scale 76
- B**
 backweighing 51
 bar code reader 51
 barcode reader connection 79
 batch 25
 batch sampling 54
 batch statistics 17, 55
 baud rate 76
 beep 74
 bulk tare softkey 32
- C**
 calibration 64
 cancel softkey 27
 catalog 50
 class table 45, 46
 close softkey 29, 31, 37, 52, 53, 54, 55, 56
 code - linefeeds 48
 communication 75, 76, 78
 compact printing 49
 complete printing 49
 continuous weight 76
 contrast settings 72
 copy softkey 26, 28
- D**
 database 25
 date and time 10, 44, 73
 default article 25
 define softkey 26, 27
 delete softkey 26, 28
- density group 23
 density weight 23
 dialog 76
 difference 45, 47
 display test 10, 80
- E**
 edit softkey 27
 erase softkey 27
- F**
 FACT 67
 factor 24
 filter 66
 footer 44
- G**
 GA46 90
 geographical adjustment value 9
 global density 17, 36
- H**
 handshake 76
 header 44, 77
 header/footer 44
 histogram 45, 46
- I**
 identification number 22
 IND469 90
 individual chart 45, 47
 individual tare 17, 24, 51
 invert 73
- K**
 keyboard connection 78
 keyboard test 79
- L**
 language 11, 72
 LC-I/O 76
 linefeeds 48, 77
- M**
 marginals 48
 maximum tolerance 37
 maximum value 45, 47
 mean 30
 mean tare 32
 mean tolerance 40
 mean value 32, 33, 47
 mean value requirements 17
 min weigh 68
 minimum password length 70
 minimum step 24
 minimum value 45, 47

104

mode settings 76, 77

N

new softkey 26
nominal weight 23

O

on and off switch 10
options softkey 26

P

parity 76
password 16, 58, 70, 71, 74
plausibility limits 17
plausibility settings 24
power supply plug 9
preweighing 51
print individual value 25
print softkey 26, 28
printer 76
printout 81
process setting 67
PS2 settings 78

R

range 46, 48
report 42
reports softkey 50
reset 69, 75, 78, 81
resolution 64, 65

S

sample - linefeeds 48
sample messages 36, 37
sample report 44
sample size 24
sampling of articles 29
search softkey 27, 28
serial number 80
set nXT softkey 32
shared statistics 17, 25, 41
shift key 34
sleep function 72
SQC16 Training 17
standard deviation 30, 46, 47, 48
statistics 33
statistics - linefeeds 48
statistics report 30, 31, 44, 52, 54,
55, 56
statistics values 45, 47
summary of database 50
supplement 17, 23, 41

T

tare 65
tare and zero values 66
tare configuration 36, 37

tare series 32
tare weight 23
taring 31
test 17, 41
test sampling 30
test series 30
tolerance 24, 36
tolerance settings 24
tolerance spec. in percentage 36
tolerance spec. in unit 36
tolerance system 17, 24, 86
tolerance violation 39, 45
tolerances relative to nominal 36
tolerances relative to zero 36
transfer key 25, 55

U

unit 22
user ID number 71
user login 69
user name 16, 71

V

VC T1 critical 40
VC T1 reject 40
vibration settings 66
violation check 17, 24, 39

W

weighing mode 17, 24
weight display size 73

X

\bar{x} /s/R/Min/Max/R in percent 45
 \bar{x} -chart 45, 46, 48

For the future benefit of your METTLER TOLEDO product, and to preserve its value, METTLER TOLEDO service assures you of its quality and measuring accuracy for years to come. Please request full details of our attractive terms of service. Thank you.



Subject to technical changes.

© Mettler-Toledo AG 2007 21901254A Printed in Germany 0705/2.12

Mettler-Toledo AG, Heuwinkelstrasse, 8606 Nänikon, Switzerland
Tel. +41 44 944 22 11, Internet: <http://www.mt.com>