

Measuring Module M 700[®] PA 700(X)

Communication Unit
for PROFIBUS PA



METTLER TOLEDO



71960

Warranty

Defects occurring within 1 year from delivery date shall be remedied free of charge at our plant (carriage and insurance paid by sender). Sensors, fittings, and accessories: 1 year.

©2007 Subject to change without notice

Return of products under warranty

Please contact our Service Team before returning a defective device. Ship the cleaned device to the address you have been given. If the device has been in contact with process fluids, it must be decontaminated/disinfected before shipment. In that case, please attach a corresponding certificate, for the health and safety of our service personnel.

Disposal

Please observe the applicable local or national regulations concerning the disposal of "waste electrical and electronic equipment".

Trademarks

The following registered trademarks are used in this instruction manual without further marking

SMARTMEDIA®

is a registered trademark of Toshiba Corp., Japan

FOUNDATION FIELDBUS™

is a trademark of Fieldbus Foundation, Austin, USA

Mettler-Toledo AG,
Process Analytics, Industrie Nord, CH-8902 Urdorf,
Tel. +41 (44) 729 62 11 Fax +41 (44) 729 26 36
Subject to technical changes.



Adresse Im Hackacker 15 (Industrie Nord), CH-8902 Urdorf, Schweiz
Briefadresse Postfach, CH-8902 Urdorf
Telefon 01-736 22 11
Telefax 01-736 26 36
Internet www.mt.com
Bank Credit Suisse First Boston, Zürich (Acc. 0835-370501-21-90)

Declaration of conformity Konformitätserklärung Déclaration de conformité

**We/Wir/Nous****Mettler-Toledo GmbH, Process Analytics**Im Hackacker 15
8902 Urdorf
Switzerland

declare under our sole responsibility that the product,
erklären in alleiniger Verantwortung, dass dieses Produkt,
déclarons sous notre seule responsabilité que le produit,

Description**Beschreibung/Description****PA 700X
5212181**

to which this declaration relates is in conformity with the following standard(s) or
other normative document(s).

auf welches sich diese Erklärung bezieht, mit der/den folgenden Norm(en) oder
Richtlinie(n) übereinstimmt.

auquel se réfère cette déclaration est conforme à la (aux) norme(s) ou au(x)
document(s) normatif(s).

**Explosion protection
Explosionsschutzrichtlinie
Prof. contre les explosions****94/9/EG
KEMA 04 ATEX 2056
NL-6812 AR Arnhem, KEMA 0344****Low-voltage directive
Niederspannungs-Richtlinie
Directive basse tension****73/23/EWG****EMC Directive
EMV-Richtlinie
Directive concernant la CEM****89/336/EWG****Place and Date of issue
Ausstellungsort / - Datum
Lieu et date d'émission****Urdorf, July 16, 2004**

Mettler-Toledo GmbH, Process Analytics

Waldemar Rauch
General Manager Ingold
Christiani Zwicky
Head of Marketing**METTLER TOLEDO**

Contents

M 700 PA 700 Module

Warranty	2
Disposal.....	2
Trademarks.....	2
Contents	4
Intended Use	6
Conformity with FDA 21 CFR Part 11	6
Safety Information	7
Application in Hazardous Locations: PA 700X Module	7
Software Version	8
Modular Concept	9
Short Description.....	10
Short Description: FRONT Module.....	10
Short Description: Menu Structure.....	11
Short Description: BASE Module.....	13
PROFIBUS Technology	14
Terminal Plate PA 700(X) Module.....	16
Attaching the Terminal Plates.....	16
Inserting the Module.....	17
PROFIBUS PA Installation	18
Communication Model.....	20
Physical Block (PB).....	20
Analog Input blocks.....	21
For Copy: Individual Settings.....	24
Configuration with PROFIBUS	25
Device database file (GSD file)	25
Cyclic Data Communication.....	26
Structure of Cyclic Input Data Telegram	26
DI Function Blocks	27
DI 1: EC 400 status	27
DI 2: CONTACTS / LOCK Status / ENABLE Request	27
DI 3: EC 400 Messages	28
Explanation of EC 400 Messages: Maintenance request.....	28

Contents

M 700 PA 700 Module

Explanation of EC 400 Messages: Failure.....	29
DI 4: EC 400 Step	29
DO Function Blocks.....	30
DO 1: HOLD Control	30
DO 2: PARSET.....	30
DO 3: EC 400 Control.....	31
DO 4: LOCK Control	31
Configuration Data.....	32
Analog Input blocks (1 ... 8)	33
Discrete Input Blocks (1 ...4)	34
Discrete Output Blocks (1 ... 4)	35
PA Slot Model.....	36
PB Block Parameters	37
TB Analyzer Block Parameters.....	39
AI Function Block Parameters.....	41
Defaults & Writable Ranges	41
DI Function Block Parameters.....	44
DI Function Block Parameters.....	45
DO Function Block Parameters.....	46
AO Function Block Parameters.....	48
Calibration Record Parameters	49
Menu Selection	61
Passcode Entry	62
Changing a passcode	62
Passcode lost.....	62
Function Control Matrix	63
Pressure Compensation via Bus (A01).....	64
Diagnostics: Bus Monitor	65
Bus Monitor	66
Specifications.....	67
Index.....	73

Intended Use

The module is a communication unit for PROFIBUS-PA and allows digital communication via current modulation.

The PA 700X module is intended for operation in locations subject to explosion hazards which require equipment of Group II, device category 2(1), gas/dust.

Conformity with FDA 21 CFR Part 11

In their directive "Title 21 Code of Federal Regulations, 21 CFR Part 11, Electronic Records; Electronic Signatures" the US American health agency FDA (Food and Drug Administration) regulates the production and processing of electronic documents for pharmaceutical development and production. This results in requirements for measuring devices used for corresponding applications. The following features ensure that the M 700(X) modular process analysis system meets the demands of FDA 21 CFR Part 11:

Electronic Signature

Access to the device functions is regulated and limited by individually adjustable codes – "Passcodes". This prevents unauthorized modification of device settings or manipulation of the measurement results. Appropriate use of these passcodes makes them suitable as electronic signature.

Audit Trail Log

Every change of device settings can be automatically recorded and documented in the Audit Trail Log on the SmartMedia card. The recording can be encrypted.

Safety Information

Application in Hazardous Locations

Caution!

Never try to open the module! If a repair should be required, return the module to our factory.

If the specifications in the instruction manual are not sufficient for assessing the safety of operation, please contact the manufacturer to make sure that your intended application is possible and safe.

Be sure to observe during installation:

- Switch off power supply before replacing or inserting a module.
- Before commissioning it must be proved that the device may be connected with other equipment.

Application in Hazardous Locations:

PA 700X Module

When using the PA 700 X module, the stipulations for electrical installations in hazardous areas (EN 60079-14) must be observed. When installing the device outside the range of applicability of the 94/9/EC directive, the appropriate standards and regulations in the country of use must be observed. The module has been developed and manufactured in compliance with the applicable European guidelines and standards.

Compliance with the European Harmonized Standards for use in hazardous locations is confirmed by the EC-Type-Examination Certificate. Compliance with the European guidelines and standards is confirmed by the EC Declaration of Conformity.

There is no particular direct hazard caused by the operation of the device in the specified environment.

Software Version

PA 700(X) Module

Device Software M 700(X)

The PA 700(X) module is supported by software version 5.0 or higher. Module software version 2.x requires device software version 7.x.

Software version 1.3 01.06.2004
Software version 2.2 02.04.2007

Query actual device/module software

When the analyzer is in measuring mode:
Press **menu** key, open Diagnostics menu.

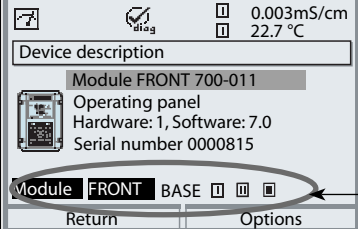
Menu	Display	Device description
		Provides information about all modules installed: Module type and function, serial number, hardware and software version and device options. Select the different modules (FRONT, BASE, slots 1 - 3) using the arrow keys.

Modular Concept

Basic Unit, Measuring Module, Additional Functions

The M 700(X) is an expandable modular process analysis system. The basic unit (FRONT and BASE modules) provides three slots which can be equipped by the user with any combination of measuring or communication modules. The software capabilities can be expanded by additional functions (options). Additional functions must be ordered separately. They are supplied with a device-specific TAN for function release.

M 700(X) Modular Process Analysis System



Additional functions

Activation via device-specific TAN



SmartMedia card

Data recording



3 module slots

for free combination of measuring and communication modules

Measuring modules

- pH / ORP / Temp
- O₂/Temp
- Noncontacting conductivity/Temp
- Contacting conductivity/Temp

Communication modules

- OUT (additional switching and current outputs)
- PID (analog and digital controller)
- Profibus PA
- Foundation Fieldbus
- EC 400 probe controller

Documentation

The basic unit is accompanied by a CD-ROM containing the complete documentation.

Latest product information as well as instruction manuals for earlier software releases are available at www.mtpro.com.

Short Description

Short Description: FRONT Module

4 captive screws

for opening the analyzer

(Caution! Make sure that the gasket between FRONT and BASE is properly seated and clean!)

Transflective LC graphic display

(240 x 160 pixels)

white backlighting, high resolution and high contrast.

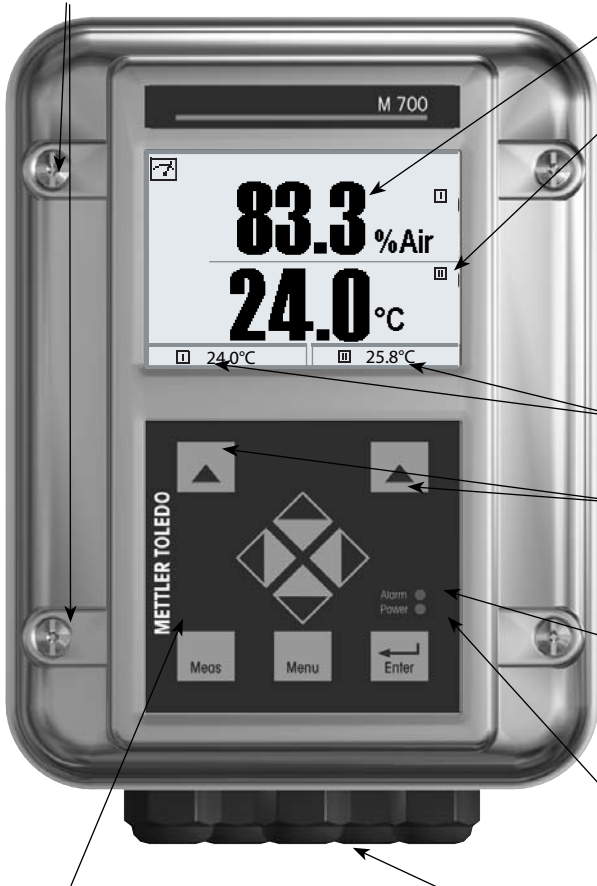

Measurement display

User interface

with plaintext menus as recommended by NAMUR.

Menu texts can be switched to: German, English, French, Italian, Swedish, and Spanish.

Intuitively acquirable menu logic, based on Windows standards.

Secondary displays

2 softkeys

with context-sensitive functions.

Red LED

signals failure (On) or maintenance request/function check (flashing) according to NE 44.

Green LED

Voltage supply okay

Control panel

3 function keys

(menu, meas, enter)

and 4 arrow keys for menu selection

and data entries

5 self-sealing cable glands

M20 x 1.5

for entry of voltage supply and signal lines

Short Description: Menu Structure

Basic Functions: Calibration, Maintenance, Parameter Setting, Diagnostics

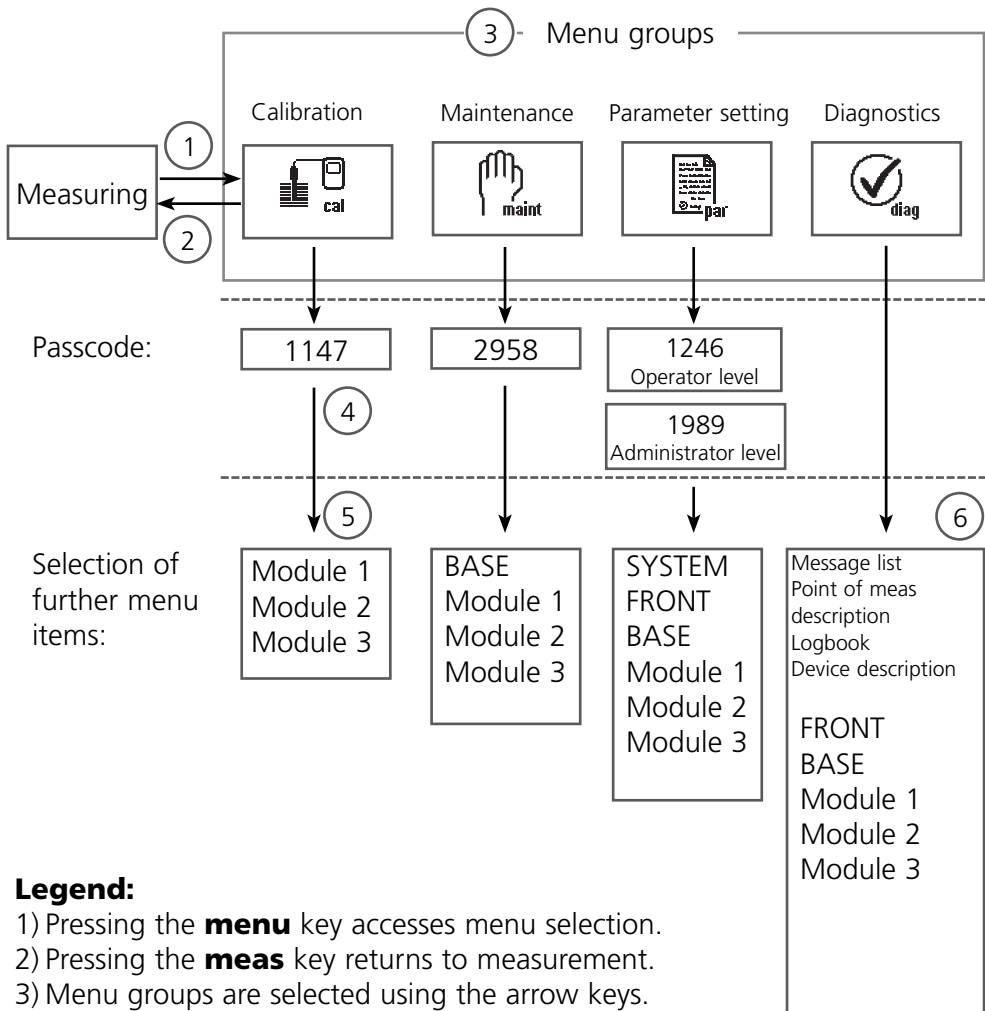

Legend:

- 1) Pressing the **menu** key accesses menu selection.
- 2) Pressing the **meas** key returns to measurement.
- 3) Menu groups are selected using the arrow keys.
- 4) Press **enter** to confirm, enter passcode.
- 5) Further menu items are displayed.
- 6) Selected functions of the Diagnostics menu can be recalled via softkey even when in measuring mode.

Short Description: FRONT Module

View into the open device (FRONT module)

Slot for SmartMedia card

- Data recording
The SmartMedia card expands the measurement recorder capacity to > 50000 records.
- Exchange of parameter sets
5 parameter sets can be stored on the SmartMedia card. The 2 internal parameter sets can be switched by remote control. Configurations can be transmitted from one analyzer to the other.
- Function expansions
are possible with additional software modules, which are released using transaction numbers (TAN)
- Software updates

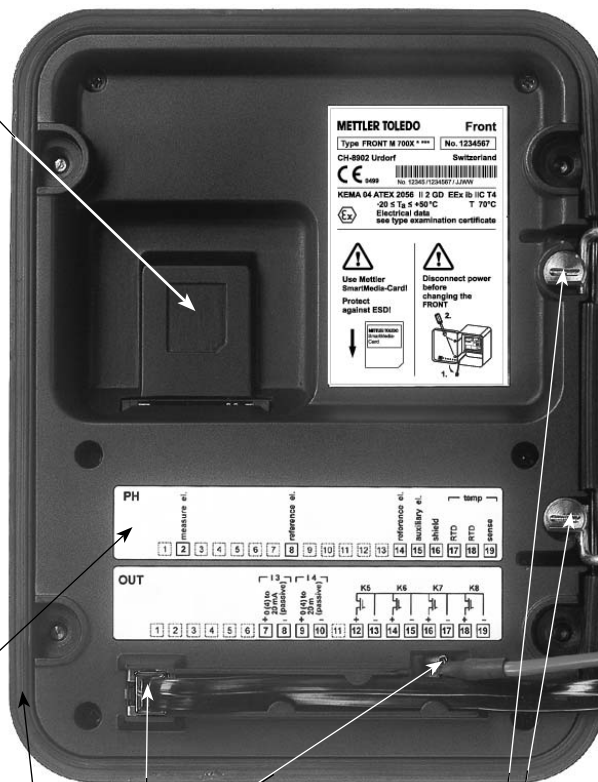

Terminal plates of "hidden" modules

Each module comes with an adhesive label containing the contact assignments. This label should be stuck to the inner side of the front (as shown). Then, the terminal assignments remain visible even if further modules are inserted.

Replacing the front module

Pull off power cord and ground wire. To separate the FRONT module from the BASE module, turn the retaining screws of the pivot hinge by 90°.

The circumferential sealing

guarantees IP 65 protection and allows spray cleaning / disinfection.

Caution! Keep clean!

Short Description: BASE Module

View into the open device (BASE module, 3 function modules installed)

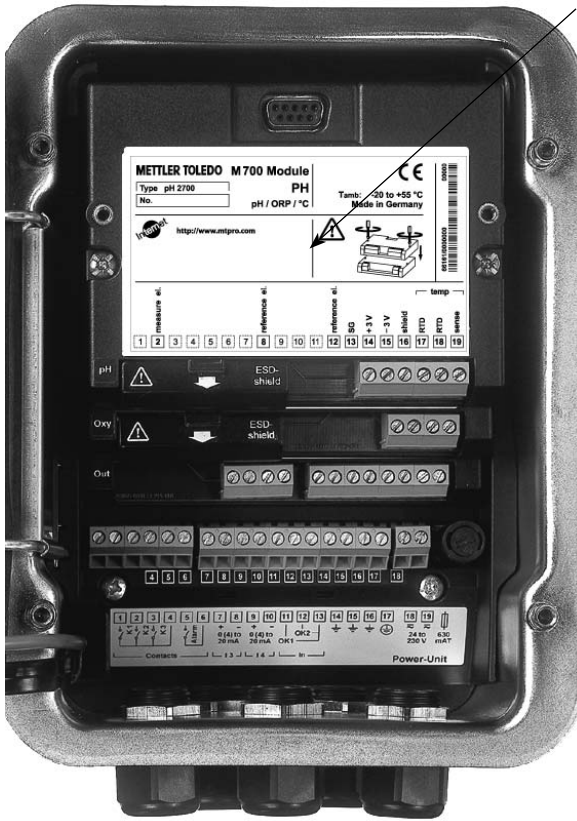

Module equipment

Module identification: Plug & Play.

Up to 3 modules can be combined as desired. Several input and communication modules are available.

BASE module

2 current outputs (free assignment of process variable) and 4 relay contacts, 2 digital inputs.

VariPower broad-range power supply, 20 ... 265 V AC/DC, suitable for all public mains supplies in the world.

Power supply units, IS version:

100 ... 230 V AC or
24 V AC/DC



Warning!

Do not touch the terminal compartment, there may be dangerous contact voltages!

Important notice concerning SmartMedia card

The SmartMedia card may be inserted or replaced with the power supply switched on. Before a memory card is removed, it must be "closed" in the maintenance menu. When closing the device, make sure that the sealing is properly seated and clean.

PROFIBUS Technology

PROFIBUS is a digital communication system that connects different field devices over a common cable and integrates them into a control system. In the long term, PROFIBUS will replace the 4-20mA technology, which only supplies pure measured values. Advantages of the PROFIBUS technology are:

- easy and cost-saving cabling
- convenient operation over a central control station
- transmission, evaluation, and control of high amounts of data from field device to control station.
- devices installed in hazardous locations are configured and maintained from the control station

PROFIBUS is the leading open fieldbus system in Europe. Its application range covers manufacturing, process, and building automation. As open fieldbus standard to EN 50170 and IEC 61158, PROFIBUS ensures communication of different devices over one bus. The PROFIBUS User Organization (PNO) provides for further development and maintenance of the PROFIBUS technology. It combines the interests of users and manufacturers.

Variants and Basic Characteristics

PROFIBUS determines the technical and functional characteristics of a serial bus system. There are three PROFIBUS variants:

- PROFIBUS-DP (decentralized peripherals)
Tailored for communication of automation systems and distributed peripherals.
RS 485 standard with transmission rates up to 12 MBits/sec
- PROFIBUS-PA (process automation)
Dedicated to the process industry. It permits connection of sensors and actuators to a common bus even in hazardous locations. PROFIBUS-PA has a transmission rate of 31.25 kBits/sec.

PROFIBUS Technology

PROFIBUS distinguishes between two types of devices:

- **Masters**
Control the data traffic on the bus. They send messages without external request.
- **Slaves**
Peripheral devices such as valves, drives, transmitters, and analyzers. They can react acyclically to servicing, configuration and diagnostic tasks of the master. The central controller cyclically reads the measurement data with status.

Definitions for PROFIBUS-PA

The bus protocol defines type and speed of the data exchange between master and slave devices and determines the transmission protocol of the respective PROFIBUS system.

PROFIBUS-PA permits cyclic and acyclic services.

- Cyclic services are used for transmission of measurement data and actuating commands with status information.
- Acyclic services are used for device configuration, maintenance and diagnostics during operation.



The PA 3.0 device profile defines the device class and typical functionalities with parameters, ranges, and limit values.

The FISCO model developed by the German PTB for hazardous locations permits connection of several devices to one common bus and defines permissible limits for device and cable parameters.



Terminal Plate

PA 700(X) Module

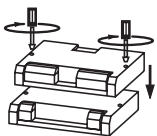
Terminal Plate PA 700 Module:

METTLER TOLEDO M 700 Module		PA		CE		00000												
Type PA 700		PA		Tamb: -20 to +55 °C		00000												
No.		PROFIBUS PA		Made in Germany		59802/0000000												
 http://www.mt.com				 				59802/0000000										
┌ PROFIBUS ┐ MBP-IS																		
PA + PA - shield																		
1	2	3	4	5	6	7	8	9	10	11	12	13	14	15	16	17	18	19

Terminal Plate PA 700X Module:

METTLER TOLEDO M 700X Module		COMPA		CE		00000												
Type PA 700 X		PA		Tamb: -20 to +50 °C		00000												
No.		PA		Made in Germany/Kassel		67134/0000000/0650												
 KEMA 04 ATEX 2056 Electr. data see type examination certificate II 2 (1) GD EEx ib [ia] IIC T4 T 70 °C CH-8902 Urdorf Switzerland																		
 IS, CLASS I, DIV1, GRP A, B, C, D, T4 Entity, Ta = 50 °C CLASS I, ZONE 1, AEx ib [ia], GRP IIC, T4 control dwg. 201.004-110																		
 NI, CI I, DIV 2, GRP A, B, C, D with IS circuits extending into DIV 1 AIS, CI I, Zone 1, Ex ib [ia] IIC T4 control dwg. 201.004-120																		
┌ PROFIBUS ┐ MBP-IS																		
PA + PA - shield																		
1	2	3	4	5	6	7	8	9	10	11	12	13	14	15	16	17	18	19

Attaching the Terminal Plates

The terminal plates of the lower modules can be stuck to the inner side of the door. This facilitates maintenance and service.



Inserting the Module

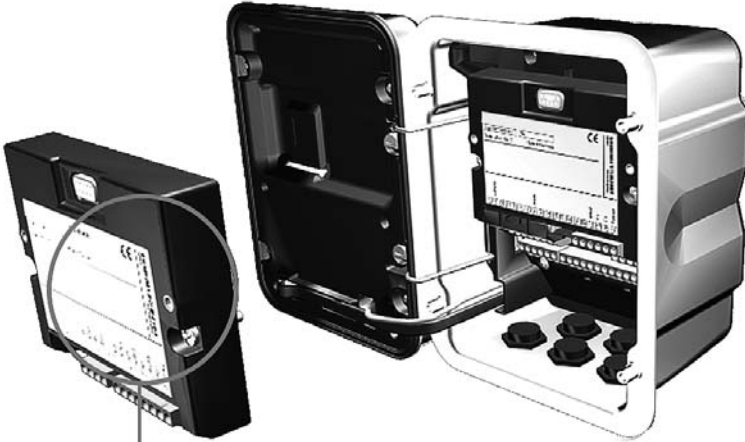

Thanks to the staggered arrangement of connectors and fastening screws the terminal strips of all modules are easy to access.

Make sure that the cable glands are tightly closed to protect against humidity.

1. Switch off power supply
2. Open the device (loosen the 4 screws at the front)
3. Place module in slot (D-SUB connector)
4. Tighten fastening screws of the module
5. Connect signal lines
6. Close device, tighten screws at the front
7. Switch on power supply
8. Assigning process variables to AI blocks on the device
9. Set parameters

PROFIBUS PA Installation

Basic build-up of a PROFIBUS system:

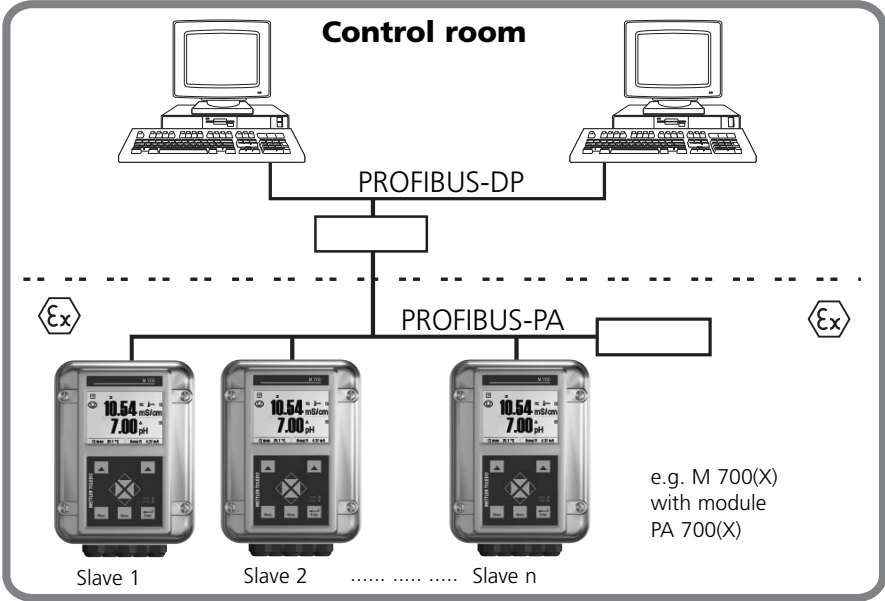

Electrical connection between module and PROFIBUS PA is in accordance with the PROFIBUS Guideline, Order No. 2.092 (www.profibus.com).

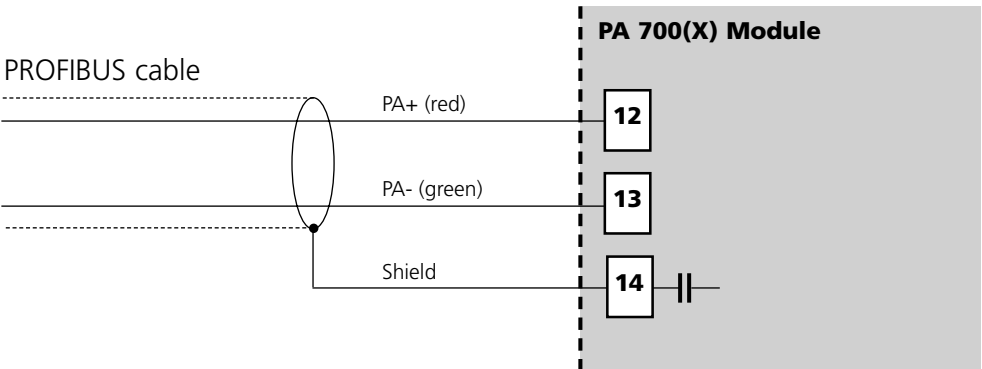

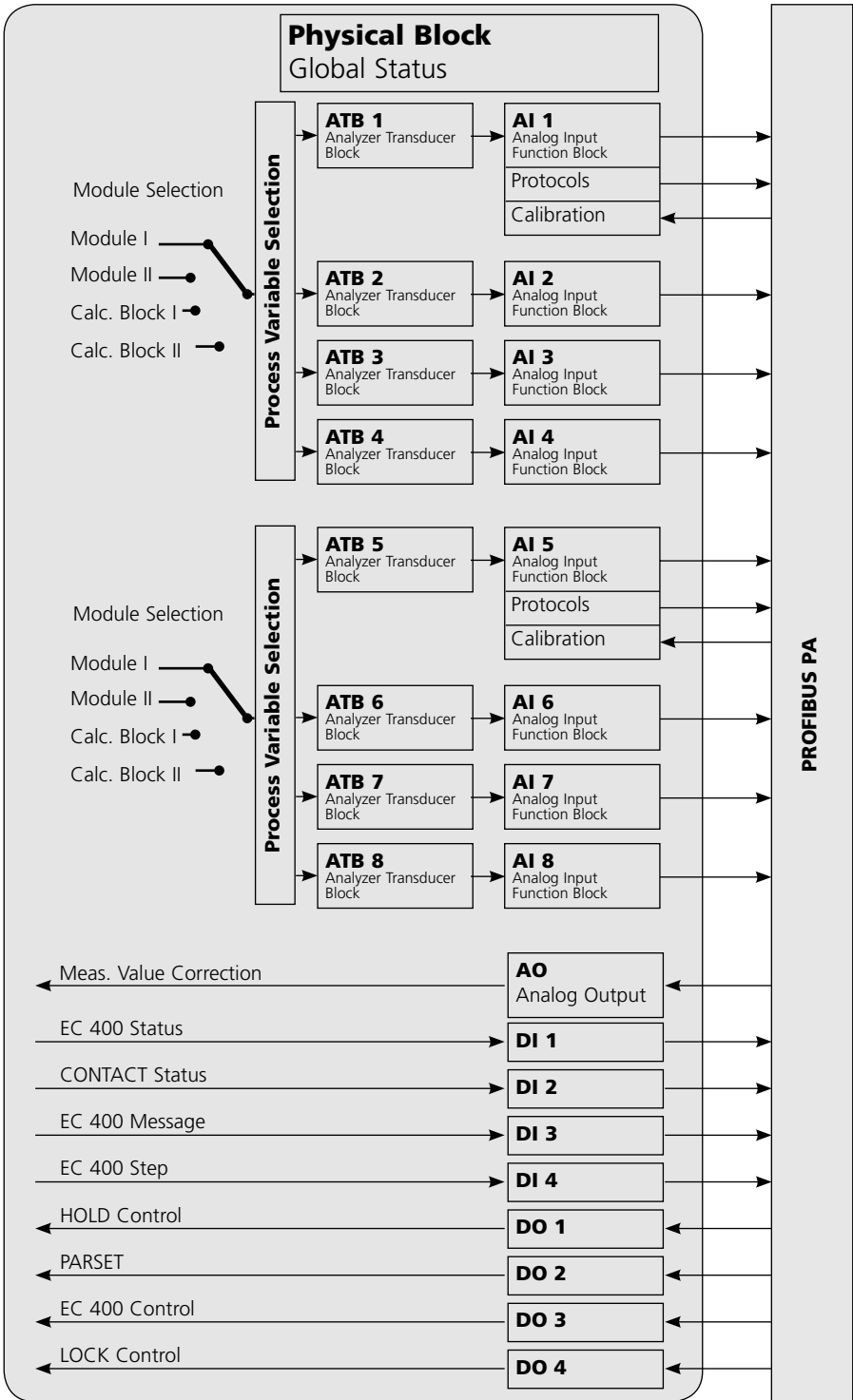

Communication Model

See diagram on previous side

The device parameters are sorted in three types of blocks:

Physical Block (PB)

This block contains the general parameters which apply to the whole device.

Transducer Blocks (TB 1 ... TB 8)

8 analog blocks. They contain measurement parameters (process variable, temperature) according to the PROFIBUS-PA Profile 3.0 specification.

Function Blocks

- 8 analog input blocks (AI1..4, AI5..8, for scaling measured values),
- 4 digital output blocks (DO 1 ... DO 4, for control signals)
- 4 digital input blocks (DI 1 ... DI 4, for status messages).
- 1 analog output block (AO 1) for analog compensation signals,
e.g. O₂ process pressure.

Physical Block (PB)

This block contains the device-specific parameters (model designation, manufacturer ID, serial number...) and controls basic device functions such as:

- Write protection
("WRITE_LOCKING" parameter) Enables or locks acyclic services (maintenance, configuration).
- Blocking operator access to the device
("LOCAL_OP_ENA" parameter)
Enables or locks access via the user interface on the device.
Notice:
When communication fails for more than 30 seconds,
the device automatically switches to local access.
- Reset
("FACTORY_RESET" parameter)
Caution – data loss!
Resets all configuration values to factory setting.

Analog Input blocks

Analog Input Blocks

The module provides 8 analog input blocks (AI 1 ... AI 8).

They are divided into two groups (channels):

AI 1..4: Channel 1

AI 5.0.8: Channel 2

Each channel can be assigned to one measuring module (or Calculation Block). The "AI 1..4 configuration" ("AI 5..8 configuration") menu only displays those measured values which are provided by the selected measuring module. Both channels can also be assigned to the same measuring module. For configuration on the device, see Page 23.

An Analog Input Block contains the signal processing options for the process variable supplied from the Transducer Block.

The following parameters are available:

Analog Input Blocks

Function	Parameter	Remark
Channel selection	CHANNEL	Determined by the assignment of process value to AI block in the device (see Page 22)
Simulation	SIMULATE	Specifying an input value for testing the system
Process value	PV_SCALE	Scaling the measured variable
Scaling	OUT_SCALE EU at 100% EU at 0%	Scaling of output range Max value Min value
Attenuation	PV_FTIME	Attenuating the input value to suppress noise peaks
Alarm	HI_LIM HI_HI_LIM LO_LIM LO_LO_LIM ALARM_HYS	Specifying HIGH warning Specifying HIGH alarm Specifying LOW warning Specifying LOW alarm Hysteresis
Block mode	MODE_BLK	Out of service Manual Automatic
Error behavior	FSAFE_TYPE	0: The content of [FSAFE_VALUE] is output as value, together with the status signal "Uncertain Substitute Value" 1: The last valid measured value is output, together with the status signal "Uncertain Last Usable Value" 2: No editing. Status: Bad

Function Blocks: Analog Input Blocks

Selecting the channels of the Analog Input Blocks on the device

Channel 1: AI 1..4, channel 2: AI 5..8

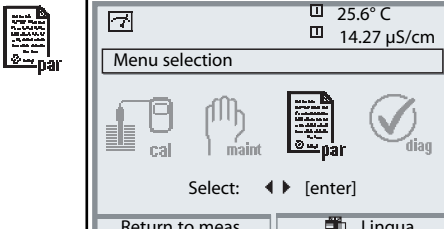
Menu	Display	Assigning process variables to Analog Input Blocks
	<p>25.6 °C 14.27 μS/cm</p> <p>Menu selection</p> <p>cal maint par diag</p> <p>Select: ◀ ▶ [enter]</p> <p>Return to meas Lingua</p>	<p>Call up parameter setting</p> <p>From the measuring mode: Press menu key to select menu. Select parameter setting using arrow keys, confirm with enter.</p>
	<p>25.6 °C 14.27 μS/cm</p> <p>Parameter setting</p> <p>Viewing level (All Data) view Operator level (Operation Data) opl Administrator level (All Data) adm</p> <p>Return</p>	<p>Administrator level:</p> <p>Access to all functions, also passcode setting. Releasing or blocking a function for access from the Operator level.</p>
	<p>HOLD 25.6 °C 14.27 μS/cm</p> <p>Parameter setting (Administrator)</p> <p>System control Module FRONT 700-011 Module BASE 700-021 Module Cond 7700 Module pH 2700 Module PA 700</p> <p>Return Release</p>	<p>Select PROFIBUS module:</p> <p>M 700 permits variable equipment with 2 measuring modules (and PROFIBUS PA module). The available process variables are assigned via "AI... configuration".</p>
	<p>HOLD 25.6 °C 14.27 μS/cm</p> <p>AI configuration (Administrator)</p> <p>Profibus address AI1..4 configuration AI5..8 configuration Bus activation</p> <p>Return Block</p>	<p>Select channel:</p> <p>Now you can assign a measuring module to one of the two channels (4 Analog Input blocks each) on the device. Both channels can be assigned to the same module. This allows evaluating more measured values.</p>

For Copy: Individual Settings

Assigning process variables to Analog Input Blocks on the device

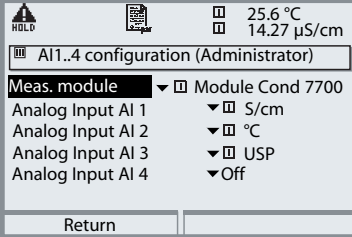
Menu	Display	Assigning process variables to Analog Input Blocks
		<p>Select AI configuration: Here you assign the process variables of a module to the 4 Analog Input blocks.</p>

AI Block

Process variable assigned

AI1..4 Selected measuring module

Analog Input Block AI 1

Analog Input Block AI 2

Analog Input Block AI 3

Analog Input Block AI 4

AI5..8 Selected measuring module

Analog Input Block AI 5

Analog Input Block AI 6

Analog Input Block AI 7

Analog Input Block AI 8

Configuration with PROFIBUS

Device database file (GSD file)

The GSD file contains the description of the device parameters and allows integration of the device in the PROFIBUS-PA system.

The included CD-ROM contains the device database file

METT7533.gsd

and the DD (Device Description) folder with further files

Cyclic Data Communication

The cyclic data traffic has two transport directions:

- Input data (data are sent from field device to process control system: Input data are provided by Analog Input and Discrete Input function blocks.)
- Output data (data are sent from process control system to field device: Output data are processed by Analog Output and Discrete Output function blocks.)

Structure of Cyclic Input Data Telegram

Data	Access	Data format / Interpretation
Analog Input Function Block 1 "Process Value 1"	r	Measured value (32-bit floating point, IEEE-754) Status byte
Analog Input Function Block 2 "Process Value 2"	r	Measured value (32-bit floating point, IEEE-754) Status byte
Analog Input Function Block 3 "Process Value 3"	r	Measured value (32-bit floating point, IEEE-754) Status byte
Analog Input Function Block 4 "Process Value 4"	r	Measured value (32-bit floating point, IEEE-754) Status byte
Analog Input Function Block 5 "Process Value 5"	r	Measured value (32-bit floating point, IEEE-754) Status byte
Analog Input Function Block 6 "Process Value 6"	r	Measured value (32-bit floating point, IEEE-754) Status byte
Analog Input Function Block 7 "Process Value 7"	r	Measured value (32-bit floating point, IEEE-754) Status byte
Analog Input Function Block 8 "Process Value 8"	r	Measured value (32-bit floating point, IEEE-754) Status byte

DI Function Blocks

DI 1: EC 400 status

Bit								Meaning
7	6	5	4	3	2	1	0	
							1	Probe in MEASURE position (PROCESS)
						1		Probe in SERVICE position
					1			Service switch actuated
				1				EC 400 alarm
			1					EC 400 program running
0	0	0						No program
0	0	1						Program: Cleaning
0	1	0						Program: Cal 2point
0	1	1						Program: Cal 1point
1	0	0						Program: Parking
1	0	1						Program: USER 1
1	1	0						Program: USER 2
1	1	1						Program: Service

DI 2: CONTACTS / LOCK Status / ENABLE Request

Bit								Meaning
7	6	5	4	3	2	1	0	
							1	Contact K4 active
						1		Contact K3 active
					1			Contact K2 active
				1				Contact K1 active
			1					CAL terminates AI-TB1 (1 min or until cal record collected)
		1						CAL terminates AI-TB2 (1 min or until cal record collected)
0	0							Measuring mode
0	1							Unconfirmed enable request
1	0							Confirmed enable request
1	1							Enable

DI Function Block EC 400 Messages

DI 3: EC 400 Messages

Bit								Meaning
7	6	5	4	3	2	1	0	
							1	Probe maintenance request
						1		Media adapter maintenance request
					1			EC 400 basic device maintenance request
			1					Medium maintenance request
			1					Probe failure
		1						Media adapter failure
	1							EC 400 basic device failure
1								Calibration / Communication error

Explanation of EC 400 Messages: Maintenance request

Probe maintenance request

U 231	Probe move time MEASURE (PROCESS)
U 234	Probe move time SERVICE
U 232	Probe wear counter
U 228	Probe cylinder untight

Media adapter maintenance request

U 190	Buffer I almost empty
U 191	Buffer II almost empty
U 192	Cleaner almost empty

Maint. request / EC 400 basic device

U 233	Water pressure switch
U 229	Sensor dismount guard defective
U 235	Safety valve defective
U 248	Water valve defective (electrical)

Medium maintenance request

U 241	Check water
U 242	Check buffer I
U 243	Check buffer II
U 244	Check cleaner
U 245	Check aux. valve I
U 246	Check aux. valve II

EC 400 Messages, EC 400 Step

Explanation of EC 400 Messages: Failure

Probe failure	
U 230	Probe limit position MEASURE (PROCESS)
U 227	Probe limit position SERVICE
Media adapter failure	
U 194	Buffer I empty
U 195	Buffer II empty
U 196	Cleaner empty
EC 400 basic device failure	
U 220	Compressed air switch
U 225	Probe valve defective
U 224	EC 400 flooded
U 221	Sensor dismantled
Calibration / Communication error	
U 251	Calibration error
U 252	Communication error

DI 4: EC 400 Step

Bit								Meaning	
7	6	5	4	3	2	1	0		
							1	System in SINGLE_STEP	
		X	X	X	X	X		Step 1 ... 30	
	0								Reserved
0									Reserved

The half-automated EC 400 program control in Single-Step Mode can only be activated and triggered from the M 700. Control via bus is not possible, however the Single-Step Mode can be watched.

DO Function Blocks

DO 1: HOLD Control

Bit								Meaning
7	6	5	4	3	2	1	0	
							1	System HOLD
						0		Reserved
					0			Reserved
				0				Reserved
			0					Reserved
		0						Reserved
	0							Reserved
0								Reserved

DO 2: PARSET

Bit								Meaning
7	6	5	4	3	2	1	0	
							1	Parameter set A (internal)
					0	0	0	Parameter set not from card
					0	0	1	Parameter set 1 (card)
					0	1	0	Parameter set 2 (card)
					0	1	1	Parameter set 3 (card)
					1	0	0	Parameter set 4 (card)
					1	0	1	Parameter set 5 (card)
			0					Reserved
		0						Reserved
	0							Reserved
0								Reserved

DO Function Blocks

DO 3: EC 400 Control

Bit								Meaning
7	6	5	4	3	2	1	0	
							X	Reserved
						1		Probe in SERVICE position (MEASURE = 0)
					1			Manual, Time control Off (Auto, Time control On = 1)
				X				Reserved
			X					Reserved
0	0	0						No program start
0	0	1						Program: Cleaning
0	1	0						Program: Cal 2point
0	1	1						Program: Cal 1point
1	0	0						Program: Parking
1	0	1						Program: USER 1
1	1	0						Program: USER 2
1	1	1						No program start

DO 4: LOCK Control

Bit								Meaning
7	6	5	4	3	2	1	0	
						0	0	Measuring mode
						0	1	Enabled
						1	0	Busy
						1	1	Not used
					X			Reserved
				X				Reserved
			X					Reserved
		X						Reserved
	X							Reserved
X								Reserved

Configuration Data

The “Cyclic Data Communication” table on the previous pages shows the maximum configuration of the cyclic data telegram.

The telegram can be adapted to the respective system requirements if you do not require all data.

For projecting, proceed as follows:

- Load the GSD file in the software of the automation system
- From the configuration software of the automation system, select those data which are required in the cyclic telegram.

From your projecting data, the configuration software of the automation system collects the configuration data which will be transferred from the process control to the field device. The configuration data (CHK_CFG) determine the contents of the cyclic data telegram.

As an alternative, you can also compile the configuration data according to the tables shown on the following pages.

The configuration data consist of 17 sections, each section being assigned to a Function Block. The content determines whether a Function Block takes part in the cyclic data traffic or not. The sequence of data in the cyclic Input/Output data telegram corresponds to the position of the respective Function Block in the configuration data.

Configuration Data

Analog Input blocks (1 ... 8)

Section	Function Block	Configuration Data	Description	Input	Output
1	AI 1	0x00	Free Place	-	-
		0x42, 0x84, 0x08, 0x05, or 0x42, 0x84, 0x81, 0x81, or 0x94	"Process Value 1"	5 bytes	-
2	AI 2	0x00	Free Place	-	-
		0x42, 0x84, 0x08, 0x05, or 0x42, 0x84, 0x81, 0x81, or 0x94	"Process Value 2"	5 bytes	-
3	AI 3	0x00	Free Place	-	-
		0x42, 0x84, 0x08, 0x05, or 0x42, 0x84, 0x81, 0x81, or 0x94	"Process Value 3"	5 bytes	-
4	AI 4	0x00	Free Place	-	-
		0x42, 0x84, 0x08, 0x05, or 0x42, 0x84, 0x81, 0x81, or 0x94	"Process Value 4"	5 bytes	-
5	AI 5	0x00	Free Place	-	-
		0x42, 0x84, 0x08, 0x05, or 0x42, 0x84, 0x81, 0x81, or 0x94	"Process Value 5"	5 bytes	-
6	AI 6	0x00	Free Place	-	-
		0x42, 0x84, 0x08, 0x05, or 0x42, 0x84, 0x81, 0x81, or 0x94	"Process Value 6"	5 bytes	-
16	AI 7	0x00	Free Place	-	-
		0x42, 0x84, 0x08, 0x05, or 0x42, 0x84, 0x81, 0x81, or 0x94	"Process Value 7"	5 bytes	-
17	AI 8	0x00	Free Place	-	-
		0x42, 0x84, 0x08, 0x05, or 0x42, 0x84, 0x81, 0x81, or 0x94	"Process Value 8"	5 bytes	-

Configuration Data

Discrete Input Blocks (1 ...4)

Section	Function Block	Configuration Data	Description	Input	Output
7	DI 1	0x00	Free Place	-	-
		0x42, 0x81, 0x05, 0x05, or 0x42, 0x81, 0x83, 0x81, or 0x91	"EC 400 Status"	2 bytes	-
8	DI 2	0x00	Free Place	-	-
		0x42, 0x81, 0x05, 0x05, or 0x42, 0x81, 0x83, 0x81, or 0x91	"CONTACT Status"	2 bytes	-
12	DI 3	0x00	Free Place	-	-
		0x42, 0x81, 0x05, 0x05, or 0x42, 0x81, 0x83, 0x81, or 0x91	"EC 400 Message"	2 bytes	-
13	DI 4	0x00	Free Place	-	-
		0x42, 0x81, 0x05, 0x05, or 0x42, 0x81, 0x83, 0x81, or 0x91	"EC 400 Step"	2 bytes	-

Configuration Data

Discrete Output Blocks (DO1 ... 4), Analog Output Block AO1

Section	Function Block	Configuration Data	Description	Input	Output
9	DO 1	0x00	Free Place	-	-
		0x82, 0x81, 0x84, 0x82, or 0xA1	"HOLD Control"	2 bytes	-
		0xC1, 0x81, 0x81, 0x83, or 0xC2, 0x81, 0x81, 0x84, 0x83	"HOLD Control / Status"	2 bytes	2 bytes
10	DO 2	0x00	Free Place	-	-
		0x82, 0x81, 0x84, 0x82, or 0xA1	"PARSET"	2 bytes	-
		0xC1, 0x81, 0x81, 0x83, or 0xC2, 0x81, 0x81, 0x84, 0x83	"Control / Status"	2 bytes	2 bytes
11	DO 3	0x00	Free Place	-	-
		0x82, 0x81, 0x84, 0x82, or 0xA1	"EC 400 Control"	2 bytes	-
		0xC1, 0x81, 0x81, 0x83, or 0xC2, 0x81, 0x81, 0x84, 0x83	"Control / Status"	2 bytes	2 bytes
14	DO 4	0x00	Free Place	-	-
		0x82, 0x81, 0x84, 0x82, or 0xA1	"Lock Control"	2 bytes	-
		0xC1, 0x81, 0x81, 0x83, or 0xC2, 0x81, 0x81, 0x84, 0x83	"Lock Control / Status"	2 bytes	2 bytes
15	AO 1	0x00	Free Place	-	-
		0x82, 0x84, 0x82, 0x82, or 0xA4	"Compensation Value"	2 bytes	-

PA Slot Model

Slot No.	Block	Usage
0	PB	General data
1	AI1	Measured value 1
2	AI2	Measured value 2
3	AI3	Measured value 3
4	AI4	Measured value 4
5	AI5	Measured value 5
6	AI6	Measured value 6
16	AI7	Measured value 7
17	AI8	Measured value 8
7	DI1	Sense EC 400 status
8	DI2	Sense contacts K1 ... K4
12	DI3	EC 400 Message
13	DI4	EC 400 Step
9	DO1	HOLD control
10	DO2	Parameter set control
11	DO3	EC 400 control
14	DO4	Lock Control
15	AO1	Analog Output 1
18	TB1	Measured value for AI 1
19	TB2	Measured value for AI 2
20	TB3	Measured value for AI 3
21	TB4	Measured value for AI 4
22	TB5	Measured value for AI 5
23	TB6	Measured value for AI 6
24	TB7	Measured value for AI 7
25	TB8	Measured value for AI 8

PB Block Parameters

Defaults & Writable Ranges

Parameter Name	Data Type	Size	Store	Access	Default Value	Writable Range	Slot	Index
BLOCK_OBJECT	DS-32	20	C	r			0	16
Reserved	Unsigned8	1						
Block_Object	Unsigned8	1						
Parent_Class	Unsigned8	1						
Class	Unsigned8	1						
DD_Reference	Unsigned32	4						
DD_Revision	Unsigned16	2						
Profile	OctetString	2						
Profile_Revision	Unsigned16	2						
Execution Time	Unsigned8	1						
Number_of_Param	Unsigned16	2						
Address_of_View_1	Unsigned16	2						
Number_of_Views	Unsigned8	1						
ST_REV	Unsigned16	2	N	r	0		0	17
TAG_DESC	OctedString	32	S	r, w	" "	no restrictions	0	18
STRATEGY	Unsigned16	2	S	r, w	0	no restrictions	0	19
ALERT_KEY	Unsigned8	1	S	r, w	0	no restrictions	0	20
TARGET_MODE	Unsigned8	1	S	r, w	0x08	0x08; automatic	0	21
MODE_BLK	DS-37	3	D	r			0	22
Actual	Unsigned8	1			0x08			
Permitted	Unsigned8	1			0x08			
Normal	Unsigned8	1			0x08			
ALARM_SUM	DS-42	8	D	r			0	23
Current	OctedString	2			0			
Unacknowledged	OctedString	2			0			
Unreported	OctedString	2			0			
Disabled	OctedString	2			0			
SOFTWARE_REVISION	VisibleString	16	C	r			0	24
HARDWARE_REVISION	VisibleString	16	C	r			0	25

PB Block Parameters

Defaults & Writable Ranges. Continued.

Parameter Name	Data Type	Size	Store	Access	Default Value	Writable Range	Slot	Index
DEVICE_MAN_ID	Unsigned16	2	C	r			0	26
DEVICE_ID	VisibleString	16	C	r			0	27
DEVICE_SER_Num	VisibleString	16	C	r			0	28
DIAGNOSIS	OctedString	4	D	r	0		0	29
DIAGNOSIS_EXTENSION	OctedString	6	D	r	0		0	30
DIAGNOSIS_MASK	OctedString	4	C	r			0	31
DIAGNOSIS_MASK_EXTENSION	OctedString	6	C	r			0	32
DEVICE_CERTIFICATION	VisibleString	32	C	r			0	33
WRITE_LOCKING	Unsigned16	2	N	r/w	2457	0: no acyclic write 2457: all parameters writable	0	34
FACTORY_RESET	Unsigned16	2	S	r/w	0	0: no action 1: reset parameters to default 2506: warmstart, no param change	0	35
DESCRIPTOR	OctedString	32	S	r/w	" "	no restrictions	0	36
DEVICE_MESSAGE	OctedString	32	S	r/w	" "	no restrictions	0	37
DEVICE_INSTAL_DATE	OctedString	16	S	r/w	" "	no restrictions	0	38
LOCAL_OP_ENA	Unsigned8	1	N	r/w	1	0: local op. disabled 1: local op. enabled	0	39
IDENT_NUMBER_SELECTOR	Unsigned8	1	S	r/w	1	0: profile specific ID 1: manufacturer specific ID number	0	40
DEVICE_CONFIGURATION	VisibleString	32	N	r	" "		0	52
INIT_STATE	Unsigned8	1	S	r/w	2	2: Run 5: Maintenance	0	53
DEVICE_STATE	Unsigned8	1	D	r/w	2	2: Run 5: Maintenance	0	54
GLOBAL_STATUS	Unsigned16	2	D	r	0		0	55

TB Analyzer Block Parameters

Defaults & Writable Ranges

Parameter Name	Data Type	Size	Store	Access	Default Value	Writable Range	Slot	Index
BLOCK_OBJECT	DS-32	20	C	r			12-17	16
Reserved	Unsigned8	1						
Block_Object	Unsigned8	1						
Parent_Class	Unsigned8	1						
Class	Unsigned8	1						
DD_Reference	Unsigned32	4						
DD_Revision	Unsigned16	2						
Profile	OctetString	2						
Profile_Revision	Unsigned16	2						
Execution Time	Unsigned8	1						
Number_of_Param	Unsigned16	2						
Address_of_View_1	Unsigned16	2						
Number_of_Views	Unsigned8	1						
ST_REV	Unsigned16	2	N	r	0		12-17	17
TAG_DESC	OctedString	32	S	r, w	" "	no restrictions	12-17	18
STRATEGY	Unsigned16	2	S	r, w	0	no restrictions	12-17	19
ALERT_KEY	Unsigned8	1	S	r, w	0	no restrictions	12-17	20
TARGET_MODE	Unsigned8	1	S	r, w	0x08	0x08; automatic	12-17	21
MODE_BLK	DS-37	3	D	r			12-17	22
Actual	Unsigned8	1			0x08			
Permitted	Unsigned8	1			0x08			
Normal	Unsigned8	1			0x08			
ALARM_SUM	DS-42	8	D	r			12-17	23
Current	OctedString	2			0			
Unacknowledged	OctedString	2			0			
Unreported	OctedString	2			0			
Disabled	OctedString	2			0			
COMPONENT_NAME	OctedString	32	S	r, w	Transducer Block n	no restrictions	12-17	24
PV	DS-60	12	D	r			12-17	25
PV	Unsigned8	4			0.0			
Measurement_Status	Unsigned8	1			0x4C			
PV_Time	Unsigned8	7			Monday, 1. Jan 2003 0h			

TB Analyzer Block Parameters

Defaults & Writable Ranges: continued

Parameter Name	Data Type	Size	Store	Access	Default Value	Writable Range	Slot	Index
PV_UNIT	Unsigned16	2	S	r, w	1243	depending on the kind of measurement	12-17	26
PV_UNIT_TEXT	OctedString	8	S	r, w	" "	no restrictions	12-17	27
ACTIVE_RANGE	Unsigned8	1	S	r, w	1	1	12-17	28
AUTORANGE_ON	Boolean	1	S	r, w	1	1	12-17	29
SAMPLING_RATE	Time Diff	4	S	r, w	1000	do not change	12-17	30
NUMBER_OF_RANGES	Unsigned8	1	N	r	1		12-17	41
RANGE_1	DS-61	8	N	r, w		depending on the kind of	12-17	42
Begin_of_Range	Float	1			-2e3	the kind of		
End_of_Range	Float	1			2e3	measurement		
						do not change		

AI Function Block Parameters

Defaults & Writable Ranges

Parameter Name	Data Type	Size	Store	Access	Default Value	Writable Range	Slot	Index
BLOCK_OBJECT	DS-32	20	C	r			1-6,	16
Reserved	Unsigned8	1					16,	
Block_Object	Unsigned8	1					17	
Parent_Class	Unsigned8	1						
Class	Unsigned8	1						
DD_Reference	Unsigned32	4						
DD_Revision	Unsigned16	2						
Profile	OctetString	2						
Profile_Revision	Unsigned16	2						
Execution Time	Unsigned8	1						
Number_of_Param	Unsigned16	2						
Address_of_View_1	Unsigned16	2						
Number_of_Views	Unsigned8	1						
ST_REV	Unsigned16	2	N	r	0		1-6 16,17	17
TAG_DESC	OctedString	32	S	r, w	" "	no restrictions	1-6 16,17	18
STRATEGY	Unsigned16	2	S	r, w	0	no restrictions	1-6 16,17	19
ALERT_KEY	Unsigned8	1	S	r, w	0	no restrictions	1-6 16,17	20
TARGET_MODE	Unsigned8	1	S	r, w	0x08	0x80: Out of Service 0x10: Manual 0x08: Automatic	1-6 16,17	21
MODE_BLK	DS-37	3	D	r			1-6 16,17	22
Actual	Unsigned8	1			0x08			
Permitted	Unsigned8	1			0x98			
Normal	Unsigned8	1			0x08			
ALARM_SUM	DS-42	8	D	r			1-6 16,17	23
Current	OctedString	2			0			
Unacknowledged	OctedString	2			0			
Unreported	OctedString	2			0			
Disabled	OctedString	2			0			
BATCH	DS-42	10	S	r, w		no restrictions	1-6	24
BATCH-ID	Unsigned32	4			0		16,17	
RUP	Unsigned16	2			0			
OPERATION	Unsigned16	2			0			
PHASE	Unsigned16	2			0			

AI Function Block Parameters

Defaults & Writable Ranges. Continued.

Parameter Name	Data Type	Size	Store	Access	Default Value	Writable Range	Slot	Index
OUT VALUE STATUS	101 Unsigned8 Unsigned8	5 4 1	D	r/ (w)	0.0 0x4C	writable if MODE_BLK. Actual=Man no restrictions any of class Non Cascade	1-6 16, 17	26
PV_SCALE	Float array	8	S	r, w	2e3, -2e3	no restrictions	1-6 16,17	27
OUT_SCALE EU at 100% EU at 0% Units Index Decimal Point	DS-36 Float Float Unsigned16 Integer8	11 4 4 2 1	S	r, w	2e3 -2e3 1243 1	no restrictions no restrictions do not change no restrictions	1-6 16,17	28
LIN_TYPE	Unsigned8	1	S	r, w	0	0: no linearization	1-6 16,17	29
CHANNEL	Unsigned16	2	S	r, w	TBn	do not change	1-6 16,17	30
PV_FTIME	Float	4	S	r, w	0.0	>=0.0	1-6 16,17	32
FSAVE_TYPE	Unsigned8	1	S	r, w	2	0: FSAVE_VALUE/ UNC-substitute 1: last useable val / UNC-last useable 2: wrong val / BAD-* (*as calculated)	1-6 16,17	33
FSAVE_VALUE	Float	4	S	r, w	0.0	no restrictions	1-6 16,17	34
ALARM_HYS	Float	4	S	r, w	100.0	>=0.0	1-6 16,17	35
HI_HI_LIM	Float	4	S	r, w	2e3	no restrictions	1-6 16,17	37
HI_LIM	Float	4	S	r, w	2e3	no restrictions	1-6 16,17	39
LO_LIM	Float	4	S	r, w	-2e3	no restrictions	1-6 16,17	41
LO_LO_LIM	Float	4	S	r, w	-2e3	no restrictions	1-6 16,17	43
HI_HI_ALM Unacknowledged Alarm State Time Stamp Subcode Value	DS-39 Unsigned8 Unsigned8 Time Val Unsigned16 Float	16 1 1 8 2 4	D	r	0 0 0 0 0.0		1-6 16,17	46

AI Function Block Parameters

Defaults & Writable Ranges. Continued.

Parameter Name	Data Type	Size	Store	Access	Default Value	Writable Range	Slot	Index
HI_ALM	DS-39	16	D	r			1-6	47
Unacknowledged	Unsigned8	1			0		16,17	
Alarm State	Unsigned8	1			0			
Time Stamp	Time Val	8			0			
Subcode	Unsigned16	2			0			
Value	Float	4			0.0			
LO_ALM	DS-39	16	D	r			1-6	48
Unacknowledged	Unsigned8	1			0		16,17	
Alarm State	Unsigned8	1			0			
Time Stamp	Time Val	8			0			
Subcode	Unsigned16	2			0			
Value	Float	4			0.0			
LO_LO_ALM	DS-39	16	D	r			1-6	49
Unacknowledged	Unsigned8	1			0		16,17	
Alarm State	Unsigned8	1			0			
Time Stamp	Time Val	8			0			
Subcode	Unsigned16	2			0			
Value	Float	4			0.0			
SIMULATE	DS-50	6	S	r, w			1-6	50
Simulate_Status	Unsigned8	1			0x60	any of class Non cascade	16,17	
Simulate_Value	Float	4			0.0	no restrictions		
Simulate_Enabled	Unsigned8	1			0	no restrictions		
OUT_UNIT_TEXT	OctedString	16	S	r, w	" "	no restrictions	1-6	51
							16,17	
SENSOR_ID	OctedString	20	D	r	0		1-6	61
							16,17	
CAL_PRD_MODE	Unsigned8	1	S	r, w	0	no restrictions	1, 5	62
CAL_PRD_SAMPLE	Unsigned8	1	D	r, w	0	0 .. 1	1, 5	63
CAL_PRD_STORED_VAL	Float	4	D	r	0.0		1, 5	64
CAL_PRD_TRUE_VAL	Float	4	D	r, w	0.0	no restrictions	1, 5	65
CAL_PRD_STEP	Unsigned8	1	D	r	0		1, 5	66
CAL_CAL_RESULT	Unsigned8	1	D	r	0		1-6	67
							16,17	
CALPROT_STATUS	Unsigned8	1	D	r	0		1, 5	69
CALPROT_DATA	OctedString	200	D	r	0		1, 5	70
CALPROT_CONFIRM	Unsigned8	1	D	r, w	0	0 .. 3	1, 5	71

DI Function Block Parameters

Defaults & Writable Ranges

Parameter Name	Data Type	Size	Store	Access	Default Value	Writable Range	Slot	Index
BLOCK_OBJECT	DS-32	20	C	r			7-8	16
Reserved	Unsigned8	1						
Block_Object	Unsigned8	1						
Parent_Class	Unsigned8	1						
Class	Unsigned8	1						
DD_Reference	Unsigned32	4						
DD_Revision	Unsigned16	2						
Profile	OctetString	2						
Profile_Revision	Unsigned16	2						
Execution Time	Unsigned8	1						
Number_of_Param	Unsigned16	2						
Address_of_View_1	Unsigned16	2						
Number_of_Views	Unsigned8	1						
ST_REV	Unsigned16	2	N	r	0		7-8	17
TAG_DESC	OctedString	32	S	r, w	" "	no restrictions	7-8	18
STRATEGY	Unsigned16	2	S	r, w	0	no restrictions	7-8	19
ALERT_KEY	Unsigned8	1	S	r, w	0	no restrictions	7-8	20
TARGET_MODE	Unsigned8	1	S	r, w	0x08	0x80: Out of Service 0x10: Manual 0x08: Automatic	7-8	21
MODE_BLK	DS-37	3	D	r			7-8	22
Actual	Unsigned8	1			0x08			
Permitted	Unsigned8	1			0x98			
Normal	Unsigned8	1			0x08			
ALARM_SUM	DS-42	8	D	r			7-8	23
Current	OctedString	2			0			
Unacknowledged	OctedString	2			0			
Unreported	OctedString	2			0			
Disabled	OctedString	2			0			
BATCH	DS-42	10	S	r, w		no restrictions	7-8	24
BATCH-ID	Unsigned32	4			0			
RUP	Unsigned16	2			0			
OPERATION	Unsigned16	2			0			
PHASE	Unsigned16	2			0			

DI Function Block Parameters

Defaults & Writable Ranges. Continued.

Parameter Name	Data Type	Size	Store	Access	Default Value	Writable Range	Slot	Index
OUT_D VALUE STATUS	102 Unsigned8 Unsigned8	2 1 1	D	r, w	0 0x4C	writable if MODE_BLK. Actual=Man no restrictions any of class Non Cascade	7-8	26
CHANNEL	Unsigned16	2	S	r, w	0	0	7-8	30
INVERT	Unsigned8	1	S	r, w	0	0: not inverted 1: invert	7-8	31
FSAVE_TYPE	Unsigned8	1	S	r, w	1	0: FSAVE_VAL_D/ UNC-substitute 1: last useable val / UNC-last useable 2: wrong val / BAD-* (* = as calculated)	7-8	36
FSAVE_VAL_D	Unsigned8	1	S	r, w	0	no restrictions	7-8	37
SIMULATE	DS-51	3	S	r, w			7-8	40
Simulate_Status	Unsigned8	1			0x60	any of class Non Cascade		
Simulate_Value	Unsigned8	1			0	no restrictions		
Simulate_Enabled	Unsigned8	1			0	no restrictions		

DO Function Block Parameters

Defaults & Writable Ranges

Parameter Name	Data Type	Size	Store	Access	Default Value	Writable Range	Slot	Index
BLOCK_OBJECT	DS-32	20	C	r			9-11	16
Reserved	Unsigned8	1						
Block_Object	Unsigned8	1						
Parent_Class	Unsigned8	1						
Class	Unsigned8	1						
DD_Reference	Unsigned32	4						
DD_Revision	Unsigned16	2						
Profile	OctetString	2						
Profile_Revision	Unsigned16	2						
Execution Time	Unsigned8	1						
Number_of_Param	Unsigned16	2						
Address_of_View_1	Unsigned16	2						
Number_of_Views	Unsigned8	1						
ST_REV	Unsigned16	2	N	r	0		9-11	17
TAG_DESC	OctedString	32	S	r, w	" "	no restrictions	9-11	18
STRATEGY	Unsigned16	2	S	r, w	0	no restrictions	9-11	19
ALERT_KEY	Unsigned8	1	S	r, w	0	no restrictions	9-11	20
TARGET_MODE	Unsigned8	1	S	r, w	0x08	0x80: Out of Service 0x10: Manual 0x08: Automatic	9-11	21
MODE_BLK	DS-37	3	D	r			9-11	22
Actual	Unsigned8	1			0x08			
Permitted	Unsigned8	1			0x98			
Normal	Unsigned8	1			0x08			
ALARM_SUM	DS-42	8	D	r			9-11	23
Current	OctedString	2			0			
Unacknowledged	OctedString	2			0			
Unreported	OctedString	2			0			
Disabled	OctedString	2			0			
BATCH	DS-42	10	S	r, w		no restrictions	9-11	24
BATCH-ID	Unsigned32	4			0			
RUP	Unsigned16	2			0			
OPERATION	Unsigned16	2			0			
PHASE	Unsigned16	2			0			

DO Function Block Parameters

Defaults & Writable Ranges. Continued.

Parameter Name	Data Type	Size	Store	Access	Default Value	Writable Range	Slot	Index
SP_D	102	2	D	r, w			9-11	25
VALUE	Unsigned8	1			0	no restrictions		
STATUS	Unsigned8	1			0x18	any of class Non Cascade		
OUT_D	102	2	D	r, w		writable if MODE_BLK. Actual=Man	9-11	26
VALUE	Unsigned8	1			0	no restrictions		
STATUS	Unsigned8	1			0x1C	any of class Non Cascade		
READBACK_D	102	2	D	r		writable if MODE_BLK. Actual=Man	9-11	28
VALUE	Unsigned8	1			0	no restrictions		
STATUS	Unsigned8	1			0x4C	any of class Non Cascade		
CHANNEL	Unsigned16	2	S	r, w	0	do not change	9-11	33
INVERT	Unsigned8	1	S	r, w	0	0: not inverted 1: invert	9-11	34
FSAVE_TIME	Float	4	S	r, w	0.0	0.0 ... 6000.0	9-11	35
FSAVE_TYPE	Unsigned8	1	S	r, w	2	0: FSAVE_VAL_D/ UNC-substitute 1: last useable val / UNC-last useable	9-11	36
FSAVE_VAL_D	Unsigned8	1	S	r, w	0	no restrictions	9-11	37
SIMULATE	DS-51	3	S	r, w			9-11	40
Simulate_Status	Unsigned8	1			0x60	any of class Non Cascade		
Simulate_Value	Unsigned8	1			0	no restrictions		
Simulate_Enabled	Unsigned8	1			0	no restrictions		
CHECK_BACK	OctedString	3	D	r	0, 0, 0		9-11	49
CHECK_BACK_MASK	OctedString	3	C	r	5, 0, 0		9-11	50

AO Function Block Parameters

Defaults & Writable Ranges. Continued.

Parameter Name	Data Type	Size	Store	Access	Parameter Usage / Kind of Transport	Default value	Mandatory Optional (Class A,B)
SP VALUE STATUS	101 Unsigned8 Unsigned8	5 4 1	D	r/ (w)	I / cyc	-	M
PV_SCALE EU at 100% EU at 0% Units Index Decimal Point	DS-36 Float Float Unsigned16 Integer8	11 4 4 2 1	S	r, w	C / a	2000, -2000, mV	M
READBACK VALUE STATUS	101 Unsigned8 Unsigned8	5 4 1	D	r/ (w)	O / cyc	-	M
IN_CHANNEL	Unsigned16	2	S	r, w	C / a	-	M
OUT_CHANNEL	Unsigned16	2	S	r, w	C / a	-	M
FSAFE_TIME	Float	4	S	r, w	C / a	0	M
FSAFE_TYPE	Unsigned8	1	S	r, w	C / a	2	M
FSAFE_VALUE	Float	4	S	r, w	C / a	0	M
POS_D VALUE STATUS	102 Unsigned8 Unsigned8	2 1 1	D	r, w	O / cyc	-	M
CHECK_BACK	OctedString	3	D	r	O / cyc	-	M
CHECK_BACK_MASK	OctedString	5	Cst	r	C / a	-	M
SIMULATE Simulate_Status Simulate_Value Simulate_Enabled	DS-50 Unsigned8 Float Unsigned8	6 1 4 1	S	r, w	C / a	disabled	M
INCREASE_CLOSE	Unsigned8	1	S	r, w	C / a	0	M
OUT VALUE STATUS	101 Unsigned8 Unsigned8	5 4 1	D	r/ (w)	C / a	-	M
OUT_SCALE EU at 100% EU at 0% Units Index Decimal Point	DS-36 Float Float Unsigned16 Integer8	11 4 4 2 1	S	r, w	C / a	-	M

Calibration Record Parameters

Specification

The calibration records are stored in the AI Function Block 1 (channel 1) or AI Function Block 5 (channel 2) of the PA 700(X) module as soon as a calibration / adjustment is terminated.

Parameter	Description
CALPROT_STATUS	Shows how many calibration records of the measured module configured for this channel are available and can be read out from the CALPROT_DATA parameter. Coding: 0...3 = number of retrievable records
CALPROT_DATA	Calibration record of the measured module configured for this channel. 3...120 bytes can be requested for reading. If you request more data than the record actually contains, the telegram is filled with zeroes up to the requested data amount. If the record contains more data than requested for reading, the remaining data must be retrieved by further read accesses to CALPROT_DATA (see CALPROT_CONFIRM). Byte 2 of each read record section shows whether the record has been transmitted completely (=0) or whether further read accesses are required (=1). Byte 1 of each read record section contains a section counter to prove the completeness of a record that was read in repeated accesses. The n bytes sent by the device are thus encoded as follows: Byte 1: BLOCK_NBR: Section counter, starting with 0 Byte 2: MORE_DATA: 0 = Record transmitted completely 1 = Further data available Byte 3 – n: Parameter blocks (the actual calibration record)
CALPROT_CONFIRM	Confirmation after readout of record. After readout of the calibration record, the host must write this parameter to the M 700. After execution of the command, the M 700 automatically resets the parameter to 0. Coding: 0 = No action (default) 1 = CONFIRM: Read confirmation of a record. The M 700 deletes this record and places the next record in CALPROT_DATA for readout. CALPROT_STATUS is reduced by one. When there is no further record in the buffer, the CALPROT_STATUS is set to 0. Further records can only be retrieved after CONFIRM has been sent. 2 = REWIND: Repeat. The record can be retrieved once more from the beginning. 3 = NEXT_BLOCK: Read confirmation of a record section. When a record is read in several sections, each read section must be acknowledged with NEXT_BLOCK. Then, M 700 places the next section in CALPROT_DATA for readout. Unless NEXT_BLOCK has been sent, every read access will retrieve the already read section.

Calibration Record Parameters

Parameter Blocks

The record is transmitted as a structured byte string. Each parameter is preceded by a 3-byte block with structure information so that it forms a parameter block.

Length (1 byte):

Number of bytes of this parameter block (= data byte number + 3).

Exception: 0x00 = end identifier.

ID (2 bytes):

Specifies the type of parameter. This identifier implies how the data bytes are to be interpreted (float, integer, ASCII, ...).

Data (n bytes): Data bytes = parameter content.

Typical calibration record with 2 entries and an end identifier:

Length	ID		Data 1	...	Data n	Length	ID		Data 1	...	Data n	Length
n+3						n+3						0

Please note that calibration records have different lengths. If a calibration process is interrupted, for example, only the sections that have been processed until the moment of interruption are stored as parameter blocks in the record. Therefore, the automatic interpretation of the calibration record must always be performed by using the parameter ID and not by using offsets in the data string.

Calibration Protocol IDs

GMP Calibration. The list shows all presentable entries.

Which entries really appear in the respective record depends on the calibration mode, process variable, module etc.

pH Calibration Record Entries

ID	Record entry	Unit of measure
102	Calibration	
103	User	
104	Cal mode	
105	Sensor designation	
106	Serial number	
110	Impedance glass (25°C)	[Mohm]
111	Impedance ref (25°C)	[kohm]
112	Allowed deviation	[pH]
113	Adjustment limit	[pH]
114	Sample value	[pH]
115	Lab value	[pH]
116	1st buffer value	[pH]
117	Electrode voltage	[mV]
118	Cal temp	[°C]
119	Response time	[s]
120	Setpoint	[pH]
121	Actual value:	[pH]
122	Deviation	[pH]
123	Allowed dev. exceeded	
124	Adj. limit exceeded	
125	2nd buffer value	[pH]
126	Electrode voltage	[mV]
127	Cal temp	[°C]
128	Response time	[s]
129	Setpoint	[pH]
130	Actual value:	[pH]
131	Deviation	[pH]

Calibration Protocol IDs

GMP Calibration. The list shows all presentable entries.

Which entries really appear in the respective record depends on the calibration mode, process variable, module etc.

pH Calibration Record Entries

ID	Record entry	Unit of measure
132	Allowed dev. exceeded	
133	Adj. limit exceeded	
134	3rd buffer value	[pH]
135	Electrode voltage	[mV]
136	Cal temp	[°C]
137	Response time	[s]
138	Setpoint	[pH]
139	Actual value:	[pH]
140	Deviation	[pH]
141	Allowed dev. exceeded	
142	Adj. limit exceeded	
143	Zero point (adj)	[pH]
144	Zero point (cal)	[pH]
145	Deviation	[pH]
146	Dev. > tolerance	
147	Zero > Min/Max	
148	Slope (adj)	[mV/pH]
149	Slope (Cal)	[mV/pH]
150	Deviation	[mV/pH]
151	Dev. > tolerance	
152	Slope > Min/Max	
153	Calibration successful	
154	Adjustment required	
155	Adjustment successful	
156	Zero	[pH]
157	Slope	[mV/pH]
158	First Adjustment	

Calibration Protocol IDs

GMP Calibration. The list shows all presentable entries.
Which entries really appear in the respective record depends on the calibration mode, process variable, module etc.

pH Calibration Record Entries

ID	Record entry	Unit of measure
170	Sample value	[pH]
171	Lab value	[pH]
172	Sample value	[pH]
173	Lab value	[pH]
200	Adjustment	
201	User	
202	Calibration	
203	User	
204	Cal mode	
205	Sensor designation	
206	Serial number	
207	Isothermal potential	[mV]
208	Isothermal point	[pH]
209	ISFET zero	[mV]
210	Impedance glass (25°C)	[Mohm]
211	Impedance ref (25°C)	[kohm]
214	Sample value	[pH]
215	Lab value	[pH]
216	1st buffer value	[pH]
217	Electrode voltage	[mV]
218	Cal temp	[°C]
219	Response time	[s]
225	2nd buffer value	[pH]
226	Electrode voltage	[mV]
227	Cal temp	[°C]
228	Response time	[s]

Calibration Protocol IDs

GMP Calibration. The list shows all presentable entries.
Which entries really appear in the respective record depends on the calibration mode, process variable, module etc.

pH Calibration Record Entries

ID	Record entry	Unit of measure
234	3rd buffer value	[pH]
235	Electrode voltage	[mV]
236	Cal temp	[°C]
237	Response time	[s]
243	Zero	[pH]
244	Old zero	[pH]
245	Deviation	[pH]
246	Dev. > tolerance	
247	Zero > Min/Max	
248	Slope	[mV/pH]
249	Old slope	[mV/pH]
250	Deviation	[mV/pH]
251	Dev. > tolerance	
252	Slope > Min/Max	
253	Adjustment successful	
254	Check buffer	[pH]
255	Electrode voltage	[mV]
256	Cal temp	[°C]
257	Response time	[s]
258	Setpoint	[pH]
259	Adj. limit exceeded	
260	Check successful	
262	Actual value:	[pH]
263	GMP cal successful	
270	Sample value	[pH]
271	Lab value	[pH]
272	Sample value	[pH]

Calibration Protocol IDs

GMP Calibration. The list shows all presentable entries.
Which entries really appear in the respective record depends on the calibration mode, process variable, module etc.

pH Calibration Record Entries

ID	Record entry	Unit of measure
273	Lab value	[pH]
300	Feature for QA	
301	Ref/Pos	
302	Meas.point	
306	Cal Buffer 1	[pH]
307	Accuracy	[pH]
308	Durability	
309	Batch no.	
310	Cal Buffer 2	[pH]
311	Accuracy	[pH]
312	Durability	
313	Batch no.	
314	Cal Buffer 3	[pH]
315	Accuracy	[pH]
316	Durability	
317	Batch no.	
319	Tolerance Zero	[pH]
320	Min	[pH]
321	Max	[pH]
322	Tolerance Slope	[mV/pH]
323	Min	[mV/pH]
324	Max	[mV/pH]
325	Allowed tolerance	[pH]

Calibration Protocol IDs

GMP Calibration. The list shows all presentable entries.

Which entries really appear in the respective record depends on the calibration mode, process variable, module etc.

O₂ Calibration Record Entries

ID	Record entry	Unit of measure
402	Last calibration	
403	User	
404	Cal mode	
405	Sensor designation	
406	Serial number	
410	Impedance	[kohm]
412	Allowed deviation	[Air]
413	Adjustment limit	[Air]
415	Relative humidity	[%]
416	Cal pressure	[mbar]
417	Sensor current	[nA]
418	Cal temp	[°C]
419	Response time	[s]
420	Setpoint	[Air]
421	Actual value:	[Air]
422	Deviation	[Air]
423	Allowed dev. exceeded	
424	Adj. limit exceeded	
430	Sample value	[Air]
431	Lab value	[Air]
432	Sample value	[µg/l]
433	Lab value	[µg/l]
434	Sample value	[Vol%]
435	Lab value	[Vol%]
436	Sample value	[ppm]
437	Lab value	[ppm]

Calibration Protocol IDs

GMP Calibration. The list shows all presentable entries.
Which entries really appear in the respective record depends on the calibration mode, process variable, module etc.

O₂ Calibration Record Entries

ID	Record entry	Unit of measure
444	Zero	[nA]
447	Slope	[nA]
448	Slope (adj)	[nA]
449	Slope (Cal)	[nA]
450	Deviation	[nA]
451	Dev. > tolerance	
452	Slope > Min/Max	
453	Calibration successful	
454	Adjustment required	
458	First Adjustment	
502	Active adjustment	
503	User	
504	Cal mode	
505	Sensor designation	
506	Serial number	
510	Impedance	[kohm]
515	Relative humidity	[%]
516	Cal pressure	[mbar]
517	Sensor current	[nA]
518	Cal temp	[°C]
519	Response time	[s]
530	Sample value	[Air]
531	Lab value	[Air]
532	Sample value	[µg/l]
533	Lab value	[µg/l]
534	Sample value	[Vol%]

Calibration Protocol IDs

GMP Calibration. The list shows all presentable entries.
Which entries really appear in the respective record depends on the calibration mode, process variable, module etc.

O₂ Calibration Record Entries

ID	Record entry	Unit of measure
535	Lab value	[Vol%]
536	Sample value	[ppm]
537	Lab value	[ppm]
544	Zero	[nA]
547	Slope	[nA]
553	Adjustment successful	
563	GMP cal successful	

Calibration Protocol IDs

GMP Calibration. The list shows all presentable entries.
Which entries really appear in the respective record depends on the calibration mode, process variable, module etc.

Conductivity Calibration Record Entries

ID	Record entry	Unit of measure
602	Last calibration	
603	User	
604	Cal mode	
605	Sensor designation	
606	Serial number	
617	Solution table value	[μ S]
618	Cal temp	[$^{\circ}$ C]
619	Response time	[s]
643	Zero	[μ S]
647	Cell constant	
653	Calibration successful	
<hr/>		
702	Last calibration	
703	User	
704	Cal mode	
705	Sensor designation	
706	Serial number	
717	Solution table value	[μ S]
718	Cal temp	[$^{\circ}$ C]
719	Response time	[s]
743	Zero	[μ S]
747	Cell constant	
753	Calibration successful	

Calibration Protocol IDs

GMP Calibration. The list shows all presentable entries.
Which entries really appear in the respective record depends on the calibration mode, process variable, module etc.

Electrodeless Conductivity Calibration Record Entries

ID	Record entry	Unit of measure
802	Last calibration	
803	User	
804	Cal mode	
805	Sensor designation	
806	Serial number	
817	Solution table value	[μS]
818	Cal temp	[$^{\circ}\text{C}$]
819	Response time	[s]
843	Zero	[μS]
847	Cell factor	[/cm]
853	Calibration successful	
<hr/>		
902	Last calibration	
903	User	
904	Cal mode	
905	Sensor designation	
906	Serial number	
917	Solution table value	[μS]
918	Cal temp	[$^{\circ}\text{C}$]
919	Response time	[s]
943	Zero	[μS]
947	Cell factor	[/cm]
953	Calibration successful	

Menu Selection

After switching on, the analyzer performs an internal test routine and automatically detects the number and type of modules installed. Then, the analyzer goes to measuring mode.

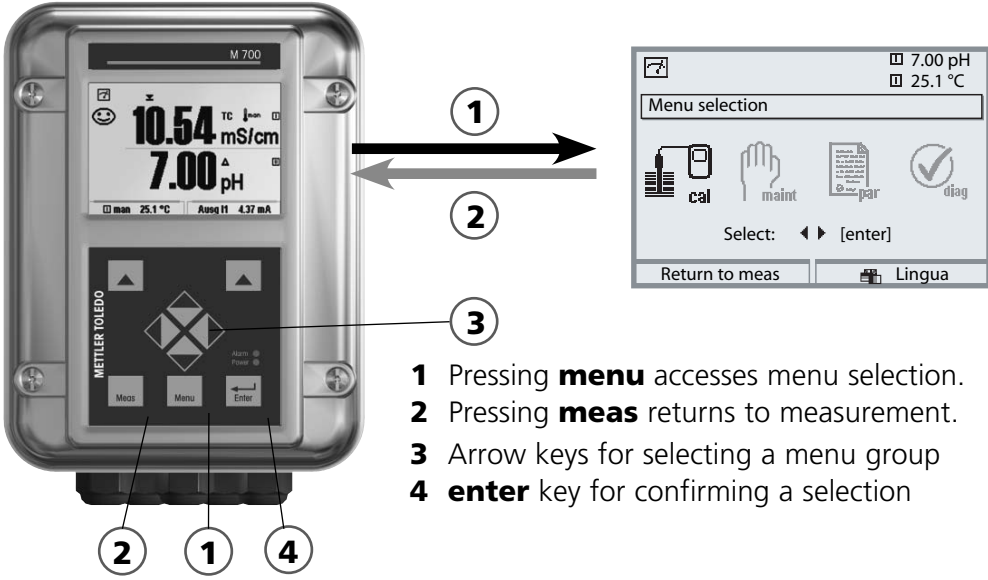

Menu Structure

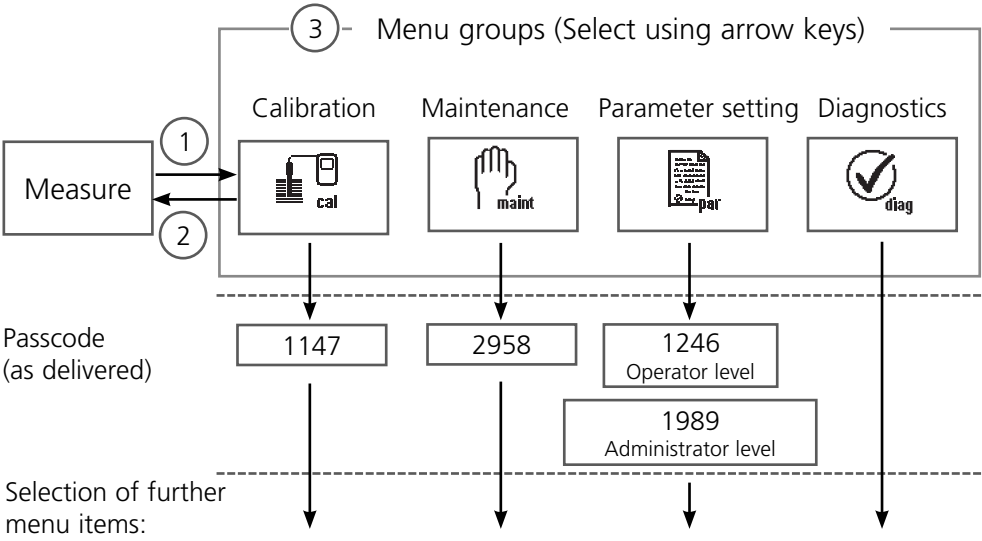

Passcode Entry

To enter a passcode

Select the position using the left/right keys, then edit the number using the up/down keys.

When all numbers have been entered, confirm with **enter**.

To change a passcode

- Open the menu selection (**menu**)
- Select parameter setting
- Administrator level, enter passcode
- Select System control: Passcode entry

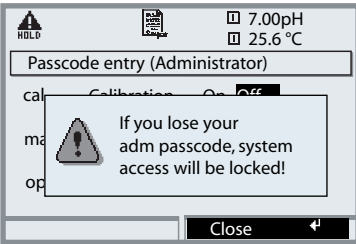
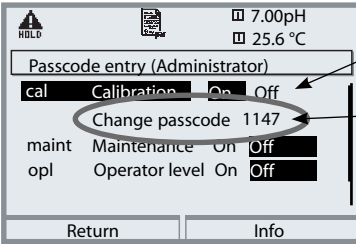
Menu	Display	System control: Passcode entry								
	 	<h3>Changing a passcode</h3> <h4>“Passcode entry” menu</h4> <p>When this menu is opened, the analyzer displays a warning (Fig.). Passcodes (factory settings):</p> <table border="0"> <tr> <td>Calibration</td> <td>1147</td> </tr> <tr> <td>Maintenance</td> <td>2958</td> </tr> <tr> <td>Operator level</td> <td>1246</td> </tr> <tr> <td>Administrator level</td> <td>1989</td> </tr> </table> <p>If you lose the passcode for the Administrator level, system access will be locked! Please consult our technical support!</p> <p>To change a passcode Select “On” using arrow keys, confirm with enter. Select the position using the left/right keys, then edit the number using the up/down keys. When all numbers have been entered, confirm with enter.</p>	Calibration	1147	Maintenance	2958	Operator level	1246	Administrator level	1989
Calibration	1147									
Maintenance	2958									
Operator level	1246									
Administrator level	1989									

Function Control Matrix

Controlling parameter set selection / KI recorder via PROFIBUS DO2
 Parameter setting/Administrator level/System control/Function control matrix

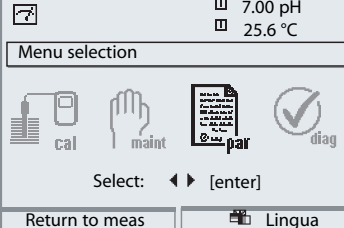
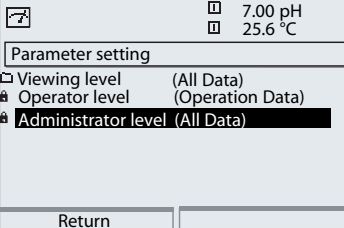
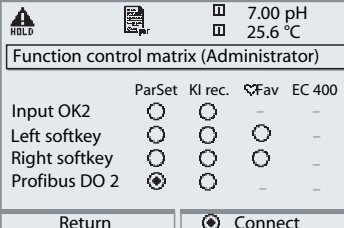
Menu	Display	Control via PROFIBUS DO2
		<p>Call up parameter setting From the measuring mode: Press menu key to select menu. Select parameter setting using arrow keys, confirm with enter.</p>
		<p>Administrator level: Access to all functions, also passcode setting. Releasing or blocking a function for access from the Operator level.</p> <p>At the Administrator level: Select "System control", then "Function control matrix".</p>
		<p>Function control matrix Clear assignment: control element/function. Example: PROFIBUS DO2 controls the parameter set selection. Assignment is made with the arrow keys, "Connect" or "Disconnect" with the right softkey. Confirm with enter.</p>

Pressure Compensation via Bus (AO1)

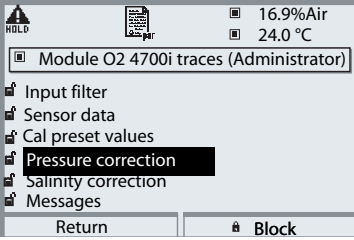
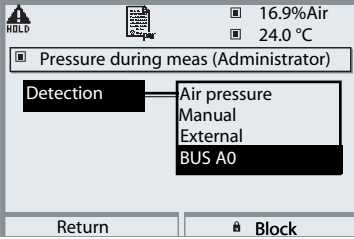
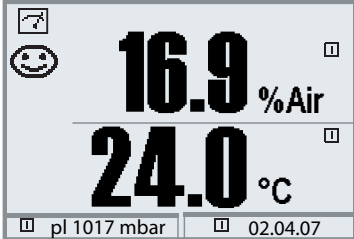
Menu	Display	Parameter setting of O ₂ module
	  	<p>Parameter setting of O₂ module Select "Pressure correction" from the Parameter setting menu of the oxygen module.</p> <p>Pressure during meas Select "BUS A0". The AO1 block provides the analog value for pressure compensation.</p> <p>Display of compensated pressure in measuring mode The compensated "pL" value can be displayed by pressing a softkey.</p>





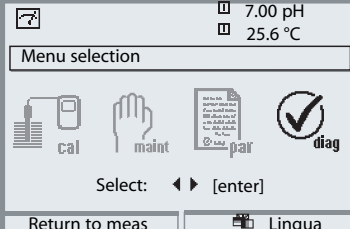
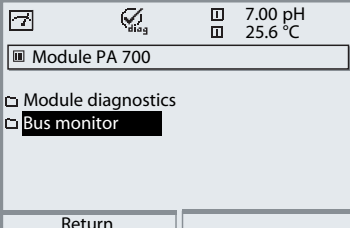
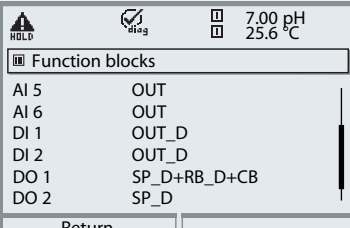







Diagnostics: Bus Monitor

Overview of Parameters Transmitted via Fieldbus
 Diagnostics/Module selection/Bus monitor

Menu	Display	Bus monitor
		<p>Call up diagnostics From the measuring mode: Press menu key to select menu. Select diagnostics using arrow keys, confirm with enter.</p>
		<p>Bus monitor: Overview of Parameters Transmitted via Fieldbus.</p> <p>Parameters</p>
		<p>Function blocks Shows the contents of the Chk_Cfg telegram in interpreted form, i.e. it is shown for each Function Block whether and which data is commu- nicated cyclically. SP_D: Setpoint (Discrete Value) RB_D: Readback (Discrete Value) CB: Check_Back.</p>

Bus Monitor

Overview of Parameters Transmitted via Fieldbus
Diagnostics/Module selection/Bus monitor

Menu	Display	Bus monitor
 diag	<div style="border: 1px solid black; padding: 5px;"> <div style="display: flex; justify-content: space-between; align-items: center;">  HOLD  Diag  7.00 pH  25.6 °C </div> <div style="border: 1px solid black; padding: 2px; margin-top: 5px;"> ▣ Prm_Data </div> <div style="margin-top: 5px;"> <p style="text-align: right;">04.01.07 09:13:00</p> <p>Station_status 10001000</p> <p>WD_Fact 10000 ms</p> <p>Min. Station Del. Resp. 53 tbit</p> <p>Ident_Number 7534 Hex</p> <p>Group_Ident 00</p> <p>User_Prm_Data 00 00 00</p> </div> <div style="display: flex; justify-content: center; margin-top: 5px;"> Return </div> </div>	<p>Prm_Data</p> <p>Shows the 10 data bytes of the Set_Prm telegram in partially interpreted form. Interpretation according to Profibus DP (IEC 61158, Type 6).</p>
	<div style="border: 1px solid black; padding: 5px;"> <div style="display: flex; justify-content: space-between; align-items: center;">  HOLD  Diag  7.00 pH  25.6 °C </div> <div style="border: 1px solid black; padding: 2px; margin-top: 5px;"> ▣ Cfg_Data </div> <div style="margin-top: 5px;"> <p style="text-align: right;">04.01.07 09:13:00</p> <p>Cfg_Data 94 94 94 94 94 94 91 91</p> <p style="padding-left: 20px;">C1 81 84 93 A1 00</p> </div> <div style="display: flex; justify-content: center; margin-top: 5px;"> Return </div> </div>	<p>Cfg_Data</p> <p>Shows the data of the Chk_Cfg telegram in hexadecimal form. This telegram is used by the PLC to specify which data is to be communicated cyclically.</p>
	<div style="border: 1px solid black; padding: 5px;"> <div style="display: flex; justify-content: space-between; align-items: center;">  HOLD  Diag  7.00 pH  25.6 °C </div> <div style="border: 1px solid black; padding: 2px; margin-top: 5px;"> ▣ Diag_Data </div> <div style="margin-top: 5px;"> <p style="text-align: right;">04.01.07 09:13:00</p> <p>Station_status_1 00000000</p> <p>Station_status_2 00001100</p> <p>Station_status_3 00000000</p> <p>Master_Add 0</p> <p>Ident_Number 7534 Hex</p> <p>Ext_Diag_Data 08 FE 00 01 20 20 00 00</p> </div> <div style="display: flex; justify-content: center; margin-top: 5px;"> Return </div> </div>	<p>Diag_Data</p> <p>Shows the 14 data bytes of the Slave_Diag telegram in partially interpreted form. Interpretation according to Profibus DP (IEC 61158, Type 6) and Profile for Process Automation (PA 3.0).</p>

Specifications

Specifications M 700 PA 700(X)

PROFIBUS-PA *) (EEx ia IIC)	Digital communication in hazardous areas via current modulation
Physical interface	MBP-IS ¹⁾ (to EN 61158-2), for use in a FISCO system
Transfer rate	31.25 kbits/s
Communication protocol	PROFIBUS DP-V1
Profile	PROFIBUS PA 3.0
Address range	1 ... 126, factory setting 126, can be set on device
Supply voltage	FISCO ≤ 17.5 V (trapezoidal or rectangular characteristic) ≤ 24 V (linear characteristic)
Current consumption	< 12 mA
Max. current in case of fault (FDE)	< 15 mA

*) galvanic isolation up to 60 V

1) MBP-IS = Manchester Bus Powered – Intrinsic Safety

Specifications

General Data

Explosion protection

(IS module only)

ATEX: See rating plate: KEMA 04 ATEX 2056
II 2 (1) GD EEx ib [ia] IIC T4 T 70 °C

FM: NI, Class I, Div 2, GP A, B, C, D T4
with IS circuits extending into Division 1
Class I, Zone 2, AEx nA, Group IIC, T4
Class I, Zone 1, AEx me ib [ia] IIC, T4

CSA: NI, Class I, Div 2, Group A, B, C, D
with IS circuits extending into Division 1
AIS, Class I, Zone 1, Ex ib [ia] IIC, T4
NI, Class I, Zone 2, Ex nA [ia] IIC

EMC

Emitted interference
Immunity to interference

NAMUR NE 21 and
EN 61326 VDE 0843 Part 20 /01.98
EN 61326/A1 VDE 0843 Part 20/A1 /05.99
Class B
Industry

Lightning protection

EN 61000-4-5, Installation Class 2

Nominal operating conditions

Ambient temperature:
-20 ... +55 °C (Ex: max. +50 °C)
Rel. humidity: 10 ... 95 % not condensing

Transport/Storage temperature

-20 ... +70 °C

Screw clamp connector

Single wires and flexible leads up to 2.5 mm²

Process Variables Available (PROFIBUS)

Process variables which can be assigned to Analog Input Blocks (AI):

Module Types pH: pH 2700
 pH 2700i
 EC 700

Measured value	Unit of measure
pH value	pH
Electrode voltage	mV
Electrode potential (ORP)	mV
rH value	rH
Glass impedance	Ohm
Reference impedance	Ohm
Temperature	°C
Temperature	°F
pH zero point	pH
pH slope	mV/pH
Cal timer (adaptive)	h

Calculation Block pH / pH

Measured value	Unit of measure
Delta pH value	pH
Delta ORP	mV
Delta temperature	°C

Process Variables Available (PROFIBUS)

Process variables which can be assigned to Analog Input Blocks (AI):

Module Types O₂:	O ₂ 4700 O ₂ 4700i	O ₂ 4700 ppb O ₂ 4700i ppb O ₂ 4700i traces
Measured value	Unit of measure	
Saturation (Air)	%	
Saturation (O ₂)	%	
Concentration	mg/l	
Concentration	ppm	
Volume concentration (GAS)	%	
Volume concentration (GAS)	ppm	
Sensor current	nA	
Temperature	°C	
Temperature	°F	
Air pressure	mbar	
DO partial pressure	mbar	
Zero	nA	
Slope	nA/mbar	
Cal timer (adaptive)	h	
Current input	mA	

Calculation Block O₂ / O₂

Measured value	Unit of measure
Delta saturation (Air)	%
Delta saturation (O ₂)	%
Delta temperature	°C
Delta O ₂ concentration	mg/l
Delta O ₂ concentration	ppm
Delta volume conc. (gas)	%
Delta volume conc. (gas)	ppm

Process Variables Available (PROFIBUS)

Process variables which can be assigned to Analog Input Blocks (AI):

Module Types Cond: Cond 7700

Measured value	Unit of measure
Conductivity	$\mu\text{S/cm}$
Resistivity	Ohm/cm
Concentration	%
Concentration	g/kg
Temperature	$^{\circ}\text{C}$
Temperature	$^{\circ}\text{F}$
cell constant	cm^{-1}
USP value	%

Calculation Block Cond / Cond

Measured value	Unit of measure
Delta conductivity	$\mu\text{S/cm}$
Delta resistivity	Ohm/cm
Delta temperature	$^{\circ}\text{C}$
Ratio	
Passage	%
Rejection	%
Deviation	%
pH value	pH

Process Variables Available (PROFIBUS)

Process variables which can be assigned to Analog Input Blocks (AI):

Module Types Cond Ind: Cond Ind 7700

Measured value	Unit of measure
Conductivity	$\mu\text{S/cm}$
Resistivity	Ohm/cm
Concentration	%
Concentration	g/kg
Temperature	$^{\circ}\text{C}$
Temperature	$^{\circ}\text{F}$
Zero	S/cm
Cell factor	cm^{-1}

Calculation Block Cond Ind / Cond Ind

Measured value	Unit of measure
Delta conductivity	$\mu\text{S/cm}$
Delta resistivity	Ohm/cm
Delta temperature	$^{\circ}\text{C}$
Ratio	
Passage	%
Rejection	%
Deviation	%

Index

A	
AI Function Block, parameters	41
Analog Input Blocks.....	21
AO Function Block, parameters.....	48
Application in hazardous locations.....	7
Assigning process variables to Analog Input Blocks.....	23, 24
B	
BASE module.....	13
Bus monitor.....	66
C	
Cable glands.....	10
Calibration protocols.....	49
CALPROT_STATUS.....	49
CD-ROM (included in shipment)	25
Change passcode	62
Communication Model	19, 20
Configuration Data.....	32
Configuration with PROFIBUS	25
CONTACTS	27
Control via PROFIBUS DO2.....	63, 64, 65, 66
Cyclic data communication	26
Cyclic input data telegram	26
Cyclic services	15
D	
Device database file (GSD file)	25
Device Driver	25
Device profile PA 3.0.....	15
Device software	8
DI Function Block, parameters	44
DI Function Blocks	27
Disposal.....	2

Index

DO Function Block, parameters.....	46
DO Function Blocks.....	30
E	
EC 400 control	31
EC 400 maintenance request.....	28
EC 400 messages.....	29
EC 400 status	27
Electrical connection between module and PROFIBUS PA.....	18
EMC	68
ENABLE request	27
F	
FDA 21	6
FISCO model.....	15
For copy: Assigning process variables to Analog Input Blocks on the device	24
FRONT module	12
Function control matrix.....	63, 65
G	
Graphic display	10
H	
Hardware and software version	8
HOLD control.....	30
I	
Inserting the module.....	17
Intended use.....	6
L	
LED.....	10
LOCK control	31
LOCK status.....	27

Index

M	
Masters.....	15
Menu selection	61
Menu structure.....	11, 61
METT7533.gsd.....	25
Modular concept	9
Module equipment.....	13
Modules	12
Module software	8
P	
PA.....	18
PARSET	30
PA Slot Model.....	36
Passcode entry.....	62
Passcode lost	62
PB Block Parameters	37
Physical Block (PB).....	20
Pressure compensation via bus (AO1)	64
PROFIBUS, available process variables.....	70
PROFIBUS-DP	14
PROFIBUS-FMS.....	14
PROFIBUS-PA	14
PROFIBUS-PA, definitions	15
PROFIBUS PA installation.....	18
PROFIBUS technology	14
Projecting procedure.....	32
Q	
Query actual device/module software	8
R	
Replacing the front module	12
Return of products.....	2

Index

S

Safety information	7
Screw clamp connector.....	68
Sealing.....	12
Secondary displays.....	10
Select AI configuration.....	23, 24
Sensor data	64
Serial number	8
Short description	10
Slaves	15
Slot for SmartMedia card.....	12
SmartMedia card	12
Softkeys.....	10
Softwareversion	8
Specifications.....	67, 68

T

Table of contents	4
TB Analyzer Block Parameters	39
Terminal compartment.....	13
Terminal plate	12, 16
Trademarks	2

W

Warranty	2
----------------	---

BR **Mettler-Toledo Ind. e Com. Ltda.,**
Alameda Araguaia, 451 - Alphaville
BR - 06455-000 Barueri / SP, Brazil
Phone +55 11 4166 74 00
Fax +55 11 4166 74 01

CH **Mettler-Toledo (Schweiz) AG,**
Im Langacher,
CH - 8606 Greifensee, Switzerland
Phone +41 44 944 45 45
Fax +41 44 944 45 10

D **Mettler-Toledo GmbH,** Prozeßanalytik,
Ockerweg 3,
D - 35396 Gießen, Germany
Phone +49 641 507-333
Fax +49 641 507-397

F **Mettler-Toledo Analyse Industrielle Sàrl,**
30 Bld. de Douaumont, BP 949,
F - 75829 Paris Cedex 17, France
Phone +33 1 47 37 06 00
Fax +33 1 47 37 46 26

USA **Mettler-Toledo Ingold, Inc.,**
36 Middlesex Turnpike,
USA - Bedford, MA 01730, USA
Phone +1 781 301-88 00
Fax +1 781 271-06 81



Management-System
zertifiziert nach
ISO 9001 / ISO 14001



www.mtpro.com