

**METTLER TOLEDO**

## **Operating instructions**

### **METTLER TOLEDO BD balances**

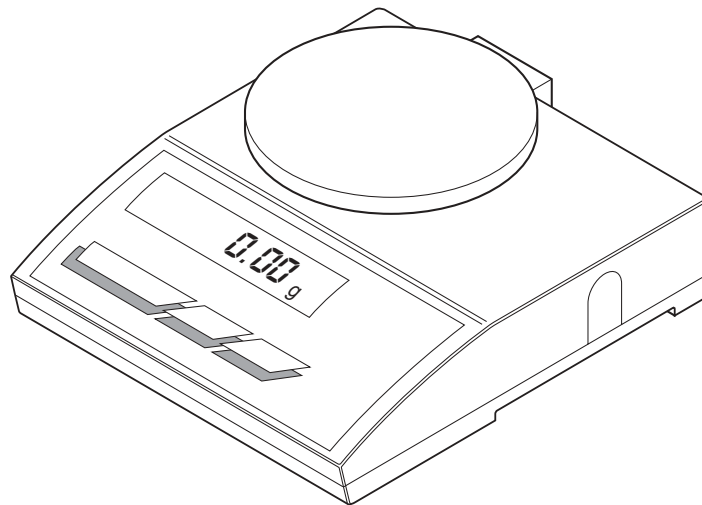

# Startup procedure

1

---

## Unpacking, standard equipment

---

The standard equipment contains:

- BD balance,
- Weighing pan, permanently mounted with BD6000,
- AC adapter,
- Operating instructions.

---

## Mounting the weighing pan

---

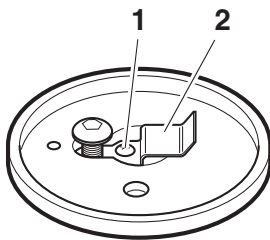

### With BD6000

Remove packaging material underneath the weighing pan.  
Weighing pan is already mounted.

### With BD202, remove transport arrestment

Unscrew arrestment screw (1).  
Pull out transport arrestment (2).

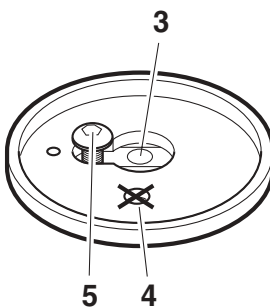

### Models with circular weighing pan

Insert the weighing pan with the stem in the middle of the pan support (3).

### Caution

Do not alter position of stop screw (5).

### Notes

- Keep packaging for transport or storage in a safe place.
- For transport, move weighing pan to position (4).

---

## Location

---

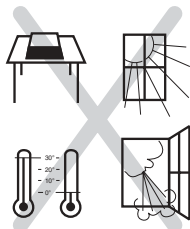

The best results are obtained when the balance is correctly sited.

- Firm, horizontal support as free from vibrations as possible.
  - Avoid direct sunlight.
  - No excessive temperature fluctuations.
  - No drafts.
-

# Startup procedure

2

---

## Attaching the AC adapter

---

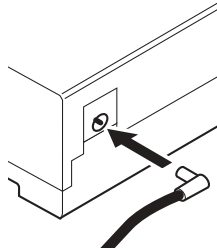

Plug AC adapter into rear of the balance.

Connect AC adapter to power supply.

---

## Installing the batteries

---

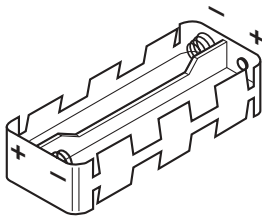

1. Lift off circular weighing pan, rectangular pan is permanently fixed.
2. Turn balance over.
3. Slide off cover in the direction of the arrow.
4. Take out battery holder.
5. Insert 8 AA batteries so that the plus (+) and minus (-) terminals coincide with the specifications on the holder.
6. Insert battery holder and check plug-in connection.
7. Replace cover.

### Notes

- When the AC adapter is attached, the batteries are bypassed.
  - The balance can also be operated with a storage battery (see Accessories, Accu Pac, page 14).
  - To prolong battery life, activate "automatic shut-down" in the menu, see page 11.
-

# Operation

## Instrument overview

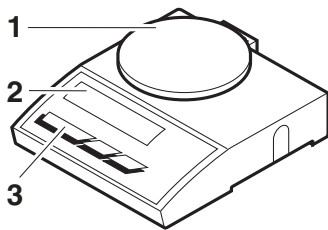

- (1) Circular or rectangular weighing pan
- (2) Display panel
- (3) Keypad

Green function = Press briefly  
Blue function = Press and hold

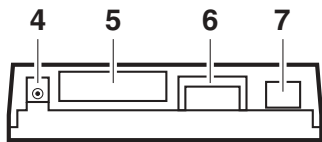

- (4) AC adapter socket
- (5) Model plate
- (6) Antitheft device
- (7) Cover of RS-232 socket

## Operation

### 2 operator control levels

- **Weighing mode** (page 4 onwards) and
- **Menu** (page 9 onwards)

BD balances have two operator control levels, the **weighing mode** and the **menu**. General operation is in the weighing mode.

In addition to the basic functions weighing and taring, other functions are available such as unit switching, counting or percent weighing. Selection of the functions and setting the balance parameters takes place in the menu (page 9 onwards).



### (1) Control key



- On (press briefly)
- 0/T← (press briefly)
- Off (press and hold)

- Switch on
- Zero setting/taring, return to weighing mode
- Switch off



### (2) Function key

- ↻ (press briefly)
- F (press and hold)

- Switching between unit 1/unit 2/% or piece number  
In the menu: Change the settings
- Enter reference weight or reference quantity

		(3) Menu key
	(press briefly)	Transmit data to a printer. An RS-232 interface must be fitted for this (see Accessories, page 14). In the menu: Select menu options.
	(press and hold)	Calibrate, entry into menu, store settings.

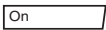
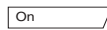
## On/off switching

	<div style="border: 1px solid black; padding: 2px; display: inline-block;">1.8.8.8.8.8 g</div> <div style="border: 1px solid black; padding: 2px; display: inline-block;">bd 1201</div> <div style="border: 1px solid black; padding: 2px; display: inline-block;">0.0 g</div>	<p>When balance is unloaded, press  .</p> <ol style="list-style-type: none"> <li>1. All segments of the display panel light up.</li> <li>2. The balance model is displayed.</li> <li>3. "0.0" is displayed. The balance is in the weighing mode.</li> </ol>
		<p>Switching off the balance: Press and hold  until "Off" is displayed.</p>

## Weighing

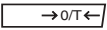
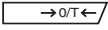
	<div style="border: 1px solid black; padding: 2px; display: inline-block;">0.1 g</div> <div style="border: 1px solid black; padding: 2px; display: inline-block;">0.0 g</div> <div style="border: 1px solid black; padding: 2px; display: inline-block;">o 105.1 g</div>	<ol style="list-style-type: none"> <li>1. Set display to zero: Press  .</li> <li>2. Load weighing sample.</li> <li>3. Read display when stability detector (o) disappears.</li> </ol>
---	--	--

## Taring

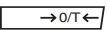
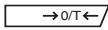
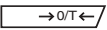
	<div style="border: 1px solid black; padding: 2px; display: inline-block;">100.0 g</div> <div style="border: 1px solid black; padding: 2px; display: inline-block;">0.0 g</div> <div style="border: 1px solid black; padding: 2px; display: inline-block;">o 105.1 g</div> <div style="border: 1px solid black; padding: 2px; display: inline-block;">- 100.0 g</div>	<ol style="list-style-type: none"> <li>1. Set display to zero.</li> <li>2. Load empty container on balance. The weight is displayed.</li> <li>3. Taring: Press  .</li> <li>4. Add weighing sample to container. The net weight of the contents is displayed.</li> <li>5. Remove container from balance. The weight of the container (tare) is displayed as a negative value. The tare weight remains stored until the  is pressed again or the balance is switched off.</li> </ol>
---	--	--

## Calibration

1. Before calibrating, the balance must be switched on for at least 5 minutes.
2. Have required weight (see Accessories, page 14) on hand.
 

BD202	200 g
BD601	500 g
BD1201	1000 g
BD6000	4000 g
3. Unload weighing pan completely.
4. Press and hold **CAL/Menu** until "CAL" appears. Release key.
5. After attainment of stability, the value of the required calibration weight flashes.
6. Place calibration weight on the balance. The balance calibrates itself.
7. When zero flashes, remove weight.

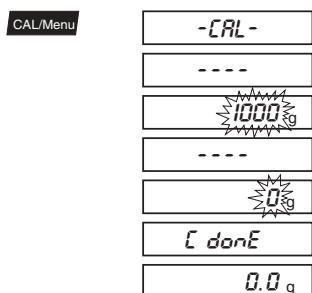

The operation is complete when "C donE" is displayed. The balance returns to the weighing mode.

### Disabling the calibration

Switch (1) to "On" position: Calibration disabled.  
 Switch (1) to "Off" position: Calibration enabled.

### Changing the switch position

1. Remove circular weighing pan, rectangular pan is permanently mounted.
2. Turn balance over.
3. Unscrew screws of baseplate and remove baseplate.
4. Move switch to desired position.
5. Replace baseplate.

### Note

When the balance is open, do not touch the leads of the sensor.

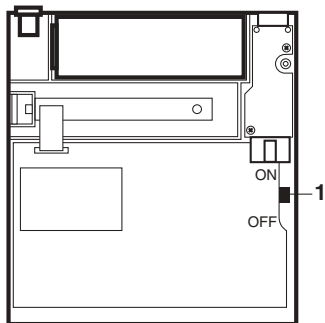

---

## Switching weight unit

---

### Requirement

Different weight units for unit 1 and unit 2 must be selected in the menu.

### Switching

Switching between unit 1 and unit 2:

Press .

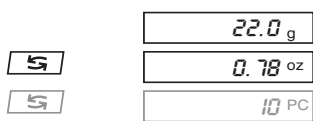

If a function has been selected in the menu, switching can be effected between unit 1, unit 2 and % or piece number.

---

## Printing

---

If an RS-232 interface is installed, weighing results can be transmitted to a printer and printed out.

Parameters of the data transmission are defined in the menu (see interface description).

Start printout: Press .







---

## Counting

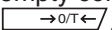
### Requirement

"F count" must be selected in the menu.

### Setting reference

1. Set display to zero.
2. Place empty container on the balance:  
Press .
3. Press and hold  until "SEt ..." is displayed. 10 is the preset reference quantity.
  - Pressing  allows a reference quantity of 10, 20, 30, 50, 100 or 5 to be selected. The selected value remains stored even if the balance is switched off.
4. Load reference quantity and confirm with . The current piece number and PC (pieces) will be displayed. If the reference weight is too small, "Add" and the current piece number are displayed.
  - To assure counting accuracy, increase reference quantity. Confirm with .
  - Ignore "Add" prompt: Confirm with .

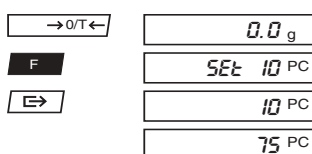

### Counting

Add weighing sample to the container and read off piece number. The current reference weight remains stored until the balance is switched off or the entry is changed.

Switching between piece number/weight units:  
Press .

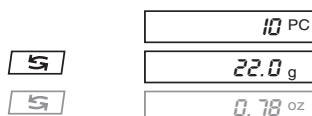

### Note

If no entry has been made for 30 seconds, the timeout function switches to normal weighing operation.



## Plus/minus and percent weighing

### Requirement

"F 100 %" must be selected in the menu.



### Setting target weight

1. Set display to zero.
2. Press and hold **F** until "SEt 100 %" appears in the display.
3. Load target weight.
4. Confirm with  $\Rightarrow$ . The target weight is now defined.

The current target weight remains stored until the balance is switched off or the entry is changed.

### Note

If no entry has been made for 30 seconds, the timeout function switches to normal weighing operation.

### Percent weighing

1. Set target weight, see above.
2. Load weighing sample.

The weight of the sample is displayed in percentage of the target weight.

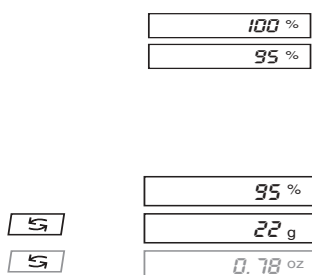

Switching between percent weighing/weight units:  
Press  $\mathcal{S}$ .

### Plus/minus weighing

1. Set target weight, see above.
2. Tare: Press  $\rightarrow 0/T \leftarrow$ .
3. Load weighing sample.

The percentage by which the weighing sample differs from the target weight is displayed.

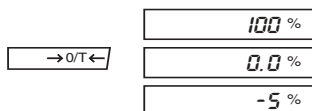

Switching between plus/minus weighing/weight units:  
Press  $\mathcal{S}$ .

## Menu overview

You can use the **menu** to configure the balance for your special requirements.

The selection line with halftone backing represents the current settings of the balance. You can access it with the  $\boxed{\text{E} \rightarrow}$  key.

The choices shown in halftone appear only when the RS-232 interface is built in (see Accessories, page 14).

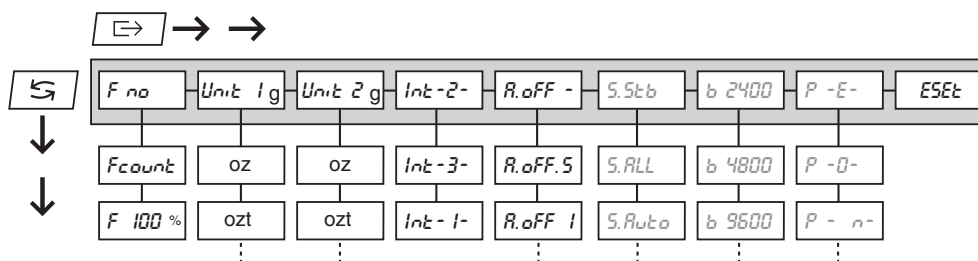

The possible settings are listed in the description of the menu options.

## Menu operation

<b>Entry into the menu</b>	Press and hold $\boxed{\text{CAL/Menu}}$ until "MENU" is displayed.
<b>Selecting menu options</b>	Select next menu option with $\boxed{\text{E} \rightarrow}$ .
<b>Changing the settings</b>	Change the settings of a menu option using $\boxed{\text{S}}$ .
<b>Storing changed settings</b>	Press and hold $\boxed{\text{CAL/Menu}}$ key until "StorEd" is displayed.
<b>Return to the weighing mode without storing changes.</b>	Quit the menu with $\boxed{\rightarrow 0/T \leftarrow}$ . The balance operates with the settings currently stored.

**Note**

If no entry has been made in the menu for 30 seconds, the timeout function switches to normal weighing operation. The balance operates with the current stored settings.

## Menu factory settings

F no	F no	no function
Unit 1 g	Unit 1 g	Unit 1 in g
Unit 2 g	Unit 2 g	Unit 2 in g (inactive)
Int-2-	Int-2-	median integration time
R.off -	A.off -	automatic shutdown inactive
S.Stb	S.Stb	Transmission mode: stable single value
b 2400	b 2400	Baud rate: 2400
P -E-	P -E-	Parity: even

## Menu description

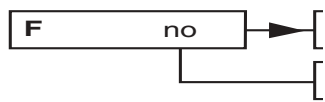
	Function	
	no	no function
	count	counting
	100 %	Plus/minus and percent weighing

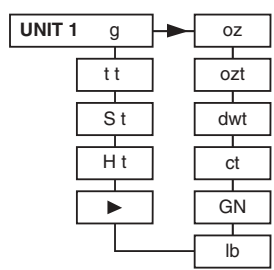
	Unit 1	
	g	Gram
	oz	Ounce
	oz t	Troy ounce
	dwt	Pennyweight
	ct	Carat
	GN	Grain
	lb	Pound
	►	Momme
	H t	Hong Kong tael*
	S t	Singapore tael*
	t t	Taiwan tael*

\* During operation, only t is displayed.

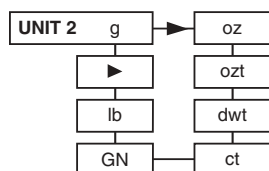

## Unit 2

All units listed under unit 1 except taels can also be selected for unit 2.

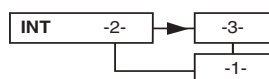

## Integration time

The integration time influences the speed of the balance and the reproducibility of the values.

- 2- Median integration time
- 3- Maximum integration time
- 1- Minimum integration time

Setting	Weighing speed	Reproducibility
1	fast	good
2	↑	↓
3	slow	very good

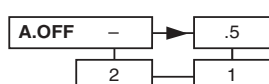

## Automatic shutdown

The automatic shutdown switches off the balance when no change in the display has occurred within the specified time.

- Inactive
- .5 0.5 minutes
- 1 1 minute
- 2 2 minutes



## Reset

Reset resets the menu to the factory settings.

To reset settings:

Press and hold the **CAL/Menu** until "r donE" is displayed. The balance returns to the weighing mode.



Overload

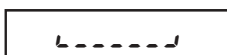

Underload

**Note**

If an overload or underload error appears when the balance is switched on, recalibrate balance.



No stability

- in taring
- in calibration
- when reference weight is loaded for counting or percent weighing



No or wrong calibration weight loaded

→ Load requested calibration weight



Reference quantity too small

→ Increase piece number

Reference weight too small

→ Increase reference weight



Internal error

→ off/on switching, or

→ calibration

If the error can not be rectified return balance to customer service.

You will find further details on the warranty certificate (bill).

## Technical data

13

	BD202	BD601	BD1201	BD6000
<b>Readability</b>	0.01 g	0.1 g	0.1 g	1 g
<b>Maximum load</b>	200 g	600 g	1200 g	6000 g
<b>Taring range (by subtr.)</b>	0 ... 200 g	0 ... 600 g	0 ... 1200 g	0 ... 6000 g
<b>Reproducibility</b>	0.01 g	0.07 g	0.1 g	0.7 g
<b>Linearity (±)</b>	0.01 g	0.1 g	0.1 g	1 g
<b>Stabilization time (typical)</b>	3.0 s	3.0 s	3.5 s	3.0 s
<b>Balance housing (W x D x H)</b>	185 x 220 x 60 mm			
<b>Weighing pan</b>	ø 102 mm	ø 102 mm	ø 120 mm	120x175 mm
<b>Weight</b>	ca. 800 g			
<b>Power supply</b>	6-12 V DC, 70 mA, with AC adapter, Accu Pac or 8 AA 1.5 V batteries			

## Maintenance

<b>Cleaning</b>	Clean housing and weighing pan with a cloth and, if necessary, a mild cleaning agent. Protect balance and weighing pan against contamination.
<b>Batteries</b>	You can operate BD balances with environmentally friendly batteries. Remove discharged or old batteries from balance and dispose of as hazardous waste.

## Accessories (by ordering)

14

	Order No.
Accu Pac (rechargeable NiCd battery)	590103
Carrying case	590116
Antitheft device	590101
RS-232 interface	590102
RS cable	
male/25-pin	210492
female/25-pin	210491
female/9-pin	210493
Extension cable DATA I/O 5 m	216152
MiniMettler connector, solderable	33930
Calibration weights	
200 g	216522
500 g	216524
1000 g	216526
2 x 2000 g	216532
AC adapter	
100/120 V (US connector)	590108
220/240 V (EURO connector)	590109
240 V (UK connector)	590110
220/240 V (AUSTRALIA connector)	590111
Battery holder (without batteries)	590112
Battery compartment cover	590115
Weighing pans	
102 mm (for BD202)	590118
102 mm (for BD601)	590113
120 mm (for BD1201)	590114
Pouch	590117

**To protect your METTLER TOLEDO product's future:  
METTLER TOLEDO service assures the quality, measuring  
accuracy and preservation of value of all METTLER TOLEDO  
products for years to come.  
Please send for full details about our attractive terms of  
service.  
Thank you.**



\*P709106\*

Subject to technical changes and to the availability  
of the accessories supplied with the instruments.

© Mettler-Toledo GmbH 2000 709106A Printed in Switzerland 0001/2.12

**Mettler-Toledo GmbH**, CH-8606 Greifensee, Switzerland  
Phone +41-1-944 22 11, Fax +41-1-944 30 60, Internet: <http://www.mt.com>