

O₂ 4700i(X) ppb module

Instruction manual

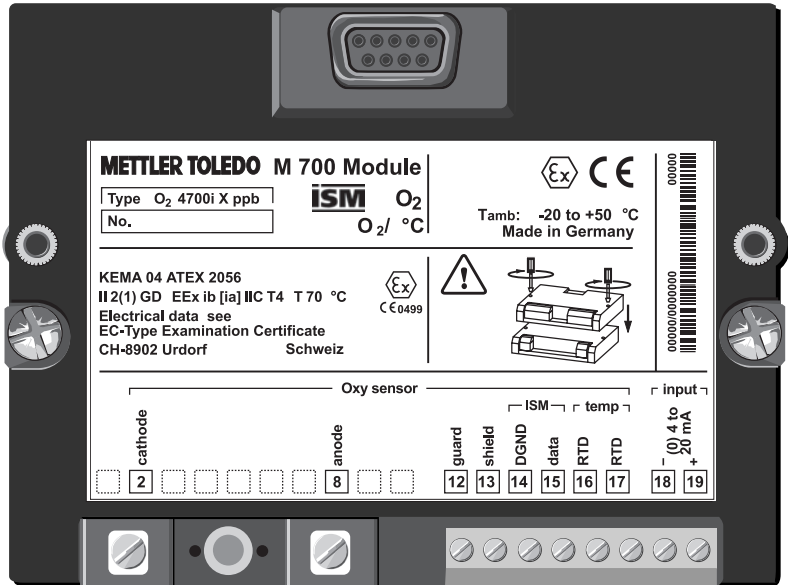

Order number: 52 121 283

METTLER TOLEDO



69912

Warranty

Defects occurring within 1 year from delivery date shall be remedied free of charge at our plant (carriage and insurance paid by sender).

©2005 Subject to change without notice

Return of products under warranty

Please contact your local Mettler-Toledo representative before returning a defective device. Ship the cleaned device to the address you have been given. If the device has been in contact with process fluids, it must be decontaminated/disinfected before shipment. In that case, please attach a corresponding certificate, for the health and safety of our service personnel.

Disposal

Please observe the applicable local or national regulations concerning the disposal of "waste electrical and electronic equipment".

Registered trademarks

The following registered trademarks are used in this instruction manual without further marking

Sensocheck
Sensoface
VariPower

SMARTMEDIA®
is a registered trademark of Toshiba Corp., Japan

InPro®
is a registered trademark of Mettler-Toledo GmbH, Switzerland

Mettler-Toledo GmbH, Process Analytics, Industrie Nord,
CH-8902 Urdorf, Tel. +41 (44) 736 22 11 Fax +41 (44) 736 26 36
Subject to technical changes. Mettler-Toledo GmbH, 10/05.
Printed in Germany.



Declaration of conformity
Konformitätserklärung
Déclaration de conformité



We/ Wir/Nous **Mettler-Toledo GmbH, Process Analytics**

Im Hackacker 15
8902 Urdorf
Switzerland

declare under our sole responsibility that the product,
erklären in alleiniger Verantwortung, dass dieses Produkt,
déclarons sous notre seule responsabilité que le produit,

Description

Beschreibung/Description

02 4700i ppb

to which this declaration relates is in conformity with the following standard(s) or other normative document(s).

auf welches sich diese Erklärung bezieht, mit der/den folgenden Norm(en) oder Richtlinie(n) übereinstimmt.

auquel se réfère cette déclaration est conforme à la (aux) norme(s) ou au(x) document(s) normative(s).

EMC Directive/

EMV-Richtlinie/

Directive concernant la CEM

89/336/EWG

Low-voltage directive/

Niederspannungs-Richtlinie/

Directive basse tension

73/23/EWG

Place and Date of issue/

Ausstellungsort/ - Datum

Lieu et date d'émission

Urdorf, September 15, 2005

Mettler-Toledo GmbH, Process Analytics

Waldemar Rauch
General Manager PO Urdorf

Thomas Hösl
Head of Operations and R&D

Norm/ Standard/ Standard

EN 61326 / VDE 0843 Teil 20
EN 61010-1 / VDE 0411 Teil 1

METTLER TOLEDO

CE_M700_Modul_02_4700i_ppb.doc

Sitz der Gesellschaft | Mettler-Toledo GmbH, Im Langacher, CH-8606 Greifensee



Contents

Warranty	2
Registered trademarks	2
EC Declaration of Conformity	3
Intended use	8
Safety information.....	9
Software version	10
Modular concept and instruction manuals	11
Short description: M 700 FRONT	12
Short description: Menu structure	13
Short description: M 700 BASE.....	15
Parameter tables (Excel) at www.mtpro.com	16
ISM - Intelligent Sensor Management.....	17
ISM - Plug and Measure	18
ISM - First Calibration	19
ISM - Parameter setting	20
ISM - Predictive maintenance.....	21
ISM - Diagnostics.....	22
ISM - Setting diagnostics messages as favorite.....	23
Terminal plate.....	26
Inserting the module	27
Wiring example	29
Quick start:	
Menu selection/structure	30
Passcode entry	31
Configuring the measurement display	32
Calibration / adjustment.....	34
Common combination: process variable / calibration mode	35
Selecting a calibration method	36
Automatic calibration in water	38
Automatic calibration in air	40

Contents

Product calibration: Saturation	42
Product calibration: Concentration	44
Data entry of premeasured sensors	46
Zero point correction	47
Adjustment.....	48
Maintenance	49
Setting the module parameters	
Operating levels.....	50
Enable / lock functions	51
Setting the module parameters	52
Setting the sensor data parameters	53
Sensoface	54
Sensor data, Cal preset values, Pressure/Salt correction.....	55
Messages.....	56
Setting the logbook parameters (System control)	
Logbook	58
Factory setting.....	58
Setting the system control and the outputs (M 700 BASE)	
Setting the current output.....	59
Output filter (time constant)	62
NAMUR signals (current outputs) - Behavior during messages -	63
NAMUR signals (relay contacts):	
failure, maintenance request, function check.....	64
Relay contacts: Protective wiring.....	65
Setting the relay contacts	66
Limit value, hysteresis, contact type	67
Setting the OK1, OK2 inputs (M 700 BASE)	
Optocoupler inputs (M 700 BASE): Usage and switching level	68
Switching parameter sets via OK2 (system control)	69
Calculation Blocks (System control)	
Calculation of new variables from measured variables	70

Contents

Diagnostics functions	73
Message list.....	73
Logbook	73
Device description.....	74
ISM sensor description	74
Module FRONT	74
Module BASE.....	74
Module diagnostics.....	75
Sensor monitor	75
Cal record.....	76
Sensor network diagram.....	76
Sensor wear monitor	76
Statistics	76
Specifications	77
Appendix	80
Minimum measuring spans for current outputs	80
High CO ₂ compensation (SW 700-011)	81
Overview of parameter setting	82
Index	86
Overview of icons	91
Overview of menu selection	92

Intended use

The module is used to measure traces of dissolved oxygen in liquids using Mettler-Toledo sensors of the InPro 6900 series or sensors with ISM technology (Intelligent Sensor Management). The module permits simultaneous measurement of oxygen partial pressure, barometric pressure, and temperature. In addition, oxygen saturation or concentration can be calculated and displayed.

The O₂ 4700iX ppb module is intended for operation in locations subject to explosion hazards which require equipment of Group II, device category 2(1), gas/dust.

Conformity with FDA 21 CFR Part 11

In their directive “Title 21 Code of Federal Regulations, 21 CFR Part 11, Electronic Records; Electronic Signatures” the US American health agency FDA (Food and Drug Administration) regulates the production and processing of electronic documents for pharmaceutical development and production. This results in requirements for measuring devices used for corresponding applications. The following features ensure that the M 700(X) modular process analysis system meets the demands of FDA 21 CFR Part 11:

Electronic Signature

Access to the device functions is regulated and limited by individually adjustable codes – “Passcodes”. This prevents unauthorized modification of device settings or manipulation of the measurement results. Appropriate use of these passcodes makes them suitable as electronic signature.

Audit Trail Log

Every change of device settings can be automatically recorded and documented in the Audit Trail Log on the SmartMedia card. The recording can be encoded.

Safety information

Caution!

Never try to open the module! If a repair should be required, return the module to our factory.

If the specifications in the instruction manual are not sufficient for assessing the safety of operation, please contact the manufacturer to make sure that your intended application is possible and safe.

Be sure to observe during installation:

- Switch off power supply before replacing or inserting a module.
- Protect the signal inputs of the modules against electrostatic discharge.
- Before commissioning it must be proved that the device may be connected with other equipment.
- Observe correct shielding: To avoid interferences, the cable shielding must be completely covered by the ESD shielding cap.

Application in hazardous locations:

O₂ 4700iX ppb module

When using the O₂ 4700iX ppb module, the stipulations for electrical installations in hazardous areas (EN 60079-14) must be observed. When installing the device outside the range of applicability of the 94/9/EC directive, the appropriate standards and regulations in the country of use must be observed.

The module has been developed and manufactured in compliance with the applicable European guidelines and standards.

Compliance with the European Harmonized Standards for use in hazardous locations is confirmed by the EC-Type-Examination Certificate. Compliance with the European guidelines and standards is confirmed by the EC Declaration of Conformity.

There is no particular direct hazard caused by the operation of the device in the specified environment.

Software version



O₂ 4700i(X) ppb module

Device software M 700(X)

The O₂ 4700i ppb module is supported by software version 6.2 or higher.

The O₂ 4700iX ppb module is supported by software version 6.2 or higher.

Module software O₂ 4700i(X) ppb

Software version 1.0 October 17, 2005 O₂ module with ISM functionality.

Query actual device/module software

When the analyzer is in measuring mode:

Press **menu** key, open Diagnostics menu.

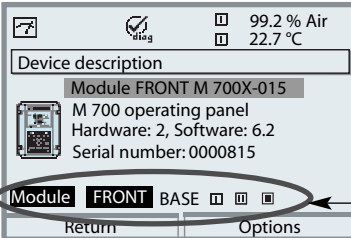
Menu	Display	Device description
 diag		Provides information about all modules installed: Module type and function, serial number, hardware and software version and device options. Select the different modules (FRONT, BASE, slots 1 - 3) using the arrow keys.

Modular concept and instruction manuals

Instruction manuals for basic unit, measuring module, additional functions.

The M 700(X) is an expandable modular process analysis system. The basic unit (M 700 FRONT and BASE) provides three slots which can be equipped by the user with any combination of measuring or communication modules. The software capabilities can be expanded by additional functions (options). Additional functions must be ordered separately. They are supplied with a device-specific TAN for function release.

M 700(X) modular process analysis system



Additional functions

Activation via device-specific TAN
For an overview, see www.mtpro.com



SmartMedia card

Data recording
For an overview, see www.mtpro.com



Measuring modules

- pH / ORP / Temp (also ISM)
- O₂/Temp (also ISM)
- Noncontacting conductivity / Temp
- Contacting conductivity / Temp

3 module slots

for free combination of measuring and communication modules

Communication modules

- Out (additional switching and current outputs)
- PID (analog and digital controller)
- Profibus PA

- **The instruction manual for the M 700(X)** describes how to install, commission and operate the basic unit.
- **The instruction manual for the measuring or communication module** describes all functions required for commissioning and working with the respective measuring or communication module.
- **Additional functions** are supplied with a function description.

Short description: M 700 FRONT

M 700

Modular hardware and software system for liquid analysis.

4 captive screws

for opening the analyzer

(Caution! Make sure that the gasket between FRONT and BASE is properly seated and clean!)

Transflective LC graphic display

(240 x 160 pixels)

white backlighting,

high resolution and high contrast.

Measurement display

For parameter setting, see Pg 32

User interface

with plaintext menus as recommended by NAMUR.

Menu texts can be switched to: German, English, French, Italian, Swedish, and Spanish.

Intuitively acquirable menu logic, based on Windows standards.

Secondary displays

see Page 23

2 softkeys

with context-sensitive functions.

Red LED

signals failure (On) or maintenance request/function check (flashing) according to NE 44.

Green LED

Voltage supply okay

Control panel

3 function keys

(menu, meas, enter)

and 4 arrow keys for menu selection and data entries

5 self-sealing cable glands

M20 x 1.5

for entry of voltage supply and signal lines

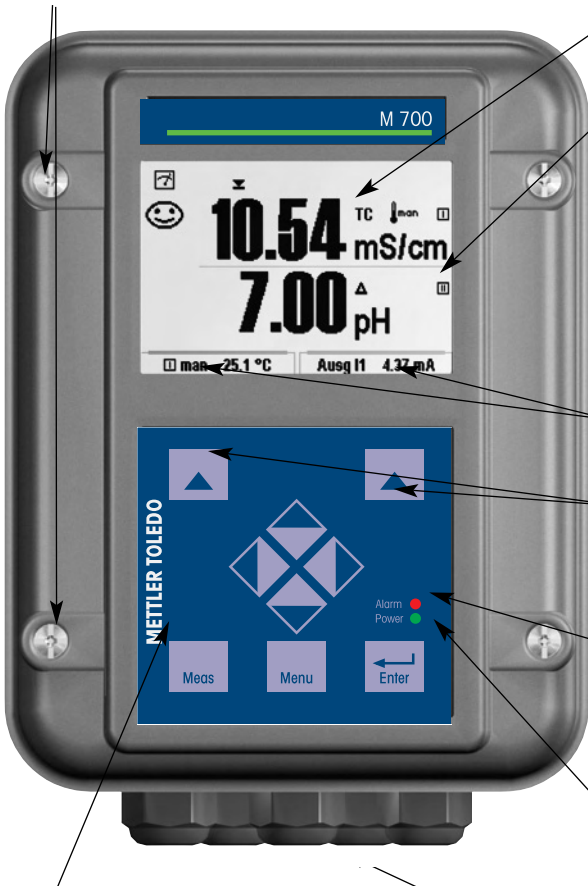

Short description: Menu structure

Basic functions: Calibration, maintenance, parameter setting, diagnostics

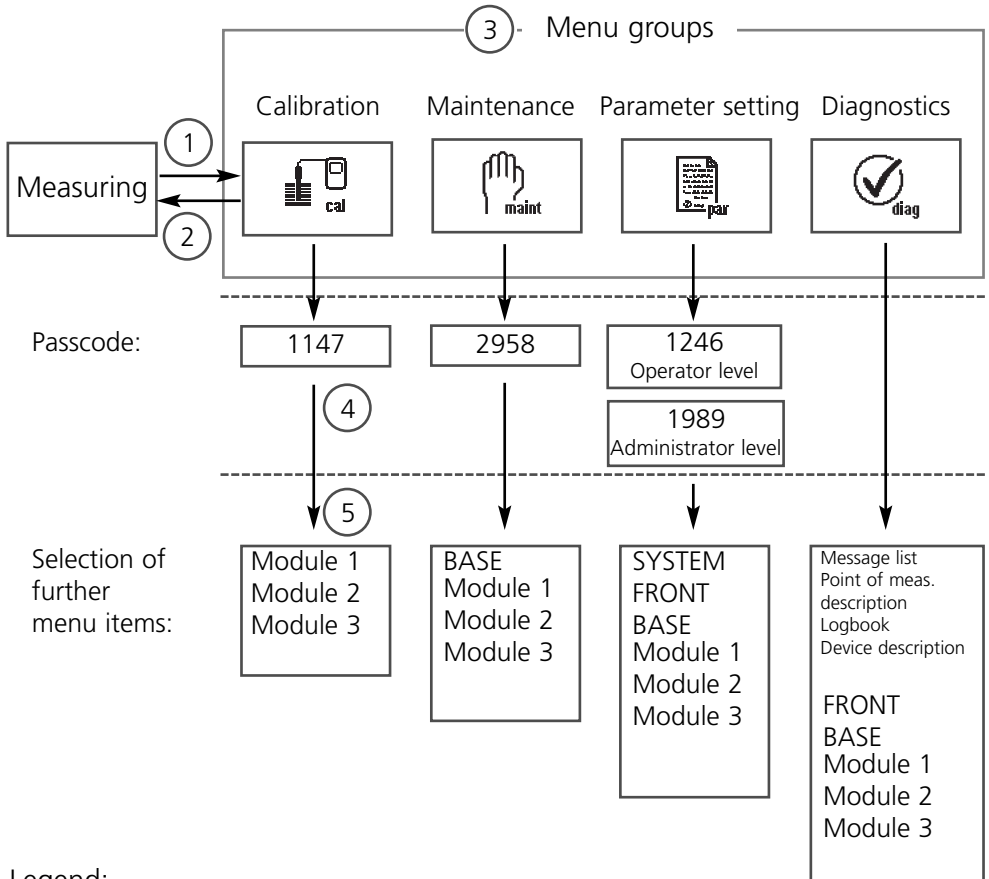

Legend:

- (1) Pressing the **menu** key accesses menu selection
- (2) Pressing the **meas** key returns to measurement
- (3) Menu groups are selected using the arrow keys
- (4) Press **enter** to confirm, enter passcode
- (5) Further menu items are displayed
- (6) Selected functions of the Diagnostics menu can be recalled via softkey even when in measuring mode ("Favorites", Pg 23)

Short description: M 700 FRONT

M 700

View into the open device (M 700 FRONT)

Slot for SmartMedia card

- **Data recording**
The SmartMedia card expands the measurement recorder capacity to > 50000 records.
- **Exchange of parameter sets**
5 parameter sets can be stored on the SmartMedia card, 2 of them can be loaded to the M 700 and switched by remote control. Configurations can be transferred from one analyzer to the other.

- **Function expansions**
are possible with additional software modules which are released using transaction numbers (TAN).

- **Software updates**

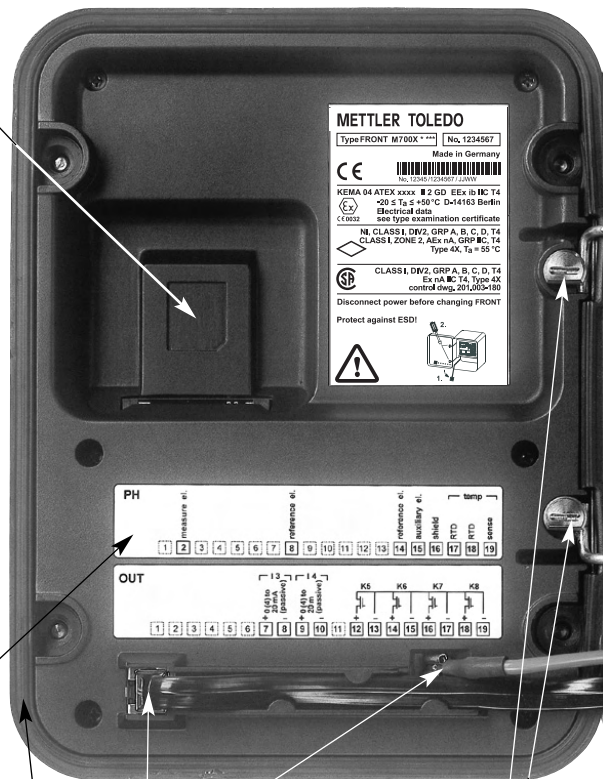

Terminal plates of "hidden" modules

Each module comes with an adhesive label containing the contact assignments. This label should be stuck to the inner side of the front (as shown). Then, the terminal assignments remain visible even if further modules are inserted.

Replacing the front module

Pull off power cord and ground wire. To separate the M 700 FRONT from the M 700 BASE, turn the retaining screws of the pivot hinge by 90°.

The circumferential sealing

guarantees IP 65 protection and allows spray cleaning / disinfection.

Caution! Keep clean!

Short description: M 700 BASE

M 700

View into the open device (M 700 BASE, 3 function modules installed)

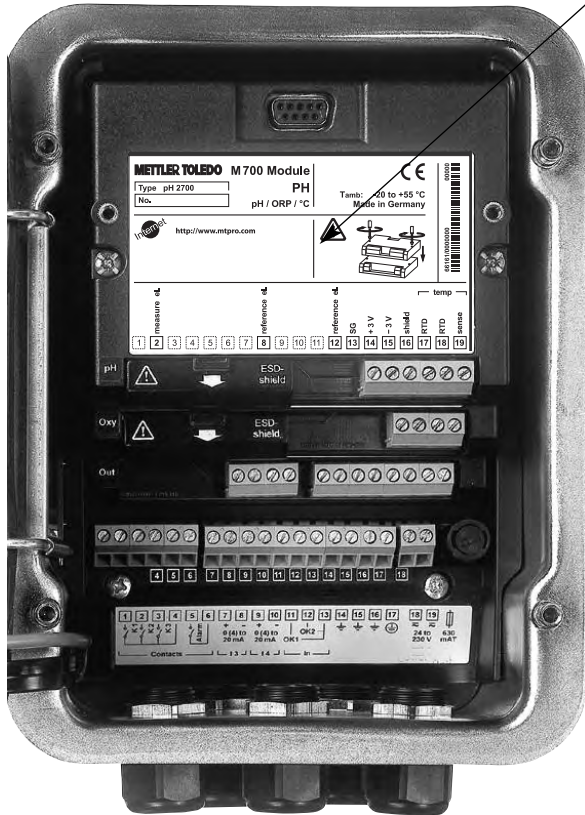

Module equipment

Module identification: Plug & Play
Up to 3 modules can be combined as desired. Several input and communication modules are available.

M 700 BASE

2 current outputs (free assignment of process variable) and 4 relay contacts, 2 digital inputs.
VariPower broad-range power supply, 20 ... 265 V AC/DC, suitable for all public mains supplies in the world.

Power supply units, IS version:

100 ... 230 V AC or
24 V AC/DC

Warning!

Do not touch the terminal compartment, there may be dangerous contact voltages!

Important note concerning SmartMedia card

The SmartMedia card may be inserted or replaced with the power supply switched on. Before a memory card is removed, it must be "closed" in the maintenance menu. When closing the device, make sure that the sealing is properly seated and clean.

Parameter tables (Excel):

www.mtpro.com

Parameter tables (Excel)

2 complete parameter sets can be stored in the basic device M 700(X). You can document the parameter settings of your complete measuring point in an Excel table that can be downloaded from our website.

The complete documentation is available in the download area of our website **www.mtpro.com**.

ISM - Intelligent Sensor Management



The O₂ 4700i(X) ppb module allows the connection of sensors with ISM technology.

ISM is an open system that is compatible to existing VarioPin (VP) connection systems and permits the use of conventional sensors. ISM is not restricted to O₂ measurement. Sensors from different manufacturers can be connected. During O₂ measurement continuous monitoring is still possible.

ISM sensors have an “electronic datasheet” which allows the storage of additional operating parameters such as calibration date and settings directly in the sensor.

An ISM sensor is immediately identified due to the “Plug & Measure” concept. This ensures the clear assignment of a sensor to a measuring point. The risk of confusing the sensors is eliminated.

Information available in the ISM sensor

Each sensor is clearly identified by the unalterable factory data. They consist of information concerning manufacturer, production date, sensor description, application data, and original calibration data, as well as information on predictive maintenance, such as the maximum load index and maximally permitted number of CIP/SIP cycles.

Statistical data inform on the product life cycle of the sensor: data of the last 3 calibrations, adjustment record, media values, partial pressure, temperature, response time, impedance, air pressure.

This allows a comprehensive diagnostic:

- Calculation of the individual load index
- Wear indication
- Membrane body changes
- Inner body changes

Thanks to the “Plug & Measure” method, an ISM sensor is immediately identified after being connected:

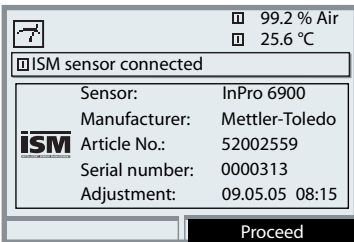

All sensor-typical parameters are automatically sent to the analyzer.

These are, for example, the measurement range, zero and slope of the sensor, but also the type of temperature probe. Without any further parameter setting, measurement starts at once, the measuring temperature is simultaneously detected.

With “Plug & Measure”, premeasured ISM sensors can immediately be used for measurement without previous calibration.

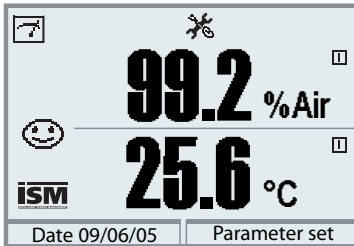

The ISM logo is displayed as long as an ISM sensor is connected.

When the ISM sensor has not been adjusted, the “maintenance request” icon is displayed.

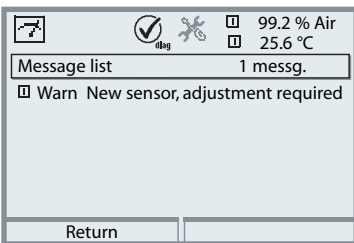

A new entry is added to the message list of the Diagnostics menu:

Warn New sensor, adjustment required

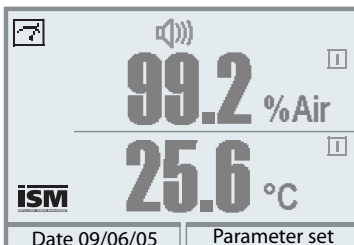

Failure message (incorrect meas. values)

Measured value, alarm icon, and module slot identifier are flashing.

The flashing means:

Caution! The displayed value is no “valid” measured value!

It is possible to use a new sensor without previous calibration. However, a First Calibration is recommended to achieve optimum measurement results.

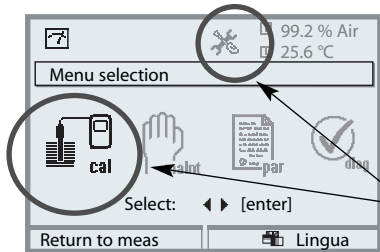

Call up calibration

Press **menu** key to select menu.

The “maintenance request” and “calibration” icons are flashing to indicate that calibration is recommended. An entry is made in the message list.

Select calibration using arrow keys, confirm with **enter**. Passcode: 1147.

(To change passcode: Parameter setting/System control/Passcode entry) After passcode entry, the system is in function check mode: Current outputs and relay contacts behave as configured* and supply either the last measured value or a fixed value until the Calibration menu is exited.

* The current outputs / relay contacts are configured in the M 700 BASE or the communication modules (Out, PID).

The “function check” mode is indicated by the “Hold” icon (upper left of display).

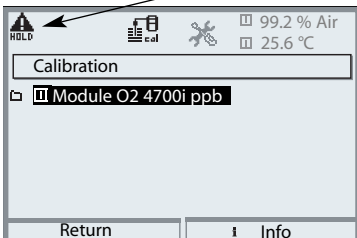

Select module using arrow keys, confirm with **enter**.

Calibration: See Pg 34.

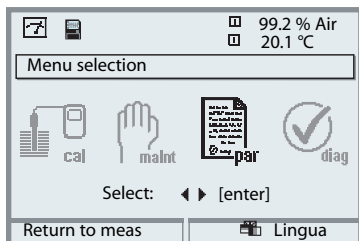

Configuring an ISM sensor is considerably safer and easier than configuring a conventional sensor. Since ISM sensors have an “electronic datasheet”, many parameters are already provided by the sensor and automatically taken over by the analyzer.

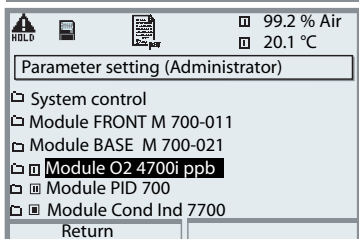

To enter the process-related parameters, select:

- **Parameter setting**
- **Module selection**
- **Sensor data**
- **Sensor monitoring details**

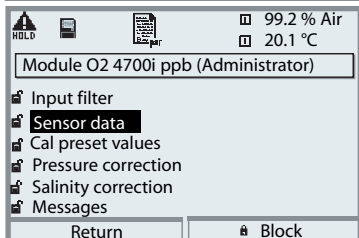

Sensor monitoring details (Pg 53)

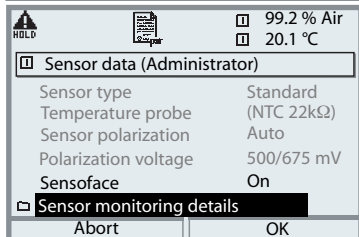

When an ISM sensor is connected, the values for slope, zero, and response time are automatically read by the module*. Additional specifications are required for sensor wear, CIP/SIP counter, autoclaving counter, and sensor operating time. The tolerance limits are displayed in gray.

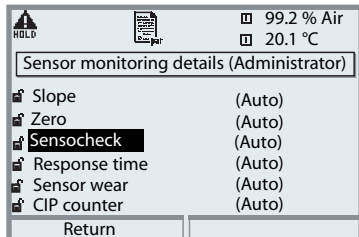

* Individual specifications are not overwritten by electrode data.

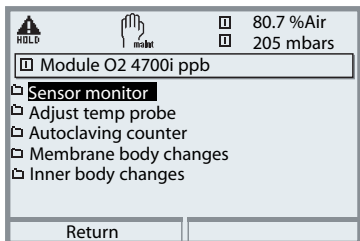

ISM sensors provide important tools for predictive maintenance.

The settings are made in the

• Maintenance menu / Module selection

For description of Sensor monitor and Adjust temp probe menu, see Pg 49.

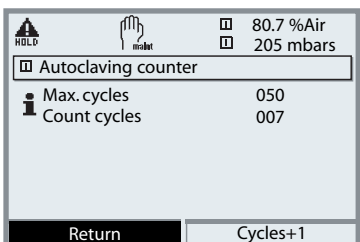

Autoclaving counter (ISM only)

When setting the sensor data, the maximum number of autoclaving procedures permitted must be specified. Then, each cycle can be recorded in the Maintenance menu. This shows how many autoclaving cycles are still permitted.

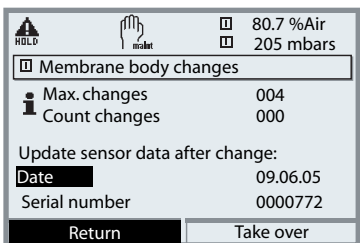

Membrane body changes (ISM only)

During parameter setting, the maximum number of membrane body changes permitted must be specified. Then, each cycle can be recorded in the Maintenance menu (date, serial number). This shows how many changes are still permitted.

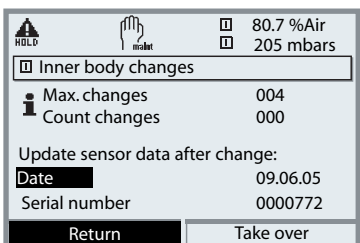

Inner body changes (ISM only)

During parameter setting, the maximum number of inner body changes permitted must be specified.

Then, each change of an inner body can be recorded in the Maintenance menu (date, serial number). This shows how many changes are still permitted.

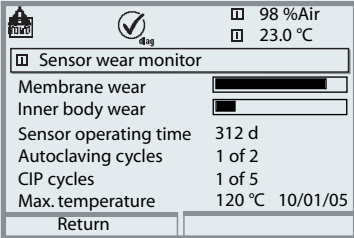

Sensor wear monitor (ISM only)

The Diagnostics menu provides single-glance information on the current sensor wear since the data for maximum load of membrane body and inner body are stored in the ISM sensor. Generally, the membrane body must be replaced more often than the inner body: The “Membrane wear” bargraph shows to what degree the membrane is used up. The inner body wear is not reset when a membrane body has been replaced - here, the load on the inner body is added up and represented as the total load on the inner body.

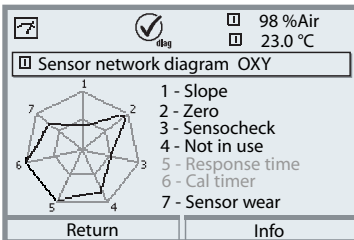

Sensor network diagram

- Slope
- Zero
- Sensocheck
- (Not in use)
- Response time
- Calibration timer
- Sensor wear

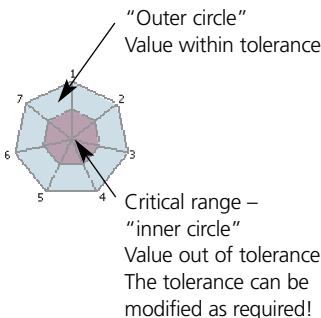

The measured values are continuously monitored during the measurement process. The sensor network diagram provides at-a-glance information about critical parameters. If a tolerance limit has been exceeded, the respective parameter is flashing. Values in gray: Monitoring switched off. To switch on, refer to “Info”.

Setting diagnostics messages as favorite

Select menu: Parameter setting/System control/Function control matrix

Secondary displays (1)

Here, additional values are displayed in the measuring mode according to the factory setting. When the respective softkey (2) is pressed, the process variables measured by the modules plus date or time are displayed.

In addition, you can use the **softkeys (2)** to control functions. To assign a function to a softkey, select

- **Parameter setting/System control/**
- **Function control matrix** (Fig.):

Function which can be controlled by softkeys:

- Parameter set selection
- KI recorder Start/Stop
- Favorites
- EC 400 (fully automated probe controller)

Favorites

Selected Diagnostics functions can be called up directly from the measuring mode using a softkey.

The following table (Pg 24) explains how to select favorites.

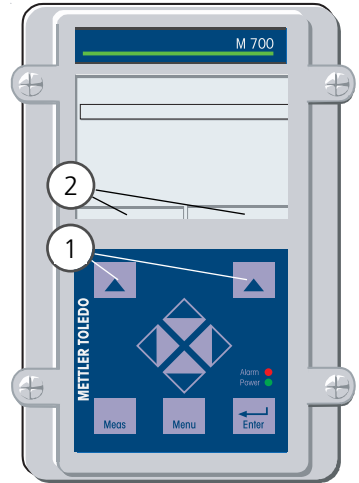

Function control matrix (Administrator)				
	ParSet	KI rec.	☺ Fav	EC 400
Input OK2	<input type="radio"/>	<input type="radio"/>	<input type="radio"/>	-
Left softkey	<input type="radio"/>	<input type="radio"/>	<input checked="" type="radio"/>	-
Right softkey	<input type="radio"/>	<input type="radio"/>	<input type="radio"/>	-
Profibus DO 2	<input type="radio"/>	<input type="radio"/>	<input type="radio"/>	-
Return		⊗ Connect		

Example:



“Favorites” to be selected with “Right softkey”

To select a softkey function:

Select desired function using arrow keys, press “Connect” softkey and confirm with **enter**.

Deselect function:

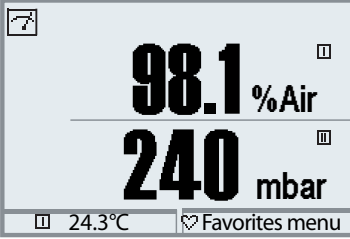
Press “Disconnect” softkey, confirm with **enter**.

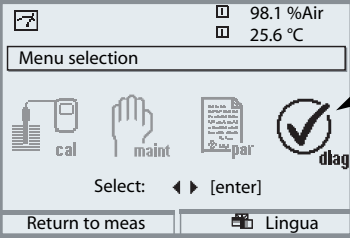
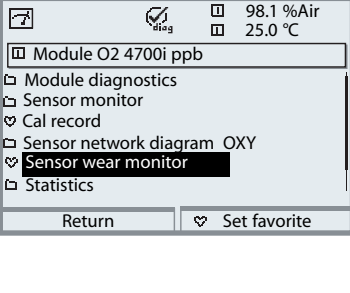
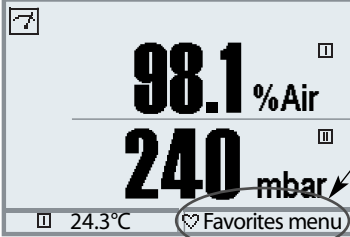
Menu	Display	Select favorites
		<p>Favorites menu</p> <p>Diagnostics functions can be called up directly from the measuring mode using a softkey. The “Favorites” are selected in the Diagnostics menu.</p>
		<p>Select favorites</p> <p>Press menu key to select menu. Select diagnostics using arrow keys, confirm with enter. Then select module and confirm with enter.</p>
		<p>Set/delete favorite:</p> <p>“Set favorite” allows activation of the selected diagnostic function directly from the measuring mode via softkey. The respective function is marked with a heart icon (see Softkey usage, Pg 23).</p>
		<p>Pressing the meas key returns to measurement. When the softkey has been assigned to “Favorites”, “Favorites menu” is read in the secondary display (see “Function control matrix”, Pg 23).</p>

Note:

When one of the softkeys has been assigned to the “Favorites menu” function, diagnostic functions which have been set as “Favorite” can be directly called up from the measuring mode.

Practical advantages of ISM sensors (e.g. in biotech applications)

CIP (Cleaning in Place) / SIP (Sterilize in Place)

CIP/SIP cycles are used for cleaning or sterilizing the process-wetted parts in the process. They are performed for biotech applications, for example. Depending on the application, one (hot acid, water) or more media (hot acid, water, hot alkaline solution, water) are used. The temperatures for CIP are around 80 °C, for SIP around 110 °C. This procedure extremely stresses the sensors. ISM sensors can release a message when a preset number of permitted CIP/SIP cycles is exceeded. This allows replacing the sensor in time.

Example of CIP cycle:

The device automatically recognizes the CIP and SIP cycles and correspondingly increments the counter. The user can specify the max. number of cycles and decide whether a message is to be generated when this number is exceeded.

These data are not overwritten even after sensor replacement. The number of CIP cycles is shown in the sensor wear monitor of the Diagnostics menu when an individual max value has been specified.

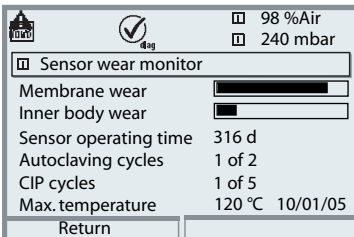

The screenshot shows a diagnostic menu with the following data:

98 %Air	
240 mbar	
Sensor wear monitor	
Membrane wear	<div style="width: 80%;"></div>
Inner body wear	<div style="width: 20%;"></div>
Sensor operating time	316 d
Autoclaving cycles	1 of 2
CIP cycles	1 of 5
Max. temperature	120 °C 10/01/05
Return	

Terminal plate O₂ 4700i(X) ppb module

Terminal plate O₂ 4700i ppb module:

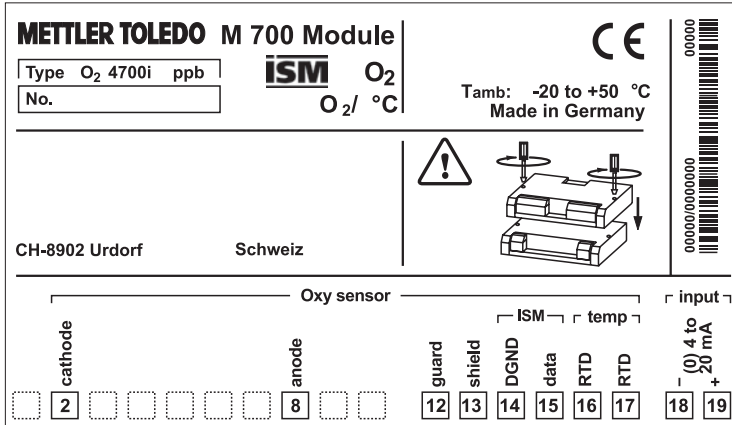

Terminal plate O₂ 4700iX ppb module:

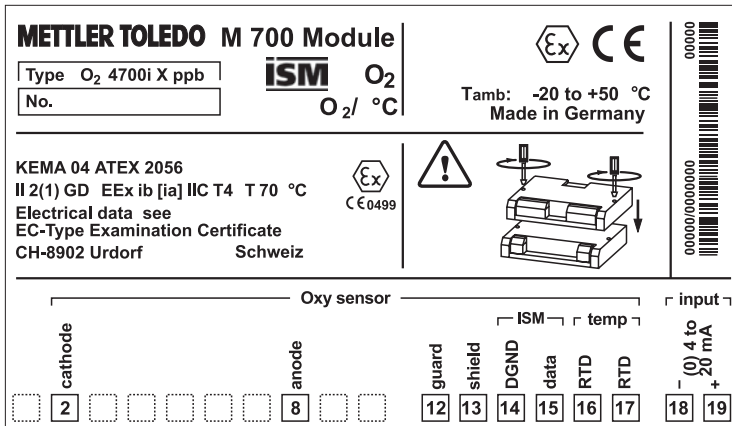

Attaching the terminal plates

The terminal plates of the lower modules can be stuck to the inner side of the door. This facilitates maintenance and service.



Inserting the module

Note: Be sure to connect the shielding properly!

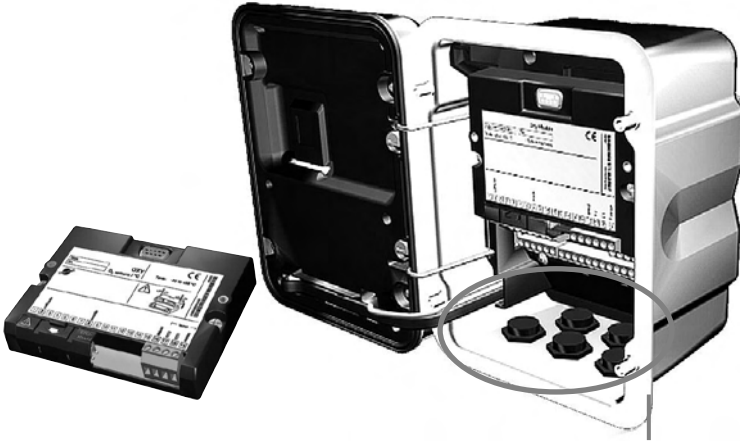

Terminals 2 and 8 are covered by an ESD shield. To connect the sensor cable, just pull it back.

Make sure that the cable glands are tightly closed to protect against humidity.

1. Switch off power supply
2. Open the device (loosen the 4 screws at the front)
3. Place module in slot (D-SUB connector)
4. Tighten fastening screws of the module
5. Open ESD shielding cap (covering terminals 2 and 8)
6. Connect sensor cable.
To avoid interferences, the cable shielding must be completely covered by the ESD shielding cap.
7. Close ESD shielding cap (covering terminals 2 and 8)
8. Close device, tighten screws at the front
9. Switch on power supply
10. Set parameters (Pg 55)

Wiring example (also ISM)

Mettler-Toledo InPro 6900 trace sensor or ISM sensor
VP8 connection

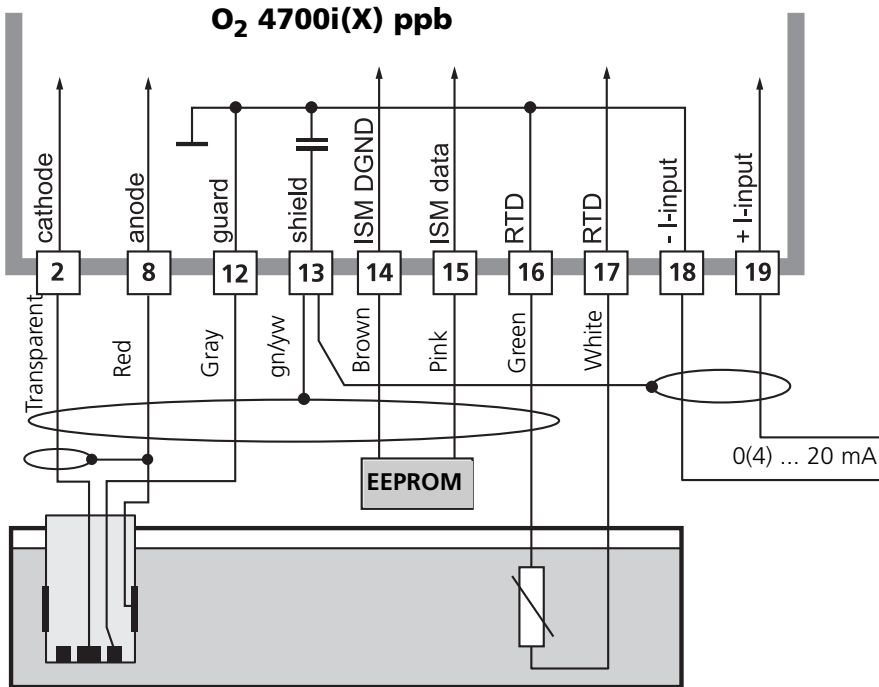

The signal from an external pressure transmitter can be fed in through the external current input. This allows pressure correction of the oxygen measurement. For parameter setting, see Pg 55.

Note:

Without ISM functionality compatible to VP6 connection.
In that case, terminals 14 and 15 are not connected.

Menu selection

After switching on, the analyzer performs an internal test routine and automatically detects the number and type of modules installed. Then, the analyzer goes to measuring mode.

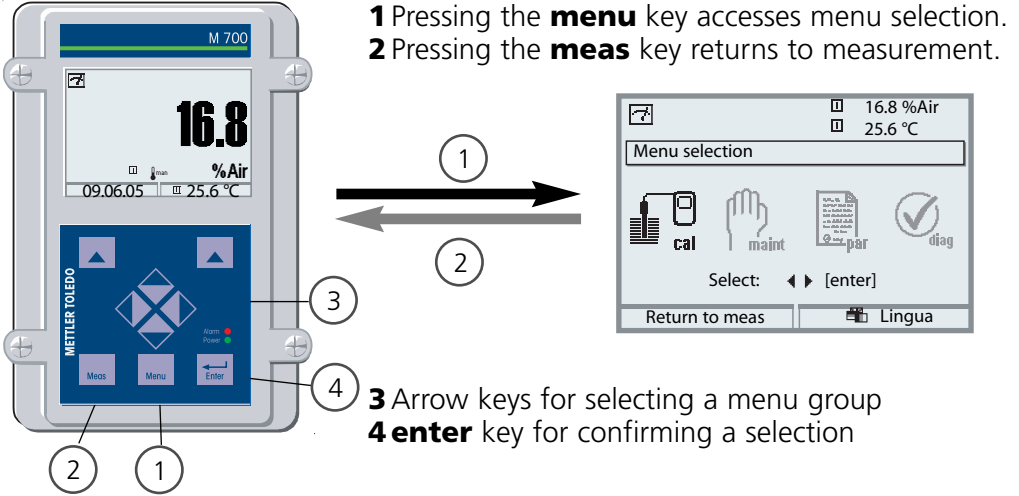

Menu structure

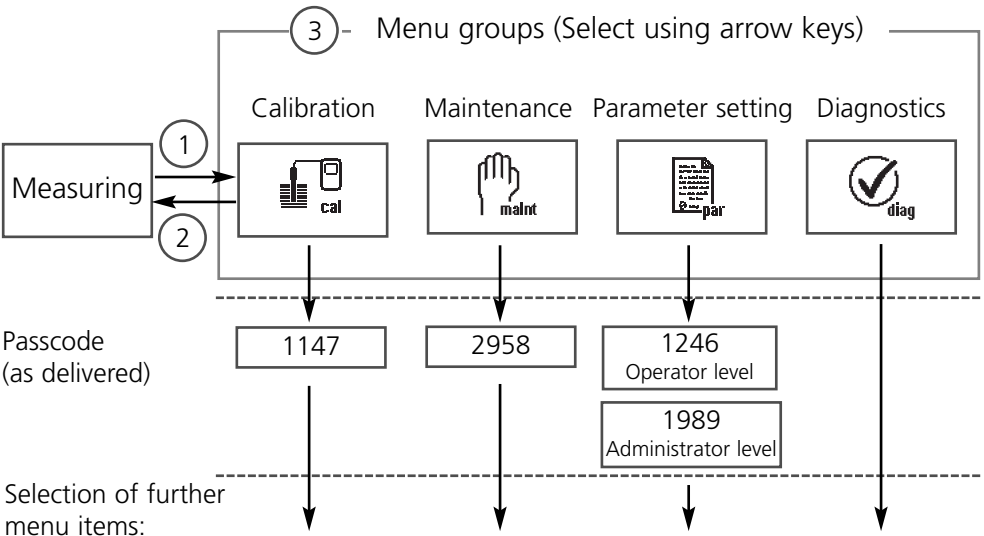

Passcode entry

Enter passcode:

Select the position using the left/right keys, then edit the number using the up/down keys. When all numbers have been entered, confirm with **enter**.

To change a passcode

- Open the menu selection (**menu** key)
- Select parameter setting
- Administrator level, enter passcode
- Select System control: Passcode entry

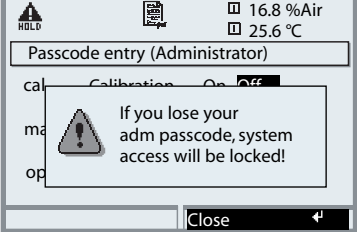
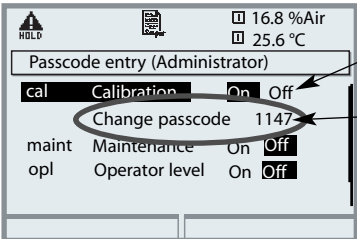
Menu	Display	System control: Passcode entry												
	 	<p>Changing a passcode: “Passcode entry” menu</p> <p>When this menu is opened, the analyzer displays a warning (Fig.). Passcodes (factory settings):</p> <table border="0"> <tr> <td>Calibration</td> <td>(cal)</td> <td>1147</td> </tr> <tr> <td>Maintenance</td> <td>(maint)</td> <td>2958</td> </tr> <tr> <td>Operator level</td> <td>(opl)</td> <td>1246</td> </tr> <tr> <td>Administrator level</td> <td>(adm)</td> <td>1989</td> </tr> </table> <p>Caution</p> <p>If you lose the Administrator passcode, system access is locked! Please consult our technical support!</p> <p>To change a passcode, select “On” using the arrow keys. Confirm with enter.</p> <p>Select the position using the left/right keys, then edit the number using the up/down keys. When all numbers have been entered, confirm with enter.</p>	Calibration	(cal)	1147	Maintenance	(maint)	2958	Operator level	(opl)	1246	Administrator level	(adm)	1989
Calibration	(cal)	1147												
Maintenance	(maint)	2958												
Operator level	(opl)	1246												
Administrator level	(adm)	1989												

Configuring the measurement display

Select menu: Parameter setting/Module FRONT/Measurement display

Pressing **meas (1)** returns the analyzer to the measuring mode from any function.

All process variables coming from the modules can be displayed. The table on the next page describes how to configure the measurement display.

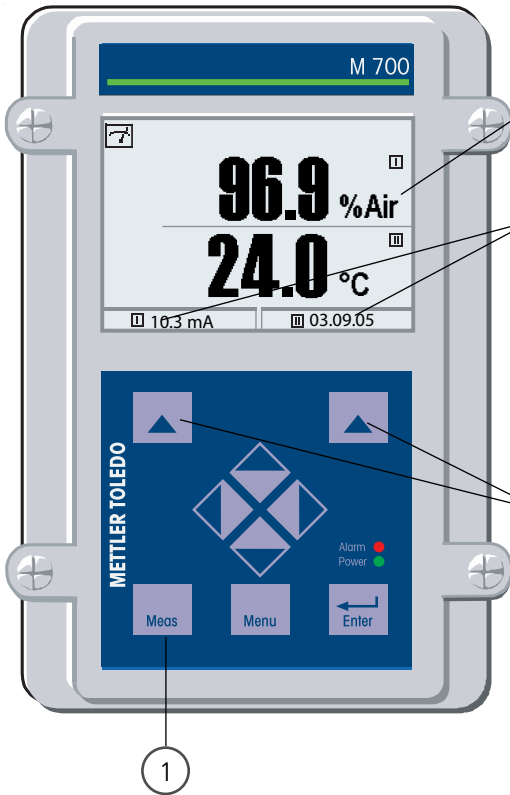

Measurement display



Typical display for
2 measured values

Secondary displays

Additional values, also date and
time, can be displayed depending
on the modules installed. They
are selected using the softkeys.

Softkeys

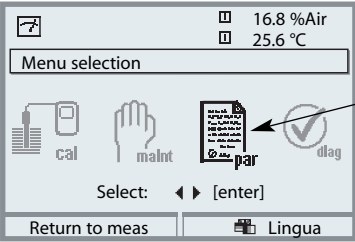
In measuring mode, the softkeys
allow selection of values for the sec-
ondary displays or control of func-
tions (user defined).

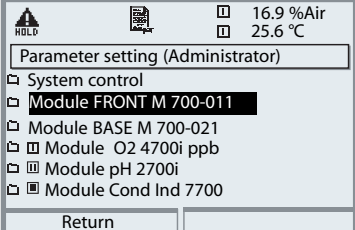
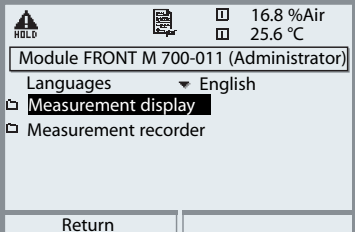
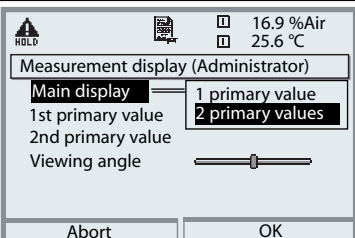
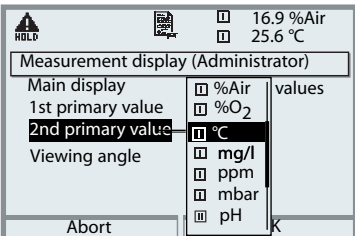
Menu	Display	Configure measurement display
		<p>Configure measurement display</p> <p>Press menu key to select menu. Select parameter setting using arrow keys, confirm with enter. Select: “Administrator level”: Passcode 1989 (For passcodes, see Pg 31)</p>
		<p>Parameter setting: Select “Module FRONT”</p>
		<p>M 700 FRONT: Select “Measurement display”</p>
		<p>Measurement display: Set the number of primary values (large display) to be displayed</p>
		<p>Select process variable(s) to be displayed and confirm with enter.</p> <p>Pressing the meas key returns to measurement.</p>

Calibration / adjustment

Note: Function check active

Current outputs and relay contacts behave as configured

- **Calibration:** Detecting deviations **without** readjustment
- **Adjustment:** Detecting deviations **with** readjustment

Caution:

Without adjustment every dissolved oxygen meter delivers an imprecise or wrong output value! After replacing the sensor, the electrolyte, or the sensor membrane, you must perform a calibration!

The resulting values must be taken over by an adjustment for calculating the measured variables (measured value display, output signals)!

Procedure

Every dissolved oxygen sensor has its individual slope and zero point. Both values are altered, for example, by aging. For sufficiently high accuracy of oxygen measurement, the meter must be regularly adjusted for the sensor data (calibration+adjustment).

Sensor replacement (First Calibration)

After replacement of the sensor, electrolyte or sensor membrane, a "First Calibration" should be performed. During First Calibration, the sensor data are stored as reference values for the statistics.

The "Statistics" menu of Diagnostics (Pg 76) shows the deviations of zero, slope, calibration temperature, calibration pressure and response time of the last three calibrations with respect to the reference values of the First Calibration. This allows evaluation of the drift behavior and aging of the sensor.

Calibration/adjustment methods

- Automatic calibration in water/air
- Product calibration (saturation/concentration)
- Data entry
- Zero point correction

Adjustment

means that the values determined by a calibration are taken over. The values determined for zero and slope are entered in the calibration record. (Cal record can be called up in the Diagnostics menu for the module, see Pg 76).

These values are only effective for calculating the measured variables when the calibration has been terminated with an adjustment.

A passcode ensures that an adjustment can only be performed by an authorized person (Administrator).

The Operator can check the current sensor data by a calibration and inform the Administrator when there are deviations.

You can use the additional function SW 700-107 for granting access rights (passcodes) and for AuditTrail (continuous data recording and backup according to FDA 21 CFR Part 11).

Recommendations for calibration

It is always recommended to calibrate in air. Compared to water, air is a calibration medium which is easy to handle, stable, and thus safe. In the most cases, however, the sensor must be dismantled for a calibration in air. When dealing with biotechnological processes which require sterile conditions, the sensor cannot be removed for calibration. Here, calibration must be performed with aeration directly in the process medium (e.g. after sterilization). In the field of biotechnology often saturation is measured and calibration is performed in the process medium (water) for reasons of sterility.

For other applications where concentration is measured (water, waste water, etc.), calibration in air has proved to be useful.

Common combination: process variable / calibration mode

<u>Measurement</u>	<u>Calibration</u>
Saturation	Water
Concentration	Air

If there is a temperature difference between the calibration medium and the measured medium, the sensor must be kept in the respective medium for several minutes before and after calibration in order to deliver stable measured values. The type of calibration pressure detection is preset during parameter setting (Pg 55).

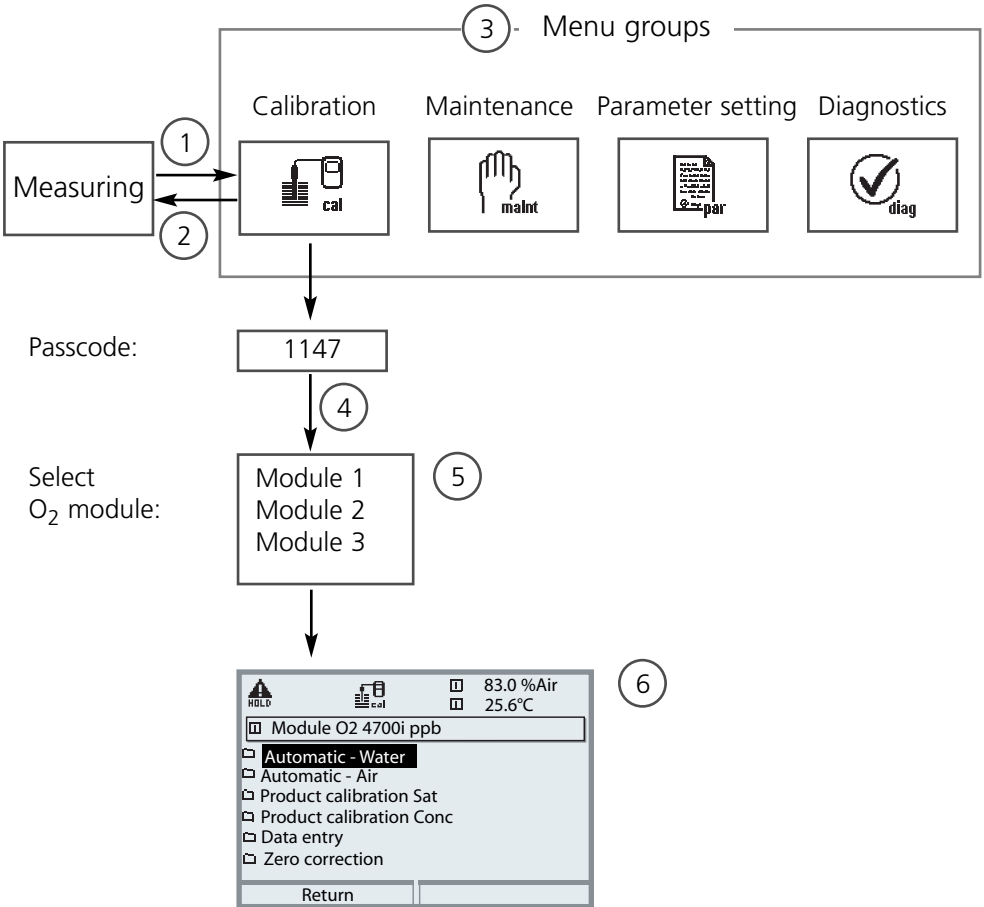

Calibration / adjustment

Selecting a calibration method

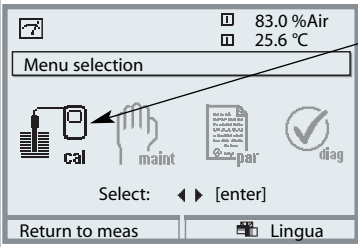

O₂ module calibration: Select calibration method

- (1) Pressing the **menu** key accesses menu selection
- (2) Pressing the **meas** key returns to measurement from every level
- (3) Select Calibration menu group using the arrow keys
- (4) Press **enter** to confirm, enter passcode
- (5) Select O₂ module, confirm with **enter**
- (6) Select calibration method

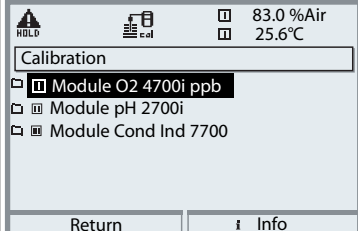
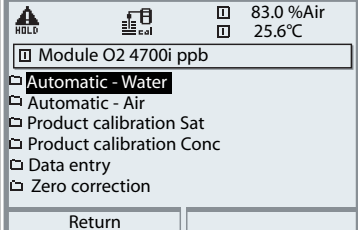
Menu	Display	Select calibration method
	 <p>83.0 %Air 25.6 °C</p> <p>Menu selection</p> <p>cal maint par diag</p> <p>Select: ◀ ▶ [enter]</p> <p>Return to meas Lingua</p>	<p>Call up calibration</p> <p>Press menu key to select menu. Select calibration using arrow keys, confirm with enter, passcode 1147 (To change passcode: Parameter setting/System control/Passcode entry)</p> <p>After passcode entry, the system is in function check mode: Current outputs and relay contacts behave as configured (BASE, Out, PID) until the Calibration menu is exited.</p>
	 <p>HOLD cal 83.0 %Air 25.6 °C</p> <p>Calibration</p> <p>Module O2 4700i ppb</p> <p>Module pH 2700i</p> <p>Module Cond Ind 7700</p> <p>Return Info</p>	<p>Calibration:</p> <p>Select "Module O₂".</p>
	 <p>HOLD cal 83.0 %Air 25.6 °C</p> <p>Module O2 4700i ppb</p> <p>Automatic - Water</p> <p>Automatic - Air</p> <p>Product calibration Sat</p> <p>Product calibration Conc</p> <p>Data entry</p> <p>Zero correction</p> <p>Return</p>	<p>Select a calibration method:</p> <ul style="list-style-type: none"> • Automatic - water (Pg 38) • Automatic - air (Pg 40) • Product calibration saturation (Pg 42) • Product calibration concentration (Pg 44) • Data entry (Pg 46) • Zero point correction (Pg 47) <p>When you open the Calibration menu, the analyzer automatically proposes the previous calibration method. If you do not want to calibrate, "Return" with the left softkey.</p>

Calibration / adjustment

Automatic calibration in water

Automatic calibration in water



The calibration value is always the oxygen saturation (referred to air). First, the slope is corrected using the 100 % value.

During calibration the M 700 is in function check mode. Current outputs and relay contacts behave as configured (BASE, Out, PID modules).

Caution!

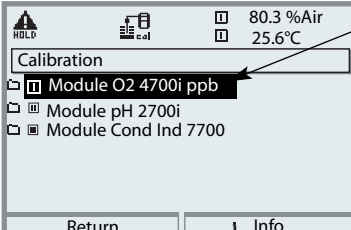
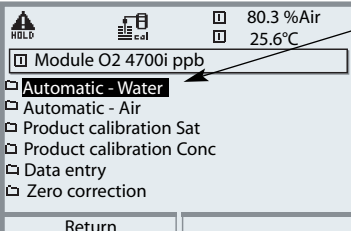
Ensure sufficient medium flow to the sensor (see Specifications of dissolved oxygen sensors). The calibration medium must be in equilibrium with air. Oxygen exchange between water and air is very slow. Therefore, it takes a relatively long time until water is saturated with atmospheric oxygen. If there is a temperature difference between calibration medium and measured medium, the sensor must be kept in the respective medium for several minutes before and after calibration.

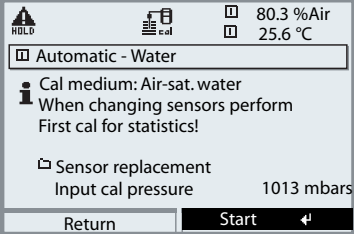
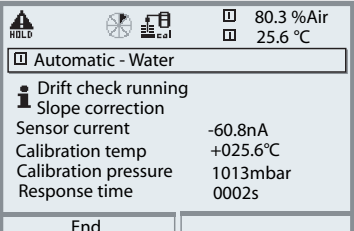
Menu	Display	Select calibration mode
		<p>Select module: O₂ 4700i ppb</p> <p>The analyzer is in function check mode. Current outputs and relay contacts behave as configured (BASE, Out, PID). Confirm with enter.</p>
		<p>Select calibration method "Automatic - Water"</p> <p>Remove sensor and immerse it in cal medium (air-saturated water), ensure sufficient medium flow to the sensor. Confirm with enter.</p>

Menu	Display	Automatic calibration in water
	 <p>Automatic - Water</p> <p>Cal medium: Air-sat. water When changing sensors perform First cal for statistics!</p> <p>Sensor replacement Input cal pressure 1013 mbars</p> <p>Return Start ↵</p>	<p>Display of selected calibration medium (Air-sat. water)</p> <p>Sensor replacement: Pg 34</p> <p>Enter cal pressure if “manual” has been configured (Pg 55)</p> <p>Start with softkey or enter</p>
	 <p>Automatic - Water</p> <p>Drift check running Slope correction</p> <p>Sensor current -60.8nA Calibration temp +025.6°C Calibration pressure 1013mbar Response time 0002s</p> <p>End</p>	<p>Drift check.</p> <p>Display during calibration</p> <ul style="list-style-type: none"> • Sensor current • Calibration temperature • Calibration pressure • Response time
	 <p>Calibration data record</p> <p>Calibration 08/12/05 15:20 Cal mode Automatic - Water Zero +0.030 nA Slope +059.3 nA Response time 0070 s</p> <p>End Adjust ↵</p>	<p>Waiting time can be reduced by pressing enter (without drift check: reduced accuracy of calibration values!). From the response time, you see how long it takes the sensor to deliver a stable signal. If the signal or the measured temperature fluctuate greatly, the calibration procedure is aborted after 2 min. Calibration must be re-started. If successful, place sensor in process, end calibration with softkey or enter</p> <p>Adjustment</p> <p>Press “Adjust” to take over the values determined during calibration for calculating the measured variables. See Page 48.</p>

Calibration / adjustment

Automatic calibration in air

Automatic calibration in air

The calibration value is always the oxygen saturation (referred to air).

The slope value is corrected. If you do not know the exact value of the relative humidity of the air used, you can take the following standard values for a sufficiently precise calibration:

- Ambient air: 50 % (average)
- Bottled gas (synthetic air): 0 %

During calibration the M 700 is in function check mode.

Current outputs and relay contacts behave as configured (BASE, Out, PID).

Caution!

The sensor membrane must be dry. Be sure to keep temperature and pressure constant during calibration. If there is a temperature difference between calibration medium and measured medium, the sensor must be kept in the respective medium for several minutes before and after calibration.

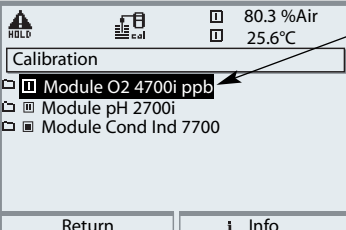
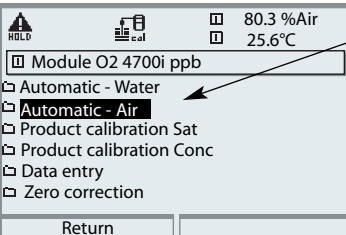
Menu	Display	Select calibration mode
		<p>Select module: O₂ 4700i ppb</p> <p>The analyzer is in function check mode. Current outputs and relay contacts behave as configured (BASE, Out, PID). Confirm with enter.</p>
		<p>Select calibration method "Automatic - Air"</p> <p>Remove sensor and place it in air.</p> <p>Confirm with enter.</p>

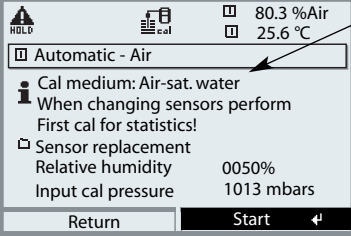
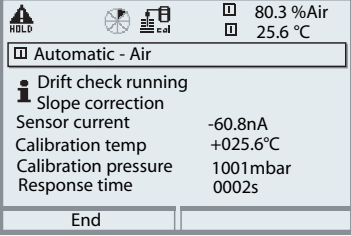
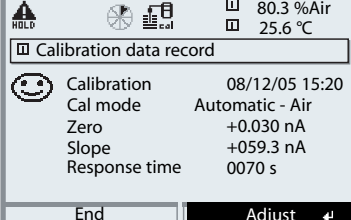
Menu	Display	Automatic calibration in air
	 <p>Automatic - Air</p> <ul style="list-style-type: none"> Cal medium: Air-sat. water When changing sensors perform First cal for statistics! Sensor replacement <ul style="list-style-type: none"> Relative humidity 0050% Input cal pressure 1013 mbars <p>Return Start ↵</p>	<p>Cal medium: Air</p> <p>Select: First Calibration (Pg 34)</p> <p>Enter relative humidity, e.g.:</p> <ul style="list-style-type: none"> Ambient air: 50 % Bottled gas: 0 % <p>Enter cal pressure if "manual" has been configured (Pg 55)</p> <p>Start with softkey or enter</p>
	 <p>Automatic - Air</p> <ul style="list-style-type: none"> Drift check running Slope correction Sensor current -60.8nA Calibration temp +025.6°C Calibration pressure 1001mbar Response time 0002s <p>End</p>	<p>Drift check.</p> <p>Display during calibration</p> <ul style="list-style-type: none"> Sensor current, calibration temp, cal pressure and response time. <p>Waiting time can be reduced by pressing "End" (without drift check: reduced accuracy of calibration values!). From the response time, you see how long it takes the sensor to deliver a stable signal. If the signal or the measured temperature fluctuate greatly, the calibration procedure is aborted after about 2 min.</p> <p>Calibration must be re-started. If successful, place sensor in process, end calibration with softkey or enter</p>
	 <p>Automatic - Air</p> <p>Calibration data record</p> <ul style="list-style-type: none"> Calibration 08/12/05 15:20 Cal mode Automatic - Air Zero +0.030 nA Slope +059.3 nA Response time 0070 s <p>End Adjust ↵</p>	<p>Adjustment</p> <p>Press "Adjust" to take over the values determined during calibration for calculating the measured variables. See Page 48.</p>

Calibration / adjustment

Product calibration: Saturation

Product calibration: Saturation (Calibration with sampling)

When the sensor cannot be removed – e.g. for sterility reasons – its slope can be determined with “sampling”. To do so, the currently measured saturation value of the process is stored by the analyzer. Directly afterwards, a reference value is determined using a portable meter, for example. The reference value is entered into the measuring system. From the difference between measured value and reference value, the analyzer calculates the sensor slope. With low saturation values, the analyzer corrects the zero point, with high values the slope.

During calibration the M 700 is in function check mode.

Current outputs and relay contacts behave as configured (BASE, Out, PID).

Caution!

The reference value must be measured at temperature and pressure conditions similar to those of the process.

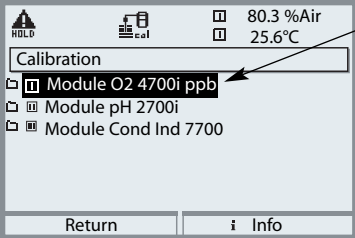
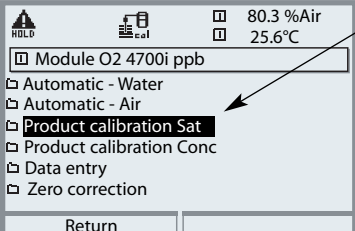
Menu	Display	Product calibration: Saturation
		<p>Select module: O₂ 4700i ppb</p> <p>The analyzer is in function check mode. Current outputs and relay contacts behave as configured (BASE, Out, PID). Confirm with enter.</p>
		<p>Select calibration method “Product calibration-Sat”</p> <p>Confirm with enter.</p>

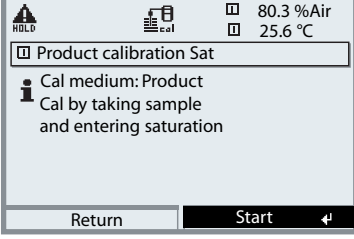
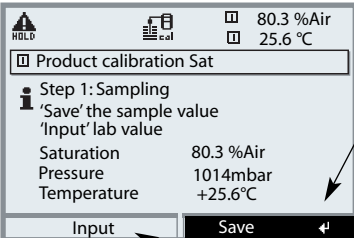
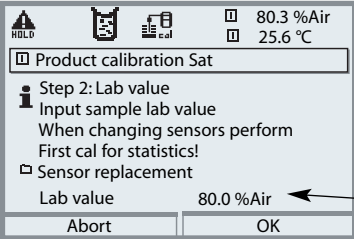
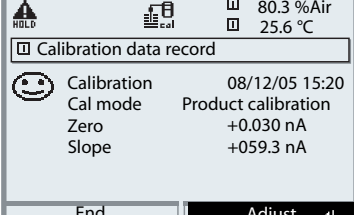
Menu	Display	Product calibration: Saturation
	<div data-bbox="185 244 540 483">  </div> <div data-bbox="185 488 540 727">  </div>	<p>Product calibration Sat</p> <p>Product calibration is performed in 2 steps. Prepare reference measurement (e.g. with portable meter), start with softkey or enter</p> <p>Step 1</p> <p>Take sample. Store measured value and temperature at the moment of sampling ("Save" softkey or enter) Press meas to return to measurement.</p> <p>Exception:</p> <p>Sample value can be measured on the site and be entered immediately. To do so, press "Input" softkey.</p>
	<div data-bbox="185 951 540 1190">  </div>	<p>Step 2</p> <p>Lab value has been measured. When you open the Product calibration menu again, the display shown on the left appears: Enter reference value ("Lab value"). Confirm with "OK".</p>
	<div data-bbox="185 1254 540 1469">  </div>	<p>Adjustment</p> <p>Press "Adjust" to take over the values determined during calibration for calculating the measured variables. See Page 48.</p>

Calibration / adjustment

Product calibration: Concentration

Product calibration: Concentration (Calibration with sampling)

When the sensor cannot be removed – e.g. for sterility reasons – its slope can be determined with “sampling”. To do so, the currently measured concentration value of the process is stored by the analyzer. Directly afterwards, a reference value is determined using a portable meter, for example.

The reference value is entered into the measuring system. From the difference between measured value and reference value, the analyzer calculates the sensor slope. With low concentration values, the analyzer corrects the zero point, with high concentrations the slope.

During calibration the M 700 is in function check mode.

Current outputs and relay contacts behave as configured (BASE, Out, PID).

Caution!

The reference value must be measured at temperature and pressure conditions similar to those of the process.

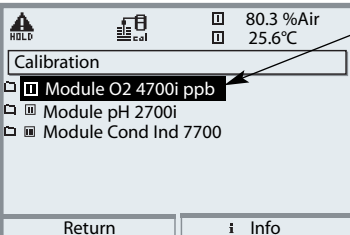
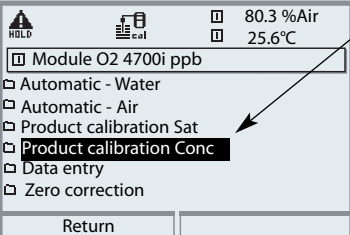
Menu	Display	Product calibration: Concentration
 cal		<p>Select module: O₂ 4700i ppb</p> <p>The analyzer is in function check mode. Current outputs and relay contacts behave as configured (BASE, Out, PID). Confirm with enter.</p>
		<p>Select calibration method “Product calibration Conc”</p> <p>Confirm with enter.</p>

Menu	Display	Product calibration: Concentration
	<div data-bbox="196 239 543 478"> <p>Product calibration Conc</p> <p>Cal medium: Product Calibration by sampling and entering concentration</p> <p>Return Start ↵</p> </div> <div data-bbox="196 486 543 734"> <p>Product calibration Conc</p> <p>Step 1: Sampling 'Save' the sample value 'Input' lab value</p> <p>Concentration 0014µg/l Pressure 1013mbar Temperature +25.6°C</p> <p>Input Save ↵</p> </div>	<p>Product calibration Conc</p> <p>Product calibration is performed in 2 steps. Prepare reference measurement (e.g. with portable meter), start with softkey or enter</p> <p>Step 1 Take sample. Store measured value and temperature at the moment of sampling ("Save" softkey or enter) Press meas to return to measurement.</p> <p>Exception: Sample value can be measured on the site and be entered immediately. To do so, press "Input" softkey.</p>
	<div data-bbox="196 941 543 1181"> <p>Product calibration Conc</p> <p>Step 2: Lab value Input sample lab value When changing sensors perform First cal for statistics!</p> <p>Sensor replacement Lab value 017µg/l</p> <p>Return OK</p> </div>	<p>Step 2 Enter reference value ("Lab value"). When you open the Product calibration menu again, the display shown on the left appears: Enter reference value ("Lab value"). Confirm with "OK".</p>
	<div data-bbox="196 1260 543 1476"> <p>Calibration data record</p> <p>Calibration 08/12/05 15:20 Cal mode Product calibration Zero +0.030 nA Slope +059.3 nA</p> <p>End Adjust ↵</p> </div>	<p>Adjustment Press "Adjust" to take over the values determined during calibration for calculating the measured variables. See Page 48.</p>

Calibration / adjustment

Data entry of premeasured sensors - not required for ISM sensors -

Data entry of premeasured sensors

Entry of values for slope and zero point of a sensor, related to 25 °C, 1013 mbars.

During calibration the M 700 is in function check mode.

Current outputs and relay contacts behave as configured (BASE, Out, PID).

Slope = Sensor current at 100 % atmospheric oxygen, 25 °C, 1013 mbars

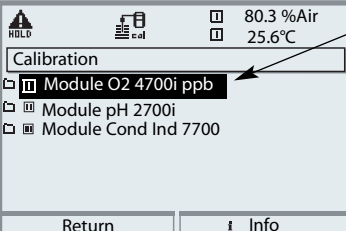
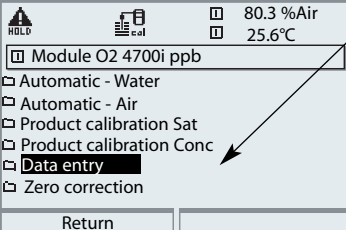
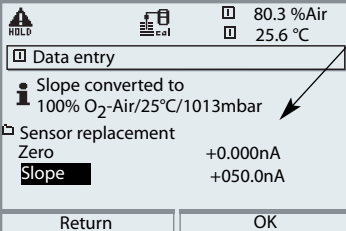
Menu	Display	Data entry premeasured sensors
	 <p>Calibration</p> <ul style="list-style-type: none"> Module O2 4700i ppb Module pH 2700i Module Cond Ind 7700 <p>Return Info</p>	<p>Select module: O₂ 4700i ppb</p> <p>The analyzer is in function check mode. Current outputs and relay contacts behave as configured (BASE, Out, PID). Confirm with enter.</p>
	 <p>Module O2 4700i ppb</p> <ul style="list-style-type: none"> Automatic - Water Automatic - Air Product calibration Sat Product calibration Conc Data entry Zero correction <p>Return</p>	<p>Select calibration method "Data entry"</p> <p>Confirm with enter.</p>
	 <p>Data entry</p> <p>Slope converted to 100% O₂-Air/25°C/1013mbar</p> <p>Sensor replacement</p> <p>Zero +0.000nA</p> <p>Slope +050.0nA</p> <p>Return OK</p>	<p>Enter the values for</p> <ul style="list-style-type: none"> Slope Zero <p>of premeasured sensor</p> <p>Confirm with "OK".</p>

Calibration / adjustment

Zero correction

Zero correction

The sensors of the InPro 6800 Series have a very low zero point current. Therefore, a zero calibration is only required for measurement of oxygen traces.

If a zero point correction is performed, the sensor should remain for at least 10 to 30 minutes in the calibration medium in order to obtain stable, non-drifting values. During zero point correction, a drift check is not performed. Zero point current of a properly functioning sensor is notably less than 0.5 % of air current.

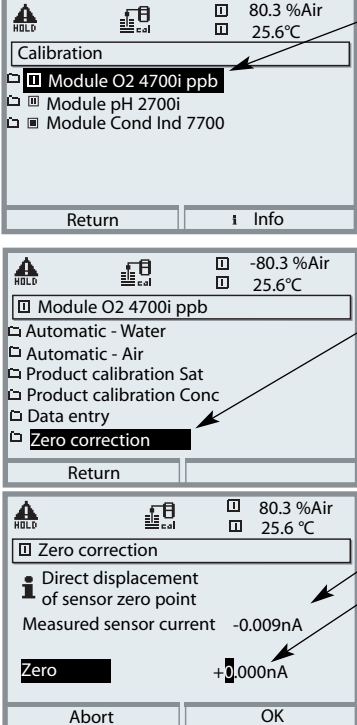
Menu	Display	Zero correction
		<p>Select module: O₂ 4700i ppb</p> <p>The analyzer is in function check mode. Current outputs and relay contacts behave as configured (BASE, Out, PID). Confirm with enter.</p> <p>Select calibration method "Zero correction"</p> <p>Confirm with enter.</p> <p>Zero point correction: Display of measured sensor current • Enter input current for zero point Confirm with "OK". Adjustment: see Page 48.</p>

Adjustment

Taking over the determined calibration parameters for calculating the measured value

Adjustment

means that the values determined by a calibration are taken over.

The values determined for zero and slope are entered in the calibration record. (Cal record can be called up in the Diagnostics menu for the module).

These values are only effective for calculating the measured variables when the calibration has been terminated with an adjustment.

A passcode ensures that an adjustment can only be performed by an authorized person (Administrator).

The Operator can check the current sensor data by a calibration and inform the Administrator when there are deviations.



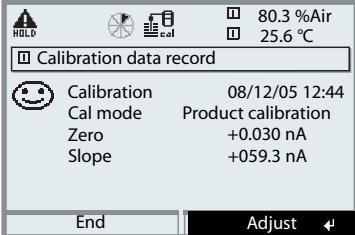
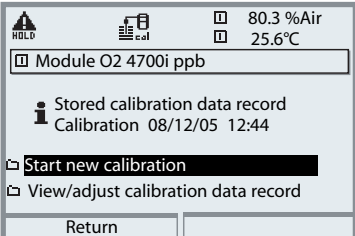

You can use the additional function SW 700-107 for granting access rights (passcodes) and for Audit Trail (data recording and backup according to FDA 21 CFR Part 11).

Menu	Display	Adjustment after calibration
	 <p>Calibration data record</p> <p>Calibration 08/12/05 12:44 Cal mode Product calibration Zero +0.030 nA Slope +059.3 nA</p> <p>End Adjust ↵</p>	<p>Administrator</p> <p>With the corresponding access rights, the device can immediately be adjusted after calibration. The calibration values are taken over for calculating the measured variables.</p>
	 <p>Module O2 4700i ppb</p> <p>Stored calibration data record Calibration 08/12/05 12:44</p> <p>Start new calibration View/adjust calibration data record</p> <p>Return</p>	<p>Operator (without Administrator rights)</p> <p>After calibration, change to measuring mode. Inform Administrator. When opening the menu (Calibration, respective module), the Administrator sees all data of the last calibration and can take over the values or perform a new calibration.</p>

Maintenance

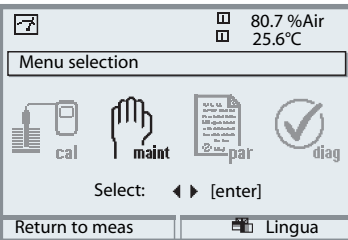
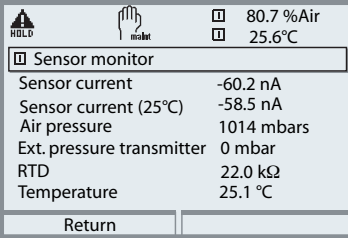
Sensor monitor, temperature probe adjustment

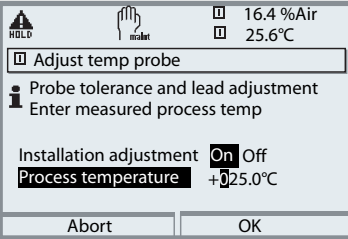
Note: Function check active (Parameter setting: BASE, Out, PID modules)

Menu	Display	Maintenance
 maint	<div data-bbox="191 363 540 603">  <p>Menu selection</p> <p>Select: ◀ ▶ [enter]</p> <p>Return to meas Lingua</p> </div> <div data-bbox="191 699 540 938">  <p>HOLO  80.7 %Air 25.6°C</p> <p>Sensor monitor</p> <p>Sensor current -60.2 nA Sensor current (25°C) -58.5 nA Air pressure 1014 mbars Ext. pressure transmitter 0 mbar RTD 22.0 kΩ Temperature 25.1 °C</p> <p>Return</p> </div> <div data-bbox="191 946 540 1185">  <p>HOLO  16.4 %Air 25.6°C</p> <p>Adjust temp probe</p> <p> Probe tolerance and lead adjustment Enter measured process temp</p> <p>Installation adjustment On Off Process temperature +025.0°C</p> <p>Abort OK</p> </div>	<p>Call up Maintenance</p> <p>From the measuring mode: Press menu key to select menu. Select Maintenance (maint) using arrow keys, confirm with enter. Enter passcode 2958 (For passcodes, see Pg 31) Then select “Module O₂”.</p> <p>Sensor monitor</p> <p>During maintenance, the sensor monitor allows validation of the sensor by immersing it in a known solution, for example, and checking the values measured.</p> <p>Temp probe adjustment</p> <p>This function allows you to compensate for the individual temperature probe tolerance and the influence of the lead resistances to increase accuracy of temperature measurement. Adjustment may only be carried out when the process temperature is precisely measured using a calibrated reference thermometer! The measurement error of the reference thermometer should be less than 0.1 °C. Adjustment without precise measurement might result in considerable deviations of the measured value display!</p>

Parameter setting: Operating levels

Viewing level, Operator level, Administrator level

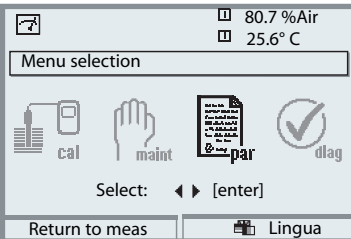
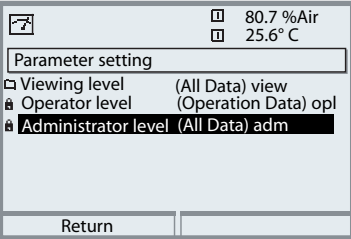
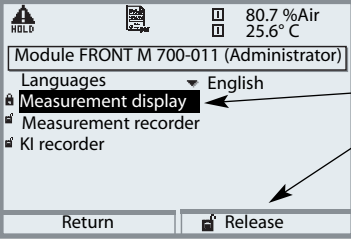
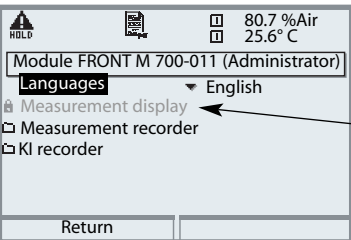

Note: Function check active (Parameter setting: BASE, Out, PID modules)

Menu	Display	Viewing level, Operator level, Administrator level
		<p>Call up parameter setting From the measuring mode: Press menu key to select menu. Select parameter setting using arrow keys, confirm with enter.</p>
		<p>Administrator level Access to all functions, also passcode setting. Releasing or blocking function for access from the Operator level.</p>
		<p>Functions which can be blocked for the Operator level are marked with the "lock" symbol. The functions are released or blocked using the softkey.</p>
		<p>Operator level Access to all functions which have been released at the Administrator level. Blocked functions are displayed in gray and cannot be edited (Fig.).</p> <p>Viewing level Display of all settings. No editing possible!</p>

Parameter setting: Lock functions

Administrator level: Enable / lock functions for Operator level

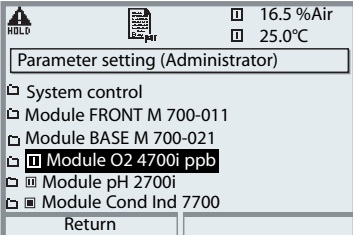
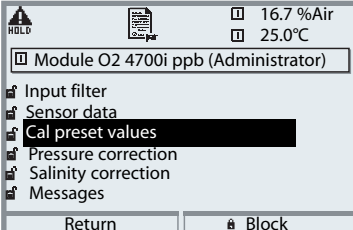
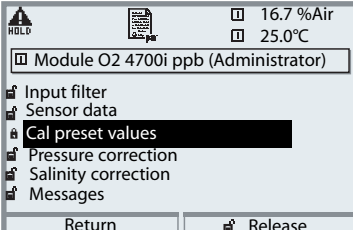
Note: Function check active (Parameter setting: BASE, Out, PID modules)

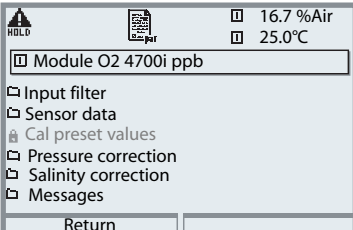
Menu	Display	Administrator level: Enable / lock functions
		<p>Example: Blocking access to the calibration adjustments (O₂ module) from the Operator level</p> <p>Call up parameter setting Select Administrator level. Enter passcode (1989). Select "Module O₂" using arrow keys, confirm with enter.</p>
		<p>Select "Cal preset values" using arrow keys. "Block" with softkey.</p>
		<p>Now, the "Cal preset values" line is marked with the "lock" icon. This function cannot be accessed from the Operator level any more. The softkey function changes to "Release".</p>
		<p>Call up parameter setting Select <u>Operator level</u>, passcode (1246). Select "Module O₂". Now, the locked function is displayed in gray and marked with the "lock" icon.</p>

Setting the module parameters

Call up parameter setting

Note: Function check active (Parameter setting: BASE, Out, PID modules)

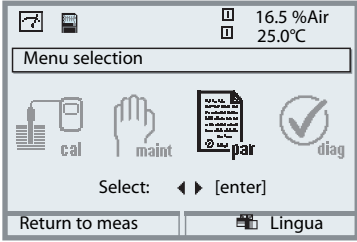
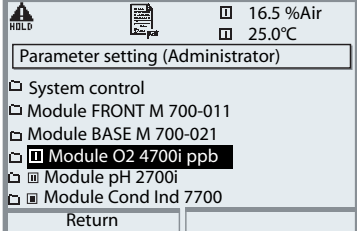
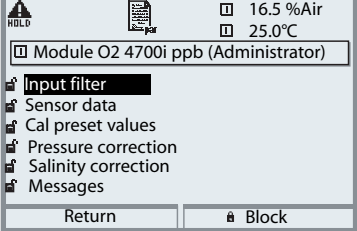
Menu	Display	Parameter setting
		<p>Call up parameter setting From the measuring mode: Press menu key to select menu. Select parameter setting using arrow keys, confirm with enter. Passcode 1989 (To change passcode: Parameter setting/System control/Passcode entry)</p>
		<p>Select "Module O₂". Confirm with enter.</p>
		<p>Select parameter using arrow keys, confirm with enter.</p>

Function check

During parameter setting the analyzer is in "function check" mode: Current outputs and relay contacts behave as configured. See instruction manuals of communication modules (e.g. Out, free download at www.mtpro.com).

Setting the sensor data parameters

Sensor data / Sensor monitoring details

Note: Function check active

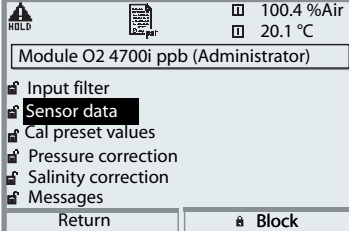
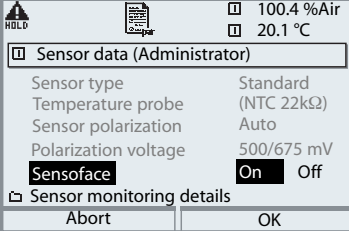
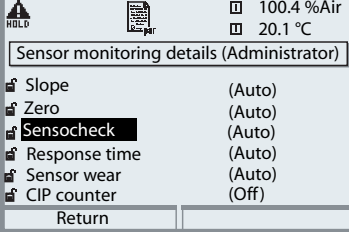
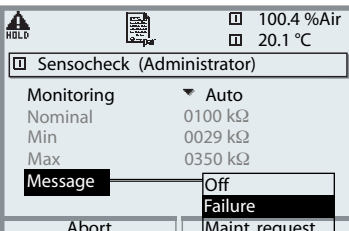
Menu	Display	Parameter selection
		<p>Sensor data (see Pg 55) Sensor data are preset depending on the sensor type. Gray display lines cannot be edited.</p>
		<p>Sensoface provides information on the sensor condition (evaluating the sensor data). Great deviations are signaled. Sensoface can be switched off.</p>
		<p>Sensor monitoring details The following parameters are monitored: Slope, zero, response time, for ISM sensors also sensor wear, CIP/SIP counter, autoclaving counter, and sensor operating time. For "Auto", the tolerance limits are displayed in gray. For "Individual", the settings can be specified by the user.</p>
		<p>ISM ISM sensors automatically provide most of the default settings. Individual settings are <u>not</u> overwritten.</p>
		<p>Message (see Pg 56)</p>

Sensoface

Sensoface is a graphic indication of the sensor condition.

Prerequisite: Sensocheck must have been activated during parameter setting.

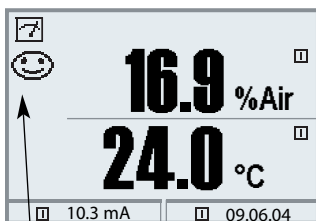

Sensocheck:

Automatic monitoring of membrane and electrolyte

The “smileys” provide information on wear and required maintenance of the sensor (“friendly” - “neutral” - “sad”).

Sensoface criteria

Parameter	Critical range	
	Sensor Type A	Sensor Type B
Slope*	< 30 nA or > 110 nA	< 225 nA or > 525 nA
Zero	< -0.6 nA or > 0.6 nA	< -1 nA or > 1 nA
Sensocheck (Ref. impedance)	0.3*R or > 3.5*R however always R < 20 kohms or > 4 Mohms, resp.	
Response time	> 600 s	
Cal timer	when 80 % expired	
Sensor wear	as specified (ISM sensors only)	

* “Slope”: Sensor current value with oxygen saturation (referred to air), 25°C, and 1013 mbars normal pressure (nA/100 %)

(The display only indicates the “nA” symbol)

From the technical point of view, it is no “slope” but a calibration point.

This value shall allow comparing the sensor with the specifications in the datasheet .

Settings of sensor data

ISM ISM sensors automatically provide most of the default settings. Individual entries are not overwritten by the ISM sensor.

Parameter	Default	Selection / Range
Input filter <ul style="list-style-type: none"> • Pulse suppression • Input filter 	Weak 010 s	Off, Weak, Medium, Strong xxx s (entry)
Sensor data <ul style="list-style-type: none"> • Measure in • Sensor type • Monitor sensor type • Temperature probe • Membrane correction • Sensor polarization • Polarization voltage • Sensoface 	Liquids Standard Off NTC 22 kΩ 01.00 Auto 0675 mV Off	Liquids, Gases (Vol%), Gases (ppm) Standard, Trace sensor, Others or defined by ISM Monitoring, Off (for ISM sensor only) NTC 30 kΩ, NTC 22 kΩ Auto, Individual xxxx mV (entry) Off, failure, maintenance request
Sensor monitoring details <ul style="list-style-type: none"> • Slope <ul style="list-style-type: none"> - Message: • Zero <ul style="list-style-type: none"> - Message: • Sensocheck <ul style="list-style-type: none"> - Message: • Response time <ul style="list-style-type: none"> - Message: 	Auto Maint. request Auto Maint. request Auto Maint. request Auto Failure	Auto, Individual Off, failure, maintenance request Auto, Individual Off, failure, maintenance request Auto, Individual Off, failure, maintenance request Auto, Individual Off, failure, maintenance request
ISM Additional sensor monitoring details for ISM sensor: Sensor wear, autoclaving counter, CIP counter, SIP counter, sensor operating time		
Cal preset values <ul style="list-style-type: none"> • Cal saturation • Cal concentration • Calibration timer <ul style="list-style-type: none"> - Monitoring - Cal timer 	%AIR mg/l Auto 0000 h	%Air µg/l, mg/l, ppb, ppm Off, Auto, Individual With ISM: Off Without ISM: xxxx h (entry)
Pressure correction <ul style="list-style-type: none"> • Pressure transmitter <ul style="list-style-type: none"> l input Start 0(4) mA End 20 mA • Pressure during meas • Pressure during cal 	Difference 4 ... 20 mA 0000 mbar 9999 mbars Air pressure Air pressure	Absolute, Difference 0 ... 20 mA / 4 ... 20 mA xxxx mbars xxxx mbars Air pressure, manual (default 1013 mbars), external Air pressure, manual (default 1013 mbars), external
Salinity correction <ul style="list-style-type: none"> • Input 	Salinity	Salinity, Chlorinity, Conductivity (00.00 g/kg or 0.000 µS/cm, as selected)

Setting the message parameters

Messages: Default settings and selection range

Note: Function check active

Parameter	Default	Selection / Range
Messages <ul style="list-style-type: none"> • Saturation %SAT • Saturation %O₂ • Concentration • Partial pressure • Temperature • Air pressure 	Limits max Off Off Off Limits max Off	Off, device limits max., variable limits* Off, device limits max., variable limits* Off, device limits max., variable limits* Off, device limits max., variable limits* Off, device limits max., variable limits* Off, device limits max., variable limits*
		*) With "Variable limits" selected, the following parameters can be edited: <ul style="list-style-type: none"> • Failure Limit Lo • Warning Limit Lo • Warning Limit Hi • Failure Limit Hi

Device limits

- Device limits max.
- Variable limits:

Maximum measurement range of device
 Range limits specified



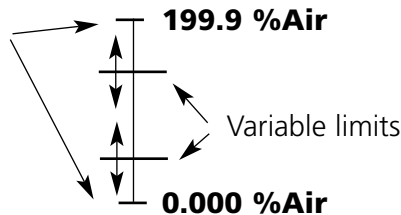

Device limits max.

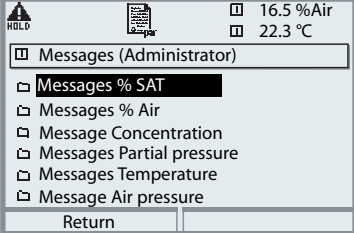
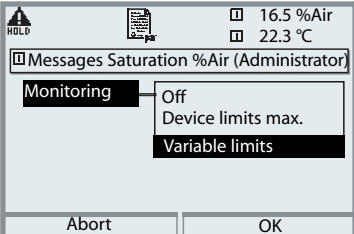
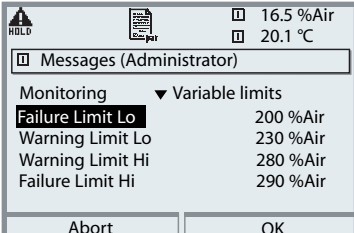

Setting the message parameters

Messages

Note: Function check active

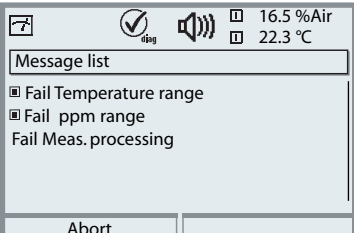
Menu	Display	Messages
	  	<p>Messages</p> <p>All measured values determined by the measuring module can generate messages.</p> <ul style="list-style-type: none"> • Device limits max.: Messages are generated when the process variable (e.g. %Air) is outside the measurement range. The "Failure" icon is displayed, the NAMUR failure contact is activated (M 700 BASE, factory setting: contact K4, N/C contact). The current outputs can signal a 22 mA message (user defined). • Variable limits: For the "failure" and "warning" messages you can define upper and lower limits for message generation. • Message icons: <ul style="list-style-type: none">  Failure (Failure limit HiHi/LoLo)  Maintenance (Warning limit Hi/Lo)
		<p>Diagnostics menu</p> <p>If the "Maintenance" or "Failure" icons are flashing in the display, you should call up the Diagnostics menu. The messages are displayed in the "Message list".</p>

Current outputs, contacts, OK inputs

Select menu: Parameter setting/Module BASE

Note: Function check active

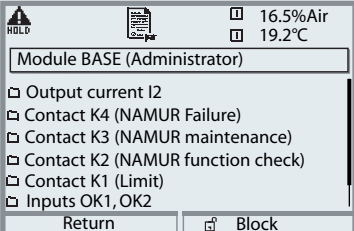
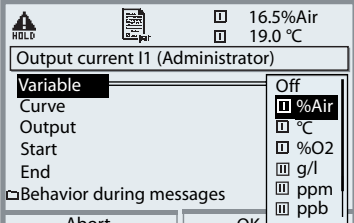
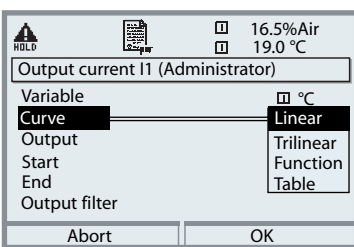
Menu	Display	Parameter setting M 700 BASE
	 <p>Module BASE (Administrator)</p> <ul style="list-style-type: none"> <input type="checkbox"/> Output current I2 <input type="checkbox"/> Contact K4 (NAMUR Failure) <input type="checkbox"/> Contact K3 (NAMUR maintenance) <input type="checkbox"/> Contact K2 (NAMUR function check) <input type="checkbox"/> Contact K1 (Limit) <input type="checkbox"/> Inputs OK1, OK2 <p>Return <input type="checkbox"/> Block</p>	<p>Configure current output</p> <ul style="list-style-type: none"> • Call up parameter setting • Enter passcode • Select "Module BASE" • Select "Output current ..."
	 <p>Output current I1 (Administrator)</p> <p>Variable</p> <ul style="list-style-type: none"> Curve Output Start End <input type="checkbox"/> Behavior during messages <p>Abort OK</p>	<ul style="list-style-type: none"> • Select measured variable
	 <p>Output current I1 (Administrator)</p> <p>Variable</p> <p>Curve</p> <ul style="list-style-type: none"> Output Start End Output filter <p>Abort OK</p>	<ul style="list-style-type: none"> • Select Curve, e.g. "Linear": The measured variable is represented by a linear output current curve. The desired range of the measured variable is specified by the values for "Start" and "End". <p>Minimum span: Pg 80</p>

Assignment of measured values: Start (4 mA) and end (20 mA)

Example 1:
Range %Air 80 ... 90

Example 2: Range %Air 85 ... 87
Advantage: Higher resolution in range of interest

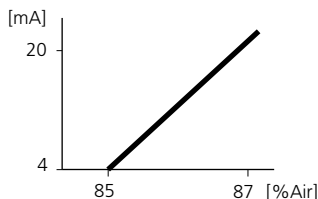
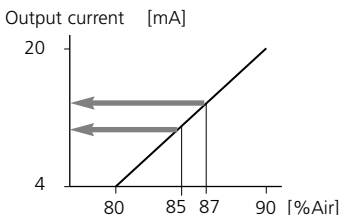

Current outputs: Current output curves

Select menu: Parameter setting/Module BASE

- **Linear characteristic**

The measured variable is represented by a linear output current curve.

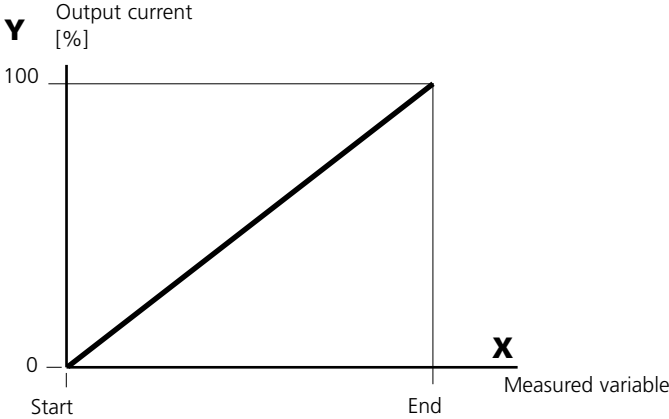

- **Trilinear characteristic**

Two additional corner points must be entered:

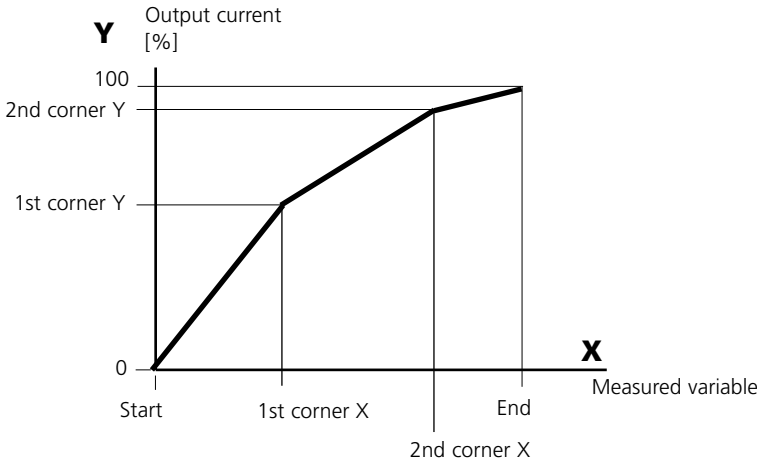

- **Note: Bilinear characteristic**

For a bilinear characteristic, identical parameters are entered for the two corner points (1st corner, 2nd corner).

• Function characteristic

Nonlinear output current characteristic: allows measurements over several decades, e.g. measuring very low values with a high resolution and high values with a low resolution.

Required: Entering a value for 50 % output current.

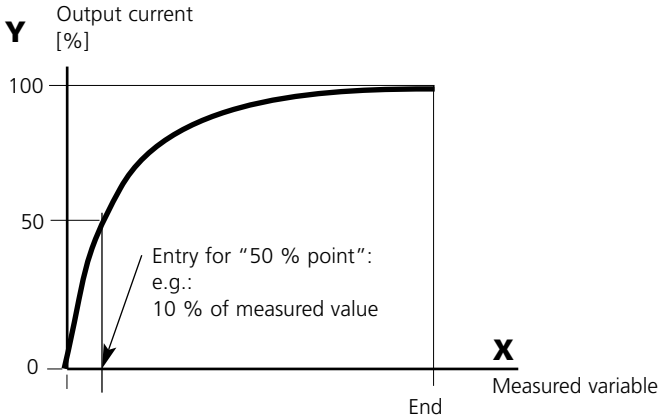

Equation

$$\text{Output current (4 to 20 mA)} = \frac{(1+K) x}{1+Kx} 16 \text{ mA} + 4 \text{ mA}$$

$$K = \frac{E + I - 2 * X50\%}{X50\% - I} \qquad x = \frac{M - I}{E - I}$$

- I: Initial value at 4 mA
- X50%: 50% value at 12 mA (output current range 4 to 20 mA)
- E: End value at 20 mA
- M: Measured value

Logarithmic output curve over one decade:

- I: 10 % of maximum value
- X50%: 31.6 % of maximum value
- E: Maximum value

Logarithmic output curve over two decades

- I: 1 % of maximum value
- X50%: 10 % of maximum value
- E: Maximum value

Output filter

Time constant

Time constant of output filter

To smoothen the current output, a low-pass filter with adjustable time constant can be switched on. When there is a jump at the input (100 %), the output level is at 63 % after the time constant has been reached. The time constant can be set from 0 to 120 sec. If the time constant is set to 0 s, the current output follows the input.

Note:

The filter only acts on the current output and the current value of the secondary display, not on the measurement display, the limit values, or the controller!

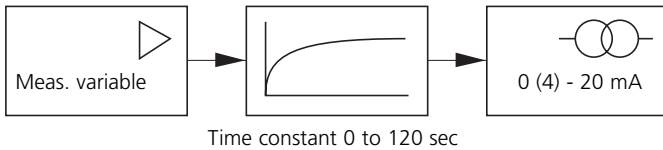

NAMUR signals: Current outputs

Behavior during messages: Function check, 22 mA signal

Behavior during messages

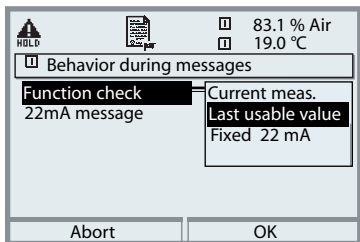

Depending on the parameter setting ("Messages"), the current outputs switch to:

- Currently measured value
- Last measured value (HOLD function)
- Fixed value (22 mA)

In the case of a fault a 22 mA signal can be generated for the selected process variable (1st primary value).

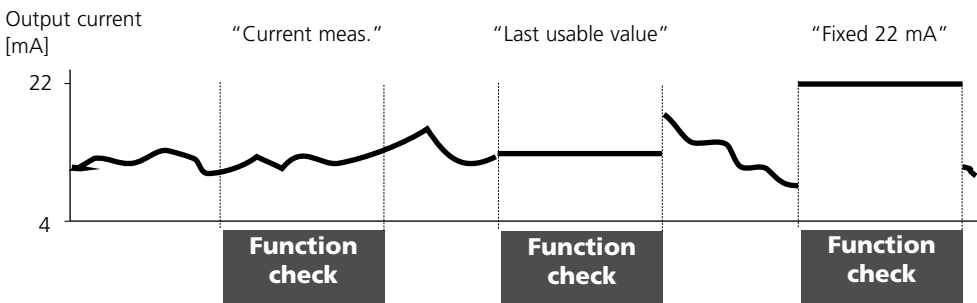

Message when the current range is exceeded

As delivered, the "Maintenance request" (Warn) message is generated when the current range is exceeded ($< 3.8 \text{ mA}$ or $> 20.5 \text{ mA}$).

This setting can be changed in the Parameter setting menu of the respective measuring module at "Messages".

To generate a "Failure" message, the limit value monitoring must be set to "Variable limits":

Parameter setting - \langle measuring module \rangle - Messages - Variable limits - Failure limit ...

Enter the same values for the failure limits as for the current output:

Parameter setting - Module BASE - Output current - Variable Start / End.

NAMUR signals: Switching contacts

Failure, maintenance request, function check

As delivered, the floating relay outputs of the M 700 BASE are assigned to the NAMUR signals:

- Failure Contact K4, Normally closed contact (signaling current failure)
- Maint. request Contact K3, normally open contact
- Function check Contact K2, normally open contact

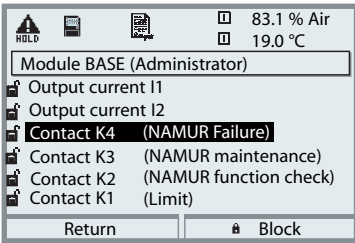

NAMUR signals: Factory setting of contacts

- Select parameter setting
- Administrator level
- Select "Module BASE" (Fig.)

You can define a delay time for "Maintenance request" and "Failure", resp. If an alarm message is released, the contact will only be activated after expiry of this delay time.

Failure is active

when a value has exceeded (or fallen below, resp.) a preset "Failure Limit Hi" or "Failure Limit Lo", when the measured value is out of range or in the event of other failure messages. That means that the equipment no longer operates properly or that process parameters have reached a critical value. Failure is disabled during function check.

Maintenance request is active

when a value has exceeded (or fallen below, resp.) a preset "Warning Limit Hi" or "Warning Limit Lo", or when other warning messages have been activated. That means that the equipment is still operating properly but should be serviced, or that process parameters have reached a value requiring intervention.

Warning is disabled during "Function check".

Function check is active:

- during calibration
- during maintenance (current source, meas. point maintenance)
- during parameter setting at the Operator level and the Administrator level
- during an automatic rinsing cycle.

Relay contacts: Protective wiring

Protective wiring of relay contacts

Relay contacts are subjected to electrical erosion. Especially with inductive and capacitive loads, the service life of the contacts will be reduced. For suppression of sparks and arcing, components such as RC combinations, nonlinear resistors, series resistors and diodes should be used.

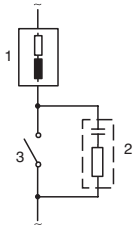
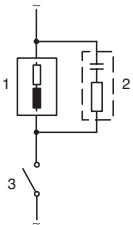

Typical AC applications with inductive load

1 Load

2 RC combination, e.g. RIFA PMR 209

Typical RC combinations

e.g.:

Capacitor 0.1 μ F,

Resistor 100 ohms / 1 W

3 Contact

Warning!

Make sure that the maximum ratings of the relay contacts are not exceeded even during switching!

Information concerning relay contacts

As delivered, the relay contacts are suitable for low signal currents (down to approx. 1 mA). If currents above approx. 100 mA are switched, the gold plating is destroyed during the switching process. After that, the contacts will not reliably switch low currents.

Relay contacts

Parameter setting/Module BASE/Relay contacts

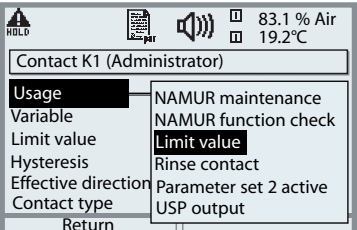
Menu	Display	Setting the relay contacts
		<p>Relay contacts, usage</p> <ul style="list-style-type: none"> • Call up parameter setting • Enter passcode • Select "Module BASE" • Select "Contact ..." • "Usage" (Fig.)

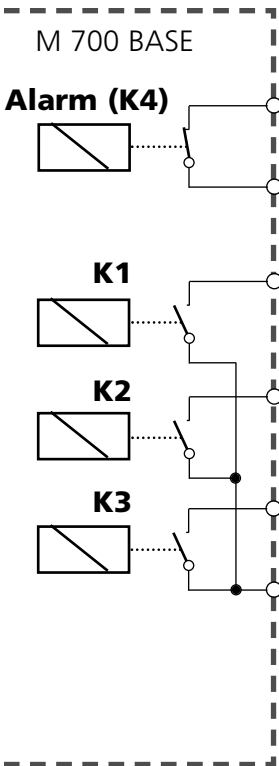

The M 700 BASE provides 4 relay contacts (max. AC/DC rating 30 V / 3 A each). Contact K4 is provided for failure message. The switching behavior (normally open or normally closed), as well as a switch-on or switch-off delay can be defined.

Default settings of the user-definable relay contacts of the M 700 BASE:

- K3: NAMUR maintenance request
- K2: NAMUR function check
- K1: Limit value

The contact assignment K1 - K3 is user defined ("Usage"):

- NAMUR maintenance request
- NAMUR function check
- Limit value
- Rinse contact
- Parameter set 2 active
- USP output (Cond module only)

Contact assignment: See terminal plate of M 700 BASE

Limit value, hysteresis, contact type

Parameter setting/Module BASE/Relay contacts/Usage

Menu	Display	Usage as limit value
		Relay output: Limit value <ul style="list-style-type: none"> • Call up parameter setting • Enter passcode • Select "Module BASE" • Select "Contact ..." • "Usage: Limit" (Fig.)

Limit value Effective direction min

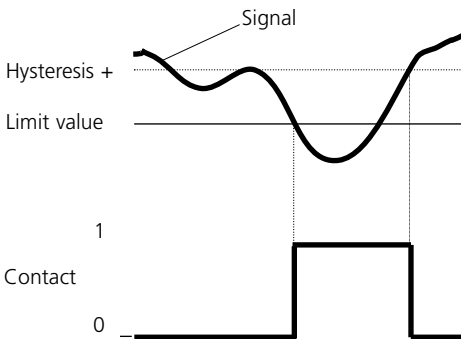

Limit value Effective direction max

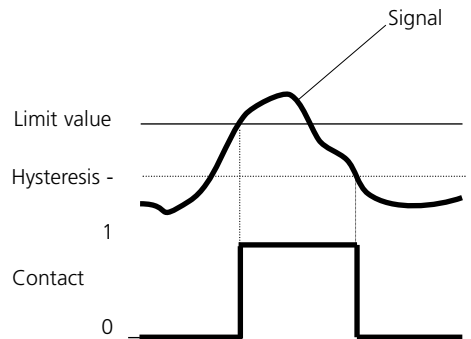

Icons in the measurement display:

Measured value exceeds limit: Measured value falls below limit:

Hysteresis

Tolerance band around the limit value, within which the contact is not actuated. Serves to obtain appropriate switching behavior at the output and suppress slight fluctuations of the measured variable (Fig.)

Contact type

Specifies whether the active contact is closed (N/O) or open (N/C).

OK1, OK2 inputs: Specify level

Parameter setting/Module BASE/Inputs OK1, OK2

Note: Function check active

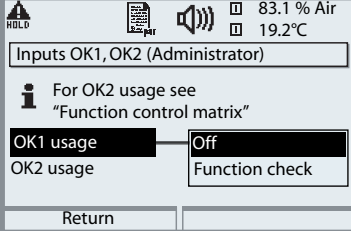
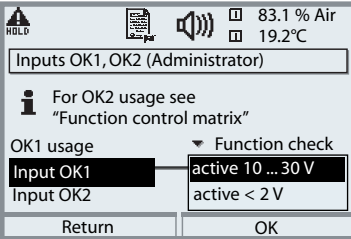
Menu	Display	Setting the OK inputs
		<p>OK1 usage</p> <ul style="list-style-type: none"> • Call up parameter setting • Enter passcode • Select "Module BASE" • Select "Inputs OK1/OK2" • Select "OK1 usage"
		<p>OK1/OK2 switching level</p> <ul style="list-style-type: none"> • Call up parameter setting • Enter passcode • Select "Module BASE" • Select "Inputs OK1/OK2" • Specify active switching level

The M 700 BASE provides 2 digital inputs (OK1, OK2). The following functions (depending on the parameter setting) can be started via a control signal:

- OK1: "Off" or "Function check"
- OK2: Select: System control / Function control matrix. ("Off", "Parameter set A/B", "Start KI recorder")

The switching level for the control signal must be specified:
(active 10...30 V or active > 2 V).

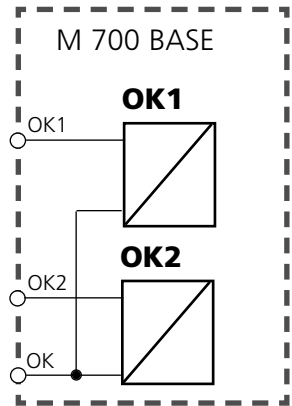

Contact assignment: See terminal plate of M 700 BASE

Switch parameter sets via OK2

Parameter setting / System control / Function control matrix

Note: Function check active

Parameter sets

2 complete parameter sets (A, B) can be stored in the analyzer.

You can switch between the parameter sets using the OK2 input.

The currently activated set can be signaled by a relay contact.

An icon in the measurement display shows which parameter set is active:

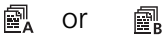

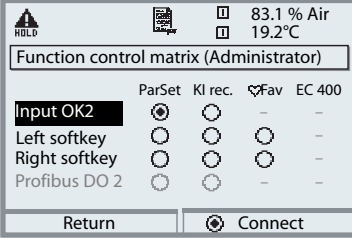
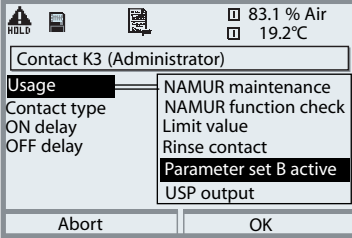
Menu	Display	Parameter sets
		<p>Select parameter set (A, B) via input OK2</p> <ul style="list-style-type: none"> • Call up parameter setting • System control • Function control matrix • Select "OK2" • Connect "Parameter set A/B"
		<p>Signaling active parameter set via relay contact</p> <ul style="list-style-type: none"> • Call up parameter setting • Select "Module BASE" • Select contact • Usage: "Parameter set ...".

Note

The selection has no effect when working on SmartMedia card with SW 700-102.

Calculation Blocks

Select menu: Parameter setting/System control/Calculation Blocks
Calculation of new variables from measured variables

Calculation Blocks

Two measuring modules with all their measured values serve as input for the calculation block. In addition, the general device status (NAMUR signals) is taken into account. The analyzer calculates the differences between the existing values.

These output variables are then available in the system and can be assigned to the outputs (current, limit values, display ...)

Functionality of measuring module

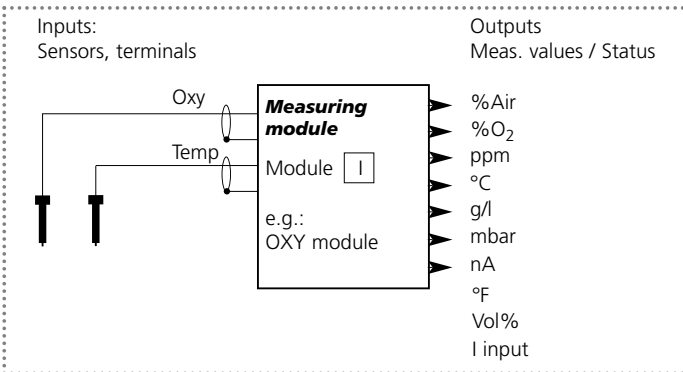

Functionality of Calculation Block

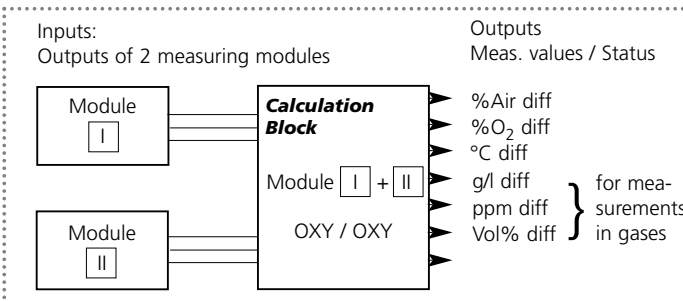

Activating a Calculation Block

Select menu: Parameter setting/System control/Calculation Blocks
 Combining measuring modules to Calculation Blocks

Combining measuring modules

With three measuring modules the following Calculation Block combinations are possible:  +  ,  +  ,  + 

Two Calculation Blocks can be activated.

All current outputs can be set to output the new process variables formed by the Calculation Blocks.

All new process variables can be displayed as primary or as secondary value.

Controller functions are not supported.

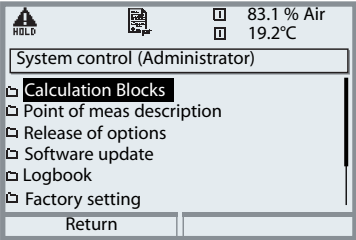
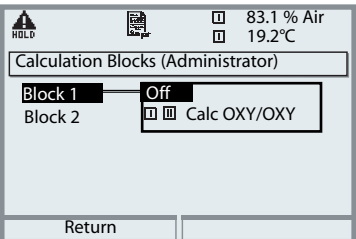
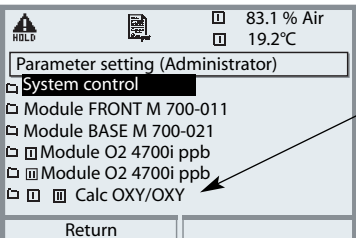
Menu	Display	Activating Calculation Blocks
		<p>Calculation Blocks</p> <ul style="list-style-type: none"> • Call up parameter setting • System control • Select “Calculation Blocks”
		<ul style="list-style-type: none"> • Depending on modules installed, the possible combinations for Calculation Blocks are offered
		<p>During parameter setting the Calculation Blocks are displayed like modules.</p>

Configuring a Calculation Block

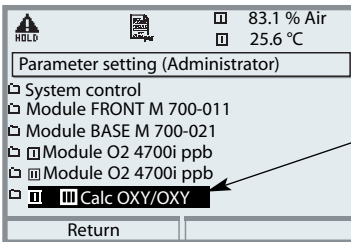
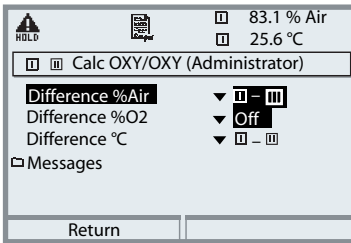
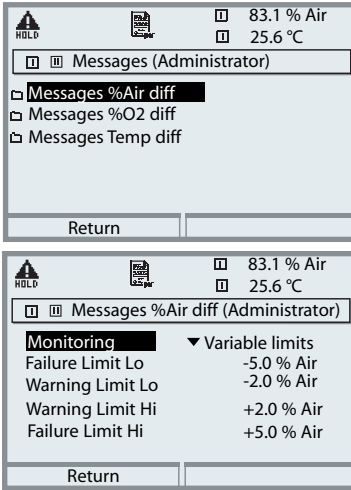

Select menu: Parameter setting/System control/Select Calculation Block
 Setting the process variable to be calculated

Menu	Display	Configuring a Calculation Block
		<p>Select Calculation Block</p> <ul style="list-style-type: none"> • Call up parameter setting • System control • Select module
		<ul style="list-style-type: none"> • Depending on modules installed, the possible combinations for Calculation Blocks are offered
		<p>Messages</p> <p>You can activate messages for the selected variables.</p> <p>Variables which have been set as "Off" cannot be processed further.</p> <p>The measured values which shall release a message are set using the arrow keys (left/right: select position, up/down: edit number). Confirm with enter.</p>

Diagnostics functions

General status information of the measuring system

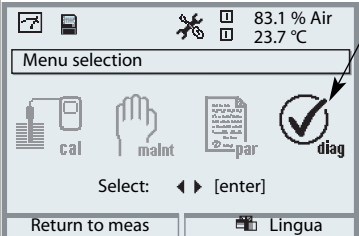

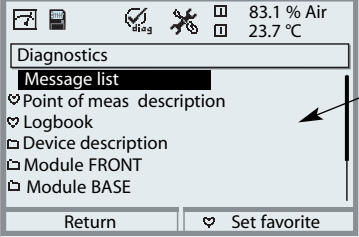
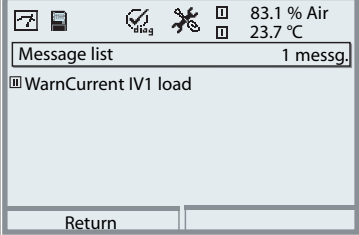
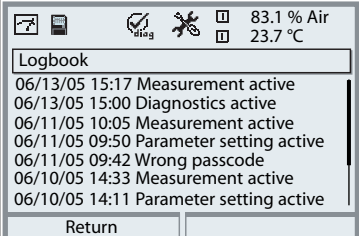
Select menu: Diagnostics

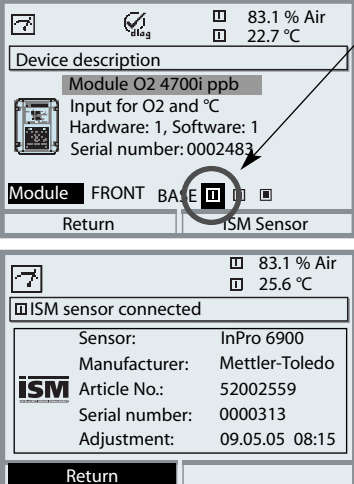
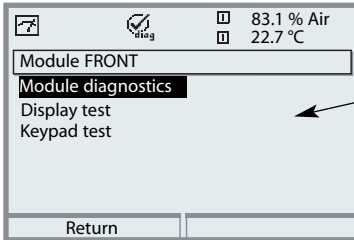
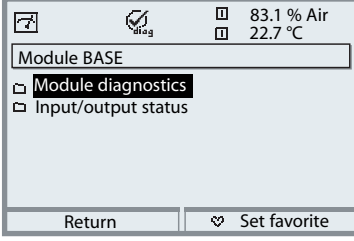
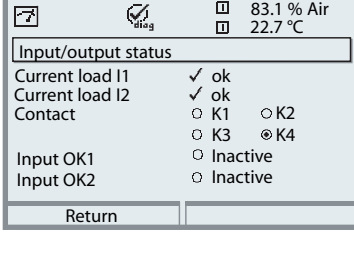
Menu	Display	Diagnostics functions
		<p>Call up diagnostics</p> <p>From the measuring mode: Press menu key to select menu. Select diagnostics using arrow keys, confirm with enter.</p>
		<p>The "Diagnostics" menu gives an overview of all functions available. Functions which have been set as "Favorite" can be directly accessed from the measuring mode (see Pg 23).</p>
		<p>Message list</p> <p>Shows the currently activated warning or failure messages in plain text.</p>
		<p>Logbook</p> <p>Shows the last 50 events with date and time, e.g. calibrations, warning and failure messages, power failure etc. This permits quality management documentation to ISO 9000.</p> <p>Extended logbook: SmartMedia card (SW 700-104)</p>

Menu	Display	Diagnostics functions
		<p>Device description</p> <p>Select module using arrow keys: Provides information about all modules installed: Function, serial number, hardware and software version and device options.</p> <p>ISM sensor description*</p> <p>Information on sensor type, manufacturer, article no., serial number, date of last adjustment</p> <p>* only with valid ISM sensor connected</p>
		<p>Module FRONT</p> <p>The module the display and keypad control. Test possibilities:</p> <ul style="list-style-type: none"> • Module diagnostics • Display test • Keypad test
		<p>Module BASE</p> <p>The module generates the standard output signals. Test possibilities:</p> <ul style="list-style-type: none"> • Module diagnostics • Input/output status
		<p>Example: Module BASE, input/output status.</p>

Module diagnostics

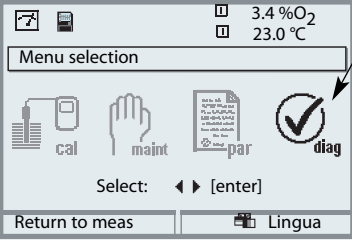
Module diagnostics, sensor monitor, cal record, sensor network diagram, statistics

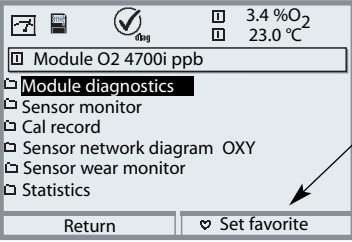
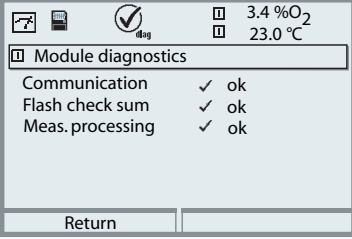
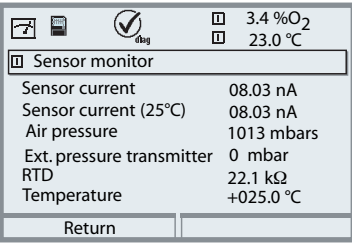
Menu	Display	Module diagnostics, sensor monitor
		<p>Call up diagnostics</p> <p>From the measuring mode: Press menu key to select menu. Select diagnostics using arrow keys, confirm with enter. Then select "Module O₂".</p>
		<p>The Diagnostics menu gives an overview of all diagnostics functions available.</p> <p><u>Messages set as "Favorite"</u> can be called up directly from the measuring mode using a softkey.</p> <p>To configure: Parameter setting / System control / Function control matrix.</p>
		<p>Module diagnostics</p> <p>Function test of internal components:</p> <ul style="list-style-type: none"> - Internal device communication - Check of firmware (module) - Factory settings, measured value processing
		<p>Sensor monitor</p> <p>Shows the current directly measured by the sensor, the barometric pressure, and temperature. Important function for diagnostics and validation!</p>

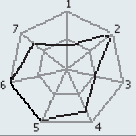
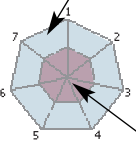
Menu	Display	Cal record, network diagram, wear monitor, statistics												
 diag	<div style="border: 1px solid black; padding: 5px;"> <div style="display: flex; justify-content: space-between;"> 3.4 %O₂ 23.0 °C </div> <div style="border-bottom: 1px solid black; padding: 5px 5px 0 5px;"> Cal record </div> <table style="width: 100%; border-collapse: collapse;"> <tr><td>Last calibration</td><td>07/04/05 10:29</td></tr> <tr><td>Sensor model</td><td>InPro6900</td></tr> <tr><td>Serial number</td><td>00150313</td></tr> <tr><td>Cal mode</td><td>Automatic - Water</td></tr> <tr><td>Zero</td><td>+0.010 nA</td></tr> <tr><td>Slope</td><td>-050.0 nA</td></tr> </table> <div style="display: flex; justify-content: space-between; border-top: 1px solid black; padding-top: 5px;"> Return </div> </div>	Last calibration	07/04/05 10:29	Sensor model	InPro6900	Serial number	00150313	Cal mode	Automatic - Water	Zero	+0.010 nA	Slope	-050.0 nA	<p>Cal record</p> <p>Data of last adjustment/calibration, suitable for documentation to ISO 9000 and GLP/GMP (Date, time, calibration method, sensor zero and slope, rel. humidity for calibration in air)</p>
Last calibration	07/04/05 10:29													
Sensor model	InPro6900													
Serial number	00150313													
Cal mode	Automatic - Water													
Zero	+0.010 nA													
Slope	-050.0 nA													
	<div style="border: 1px solid black; padding: 5px;"> <div style="display: flex; justify-content: space-between;"> 3.4 %O₂ 23.0 °C </div> <div style="border-bottom: 1px solid black; padding: 5px 5px 0 5px;"> Sensor network diagram </div> <div style="display: flex; align-items: center;">  <div style="margin-left: 10px;"> <ul style="list-style-type: none"> 1 - Slope 2 - Zero 3 - Sensocheck 4 - Not in use 5 - Response time 6 - Cal timer 7 - Sensor wear </div> </div> <div style="display: flex; justify-content: space-between; border-top: 1px solid black; padding-top: 5px;"> Return Info </div> </div> <p style="margin-top: 10px;">"Outer circle" Value within tolerance</p>  <p style="margin-left: 20px;">Critical range – "inner circle" Value out of tolerance The tolerance can be modified as required!</p>	<p>Sensor network diagram</p> <p>The measured values are continuously monitored during the measurement process. The sensor network diagram provides at-a-glance information about critical parameters. If a tolerance limit has been exceeded, the respective parameter is flashing. Values in gray: Monitoring switched off. To switch on, refer to "Info".</p>												
	<div style="border: 1px solid black; padding: 5px;"> <div style="display: flex; justify-content: space-between;"> 3.4 %O₂ 23.0 °C </div> <div style="border-bottom: 1px solid black; padding: 5px 5px 0 5px;"> Sensor wear monitor </div> <table style="width: 100%; border-collapse: collapse;"> <tr><td>Membrane wear</td><td><div style="width: 80%; height: 10px; background-color: black;"></div></td></tr> <tr><td>Inner body wear</td><td><div style="width: 20%; height: 10px; background-color: black;"></div></td></tr> <tr><td>Sensor operating time</td><td>312 d</td></tr> <tr><td>Autoclaving cycles</td><td>1 of 2</td></tr> <tr><td>CIP cycles</td><td>1 of 5</td></tr> <tr><td>Max. temperature</td><td>120 °C 10/01/05</td></tr> </table> <div style="display: flex; justify-content: space-between; border-top: 1px solid black; padding-top: 5px;"> Return </div> </div>	Membrane wear	<div style="width: 80%; height: 10px; background-color: black;"></div>	Inner body wear	<div style="width: 20%; height: 10px; background-color: black;"></div>	Sensor operating time	312 d	Autoclaving cycles	1 of 2	CIP cycles	1 of 5	Max. temperature	120 °C 10/01/05	<p>Sensor wear monitor (ISM only)</p> <p>In addition to the current sensor wear, the sensor operating time, the number of executed autoclaving, CIP, or SIP cycles, as well as the max. measured temperature with date can be seen.</p>
Membrane wear	<div style="width: 80%; height: 10px; background-color: black;"></div>													
Inner body wear	<div style="width: 20%; height: 10px; background-color: black;"></div>													
Sensor operating time	312 d													
Autoclaving cycles	1 of 2													
CIP cycles	1 of 5													
Max. temperature	120 °C 10/01/05													
	<div style="border: 1px solid black; padding: 5px;"> <div style="display: flex; justify-content: space-between;"> 3.4 %O₂ 22.7 °C </div> <div style="border-bottom: 1px solid black; padding: 5px 5px 0 5px;"> Statistics </div> <table style="width: 100%; border-collapse: collapse;"> <tr><td>Zero</td><td></td></tr> <tr><td>1st Cal</td><td>+0.000nA 07/01/05 10:20</td></tr> <tr><td>Diff</td><td>+0.010nA 07/11/05 12:34</td></tr> <tr><td>Diff</td><td>-0.020nA 07/12/05 11:35</td></tr> <tr><td>Diff</td><td>+0.900nA 07/18/05 10:42</td></tr> <tr><td>Slope</td><td></td></tr> </table> <div style="display: flex; justify-content: space-between; border-top: 1px solid black; padding-top: 5px;"> Return </div> </div>	Zero		1st Cal	+0.000nA 07/01/05 10:20	Diff	+0.010nA 07/11/05 12:34	Diff	-0.020nA 07/12/05 11:35	Diff	+0.900nA 07/18/05 10:42	Slope		<p>Statistics</p> <p>Indication of sensor data for the First Calibration and the last 3 calibrations. (Date and time of First Calibration, sensor zero and slope, temperature, pressure, response time)</p>
Zero														
1st Cal	+0.000nA 07/01/05 10:20													
Diff	+0.010nA 07/11/05 12:34													
Diff	-0.020nA 07/12/05 11:35													
Diff	+0.900nA 07/18/05 10:42													
Slope														

Specifications

O₂ 4700i(X) ppb module

Specifications M 700 O₂ 4700i(X) ppb

Oxy input

(Ex ia IIC)

Measuring current

Saturation (-10 ... 80 °C)

Measurement error**

Concentration (-10 ... 80 °C)

Measurement error**

Polarization voltage

Partial pressure

Barometric pressure

Manual

External

Salinity correction

Adm. guard current

Ref voltage

Trace measurement with the Mettler-Toledo

sensors of the InPro 6800 Series

control and evaluation of ISM sensors

0 ... 1800 nA, resolution 30 pA

0.0 ... 199.9 / 200 ... 600 %Air

0.0 ... 29.9 / 30 ... 120 % O₂

< 0.5 % meas.val. + 0.1 nA + 0.005 nA/K

0000 ... 9999 µg/l (overrange during cal. up to 19.99 mg/l)

0000 ... 9999 ppb (overrange during cal. up to 19.99 ppm)

< 0.5 % meas.val. + 0.05 mg/l or 0.05 ppm

0 ... -1000 mV, default -675 mV (resolution 5 mV)

0 ... 5000 mbars

700 ... 1100 mbars

0 ... 9999 mbars

0 ... 9999 mbars (through current input 0(4) ... 20 mA input)

0.0 ... 45.0 g/kg

≤ 20 µA

± 500 mV (voltage across ref connection and anode)

Measurement in gases

0 ... 2000 mbars

0 ... 9999 ppm

0.00 ... 29.9 / 30.0 120.0 Vol% (display only)

0.00 ... 120.0 Vol% (current, limit values) (1 Vol% = 10,000 ppm)

Current start / end

As desired within range

Calibration methods

Automatic - Air

- with the following default settings: rH = 50 %, p 0 measured

barometric pressure, cal medium air (dry air = 20.95 Vol%)

Product calibration (select ppm or Vol%)

Data entry

Zero correction

ISM

Intelligent Sensor Management

Plug & Measure

Display of sensor data: Manufacturer, serial number,

calibration record, load matrix a.o.

Enhanced diagnostic capabilities

Specifications

O₂ 4700i(X) ppb module

Sensor monitoring *

Sensoface Sensor network diagram

Sensor monitor

Wear monitor

Calibration *

Calibration record/statistics

Temperature input

(EEx ia IIC)

Temperature probe *

Range

Resolution

Measurement error**

Input

Pressure range

Current range

Resolution

KI recorder

(Additional function SW700-001)

Sensocheck Monitoring of membrane and electrolyte

Provides information on the sensor condition:
Zero, slope, response time, cal timer, Sensocheck, wear (ISM)

Direct display of measured values from sensor for validation
sensor current / air pressure / temperature / I input

Display of wear parameters
sensor wear / sensor operating time / autoclaving cycles /
CIP cycles / CIP cycles / max. temperature

Operating modes

- Automatic calibration in air-saturated water
- Automatic calibration in air
- Product calibration: Saturation
- Product calibration: Concentration
- Data entry zero/slope
- Zero point correction

Recording of:

Zero, slope, response time, calibration method,
with date and time of the last three calibrations and the
First Calibration

NTC 22 k Ω / NTC 30 k Ω

2-wire connection, adjustable

-20 ... +150 °C (-4 ... 302°F)

0.1 °C

0.2 % meas.val. + 0.5 K

0(4) ... 20 mA for absolute or differential pressure transmitter

0 ... 9999 mbars

0(4) ... 20 mA / 50 ohms

Start / end user-defined within pressure range

< 1%

Adaptive representation of a process sequence with
monitoring and signaling of critical parameters

Specifications

O₂ 4700i(X) ppb module

General data

Explosion protection

(Module O₂ 4700iX ppb only)

See rating plate: KEMA 04 ATEX 2056

ATEX: II 2 (1) GD EEx ib [ia] IIC T4 T 70 °C

FM: IS, Class I, Div 1, Group A, B, C, D T4
NI, Class I, Div 2, Group A, B, C, D T4

EMC

Emitted interference
Immunity to interference

USA:

NAMUR NE 21 and
EN 61326 VDE 0843 Part 20 /01.98
EN 61326/A1 VDE 0843 Part 20/A1 /05.99
FCC Rules Part 15/B Class A
Class B
Industry

Lightning protection

EN 61000-4-5, Installation Class 2

Nominal operating conditions

Ambient temperature -20 to +55 °C (Ex: max. +50 °C)
Relative humidity 10 to 95 % not condensing

Transport/ Storage temperature

-20 ... +70 °C

Screw clamp connection

Single wires and flexible leads up to 2.5 mm² (AWG 14)

* User-defined

** To IEC 746 Part 1, at nominal operating conditions, ± 1 count, plus sensor error

Appendix:

Minimum measuring spans for current outputs

The O₂ 4700i(X) ppb module is a measuring module. It does not provide current outputs. Current outputs are provided by the M 700 BASE (basic device) or by communication modules (e.g. Out, PID). The corresponding parameters must be set there.

The **minimum current span** shall prevent that the resolution limit of the measurement technology (± 1 count) is seen in the current.

O₂ 4700i(X) ppb module

%Air	10.0
%O ₂	2.0
°C	10.0
mbar	20.0 (barometric pressure)
nA	10 % min. 1.00 nA
mg/l	10 % min. 20.0 µg/l
ppm	10 % min. 20.0 ppb
mbar	20.0 (partial pressure)
Vol%	2.0
ppm	1000
°F	10.0

Calculation Block OXY/OXY

Diff %Air	10.0
Diff %O ₂	2.0
Diff mg/l	10 % min. 20.0 µg/l
Diff ppm	10 % min. 20.0 ppb
Diff °C	10.0
Diff Vol%	2.0
Diff ppm	1000

High CO₂ compensation (SW 700-011)

Application-specific additional function for breweries

This additional function simplifies parameter setting since all steps not required for dissolved oxygen measurement in carbonated beverages are omitted. It simultaneously acts on all installed O₂ modules (module software version 2.2 and higher).

Function principle:

The following processes are automated by the additional function, i.e. all parameters required for the respective program step are set automatically.

During the filling process, for example, it must be ensured that as little oxygen as possible is dissolved in the beer to extend its shelf life.

During oxygen trace measurement the sensor is operated with a very low polarization voltage (-500 mV). This results in low cross-sensitivity to CO₂.

For a calibration in air, this polarization voltage is too low.

It must be set to -675 mV and afterwards be reduced again to -500 mV for measuring in the trace range.

Be sure to wait long enough for the sensor to stabilize.

Opening and closing of valves causes pressure variations in the beer pipes which momentarily falsify the O₂ signal. Therefore the input signal must be attenuated correspondingly to suppress transient interferences.

Overview of parameter setting

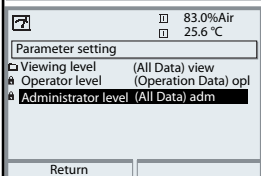
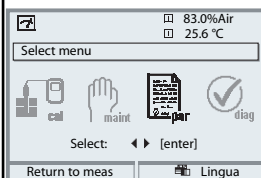

Parameter setting

Activated from measuring mode: Press **menu** key to select menu.

Select parameter setting using arrow keys, confirm with **enter**.

Administrator level

Access to all functions, also passcode setting. Releasing or blocking function for access from the Operator level.

Operator level

Access to all functions which have been released at the Administrator level. Blocked functions are displayed in gray and cannot be edited.

Viewing level

Only display, no editing possible!

System control

Memory card (Option)

- Register Logbook
- Register recorder
- Decimal separator
- Card full
- Formatting

Menu only appears with SmartMedia Card inserted.

Make sure that it is a memory card,

Commercially available SmartMedia cards must be formatted before they can be used as memory card.

Copy configuration

The complete configuration of an analyzer can be written on a SmartMedia card. This allows transferring all device settings - except options - to other devices with identical equipment.

Parameter sets

- Save
- Load

2 parameter sets (A,B) are available in the analyzer.

The currently active parameter set is read on the display.

Parameter sets contain all settings except:

Sensor type, Options, System control settings

Up to 5 parameter sets (1, 2, 3, 4, 5) are available when a SmartMedia card (Option) is used.

Function control matrix

- Input OK2
- Left softkey
- Right softkey

Selecting the control element for the following functions:

- Parameter set selection

- KI recorder (Start/Stop)

- Favorites menu (selected diagnostics functions)

- EC 400 (fully automated probe controller)

Time/date

Selecting the display format, entry

Point of meas description

Can be called up in the diagnostics menu.

Release of options

A TAN is required to release an Option.

Software update

Software update from SmartMedia card (update card)

Logbook

Selecting events to be recorded

Factory setting

Resetting all parameters to factory setting

Passcode entry

Editing the passcodes

Parameter setting menu



Display settings: M 700 FRONT

Languages

Measurement display

- Main display
- Display format
- Viewing angle

Representation of measured values on the display:

- Selecting the number of primary values displayed (one or two)
- Decimal places

Measurement recorder

- Time base
- Zoom function
- Min/Max display

Option. 2-channel, selection of process variable, start and end

KI recorder

Option. See more detailed "Options" manual

Signal outputs and inputs, contacts: M 700 BASE

Output current I1, I2

- Process variable
- Characteristic
- Output (0/4 - 20 mA)
- Output filter
- Behavior during messages
 - Function check
 - Currently meas. value
 - Last meas. value
 - Fixed 22 mA
 - 22 mA message

2 current outputs, separately adjustable

Behavior during messages

Output current

[mA]

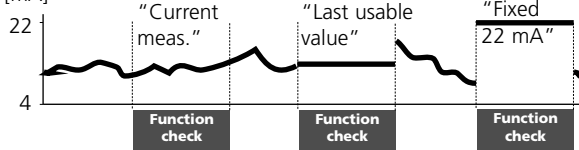

Contact K4

- Contact type
- ON delay
- OFF delay

NAMUR Failure

Contacts K3, K2, K1

- Usage
 - Maintenance request
 - Function check
 - Limit value (adjustable)
 - Rinse contact (adjustable)
 - Parameter set B active
 - USP output
 - KI recorder active
- Contact type
- ON delay
- OFF delay

Factory setting:

K3: Maintenance request, K2: Function check, K1: Limit value

- Variable, limit value, hysteresis, effective direction, ...

- Rinsing interval, lead times, rinse duration, logbook entry, ...

Inputs OK1, OK2

- OK1 usage
 - Signal level

Optocoupler - signal inputs

Off, function check

active level switchable from 10 to 30 V or < 2 V, resp.

For OK2 see System control/Function control matrix

Parameter setting menu



O₂ 4700i(X) ppb module

Input filter

Sensor data

Representation of measured values on the display:

- Measure in
- Sensor type - Select (automatic for ISM)
- Monitor sensor type - (for ISM sensor only)
- Temperature probe
- Membrane correction
- Sensor polarization
- Polarization voltage
- Sensoface
- Sensor monitoring details
- Slope
- Zero
- Sensocheck
- Response time

Additional sensor monitoring details for ISM sensor:

- Sensor wear
- CIP counter
- SIP counter
- Autoclaving counter
- Sensor operating time

Cal preset values

- Cal saturation
- Cal concentration
 - mg/l
 - µg/l
 - ppm
 - ppb
- Calibration timer

Pressure correction

- Ext. pressure transmitter
- Pressure during meas
- Pressure during cal

Salinity correction

- Input
 - Salinity
 - Chlorinity
 - Conductivity
- Salinity

Messages

- Saturation %Air
- Saturation %O₂
- Concentration
- Partial pressure
- Temperature
- Air pressure

Devaluate ISM sensor

Calibration menu



O₂ 4700i(X) ppb module

Automatic - Water
 Automatic - Air
 Product calibration Sat
 Product calibration Conc
 Data entry
 Zero correction

Maintenance menu



Module BASE

Current source Output current definable 0 ... 22 mA

O₂ 4700i(X) ppb module

Sensor monitor Sensor current, air pressure, ext. pressure transmitter, RTD, temperature, impedance, current input
Temp probe adjustment Compensating for lead length

Diagnostics menu



Message list List of all warning and failure messages
Point of meas description
Logbook
Device description Hardware version, Serial no., (Module) Firmware, ISM, Options

Module FRONT

Module diagnostics
Display test
Keypad test

Module BASE

Module diagnostics
Input/output status

O₂ 4700i(X) ppb module

Module diagnostics Internal function test
Sensor monitor Shows the values currently measured by the sensor
Cal record Data of last adjustment / calibration
Sensor network diagramOxy Graphical representation of the sensor parameters
Sensor wear monitor Current sensor wear, No. of CIP/SIP/autoclaving cycles
Statistics Displays first calibration and deviations of last 3 calibrations

Index

A

- Adjustment 35, 48
- Administrator level 50
- AuditTrail Log 8
- Autoclaving counter (ISM only) 21
- Automatic calibration in air 40
- Automatic calibration in water 38

C

- Cal preset values 55
- Cal record 76
- Calculation Blocks 70
- Calculation module, operation 70
- Calibration 34
- Calibration methods 36
- CIP (Cleaning in Place) 25
- Configuring the module 52
- Connection of sensors 29
- Contact type 67
- Current outputs 59, 80
- Current outputs: Characteristics 60

D

- Data entry of premeasured sensors 46
- Data recording 14
- Declaration of Conformity 3
- Default values 55
- Device description 10, 74
- Device limits 56
- Diagnostics functions 73
- Diagnostics menu 57
- Diagnostics messages 23
- Digital inputs 68
- Display settings 32

Index

Disposal 2

Dissolved oxygen measurement in carbonated beverages 81

E

EC Declaration of Conformity 3

Electronic Signature 8

EMC 79

Enable / lock functions 51

Explosion protection 79

External current input 29

External pressure transmitter 55

F

Factory settings 58

Failure 57, 64, 87

Favorites 23

FDA 21 CFR Part 11 8

Function check 52, 64, 87

Function control matrix 23

H

Hazardous-area application 9

High CO₂ compensation 81

Hysteresis 67

I

Icons 87

Inner body changes (ISM only) 21

Input filter 55

Inserting the module 27

Intended use 8

ISM - Intelligent Sensor Management 17

ISM diagnostics 22

ISM First Calibration 19

ISM parameter setting 20

Index

ISM Plug and Measure 18
ISM predictive maintenance 21
ISM sensor description 74

L

Limit value 67
Locking a function 51
Logbook 58, 73

M

M 700 BASE 15
M 700 FRONT 12, 14
Maintenance 21, 49, 57
Maintenance request 64, 87
Max. device limits 56
Measurement display settings 32
Membrane body changes (ISM only) 21
Menu selection 30
Menu structure 13, 30
Message icons 57
Message list 57, 73
Message when the current range is exceeded 63
Messages 56, 72
Minimum measuring spans for current outputs 80
Modular concept 11
Module configuration 52
Module diagnostics 74-75
Module equipment 15

N

NAMUR signals 63
NAMUR signals: Relay contacts 64

O

OK1,OK2 inputs 68

Index

OK1/OK2 switching level 68
Operator level 50
Output filter 62
Overview of menu selection 92
Overview of parameter setting 82

P

Parameter sets 69
Parameter sets: Switching via OK2 69
Parameter setting 52
Parameter setting: Locking a function 51
Parameter setting: Messages 56
Parameter setting: Operating levels 50
Parameter tables (Excel) 16
Passcode entry 31
Pressure correction 55
Pressure during calibration 55
Pressure during measurement 55
Product calibration: Concentration 44
Product calibration: Saturation 42

R

Relay contacts 64-66
Relay contacts: Protective wiring 65
Resolution limit 80
Return of products 2

S

Safety information 9
Salinity correction 55
Secondary displays 23, 32
Sensocheck, Sensoface 54
Sensoface 53
Sensoface criteria 54
Sensor data 53, 55

Index

Sensor monitor 49, 75
Sensor monitoring details 20, 53, 55
Sensor network diagram 22, 76
Sensor wear monitor 22, 76
Settings of sensor data 55
Short description 12
SIP (Sterilize in Place) 25
SmartMedia card 14-15
Softkeys 23, 32
Software version 10
Specifications 77
Statistics 76
Switching behavior 66

T

Temp probe adjustment 49
Terminal plate 26
Time constant 62
Trace sensor 29
Trademarks 2

V

















Variable limits 56
Viewing level 50

W





Warranty 2
Wiring examples 28

Z

Zero current 47
Zero point correction 47

Icon	Explanation of icons important for this module
	The analyzer is in measuring mod, an ISM sensor is connected.
	The analyzer is in calibration mode. Function check is active.
	The analyzer is in maintenance mode. Function check is active.
	The analyzer is in parameter setting mode. Function check is active.
	The analyzer is in diagnostics mode.
NAMUR signals   	<p>Function check. The NAMUR “function check” contact is active (factory setting: BASE module, contact K2, N/O contact). Current outputs as configured:</p> <ul style="list-style-type: none"> • Currently meas. value: The currently measured value appears at the current output • Last measured value: The last measured value is held at the current output • Fix 22 mA: The output current is at 22 mA <p>Failure: The NAMUR “failure” contact is active (factory setting: BASE module, contact K4, N/C contact). To view error message, call up: Diagnostics menu/Message list</p> <p>Maintenance: The NAMUR “maintenance request” contact is active (factory setting: BASE module, contact K2, N/O contact). To view error message, call up: Diagnostics menu/Message list</p>
	Limit indication: Lower / upper range exceeded
 man	Temperature detection by manual input
	Calibration is performed
	Calibration - Step 1 of product calibration has been executed. The analyzer is waiting for the sample values
	In the plaintext display in front of a menu line: Access to next menu level with enter
	In the plaintext display in front of a menu line when it has been blocked by the Administrator against access from the Operator level.
	Designates the module slot (1, 2 or 3), allowing the clear assignment of measured-value/parameter displays in the case of identical module types.
 B	Indicates the active parameter set (The analyzer provides two parameter sets A and B. Up to 5 sets can be added using additional functions and SmartMedia card.)

Menu selection

	Calibration and adjustment	34
	Automatic - Water.....	38
	Automatic - Air.....	40
	Product calibration: Saturation.....	42
	Product calibration: Concentration.....	44
	Data entry	46
	Zero correction	47
	Adjustment.....	48
	Maintenance	49
	Autoclaving counter (ISM)	21
	Membrane and inner body changes	
	Parameter setting	50
	Input filter	55
	Sensor data	55
	Cal preset values	55
	Pressure correction.....	55
	Salinity correction	55
	Messages.....	56
	Current outputs, contacts, OK inputs (BASE)	59
	Diagnostics	75
	Module diagnostics.....	75
	Sensor monitor	75
	Cal record.....	76
	Sensor network diagram.....	76
	Sensor wear monitor	76
	Statistics	76
	Set favorite.....	23