

# Operating instructions and installation information

## METTLER TOLEDO MultiRange ID7-24V-Base<sup>2000</sup> weighing terminal

METTLER TOLEDO

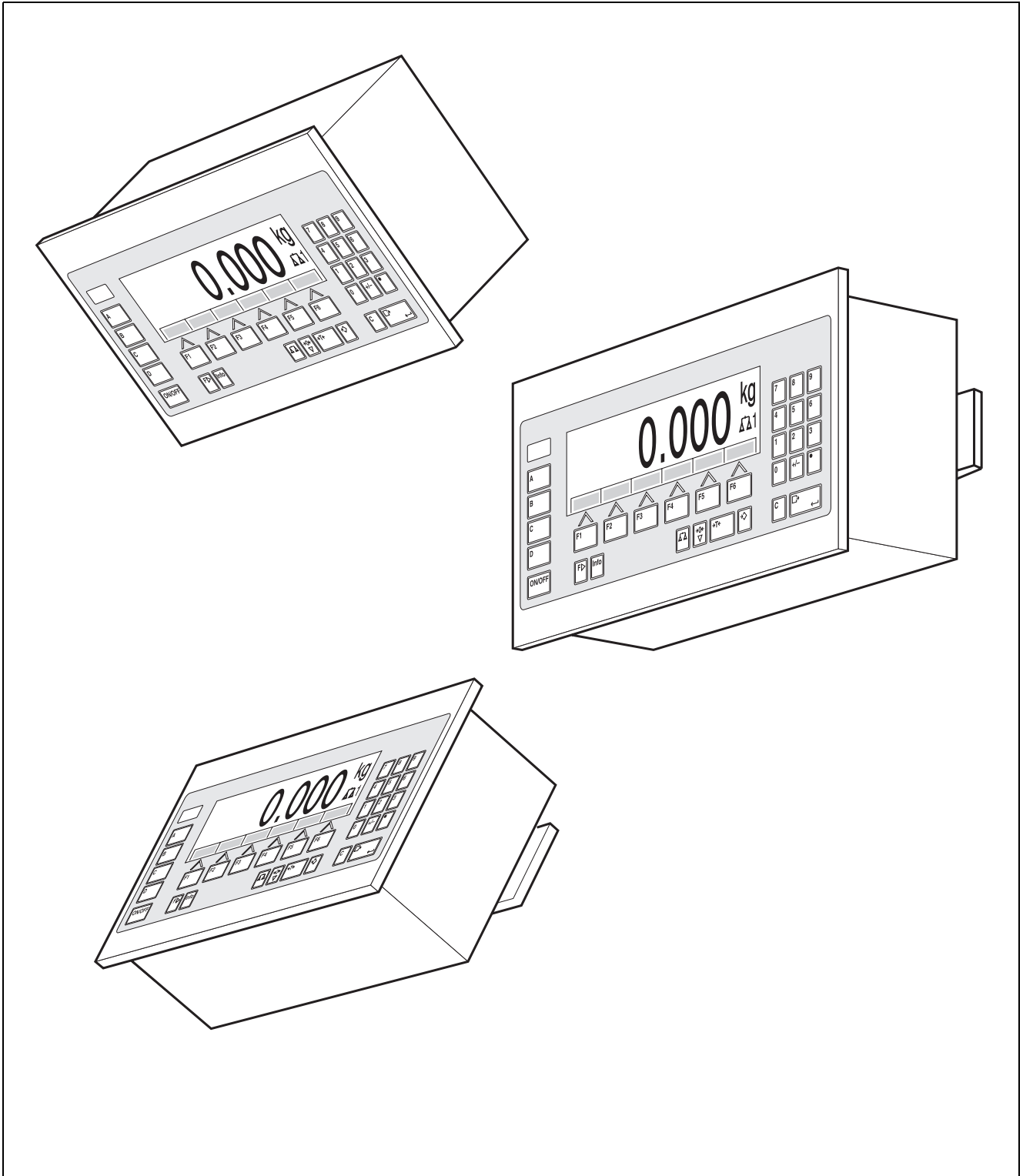

These operating instructions and installation information 22006771A describe the following components:

ID7-24V-Wall

Base<sup>2000</sup>-ID7

IDNet-ID7 (1 x Standard)

RS232-ID7 (1 x Standard)

BIG WEIGHT® is a registered trademark of Mettler-Toledo (Albstadt) GmbH

# Contents

	Page
<b>1 Introduction and commissioning .....</b>	<b>3</b>
1.1 Safety precautions .....	3
1.2 Applications .....	3
1.3 ID7-24V-Base weighing terminal .....	4
1.4 Commissioning .....	7
1.5 Cleaning .....	11
<b>2 Basic functions .....</b>	<b>12</b>
2.1 Switching on and off .....	12
2.2 Charge indicator in storage battery operation.....	12
2.3 Setting to zero .....	12
2.4 Taring .....	13
2.5 Weighing .....	14
2.6 Switch over weighing platform.....	15
<b>3 Additional functions .....</b>	<b>16</b>
3.1 Weighing with the DeltaTrac.....	16
3.2 Dynamic weighing.....	19
3.3 Change weight unit .....	19
3.4 Working in a higher resolution .....	20
3.5 Display gross weight.....	20
3.6 Specifying dynamic set points .....	20
3.7 Multiplicative tare function .....	21
3.8 Additive tare function .....	21
3.9 Sandwich tare .....	21
3.10 Display ID code and test weighing platform .....	22
3.11 Identifications .....	22
3.12 Recall information.....	24
3.13 Print or transfer data .....	25
3.14 Enter values with barcode reader .....	25
3.15 Working with external keypad .....	26
3.16 Working with a second display .....	27
<b>4 Settings in the master mode .....</b>	<b>28</b>
4.1 Overview of the master mode .....	28
4.2 Operating the master mode.....	29
4.3 TERMINAL master mode block.....	30
4.4 SCALE master mode block .....	37
4.5 INTERFACE master mode block .....	40
<b>5 Interface description .....</b>	<b>54</b>
5.1 MMR command set.....	54
5.2 METTLER TOLEDO continuous mode .....	65
5.3 METTLER TOLEDO SICS command set.....	67

<b>6</b>	<b>Application blocks .....</b>	<b>82</b>
6.1	Syntax and formats.....	82
6.2	TERMINAL, SCALE application blocks.....	85
6.3	INTERFACE application blocks.....	89
<b>7</b>	<b>What to do if ...?.....</b>	<b>92</b>
<b>8</b>	<b>Technical data and accessories.....</b>	<b>94</b>
8.1	Technical data .....	94
8.2	Accessories .....	99
<b>9</b>	<b>Appendix .....</b>	<b>103</b>
9.1	ASCII table .....	103
9.2	Key numbers .....	104
9.3	Opening/closing ID7-24V-Base weighing terminal.....	105
9.4	Configuring Pin 5 on RS232-ID7 interface.....	105
9.5	Drilling template for wall mounting .....	107
<b>10</b>	<b>Index.....</b>	<b>109</b>

# 1 Introduction and commissioning

## 1.1 Safety precautions



- ▲ Never operate the ID7-24V-Base weighing terminal in hazardous areas; there are special scales in our product line for this purpose.
- ▲ The ID7-24V-Base weighing terminal may only be connected to a 24 V DC power supply (storage battery or mains).
- ▲ Short-circuit danger!  
Ensure that the power supply is connected properly:  
brown lead +24 V  
blue lead 0 V or negative pole
- ▲ The safety of the unit is endangered if it is not operated in accordance with these operating instructions.
- ▲ Only authorized personnel may open the ID7-24V-Base weighing terminal.

## 1.2 Applications

With the ID7-24V-Base weighing terminal the following applications are possible:

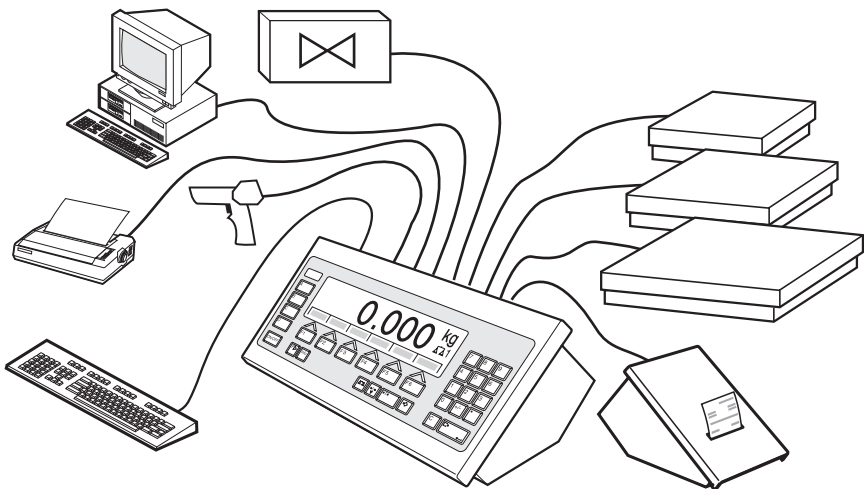

- Storage battery or mains operation, reversible.
- Multi-scale operation with up to 3 weighing platforms, including a weighing platform with an analog signal output.
- Up to 6 data interfaces
  - for printing,
  - for data exchange with a computer,
  - for connecting a barcode reader,
  - for control, e.g. of valves or flaps,
  - for connecting reference scales.
- Comfortable alphanumeric entry via an external keypad.

## 1.3 ID7-24V-Base weighing terminal

### 1.3.1 Display

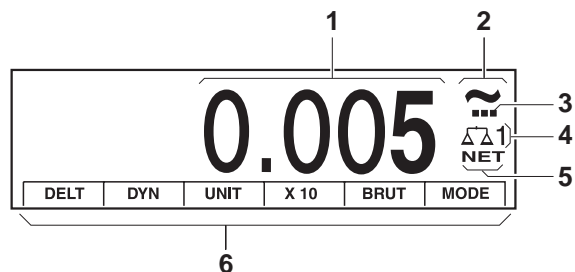

- 1 Weight display BIG WEIGHT<sup>®</sup> with sign and decimal point
- 2 Stability monitor: lights up until the weighing platform has levelled out, then the weight unit appears here
- 3 Range display for multi-range weighing platforms
- 4 Number of the weighing platform: shows the weighing platform just selected
- 5 NET symbol for marking net weight values
- 6 Assignment of the function keys

### 1.3.2 Keypad

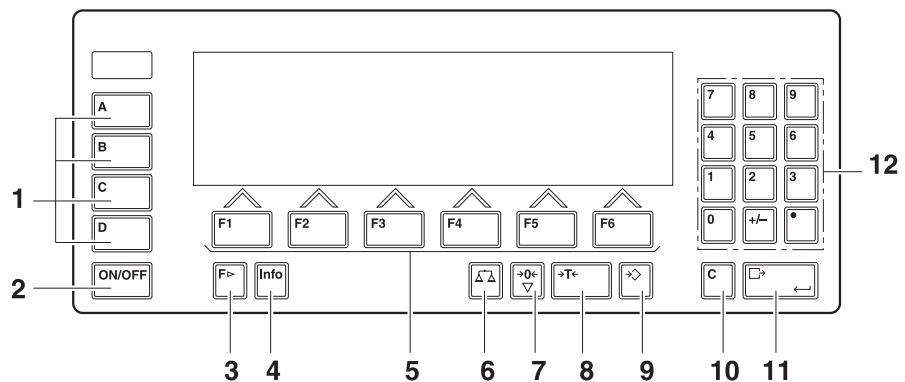

- 1** CODE A ... CODE D keys – enter identification data
- 2** ON/OFF – On/Off key
- 3** FUNCTION CHANGE key – display additional functions when entering weight values: switch over unit
- 4** INFO key – recall memory contents and system information
- 5** Function keys F1 ... F6 – the current assignment is shown in the display above the key
- 6** SCALE key – select scale
- 7** ZERO-SET key – set scale to zero, test scale
- 8** TARA key – tare scale
- 9** TARE SPECIFICATION key – enter known tare values numerically
- 10** CLEAR key – clear entries and values
- 11** ENTER key – accept and transfer data
- 12** Numeric keypad with decimal point and signs

### 1.3.3 Connections

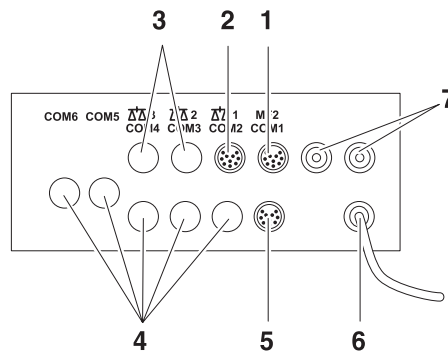

- 1 Connection for the external MFI keypad
- 2 Connection for weighing platform 1
- 3 Optional connections for weighing platforms 2 and 3
- 4 5 optional interface connections
- 5 Standard RS232 interface
- 6 Power supply
- 7 Optional connections for the Profibus

#### Possible assignments for serial interfaces (with software)

Interface	COM1	COM2	COM3	COM4	COM5	COM6
CL20mA-ID7	–	X	X	X	X	X
RS232-ID7	X	X	X	X	X	X
RS422-ID7	–	–	–	–	X	X
RS485-ID7	–	–	–	–	X	X
RS485-ID7 with relay box 8-ID7	–	–	–	–	X	X
4 I/O-ID7	–	–	–	–	X	X
Analog Output-ID7	–	–	–	–	X	X
Alibi Memory-ID7	–	X	X	X	X	X
Ethernet-ID7	–	X	X	X	X	X
Profibus-DP-ID7	–	X	X	X	X	X
WLAN-ID7	–	X	X	X	X	X



**Notes**

- COM1 is permanently equipped with the serial interface RS232-ID7 as standard.
- Only one Alibi Memory ID7 can be installed. It has no additional external connection, and internally it occupies the space of a data port COM2 ... COM6. Alibi Memory ID7 is installed as COM4 at the factory.

**CAUTION**

- Cover unused connection sockets with protective caps to protect the socket contacts from moisture and dirt.

**1.4 Commissioning****1.4.1 Mount ID7-24V-Base on the wall**

The ID7-24V-Base weighing terminal and wall bracket are one unit. The mounting materials for wall mounting are included in the scope of delivery.

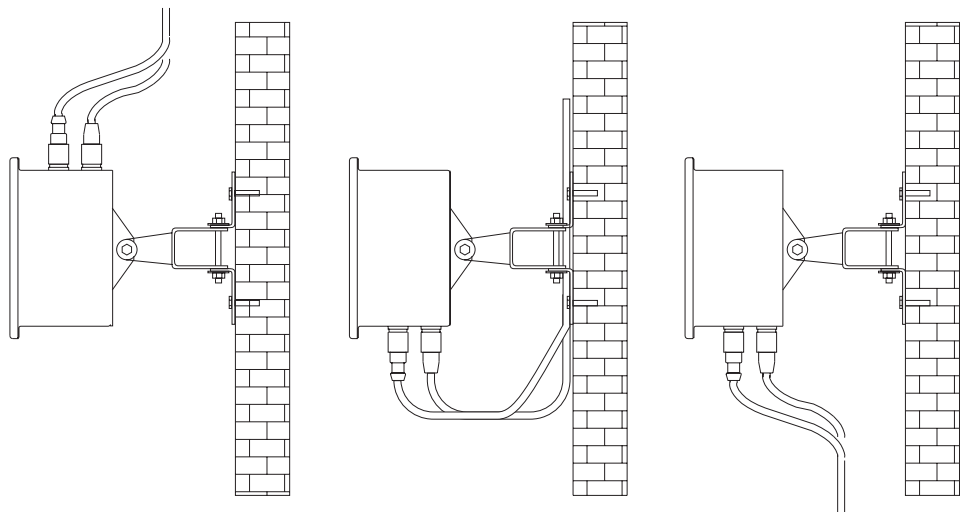
**Mounting possibilities****Note**

If one or more Analog Scale ID7, Alibi Memory ID7, Ethernet ID7 or Profibus DP-ID7 interfaces are installed, we recommend securing with cable entry from above.

**Procedure**

1. Drill securing holes and fit plugs in accordance with the drilling template in the Appendix.
2. Secure the weighing terminal with the screws provided.

**With cable entry from above**

3. Unscrew the screws on the underside of the cover and set down the cover toward the front.
4. Disconnect the display and keyboard cable.
5. Remove the cover and turn it by 180°.

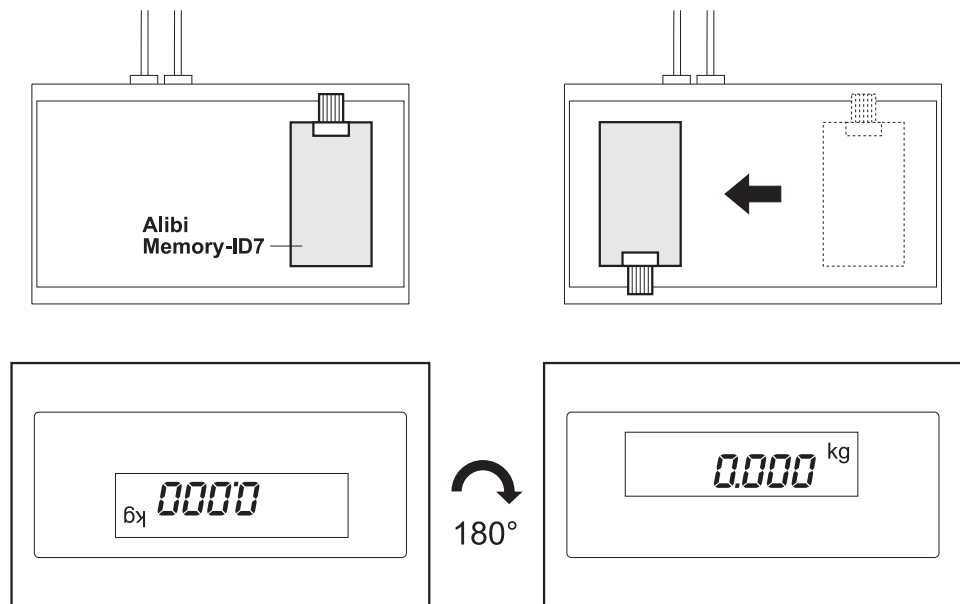

6. If an Alibi Memory-ID7 is installed, remount the Alibi Memory-ID7 PCB on the mounting plate. To do this
  - remove the PCB from the mounting plate by unscrewing a screw,
  - pull the plug off the PCB,
  - mount the PCB in the left-hand position with a screw,
  - fold up the mounting plate and route the cable upward on the lower housing wall,
  - connect the cable on the PCB
7. Reconnect the display and keyboard cable.
8. Screw on the cover again.

**1.4.2 Connect weighing platforms of the series D, F, K, N, Spider ID and AWU3/6**

1. Set up weighing platform, see installation instructions of weighing platform.
2. Route weighing platform cable to weighing terminal.
3. Plug in weighing platform connector on weighing terminal.

### 1.4.3 Connect scales of the series B, G, R and DigiTOL

Precision scales of the **series B, G and R** can be connected to the ID7-24V-Base weighing terminal with the LC-IDNet B or LC-IDNet R/G connection set. To connect **DigiTOL** scales, the GD17 connection set is required.

1. Set up scale, see operating instructions of scale.
2. Connect appropriate connection set to scale.
3. Route cable of connection set to weighing terminal and plug in.

### 1.4.4 Commissioning with several weighing platforms

→ To start up the ID7-24V-Base weighing terminal with several weighing platforms, please contact METTLER TOLEDO Service.

### 1.4.5 Connecting power supply



#### CAUTION

The ID7-24V-Base weighing terminal only functions correctly with a 24 V DC power supply.

→ Ensure that the ID7-24V-Base only be connected to a 24 V DC power supply (storage battery or mains).

#### Selecting storage battery or mains operation

The ID7-24V-Base weighing terminal is set to storage battery operation at the factory.

1. Open weighing terminal, see Section 9.2.
2. Remove power supply unit cover.

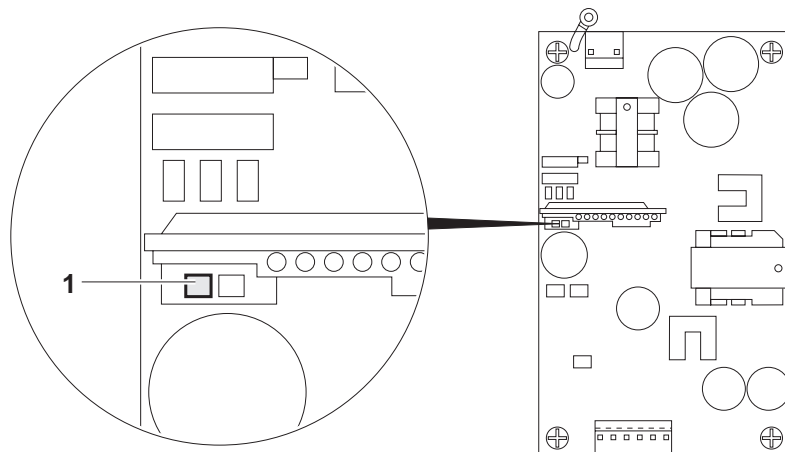

3. Set the switch (1) to the desired position:
  - left      storage battery operation (default setting)
  - right     mains operation
4. Replace power supply unit cover and close ID7-24V-Base weighing terminal.

**Earthing**

The blue lead of the power cable is connected to the GND of the individual voltages and the housing internally.

→ This is why we recommend the earthing of GND or the negative pole of the supply voltage.

**Mains operation**

→ We recommend that the green-yellow lead of the power cable be connected to the earth or the equipotential bonding of the mains or the system.

**Storage battery operation**

→ If the negative pole of the storage battery is not earthed, the green-yellow lead of the power cable need not be connected.

→ If the negative pole of the storage battery is earthed, we recommend that the green-yellow lead of the power cable be connected to the equipotential bonding.

**Connecting**

→ Connect the leads of the power cable as follows:

brown lead    +24 V

blue lead     0 V or negative pole

In the factory setting the display briefly shows METTLER TOLEDO ID7 and the versions of the installed components; then the weight display appears.

**1.4.6 Marking and sealing of certified weighing platforms****ID code**

With the ID code it can be checked whether certified weighing platforms have been tampered with since the last certification. The ID code can be displayed on the terminal at any time, see section 3.10.

During certification the currently displayed ID code is recorded and sealed.

During each change to the configuration the displayed ID code increases. It then no longer matches the sealed ID code; the certification is not longer valid.

**Certification**

To mark and certify your weighing system, please contact METTLER TOLEDO Service or your local board of weights and measures.

**Check certification**

1. Display ID code, see section 3.10; press ZERO-SET key until IDENTCODE = ... is displayed.

No value is shown for noncertified weighing platforms, but instead:  
IDENTCODE ===.

2. Compare ID code displayed with sealed ID code on ID card.

The certification of the weighing system is only valid when both values are identical.

Depending on the type of cable connection, the ID card is mounted either above or below.

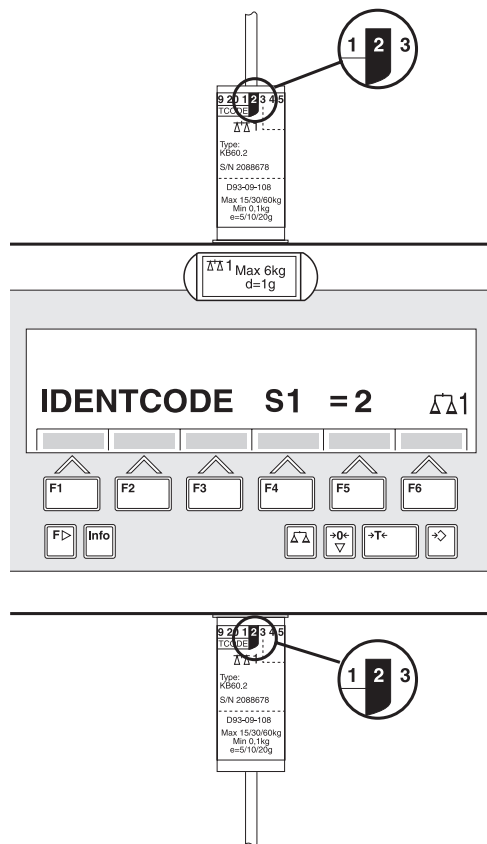

3. Press ZERO-SET key again.  
The connected weighing platform is checked. The display shows CHECK SCALE and after the test is completed SCALE IS OK.  
Then the ID7-24V-Base automatically returns to normal operation.

## 1.5 Cleaning



### DANGER OF SHOCK

→ Do not open ID7-24V-Base weighing terminal to clean.

### CAUTION

- Make sure that unused connection sockets are covered with protective caps to protect the socket contacts from moisture and dirt.
- Do not use high-pressure cleaners.

### Cleaning

- Wipe off ID7-24V-Base weighing terminal with a commercially available glass or plastic cleaner.

## 2 Basic functions

### 2.1 Switching on and off

#### Switch on from the standby mode

→ Press ON/OFF key.

The display shows a weight value based on the last tare value and zero point.

#### Switch on with restart

1. Relieve weighing platform.
2. Press ON/OFF key and hold down until METTLER TOLEDO ID7 (factory setting) or text you have specified appears in display.  
Then weight value 0.000 kg appears.

The weighing platform is restarted.

#### Note

The text which appears during switch-on with a restart is saved in the text memory 20, see section 4.3.2.

#### Switch off

→ Press ON/OFF key.

The display goes out and the ID7-24V-Base weighing terminal is in the standby mode. The zero point and tare value remain saved.

### 2.2 Charge indicator in storage battery operation

If the supply voltage drops below 22.5 V, a continuous whistle sound is emitted for approx. 10 to 30 minutes.

If the supply voltage drops below 21 V, the ID7-24V-Base weighing terminal switches off automatically.

→ If the whistle sound is emitted, complete the current weighing process and charge or replace the storage battery.

### 2.3 Setting to zero

Setting to zero corrects the influence of minor dirt on the load plate.

In the case of excessive dirt which cannot be compensated by setting to zero, the display shows OUT OF RANGE.

#### Manual zero set

1. Relieve weighing platform.
2. Press ZERO-SET key.  
The display shows 0.000 kg.

### Automatic zero set

On certified weighing platforms the zero point of the weighing platform is automatically corrected when the weighing platform is relieved.

The automatic zero set can be switched off in the master mode on noncertified weighing platforms.

## 2.4 Taring

### 2.4.1 Manual taring

1. Place empty container on scale.
2. Press TARE key.  
The tare weight is saved and the weight display set to zero.  
The display shows the NET symbol.

#### Notes

- When the weighing platform is relieved, the saved tare weight is displayed with a negative sign.
- The weighing platform only saves **one** tare value.

### 2.4.2 Automatic taring

#### Prerequisite

AUTOTARA ON must be set in the master mode, see section 4.4.

- Place empty container on scale.  
The container weight is automatically saved and the weight display set to zero.  
The display shows the NET symbol.

#### Note

When the weighing platform is relieved, the saved tare weight is cleared.

### 2.4.3 Specify tare weight

#### Enter numerically

1. Press TARE SPECIFICATION key.
2. Enter tare weight (container weight) and confirm with ENTER.  
When weighing platform is relieved, the entered tare weight is displayed with a negative sign.

#### Note

With the FUNCTION CHANGE key you can select the weight unit for entering the tare weight.

#### Correct entry

- Clear the entry character by character with the CLEAR key and repeat correctly.

**Copy tare constant** The ID7-24V-Base has 999 tare memories for frequently used tare weights programmed in the master mode.

1. Enter memory number: 1... 999.
2. Press TARE SPECIFICATION key.  
The display shows the NET symbol and the net weight based on the recalled tare weight.

#### 2.4.4 Recall currently saved tare weight

The saved tare weight can be recalled at any time.

- Enter INFO, TARE SPECIFICATION key sequence.  
The saved tare weight is displayed.

#### 2.4.5 Clear tare weight

- Relieve weighing platform and tare.

– or –

- Specify tare weight 0.

– or –

- Enter TARE SPECIFICATION, CLEAR key sequence.

## 2.5 Weighing

### Weighing without taring

- Lay weighing sample on weighing platform.  
Gross weight (total weight) is displayed.

### Weighing with taring

1. Place the empty container on the weighing platform and tare.
2. Pour in weighing sample.  
The display shows the net weight and the NET symbol.

### Weighing with tare specification

1. Place filled container on weighing platform.  
The display shows the gross weight (total weight).
2. Specify tare weight or recall tare memory.  
The display shows the net weight (container content) and the NET symbol.

### Note

If a **multi-range weighing platform** is chosen, a display for the currently active range appears above the scale symbol.



## 2.6 Switch over weighing platform

Up to 3 weighing platforms can be connected to the ID7-24V-Base. The weighing platform currently selected is shown on the terminal.

→ Press SCALE key.

The next weighing platform is selected.

– or –

→ Enter number of weighing platform and press SCALE key.

The desired weighing platform is selected.

### 3 Additional functions

The assignment of the 6 function keys of the ID7-24V-Base weighing terminal differs depending on the weighing task. The current assignment is shown above the function keys.

With the FUNCTION CHANGE key it is possible to switch over to other function key assignments.

Independent of the application software, the ID7-24V-Base has the following additional functions:

<b>DELT</b>	<b>DYN</b>	<b>UNIT</b>	<b>X 10</b>	<b>GROSS</b>	<b>MODE</b>
Weighing with the DeltaTrac, see 3.1	Dynamic weighing, see 3.2	Change weight unit, see 3.3	Increase resolution, see 3.4. This key is not assigned when the control mode is continually switched on.	Display gross weight, see 3.5	Activate master mode, see Chapter 4

<b>MULT-TARE</b>	<b>ADD-TARE</b>	<b>SANDWICH-T</b>
Multiplicative tare function, see 3.7	Additive tare function, see 3.8	Sandwich tare, see 3.9

If at least one dynamic switching point is configured in the master mode (see page 53), the second row of function keys is given the following assignment:

<b>SETP</b>			<b>MUL-T</b>	<b>ADD-T</b>	<b>SW-T</b>
Set dynamic set points, see 3.6			Multiplicative tare function, see 3.7	Additive tare function, see 3.8	Sandwich tare, see 3.9

#### 3.1 Weighing with the DeltaTrac

The DeltaTrac is an analog display which makes it easier to read the weighing results.

In the master mode you can select how the DeltaTrac is displayed for the various weighing tasks FILLING, CLASSIFYING or CHECKWEIGHING.

##### Note

- With the DeltaTrac signals you can also control lamps, flaps or valves, see section 4.5.4.

**Application** For weighing-in to a target weight with tolerance monitoring.

**FILLING**

**Example: Target weight = 1.000 kg, tolerance = 1 %**



Target weight not reached yet



Weight within the tolerance



Target weight reached exactly

**Application**  
**CLASSIFYING**

To evaluate test samples as OKAY, TOO LIGHT or TOO HEAVY, based on a target weight and specified +/- tolerances.

**Example: Target weight = 1.000 kg, tolerance = 1 %**



TOO LIGHT  
Weight below the tolerance



OKAY  
Weight within the tolerance



TOO HEAVY  
Weight above the tolerance

**Application**  
**CHECKWEIGHING**

For determining the difference between the target and actual weight.

**Example: Target weight = 1.000 kg, tolerance = 1 %**

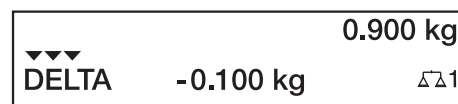

Weight below the tolerance  
Difference: -0.100 kg



Weight within the tolerance  
Difference: +0.002 kg

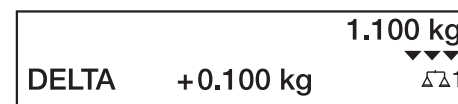

Weight above the tolerance  
Difference: +0.100 kg

### 3.1.1 Preset DeltaTrac target values

- Enter numerically**
1. Press DELT key.
  2. Enter target weight and confirm with ENTER.
  3. Enter tolerance in % of target weight and confirm with ENTER.

**Note**

With the FUNCTION CHANGE key you can select the weight unit for entering the DeltaTrac target values.

- Correct entry** → With the CLEAR key the entry is corrected character by character.

**Copy constants** The ID7-24V-Base weighing terminal has 999 DeltaTrac memories for frequently used target values and tolerances, which are programmed in the master mode.

1. Enter number of DeltaTrac memory: 1 ... 999.
2. Press DELT key.

- Reference sample**
1. Press DELT key.
  2. Lay sample on weighing platform and confirm with SCALE key.
  3. Only for FILLING and CLASSIFYING: Enter tolerance and confirm with ENTER.
  4. Remove sample from weighing platform.

<b>Limits</b>	Minimum target value	10 Digit, can be adjusted in mastermode, see section 4.3
	Maximum target value	configured maximum load
	Minimum tolerance	1 Digit
	Maximum tolerance	10 % for the applications FILLING, CHECKWEIGHING 50 % for the application CLASSIFYING

**Note**

If the limits are not observed, a message appears in the display, e.g. MIN-DEL = ..., for too small a target value.

- Clear DeltaTrac target value** → Press DELT CLEAR key sequence.  
DELTA CLEARED appears briefly in the display, then the weight is shown.

### 3.2 Dynamic weighing

With the dynamic weighing function you can weigh restless weighing samples, e.g. live animals. To do this, specify the number of weighing cycles for which the mean weight value is to be taken.

1. Set container on the weighing platform.
2. Tare weighing platform.
3. Place weighing sample in container.
4. Press DYN key and enter number of weighing cycles.  
Possible values: 1 ... 255.
5. Start dynamic weighing with ENTER key.
6. After cycle time has expired, center line of display shows:  
RESULT x.xxxx kg.  
This display is retained until the next weighing is started or until it is cleared.

**Delete result** → Press CLEAR key.

#### Notes

- Dynamic weighing results are automatically printed when AUTO PRINT is set in the master mode, see section 4.3.2.
- During dynamic weighing it is not possible to display the weight value BIG WEIGHT DISPLAY, which fills the entire display.
- Dynamic weighing can also be started with the interface command AW016..., see section 6.2.

### 3.3 Change weight unit

If an additional, second weight unit is configured in the master mode, it is possible to switch back and forth between the two weight units.

- Press UNIT key.  
The weight value is shown in the second unit.

#### Note

Possible second weight units are: g, kg, lb, oz, ozt, dwt.

### 3.4 Working in a higher resolution

Depending on the setting of the master mode block CONTROL MODE (see page 34), the weight value can be displayed in a higher resolution continuously or when called. Weight values in a higher resolution are marked with a \*.

#### Displaying weight values in higher resolution

→ Press X 10 key.

The weight value is displayed in at least a 10x higher resolution.

The higher resolution is displayed until the X 10 key is pressed again.

#### Note

With certified weighing platforms, the weight value only appears in a higher resolution as long as the X 10 key is pressed.

### 3.5 Display gross weight

The gross weight can only be displayed when a tare weight has been saved.

→ Press GROSS key and hold down.

The gross weight is displayed.

### 3.6 Specifying dynamic set points

#### Conditions

- 4 I/O-ID7 interface or 8-ID7 relay box connected.
- SETPOINT MODE ON and at least one dynamic set point is configured in the master mode.

**Use** If the specified set point values are exceeded or dropped below, digital outputs are set, e.g. for controlling lamps, flaps, valves etc.  
Dynamic set points can be set for each weighing procedure individually.  
The set points are retained until they are overwritten with a new value or deleted.

#### Specifying set points

1. Press the SETP key; the entry prompt for the first dynamic set point appears.
2. Enter the desired weight value and confirm with ENTER.
3. If additional dynamic set points are configured, the entry prompt appears for the next dynamic set point.
4. Enter the desired weight value and confirm with ENTER.
5. Repeat the procedure until all set points have been entered.

#### Deleting set points

→ Press the SETP key and delete the value with the CLEAR key.

### 3.7 Multiplicative tare function

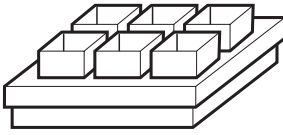

The multiplicative tare function is particularly suitable when pallets with identical containers are filled. If the number of containers and tare of the individual container are known, the ID7-24V-Base weighing terminal calculates the total tare.

1. Press MULT TARE key.
2. Enter known tare weight of individual container and confirm with ENTER.
3. Enter number of containers and confirm with ENTER.  
When the weighing platform is relieved, the total tare value is shown in the display with a negative sign.

#### Note

With the FUNCTION CHANGE key you can select the weight unit for entering the tare weight.

### 3.8 Additive tare function

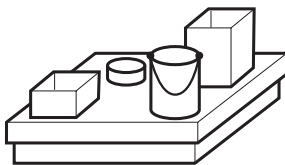

With the additive tare function you can subtract the tare of additional containers with a known tare weight for related weighings, e.g. if containers with different weights are filled on one pallet.

1. Place container on scale and press ADD TARE key.
2. Enter known tare weight and confirm with ENTER.  
The total net weight appears in the weight display.

#### Note

With the FUNCTION CHANGE key you can select the weight unit for entering the tare weight.

### 3.9 Sandwich tare

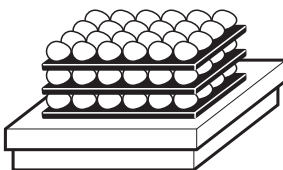

With the sandwich tare function you can detect additional tare weights for related weighings without losing the total gross and total net.

#### Example

In production or shipping boxes are laid between individual layers in the transport container. The weight of these boxes can be subtracted with this function.

1. Press SANDWICH-T key.
2. Place sandwich tare, e.g. box, on scale and confirm with ENTER.  
The net weight is retained.

### 3.10 Display ID code and test weighing platform

Each time the weighing platform configuration is changed the ID code counter is increased by 1. On certified weighing platforms the displayed ID code must match the ID code on the ID code sticker, otherwise the calibration is no longer valid.

#### Display ID code

→ Press ZERO-SET key and hold until IDENTCODE = ... appears in the display and press again.

#### Test weighing platform

→ Press ZERO-SET key again.

The connected weighing platform is checked. The display shows CHECK SCALE and then SCALE IS OK after completing the test.

#### Note

If weighing platform is defective, display shows SCALE ERROR.

### 3.11 Identifications

The ID7-24V-Base weighing terminal is equipped with 4 identification data memories for storing identification data Code A ... Code D.

The memories have a name, e.g. Article No., and a content which identifies the current weighing, e.g. 1234567.

The memories are named in the master mode, and the names can be noted on the keyboard. When the CODE keys are pressed, the name appears in the display.

Identification data Code A ... Code D can be entered or recalled for each weighing and are printed immediately.

#### 3.11.1 Enter identification

An identification may contain a maximum of 20 characters.

##### Enter numerical identification

1. Press one of the keys CODE A ... CODE D.
2. Enter identification data Code A ... Code D via the numeric keypad and confirm with ENTER.



### Enter alphanumeric identification

1. Press one of the keys CODE A ... CODE D.  
The functions keys are given the following assignment:

ABCDE	FGHIJ	KLMNO	PQRST	UVWXY	Z/(-)
Selection of letters A to E	Selection of letters F to J	Selection of letters K to O	Selection of letters P to T	Selection of letters U to Y	Selection of letter Z and special characters

2. Select desired group of letters, e. g. press KLMNO key.
3. Select desired letter.  
The display changes again to the above selection.
4. Repeat entry in steps 2 and 3 for additional characters.

#### Note

Letters and numbers can be combined as desired.

### Recall fixed text memory

The ID7-24V-Base weighing terminal is equipped with 999 memories for fixed texts which can be programmed in the master mode and used as identifications.

1. Enter memory number: 1 ... 999.
2. Press a key CODE A ... CODE D.  
The saved fixed text is now assigned to the selected identification Code A ... Code D.

### Other entry possibilities

Identifications can also be entered with a barcode reader, see section 3.14, or with an external keypad, see section 3.15.

#### 3.11.2 Clear identifications

- Press desired key CODE A ... CODE D and clear memory content with CLEAR key.

## 3.12 Recall information

On the ID7-24V-Base weighing terminal memory contents and system information can be recalled.

1. Press INFO key.

Then the following function key assignment appears:

<b>DELT</b>	<b>TARE</b>	<b>TEXT</b>	<b>ALIBI</b>	<b>DATE</b>	<b>VERS</b>
Display DeltaTrac values	Display tare weight	Display fixed texts and name of keys CODE A ... CODE D	Recall content of alibi memory, see section 2.1. This selection only appears when Alibi Memory-ID7 is installed.	Display date and time	Display version numbers of installed software modules

2. Select desired information.

The information is displayed for the set DISPLAY DURATION, then the ID7-24V-Base changes to the weighing mode again.

### Notes

- When several values are displayed, the ID7-24V-Base automatically changes to the next value after the set DISPLAY DURATION.
- With the CLEAR key it is possible to switch to the next value or back to the weighing mode.
- When the GA46 printer is connected, the version numbers of the installed software modules are automatically printed.

### 3.12.1 Recall memory

1. Press INFO key.
2. Enter number of memory and press DELT, TARA or TEXT key depending on desired memory.

#### Recall name of CODE A ... CODE D keys

1. Press INFO key.
2. Press one of the keys CODE A ... CODE D.  
The display shows the current Code.

### 3.13 Print or transfer data

If a printer or computer is connected, weighing results can be printed out or transferred to the computer.

In the master mode you can set the following for this purpose:

- Data to be printed or transferred,
- Manual or automatic data transfer,
- Key which triggers printing or data transfer.

#### Factory setting

- Manual triggering with the ENTER key.
- The content of the display is transferred or printed.

### 3.14 Enter values with barcode reader

If you have connected a barcode reader to the ID7-24V-Base weighing terminal, you can make all required entries, such as identifications or target specifications, easily with the barcode reader.

#### 3.14.1 Read in any desired entries with the barcode reader

##### Example Read in identification Code A

1. Press CODE A key; the ID7-24V-Base expects the entry of Code A.
2. Enter identification Code A with the barcode reader.  
The identification read in appears in the display.
3. Confirm barcode entry with ENTER.

#### 3.14.2 Read in a frequently used entry directly with the barcode reader

If your working procedure repeatedly requires the same entry, you can configure the barcode reader in the master mode (see section 4.5.3) so that no additional keys need to be pressed on the ID7-24V-Base terminal for barcode entry.

##### Example Barcodes are automatically read in as Code A

If the working procedure requires the entry of Code A:

- Enter identification Code A with barcode reader.  
The information read in appears in the display and is automatically processed by ID7-24V-Base as Code A.

### 3.15 Working with external keypad

In addition to the alpha and numerical keys, the following additional scale functions can also be operated with the external AK-MFII keypad.

Function for ID7-24V-Base	External keypad	Function for ID7-24V-Base	External keypad
Function key F1	F1	CODE A key	Shift F1
Function key F2	F2	CODE B key	Shift F2
Function key F3	F3	CODE C key	Shift F3
Function key F4	F4	CODE D key	Shift F4
Function key F5	F5		
Function key F6	F6		
FUNCTION CHANGE key	F7		
INFO key	F8		
SCALE key	F9	SCALE key	Shift F9
ZERO-SET key	F10	ZERO-SET key	Shift F10
TARE key	F11	TARE key	Shift F11
TARE SPECIFICATION key	F12	TARE SPECIFICATION key	Shift F12

#### Note

The language of your external keyboard can be set in the master mode block LAYOUT EXT. KEYBOARD, see page 32.

### 3.16 Working with a second display

An ID1 Plus, ID3s or another ID7-... weighing terminal can be connected to the ID7-24V-Base weighing terminal as a second display.

#### Conditions

- Interface CL 20mA-ID7 installed in passive operating mode (factory setting).
- AUTO-DIR setting selected in mastermode (see page 43).
- Weighing terminal is connected as second display with cable 00 504 511.

#### Operation possibilities on second display

The following functions are also possible on the second display:

- Set to zero
- Taring

#### ID7-... as second display

With ID7-... as a second display, the weight value fills the entire display (BIG WEIGHT DISPLAY ON).

## 4 Settings in the master mode

### 4.1 Overview of the master mode

In the master mode you adapt the ID7-24V-Base weighing terminal to meet your needs. Depending on the configuration, the master mode is divided into 4 or 5 master mode blocks, which are in turn divided into further blocks.

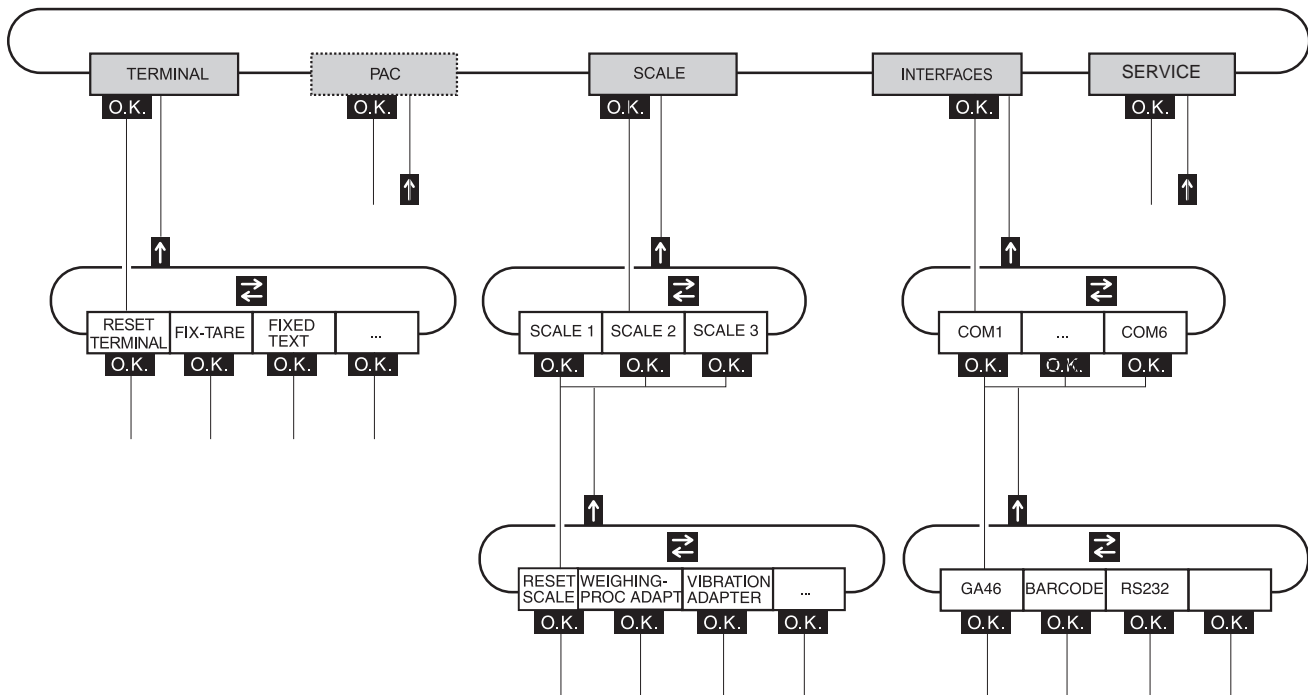

**TERMINAL** For system settings, such as entering the date and time or loading permanent texts, see section 4.3.2.

**PAC** To set application-specific parameters.  
This block does not appear with ID7-24V-Base.

**SCALE** To select one of the connected weighing platforms. For each selected weighing platform the parameters are then set which concern the weight value, e. g. stability detector, unit, etc., see section 4.4.

**INTERFACES** To select an interface. The communication parameters are then set for each interface, see section 4.5.

**SERVICE** For configuring the weighing platform(s). On IDNet weighing platforms only for METTLER TOLEDO service technicians.

## 4.2 Operating the master mode

### 4.2.1 Enter the master mode

1. Press MODE key.  
If the current function key assignment does not contain MODE, change to the assignment with MODE by repeatedly pressing the FUNCTION CHANGE key.
2. Enter personal code if configured.  
The display shows the first master mode block TERMINAL.

### 4.2.2 Assignment of function keys in the master mode

In the master mode the function keys are assigned as follows:

←	→		↑	<b>END</b>	<b>OK</b>
Change to previous block within a level	Change to next block within a level		Exit level and return to higher-level block	Exit the master mode and return to normal mode	Recall lower-level block or confirm selection

→ Select the function by pressing the function key.

**Example** → Press the END key to exit the master mode and return to the normal mode.

#### When the function keys are otherwise allocated

→ Press the key FUNCTION CHANGE until the function keys allocation displayed above appears.

### 4.2.3 Orientation in the master mode

For improved orientation the display shows the last steps in the path of the current master mode block.

**Example** The upper 3 lines of the display show the following path for selecting the DeltaTrac application FILLING:

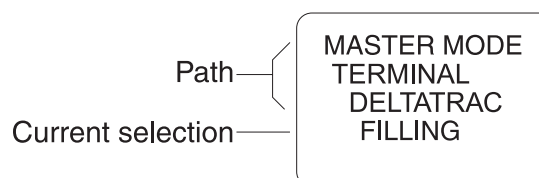

### 4.2.4 Entries in the master mode

The following basic rules apply to entries made in the master mode:

- Confirm (alpha)numeric entries with ENTER.
- Alphanumeric entries with the ID7-24V-Base: see section 3.11.
- To accept the displayed value: Press ENTER key.

### 4.2.5 Emergency entrance into the master mode

If a personal code has been assigned for entering the master mode and you have forgotten your code, you can still enter the master mode:

→ Enter the character sequence C, L, E, A, R as your personal code.

## 4.3 TERMINAL master mode block

### 4.3.1 Overview of the TERMINAL master mode block

In the TERMINAL master mode block you enter the following system settings:

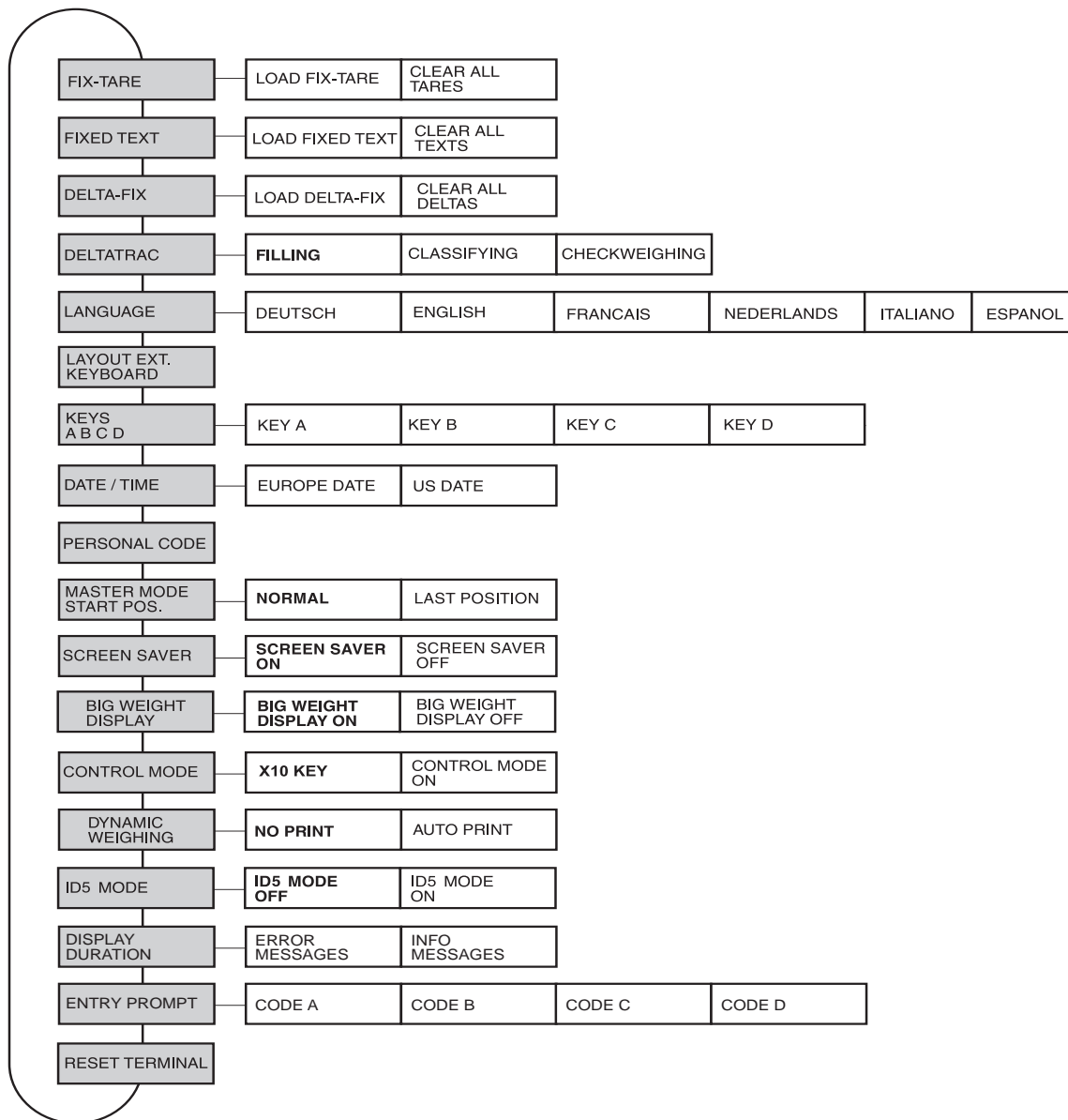

#### Legend

- Blocks highlighted in **grey** are described in detail in the following.
- Factory settings are printed in **bold print**.



### 4.3.2 Settings in the TERMINAL master mode block

<b>FIX-TARE</b>	<b>Save tare values protected against power failure to tare memories</b>
LOAD FIX-TARE	<ol style="list-style-type: none"> <li>1. Enter memory number of FIX-TARE NO.: 1 ... 999.</li> <li>2. Enter tare weight for the selected memory in the displayed unit.</li> <li>3. To load additional fixed tare values, repeat the first two steps.</li> <li>4. End entry: Confirm FIX-TARE NO. without entry with ENTER.</li> </ol>
CLEAR ALL TARES	Delete all tare memories.

<b>FIXED TEXT</b>	<b>Save texts protected against power failure to text memories</b>
	These texts can be assigned, for example as identifications, or also output during printing.
LOAD FIXED TEXT	<ol style="list-style-type: none"> <li>1. Enter memory number of FIXED TEXT NO.: 1 ... 999.</li> <li>2. Enter text for the selected memory: max. of 20 characters.</li> <li>3. To load additional fixed texts, repeat the first two steps.</li> <li>4. End entry: Confirm FIXED TEXT NO. without entry with ENTER.</li> </ol>
CLEAR ALL TEXTS	Delete all text memories.
Comment	Fixed Text No. 20 is displayed during switch-on with a restart, see section 2.1.

<b>DELTA-FIX</b>	<b>Save target weight/tolerance combinations in DeltaTrac memory</b>
LOAD DELTA-FIX	<ol style="list-style-type: none"> <li>1. Enter memory number of DELTA-FIX No.: 1 ... 999.</li> <li>2. Enter target weight TARG in the displayed unit.</li> <li>3. Enter tolerance TOL in %.</li> <li>4. To enter additional Delta-Fix, repeat the first three steps.</li> <li>5. End entry: Confirm memory number without entry with ENTER.</li> </ol>
CLEAR ALL DELTA	Delete all DeltaTrac memories.

<b>DELTATRAC</b>	<b>Set DeltaTrac application</b>
TYPE	Select DeltaTrac application
FILLING	Weigh in target weight within a tolerance range (factory setting)
CLASSIFYING	Evaluate the test samples as good, too light or too heavy based on the target weight and tolerance
CHECKWEIGHING	Determine difference between target and actual weight
AUTO PRINT WITHIN TOL	Automatic printout when actual weight lies within the specified tolerance
PRINT ONLY WITHIN TOL	Printout only when actual value lies within the specified tolerance
MIN. DELTA	Specify minimum target weight, adjustable from 10 ... 100 d, factory setting: 40 d

<b>LANGUAGE</b>	<b>Select dialog language</b>
	Possible settings: German, English, French, Dutch, Italian, Spanish

<b>LAYOUT EXT. KEYBOARD</b>	<b>Select keyboard layout of connected external keyboard</b>
	Possible setting: Germany, England, France, Holland, Italy, Spain, Scandinavia, Russia, Poland, Belgium, Switzerland, Slovakia, Czech Republic, Latin America, Canada, ...

<b>KEYS A B C D</b>	<b>Name identification keys CODE A ... CODE D</b>
KEY A TEXT DATA LENGTH	Identifikation data CODE A Factory setting: ARTICLE NO. Max. 30 characters possible, factory setting: 20 characters
KEY B TEXT DATA LENGTH	Identifikation data CODE B Factory setting: ORDER NO. Max. 30 characters possible, factory setting: 20 characters
KEY C TEXT DATA LENGTH	Identifikation data CODE C Factory setting: CODE NO. Max. 30 characters possible, factory setting: 20 characters
KEY D TEXT DATA LENGTH	Identifikation data CODE D Factory setting: DOCUMENT NO. Max. 30 characters possible, factory setting: 20 characters

<b>DATE / TIME</b>	<b>Enter date and time</b>
TYPE EUROPE US	Select European notation: Day.Month.Year / (24) Hours.Minutes.Seconds  Select American notation: Month.Day.Year / (12) Hours.Minutes.Seconds AM/PM
DATE	Enter date according to the type selected
TIME	Enter time according to the type selected
Comments	<ul style="list-style-type: none"> <li>• Enter single-place numbers with a preceding zero.</li> <li>• Change over between AM and PM: Press FUNCTION CHANGE key.</li> <li>• Date and time can be printed out.</li> <li>• The clock continues to run after the terminal is switched off.</li> </ul>

<b>PERSONAL CODE</b>	<b>Load or delete code for entering the master mode</b>
CODE	Enter code with a maximum of 8 alphanumeric characters.
Comment	If no code is entered, access to the master mode is unrestricted.

<b>MASTER MODE START POS.</b>	<b>Select start position for entering the master mode</b>
NORMAL	Selection of the master mode blocks always begins with the TERMINAL block (factory setting).
LAST POSITION	When entering the master mode, the last block edited is displayed immediately.

<b>SCREEN SAVER</b>	<b>Switch screen saver on or off</b>
WAITING TIME	Enter time until screen saver is activated. Possible values: 1 ... 99 minutes
Comment	To hold all display elements at the same luminosity, we recommend not switching off the screen saver.

<b>BIG WEIGHT DISPLAY</b>	<b>Switch full-display indication of the weight on or off</b>
	Factory setting: BIG WEIGHT DISPLAY ON

<b>CONTROL MODE</b>	<b>Adjust control mode</b>
X10 KEY	Activation of control mode with X10 key (factory setting).
CONTROL MODE ON	This setting is only possible with non-certified scales. The weighing terminal always operates with the higher resolution.

<b>DYNAMIC WEIGHING</b>	<b>Set printing during dynamic weighing</b>
NO PRINT	Results during dynamic weighing are not automatically printed out (factory setting).
AUTO PRINT	Each result during dynamic weighing is automatically printed. Dynamic weights are marked with "Result:" on the printout.

ID5 MODE	Deactivating or activating downward compatibility with ID5												
	<p>If ID5 MODE ON is selected, the ID7-24V-Base is operated with downward compatibility to the ID5.</p> <p><b>Affected settings</b></p> <table data-bbox="491 499 1209 712"> <tr> <td>Text length of identification data</td> <td>18 characters</td> </tr> <tr> <td>Text length for keys CODE A ... D</td> <td>max. 18 characters</td> </tr> <tr> <td>Date/time</td> <td>dd/mm/yy, hh-mm-ss</td> </tr> <tr> <td>Barcode print command</td> <td>P\$#1EAN13</td> </tr> <tr> <td></td> <td>P\$#2Code 39</td> </tr> <tr> <td></td> <td>P\$#3EAN13</td> </tr> </table> <p>Factory setting: ID5 MODE OFF</p>	Text length of identification data	18 characters	Text length for keys CODE A ... D	max. 18 characters	Date/time	dd/mm/yy, hh-mm-ss	Barcode print command	P\$#1EAN13		P\$#2Code 39		P\$#3EAN13
Text length of identification data	18 characters												
Text length for keys CODE A ... D	max. 18 characters												
Date/time	dd/mm/yy, hh-mm-ss												
Barcode print command	P\$#1EAN13												
	P\$#2Code 39												
	P\$#3EAN13												

DISPLAY DURATION	Set display duration for messages
ERROR MESSAGES	Set display duration for error messages; factory setting: 2 seconds
INFO MESSAGES	Set display duration for informational messages; factory setting: 3 seconds

ENTRY PROMPT	Activating/deactivating entry prompt for Code A to D						
CODE A ... CODE D	<p>If ENTRY PROMPT CODE X ON is selected, an item cannot be weighed until the relevant code is entered.</p> <p>Other settings:</p> <table data-bbox="491 1301 1161 1406"> <tr> <td>REENTER</td> <td>The code must be entered again</td> </tr> <tr> <td>REPEAT</td> <td>The last entry is suggested again</td> </tr> <tr> <td>Factory setting:</td> <td>Entry prompt deactivated for all codes</td> </tr> </table>	REENTER	The code must be entered again	REPEAT	The last entry is suggested again	Factory setting:	Entry prompt deactivated for all codes
REENTER	The code must be entered again						
REPEAT	The last entry is suggested again						
Factory setting:	Entry prompt deactivated for all codes						
Note	<p>The entry prompt is activated by pressing the following keys:</p> <table data-bbox="491 1469 963 1574"> <tr> <td>ENTER</td> <td>with ID7-Base</td> </tr> <tr> <td>START</td> <td>with ID7-Dos</td> </tr> <tr> <td>PLUS or CONTAINER</td> <td>with ID7-Form</td> </tr> </table>	ENTER	with ID7-Base	START	with ID7-Dos	PLUS or CONTAINER	with ID7-Form
ENTER	with ID7-Base						
START	with ID7-Dos						
PLUS or CONTAINER	with ID7-Form						

RESET TERMINAL	Reset all terminal functions to the factory setting
	DELTATRAC                      Filling MASTER MODE START POS.      Normal BIG WEIGHT DISPLAY            On DYNAMIC WEIGHING            No printout CONTROL MODE                 X 10 key ID5 MODE                        Off DISPLAY DURATION             2 / 3 seconds ENTRY PROMPT                 Off
Comment	The memories are not affected by this.

## 4.4 SCALE master mode block

In the first block the weighing platform is selected: SCALE 1 ... SCALE 3.  
The other setting possibilities are the same for all connected weighing platforms.

### 4.4.1 Overview of the SCALE master mode block

In the SCALE master mode block the following settings for the weight can be carried out:

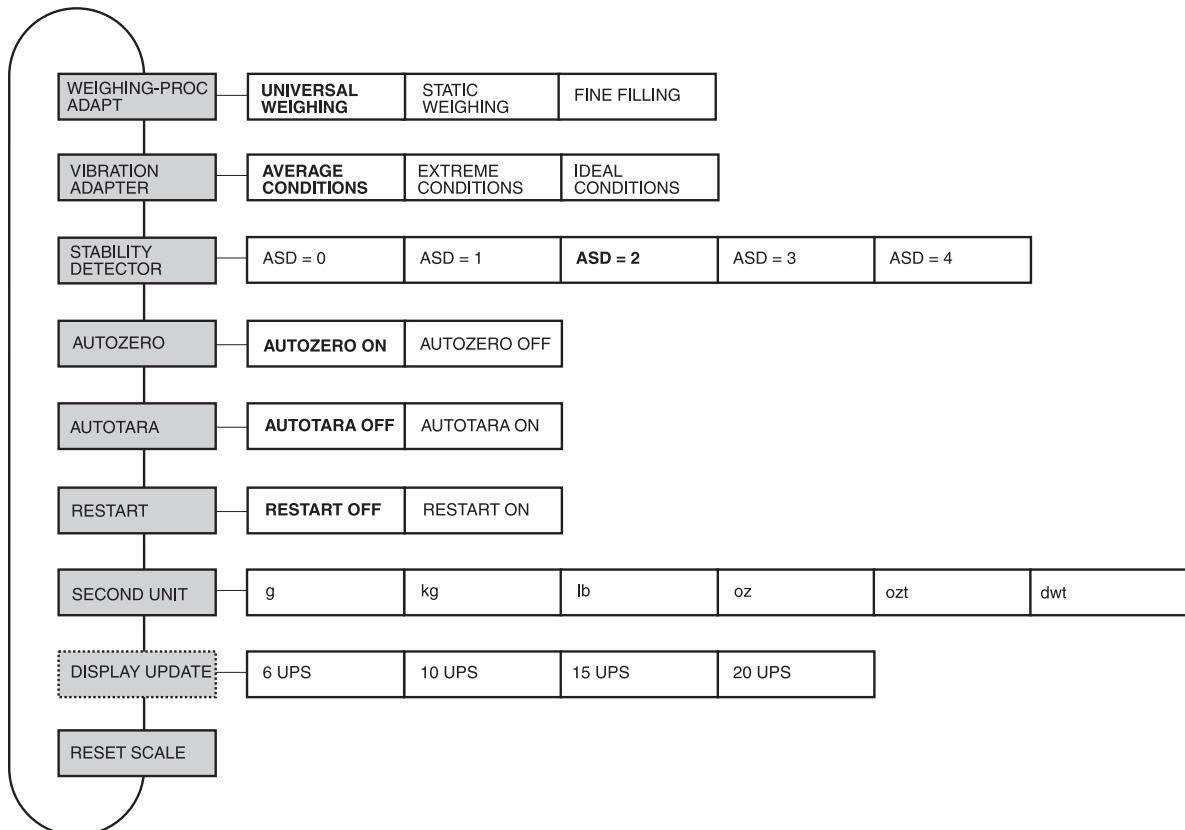

- Legend**
- Blocks highlighted in **grey** are described in detail in the following.
  - Factory settings are printed in **bold print**.
  - Blocks which only appear under certain conditions have a **dotted outline**.





<b>RESTART</b>	<b>Switch restart function on or off</b>
	<p>When RESTART ON is set, the zero point and tare value remain stored after the power supply is interrupted. When the weighing platform is switched on again, the terminal shows the current weight.</p> <p>Factory setting: RESTART OFF</p>

<b>SECOND UNIT</b>	<b>Select second weight unit</b>																					
	<p>Possible units: g, kg, lb, oz, ozt, dwt</p> <table border="1"> <thead> <tr> <th><b>Unit</b></th> <th><b>Abbreviation</b></th> <th><b>Conversion to g</b></th> </tr> </thead> <tbody> <tr> <td>Kilogram</td> <td>kg</td> <td>= 1000 g</td> </tr> <tr> <td>Pound</td> <td>lb</td> <td>≈ 453.59237 g</td> </tr> <tr> <td>Ounce</td> <td>oz</td> <td>≈ 28.349523125 g</td> </tr> <tr> <td>Troy Ounce</td> <td>ozt</td> <td>≈ 31.1034768 g</td> </tr> <tr> <td>Pennyweight</td> <td>dwt</td> <td>≈ 1.555173843 g</td> </tr> <tr> <td>Gram</td> <td>g</td> <td>= 1 g</td> </tr> </tbody> </table>	<b>Unit</b>	<b>Abbreviation</b>	<b>Conversion to g</b>	Kilogram	kg	= 1000 g	Pound	lb	≈ 453.59237 g	Ounce	oz	≈ 28.349523125 g	Troy Ounce	ozt	≈ 31.1034768 g	Pennyweight	dwt	≈ 1.555173843 g	Gram	g	= 1 g
<b>Unit</b>	<b>Abbreviation</b>	<b>Conversion to g</b>																				
Kilogram	kg	= 1000 g																				
Pound	lb	≈ 453.59237 g																				
Ounce	oz	≈ 28.349523125 g																				
Troy Ounce	ozt	≈ 31.1034768 g																				
Pennyweight	dwt	≈ 1.555173843 g																				
Gram	g	= 1 g																				
Comment	On certified weighing platforms only the units permitted by certification appear.																					

<b>DISPLAY UPDATE</b>	<b>Set display speed of the weight display</b>
	<p>Select number of updates per second (UPS).</p> <p>Possible values: 6, 10, 15, 20 UPS</p>
Comments	<ul style="list-style-type: none"> <li>• This block only appears when the DISPLAY UPDATE function is supported by the connected weighing platform.</li> <li>• The possible settings are dependent on the connected weighing platform.</li> </ul>

<b>RESET SCALE</b>	<b>Reset weighing platform to factory setting</b>												
	<table border="1"> <tbody> <tr> <td>WEIGHING-PROC ADAPT</td> <td>universal weighing</td> </tr> <tr> <td>VIBRATION ADAPTER</td> <td>average conditions</td> </tr> <tr> <td>STABILITY DETECTOR</td> <td>ASD = 2</td> </tr> <tr> <td>AUTOZERO</td> <td>on</td> </tr> <tr> <td>AUTOTARA</td> <td>off</td> </tr> <tr> <td>RESTART</td> <td>off</td> </tr> </tbody> </table>	WEIGHING-PROC ADAPT	universal weighing	VIBRATION ADAPTER	average conditions	STABILITY DETECTOR	ASD = 2	AUTOZERO	on	AUTOTARA	off	RESTART	off
WEIGHING-PROC ADAPT	universal weighing												
VIBRATION ADAPTER	average conditions												
STABILITY DETECTOR	ASD = 2												
AUTOZERO	on												
AUTOTARA	off												
RESTART	off												

## 4.5 INTERFACE master mode block

**Select the interface connection** → Select the interface connection in the first block:  
COM1, COM2, COM3, COM4, COM5 or COM6.

**Select interface type** → Specify the interface type for the selected interface connection COM1 ... COM6.

- Possible interface types**
- NOT ASSIGNED When the selected interface connection is not assigned.
  - GA46 For connection of the GA46/GA46-W printer. Data is exchanged via the RS232-ID7 interface. The other setting possibilities are described in the operating and installation instructions GA46. This selection no longer appears when a GA46 printer is already configured.
  - BARCODE For connection of a barcode reader. Data is exchanged via the RS232-ID7 interface. For other settings see 4.5.3.
  - RS232 An RS232-ID7 interface must be installed on the selected interface connection for this purpose. For other settings see 4.5.2.
  - ALIBI MEMORY Only for COM2 ... COM6. An Alibi Memory-ID7 must be installed on the selected interface connection for this purpose. No further settings are required in the master mode. This selection no longer appears when an Alibi Memory-ID7 is already configured.
  - CL20mA Only for COM2 ... COM6. A CL20mA-ID7 interface must be installed on the interface connection for this purpose. For other settings see 4.5.2.
  - RS422 Only for COM5/COM6. An RS422-ID7 interface must be installed on the interface connection for this purpose. For other settings see 4.5.2.
  - RS485 Only for COM5/COM6. An RS485-ID7 interface must be installed on the interface connection for this purpose. For other settings see 4.5.2.
  - 4 I/O Only for COM5/COM6. A 4 I/O-ID7 interface with relay box 4-ID7 must be installed on the interface connection for this purpose. For other settings see 4.5.4.
  - RELAY BOX 8 Only for COM5/COM6. An RS485-ID7 interface with relay box 8-ID7 must be installed on the interface connection for this purpose. For other settings see 4.5.4.
  - ANALOG OUTPUT Only for COM5/COM6 with installed Analog Output-ID7 interface.
  - ETHERNET Only for COM5/COM6 with installed Ethernet-ID7 interface.
  - PROFIBUS-DP Only for COM2 ... COM6 with installed Profibus-DP-ID7 interface.

- **SCALE SICS** For connecting a reference scale. For this purpose an RS232-ID7 interface must be installed on the selected interface connection and the reference scale must be capable of processing at least the SICS Level 0 command set. This selection no longer appears if a total of 3 scales are already connected to the ID7-24V-Base.  
When SCALE SICS is selected, the following default settings are set: SICS mode, 9600 baud, 8 data bits, 1 stop bit, no parity. For additional settings, see 4.5.2.
- **WLAN** Only for COM2 ... COM6 with installed WLAN-ID7 interface.

#### 4.5.1 Overview of the master mode blocks RS232, RS422, RS485, CL20mA

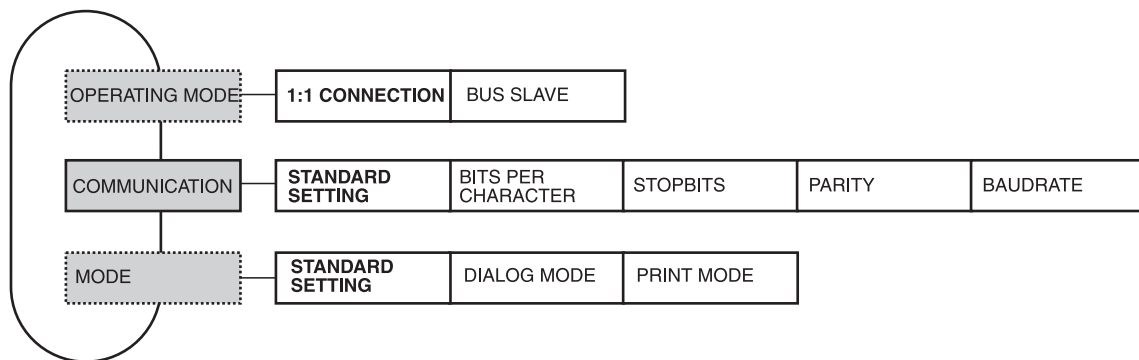

- Legend**
- Blocks highlighted in **grey** are described in detail in the following.
  - Factory settings are printed in **bold print**.
  - Blocks which only appear under certain conditions have a **dotted outline**.

#### 4.5.2 Settings in the master mode blocks RS232, RS422, RS485, CL20mA

RS232, RS422, RS485, CL20mA	
OPERATING MODE	This selection only appears with the RS485 master mode block.
1:1 CONNECTION	ID7-24V-Base weighing terminal and peripheral are directly connected.
BUS SLAVE	For operating the ID7-24V-Base weighing terminal in a bus system. The following parameters are set automatically for the dialog: No handshake, no continuous transmission, no transfer string, fixed string framing $C_{R\text{LF}}$ . The PC is the master, the terminals act as slaves and only transmit when requested to do so by the master. The master must also wait until after sending out a command until the slave's answer is received. Each terminal must be assigned a unique address. Additional setting: ENTER TERMINAL ADDRESS. Possible addresses: 1 ... 31
COMMUNICATION	Set communication parameters (factory settings are shown in bold print). All parameters are shown on a display page and can be set there; for function key assignment, see page 47.
BITS PER CHARACTER	Possible settings: <b>7 bits</b> , 8 bits
STOPBITS	Possible settings: 1 stop bit, <b>2 stop bits</b>
PARITY	Possible settings: <b>Parity even</b> , parity odd, parity space, parity mark, no parity
BAUDRATE	Possible settings: 150, 300, 600, 1200, <b>2400</b> , 4800, 9600, 19200 baud
MODE	Set operating mode. This selection does not appear when interface RS485-ID7 is operated in the BUS SLAVE operating mode.
STANDARD SETTING	Set operating mode to factory setting: MMR dialog mode, no handshake, no auto transmission (no continuous transmission), transfer string: Standard, string framing: $C_{R\text{LF}}$
DIALOG MODE	For dialog between ID7-24V-Base weighing terminal and computer. For other settings see next section.
PRINT MODE	To print weighing data, e. g. on a form printer. For other settings see page 46.

## Set dialog mode

DIALOG MODE	Set dialog between ID7-24V-Base weighing terminal and computer
<p>MMR</p> <p>HANDSHAKE</p> <p>AUTOMATIC CONTINUOUS TRANSMISSION</p> <p>TRANSFER STRING</p>	<p>For information on dialog mode with the MMR command set, see section 5.1. All parameters are shown on a display page and can be set there; for function key assignment, see page 44.</p> <p>Possible settings:</p> <ul style="list-style-type: none"> <li>• NO HANDSHAKE</li> <li>• CL HANDSHAKE – for additional information on the CL handshake, see page 45.</li> <li>• XON-XOFF PROTOCOL.</li> </ul> <p>This block does not appear with the RS485-ID7 interface.</p> <p>Possible settings:</p> <ul style="list-style-type: none"> <li>• NO AUTO TRANSMISSION.</li> <li>• AUTO SIR – after each measuring cycle a stabilized or dynamic weight is transmitted.</li> <li>• AUTO DIR – weight values are transmitted as with AUTO SIR and additionally, the special characters in the display are transmitted for a second display. Fixed communications parameters: 9600 baud, 7 data bits, 2 stop bits, parity even</li> <li>• AUTO SR – after each weight change which is greater than the set value, a motionless weight value and then a dynamic weight value are sent</li> </ul> <p>This block does not appear with the RS485-ID7 interface.</p> <p>Possible settings:</p> <ul style="list-style-type: none"> <li>• STANDARD – gross, net, tare</li> <li>• OPTION 082/083 – gross, net, tare in GNT form, see operating instructions, Option 082.</li> <li>• USER-DEFINED – enter numbers of the application blocks which are to be transmitted or printed out.</li> </ul>
<p>STRING FRAMING</p>	<p>Possible settings:</p> <ul style="list-style-type: none"> <li>• ---&lt;CR&gt;&lt;LF&gt; (Factory setting)</li> <li>• &lt;STX&gt;---&lt;ETX&gt;</li> <li>• BLOCK CHECK CHAR</li> <li>• ---&lt;CR&gt;</li> </ul>
<p>SICS</p> <p>STANDARD</p> <p>HANDSHAKE</p> <p>AUTOREPEAT</p>	<p>Dialog mode with Standard Interface Command Set (SICS), see section 6.3.</p> <p>Standard setting: no handshake, no auto transmission.</p> <p>Possible settings as MMR, see above.</p> <p>Possible settings as MMR, see above.</p> <p>AUTO-DIR not possible with SICS.</p>

<b>DIALOG MODE</b>	<b>Set dialog between ID7-24V-Base weighing terminal and computer</b>
TOLEDO CONTINUOUS	For the continuous transmission of net and tare values to METTLER TOLEDO devices, e. g. to a second display. For a description, see section 5.2. This block does not appear with the RS485-ID7 interface.
CHECKSUM ON	Checksum byte active, factory setting
CHECKSUM OFF	Checksum byte inactive, the transfer format is shortened by 1 character.
TOLEDO SHORT CONTINUOUS	For the continuous transmission of net values to METTLER TOLEDO devices, e. g. to a second display. For a description, see section 5.2. This block does not appear with the RS485-ID7 interface.
CHECKSUM ON	Checksum byte active, factory setting
CHECKSUM OFF	Checksum byte inactive, the transfer format is shortened by 1 character.
PE SEND CONTINUOUS	For connecting a PE balance as a reference balance, only with ID7 Count and Interface CL20mA-ID7.

### Enter data interface parameters

**Function keys** With the master mode blocks COMMUNICATION and STRING FRAMING the function keys are assigned as follows:

<->	<	>		<b>STD</b>	↑
Choose parameter	Adjust parameter			Choose standard setting; lights up, when factory setting active	Confirm selection and return to higher-level block

**CL handshake**

With the CL handshake 3 types of interface control are possible:

Handshake in receiving direction, in transmitting direction and in both directions.

After switch-on and after each interruption, the ID7-24V-Base attempts to establish the handshake in both directions.

**CL handshake in receiving direction**

This type of CL handshake is suitable for data transmission from the ID7-24V-Base to the computer.

1. The ID7-24V-Base transmits SYN after switch-on.
2. The computer transmits the character ACK after switch-on or after receiving SYN.
3. ID7-24V-Base then sends the response to a command or to a key actuation after each ACK.

**CL handshake in transmission direction**

This type of CL handshake is suitable for data transmission from the computer to the ID7-24V-Base.

1. The ID7-24V-Base transmits SYN after switch-on.
2. The computer transmits the character SYN after switch-on or after receiving SYN.
3. ID7-24V-Base acknowledges the receipt of SYN again with SYN and signals its readiness to receive with ACK.
4. Then the computer can transmit a command after each ACK.

**CL handshake in both directions**

1. The ID7-24V-Base transmits SYN after switch-on.
2. The computer transmits the character SYN after switch-on or after receiving SYN.
3. ID7-24V-Base acknowledges the receipt of SYN again with SYN and signals its readiness to receive with ACK.
4. The computer signals its readiness to receive with ACK.
5. During operation the ID7-24V-Base receives data and transmits ACK when it is ready to receive data again.  
The computer receives data and transmits ACK when it is ready to receive data again.

## Set print mode

PRINT MODE	Configure printout on an external printer
HANDSHAKE	Possible settings: <ul style="list-style-type: none"> <li>• NO HANDSHAKE</li> <li>• XON-XOFF PROTOCOL</li> </ul>
LINE LENGTH	Enter number of characters per line. Possible settings: 1 ... 80 characters Factory setting: 40 characters
LINE FRAMING	Enter ASCII character for line framing. Possible settings: ASCII 0 ... 255 Factory setting: ASCII 013 010 (C <sub>R</sub> L <sub>F</sub> )
REPORT TYPE	Assignment of one of two possible printout formats to the configured printer. Possible settings: <ul style="list-style-type: none"> <li>• REPORT TYPE A e.g. for barcode printer</li> <li>• REPORT TYPE B e.g. for A4 printer</li> </ul>
CONFIGURATION PRINTOUTS  TRANSFER KEY CODE A KEY ... CODE D KEY DYNAMIC KEY Pac keys	Configuration of the printouts assigned to the individual keys. For each offered key, the current configuration can be printed out with the key sequence CHANGE CONFIGURATION, F▶ (possibly several times) and PRINT.  Configuration options: <ul style="list-style-type: none"> <li>• DELETE ALL All blocks of the data string are deleted</li> <li>• DEFAULT SETTING Key-specific, if existent</li> <li>• CHANGE CONFIGURATION See next section</li> <li>• PAPER FEED Adjustment range: 0 ... 9 lines</li> <li>• REPORT ON/OFF Switch key printout on/off</li> </ul>
AUTOMATIC PRINTOUT	Switch automatic printout for transfer key on/off. When AUTO PRINTOUT ON is selected, a printout for the transfer key is automatically created for each weight change > x digits. Possible settings: 1 ... 255 digits (factory setting: 10 digits)



## Change configuration

**Function keys** The function keys are assigned in CHANGE CONFIGURATION as follows:

	<	>	F▶	ADD	↑
	Display previous entry	Display next entry	Select function of function key F5: ADD, INS etc.	ADD INS EDIT DEL PRINT	Return to next highest level; changes are not saved

The printout can be edited with function key F5:

ADD	Adds a new entry at the end of the printout.
INS	Inserts a new entry in front of the displayed entry.
EDIT	Changes into the EDIT mode for the displayed entry to edit the entry.
DEL	Deletes the displayed entry.
PRINT	Creates a key printout.

## EDIT mode

**Function keys** The following function keys are available in the EDIT mode:

<->	<	>	F▶	SAVE	↑
Select parameters	Set parameters, scroll back	Set parameters, scroll forward	Select function of function key F5: SAVE, EDIT	Confirm changes and return to higher level	Cancel EDIT mode and return to higher level; changes are not saved

**Display page** The setting of the parameters of an entry appears in a clear layout on a display page (example):









TRANSFER KEY	[EDIT]	(2/7)
TYPE: AB		STYLE: <input type="text" value="u"/>
CRLF: YES	FILL: NO	PAD: 01
DATA:		011-013

**First display line** Information for orientation in an entry



- Key name
- Mode: EDIT, INS or ADD
- Number of the display entry and total number of entries for the current printout.

<b>TYPE parameter</b>	Selection possibilities:
AB	Output content of an application block with or without designation
TEXT	Print out any desired text
CHRn	Insert n of any desired ASCII characters in the line, e.g. for tables; selection of character via DATA parameter
LINE	Blank line or separator line with any desired alphanumeric characters
DB	Accesses a database field. When a field is printed out, all entries of the field are listed. The option DB is only available when the software application supports access to a database. The offered database fields are application-specific.

**STYLE parameter** STYLE determines in which format the designation and content of the application block are printed; adjustment possibilities:

TYPE	STYLE
AB DB	 Designation and content in grouped style
	 Designation and content in two lines, grouped style
	 Designation and content separated with extra blank spaces
	 Content alone, left-justified
	 Content alone, centred
	 Content alone, right-justified
TEXT	 Left-justified
	 Centred
	 Right-justified



**CRLF parameter** Force line feed; the CRLF parameter is only available for:

-  Text, left-justified
-  Content alone, left-justified
-  Designation and content separated with extra blank spaces
- Type CHRn

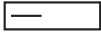
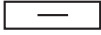
**FILL parameter** Show content with leading blank spaces up to maximum available length; the FILL parameter is only available for:

-  Designation and content separated with extra blank spaces
-  Content alone, left-justified
-  Content alone, centred

**PAD parameter** Show designation and content separated with x blank spaces  
Possible settings: 0 ... 63 extra blank spaces.  
The PAD parameter is only available for:

-  Designation and content separated with extra blank spaces
-  Content alone, left-justified

**DATA/FIELD parameter** Depending on the TYPE selected, DATA or FIELD is available.

TYPE	DATA/ FIELD	ENTRY
LINE	DATA	1 alphanumeric character Entry also possible as ASCII code, see below
AB	DATA	Number of application blocks to be output: xxx The application block can be further specified with the following keys: AB_EXT: _ For selecting read-only memories: xxx_yyy SUB-BLK: . For selecting a sub-block: xxx.z or xxx_yyy.z RANGE: - For entering a range: xxx-xxx or xxx_yyy-yyy
CHRn	DATA	1 alphanumeric character Entry also possible as ASCII code, see below
TEXT	DATA	Alphanumeric characters
DB	FIELD	Select database field

#### Entry of DATA parameter

To enter data or select database fields, the EDIT mode must be active.

1. Press **F▶** key, repeat if necessary until the assignment of the F5 key changes to EDIT.
2. Press the EDIT key; an input mask appears.
3. Enter data in the format and with the keys offered.
4. Complete entry with ENTER.

**Enter ASCII code for LINE and CHRn parameters**

1. Open the entry mask with the EDIT key.
2. Press the +/- key and enter the ASCII code numerically.
3. Complete the numeric entry with the +/- key.
4. Complete entry with ENTER.

**4.5.3 Set barcode reader**

BARCODE	Set barcode reader
TYPE DL900/DL910 DLL6000 ... OTHER	Select barcode reader. When one of the barcode readers is selected, the communication and mode parameters for the selected barcode reader are automatically set. For other barcode readers: Settings in the sub-blocks COMMUNICATION and MODE as for the blocks RS232/RS422/RS485/CL20mA, see section 4.5.2. The PRINT MODE setting is not possible when using barcode readers!
DESTINATION BLOCK 000/00	Enter the number of the application block and of the subsequent block with which the barcode entry is to be described. When a target block is selected, barcode information can be read directly into this block without having to press a key beforehand, see section 3.14.2.
AUTOMATIC ENTRY	If AUTOMATIC ENTRY ON is selected, the received barcode is shown in the display and is then accepted as the entry automatically. The display duration can be set in the TERMINAL master mode block. See section 4.3.

#### 4.5.4 Configure inputs/outputs

4 I/O / RELAY BOX 8	
INPUT	Operate inputs internally or externally.
INTERNALLY	<p>Factory setting. Additional settings:</p> <p>CONFIGURE INPUTS Select the desired setting for every input.  Factory setting for ID7-Base:  Input 1 not in use  Input 2 zero setting  Input 3 taring  Input 4 entry (ENTER key)  Input 5  ... not in use  Input 8</p> <p>Additional settings, only for 4 I/O:  ON/OFF HIGH ACTIVE Factory setting, the ID7-24V-Base is switched off when ON/OFF = 1. After the digital input has been activated, the display goes out, and the content of the text read-only memory 021, factory setting appears in the upper left corner: POWER OFF.  ON/OFF LOW ACTIVE The ID7-24V-Base is switched off when ON/OFF = 0.</p> <p><b>Note:</b> The input ON/OFF has priority over the keyboard, i.e. the ID7-24V-Base can only be switched on again in the POWER OFF state via the ON/OFF input! In addition, entry into the master mode is permitted via the F6 key to be able to correct incorrect settings.</p>
EXTERNALLY	<p>Inputs are independent of the weighing functions.  Read status of the inputs with the AR707 command, see section 6.3.2.</p>
OUTPUT	Operate outputs internally or externally.
INTERNALLY	<p>Factory setting. Additional settings:</p> <p>CONFIGURE OUTPUTS Select the desired setting for every output.  Factory setting for ID7-Base:  Output 1 Delta low  Output 2 Delta ok  Output 3 Delta high  Output 4 Stable  Output 5 Setpoint 1  Output 6 Setpoint 2  Output 7 Setpoint 3  Output 8 Setpoint 4</p> <p>SETPOINT MODE With SETPOINT MODE ON 4 configurable fixed or dynamic set points are available, see page 53.</p>
EXTERNALLY	<p>Outputs are independent of the weighing functions.  Set the outputs via the AW706... command, see section 6.3.2.</p>

4 I/O / RELAY BOX 8	
I/O TEST	<p>Testing of the function and state of the inputs and outputs of one or two connected 8-ID7 relay box(es)</p> <p>If an input or output is set (high), the display indicates its number. If an input or output is not set (low), the display indicates –.</p> <p><b>Set outputs</b> Switch over the outputs with the keys 1 to 8 of the numerical keypad.</p> <p><b>Set inputs</b> Set inputs, e. g. by connecting a supply voltage (+24 V).</p> <p><b>Two 8-ID7 relay boxes</b> Switch back and forth between the two 8-ID7 relay boxes with key 9 of the numerical keypad.</p> <p><b>Exit I/O TEST</b> Exit the I/O test and the master mode with the 0 key of the numerical keypad.</p>
Comments	<ul style="list-style-type: none"> <li>• During the I/O tests only the keys ZERO SET, TARE and ENTER are active.</li> <li>• Serial interfaces can be used during the I/O test.</li> <li>• The 8-ID7 relay box corresponds to the binary interface unit (BIU). For additional information see the operating instructions for the Binary Interface Unit 505981.</li> </ul>

**SETPOINT MODE ON –  
defining set points**

After SETPOINT MODE ON is selected, the following input mask appears (Example):

SP1:	F↑	AO12	W1	1.2345 KG
SP2:	F↓	AO13	W2	0.5678 KG
SP3:	D↑	AO12	ALL	
SP4:	D↓	AO11	ALL	

4 parameters can be set for each set point:

**a) Type of set point**

- F↑ fixed set point, ascending
- F↓ fixed set point, descending
- D↑ dynamic set point, ascending
- D↓ dynamic set point, descending

Fixed set point Set point value is specified in the master mode and cannot be changed in the weighing mode.

Dynamic set point Set point value is specified in the weighing mode, see Section 3.6.

Ascending Digital output is set when the value of the application block concerned is greater than or equal to the set point value.

Decending Digital output is set when the value of the application block concerned is less than or equal to the set point value.

**b) Application block**

Weight value to which the set point refers. All application blocks with a valid weight unit (kg, g, lb, oz, ozt, dwt, pc) are possible.

Factory setting: Application block 012, net weight

**c) Scale**

W1 ... W3 or ALL for all scales

**d) Set point value**

With dynamic set points the weight value is entered in the normal mode, see Section 3.6.

**Function key assignment**

<->	<	>		EDIT	↑
Select parameters	Scroll through valid input values, forward	Scroll through valid input values, backward		Edit selected parameter	Return to next highest level; settings are accepted as displayed

## 5 Interface description

To exchange data with a computer, the ID7-24V-Base weighing terminal is equipped with an RS232 interface. Up to 5 additional interfaces are available as an option. The interfaces operate independently of each other, can be used simultaneously and can be adjusted individually, see section 4.5.

To operate the serial interfaces in the **dialog mode**, one of the following METTLER TOLEDO command sets must be selected in the master mode:

- MMR command set, see section 5.1.
- METTLER TOLEDO Continuous mode, see section 5.2.
- METTLER TOLEDO SICS command set, see section 5.3.

### 5.1 MMR command set

#### 5.1.1 Syntax and formats of communication

Commands and responses for transmitting weights have the following formats:

##### Command format when transmitting weight formats

Identification	_	Weight value	_	Unit	Framing
Character sequence for specification of command (1 ... 4 characters)		1 ... 8 digits, number of digits variable		1 ... 3 characters, number of characters variable	Definable in master mode, factory setting: C <sub>R</sub> L <sub>F</sub>

##### Response format when transmitting weight formats

Identification	_	Weight value	_	Unit	Framing
Character sequence for specification of response (2 ... 3 characters)		10 digits, right-justified, filled out with blank spaces		3 characters, left-justified, filled out with blank spaces	definable in master mode, factory setting: C <sub>R</sub> L <sub>F</sub>

##### Example

Command Tare specification

T \_ 1 3 . 2 9 5 \_ k g

Response Tare specification

T B H \_ \_ \_ \_ \_ 1 3 . 2 9 5 \_ k g \_



**Data formats**

- The following symbols are used in the following command description:

<u>Weight value</u>	10 characters with sign and decimal point, right-justified (with preceding blank spaces)
<u>Unit</u>	3 characters, left-justified (with following blank spaces)
<u>Text_n</u>	maximum of n characters, left-justified

- The string framing is mandatory, however it is **not** contained in the following command description!
- Enter commands as ASCII characters. The following ASCII characters are available: 20 hex/32 deci ... 7F hex/127 deci, see section 9.1.

**BUS SLAVE  
operating mode  
(RS485)**

In the BUS SLAVE operating mode each command and each response begins with a code for the terminal address.

Terminal address 1 ... 9 Code "1" ... "9" (31H ... 39H)

Terminal address 10 ... 31 Code "a" ... "v" (61H ... 76H)

**Example**

Command to terminal 3: 

3	S
---	---

Response from terminal 3: 

3	S	_	_	_	_	_	_	1	2	.	7	6	5	_	k	g	_
---	---	---	---	---	---	---	---	---	---	---	---	---	---	---	---	---	---

### 5.1.2 Command overview

Command	Meaning	Page
RO / R1	Switch keypad on/off	57
KD / KE	Switch individual key on/off	57
Z	Set weight display to zero after weighing platform stabilization	57
U_...	Change over terminal to a different weight unit	57
T	Tare	58
T_...	Specify tare weight	58
DY_...	Specify DeltaTrac target value	59
S	Transmit in case of weighing platform stabilization	59
SI	Transmit independent of weighing platform stabilization	59
SIR	Transmit repeatedly independent of weighing platform stabilization	59
SR	Transmit stabilized weight values repeatedly depending on a weight change	59
SR_...	Transmit repeatedly depending on weighing platform stabilization with specification of an excursion value	59
SX	Transmit data record after weighing platform stabilization	60
SXI	Transmit data record independent of weighing platform stabilization	60
SXIR	Transmit data record repeatedly independent of weighing platform stabilization	60
ARNo.	Read information of application block	61
AWNo._...	Write to application block	61
D_...	Write to display	61
P_...	Print alphanumeric characters or barcodes on the GA46	62,62
DS	Trigger acoustic signal	62
ID	Interrogate terminal identification	62
W_...	Actuating digital outputs	63

### 5.1.3 Command description

#### Switch keypad on or off

Command	<code>R,0</code> <code>R,1</code>	Switch on keypad Switch off keypad
Response	<code>R,B</code>	Keypad switched on or off
Comments	<ul style="list-style-type: none"> <li>• Factory setting: Keypad switched on.</li> <li>• When the keypad is switched off, the terminal cannot be operated manually.</li> </ul>	

#### Switch individual key on or off

Command	<code>K,E,_,x,x</code> <code>K,D,_,x,x</code>	Switch on key with key number xx Switch off key with key number xx
Response	<code>K,B</code>	Key switched on or off
Noteen	<ul style="list-style-type: none"> <li>• Factory setting: Keys switched on.</li> <li>• See table in the Appendix for key numbers.</li> </ul>	

#### Set zero

Command	<code>Z</code>	Set gross weight display to zero after weighing platform stabilization, effect as when ZERO-SET key is pressed.
Response	<code>Z,B</code> <code>Z,-</code> <code>Z,+</code>	Weighing platform set to zero Command cannot be executed: Zero-set range dropped below Command cannot be executed: Zero-set range exceeded
Comments	<ul style="list-style-type: none"> <li>• Setting to zero is not possible when the weighing platform stabilizes in the zero-set range.</li> <li>• With some weighing platform types setting to zero deletes a saved tare weight. This is indicated with the message TA, see section 5.1.4.</li> </ul>	

#### Changing over to different weight unit

Command	<code>U,_,Unit</code> <code>U</code>	Change over weight display to different weight unit Change over weight display to first weight unit
Response	<code>U,B</code>	Weight display changed over to different weight unit
Comment	Possible units: g, kg, lb, ozt, oz, dwt	

**Tare**

<p>Command</p>	<p><input type="text" value="T"/> Tare weighing platform: After the weighing platform stabilizes, the current weight value is saved as the tare weight and the weight display is set to zero with the weight placed on the platform. Effect as when TARE key is pressed.</p> <p><input type="text" value="T"/> <input type="text" value="_"/> Tare weight (weight value) <input type="text" value="_"/> <input type="text" value="Unit"/> Specify tare weight: The content of the tare memory is overwritten with the specified tare weight and the net weight is displayed. Effect as when TARE ENTRY, 0 ... 9, ENTER key sequence is pressed.</p> <p><input type="text" value="T"/> <input type="text" value="_"/> Delete tare weight.</p>
<p>Response</p>	<p><input type="text" value="T"/> <input type="text" value="B"/> <input type="text" value="_"/> <input type="text" value="_"/> Tare weight (weight value) <input type="text" value="_"/> <input type="text" value="Unit"/> Weighing platform is tared</p> <p><input type="text" value="T"/> <input type="text" value="B"/> <input type="text" value="H"/> <input type="text" value="_"/> Tare weight (weight value) <input type="text" value="_"/> <input type="text" value="Unit"/> Weighing platform is tared with specified weight</p> <p><input type="text" value="T"/> <input type="text" value="-"/> Command cannot be executed: Tare range dropped below</p> <p><input type="text" value="T"/> <input type="text" value="+"/> Command cannot be executed: Tare range exceeded</p>
<p>Comments</p>	<ul style="list-style-type: none"> <li>• Taring is only possible when the weighing platform stabilizes within the tare range.</li> <li>• The tare weight is always transmitted in the first weight unit.</li> <li>• Each taring command overwrites the content of the tare memory with the new tare weight.</li> <li>• Taring with an unloaded weighing platform deletes the tare memory. On some weighing platform types a zero set is carried out in the unloaded state. This is displayed with the message ZA, see section 5.1.4.</li> <li>• On not certified weighing systems the tare weight is automatically rounded to the current increment.</li> <li>• On certified weighing systems: Tare range for MultiRange only in first increment range.</li> </ul>
<p>Example</p>	<p>Command: <input type="text" value="T"/></p> <p>Response: <input type="text" value="T"/> <input type="text" value="B"/> <input type="text" value="_"/> <input type="text" value="_"/> <input type="text" value="1"/> <input type="text" value="2"/> <input type="text" value="."/> <input type="text" value="6"/> <input type="text" value="5"/> <input type="text" value="0"/> <input type="text" value="_"/> <input type="text" value="k"/> <input type="text" value="g"/> <input type="text" value="_"/></p>

**Specify DeltaTrac target value**

Command	<input type="text" value="D,Y"/> Target weight (weight value) <input type="text" value=""/> Unit <input type="text" value=""/> Tolerance <input type="text" value=""/> % Specify DeltaTrac target value <input type="text" value="D,Y"/> Delete DeltaTrac target value
Response	<input type="text" value="D,B"/> DeltaTrac target value loaded/deleted
Comments	<ul style="list-style-type: none"> <li>Observe limit values, see section 3.1.1</li> <li>Also possible: <input type="text" value="A,W,0,2,0,..."/> , see section 6.2</li> </ul>
Example	Command: <input type="text" value="D,Y,4.5,kg,5%"/> Response: <input type="text" value="D,B"/>

**Transmit content of display**

Command	<input type="text" value="S"/> Transmit a stabilized weight when weighing platform is stabilized. <input type="text" value="S,I"/> Transmit a stabilized or dynamic weight independent of weighing platform stabilization.
Response	<input type="text" value="S,Weight value,Unit"/> Stabilized weight value transmitted <input type="text" value="S,D,Weight value,Unit"/> Dynamic weight value transmitted <input type="text" value="S,I"/> Invalid weight <input type="text" value="S,I,-"/> Weighing platform in underload range <input type="text" value="S,I,+"/> Weighing platform in overload range

**Transmit content of display repeatedly**

Command	<input type="text" value="S,I,R"/> Transmit stabilized or dynamic weight values after each measuring cycle independent of weighing platform stabilization. <input type="text" value="S,R"/> Transmit the next stabilized weight value after a weight change (e. g. different item) and one dynamic and the next stabilized weight value after each deflection > 30 d.  <input type="text" value="S,R,Deflection weight (weight value),Unit"/> Transmit the next stabilized weight value and, depending on the specified deflection, a dynamic weight value after a weight change greater than the specified deflection value.
Response	<input type="text" value="S,Weight value,Unit"/> Transmit stabilized weight value repeatedly <input type="text" value="S,D,Weight value,Unit"/> Transmit dynamic weight value repeatedly
Comment	Stop command with <input type="text" value="S"/> , <input type="text" value="S,I"/> command or by interrupting the interface
Example	Command: <input type="text" value="S,R,1,4,0,kg"/> Responses: <input type="text" value="S,2,0,0.0,kg"/> 1st item <input type="text" value="S,D,3,4,5.8,kg"/> <input type="text" value="S,4,1,0.5,kg"/> 2nd item

**Transmit data record**

<p>Command</p>	<p><code>S,X</code> Transmit a data record with stabilized weight values after weighing platform stabilization. Effect as if ENTER key is pressed.</p> <p><code>S,X,I</code> Transmit a data record with stabilized or dynamic weight values independent of weighing platform stabilization.</p> <p><code>S,X,I,R</code> Transmit data records with stabilized or dynamic weight values repeatedly independent of weighing platform stabilization.</p>
<p>Response</p>	<p><code>S,X,_,_ Application block _ _ Application block [...]</code>     <code>A No. _ Data record</code> Data record with stabilized weight values transmitted</p> <p><code>S,X,D _ Application block _ _ Application block [...]</code>     <code>A No. _ Data record</code> Data record with dynamic weight values transmitted</p> <p><code>S,X,I</code> Invalid value  <code>S,X,I-</code> Weighing platform in underload range  <code>S,X,I+</code> Weighing platform in overload range</p>
<p>Comments</p>	<ul style="list-style-type: none"> <li>• Number of application block: three-digit with leading zeros.</li> <li>• The content of the corresponding application block is contained in data record, see chapter 6. Standard data record consists of 3 blocks:  <code>S,X,_,_ A,0,1,1 _ Gross weight (weight value) _ Unit _ _</code>  <code>A,0,1,2 _ Net weight (weight value) _ Unit _ _</code>  <code>A,0,1,3 _ Tare weight (weight value) _ Unit</code></li> </ul> <p>The continuous transmission of data records started with the <code>S,X,I,R</code> command can be stopped with the <code>S,X</code> or <code>S,X,I</code> command.</p>
<p>Example</p>	<p>Command: <code>S,X,I</code></p> <p>Response: Standard data record</p> <pre> S,X,D _ A,0,1,1 _ _ _ _ _ 2,3 . 6,5,0 _ k,g _ _ _ A,0,1,2 _ _ _ _ _ 2,1 . 6,5,0 _ k,g _ _ _ A,0,1,3 _ _ _ _ _ 2 . 0,0,0 _ k,g _     </pre>

**Read application block**

Command	<input type="text" value="A"/> <input type="text" value="R"/> <input type="text" value="No."/> <input type="text"/>	Read content of application block
Response	<input type="text" value="A"/> <input type="text" value="B"/> <input type="text" value="Information"/>	Content of application block transmitted
Comments	<ul style="list-style-type: none"> <li>• Transmitted information is dependent on application block, see chapter 6.</li> <li>• Number of application block must be entered as 3 digits with preceding zeros.</li> </ul>	

**Write to application block**

Command	<input type="text" value="A"/> <input type="text" value="W"/> <input type="text" value="No."/> <input type="text" value="Information"/>	Write to application block
	<input type="text" value="A"/> <input type="text" value="W"/> <input type="text" value="No."/> <input type="text"/>	Reset application block
	<input type="text" value="A"/> <input type="text" value="W"/> <input type="text" value="No."/> <input type="text" value=""/>	Delete application block
Response	<input type="text" value="A"/> <input type="text" value="B"/>	Written to application block
Comments	<ul style="list-style-type: none"> <li>• Information to be entered is dependent on target block, see chapter 6.</li> <li>• Deleting and resetting have same effect.</li> </ul>	

**Write to display**

Command	<input type="text" value="D"/> <input type="text" value="Text_20"/>	Write to display
	<input type="text" value="D"/> <input type="text" value=""/>	Switch display to dark
	<input type="text" value="D"/>	Set display to normal status
Response	<input type="text" value="D"/> <input type="text" value="B"/>	Written to display
Comments	<ul style="list-style-type: none"> <li>• Character stock: ASCII characters 20 hex/32 deci ... 7F hex/127 deci, see section 9.1.</li> <li>• Watch capitalization.</li> </ul>	

**Alphanumeric printout on GA46 printer**

Command	<code>P _ Text_48</code>	Print text as per setting
	<code>P _ \$ ! 1 Text_48</code>	Print text in small type
	<code>P _ \$ ! 2 Text_48</code>	Print text in normal type
	<code>P _ \$ ! 3 Text_48</code>	Print text in large type
	<code>P _ \$ ! A Text_48</code>	Print text in small type and bold print
	<code>P _ \$ ! B Text_48</code>	Print text in normal type and bold print
	<code>P _ \$ ! C Text_48</code>	Print text in large type and bold print
	<code>P _</code>	Print blank line
Response	<code>P , B</code>	Alphanumeric characters printed
Comments	<ul style="list-style-type: none"> <li>• Character stock: ASCII characters 20 hex/32 deci ... 7F hex/127 deci, see section 9.1.</li> <li>• Text is printed in last selected type size.</li> <li>• Watch capitalization.</li> </ul>	

**Barcode printout on GA46 printer**

Command	<code>P _ \$ # 1 Text_20, barcode-specific</code>	Print Code 39
	<code>P _ \$ # 2 Text_8, barcode-specific</code>	Print EAN 8
	<code>P _ \$ # 3 Text_13, barcode-specific</code>	Print EAN 13
	<code>P _ \$ # 4 Text_20, barcode-specific</code>	Print EAN 128
	<code>P _ \$ # 5 Text_20, barcode-specific</code>	Print Code 2 of 5
	<code>P _ \$ # 6 Text_20, barcode-specific</code>	Print Code 2 of 5 interleaved
	<code>P _ \$ # 7 Text_20, barcode-specific</code>	Print Code 128
	<code>P _ \$ # 8 Text_20, barcode-specific</code>	Print EAN 128
	<code>P _</code>	Print blank line
Response	<code>P , B</code>	Barcode printed
Comments	<ul style="list-style-type: none"> <li>• Character stock: ASCII characters 20 hex/32 deci ... 7F hex/127 deci, see section 9.1.</li> <li>• With Code 39, 3 barcodes can be printed next to each other. Separating characters: \$\$ or H<sub>T</sub> (ASCII character 09 hex/9 deci). Arrangement of barcodes: Barcode 2, Barcode 1, Barcode 3.</li> </ul>	

**Acoustic signal**

Command	<code>D , S</code>	Generate short acoustic signal (beep tone) in terminal
Response	<code>D , B</code>	Acoustic signal generated in terminal

**Identification**

Command	<code>I , D</code>	Interrogate identification of terminal
Response	<code>I , D , 7 _</code>	Program number of Pac

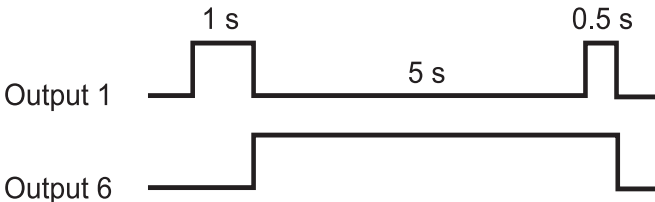

### Actuating digital outputs

<p>Command</p>	<p><code>W _ Status</code> Switch individual digital outputs on or off</p> <p><code>W _ Status 1 _ Time 1 _ Status 2 _ Time 2 _ ... _ Status 4 _ Time 4 _ Status 5</code> Trigger time sequence of status changes of digital outputs</p> <p><code>W , W _</code> Reset all outputs to logical 0</p> <p>Status: Each output is assigned a value. The total of the values of those outputs which are to be closed is indicated as the "Status".</p> <table data-bbox="719 607 1471 972"> <tr><td>Digital output 1</td><td>1</td></tr> <tr><td>Digital output 2</td><td>2</td></tr> <tr><td>Digital output 3</td><td>4</td></tr> <tr><td>Digital output 4</td><td>8</td></tr> <tr><td>Digital output 5</td><td>16</td></tr> <tr><td>Digital output 6</td><td>32</td></tr> <tr><td>Digital output 7</td><td>64</td></tr> <tr><td>Digital output 8</td><td>128</td></tr> <tr><td>All outputs open</td><td>0</td></tr> <tr><td>All outputs closed</td><td>255</td></tr> </table> <p>Time: 1 ... 99999 ms</p>	Digital output 1	1	Digital output 2	2	Digital output 3	4	Digital output 4	8	Digital output 5	16	Digital output 6	32	Digital output 7	64	Digital output 8	128	All outputs open	0	All outputs closed	255
Digital output 1	1																				
Digital output 2	2																				
Digital output 3	4																				
Digital output 4	8																				
Digital output 5	16																				
Digital output 6	32																				
Digital output 7	64																				
Digital output 8	128																				
All outputs open	0																				
All outputs closed	255																				
<p>Response</p>	<p><code>W B</code> Digital outputs set</p>																				
<p>Comments</p>	<ul style="list-style-type: none"> <li>• Max. 5 statuses "Status" and 4 intervals "Time" are possible. After sequence has been run, digital outputs freeze in last status "Status".</li> <li>• A break in the port has no effect on the outputs.</li> <li>• If terminal receives a new W command before time sequence has been run, ongoing sequence will be aborted immediately.</li> <li>• If limits for "Status" and "Time" are not adhered to, error message EL appears on 4 I/O-ID7 interface or 8-ID7 relay box.</li> </ul>																				
<p>Examples</p>	<p>Command: <code>W _ 5</code> Digital outputs 1 and 3 are closed, all others opened</p> <p>Command: <code>W _ 1 _ 1,0,0,0 _ 3,2 _ 5,0,0,0 _ 3,3 _ 5,0,0 _ 0</code> triggers following sequence:</p>  <p>The diagram shows two digital signals over time. The top signal, labeled 'Output 1', starts at a low level, rises to high for a duration of 1 s, then returns to low. It remains low for 5 s, then rises to high for a duration of 0.5 s, and finally returns to low. The bottom signal, labeled 'Output 6', starts at a low level, rises to high at the same time as Output 1, and remains high for the entire 5 s interval before returning to low.</p>																				

#### 5.1.4 Terminal messages – only with RS232, RS422 or C20mA

In the dialog mode the ID7-24V-Base weighing terminal transmits an acknowledgement to the computer each time a key is pressed.

When this pressing of a key is replaced with an interface command, the acknowledgement only differs in the second character in the response format which is part of the command:

Function	Key	Acknowledgement
Set zero		Z, A
Tare		T, A ... (see command T)
Specify tare weight		T, A, H ... (see command T_ ...)
Change over unit		U, A, _ Unit
Transmit data record in case of weighing platform stabilization		S, T, _ _ ... (see command SX)
Switch over weighing platform		S, A, _ _ n n = weighing platform 1 ... 3
Dynamic weighing		A, A, 0, 1, 6 _ Weight value _ Unit
Identification A ... D	A ... D	K, x _ Identification x = A, B, C, D 20 characters, right-justified
Function keys	F1 ... F6	K, F _ x x = I, J, K, L, M, N

#### 5.1.5 Fault messages

Fault messages always consist of 2 characters and a string frame.

The string frame can be defined in the master mode (section 4.5.2).

E, T

##### Transmission error

The terminal transmits a transmission error for errors in the received bit sequence, e. g. parity errors, missing stop bit.

E, S

##### Syntax error

The terminal transmits a syntax error when the received characters cannot be processed, e. g. command does not exist.

E, L

##### Logic error

The terminal transmits a logic error when a command cannot be executed, e. g. when an attempt is made to write to a write-protected application block.

## 5.2 METTLER TOLEDO continuous mode

These operating modes are suitable for continuous data transmission in real time from the ID7-24V-Base to METTLER TOLEDO devices, e. g. to a second display.

The data are even transmitted when the weighing platform is moving or the gross weight = 0.

Commands can also be sent to the ID7-24V-Base weighing terminal, permitting remote control of certain keys on the terminal.

There are 2 different continuous modes:

- Continuous mode – net and tare values are continuously transmitted.
- Short continuous mode – only net values are continuously transmitted.

### 5.2.1 Data output from ID7-24V-Base

#### Output format

Weight values are always transmitted in the following format:

STX	SB1	SB2	SB3	DF1	DF2	CR	CHK
-----	-----	-----	-----	-----	-----	----	-----

STX ASCII characters 02 hex/2 deci, character for "start of text" is required by some printers

SB... For status bytes, see below

DF1 Data field with 6 digits for the weight value transmitted without a decimal point and unit

DF2 Data field with 6 digits for the tare weight; is not transmitted in the short continuous mode

CR Carriage return (ASCII character 0D hex/13 deci)

CHK Checksum (2-part complement of binary sum of 7 lower bits of all previously transmitted characters, including STX and CR)

#### Status byte SB1

Bit 6	Bit 5	Bit 4	Bit 3	Bit 2	Bit 1	Bit 0
0	1	Rounding / Increment		Decimal position		

Bit 4	Bit 3	Rounding/ Increment
0	1	1
1	0	2
1	1	5

Bit 2	Bit 1	Bit 0	Decimal position
0	0	0	XXXX00
0	0	1	XXXXX0
0	1	0	XXXXXX
0	1	1	XXXXX.X
1	0	0	XXXX.XX
1	0	1	XXX.XXX
1	1	0	XX.XXXX
1	1	1	X.XXXXX

**Status byte SB2**

Bit 6	Bit 5	Bit 4	Bit 3	Bit 2	Bit 1	Bit 0
0	1	0 lb	0 Stabiliza- tion	0 Normal status	0 Positive sign	0 Gross value
		1 kg	1 Movement	1 Underload/ overload	1 Negative sign	1 Net value

**Status byte SB3**

Bit 6	Bit 5	Bit 4	Bit 3	Bit 2	Bit 1	Bit 0
0	1	0	0 Basic state 1 Print request	Weight value		

Bit 2	Bit 1	Bit 0	Weight value
0	0	0	kg / lb (SB2 Bit 4)
0	0	1	g
0	1	0	t
0	1	1	oz
1	0	0	ozt
1	0	1	dwt
1	1	0	ton
1	1	1	free unit

**5.2.2 Commands to ID7-24V-Base**

Individual command characters can be transmitted to the ID7-24V-Base in the text format. One function each on the terminal is assigned to these command characters. After a command character is received, the following functions are executed:

Command	Function
C	Clear tare
P	Print or transmit transfer string
T	Tare
Z	Set zero

## 5.3 METTLER TOLEDO SICS command set

### 5.3.1 Communication syntax and formats

#### Command format when transmitting weight values

Identification	_	Weight value	_	Unit	Framing
String of characters for specification of command (1 ... 4 characters)		1 ... 10 characters		1 ... 3 characters, number of characters variable	C <sub>R</sub> L <sub>F</sub>

#### Response format when transmitting weight values

Identification	_	Status	_	Weight value	_	Unit	Framing
String of characters for specification of response (1 ... 2 char.)		1 char.		10 char., right-justified, filled in with blank char.		3 char., left-justified, filled in with blank char.	C <sub>R</sub> L <sub>F</sub>

#### Example

Tare specification command

T|A|\_|1|3|.2|9|5|\_|k|g|

Tare specification response

T|A|\_|A|\_|\_|\_|\_|\_|1|3|.2|9|5|\_|k|g|\_|

#### Data formats

- The following symbols are used in the command description:

Weight value

10 numbers with sign and decimal point, right-justified (with preceding blank spaces)

Unit

3 characters, left-justified (with following blank spaces)

"Text\_n"

maximum of n characters, left-justified

- The string framing is mandatory, however it is **not** listed in the following command description!
- Enter commands as upper-case letters.
- Text to be entered must always be placed in inverted commas.

### 5.3.2 Command overview

Command	Meaning	Page
<b>Level 0</b>		
I0	Transmit list of all available SICS commands	69
I1	Transmit SICS level and SICS versions	69
I2	Transmit scale data (terminal, platform)	69
I3	Transmit scale software version (program number)	70
I4	Transmit serial number	70
S, SI, SIR	Transmit display contents	70
Z	Set to zero	71
@	Reset	71
<b>Level 1</b>		
D	Write display	71
DW	Weight display	71
K	Keyboard monitoring	72
SR	Transmit stable weight values repeatedly depending on a weight change	74
T	Taring	74
TI	Tare immediately	75
TA	Specify tare weight	75
TAC	Delete tare weight	76
<b>Level 2</b>		
SX, SXI, SXIR	Transmit data record	76
RO, R1	Switch keyboard on or off	77
U	Change over to different weight unit	77
DS	Acoustic signal	77
<b>Level 3</b>		
AR	Read application block	77
AW	Write application block	78
DY	Specify DeltaTrack target value	78
P	Print text or barcode	79
W	Actuating digital outputs	80

### 5.3.3 Command description

#### Transmit SICS commands

Command	<code>I,0</code> Transmit SICS commands
Response	<code>I,0 _ B</code> <code>I,0 _ 0 _ "I0 "</code> <code>I,0 _ 0 _ "I1 "</code> ... <code>I,0 _ 1 _ "D "</code> ... <code>I,0 _ 2 _ "SX "</code> ... <code>I,0 _ 3 _ "AR "</code> ... <code>I,0 _ A</code>

#### Transmit SICS levels and SICS versions

Command	<code>I,1</code> Transmit SICS levels and SICS versions
Response	<code>I,1 _ A _ "x1" _ "x2" _ "x3" _ "x4" _ "x5 "</code> x1 = 0123 Scale with SICS levels 0, 1, 2 and 3 x2 Version or implemented SICS0 commands x3 Version or implemented SICS1 commands x4 Version or implemented SICS2 commands x5 Version or implemented SICS3 commands <code>I,1 _ I</code> Command understood, cannot be executed at this time
Comments	<ul style="list-style-type: none"> <li>• On the SICS level only fully implemented levels are executed.</li> <li>• With the SICS version all levels are specified.</li> </ul>

#### Transmit scale data

Command	<code>I,2</code> Transmit data from weighing terminal and weighing platform(s)
Response	<code>I,2 _ A _ "text "</code>
Example	<code>I,2 _ A _ "ID7-Count IZ05 15,000 kg IZ10 32,000 kg "</code>

**Transmit scale software version**

Command	<code>I,3</code> Transmit software version from weighing terminal and weighing platform(s)
Response	<code>I,3 _ A _ "text"</code>
Example	<code>I,3 _ A _ "IP73-0-0200 IZ05-0-0301 Z10-0-0221"</code>

**Transmit serial number**

Command	<code>I,4</code> Transmit serial number of weighing terminal
Response	<code>I,4 _ A _ "text"</code>
Example	<code>I,4 _ A _ "1234567"</code>
Comment	The response to I4 appears automatically following switch-on and after the Reset command (@).

**Transmit display contents**

Command	<p><code>S</code> Transmit a stable weight value when the weighing platform is at a standstill.</p> <p><code>S,I</code> Transmit a stable or a dynamic weight value, regardless of whether the weighing platform is at a standstill.</p> <p><code>S,I,R</code> Transmit a stable or a dynamic weight value after each measuring cycle, regardless of whether the weighing platform is at a standstill.</p>
Response	<p><code>S _ S _ Weight value _ Unit</code> Stable weight value transmitted</p> <p><code>S _ D _ Weight value _ Unit</code> Dynamic weight value transmitted</p> <p><code>S _ I</code> Invalid value</p> <p><code>S _ -</code> Weighing platform in underload range</p> <p><code>S _ +</code> Weighing platform in overload range</p>
Comment	Stop <code>S,I,R</code> command with <code>S</code> , <code>S,I</code> , <code>S,R</code> , @ command or disconnect port.



**Set to zero**

Command	<code>Z</code>	Set gross weight display to zero after weighing platform comes to a standstill, effect as when ZERO-SET key is pressed
Response	<code>Z _ A</code> <code>Z _ I</code> <code>Z _ -</code> <code>Z _ +</code>	Weighing platform set to zero Command cannot be executed: e.g. standstill not achieved or another command is currently being executed Command cannot be executed: Zero-set range dropped below Command cannot be executed: Zero-set range exceeded
Comment	Can only be set to zero when the weighing platform comes to a standstill in the zero-set range.	

**Reset**

Command	<code>@</code>	Reset weighing terminal to the state maintained after Power On
Response	<code>I 4 _ A _ "text"</code>	Serial number
Comments	<ul style="list-style-type: none"> <li>• All running applications and functions are cancelled.</li> <li>• The tare memory is reset to zero.</li> </ul>	

**Write display**

Command	<code>D _ "Text_20"</code> <code>D _ ""</code>	Write display Darken display
Response	<code>D _ A</code> <code>D _ A</code> <code>D _ I</code> <code>D _ L</code>	Display written; the complete text appears left-justified in the display, marked with a symbol, e.g. with * Display written; the end of the text appears left-justified in the display with the beginning cut off, marked with a symbol, e.g. with * Command cannot be executed Command understood, parameters defective
Comment	A symbol in the display, e.g. *, indicates that an invalid weight value is displayed.	

**Weight display**

Command	<code>D W</code>	Switch over main display into the weight mode
Response	<code>D W _ A</code> <code>D W _ I</code>	The main display shows the current weight value Command understood, but cannot be executed

**Keyboard monitoring**

Command	<p><math>\boxed{K\_ \_ \_1}</math> When a key is pressed, execute the function, but do not transmit anything (factory setting)</p> <p><math>\boxed{K\_ \_ \_1}</math> When a key is pressed, do not execute the function and do not transmit anything</p> <p><math>\boxed{K\_ \_ \_3}</math> When a key is pressed, do not execute the function, but transmit the key code <math>\boxed{K\_ \_ \_C\_ \_ \_x}</math> or, when the key is pressed longer, transmit <math>\boxed{K\_ \_ \_R\_ \_ \_x}</math> and <math>\boxed{K\_ \_ \_C\_ \_ \_x}</math></p> <p><math>\boxed{K\_ \_ \_4}</math> When a key is pressed, execute the function and transmit the function code <math>\boxed{K\_ \_ \_A\_ \_ \_x}</math></p> <p>If the function cannot be executed immediately, the function code for the start of the function <math>\boxed{K\_ \_ \_B\_ \_ \_x}</math> or <math>\boxed{K\_ \_ \_A\_ \_ \_x}</math> for the end of the function is transmitted.</p>
Response	<p><math>\boxed{K\_ \_ \_A}</math> Command understood or function successfully executed</p> <p><math>\boxed{K\_ \_ \_I}</math> Command understood, but currently cannot be executed, e.g. no keyboard present</p> <p><math>\boxed{K\_ \_ \_L}</math> Command understood, parameters defective</p> <p><b>Key codes</b></p> <p><math>\boxed{K\_ \_ \_R\_ \_ \_x}</math> Key x was pressed briefly and released again immediately</p> <p><math>\boxed{K\_ \_ \_C\_ \_ \_x}</math> Key x was pressed for approx. 2 sec.</p>

Response	<p><b>Function codes x</b></p> <p>The function codes are dependent on the command transmitted.</p> <table border="0"> <tr> <td><b>x</b>    <math>\boxed{K}_{-,-,3}</math></td> <td><b>x</b>    <math>\boxed{K}_{-,-,4}</math></td> </tr> <tr> <td>1    Set to zero</td> <td>1    Tare</td> </tr> <tr> <td>2    X 10</td> <td>2    Set to zero</td> </tr> <tr> <td>3    Switch on/off, tare</td> <td>3    Transfer key</td> </tr> <tr> <td>4    Enter master mode</td> <td>4    Enter master mode</td> </tr> <tr> <td>5    Transfer key</td> <td>5    Exit master mode</td> </tr> <tr> <td>6    F1</td> <td>7    Test</td> </tr> <tr> <td>7    F2</td> <td>8    ON/OFF</td> </tr> <tr> <td>8    F3, unit switchover</td> <td>10    Unit switchover</td> </tr> <tr> <td>9    F4, but not X10</td> <td>11    X 10</td> </tr> <tr> <td>10    F5</td> <td>12    RESET ALL</td> </tr> <tr> <td>11    F6, but not MODE</td> <td>13    F1</td> </tr> <tr> <td>21    CODE A</td> <td>14    F2</td> </tr> <tr> <td>22    CODE B</td> <td>15    F3</td> </tr> <tr> <td>23    CODE C</td> <td>16    F4</td> </tr> <tr> <td>24    CODE D</td> <td>17    F5</td> </tr> <tr> <td>25    Function change key</td> <td>18    F6</td> </tr> <tr> <td>26    INFO</td> <td>21    CODE A</td> </tr> <tr> <td>27    SCALE</td> <td>22    CODE B</td> </tr> <tr> <td>28    +/-</td> <td>23    CODE C</td> </tr> <tr> <td>29    Decimal point</td> <td>24    CODE D</td> </tr> <tr> <td>30    0</td> <td>25    Function change key</td> </tr> <tr> <td>...    ...</td> <td>26    INFO</td> </tr> <tr> <td>39    9</td> <td>27    SCALE</td> </tr> <tr> <td>40    CLEAR</td> <td>28    +/-</td> </tr> <tr> <td></td> <td>29    Decimal point</td> </tr> <tr> <td></td> <td>30    0</td> </tr> <tr> <td></td> <td>...    ...</td> </tr> <tr> <td></td> <td>39    9</td> </tr> <tr> <td></td> <td>40    CLEAR</td> </tr> </table>	<b>x</b> $\boxed{K}_{-,-,3}$	<b>x</b> $\boxed{K}_{-,-,4}$	1    Set to zero	1    Tare	2    X 10	2    Set to zero	3    Switch on/off, tare	3    Transfer key	4    Enter master mode	4    Enter master mode	5    Transfer key	5    Exit master mode	6    F1	7    Test	7    F2	8    ON/OFF	8    F3, unit switchover	10    Unit switchover	9    F4, but not X10	11    X 10	10    F5	12    RESET ALL	11    F6, but not MODE	13    F1	21    CODE A	14    F2	22    CODE B	15    F3	23    CODE C	16    F4	24    CODE D	17    F5	25    Function change key	18    F6	26    INFO	21    CODE A	27    SCALE	22    CODE B	28    +/-	23    CODE C	29    Decimal point	24    CODE D	30    0	25    Function change key	...    ...	26    INFO	39    9	27    SCALE	40    CLEAR	28    +/-		29    Decimal point		30    0		...    ...		39    9		40    CLEAR
<b>x</b> $\boxed{K}_{-,-,3}$	<b>x</b> $\boxed{K}_{-,-,4}$																																																												
1    Set to zero	1    Tare																																																												
2    X 10	2    Set to zero																																																												
3    Switch on/off, tare	3    Transfer key																																																												
4    Enter master mode	4    Enter master mode																																																												
5    Transfer key	5    Exit master mode																																																												
6    F1	7    Test																																																												
7    F2	8    ON/OFF																																																												
8    F3, unit switchover	10    Unit switchover																																																												
9    F4, but not X10	11    X 10																																																												
10    F5	12    RESET ALL																																																												
11    F6, but not MODE	13    F1																																																												
21    CODE A	14    F2																																																												
22    CODE B	15    F3																																																												
23    CODE C	16    F4																																																												
24    CODE D	17    F5																																																												
25    Function change key	18    F6																																																												
26    INFO	21    CODE A																																																												
27    SCALE	22    CODE B																																																												
28    +/-	23    CODE C																																																												
29    Decimal point	24    CODE D																																																												
30    0	25    Function change key																																																												
...    ...	26    INFO																																																												
39    9	27    SCALE																																																												
40    CLEAR	28    +/-																																																												
	29    Decimal point																																																												
	30    0																																																												
	...    ...																																																												
	39    9																																																												
	40    CLEAR																																																												
Comments	<ul style="list-style-type: none"> <li>• The factory setting is active after switch-on, after the Reset command and after exiting the master mode.</li> <li>• Only one K command is ever active at one time.</li> </ul>																																																												

**Transmit stable weight values repeatedly depending on a weight change**

Command	<p><code>S,R</code> <code>Excursion weight (weight value)</code> <code>Unit</code></p> <p>After a weight change greater than the specified excursion weight, transmit alternately the next stable weight value and a dynamic weight value depending on the specified excursion.</p> <p><code>S,R</code></p> <p>If no excursion weight is entered, the weight change must be at least 12.5 % of the last stable weight value, however at least 30 d.</p>
Response	<p><code>S</code> <code>S</code> <code>Weight value</code> <code>Unit</code> Current stable weight value transmitted</p> <p>Weight change</p> <p><code>S</code> <code>D</code> <code>Weight value</code> <code>Unit</code> Dynamic weight value transmitted</p> <p><code>S</code> <code>I</code> Command cannot be executed</p> <p><code>S</code> <code>L</code> Command understood, parameters defective</p> <p><code>S</code> <code>-</code> Weighing platform in underload range</p> <p><code>S</code> <code>+</code> Weighing platform in overload range</p>
Comment	Stop command with command <code>S</code> , <code>S,I</code> , <code>S,I,R</code> , <code>@</code> or disconnect the port.
Example	<p>Command: <code>S,R</code> <code>1,4,0</code> <code>k,g</code></p> <p>Responses: <code>S</code> <code>S</code> <code>2,0,0.0,0</code> <code>k,g</code> 1st item</p> <p><code>S</code> <code>D</code> <code>3,4,5.8,5</code> <code>k,g</code></p> <p><code>S</code> <code>S</code> <code>4,1,0.5,0</code> <code>k,g</code> 2nd item</p>

**Taring**

Command	<p><code>T</code></p> <p>Tare weighing platform:</p> <p>After the weighing platform comes to a standstill, the current weight value is saved as a tare weight and the weight display set to zero with the weight on the platform.</p> <p>Effect as when TARE key is pressed.</p>
Response	<p><code>T</code> <code>S</code> <code>Tare weight (weight value)</code> <code>Unit</code> Weighing platform tared, stable tare value</p> <p><code>T</code> <code>I</code> Taring not carried out</p> <p><code>T</code> <code>-</code> Command cannot be executed: Tare range dropped below</p> <p><code>T</code> <code>+</code> Command cannot be executed: Tare range exceeded</p>
Comments	<ul style="list-style-type: none"> <li>• Each taring command overwrites the contents of the tare memory with the new tare weight.</li> <li>• Taring with unloaded weighing platform clears the tare memory. On some weighing platform models, setting to zero is carried out in the unloaded state.</li> <li>• On non-certified weighing systems the tare weight is automatically rounded off to the current increment.</li> <li>• On certified weighing systems: Tare range with MultiRange only in first increment range.</li> </ul>

**Tare immediately**

Command	<code>T, I</code> Tare weighing platform immediately.
Response	<code>T, I, S, Tare weight (weight value) Unit</code> Weighing platform tared, stable tare value <code>T, I, D, Tare weight (weight value) Unit</code> Weighing platform tared, dynamic tare value <code>T, I, I</code> Taring not carried out <code>T, I, L</code> Command cannot be executed <code>T, I, -</code> Command cannot be executed: Tare range dropped below <code>T, I, +</code> Command cannot be executed: Tare range exceeded
Comments	<ul style="list-style-type: none"> <li>• Each taring command overwrites the contents of the tare memory with the new tare weight.</li> <li>• Following a dynamic tare value, a stable weight value can be specified. However, this value is not exact.</li> </ul>

**Specify tare weight**

Command	<code>T, A, Tare weight (weight value) Unit</code> Specify tare weight: The contents of the tare memory are overwritten with the specified tare weight and the net weight is displayed. Effect as when the key sequence TARE ENTRY, 0 ... 9, ENTER is pressed.
Response	<code>T, A, A, Tare weight (weight value) Unit</code> Weighing platform tared with the specified value <code>T, A, I</code> Command not carried out <code>T, A, L</code> Command understood, parameters defective <code>T, -</code> Command cannot be executed: Tare range dropped below <code>T, +</code> Command cannot be executed: Tare range exceeded
Comments	<ul style="list-style-type: none"> <li>• The contents of the tare memory are overwritten with the specified tare value.</li> <li>• On non-certified weighing systems the tare weight is automatically rounded off to the current increment.</li> <li>• On certified weighing systems: Tare range with MultiRange only in first increment range.</li> </ul>
Example	Command: <code>T, A, 1, 2, ., 6, 5, 0, k, g</code> Response: <code>T, A, A, ., ., ., ., 1, 2, ., 6, 5, 0, k, g, .</code>

**Delete tare weight**

Command	<code>T A C</code>	Delete tare weight.
Response	<code>T A C _ A</code> <code>T A C _ I</code>	Weighing platform tared with the specified weight Command not carried out

**Transmit data record**

Command	<p><code>S X</code> After the weighing platform comes to a standstill, transmit a data record with stable weight values. Effect as when ENTER key is pressed.</p> <p><code>S X I</code> Transmit a data record with stable or dynamic weight values, regardless of whether the weighing platform is at a standstill.</p> <p><code>S X I R</code> Repeatedly transmit a data record with stable or dynamic weight values, regardless of whether the weighing platform is at a standstill.</p>
Response	<p><code>S X _ S _ Application block _ _ Application block [ ... ]</code>   <code>A No. _ Data record</code> Data record with stable weight values transmitted</p> <p><code>S X _ D _ Application block _ _ Application block [ ... ]</code>   <code>A No. _ Data record</code> Data record with dynamic weight values transmitted</p> <p><code>S X _ I</code> Command cannot be executed  <code>S X _ -</code> Weighing platform in underload range  <code>S X _ +</code> Weighing platform in overload range</p>
Comments	<ul style="list-style-type: none"> <li>• Number of application blocks: three-place with preceding zeros.</li> <li>• The contents of the corresponding application block is contained in the data record, see chapter 6. The standard data record consists of 3 blocks:  <code>S X _ S _ A 0 1 1 _ Gross weight (weight value) _ Unit _ _</code>  <code>A 0 1 2 _ Net weight (weight value) _ Unit _ _</code>  <code>A 0 1 3 _ Tare weight (weight value) _ Unit</code></li> </ul> <p>The continuous transmission of data records started with the <code>S X I R</code> command can be stopped with the commands <code>S X</code> or <code>S X I</code>.</p>
Example	<p>Command: <code>S X I</code></p> <p>Response: Default data record</p> <pre> S X _ D _ A 0 1 1 _ _ _ _ _ 2 3 . 6 5 0 _ k g _ _ _ _ A 0 1 2 _ _ _ _ _ 2 1 . 6 5 0 _ k g _ _ _ _ A 0 1 3 _ _ _ _ _ 2 . 0 0 0 _ k g _ _                     </pre>

**Switch keyboard on or off**

Command	<code>R,0</code> Switch on keyboard <code>R,1</code> Switch off keyboard
Response	<code>R,0 _ _ A</code> Keyboard switched on <code>R,1 _ _ A</code> Keyboard switched off
Comments	<ul style="list-style-type: none"> <li>• Factory setting: Keyboard switched on.</li> <li>• When the keyboard is switched off, the terminal cannot be manually operated.</li> </ul>

**Changing over to different weight unit**

Command	<code>U _ Unit</code> Change over weight display to different weight unit <code>U</code> Change over weight display to the first weight unit
Response	<code>U _ A</code> Weight display switched over to another weight unit <code>U _ I</code> Impermissible weight unit
Comment	Possible units: g, kg, lb, ozt, oz, dwt

**Acoustic signal**

Command	<code>D,S</code> Generate short acoustic signal (beep) in the terminal
Response	<code>D,S _ _ A</code> Acoustic signal generated in the terminal

**Read application block**

Command	<code>A,R _ _ No.</code> Read contents of the application block
Response	<code>A,R _ _ A _ Information</code> Contents of the application block transmitted
Comments	<ul style="list-style-type: none"> <li>• The transmitted information is dependent on the application block, see chapter 6.</li> <li>• The number of the application block must be entered as a three-place number with preceding zeros.</li> </ul>





**Print text or barcode with GA46 printer**

Command	<table border="0"> <tr> <td><code>P _ Text_48</code></td> <td>Print text as per setting</td> </tr> <tr> <td><code>P _ \$ ! 1 Text_48</code></td> <td>Print text in small print</td> </tr> <tr> <td><code>P _ \$ ! 2 Text_48</code></td> <td>Print text in normal print</td> </tr> <tr> <td><code>P _ \$ ! 3 Text_48</code></td> <td>Print text in large print</td> </tr> <tr> <td><code>P _ \$ ! A Text_48</code></td> <td>Print text in small type and bold print</td> </tr> <tr> <td><code>P _ \$ ! B Text_48</code></td> <td>Print text in normal type and bold print</td> </tr> <tr> <td><code>P _ \$ ! C Text_48</code></td> <td>Print text in large type and bold print</td> </tr> <tr> <td><code>P _ \$ # 1 Text_20, barcode-specific</code></td> <td>Print code 39</td> </tr> <tr> <td><code>P _ \$ # 2 Text_8, barcode-specific</code></td> <td>Print EAN 8</td> </tr> <tr> <td><code>P _ \$ # 3 Text_13, barcode-specific</code></td> <td>Print EAN 13</td> </tr> <tr> <td><code>P _ \$ # 4 Text_20, barcode-specific</code></td> <td>Print code 128</td> </tr> <tr> <td><code>P _ \$ # 5 Text_20, barcode-specific</code></td> <td>Print code 2 of 5</td> </tr> <tr> <td><code>P _ \$ # 6 Text_20, barcode-specific</code></td> <td>Print code 2 of 5 interleaved</td> </tr> <tr> <td><code>P _ \$ # 7 Text_20, barcode-specific</code></td> <td>Print code 128</td> </tr> <tr> <td><code>P _ \$ # 8 Text_20, barcode-specific</code></td> <td>Print EAN 128</td> </tr> <tr> <td><code>P _</code></td> <td>Print blank line</td> </tr> </table>	<code>P _ Text_48</code>	Print text as per setting	<code>P _ \$ ! 1 Text_48</code>	Print text in small print	<code>P _ \$ ! 2 Text_48</code>	Print text in normal print	<code>P _ \$ ! 3 Text_48</code>	Print text in large print	<code>P _ \$ ! A Text_48</code>	Print text in small type and bold print	<code>P _ \$ ! B Text_48</code>	Print text in normal type and bold print	<code>P _ \$ ! C Text_48</code>	Print text in large type and bold print	<code>P _ \$ # 1 Text_20, barcode-specific</code>	Print code 39	<code>P _ \$ # 2 Text_8, barcode-specific</code>	Print EAN 8	<code>P _ \$ # 3 Text_13, barcode-specific</code>	Print EAN 13	<code>P _ \$ # 4 Text_20, barcode-specific</code>	Print code 128	<code>P _ \$ # 5 Text_20, barcode-specific</code>	Print code 2 of 5	<code>P _ \$ # 6 Text_20, barcode-specific</code>	Print code 2 of 5 interleaved	<code>P _ \$ # 7 Text_20, barcode-specific</code>	Print code 128	<code>P _ \$ # 8 Text_20, barcode-specific</code>	Print EAN 128	<code>P _</code>	Print blank line
<code>P _ Text_48</code>	Print text as per setting																																
<code>P _ \$ ! 1 Text_48</code>	Print text in small print																																
<code>P _ \$ ! 2 Text_48</code>	Print text in normal print																																
<code>P _ \$ ! 3 Text_48</code>	Print text in large print																																
<code>P _ \$ ! A Text_48</code>	Print text in small type and bold print																																
<code>P _ \$ ! B Text_48</code>	Print text in normal type and bold print																																
<code>P _ \$ ! C Text_48</code>	Print text in large type and bold print																																
<code>P _ \$ # 1 Text_20, barcode-specific</code>	Print code 39																																
<code>P _ \$ # 2 Text_8, barcode-specific</code>	Print EAN 8																																
<code>P _ \$ # 3 Text_13, barcode-specific</code>	Print EAN 13																																
<code>P _ \$ # 4 Text_20, barcode-specific</code>	Print code 128																																
<code>P _ \$ # 5 Text_20, barcode-specific</code>	Print code 2 of 5																																
<code>P _ \$ # 6 Text_20, barcode-specific</code>	Print code 2 of 5 interleaved																																
<code>P _ \$ # 7 Text_20, barcode-specific</code>	Print code 128																																
<code>P _ \$ # 8 Text_20, barcode-specific</code>	Print EAN 128																																
<code>P _</code>	Print blank line																																
Response	<table border="0"> <tr> <td><code>P _ A</code></td> <td>Alphanumeric characters printed</td> </tr> <tr> <td><code>P _ L</code></td> <td>no GA46 present</td> </tr> </table>	<code>P _ A</code>	Alphanumeric characters printed	<code>P _ L</code>	no GA46 present																												
<code>P _ A</code>	Alphanumeric characters printed																																
<code>P _ L</code>	no GA46 present																																
Comments	<ul style="list-style-type: none"> <li>• Character stock: ASCII character 20 hex/32 dec ... 7F hex/127 dec, see section 9.1.</li> <li>• Printing is carried out in the font size last selected.</li> <li>• Watch uppercase and lowercase letters.</li> </ul>																																

**Actuating digital outputs**

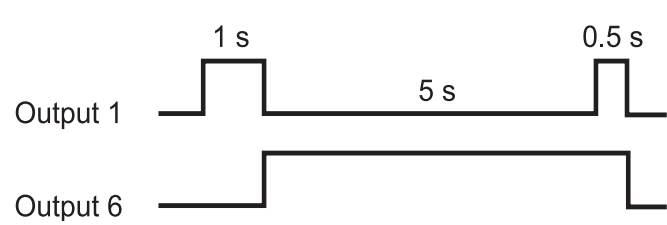
<p>Command</p>	<p><code>W _ Status</code> Switch individual digital outputs on or off</p> <p><code>W _ Status 1 _ Time 1 _ Status 2 _ Time 2 _ ... _ Status 4 _ Time 4 _ Status 5</code> Trigger time sequence of status changes of digital outputs</p> <p><code>W , W _</code> Reset all outputs to logical 0</p> <p>Status: Each output is assigned a value. The total of the values of those outputs which are to be closed is indicated as the "Status".</p> <table border="0"> <tr><td>Digital output 1</td><td>1</td></tr> <tr><td>Digital output 2</td><td>2</td></tr> <tr><td>Digital output 3</td><td>4</td></tr> <tr><td>Digital output 4</td><td>8</td></tr> <tr><td>Digital output 5</td><td>16</td></tr> <tr><td>Digital output 6</td><td>32</td></tr> <tr><td>Digital output 7</td><td>64</td></tr> <tr><td>Digital output 8</td><td>128</td></tr> <tr><td>All outputs open</td><td>0</td></tr> <tr><td>All outputs closed</td><td>255</td></tr> </table> <p>Time: 1 ... 99999 ms</p>	Digital output 1	1	Digital output 2	2	Digital output 3	4	Digital output 4	8	Digital output 5	16	Digital output 6	32	Digital output 7	64	Digital output 8	128	All outputs open	0	All outputs closed	255
Digital output 1	1																				
Digital output 2	2																				
Digital output 3	4																				
Digital output 4	8																				
Digital output 5	16																				
Digital output 6	32																				
Digital output 7	64																				
Digital output 8	128																				
All outputs open	0																				
All outputs closed	255																				
<p>Response</p>	<p><code>W _ A</code> Digital outputs set</p>																				
<p>Comments</p>	<ul style="list-style-type: none"> <li>• Max. 5 statuses "Status" and 4 intervals "Time" are possible. After sequence has been run, digital outputs freeze in last status "Status".</li> <li>• A break in the port has no effect on the outputs.</li> <li>• If terminal receives a new W command before time sequence has been run, ongoing sequence will be aborted immediately.</li> <li>• If the limits for "Status" and "Time" are not adhered to when operating the interface types 4 I/O or relay box 8, the fault message EL appears.</li> </ul>																				
<p>Examples</p>	<p>Command: <code>W _ 5</code> Digital outputs 1 and 3 are closed, all others opened</p> <p>Command: <code>W _ 1 _ 1 0 0 0 _ 3 2 _ 5 0 0 0 _ 3 3 _ 5 0 0 _ 0</code> triggers following sequence:</p>  <p>The diagram shows two digital signals. The top signal, labeled 'Output 1', starts at a low level, transitions to high for a duration of 1 second, returns to low, remains low for 5 seconds, transitions to high for a duration of 0.5 seconds, and finally returns to low. The bottom signal, labeled 'Output 6', starts at a low level, transitions to high at the same time as Output 1, remains high for 5 seconds, and then returns to low.</p>																				

### 5.3.4 Error messages

Error messages always consist of 2 characters and a string limit.  
The string limit can be defined in the master mode (section 4.5.2).

E,T

#### **Transmission error**

The terminal transmits a transmission error for errors in the received bit sequence, e.g. parity error, missing stop bit.

E,S

#### **Syntax error**

The terminal transmits a syntax error when it cannot process the received characters, e.g. command not present.

E,L

#### **Logic error**

The terminal transmits a logic error, when a command cannot be executed, e.g. when an attempt is made to write an non-writable application block.

## 6 Application blocks

Application blocks are internal information memories in which weighing data, calculated quantities, configuration data or character sequences entered with the keypad are stored. The content of the application blocks can be read out or written to with a computer.

When the GA46 printer is connected, the assignment of the application blocks can be printed out, see operating instructions for the GA46 printer.

### 6.1 Syntax and formats

The syntax and formats are dependent on the command set selected in the dialog mode, see page 43.

#### 6.1.1 Read application block

##### Read

A	R	No.
A	R	__ No.

MMR command set

SICS command set

The weighing terminal receives the command from the computer to read out the content of the "No." application block. Possible formats for "No." are:

xxx	Entire application block
xxx.zz	Sub-block of an application block
xxx_yyy	Read-only memory
xxx_yyy.zz	Sub-block of a read-only memory

This read command is **not** contained in the following description of the application blocks.

##### Response

A	B	__	Information
A	R	__	A __ Information

MMR command set

SICS command set

As a response the weighing terminal transmits the content of the "No." application block to the computer.

This response is contained in the following description of the application blocks in the MMR version.

##### Example

Command MMR

A	R	0	2	1	__	0	0	1
---	---	---	---	---	----	---	---	---

Command SICS

A	R	__	0	2	1	__	0	0	1
---	---	----	---	---	---	----	---	---	---

Read out tare memory 1.

Response MMR

A	B	__	__	__	__	__	__	1	0	.	5	__	k	g	__
---	---	----	----	----	----	----	----	---	---	---	---	----	---	---	----

Response SICS

A	R	__	A	__	__	__	__	__	__	1	0	.	5	__	k	g	__
---	---	----	---	----	----	----	----	----	----	---	---	---	---	----	---	---	----



### 6.1.3 Data formats

- In the following description of the application blocks the following data formats are used:

<u>Weight value</u>	10 digits with sign and decimal point, right-justified (with preceding blank space)
<u>Unit</u>	3 characters, left-justified (with following blank spaces)
<u>Number_n</u>	Number, n digits, right-justified (with preceding blank spaces)
<u>Text_n</u>	maximum of n characters If the SICS command set is used, "Text" must always be placed in inverted commas.

- Conclude commands and responses with the string frame C<sub>R</sub>L<sub>F</sub> (ASCII characters C<sub>R</sub> = 0D hex/13 deci, L<sub>F</sub> = 0A hex/10 deci). The string frame is **not** contained in the following description.

### 6.1.4 Read and write application blocks with the SICS command set

In the following description, the application blocks are shown in the syntax for the MMR command set. When used with the SICS command set, please observe the following SICS conventions, also see sections 6.1.1 to 6.1.3 :

- A blank space must be entered between AR or AW and the application block number: E. g. `A R _ _ No.`
- The command identification is repeated in the response and a blank space and the character A added:
 

<code>A R _ _ A _ Information</code>	application block transmitted and
<code>A W _ _ A</code>	application block written.
- Texts entered or transmitted are always in inverted commas.

#### Example Read application block for CODE A

Command: `A R _ _ 0 9 4`

Response: `A R _ _ A _ "Article"`

#### Write application block for CODE A

Command: `A W _ _ 0 9 4 _ "Article"`

Response: `A W _ _ A`

## 6.2 TERMINAL, SCALE application blocks

No.	Content	Format
001	Terminal type	Response: <code>A,B _ M,e,t,t,l,e,r,-,T,o,l,e,d,o,_,I,D,7</code>
002	Program number	Response: <code>A,B _ I,T,0,7,-,0,-,0,x,x,x _</code>
004	Serial number	Response: <code>A,B _ Text_20 _ _ SN Terminal (Number_20) _ _</code> <code>Software version scale 1 (Number_14) _ _</code> <code>Software version scale 2 (Number_14) _ _</code> <code>Software version scale 3 (Number_14)</code> Write: <code>A,W 0,0,4 _ Identification (Text_20)</code>
006	Transfer key	Response: <code>A,B _ Keys _ _ 2,4</code> Write: <code>A,W 0,0,6 _ \$ \$ 2,4</code>
007	Current gross weight (2nd weight unit)	Response: <code>A,B _ Weight value _ Unit</code>
008	Current net weight (2nd weight unit)	Response: <code>A,B _ Weight value _ Unit</code>
009	Current tare weight (2nd weight unit)	Response: <code>A,B _ Weight value _ Unit</code> Write: <code>A,W 0,0,9 _ Weight value _ Unit</code>
010	Current weighing platform	Response: <code>A,B _ Number_2</code> Write: <code>A,W 0,1,0 _ Number_2</code> Switch over weighing platform
011	Current gross weight (1st weight unit)	Response: <code>A,B _ Weight value _ Unit</code>
012	Current net weight (1st weight unit)	Response: <code>A,B _ Weight value _ Unit</code>
013	Current tare weight (1st weight unit)	Response: <code>A,B _ Weight value _ Unit</code> Write: <code>A,W 0,1,3 _ Weight value _ Unit</code>
014	Content of display	Response: <code>A,B _ Display</code> Display = Text_20 or weight value
015	Date	Response: <code>A,B _ Date</code> Write: <code>A,W 0,1,5 _ Date</code> Date = DD/MM/YY or DD.MM.YY
016	Dynamic weighing	Response: <code>A,B _ Weight value _ Unit</code> Write: <code>A,W 0,1,6 _ No. of cycles</code> Start weighing cycle Comment: No. of cycles = 1 ... 255
018	Difference target/ actual weight	Response: <code>A,B _ Weight value _ Unit</code>





No.	Content	Format
091	Barcode EAN 28, EAN 128	<p>Response: <input type="text" value="A B _ EAN 28 _ _ EAN 128 01 _ _ EAN 128 310 _ _"/>  <input type="text" value="EAN 128 330"/></p> <p>EAN 28: <input type="text" value="2 8 Article Check digit Weight"/>  Article: 4-digit Article No. from memory Code A  Check digit: 1-digit, calculated by ID7-24V-Base for the weight  Weight: 5-digit positive weight value with 3 decimal places between 00.000 kg - 99.999 kg</p> <p>EAN 128 01: <input type="text" value="0 1 Article"/> or  <input type="text" value="0 1 Article Check digit"/> or  <input type="text" value="0 1 0 Article Check digit"/> or  <input type="text" value="0 1 0 Article"/>  Article: Article No. from memory Code A, max. 14 digits  Check digit: 1-digit, calculated by ID7-24V-Base  Length: total of max. 16 digits</p> <p>EAN 128 310: <input type="text" value="0 1 9 Article Check digit 3 1 0 x Weight"/> or  <input type="text" value="0 1 9 Article 3 1 0 x Weight"/>  Article: Article No. from memory Code A max. 12 or 13 digits  Check digit: 1-digit calculated by ID7-24V-Base  x: 0 ... 6, decimal places of weight value  Weight: 6-digit net weight value</p> <p>EAN 128 330: <input type="text" value="3 3 0 x Weight"/>  x: 0 ... 6, decimal places of weight value  Weight: 6-digit gross weight value</p>
092	Barcode EAN 29	<p>Response: <input type="text" value="A B _ 2 9 Article Check digit Weight"/></p> <p>Comment: Article: 4-digit article no. from memory Code A  Check digit: 1-digit no., calculated from ID7-24V-Base for the weight  Weight: 5-digit positive weight value with 3 places to right of point between 00.000 kg ... 99.999 kg</p>
093	Barcode EAN 29 A	<p>Response: <input type="text" value="A B _ 2 9 Article Weight"/></p> <p>Comment: Article: 5-digit article no. from memory Code A  Weight: 5-digit positive weight value with 3 places to right of point between 00.000 kg ... 99.999 kg</p>
094 ... 097	Identification data Code A ... Code D	<p>Response: <input type="text" value="A B _ Name (text_20) _ _ Identification (text_30)"/></p> <p>Write: <input type="text" value="A W 0 x x _ Name (text_20) \$ \$ Identification (text_30)"/></p> <p>Comment: xx = 94 ... 97</p>
098	Number of last Alibi entry	<p>Response: <input type="text" value="A B _ Number_6 _ _ Date _ _ Time _ _"/>  <input type="text" value="Gross (Weight value) _ _"/>  <input type="text" value="Net (Weight value) _ _"/>  <input type="text" value="Tare (Weight value)"/></p> <p>Note: Date and time as in application block 019.</p>

No.	Content	Format
601	Parameters for Scale 1	Response: <input type="text" value="A"/> <input type="text" value="B"/> <input type="text" value="Parameters for Scale 1"/> Note: For service information purposes the internal scale parameters can be read out/printed; the structure and content are scale-dependent
602	Parameters for Scale 2	Response: <input type="text" value="A"/> <input type="text" value="B"/> <input type="text" value="Parameters for Scale 2"/> Note: For service information purposes the internal scale parameters can be read out/printed; the structure and content are scale-dependent
603	Parameters for Scale 3	Response: <input type="text" value="A"/> <input type="text" value="B"/> <input type="text" value="Parameters for Scale 3"/> Note: For service information purposes the internal scale parameters can be read out/printed; the structure and content are scale-dependent

## 6.3 INTERFACE application blocks

Application blocks are reserved for the possible interface connections. These application blocks can only be read and written to when an ...-ID7 interface is actually installed on the interface connection concerned.

### 6.3.1 Serial interfaces

No.	Content	Format
101	Description of application	Response: <code>A,B _ ID7 Interfaces</code>
102	Program designation	Response: <code>A,B _ IK07-0-0100</code>
103	Transmit buffer COM1	Response: <code>A,B _ Transmit buffer COM1</code> Write*: <code>A,W 1,0,3 _ Information</code>
104	Transmit buffer COM2	Response: <code>A,B _ Transmit buffer COM2</code> Write*: <code>A,W 1,0,4 _ Information</code>
201	Description of application	Response: <code>A,B _ ID7 Interfaces</code>
202	Program designation	Response: <code>A,B _ IK07-0-0100</code>
203	Transmit buffer COM3	Response: <code>A,B _ Transmit buffer COM3</code> Write*: <code>A,W 2,0,3 _ Information</code>
204	Transmit buffer COM4	Response: <code>A,B _ Transmit buffer COM4</code> Write*: <code>A,W 2,0,4 _ Information</code>
701	Description of application	Response: <code>A,B _ ID7 Interfaces</code>
702	Program designation	Response: <code>A,B _ IK07-0-0100</code>
703	Transmit buffer COM5	Response: <code>A,B _ Transmit buffer COM5</code> Write*: <code>A,W 7,0,3 _ Information</code>
704	Transmit buffer COM6	Response: <code>A,B _ Transmit buffer COM6</code> Write*: <code>A,W 7,0,4 _ Information</code>

#### \* Comments on the transmit buffers

- The entered information is transmitted directly via the selected interface.
- A transmit buffer contains a maximum of 246 characters.

### 6.3.2 Digital inputs/outputs

The following application blocks are only available when interface 4 I/O-ID7 is installed on COM5/COM6 or interface RS485-ID7 and relay box 8-ID7 is installed on COM6.

When the weighing terminal checks the outputs, the blocks concerned cannot be written to, and the `E, L` error message appears.

No.	Content	Format
706	Digital outputs 1 COM5/COM6	Response: <code>A, B _ _ 8-place binary value</code> * Write: <code>A, W 7, 0, 6 _ _ 8-place binary value</code> *
707	Digital inputs 1 COM5/COM6	Response: <code>A, B _ _ 8-place binary value</code> *
708	Dig. outputs 2 COM6	Response: <code>A, B _ _ 8-place binary value</code> * Write: <code>A, W 7, 0, 8 _ _ 8-place binary value</code> *
709	Dig. inputs 2 COM6	Response: <code>A, B _ _ 8-place binary value</code> *
710	Dig. outputs 3 COM6	Response: <code>A, B _ _ 8-place binary value</code> * Write: <code>A, W 7, 1, 0 _ _ 8-place binary value</code> *
711	Dig. inputs 3 COM6	Response: <code>A, B _ _ 8-place binary value</code> *
712	Dig. outputs 4 COM6	Response: <code>A, B _ _ 8-place binary value</code> * Write: <code>A, W 7, 1, 2 _ _ 8-place binary value</code> *
713	Dig. inputs 4 COM6	Response: <code>A, B _ _ 8-place binary value</code> *
714	Dig. outputs 5 COM6	Response: <code>A, B _ _ 8-place binary value</code> * Write: <code>A, W 7, 1, 4 _ _ 8-place binary value</code> *
715	Dig. inputs 5 COM6	Response: <code>A, B _ _ 8-place binary value</code> *
716	Dig. outputs 6 COM6	Response: <code>A, B _ _ 8-place binary value</code> * Write: <code>A, W 7, 1, 6 _ _ 8-place binary value</code> *
717	Dig. inputs 6 COM6	Response: <code>A, B _ _ 8-place binary value</code> *
718	Dig. outputs 7 COM6	Response: <code>A, B _ _ 8-place binary value</code> * Write: <code>A, W 7, 1, 8 _ _ 8-place binary value</code> *
719	Dig. inputs 7 COM6	Response: <code>A, B _ _ 8-place binary value</code> *
720	Dig. outputs 8 COM6	Response: <code>A, B _ _ 8-place binary value</code> * Write: <code>A, W 7, 2, 0 _ _ 8-place binary value</code> *
721	Dig. inputs 8 COM6	Response: <code>A, B _ _ 8-place binary value</code> *

\* 8-place binary value: Bit8, Bit7 ... Bit1  
Bit8 = output/input 8 ... Bit1 = output/input 1

No.	Content	Format
724	Set point 1	<p>Response: <input type="text" value="A, B, _"/> Set point (Text_2) <input type="text" value=""/> <input type="text" value=""/></p> <p><input type="text" value="A, x, x, x, _"/> <input type="text" value="Y, Y, Y, ., z, z"/> <input type="text" value=""/> <input type="text" value=""/></p> <p><input type="text" value=""/> Scale (Text_3) <input type="text" value=""/> <input type="text" value=""/></p> <p><input type="text" value=""/> Set point value (weight value) <input type="text" value=""/> <input type="text" value=""/></p> <p>Write: <input type="text" value="A, W, 7, 2, x, _"/> Set point type (Text_2) <input type="text" value=""/> <input type="text" value="\$, \$"/></p> <p><input type="text" value="A, x, x, x, _"/> <input type="text" value="Y, Y, Y, ., z, z"/> <input type="text" value="\$, \$"/></p> <p><input type="text" value=""/> Scale (Text_3) <input type="text" value=""/> <input type="text" value="\$, \$"/></p> <p><input type="text" value=""/> Set point value (weight value) <input type="text" value=""/> <input type="text" value="\$, \$"/></p> <p>Note: x = 4            Set point type: F↑, F↓, D↑, D↓            Scale: W1, W2, W3, ALL</p>
725	Set point 2	<p>Response: equal to 724            Write: equal to 724, x = 5</p>
726	Set point 3	<p>Response: equal to 724            Write: equal to 724, x = 6</p>
727	Set point 4	<p>Response: equal to 724            Write: equal to 724, x = 7</p>

## 7 What to do if ...?

Error / Display	Possible causes	Remedy
Display is dark	<ul style="list-style-type: none"> <li>• No mains voltage</li> <li>• Terminal switched off</li> <li>• Power cord not connected</li> <li>• Brief malfunction</li> </ul>	<ul style="list-style-type: none"> <li>→ Check mains</li> <li>→ Switch on terminal</li> <li>→ Plug in power plug</li> <li>→ Switch terminal off and on again</li> </ul>
Underload	<ul style="list-style-type: none"> <li>• Load plate not in place</li> <li>• Preload not applied</li> <li>• Weighing range dropped below</li> </ul>	<ul style="list-style-type: none"> <li>→ Apply load plate</li> <li>→ Apply preload</li> <li>→ Set zero</li> </ul>
Overload	<ul style="list-style-type: none"> <li>• Weighing range exceeded</li> <li>• Weighing platform locked</li> </ul>	<ul style="list-style-type: none"> <li>→ Relieve weighing platform</li> <li>→ Release lock</li> </ul>
Weight display unstable	<ul style="list-style-type: none"> <li>• Agitated set-up location</li> <li>• Draft</li> <li>• Agitated weighing sample</li> <li>• Contact between load plate and/or weighing sample and surroundings</li> <li>• Power malfunction</li> </ul>	<ul style="list-style-type: none"> <li>→ Adjust vibration adapter</li> <li>→ Avoid drafts</li> <li>→ Weigh dynamically</li> <li>→ Eliminate contact</li> <li>→ Check mains</li> </ul>
Wrong weight display	<ul style="list-style-type: none"> <li>• Wrong setting to zero of weighing platform</li> <li>• Wrong tare weight</li> <li>• Contact between load plate and/or weighing sample and surroundings</li> <li>• Weighing platform tilted</li> <li>• Wrong weighing platform selected</li> </ul>	<ul style="list-style-type: none"> <li>→ Relieve weighing platform, set to zero and repeat weighing</li> <li>→ Delete tare or enter right tare value</li> <li>→ Eliminate contact</li> <li>→ Level weighing platform</li> <li>→ Select right weighing platform</li> </ul>
PLUG IN	<ul style="list-style-type: none"> <li>• Weighing platform cable not plugged in</li> </ul>	<ul style="list-style-type: none"> <li>→ Switch off terminal, plug in weighing platform cable and switch on terminal again</li> <li>→ If the message appears again: contact METTLER TOLEDO Customer Service</li> </ul>
WRONG CODE	<ul style="list-style-type: none"> <li>• Wrong personal code</li> </ul>	<ul style="list-style-type: none"> <li>→ Enter right personal code</li> </ul>
SCALE NO. ERROR	<ul style="list-style-type: none"> <li>• Error in weighing cell</li> </ul>	<ul style="list-style-type: none"> <li>→ Repeat test</li> <li>→ If the message appears again: contact METTLER TOLEDO Customer Service</li> </ul>

Error / Display	Possible causes	Remedy
OUT OF RANGE	<ul style="list-style-type: none"> <li>• Zero set range exceeded</li> <li>• Gross weight negative</li> <li>• Taring range exceeded</li> <li>• Entered value outside permissible range</li> </ul>	<ul style="list-style-type: none"> <li>→ Relieve weighing platform</li> <li>→ Relieve weighing platform and set to zero</li> <li>→ Relieve weighing platform and set to zero</li> <li>→ Enter permissible value</li> </ul>
NOT ALLOWED	<ul style="list-style-type: none"> <li>• Wrong cycle time for dynamic weighing</li> <li>• Weighing platform does not exist</li> <li>• Print with negative weight value</li> </ul>	<ul style="list-style-type: none"> <li>→ Enter cycle time between 1 and 255 cycles</li> <li>→ Connect weighing platform</li> <li>→ Relieve weighing platform, set to zero and repeat weighing</li> </ul>
NOT EXISTENT	<ul style="list-style-type: none"> <li>• Recalled memory not assigned</li> </ul>	<ul style="list-style-type: none"> <li>→ Recall other memory</li> </ul>
NO DATA TRANSFER	<ul style="list-style-type: none"> <li>• Weighing platform does not transmit data to the terminal</li> </ul>	<ul style="list-style-type: none"> <li>→ Switch terminal off and on again</li> <li>→ If the message appears again: contact METTLER TOLEDO Customer Service</li> </ul>
INTERF. COM X – BREAK	<ul style="list-style-type: none"> <li>• Break in receiving cable of specified interface</li> </ul>	<ul style="list-style-type: none"> <li>→ Check cable and connectors</li> <li>→ Check external devices (on/off)</li> </ul>
TRANSMIT BUFFER FULL	<ul style="list-style-type: none"> <li>• No transmission</li> <li>• Too many key messages and baud rate too low</li> </ul>	<ul style="list-style-type: none"> <li>→ Check handshake</li> <li>→ Increase baud rate</li> </ul>
KEY BUFFER FULL	<ul style="list-style-type: none"> <li>• Data string currently being edited contains too many blocks</li> </ul>	<ul style="list-style-type: none"> <li>→ Remove blocks from data string</li> </ul>
ERROR BARCODE	<ul style="list-style-type: none"> <li>• The specified application block contains no data</li> <li>• Wrong sub-block selected, e.g. sub-block 0</li> </ul>	<ul style="list-style-type: none"> <li>→ Select application block which contains data</li> <li>→ Select permissible sub-block</li> </ul>
NO BLOCK	<ul style="list-style-type: none"> <li>• Entered application block does not exist</li> </ul>	<ul style="list-style-type: none"> <li>→ Enter different application block</li> </ul>
BUFFER IS FULL	<ul style="list-style-type: none"> <li>• Data string of transfer key contains more than 10 application blocks</li> </ul>	<ul style="list-style-type: none"> <li>→ Change configuration of transfer key</li> </ul>
DISPLAY MODE	<ul style="list-style-type: none"> <li>• Weighing cell defective</li> <li>• 2 weighing platforms with same scale number connected</li> </ul>	<ul style="list-style-type: none"> <li>→ Contact METTLER TOLEDO Customer Service</li> <li>→ Contact METTLER TOLEDO Customer Service</li> </ul>

## 8 Technical data and accessories

### 8.1 Technical data

Terminal	
Display	<ul style="list-style-type: none"> <li>• Active, brightly lit green VFD dot matrix display, with graphics capabilities, 40 x 170 pixels, display field 135 x 46 mm</li> <li>• BIG WEIGHT® display with 35 mm high characters</li> <li>• Cover of scratch-resistant, hardened, antireflection glass</li> </ul>
Keypad	<ul style="list-style-type: none"> <li>• Tactile-touch membrane keypad with acoustic acknowledgement</li> <li>• Scratch-resistant marking, 3-color</li> <li>• 4 keys A to D for identification data, 6 function keys with function change and info key, 4 scale function keys, numerical keypad</li> <li>• Alphanumeric input possible with function keys</li> <li>• Standard connection for external MFII keypad</li> </ul>
Housing	<ul style="list-style-type: none"> <li>• All nickel chromium steel DIN X5 CrNi 1810</li> <li>• Weight: net 3.5 kg; gross 5 kg</li> </ul>
Protection type (IEC 529, DIN 40050)	<ul style="list-style-type: none"> <li>• Dust and water-tight as per IP68</li> <li>• Resistant to high-pressure and steam jet cleaning as per IPX9K</li> </ul>
Power supply	<ul style="list-style-type: none"> <li>• 24 V DC, +20/-15 % in mains operation</li> <li>• 24 V DC, +20/-12.5 % in storage battery operation</li> <li>• Power cable with open ends, length approx. 2.5 m</li> <li>• Power consumption approx. 12 – 58 VA, depending on design level</li> <li>• Current consumption approx. 0.5 – 2.5 A, depending on design level</li> <li>• Audible signal in storage battery operation, if the supply voltage drops below 22.5 V</li> <li>• Automatic switch-off of the ID7-24V-Base in storage battery operation, if the supply voltage drops below 21 V</li> <li>• 8-hour storage battery: 7 to 20 Ampere-hours, depending on design level</li> </ul>
Ambient conditions as per EN 60950	<ul style="list-style-type: none"> <li>• Pollution degree 2</li> <li>• Overvoltage category II</li> <li>• Maximum operating elevation in m above sea level: 2000 m</li> </ul>
Ambient temperature	<ul style="list-style-type: none"> <li>• Operation:    -10 °C – +40 °C    for weighing platforms of certification class III                           0 °C – +40 °C    for weighing platforms of certification class II</li> <li>• Lagerung:     -25 °C – +60 °C</li> </ul>
Relative humidity	20 – 80 % , non condensing



Terminal							
Weighing platform connection	<ul style="list-style-type: none"> <li>• 1 IDNet connection standard for METTLER TOLEDO weighing platforms of the series D, F, K, N, Spider ID, DigiTOL, analog scales with AWU 3/6 and analytical and precision scales of series B, G and R</li> <li>• 2 additional weighing platform connections possible (IDNet-ID7 oder Analog Scale-ID7)</li> </ul>						
Interface connection	1 RS232 connection standard, maximum of 5 additional interface connections possible						
Total load of all output voltages on the ID7-24V-Base	<table> <tr> <td>Output voltage 5 V</td> <td>max. 600 mA</td> </tr> <tr> <td>Output voltage 12 V</td> <td>max. 200 mA</td> </tr> <tr> <td>Output voltage 24 V</td> <td>max. 100 mA</td> </tr> </table>	Output voltage 5 V	max. 600 mA	Output voltage 12 V	max. 200 mA	Output voltage 24 V	max. 100 mA
Output voltage 5 V	max. 600 mA						
Output voltage 12 V	max. 200 mA						
Output voltage 24 V	max. 100 mA						

Weighing functions	
Tare compensation	At the press of a button or automatically, up to maximum load (subtractive)
Tare target value	<ul style="list-style-type: none"> <li>• For single-range scales over entire weighing range (subtractive)</li> <li>• For multi-range scales depending on national calibration regulations</li> <li>• 999 stored tare memories, protected against power failure</li> </ul>
Tare calculation	Tare addition, tare multiplication, sub-tare
Tare indicator	NET lights up with saved tare weight
DeltaTrac	<ul style="list-style-type: none"> <li>• Analog display of dynamic measured values</li> <li>• With optical marks for target value and tolerances</li> <li>• 3 selectable applications</li> <li>• 999 DeltaTrac memories, protected against power failure</li> </ul>
Setting to zero	Automatic or manual
Gross changeover	Display of weight value can be changed over to gross weight at press of a button
Unit changeover	Unit can be changed over to weight units kg, g, lb, oz, ozt, dwt in dependence on national calibration regulations at press of a button
Dynamic weighing	<ul style="list-style-type: none"> <li>• Cycle time adjustable from 1 – 255 cycles</li> <li>• Automatic printout selectable</li> </ul>
Stabilization detector	4-step, with motion indicator

<b>Weighing functions</b>	
Weighing process adapter	3-step adjustment to weighing sample
Vibration adapter	3-step adjustment to ambient conditions
Test	Test function for displaying the ID code and checking weighing platform
Identification data	<ul style="list-style-type: none"> <li>• 4 memories for 20 alphanumeric characters, can be recalled with keys A to D</li> <li>• Each memory can be assigned a fixed name which can be written in the marking field next to the corresponding key</li> <li>• 999 memories for frequently used identification data</li> </ul>
Info function	Displays of current weighing data, identification data and memories at the press of a button
Date and time	<ul style="list-style-type: none"> <li>• For printout or output via the data interface</li> <li>• Quartz-controlled, 12 or 24-hour display, automatic calendar function, Europe or US format, protected against power failures</li> </ul>

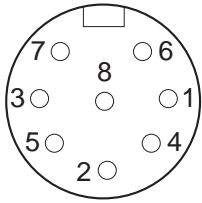
<b>Interface RS232-ID7</b>	
Interface type	Voltage interface as per EIA RS232C/DIN 66020 (CCITT V.24/V.28)
Control signals DTR, DSR	<ul style="list-style-type: none"> <li>• Signal level 0 (for <math>R_L &gt; 3 \text{ k}\Omega</math>): <math>-3 \text{ V} - -25 \text{ V}</math> (low level)</li> <li>• Signal level 1 (for <math>R_L &gt; 3 \text{ k}\Omega</math>): <math>+3 \text{ V} - +25 \text{ V}</math> (high level)</li> </ul>
Data lines TXD, RXD	<ul style="list-style-type: none"> <li>• Signal level 0 (for <math>R_L &gt; 3 \text{ k}\Omega</math>): <math>+3 \text{ V} - +25 \text{ V}</math> (high level)</li> <li>• Signal level 1 (for <math>R_L &gt; 3 \text{ k}\Omega</math>): <math>-3 \text{ V} - -25 \text{ V}</math> (low level)</li> </ul>
Interface parameters	Operating mode full duplex Transmission type bit serial, asynchronous Transmission code ASCII Data bits 7/8 Stop bits 1/2 Parity parity even, parity odd, parity space, parity mark, no parity Baud rate 150, 300, 600, 1200, 2400, 4800, 9600, 19200 baud
Socket  External view	8-pin circular connector, socket Pin 1 Ground Pin 2 TXD, transmission line of scale Pin 3 RXD, receiving line of scale Pin 4 DTR, Data Terminal Ready Pin 5 for COM1 – COM6: $+5 \text{ V}$ , max. 250 mA (factory setting) – or – for COM2 – COM6: $+12 \text{ V}$ , max. 100 mA; configuring of Pin 5, see section 9.4 Pin 6 Signal Ground Pin 8 DSR, Data Set Ready
Cable	<ul style="list-style-type: none"> <li>• Shielded, stranded in pairs, max. 15 m</li> <li>• Cable resistance <math>\leq 125 \text{ }\Omega/\text{km}</math></li> <li>• Cable cross section <math>\geq 0.14 \text{ mm}^2</math></li> <li>• Cable capacity <math>\leq 130 \text{ nF}/\text{km}</math></li> </ul>

Dimensions

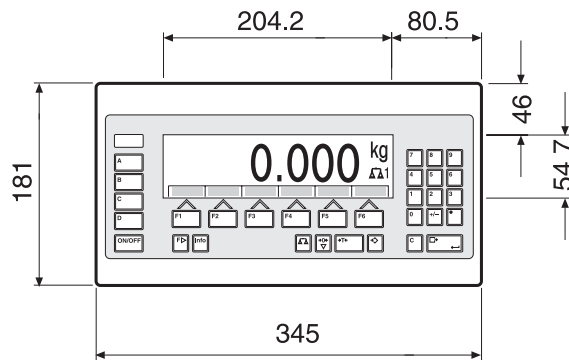

Side view

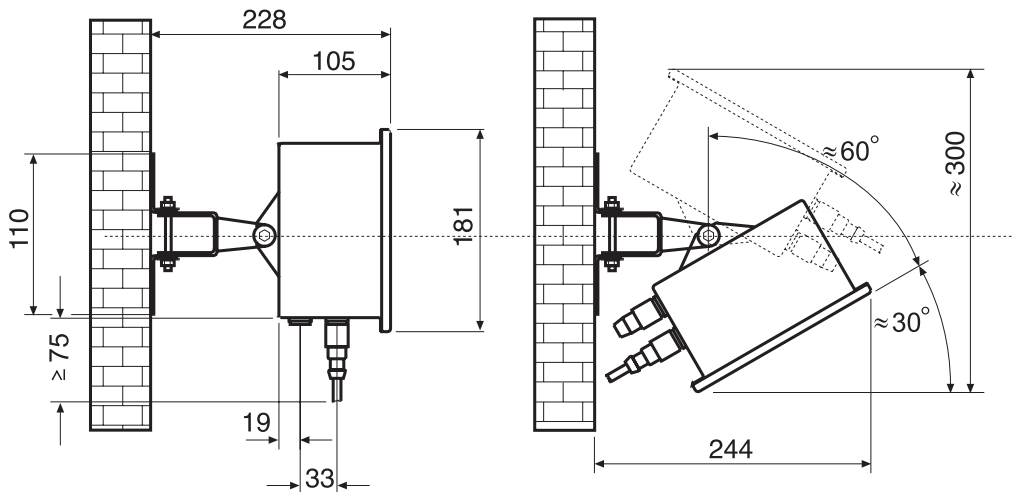

View from above

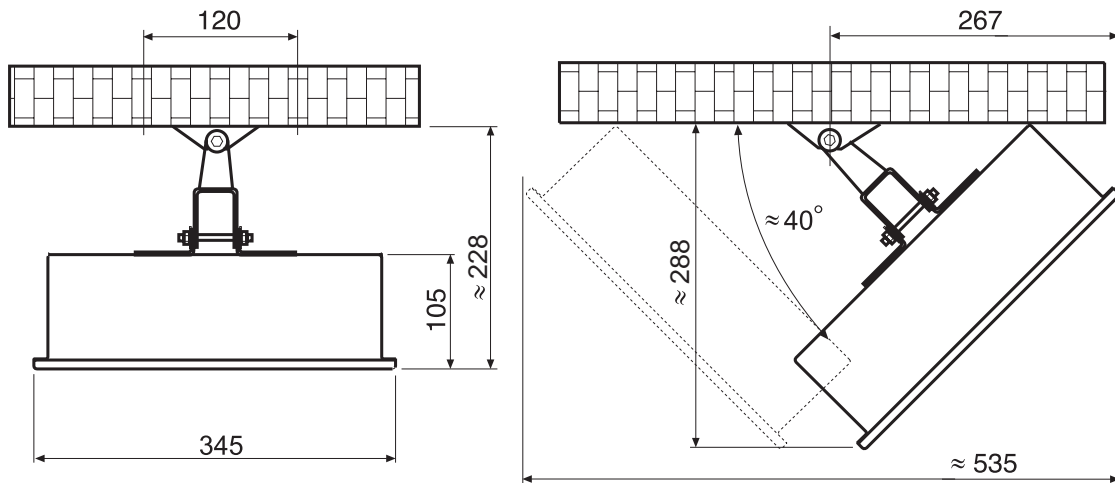

Dimensions in mm

## 8.2 Accessories

Applications		Order No.
ControlPac-ID7	Basic functions, checking, classifying	22 004 098
CountPac-ID7	Basic functions, convenient counting, totalizing	22 004 092
DataPac-ID7	Basic functions, data communication	22 004 094
DosPac-ID7	Basic functions, dispensing, filling	22 004 096
DosPac-R-ID7	Basic functions, multi-component dispensing	22 004 097
FormPac-ID7	Basic functions, formulation, dispensing	22 004 093
FormPac-XP-ID7	Basic functions, formulation, dispensing, based upon database, incl. PC software FormTool-XP	22 005 899
SumPac-ID7	Basic functions, totalizing, inventory management	22 004 095
SysPac-ID7	Basic functions, customer-specific application	22 005 340

Weighing platform connections		Order No.
IDNet ID7	<ul style="list-style-type: none"> <li>• Connection for an IDNet weighing platform</li> <li>• Max. of 2 additional connections possible</li> </ul>	22 001 082
Analog Scale ID7	<ul style="list-style-type: none"> <li>• Connection for a weighing platform with an analog signal output</li> <li>• Max. of 2 additional connections possible</li> </ul>	22 001 083
LC IDNet R/G	Connection set for connecting METTLER TOLEDO R/G scales to IDNet connection of ID7-24V-Base	00 229 110
LC IDNet B	Connection set for connecting METTLER TOLEDO B scales to IDNet connection of ID7-24V-Base	00 229 225
GD17	Connection set for connecting DigiTOL scales to IDNet connection of ID7-24V-Base	00 507 073

Serial data interfaces		Order No.
CL20mA-ID7	CL 20 mA interface	22 001 084
Accessories for CL20mA-ID7	CL cable, 3 m	00 503 749
	Mating connector, 7-pin	00 503 745
	Second-display cable CL20mA-ID7 – ID1 Plus/ID3s/ID7, 10 m	00 504 511
	Extension cable for second display, 10-pin, 10 m	00 504 134
	Adapter cable PE / CL, 0.3 m	22 003 029
RS232-ID7	RS232 interface	22 001 085
Accessories for RS232-ID7	RS232 cable/DTE, 3 m	00 503 754
	RS232 cable/DCE, 3 m	00 503 755
	RS232 cable/PC, 3 m	00 504 374
	RS232 cable/9-pin, 3 m	00 504 376
	RS232 cable/Scale, 3 m	22 006 795
	Mating connector, 8-pin	00 503 756
RS422-ID7	RS422 interface, electrically isolated	22 003 031
RS485-ID7	RS485 interface, electrically isolated	22 001 086
Accessories for RS422-ID7/RS485-ID7	RS422/485 cable, 6-pin, open end, 3 m	00 204 933
	Mating connector, 6-pin	00 204 866
	Extension cable, 10 m	00 204 847
8-ID7 relay box	8 digital inputs, 8 digital outputs, for connection to RS485-ID7	22 001 089
Accessories for 8-ID7 relay box	RS422/485 cable, 6-pin, open end, 3 m	00 204 933
	Power supply unit for 8-ID7 relay box, 24 V DC	00 505 544
	Extension cable, 10 m	00 204 847

Digital inputs/outputs		Order No.
4 I/O-ID7	4 digital inputs, 4 digital outputs	22 001 087
4-ID7 relay box	Relay box for 4 I/O-ID7; 4 digital inputs, 4 digital outputs, for connection to 4 I/O-ID7	22 001 088
Accessories for 4-ID7 relay box	Cable for 4 I/O-ID7, 19-pin, open end, 10 m	00 504 458
	Mating connector, 19-pin	00 504 461
8-ID7 relay box	8 digital inputs, 8 digital outputs, for connection to RS485-ID7	22 001 089
Accessories for 8-ID7 relay box	RS422/485 cable, 6-pin, open end, 3 m	00 204 933
	Power supply unit for 8-ID7 relay box, 24 V DC	00 505 544

Digital/analog interface		Order No.
Analog Output-ID7	Digital/analog output 0 – 10 V, 0 – 20 mA or 4 – 20 mA	22 001 090
Accessories for Analog Output-ID7	Cable for Analog Output-ID7, 5-pin, 3 m Mating connector, 5-pin	00 204 930 00 205 538

Alibi memory		Order No.
Alibi Memory-ID7	Paperless archiving of certification-relevant weighing data	22 001 663

Network connections		Order No.
Ethernet ID7	Network card	22 003 694
Connection cable for ID7 to Ethernet network	Twisted-pair cable, 16-pin, RJ45      5 m	00 205 247
	Twisted-pair cable, 16-pin, RJ45      20 m	00 208 152
Profibus-DP-ID7	Field bus card	22 004 940
WLAN-ID7	Radio network card	22 010 390

Printer		Order No.
GA46	Printer in separate tabletop housing of nickel chromium steel, protection type IP21 Printing of weighing data and barcodes on 62 mm wide thermal paper Interface RS232, cable approx. 2.5 m For technical details see data sheet GA46	00 505 471
GA46/0.4 m	As for GA46, however with 0.4 m cable	00 507 229
GA46-W	As for GA46, however with integrated paper winding device and transparent PVC cover Protection type IP65	00 505 799
GA46-W/0.4 m	As for GA46-W, however with 0.4 m cable	00 507 230
Accessories for GA46	Protective cover for GA46	00 507 224

<b>External keypad</b>		<b>Order No.</b>
AK-MFII	Compact, alphanumeric membrane keypad for connection to the standard-equipment 5-pin MFII circular connector Housing of all nickel chromium steel, protection type IP65 Dimensions (W x D x H): 380 mm x 158 mm x 30 mm Cable approx. 1 m	00 505 490

<b>Other accessories</b>		<b>Order No.</b>
Protective covers	Elastic, transparent protective keyboard film, 3 pieces	22 001 091



# 9 Appendix

## 9.1 ASCII table

hex	deci	ASCII US	hex	deci	ASCII US	hex	deci	ASCII US	hex	deci	ASCII US	hex	deci	ASCII US
00	0	NUL	34	52	4	68	104	h	9C	156	₤	D0	208	⌚
01	1	SOH	35	53	5	69	105	i	9D	157	¥	D1	209	⌚
02	2	STX	36	54	6	6A	106	j	9E	158	₹	D2	210	⌚
03	3	ETX	37	55	7	6B	107	k	9F	159	₱	D3	211	⌚
04	4	EOT	38	56	8	6C	108	l	A0	160	á	D4	212	⌚
05	5	ENQ	39	57	9	6D	109	m	A1	161	í	D5	213	⌚
06	6	ACK	3A	58	:	6E	110	n	A2	162	ó	D6	214	⌚
07	7	BEL	3B	59	;	6F	111	o	A3	163	ú	D7	215	⌚
08	8	BS	3C	60	<	70	112	p	A4	164	ñ	D8	216	⌚
09	9	HT	3D	61	=	71	113	q	A5	165	Ñ	D9	217	⌚
0A	10	LF	3E	62	>	72	114	r	A6	166	ª	DA	218	⌚
0B	11	VT	3F	63	?	73	115	s	A7	167	º	DB	219	■
0C	12	FF	40	64	@	74	116	t	A8	168	¿	DC	220	■
0D	13	CR	41	65	A	75	117	u	A9	169	ƒ	DD	221	■
0E	14	SO	42	66	B	76	118	v	AA	170	ƒ	DE	222	■
0F	15	SI	43	67	C	77	119	w	AB	171	½	DF	223	■
10	16	DLE	44	68	D	78	120	x	AC	172	¼	E0	224	α
11	17	DC1	45	69	E	79	121	y	AD	173	ı	E1	225	β
12	18	DC2	46	70	F	7A	122	z	AE	174	«	E2	226	Γ
13	19	DC3	47	71	G	7B	123	[	AF	175	»	E3	227	Π
14	20	DC4	48	72	H	7C	124	]	B0	176	█	E4	228	Σ
15	21	NAK	49	73	I	7D	125	}	B1	177	█	E5	229	σ
16	22	SYN	4A	74	J	7E	126	~	B2	178	█	E6	230	μ
17	23	ETB	4B	75	K	7F	127	⌣	B3	179		E7	231	τ
18	24	CAN	4C	76	L	80	128	reserved	B4	180		E8	232	φ
19	25	EM	4D	77	M	81	129	ü	B5	181		E9	233	θ
1A	26	SUB	4E	78	N	82	130	é	B6	182		EA	234	Ω
1B	27	ESC	4F	79	O	83	131	â	B7	183		EB	235	ø
1C	28	FS	50	80	P	84	132	ä	B8	184		EC	236	∞
1D	29	GS	51	81	Q	85	133	å	B9	185		ED	237	∅
1E	30	RS	52	82	R	86	134	ã	BA	186		EE	238	ε
1F	31	US	53	83	S	87	135	ç	BB	187		EF	239	∩
20	32	SP	54	84	T	88	136	ê	BC	188		F0	240	≡
21	33	!	55	85	U	89	137	ë	BD	189		F1	241	±
22	34	"	56	86	V	8A	138	è	BE	190		F2	242	≥
23	35	#	57	87	W	8B	139	ï	BF	191		F3	243	≤
24	36	\$	58	88	X	8C	140	î	C0	192		F4	244	∫
25	37	%	59	89	Y	8D	141	ì	C1	193		F5	245	∫
26	38	&	5A	90	Z	8E	142	Ë	C2	194		F6	246	÷
27	39	'	5B	91	[	8F	143	Å	C3	195		F7	247	≈
28	40	(	5C	92	\	90	144	É	C4	196		F8	248	°
29	41	)	5D	93	]	91	145	æ	C5	197		F9	249	•
2A	42	*	5E	94	^	92	146	Æ	C6	198		FA	250	·
2B	43	+	5F	95	_	93	147	ô	C7	199		FB	251	√
2C	44	,	60	96	`	94	148	ö	C8	200		FC	252	∞
2D	45	-	61	97	a	95	149	ò	C9	201		FD	253	²
2E	46	.	62	98	b	96	150	û	CA	202		FE	254	.
2F	47	/	63	99	c	97	151	ù	CB	203		FF	255	
30	48	0	64	100	d	98	152	ÿ	CC	204				
31	49	1	65	101	e	99	153	Ö	CD	205				
32	50	2	66	102	f	9A	154	Ü	CE	206				
33	51	3	67	103	g	9B	155	ç	CF	207				

## 9.2 Key numbers

All keys of the ID7-24V-Base are assigned numbers so that they may be addressed via the interface.

Key	Number	Key	Number
Key 0	0	SCALE key	19
Key 1	1	ZERO-SET key	20
...	...	TARE key	21
Key 9	9	TARE SPECIFICATION key	22
Decimal point key	10	CLEAR key	23
Function key F1	11	ENTER key	24
Function key F2	12	CODE A key	25
Function key F3	13	CODE B key	26
Function key F4	14	CODE C key	27
Function key F5	15	CODE D key	28
Function key F6	16	SIGN key	29
CHANGE FUNCTION key	17	ON/OFF key	30
INFO key	18		

### 9.3 Opening/closing ID7-24V-Base weighing terminal



#### CAUTION

- The ID7-24V-Base weighing terminal may only be opened by authorized personnel!
- Switch off the power supply before opening the terminal.

#### Opening

1. Unscrew the screws on the underside of the cover and fold the cover toward the front. When doing so, make sure that the cables are not damaged.
2. Fold open the mounting plate.

#### Closing

1. Fold in the mounting plate.
2. Position the cover and screw on again. When doing so, make sure that no cables are pinched.

### 9.4 Configuring Pin 5 on RS232-ID7 interface

Pin 5 of the RS232-ID7 interface can be configured for the connection of devices which require a 12 V supply voltage (with COM2 – COM6 only).

1. Open weighing terminal.
2. Change position of jumper W1 on RS232-ID7 board.

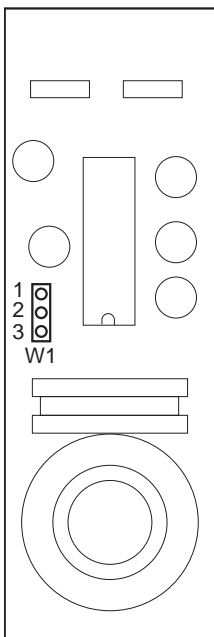

Jumper W1	Voltage at Pin 5
Pin 1 and 2 (factory setting)	5 V
Pin 2 and 3	12 V

3. Close weighing terminal again.



## 9.5 Drilling template for wall mounting

→ Cut the drilling template out of these instructions.

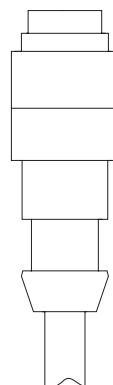
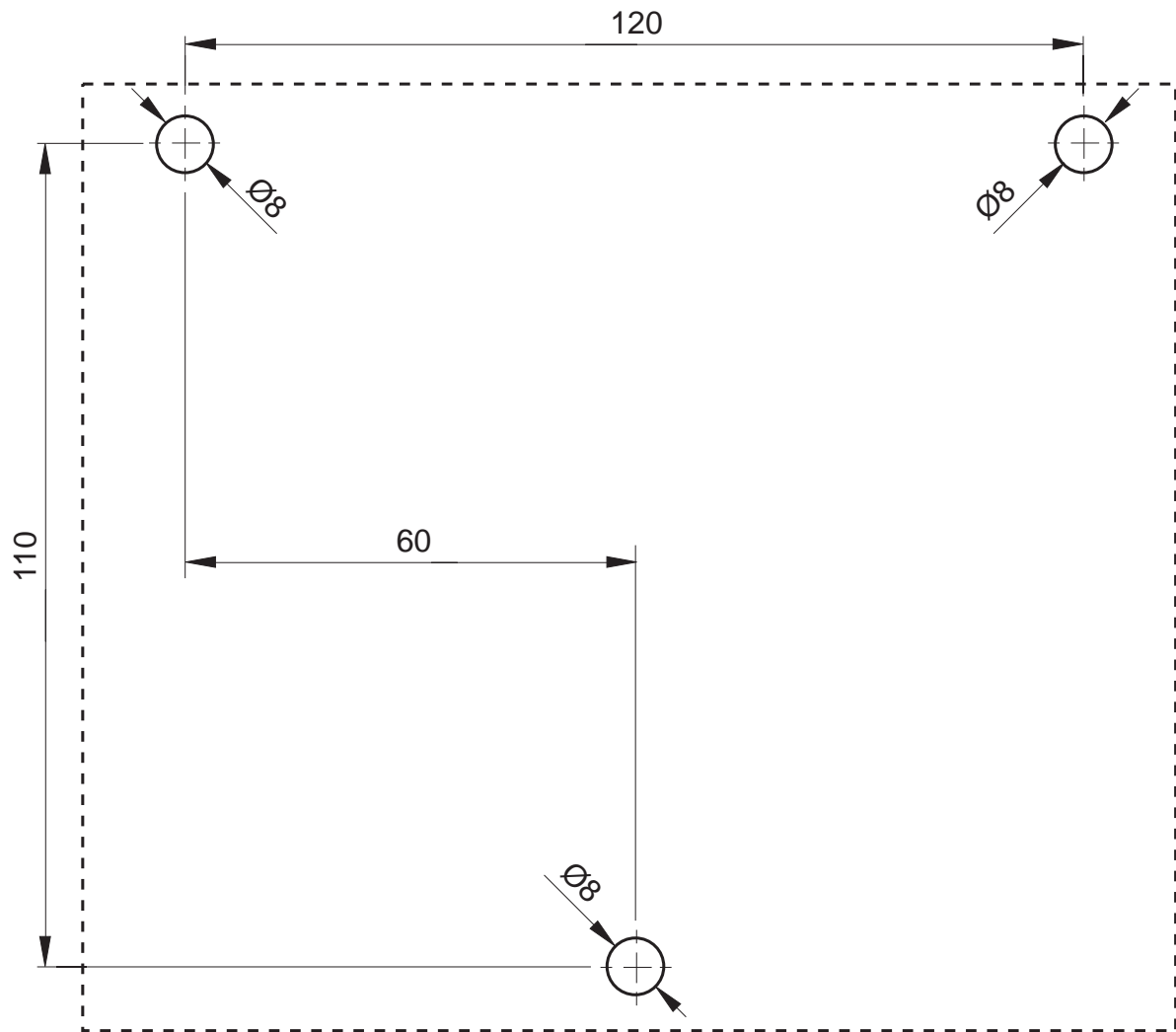

Space needed

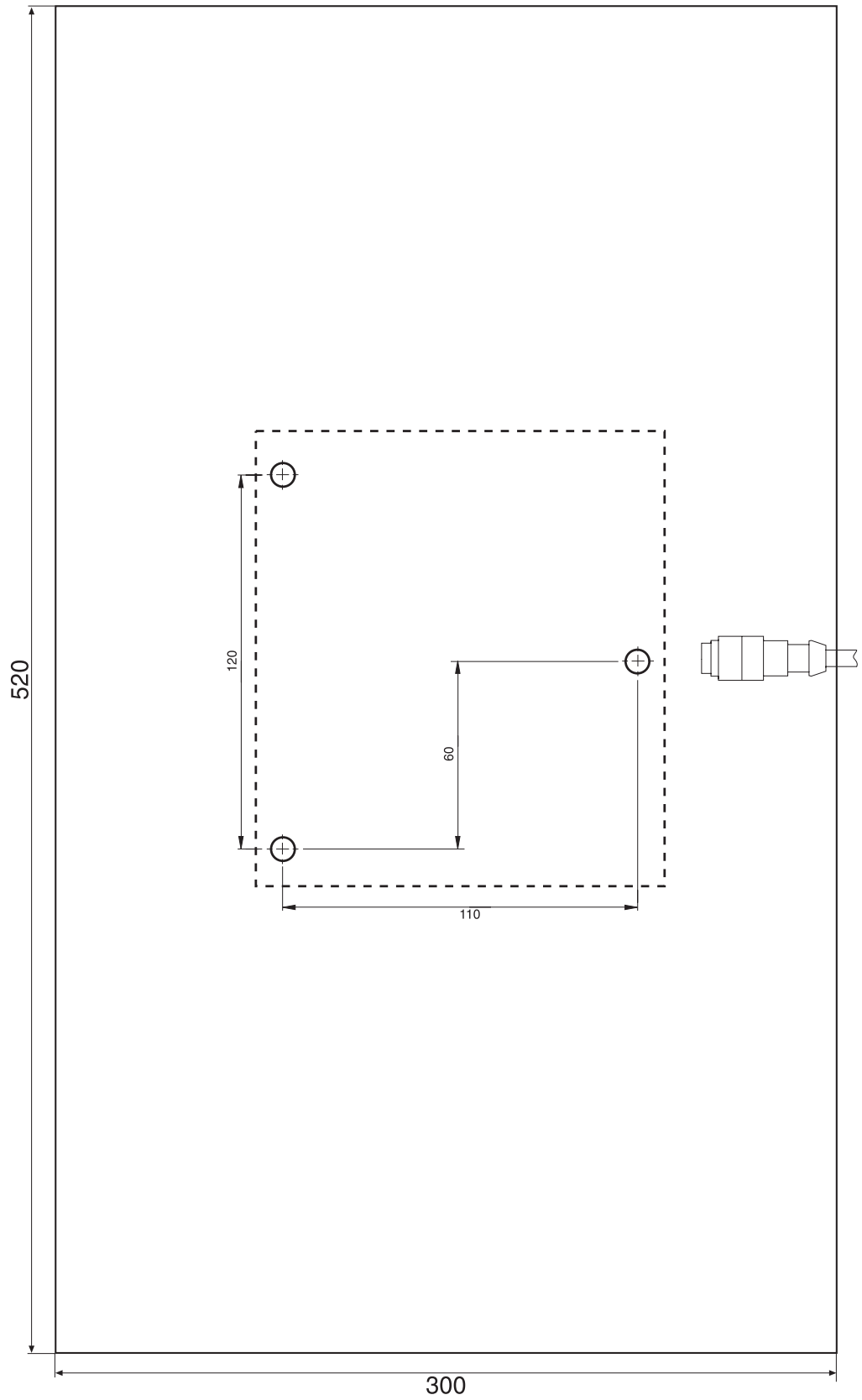

# 10 Index

## A

Accessories 99  
 Acoustic signal 62, 77  
 Additional functions 16  
 Additive tare function 21  
 Alibi Memory-ID7 7, 40, 101  
 Alphanumeric  
   identification 23  
 Alphanumeric keypad 26, 102  
 Alphanumeric printout 62, 79  
 Analog Output-ID7 6, 101  
 Application blocks 61, 77, 78, 82  
 Applications 3  
 ASCII characters 55, 103  
 Automatic continuous transmission 43  
 Automatic taring 13, 38, 95  
 Autozero 13, 38

## B

Barcode 25, 40, 50, 62  
 Basic functions 12  
 Big Weight Display 2, 4, 34, 94  
 Bus Slave 42, 55

## C

Certified weighing platforms 10  
 Change over weight unit 57, 77, 95  
 Check mode 34  
 Checkweighing 17  
 Classifying 17  
 Cleaning 11  
 Command format 67  
 Command overview 56, 68  
 Commissioning 7  
 Communication 42  
 Configuration printouts 46  
 Connect weighing platforms 8  
 Connections 6

## D

Data formats 55, 67  
 Date 33, 96  
 DeltaTrac 16, 32, 59, 78, 95  
 DeltaTrac memory 18, 31

DeltaTrac target values 18, 59, 78  
 Dialog mode 42, 54  
 Digital inputs/outputs 6, 90, 100  
 Digital/analog interface 6, 101  
 Display 4, 61, 71, 94  
 Display Mode 93  
 Display update 39  
 Dynamic weighing 19, 34, 95

## E

Edit data string 47  
 Error messages 64, 81, 92  
 External keypad 26, 32, 102

## F

Filling 17  
 Function keys 4, 16, 94

## G

GA46 40, 101  
 Gross 20, 95

## H

Housing 94

## I

I/O test 52  
 ID code 10, 22  
 ID5 mode 35  
 Identifications 22, 62, 96  
 Interface 4 I/O-ID7 40  
 Interface CL20mA-ID7 40  
 Interface connections 6, 40, 95  
 Interface description 54  
 Interface RS232-ID7 97  
 Interface type 40  
 Introduction 3

## K

Keypad 5, 94

## L

Language 32

## M

Master mode 28  
 Memory 24  
 METTLER TOLEDO continuous mode 44  
 MMR command set 43, 54

Multiplicative tare function 21

## O

Operating mode 42

## P

Personal code 33  
 Print 25  
 Print mode 42, 46  
 Printout 62

## R

Recall information 24  
 Representable characters 103  
 Reset scale 39  
 Reset terminal 36  
 Response format 67  
 Restart 39  
 RS... 40  
 RS232-ID7 interface 41

## S

Safety precautions 3  
 Sandwich tare 21  
 Second display 27, 100  
 Second unit 39  
 Serial interfaces 54  
 Set zero 12, 57, 71, 95  
 SICS command set 43, 67  
 Stability detector 38  
 Status byte 65, 66  
 String framing 43, 55, 67  
 Switch keyboard on/off 57  
 Switch keypad on/off 57, 77  
 Switch off 12  
 Switch on 12  
 Switch over weighing platform 15

## T

Tare 13, 58, 95  
 Tare memory 14, 31  
 Taring 74  
 Technical data 94  
 Terminal 94  
 Test 96  
 Test weighing platform 22  
 Text memory 23, 31  
 Time 33, 96  
 Transfer data 25  
 Transfer string 43  
 Transmit buffer 89  
 Transmit data record 60, 76

Transmit weight value 59, 70

## U

Unit changeover 95

## V

Vibration adapter 38, 96

## W

Wägebrückenanschluß 95  
 Weighing 14  
 Weighing functions 95  
 Weighing platform connections 99  
 Weighing process adapter 38, 96  
 What to do if ...? 92



**22006771A**

Subject to technical changes © Mettler-Toledo (Albstadt) GmbH 04/10 Printed in Germany 22006771A

**Mettler-Toledo (Albstadt) GmbH**

D-72458 Albstadt

Tel. ++49-7431-14 0, Fax ++49-7431-14 232

Internet: <http://www.mt.com>