

Installation information

METTLER TOLEDO MultiRange
Floor scales / Pit scales
For hazardous areas

METTLER TOLEDO

KC300..x-T4/KCS300..x-T4
KC600..x-T4/KCS600..x-T4
KD600..x-T4/KD1500..x-T4
KE1500..x-T4/KE3000..x-T4
KES1500..x-T4/KES3000..x-T4
KG3000..x-T4/KG6000..x-T4
KN1500..x-T4

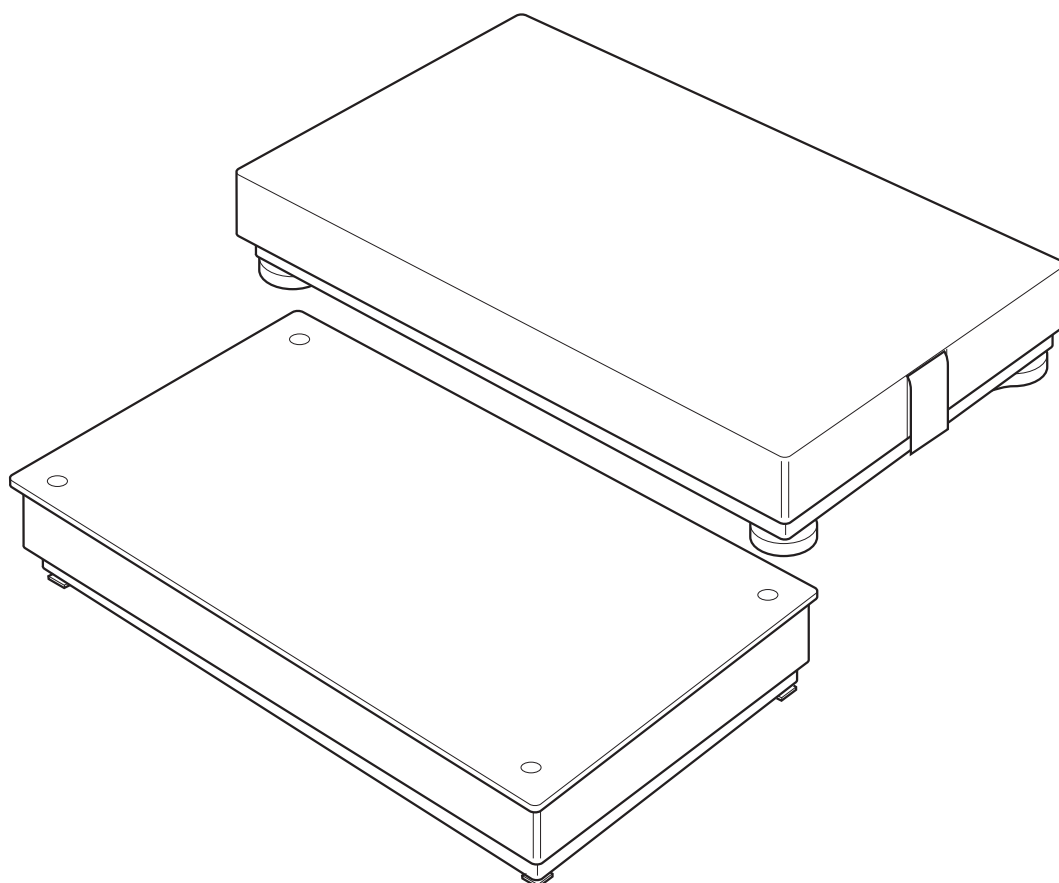

Contents		Page
1	Safety precautions	2
2	Installation.....	4
2.1	Preparatory work	4
2.2	Setting up and levelling	4
2.3	Installing connection cable	10
2.4	Pit installation	12
3	Configuration possibilities	14
3.1	General information	14
3.2	Configuration data	15
4	Planning assemblies	17
4.1	Notes on planning	17
4.2	Preload range	18
4.3	Mounting possibilities	19
4.4	Opening possibilities	26
5	Dimensions	32

1 Safety precautions



There is an increased danger of injuries and damage when using the K...x-line weighing platforms in hazardous areas.

Special care must be taken when working in such hazardous areas. The code of practice is oriented to the "Safe Distribution" concept drawn up by METTLER TOLEDO. The K...x-line weighing platforms with the measuring cells TBrick 15-Ex or TBrick 32-Ex are admitted when using in the following domains:

Classification according to CENELEC

II 2 G/D EEx ib IIC T4

Classification according to FM

Class I, II, III Division 1, Group A – G

- Competence** ▲ The K...x-line weighing platforms may only be installed, maintained and repaired by authorised METTLER TOLEDO service personnel.
- Ex approval** ▲ No modifications may be made to the device and no repair work may be performed on the modules. Any weighing platforms or system modules that are used must comply with the specifications. Non-compliant equipment jeopardises the intrinsic safety of the system, cancels the Ex approval and renders any warranty or product liability claims null and void.
- ▲ The safety of the weighing system is only guaranteed when the weighing system is operated, installed and maintained in accordance with the respective instructions.
- ▲ Also comply with the following:
- the instructions for the system modules,
 - the relevant national regulations and standards,
 - the applicable statutory requirements for electrical equipment installed in hazardous areas in the respective country,
 - all instructions related to safety issued by the owner.
- ▲ The explosion-proof weighing system must be checked to ensure compliance with the safety requirements before being put into service for the first time, following any service work and at least every 3 years.
- Operation** ▲ Prevent the build-up of static electricity. Always wear suitable working clothes when operating or performing service work in a hazardous area.
- ▲ Do not use protective covers with the devices.
- ▲ Any protective foils possibly present on the load plate have to be removed prior to the first startup.
- ▲ Prevent damage to the weighing platforms.

- Installation**
- ▲ Only install or perform maintenance work on the weighing system in the hazardous area if the following conditions are fulfilled:
 - the owner has issued a permit ("spark permit" or "fire permit"),
 - the area has been rendered safe and the owner's safety co-ordinator has confirmed that there is no danger,
 - the necessary tools and any required protective clothing are provided (danger of the build-up of static electricity).
 - ▲ The certification papers (certificates, manufacturer's declarations) must be present.
 - ▲ Lay cables in such a way that they are protected from damage.
 - ▲ Only route cables into the housing of the system modules via the suitable gland and ensure proper seating of the seals.

2 Installation

2.1 Preparatory work

2.1.1 Selecting installation location

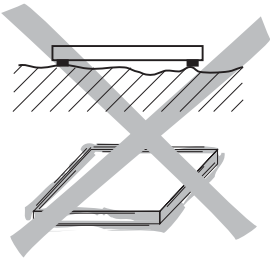

- ▲ The foundation at the installation location must be capable of safely support the weight of the weighing platform at its support points when it carries the maximum load. At the same time, it should be so stable that no vibrations occur during weighing operations. These requirements also apply when the weighing platform is integrated in conveying systems and the like.
- ▲ Ensure that vibrations due to machines near the installation site are kept to a minimum.

2.1.2 Ambient conditions

- Use powder-coated/enamelled weighing platforms only in a dry environment.
- In a damp environment, in wet operation or when working with chemicals: Use stainless-steel weighing platforms.

2.1.3 Accessories

- Completely unpack the accessories provided with the weighing platform.
 - 1 Identcard
 - 1 Set of signs for selectable configurations
additionally provided for KD...x, KE...x, KES...x:
 - 4 Eye bolts in bag
additionally provided for KE...skx, KES...skx:
 - 2 Eye bolts in bag
 - 1 Special key
 - 1 Universal oil
additionally provided for KN...x:
 - 2 Eye bolts with nuts
 - 1 Set of mounting parts for screwing on the floor

2.2 Setting up and levelling

2.2.1 Setting up and levelling KC...x/KCS...x

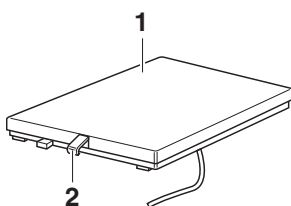

1. To reduce weight, first lift off the load carrier (1). Fold out the lift-off locks (2) on both faces of the load carrier to use as handles.
2. Lift the weighing platform off the transport pallet and set down at the installation location.
Be careful when lifting it off the pallet to prevent the lever mechanism open at the bottom from being damaged.

Releasing transport lock

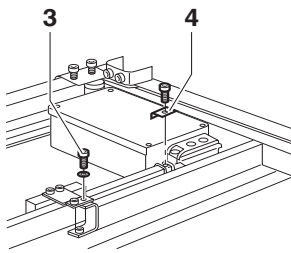

1. Unscrew and remove the yellow locking screw (3).
2. Unscrew the yellow angled locking bracket (4).

Keep the locking elements for use when transporting the weighing platform in the future.

Levelling

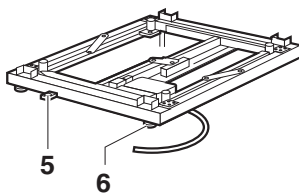

1. Level the weighing platform with the four foot bolts (6) using the level indicator (5): The air bubble of the level indicator must come to rest in the centre of the ring marking.
2. Ensure even contact of the foot bolts. Check the stability of the weighing platform by pressing down on or rocking it at the corners.

2.2.2 Setting up and levelling KD...x/KE...x/KE...skx/KES...x/KES...skx

Setting up KD...x/KE...x/KES...x

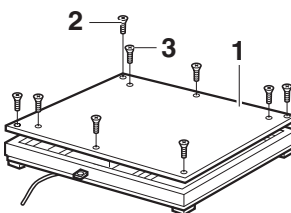

1. Lift off the load plate (1) after unscrewing the 6 or 8 screws (2). The eye bolts (3) can be screwed into the threads after removing the blind screws as lifting aid. Depending on the shipping warehouse or the model ordered, the load plate may also be included in separate packing. Then the mounting screws and the blind screws are supplied in the accessories bag.
2. Lift the weighing platform off the transport pallet. To do this, screw the four eye bolts (4) provided into the threads at the corners of the load plate mounting device and lift off the weighing platform with a crane, block and tackle or similar equipment and set it down at the installation location.

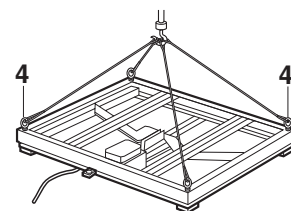

CAUTION

Danger of damage to the lever mechanism open at the bottom when using forklift trucks.

- Move up the load forks of the forklift truck and hang the weighing platform on them as described.

Setting up KE...skx/KES...skx

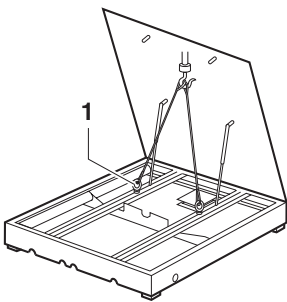

1. Open the two quick release locks with the special key and fold up the load plate (special key is used as a aid when lifting off).
2. Lift the weighing platform off the transport pallet. To do this, screw the two eye bolts (1) provided (they are located on the inside on the level indicator side) into the threads of the load frame and lift off the weighing platform with a crane, block and tackle or similar equipment and set it down at the installation location.
3. Remove the eye bolts.

CAUTION

Danger of damage to the lever mechanism open at the bottom when using forklift trucks.

- Move up the load forks of the forklift truck and hang the weighing platform on them as described.

Releasing the lift-off locks: KD...x/KE...x./KE...skx/KES...x/KES...skx

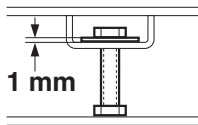
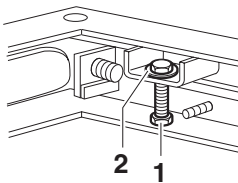

1. Loosen the nuts (1) at all four corners. Screw up the locking screws (2) and adjust evenly to approx. 1 mm clearance at all four corners.
2. Retighten the nuts (1).

Levelling KD...x/KE...x/KE...skx/KES...x/KES...skx

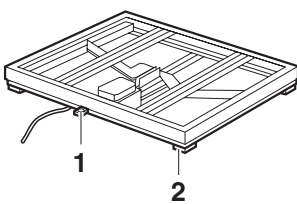

- Level the weighing platform with the 4 levelling feet (2) using the level indicator (1): The air bubble of the levelling indicator must be located within the ring marking.

The levelling feet can be adjusted with a 30 mm open-end spanner. Ensure even contact of the levelling feet.

2.2.3 Setting up and levelling KG...x

Setting up KG...x

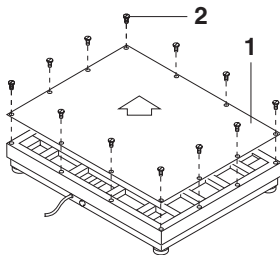

1. Lift off the load plate (1) after unscrewing the 12 screws (2).
Depending on the shipping warehouse or the model ordered, the load plate may also be included in separate packing. If this is the case, the mounting screws and the blind screws are supplied in the accessories bag.
2. Lift the weighing platform off the transport pallet. For this purpose, fasten a rope or chain to the load frame (3) and lift the weighing platform off the transport pallet with a crane, block and tackle or similar equipment, and set it down at the setup location.

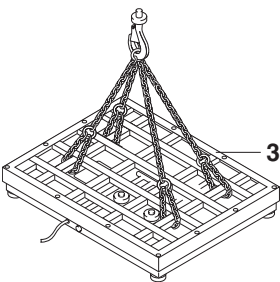

CAUTION

Danger of damage to the lever mechanism open at the bottom when using forklift trucks.

- Move up the load forks of the forklift truck and hang the weighing platform as described.

Loosening KG...x transport locks

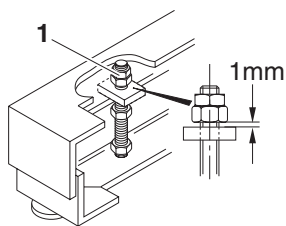

1. Unscrew the yellow load-frame fastening nuts (1) at all four corners. Adjust to 1 mm clearance by screwing upward and then lock.

2. Loosen both locked yellow locking nuts (2) and screw upward approx. 2 mm.

3. Unscrew the yellow locked locking nuts (3) at the stop.
First screw the lower one downward until the knife edge (4) at the lever rests in the suspended bearing.

Then set the upper and lower locking nuts (3) to approx. 1 mm clearance from the stop pin (5) and lock.

4. Set both locking nuts (2) to approx. 1 mm clearance and lock.

5. Perform final inspection: All levers must have 0.2 mm to 0.3 mm clearance in the axial direction. Readjust the stops if necessary.

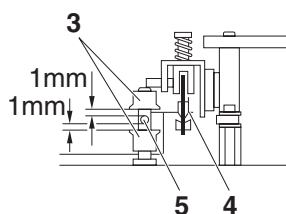
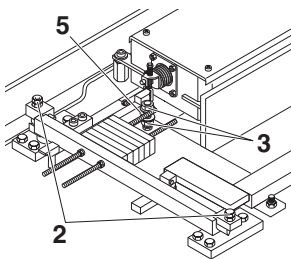

Levelling KG...x

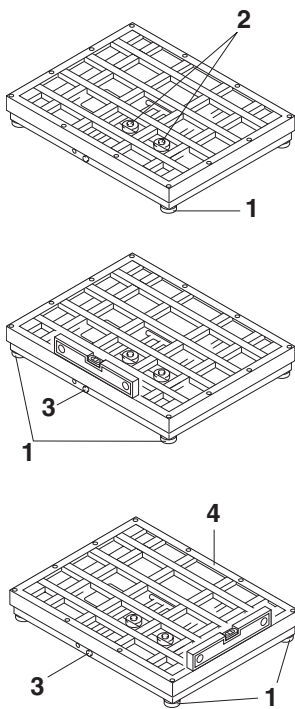

1. Evenly screw out the four foot bolts (1) at the corners approx. 3 turns.
2. Unscrew the inner support bolts (2) completely.
3. Place the bubble level on the long side with the level indicator, and level this side with the foot bolts (1) on the left and on the right.
4. Place the bubble level on both short sides alternately and level these sides with the other two foot bolts until the level indicator (3) and the bubble level match.
5. Perform final inspection: When the levelling is correct, the load frame (4) must rest snugly in the bases at all four corners. Ensure even contact of the foot bolts. Check the stability of the weighing platform by pressing down on it or rocking it at the corners.
6. Screw both support bolts (2) downward until they touch the surface, tighten with approx. 1/2 turn and lock.

2.2.4 Setting up and levelling KN...x

Setting up KN...x

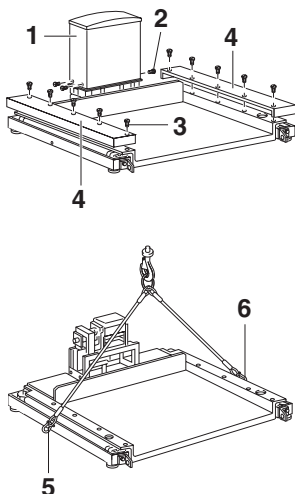

1. Unscrew the four screws (2) and remove the cover hood (1).
2. Remove the accessories.
3. Unscrew the screws (3) and remove both covering angled sections (4).
4. Lift the weighing platform off the transport pallet.
For this purpose, insert the two supplied eye bolts (6) through the holes (5) in the base frame and tighten with the nuts from inside.
Fasten ropes or chains to the eye bolts and lift up the weighing platform from the transport pallet with a crane, block and tackle or similar equipment and set it down at the setup location.

CAUTION

Danger of damage to the lever mechanism open at the bottom when using forklift trucks.

- Move up the load forks of the forklift truck and hang the weighing platform as described.

Loosening KN...x transport locks

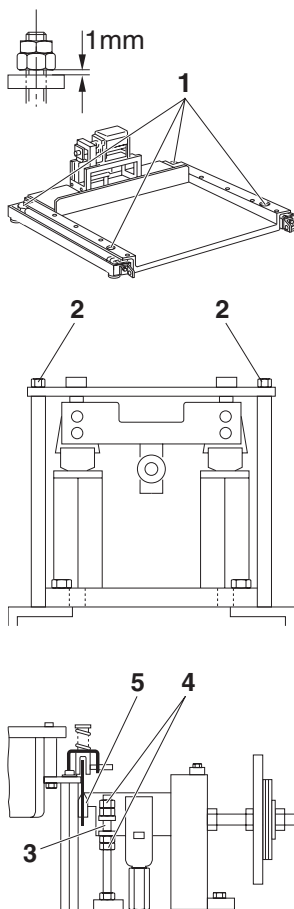

1. Unscrew the yellow load-frame fastening nuts (1) at all four corners.
2. Adjust to 1 mm clearance by screwing upward and then lock.
3. Completely remove both yellow locking bolts (2) in the cabinet. Keep these screws for use when transporting in the future.
4. Unscrew the yellow locking nuts (4) at the stop (3). First screw the lower one downward until the knife edge rests in the suspended bearing (5). Then set the upper and lower locking nuts to approx. 1 mm clearance from the stop pin and lock.

Levelling KN...x

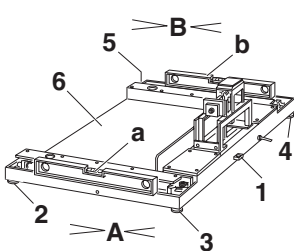

1. Evenly screw out the four foot bolts (2–5) at the corners approx. 3 turns.
2. Place the bubble level on the right-hand cheek of the load carrier (a) and level in direction A with foot bolts (2) and (3).
3. Level using the foot bolt (4) and the level indicator (1).
4. Place the bubble level on the left-hand cheek of the load carrier (b), and level with the foot bolt (5) in direction B.
5. Perform final inspection:
 - The levelling is correct when the air bubble of the level indicator (1) lies in the centre of the ring marking and the bubble level matches in directions A and B.
 - The load carrier (6) must rest snugly in the bases at all four corners. Press down or rock the corners for this. Make corrections at the front corners (foot bolts 2 and 5) if necessary.

Installing approach ramp KN...x

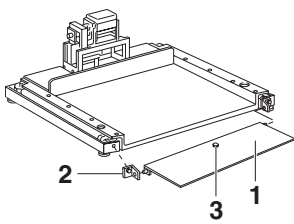

1. Screw off one of the two angle brackets (2).
2. Insert approach ramp (1) and screw on angle bracket again.
3. Screw support bolt (3) downward and tighten lightly.

Fastening KN...x to floor

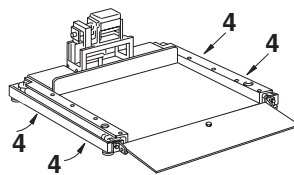

The KN...x weighing platform can be used free-standing. If it is to be used on a smooth floor, however, we recommend that you fasten it to the floor. The base frame has four holes (4) for this purpose.

- Drill dowel holes matching the holes in the base frame (4) and screw down the weighing platform with the supplied fastening hardware.

2.3 Installing connection cable

- Route the connection cable to the terminal so that it is protected from possible damage.

Extension of connection cable

- ▲ An extension of the connection cable is only permitted according to the guide for installers for the explosion-protected weighing system.



2.3.1 KC...x/KCS...x

The connection cable is stored inside the weighing platform during transport for protection.

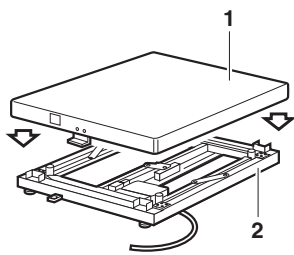

1. Route out the connection cable under the base frame.
2. Remount the load carrier (1) so that the symbol 0 is located above the level indicator. Make sure that the load supports (2) in the corners of the weighing platform are vertical.
3. Fold out the lift-off locks (3) on both faces of the load carrier for lifting. The lift-off locks are used both to lift off the load carrier (Pos. A) and to prevent lifting off and tilting (Pos. B) during weighing.

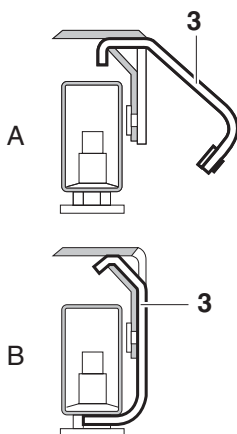

2.3.2 KD...x/KE...x/KE...skx/KES...x/KES...skx

The connection cable (1) is stored inside the weighing platform during transport for protection. Depending on the conditions at the installation location, the connection cable can be routed out as follows:

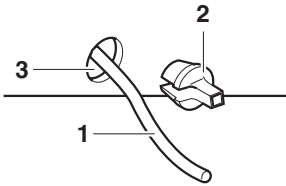

- Below the weighing platform on the floor:
Ideal with the recessing installation of the weighing platform. In the case of above-floor installation protective cable bridges can be laid up to under the weighing platform.
- Through the base frame:
Remove the rubber grommet (2) from the hole (3) in the base frame and pull through the connection cable (1). Push the slotted rubber grommet (2) over the cable and insert it in the hole (3).

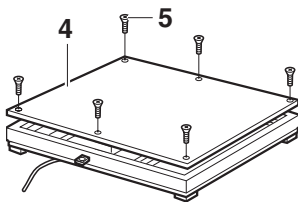

1. Lay on the load plate (4) (fold down) and mount it with the screws (5) (quick-release locks).
2. Screw the blind screws into the threads.

2.3.3 KG...x

The connection cable is stored inside the weighing platform during transport for protection.

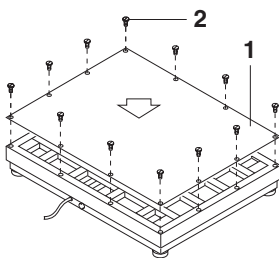

1. At the setup location, route out the cable below the weighing platform on the floor. In the case of above-floor installation, protective cable bridges can be laid up to just under the weighing platform.
2. Place the load plate (1) on the load frame and fasten with the screws (2).

2.3.4 KN...x

The connection cable (1) is stored inside the cabinet during transport for protection. Depending on the conditions at the setup location, the connection cable can be routed out as follows:

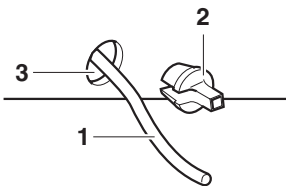

- Below the weighing platform on the floor:
Ideal if cover strips have been provided as cable bridges. These can then be laid below the weighing platform.
- Through the base frame:
Remove the rubber grommet (2) from the hole (3) in the base frame and pull the connection cable (1) through. Push the slotted rubber grommet (2) over the cable and insert it in the hole (3).

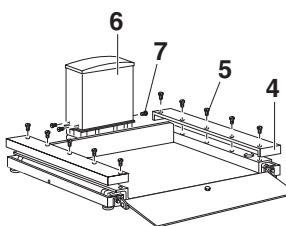

1. Remove the eye bolts and screw on both covering angle sections (4) with the screws (5).
2. Mount the cover hood (6) and fasten with the screws (7).

2.4 Pit installation

2.4.1 Producing pit

The mounting material and detailed instructions for constructing the pit are included with the pit-frame installation kit. The proper construction of the pit according to these instructions is a requirement.

2.4.2 Installing the KC...x/KCS...x weighing platform

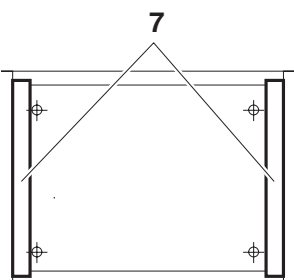
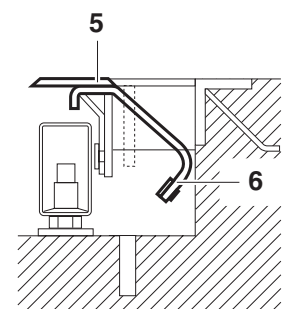
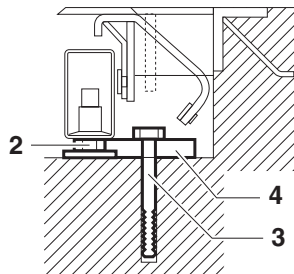
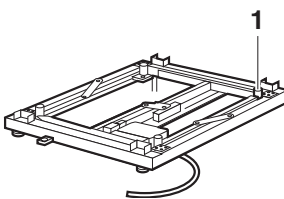
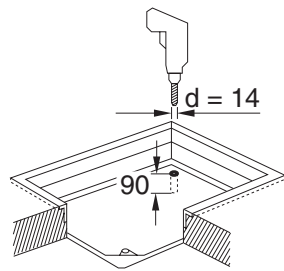

1. Lay the drawing provided in the pit as a drilling template. Centre the template in all directions and secure with adhesive tape. Drill the four holes at the points marked and insert the plugs.
2. Measure the pit depth at the corners.
3. Roughly adjust the weighing platform to the height of or flushness with the floor outside the pit using the foot bolts.
4. Lift off the load carrier, see Section 2.2.1.
5. Place the weighing platform in the pit and align. When doing so, also pull the cable into the empty pipe or cable conduit. For details on routing the empty pipe to the terminal, see the instructions on pit construction.
6. Adjust flushness to the floor. To do this, lay a 6 mm spacer on the load supports (1) and check with a ruler from the upper edge of the pit frame. Adjust the height with the foot bolts while ensuring even contact of the support feet, see Section 2.2.1.
7. Mount the weighing platform on the pit floor on the four foot bolts (2) with the screws (3) and lugs (4). Before tightening, check the distance to the pit edge.
8. Release the transport locks, see Section 2.2.1.
9. Fit the load carrier (5). The swivelled-out lifting and tilting locks (6) on both faces of the weighing platform serve as lifting aids.
10. Lay the left and right cover strips (7) in the pit frame.
11. Final inspection: Make sure that the distance between the load carrier and the pit frame is equal on all sides.

2.4.3 Installing weighing platform KD...x/KE...x/KE...skx/KES...x/KES...skx

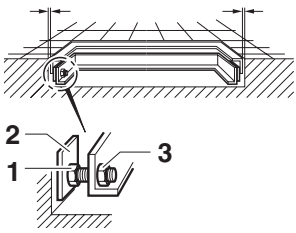
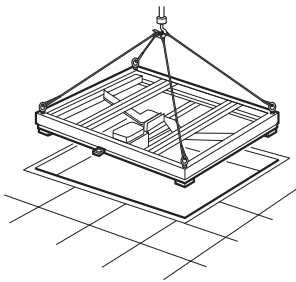

1. Lift off the load plate and route out the connection cable under the weighing platform, see Section 2.2.2.
2. Slowly lower the weighing platform into the pit by the eye bolts. When doing so, also pull the cable into the empty pipe or cable conduit.
3. Release the lift-off lock, see Section 2.2.2.
4. Adjust flushness to the floor.
To do this, lay spacers (KD...x/KE...x: 8 mm, KE...skx: 6 mm) on the load frame at the corners and adjust flush with the upper edge of the pit frame. Adjust the height of the support feet. To level, see section 2.2.2.
5. Level out, see Section 2.2.2.
6. Insert the clamping plates (2) provided in the installation kit between the pit wall and the clamping screw (1) so that they stand up on the pit floor. Centre the weighing platform in the pit with 6 or 8 clamping screws (1) and clamp firmly in place. Lock the bolts (1) on the inside of the base frame with the nuts (3).
7. Lay on the load plate and screw on firmly.

2.4.4 Installing KG...x weighing platform

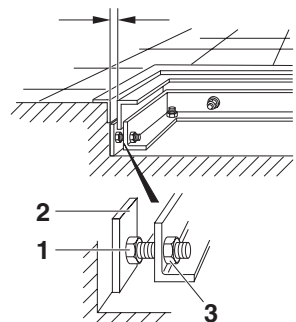
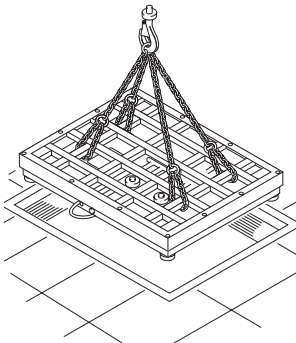

1. Measure the pit depth at the corners.
2. Roughly adjust the weighing platform flush with the floor outside the pit using the foot bolts.
3. Remove the load plate and route out the connection cable under the weighing platform.
4. Slowly lower the weighing platform into the pit. When doing so, pull the cable into the empty pipe or cable conduit.
5. Release transport locks.
6. Adjust flushness to the floor.
For this purpose, place 6 mm spacers on the load carrier at the corners, and check with a ruler from the upper edge of the base frame. Adjust the height with the foot bolts while ensuring even contact of the support feet.
7. Level out, see section 2.2.3.
8. Insert clamping plates (2) between the pit wall and the clamping bolt (1) so that they stand up on the pit floor.
9. Clamp the weighing platform in the pit with eight clamping bolts (1) and centre it at the same time.
10. Lock the clamping bolts (1) on the inside of the base frame with the nuts (3).

3 Configuration possibilities

3.1 General information

3.1.1 MultiInterval

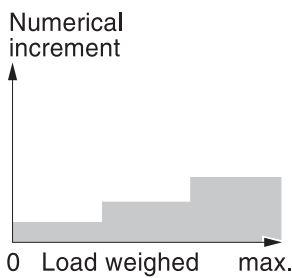

- MultiInterval precision means automatic switchover of the numerical increment (readability) in dependence on the applied load.

3.1.2 Single Range and High Resolution

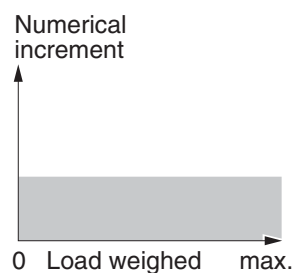

- Single Range and High Resolution mean that the numerical increments (readability) remain the same across the entire weighing range.

3.1.3 Additional setting options

- All other adjustment variables (adjustment to the weighing process and vibrations, as well as adjustment of stability monitoring and the zero point correction) are adjusted to the usual user conditions, however can be changed in the master mode of the weighing terminal if necessary.
- The Identcard provided is labelled with the standard configuration. Mount the Identcard in accordance with the installation instructions of the weighing terminal concerned.
- If the standard configuration does not meet your needs, it is possible to reconfigure the weighing platform with the terminal. To do this, see the terminal operating instructions or the Service Manual for the TBrick Service Mode.
- A set of measuring data signs is provided with the weighing platform. Apply the selected configuration corresponding to the factory-mounted measuring data sign to the Identcard, and the Max-Min sign near the terminal display.
- When the configuration is changed, it is also possible to change the preload range in addition to the weighing range and the readability.

3.2 Configuration data

3.2.1 Configuration data for KC...x/KCS...x, factory setting

Standard configuration	KC300..x	KCS300..x	KC600..x/KCS600..x
Maximum load	300 kg	300 kg	600 kg
Readability	0 ... 300 kg 0.002 kg	0 ... 300 kg 0.002 kg	0 ... 600 kg 0.01 kg
Tare range, subtractive	300 kg	300 kg	600 kg
Preload range Zero-set range Zero-set range (typ.)	± 6 kg 105 kg	± 6 kg 120 kg	± 12 kg 255 kg
Calibration data as per OIML Calibration class Calibration value Minimum load Temperature range	III 0.05 kg 1.0 kg -10 °C ... +40 °C	III 0.05 kg 1.0 kg -10 °C ... +40 °C	II 0.1 kg 0.5 kg 0 °C ... +40 °C

3.2.2 Configuration data for KD...x/KE...x/KE...skx/KES...x/KES...skx, factory setting

Standard configuration	KD600..x	KD1500..x	KE1500..x
Maximum load	600 kg	1500 kg	1500 kg
Readability	0 ... 600 kg 0.01 kg	0 ... 1500 kg 0.02 kg	0 ... 1500 kg 0.02 kg
Tare range, subtractive	600 kg	1500 kg	1500 kg
Preload range Zero-set range Zero-set range (typ.)	± 12 kg 200 kg	± 30 kg 640 kg	± 30 kg 600 kg
Calibration data as per OIML Calibration class Calibration value Minimum load Temperature range	III 0.1 kg 2 kg -10 °C ... +40 °C	III 0.2 kg 4 kg -10 °C ... +40 °C	III 0.2 kg 4 kg -10 °C ... +40 °C

Standard configuration	KES1500..x	KE3000..x	KES3000..x
Maximum load	1500 kg	3000 kg	3000 kg
Readability	0 ... 1500 kg 0.02 kg	0 ... 3000 kg 0.05 kg	0 ... 3000 kg 0.05 kg
Tare range, subtractive	1500 kg	3000 kg	3000 kg
Preload range Zero-set range Zero-set range (typ.)	± 30 kg 600 kg	± 60 kg 1270 kg	± 60 kg 1270 kg
Calibration data as per OIML Calibration class Calibration value Minimum load Temperature range	III 0.2 kg 4 kg -10 °C ... +40 °C	III 0.5 kg 10 kg -10 °C ... +40 °C	III 0.5 kg 10 kg -10 °C ... +40 °C

3.2.3 Configuration data for KG...x/KN...x, factory setting

Standard configuration	KG3000..x	KG6000..x	KN1500..x
Maximum load	3000 kg	6000 kg	1500 kg
Readability	0 ... 600 kg 0.2 kg 600 ... 1500 kg 0.5 kg 1500 ... 3000 kg 1.0 kg	0 ... 1500 kg 0.5 kg 1500 ... 3000 kg 1.0 kg 3000 ... 6000 kg 2.0 kg	0 ... 300 kg 0.1 kg 300 ... 600 kg 0.2 kg 600 ... 1500 kg 0.5 kg
Tare range, subtractive	3000 kg	6000 kg	1500 kg
Preload range Zero-set range Zero-set range (typ.)	± 60 kg 1270 kg	± 120 kg 2550 kg	± 30 kg 630 kg
Calibration data as per OIML Calibration class Calibration value Minimum load Temperature range	III 0.2 kg 4.0 kg -10 °C ... +40 °C	III 0.5 kg 10 kg -10 °C ... +40 °C	III 0.1 kg 2 kg -10 °C ... +40 °C

4 Planning assemblies

4.1 Notes on planning

Due to their design characteristics, the weighing platforms are suitable for installation in conveying systems. The following specifications and dimensional drawings form the basis for the design of the required assemblies.

- The weighing platform may only be supported by the support feet, and never by the frame or lever parts.
- The weighing platform may only be permanently installed on the support feet.
- Moving or rotating parts on the weighing platform must be designed so that they do not affect the weighing result. Balance rotating parts.
- The load plate must be free on all sides so that not connection between the load plate and permanently mounted parts is made, even by falling parts or dirt deposits.
- Lay cables or hoses between the weighing platform and other machine parts so that they do not exert any force on the weighing platform.

EXPLOSION RISK

The assemblies are also part of the explosion-protected weighing system.



- Use only assemblies which are suitable for the application in hazardous areas.
- Make sure that there is no increased risk due to electrostatic charge of the assemblies.

CAUTION

When mounting assemblies, make sure that no metal chips get into the weighing platform.

- Remove the load plate to machine the weighing platform.

4.2 Preload range

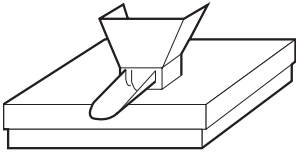

The weight of the structural parts permanently mounted on the weighing platform is referred to as "preload". The preload is electrically compensated in the weighing platform so that the full weighing range is available.

The maximum preload (or the zero-set range) that can be compensated is dependent on the configured weighing range.

CAUTION

The assemblies must already be mounted when connecting the weighing platform.

Model	Weighing range	Max. preload
KC300..x	300 kg	105 kg
KCS300..x	300 kg	120 kg
KC600..x	600 kg	255 kg
KCS600..x	600 kg	255 kg
KD600..x	600 kg	200 kg
KD1500..x	1500 kg	640 kg
KE1500..x	1500 kg	600 kg
KES1500..x	1500 kg	600 kg
KE3000..x	3000 kg	1270 kg
KES3000..x	3000 kg	1270 kg
KG3000..x	3000 kg	1270 kg
KG6000..x	6000 kg	2550 kg
KN1500..x	1500 kg	630 kg

4.3 Mounting possibilities

4.3.1 Mounting possibilities for KC...x

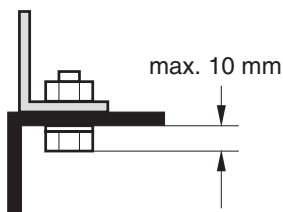
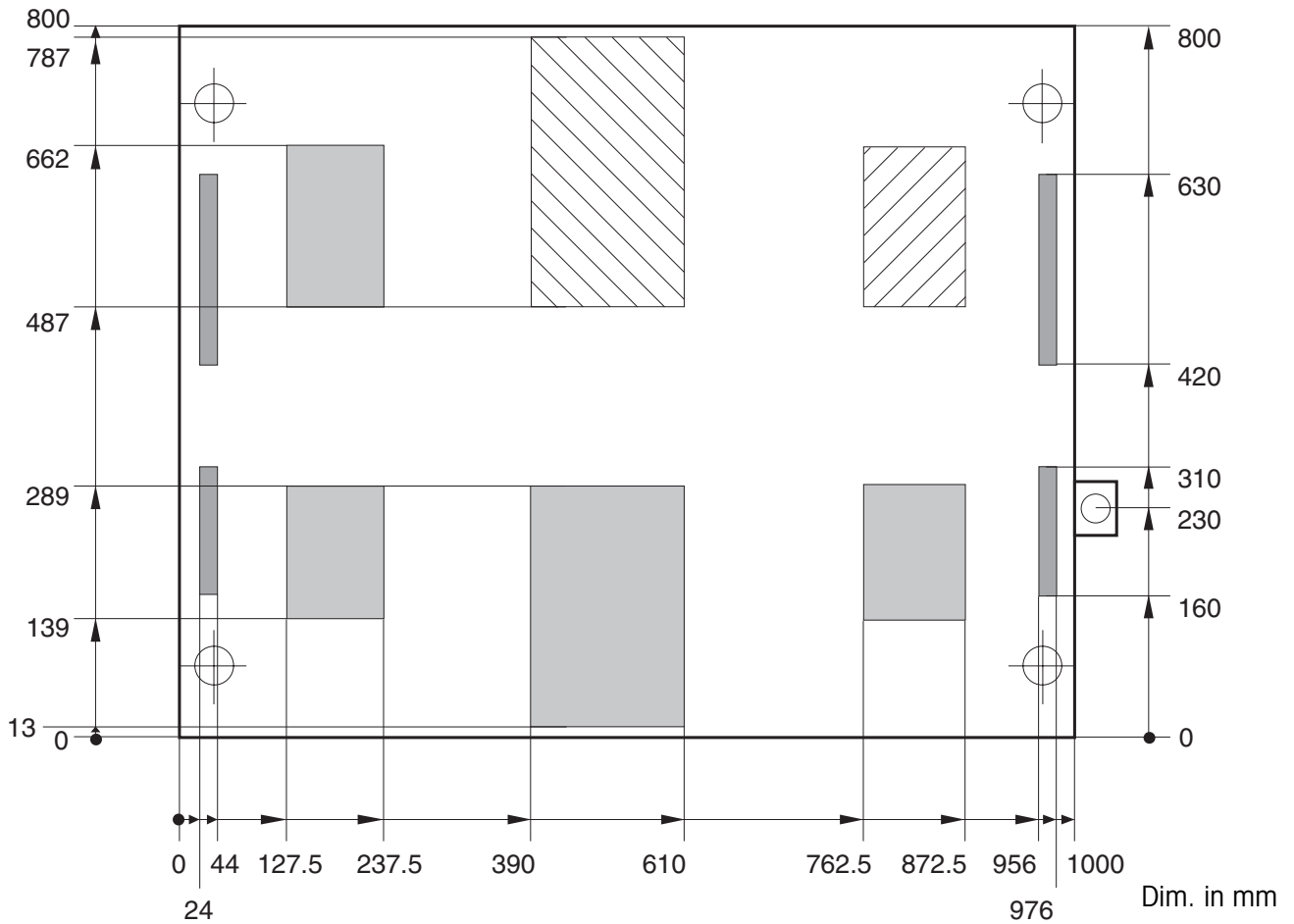

- Bridge assemblies can be mounted in the shaded or hatched areas.
- Recommended mounting type: Bolting on.
Remove the load plate and drill through for this purpose.
- Mounting parts (e.g. bolts and nuts) may extend a maximum of 10 mm beyond the underside of the load plate.



Only for KC300..x



Only for KC600..x





For KC300..x and KC600..x

Technical version: 08/2000

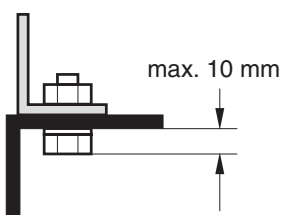
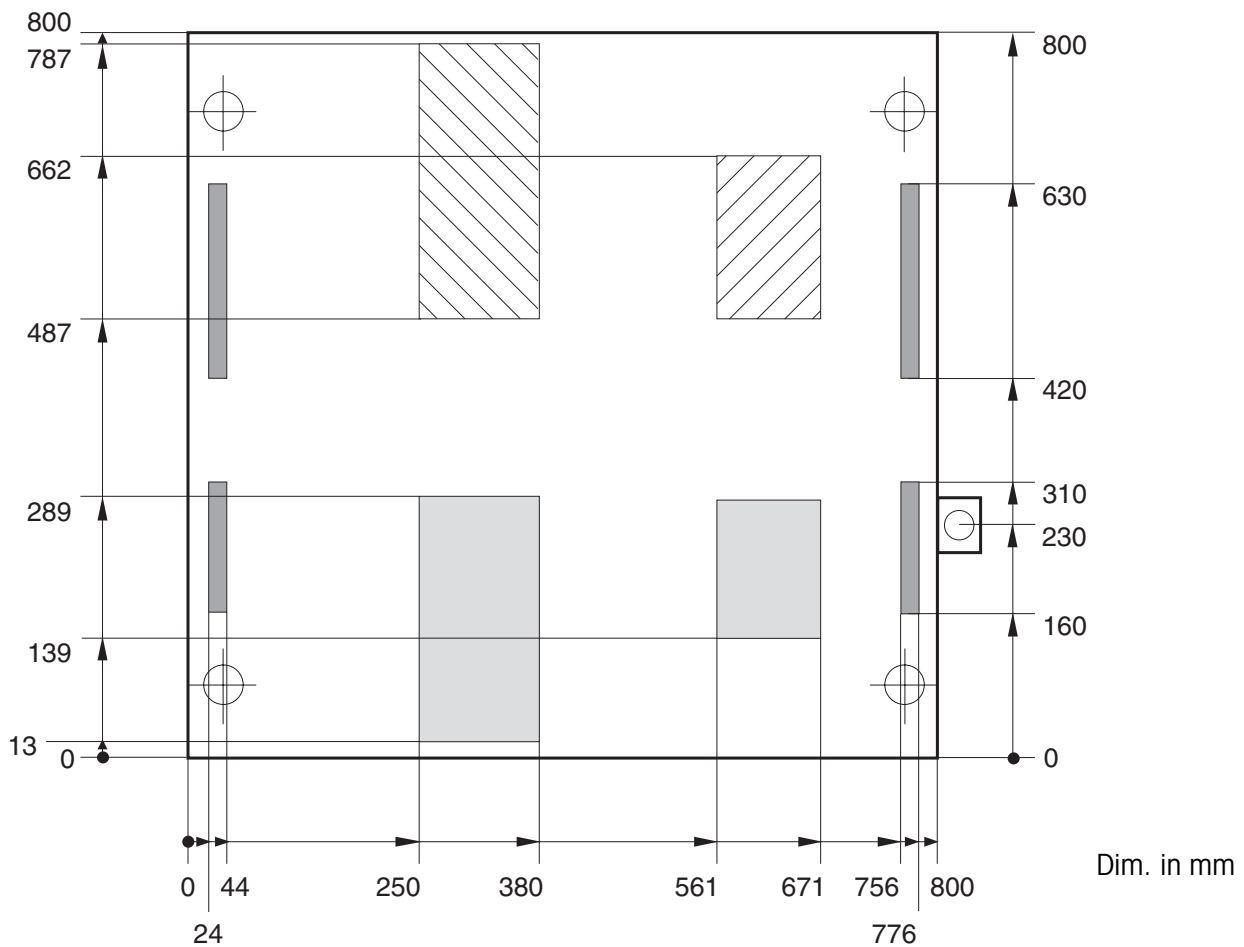
4.3.2 Mounting possibilities for KCS...x



- Bridge assemblies can be mounted in the shaded areas.
- Recommended mounting type: Bolting on.
Remove the load plate and drill through for this purpose.
- Mounting parts (e.g. bolts and nuts) may extend a maximum of 10 mm beyond the underside of the load plate.

-  Only for KCS300..x
-  Only for KCS600..x
-  For KCS300..x and KCS600..x

Technical version: 08/2000

4.3.3 Mounting possibilities for KD...x

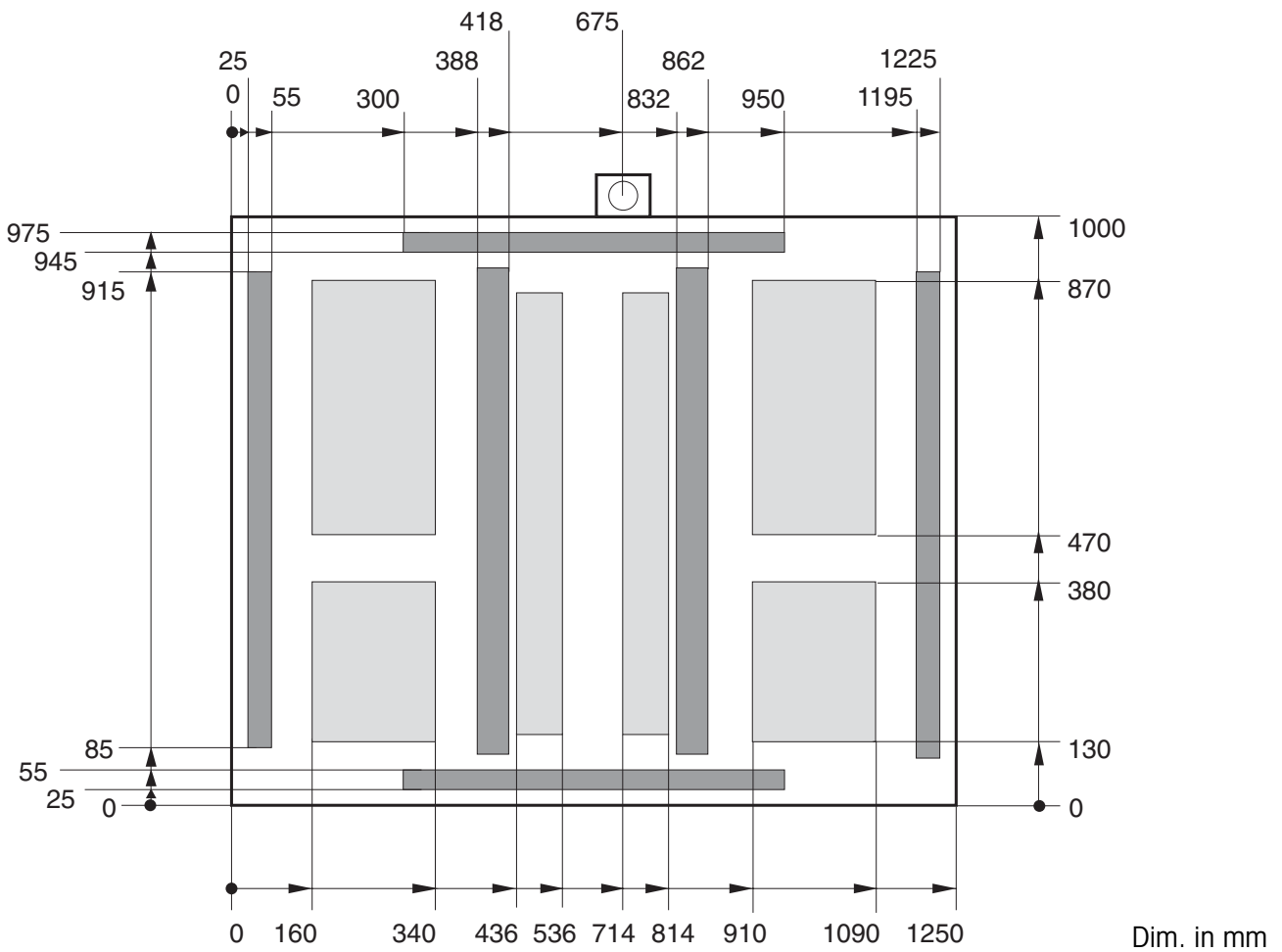

Dim. in mm

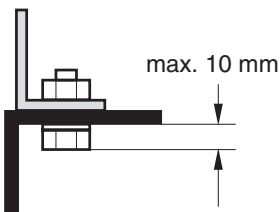

- Bridge assemblies can be mounted in the shaded areas.
- Recommended mounting type: Bolting on.
Remove the load plate and drill through for this purpose.
- Mounting parts (e.g. bolts and nuts) may extend a maximum of 10 mm beyond the underside of the load plate or load frame.



Mounting possibilities on the load plate



Mounting possibilities on the load frame

Technical version: 08/2000

4.3.4 Mounting possibilities for KE...x

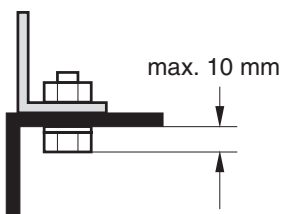
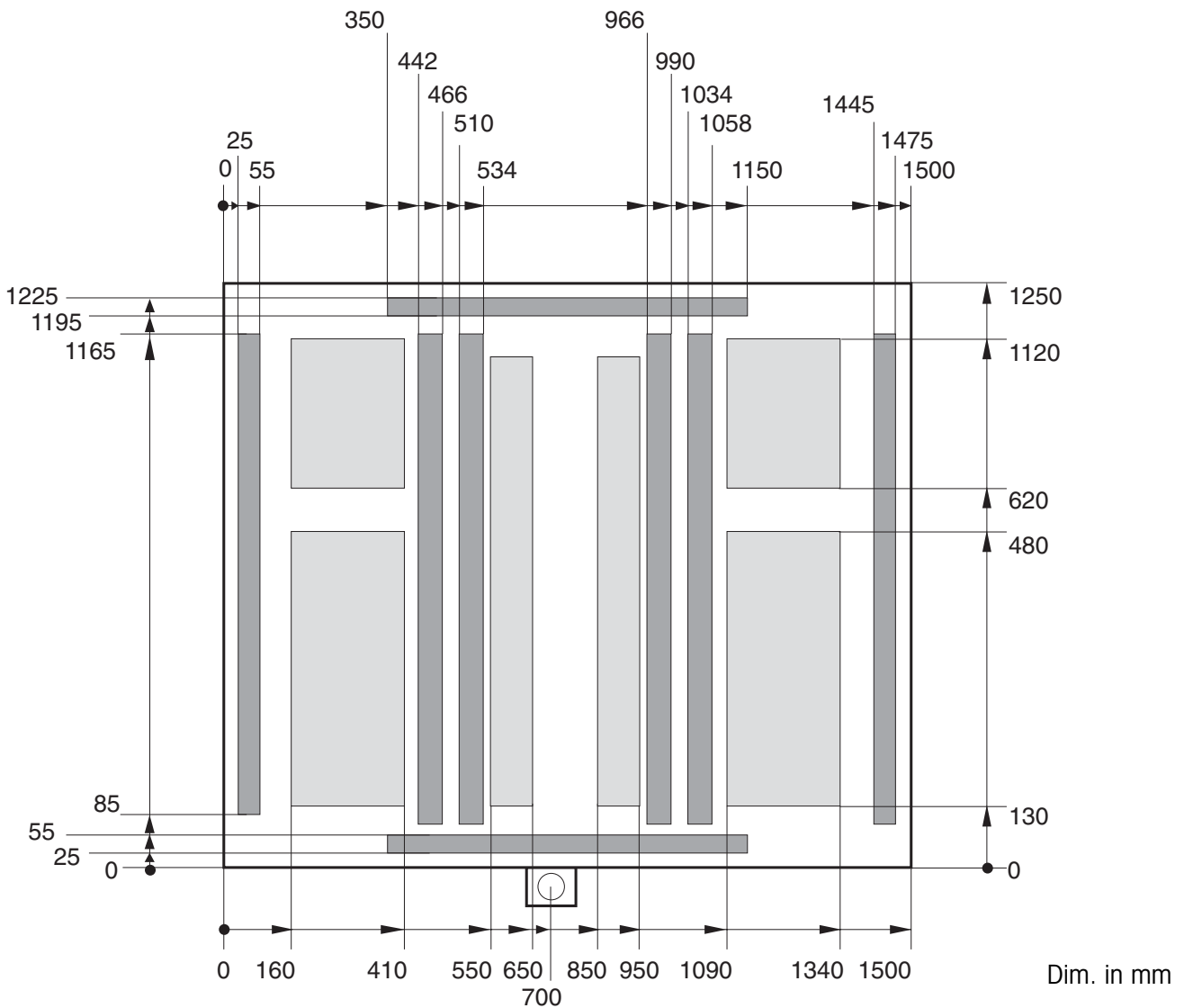

- Bridge assemblies can be mounted in the shaded areas.
- Recommended mounting type: Bolting on.
Remove the load plate and drill through for this purpose.
- Mounting parts (e.g. bolts and nuts) may extend a maximum of 10 mm beyond the underside of the load plate or load frame.



Mounting possibilities on the load plate



Mounting possibilities on the load frame

Technical version: 08/2000

4.3.5 Mounting possibilities for KE...skx

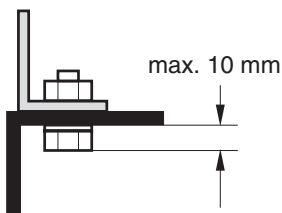
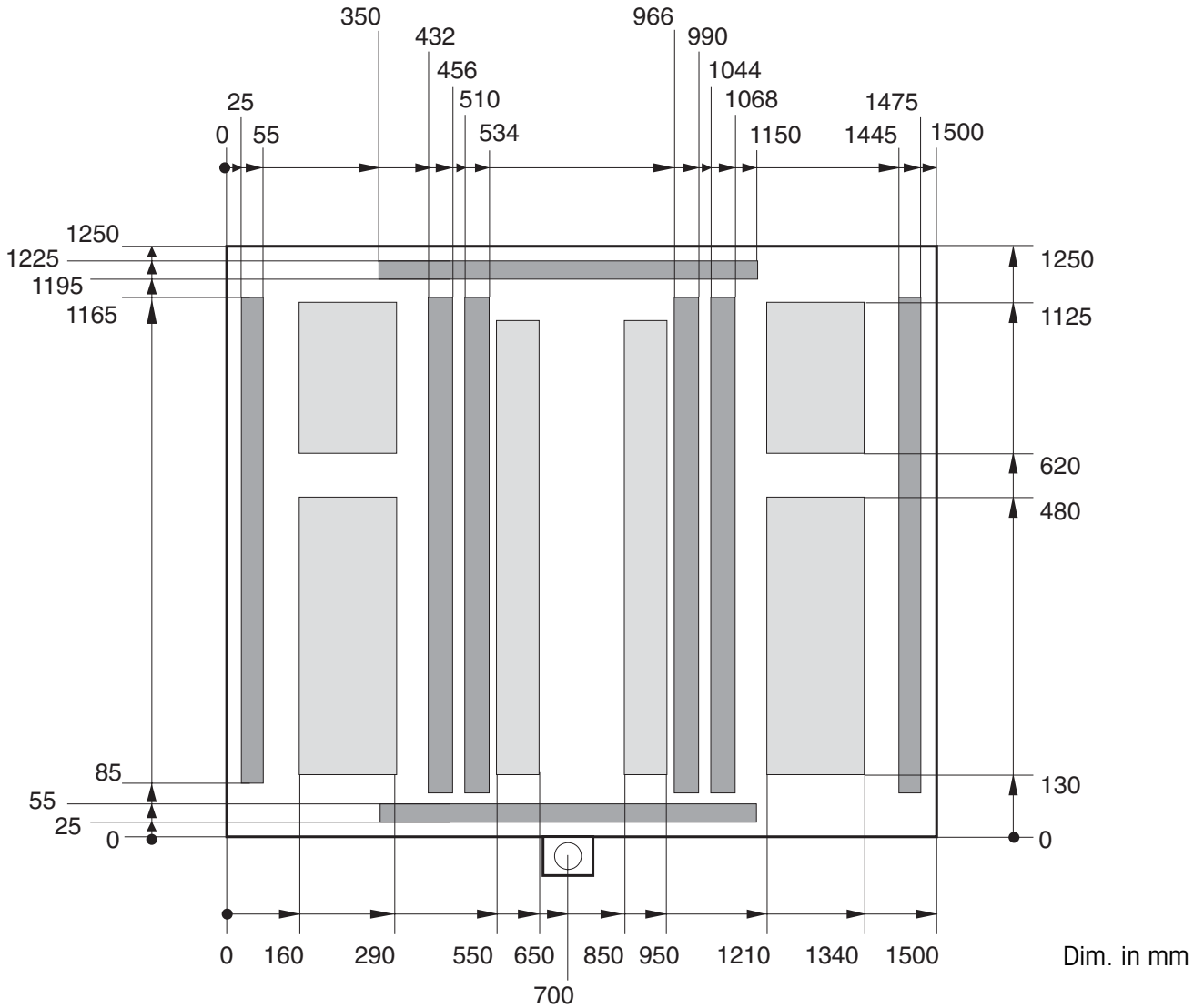

- Bridge assemblies can be mounted in the shaded areas.
- Recommended mounting type: Bolting on.
Remove the load plate and drill through for this purpose.
- Mounting parts (e.g. bolts and nuts) may extend a maximum of 10 mm beyond the underside of the load plate or load frame.



Mounting possibilities on the load plate



Mounting possibilities on the load frame

Technical version: 08/2000

4.3.6 Mounting possibilities for KES...x/KES...skx

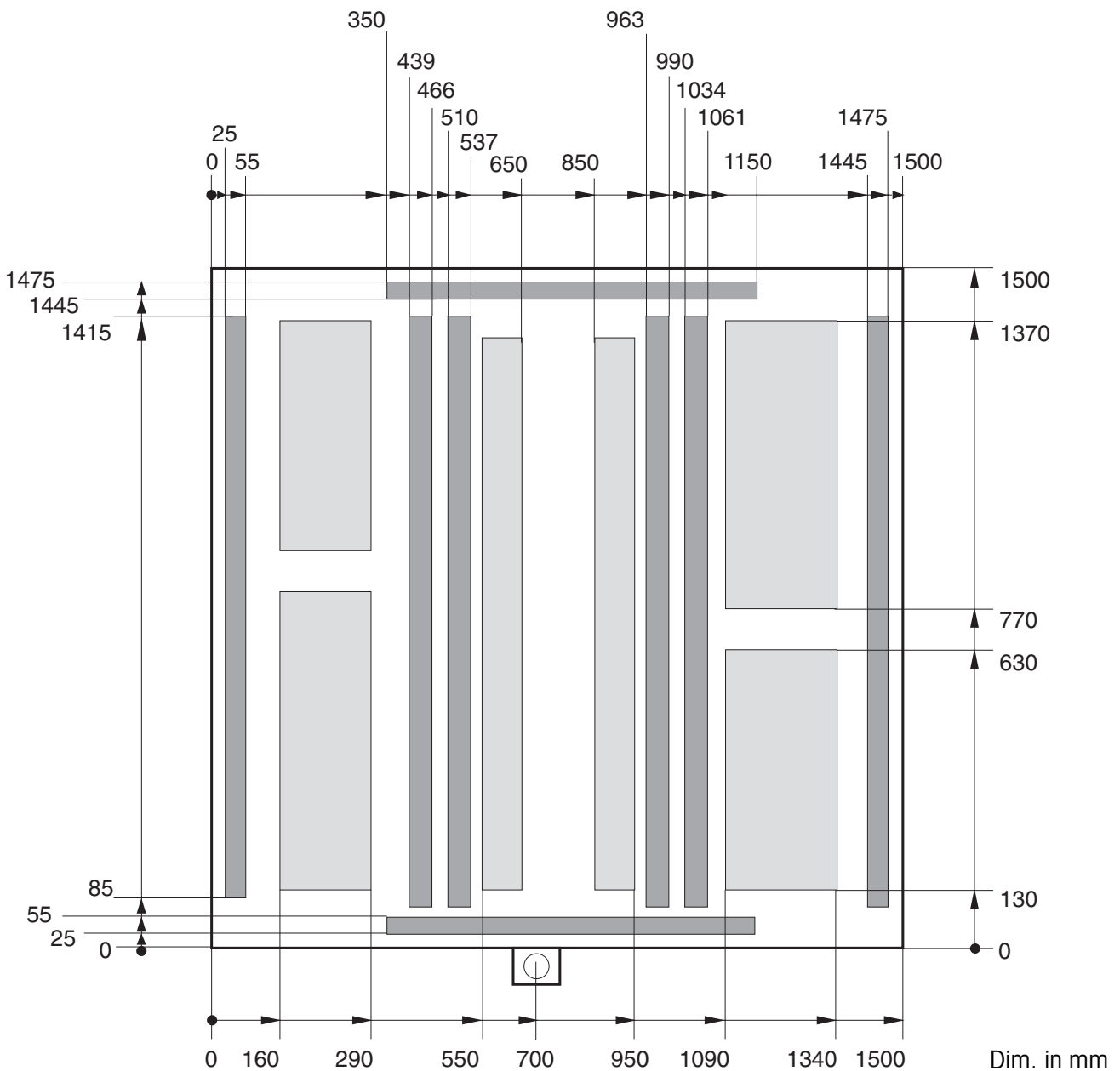

- Bridge assemblies can be mounted in the shaded areas.
- Recommended mounting type: Bolting on.
Remove the load plate and drill through for this purpose.
- Mounting parts (e.g. bolts and nuts) may extend a maximum of 10 mm beyond the underside of the load plate or load frame.

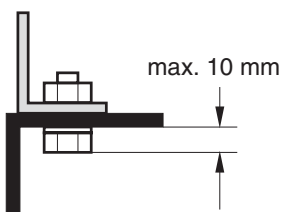

- Mounting possibilities on the load plate
- Mounting possibilities on the load frame

Technical version: 08/2000

4.3.7 Mounting possibilities for KG...x

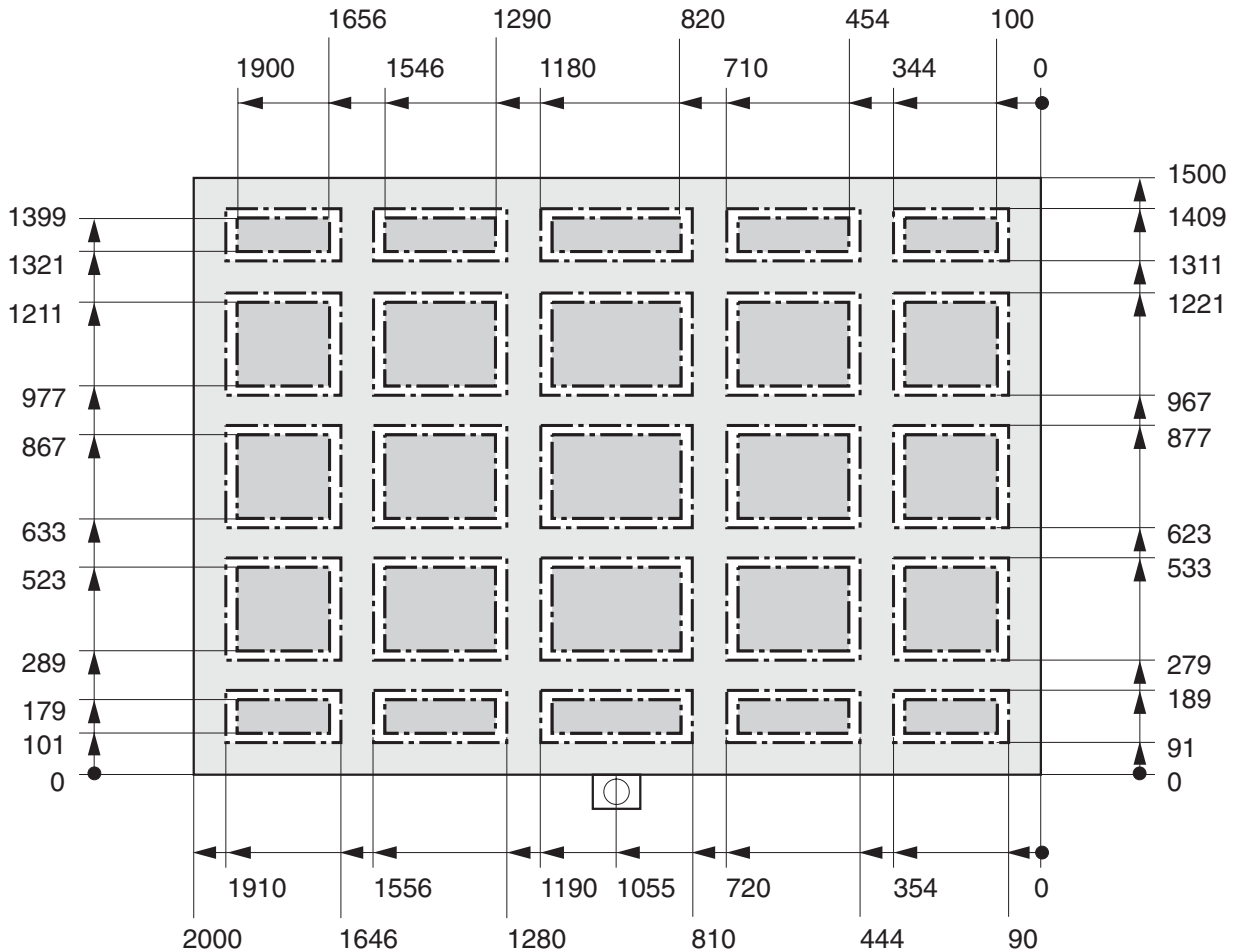

Dim. in mm

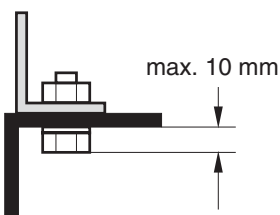

- Bridge assemblies can be mounted in the shaded areas.
- Recommended mounting type: Bolting on.
Remove the load plate and drill through for this purpose.
- Mounting parts (e.g. bolts and nuts) may extend a maximum of 10 mm beyond the underside of the load plate or load frame.



Mounting possibilities on the load plate



Mounting possibilities on the load frame

Technical version: 08/2000

4.4 Opening possibilities

4.4.1 Opening possibilities for KC...x

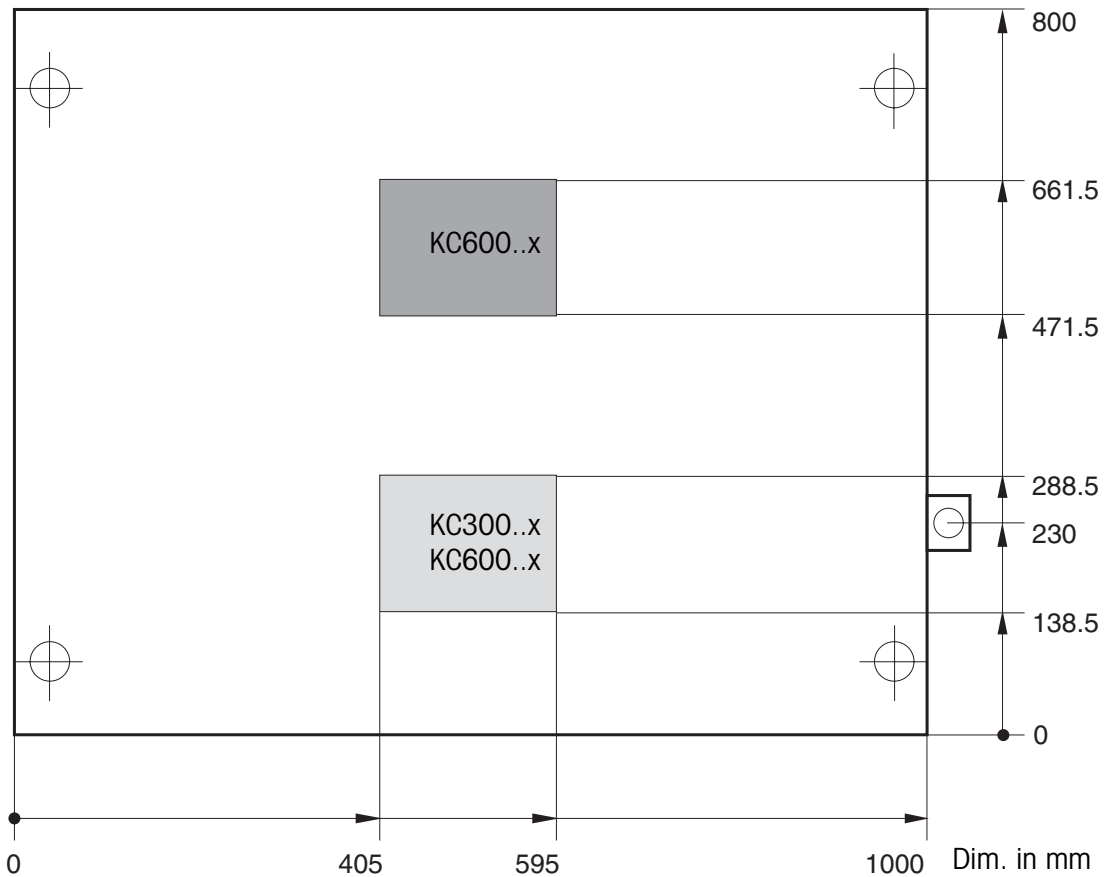

- Openings, e.g. for emptying tank, can be made in the shaded areas.
- The measuring cell TBrick ...-Ex has an individual terminal box which is mounted nearby the measuring cell. If required, the terminal box can be removed and reinstalled in a suitable place.
- Remove the load plate to produce the opening.

Technical version: 08/2000

4.4.2 Opening possibilities for KCS...x

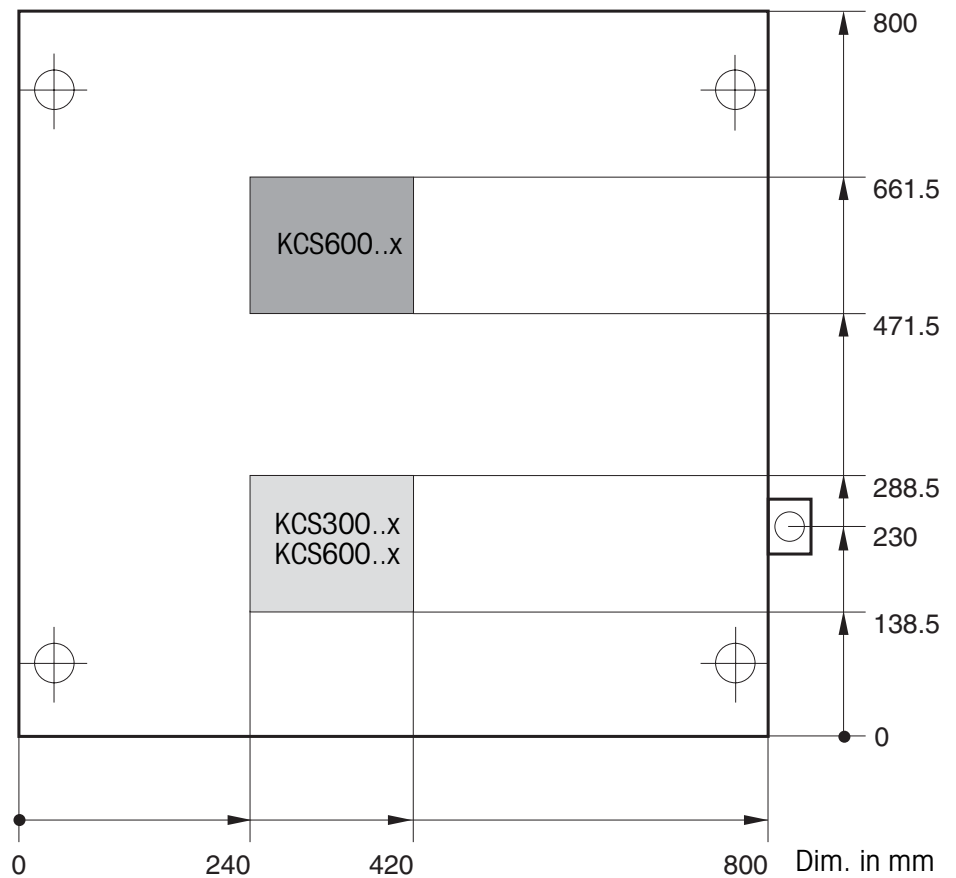

- Openings, e.g. for emptying tank, can be made in the shaded areas.
- The measuring cell TBrick ...-Ex has an individual terminal box which is mounted nearby the measuring cell. If required, the terminal box can be removed and reinstalled in a suitable place.
- Remove the load plate to produce the opening.

Technical version: 08/2000

4.4.3 Opening possibilities for KD...x

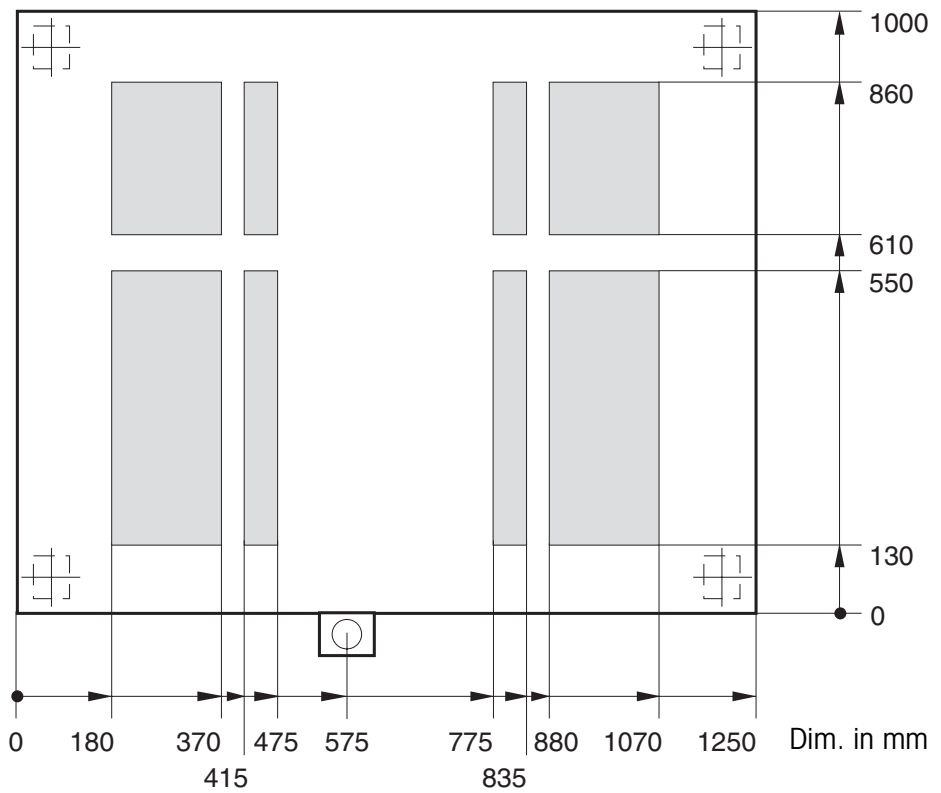

- Openings, e.g. for emptying tank, can be made in the shaded areas.
- The measuring cell TBrick ...-Ex has an individual terminal box which is mounted nearby the measuring cell. If required, the terminal box can be removed and reinstalled in a suitable place.
- Remove the load plate to produce the opening.

Technical version: 08/2000

4.4.4 Opening possibilities for KE...x/KE...skx

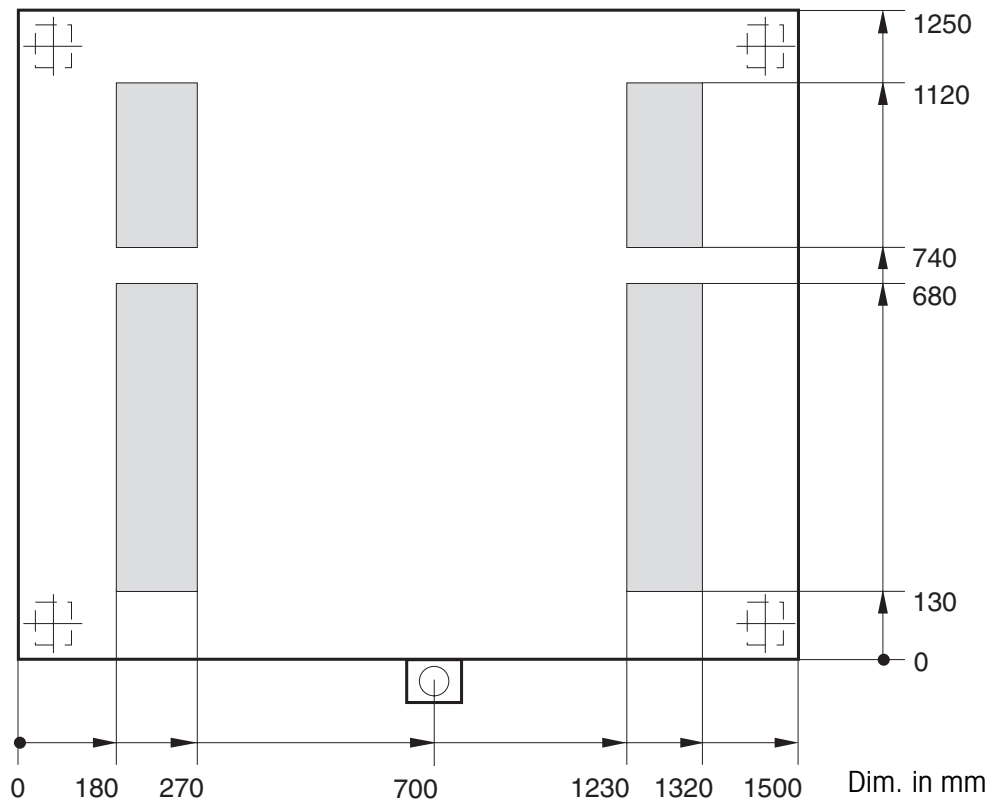

- Openings, e.g. for emptying tank, can be made in the shaded areas.
- The measuring cell TBrick ...-Ex has an individual terminal box which is mounted nearby the measuring cell. If required, the terminal box can be removed and reinstalled in a suitable place.
- Remove the load plate to produce the opening.

Technical version: 08/2000

4.4.5 Opening possibilities for KES...x/KES...skx

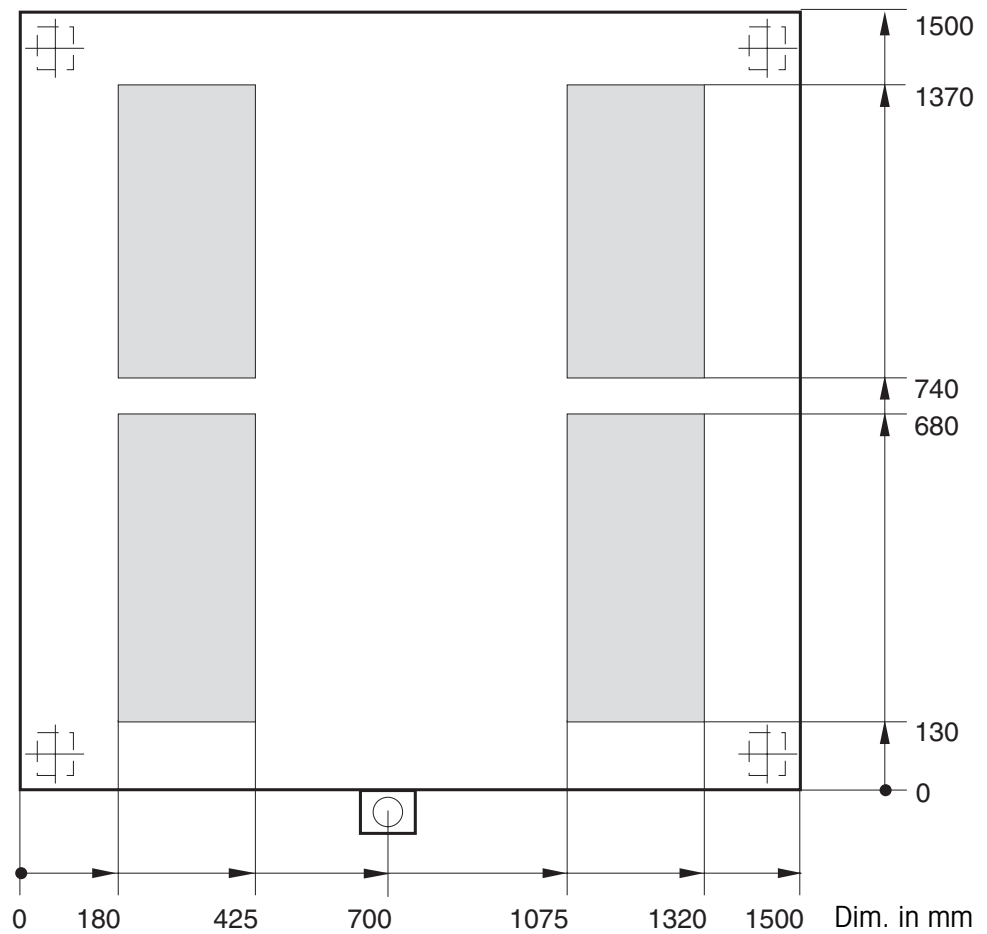

- Openings, e.g. for emptying tank, can be made in the shaded areas.
- The measuring cell TBrick ...-Ex has an individual terminal box which is mounted nearby the measuring cell. If required, the terminal box can be removed and reinstalled in a suitable place.
- Remove the load plate to produce the opening.

Technical version: 08/2000

4.4.6 Opening possibilities for KG...x

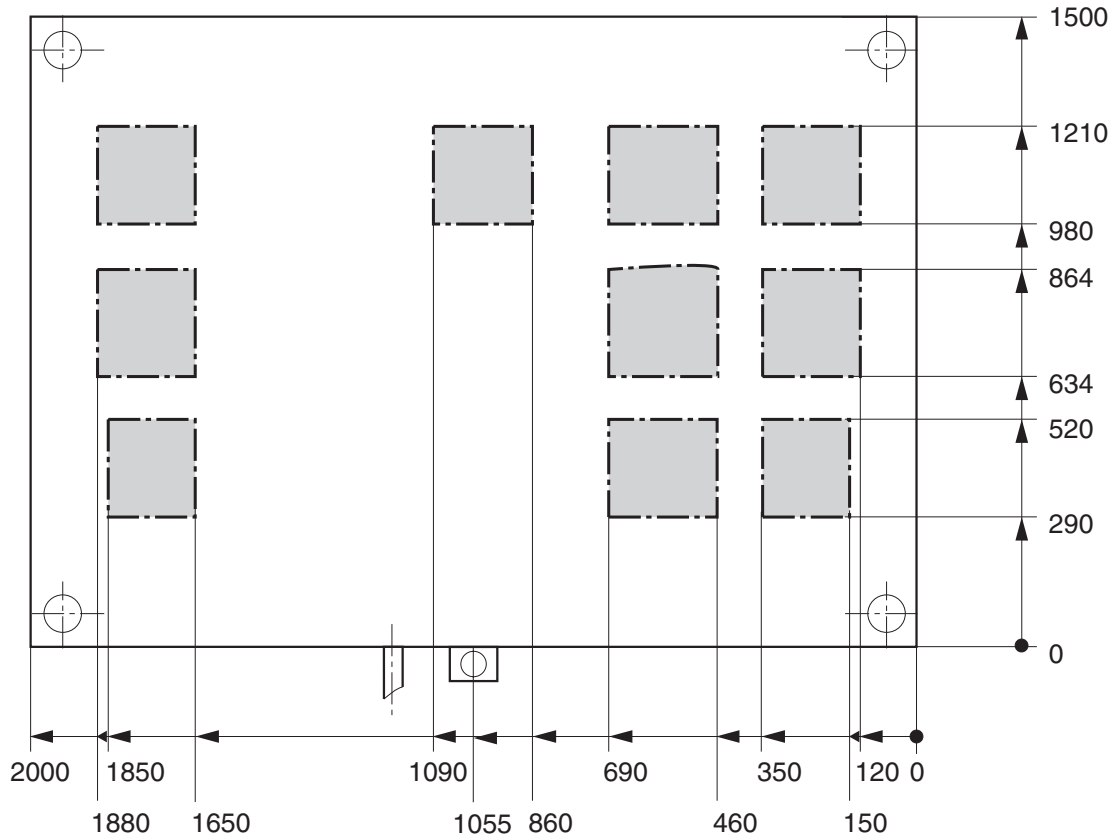

Dim. in mm

- Openings, e.g. for emptying tank, can be made in the shaded areas.
- The measuring cell TBrick ...-Ex has an individual terminal box which is mounted nearby the measuring cell. If required, the terminal box can be removed and reinstalled in a suitable place. Remove the load plate to produce the opening.
- Remove the load plate to produce the opening.

Technical version: 08/2000

5 Dimensions

Dimensions of KC...x

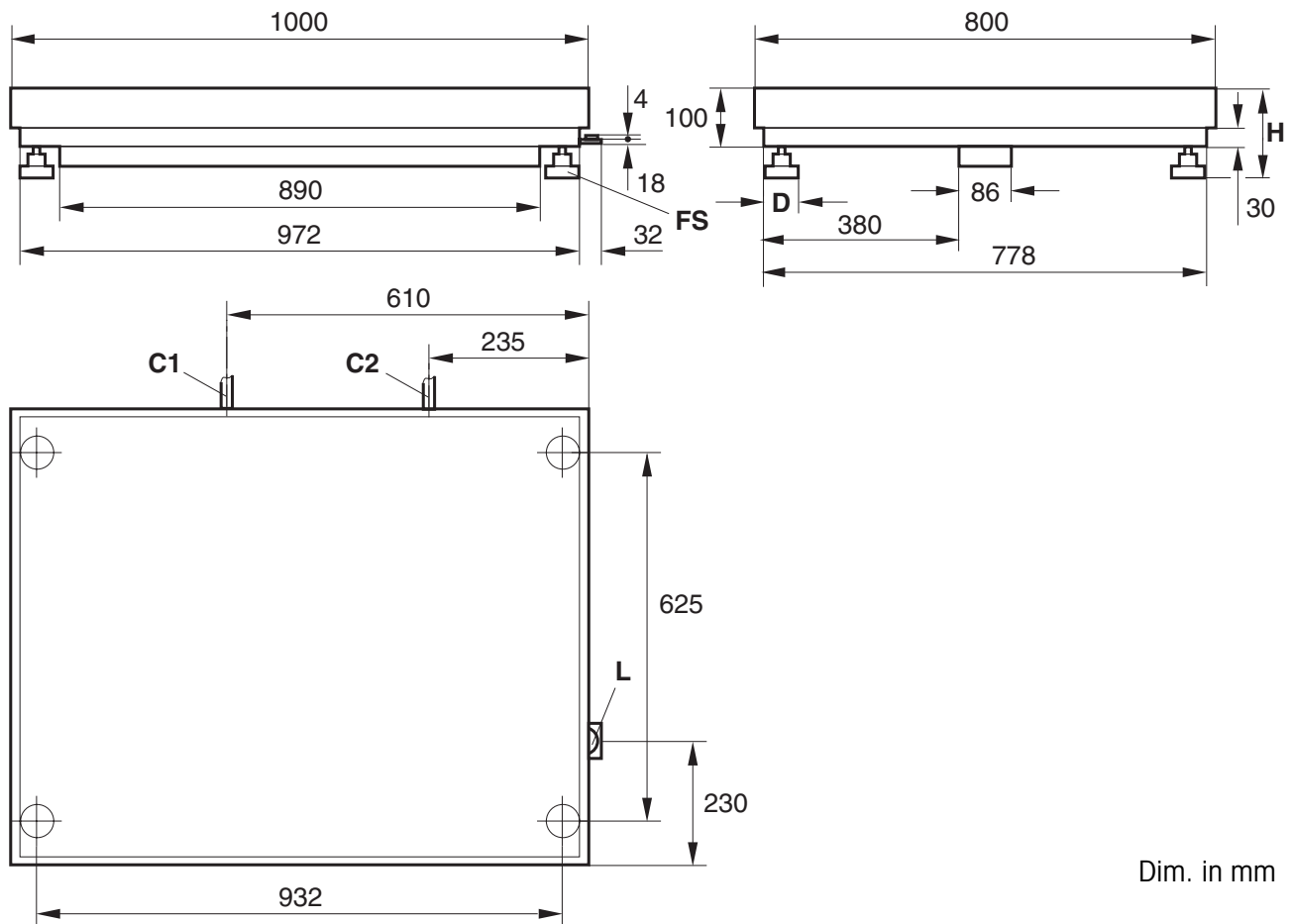

Dim. in mm

- H Adjustable with 4 foot bolts
Min. H = 115 mm
Max. H = 140 mm
- FS Foot bolt
Spanner size = 19 mm
Required area D = 40 mm dia.
- L Level indicator
- C1 Cable connection of KC300..x
- C2 Cable connection of KC600..x

Technical version: 08/2000

Dimensions of KCS...x

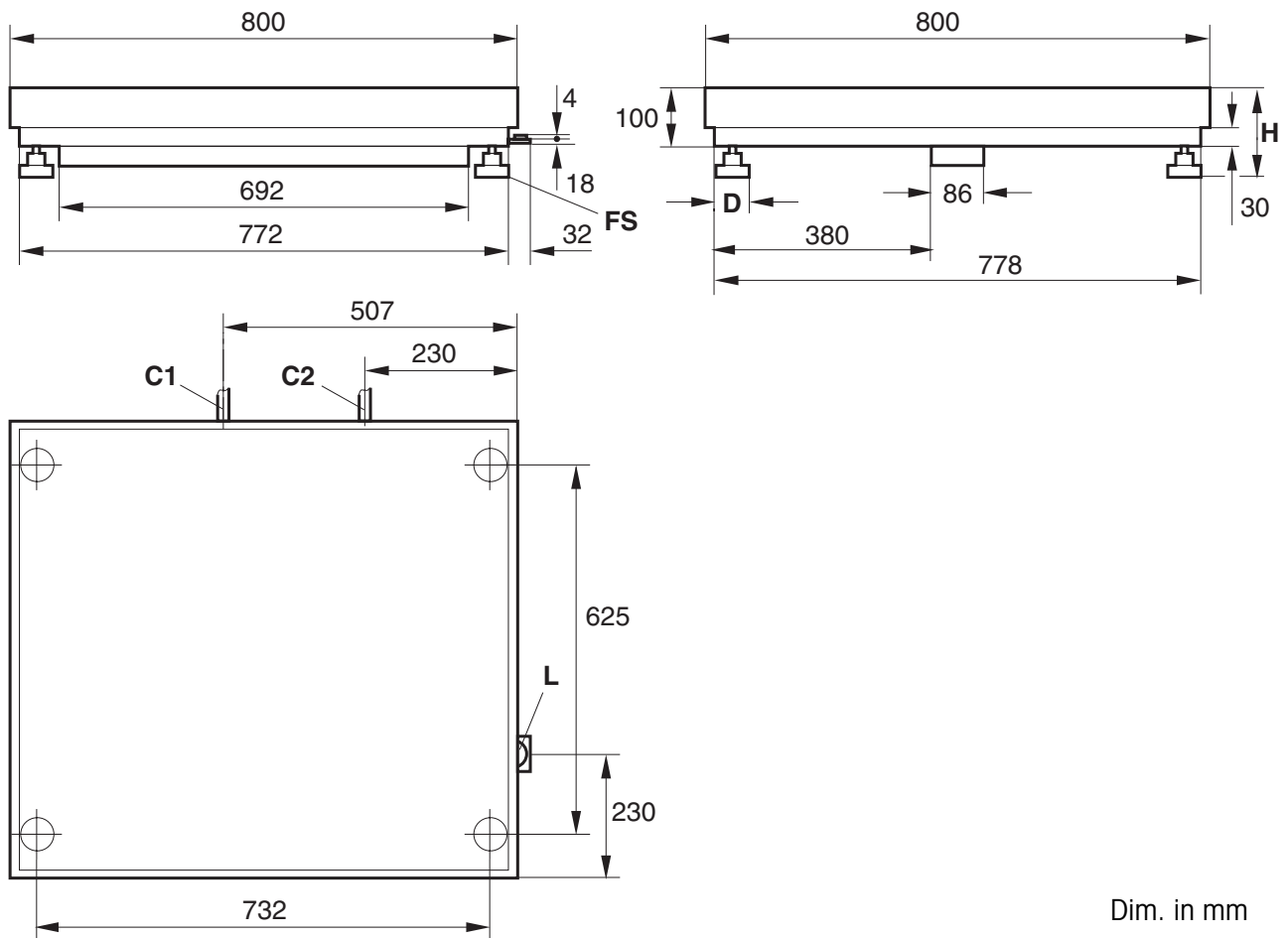

Dim. in mm

- H Adjustable with 4 foot bolts
Min. H = 115 mm
Max. H = 140 mm
- FS Foot bolt
Spanner size = 19 mm
Required area D = 40 mm dia.
- L Level indicator
- C1 Cable connection of KCS300..x
- C2 Cable connection of KCS600..x

Technical version: 08/2000

Dimensions of KD...x

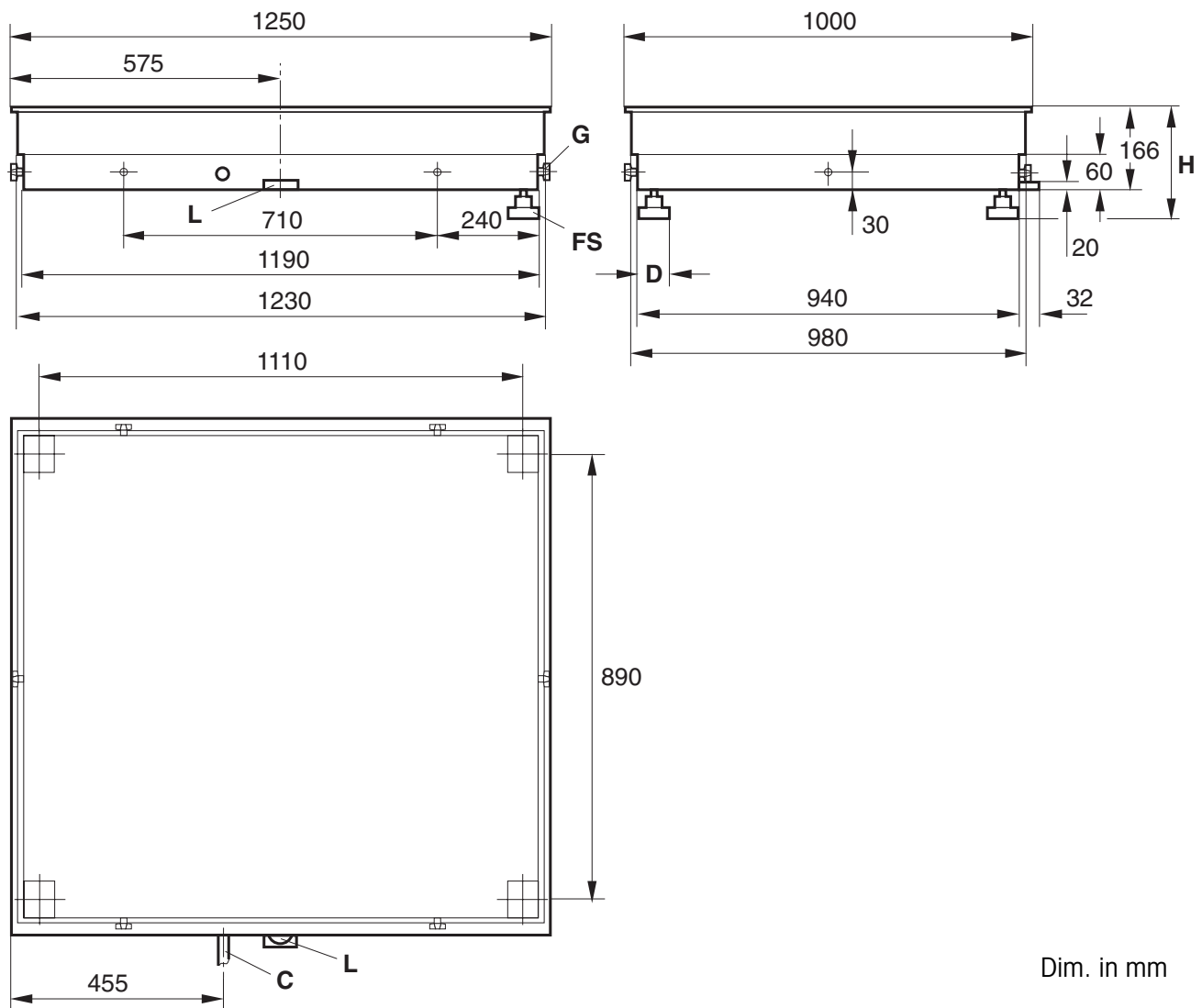

Dim. in mm

- H Adjustable with 4 foot bolts
Min. H = 180 mm
Max. H = 205 mm
- FS Foot bolt
Spanner size = 30 mm
Required area D = 60 x 60 mm
- G Thread M12
- L Level indicator
- C Cable connection

Technical version: 08/2000

Dimensions of KE...x/KE...skx

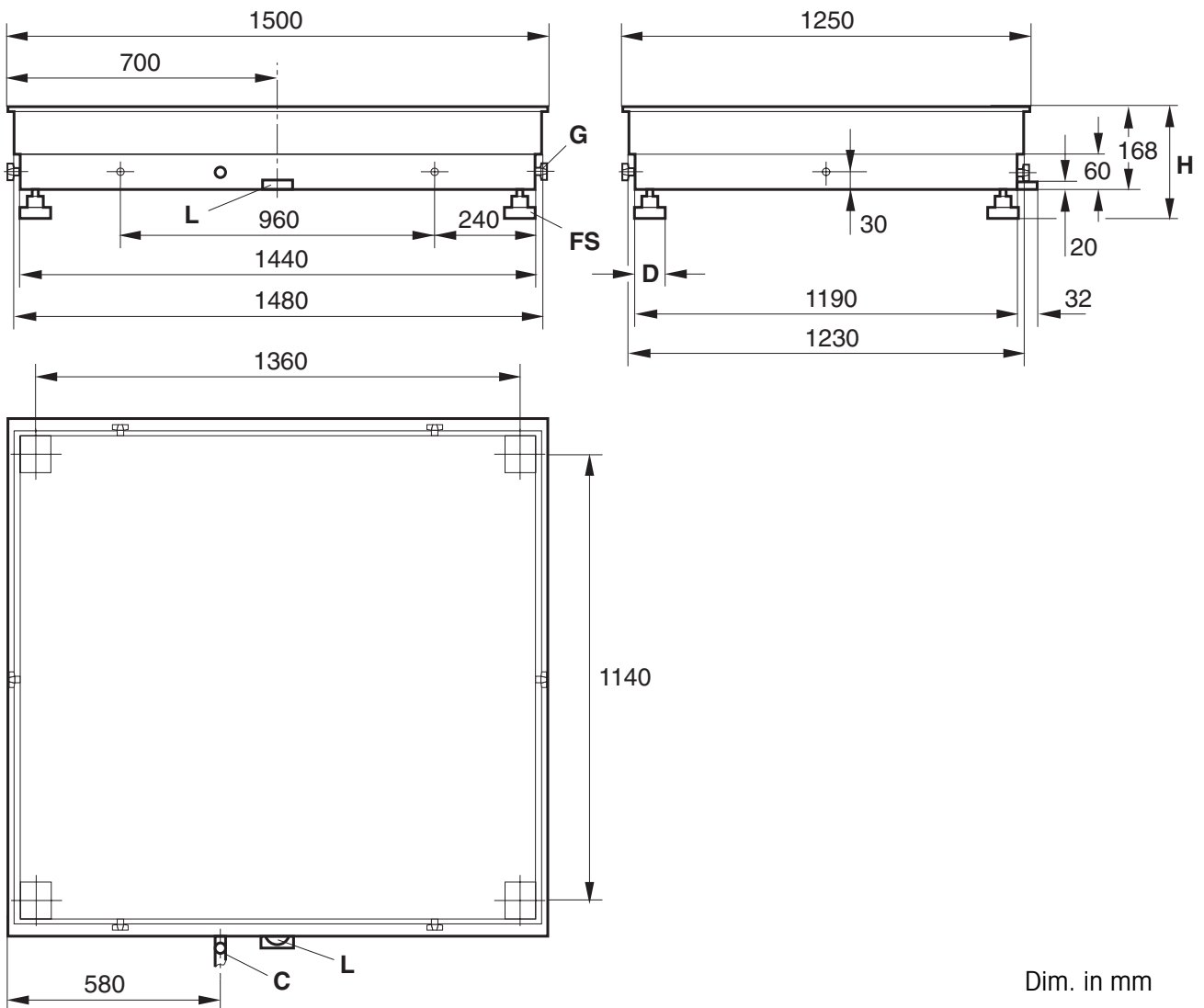

Dim. in mm

- H Adjustable with 4 foot bolts
Min. H = 182 mm
Max. H = 207 mm
- FS Foot bolt
Spanner size = 30 mm
Required area D = 60 x 60 mm
- G Thread M12
- L Level indicator
- C Cable connection

Technical version: 08/2000

Dimensions of KES...x/KES...skx

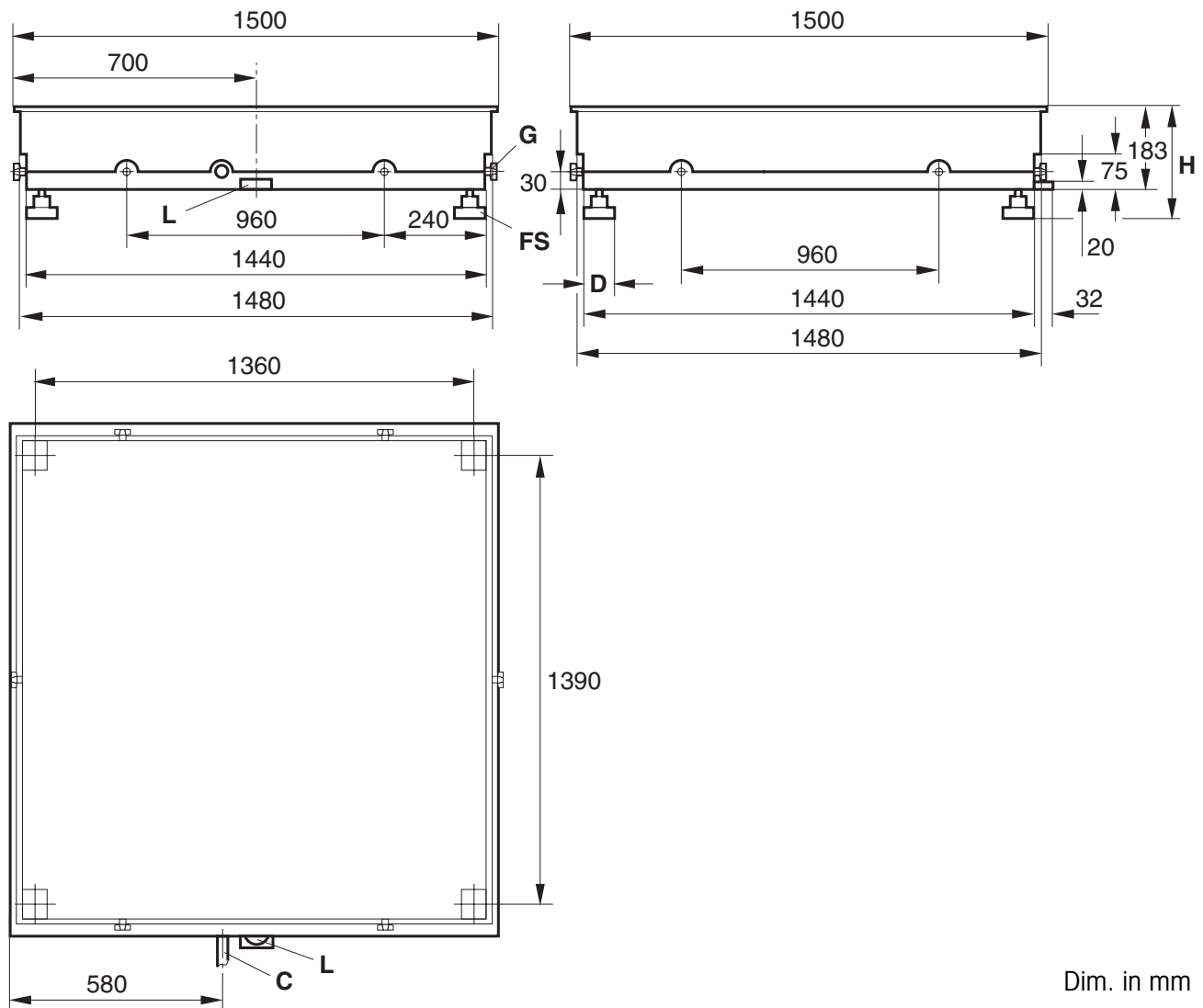

Dim. in mm

- H Adjustable with 4 foot bolts
H min. = 197 mm
H max. = 222 mm
- FS Foot bolt
Spanner size = 30 mm
Required area D = 60 x 60 mm
- G Thread M12
- L Level indicator
- C Cable connection

Technical version: 08/2000

Dimensions of KG...x

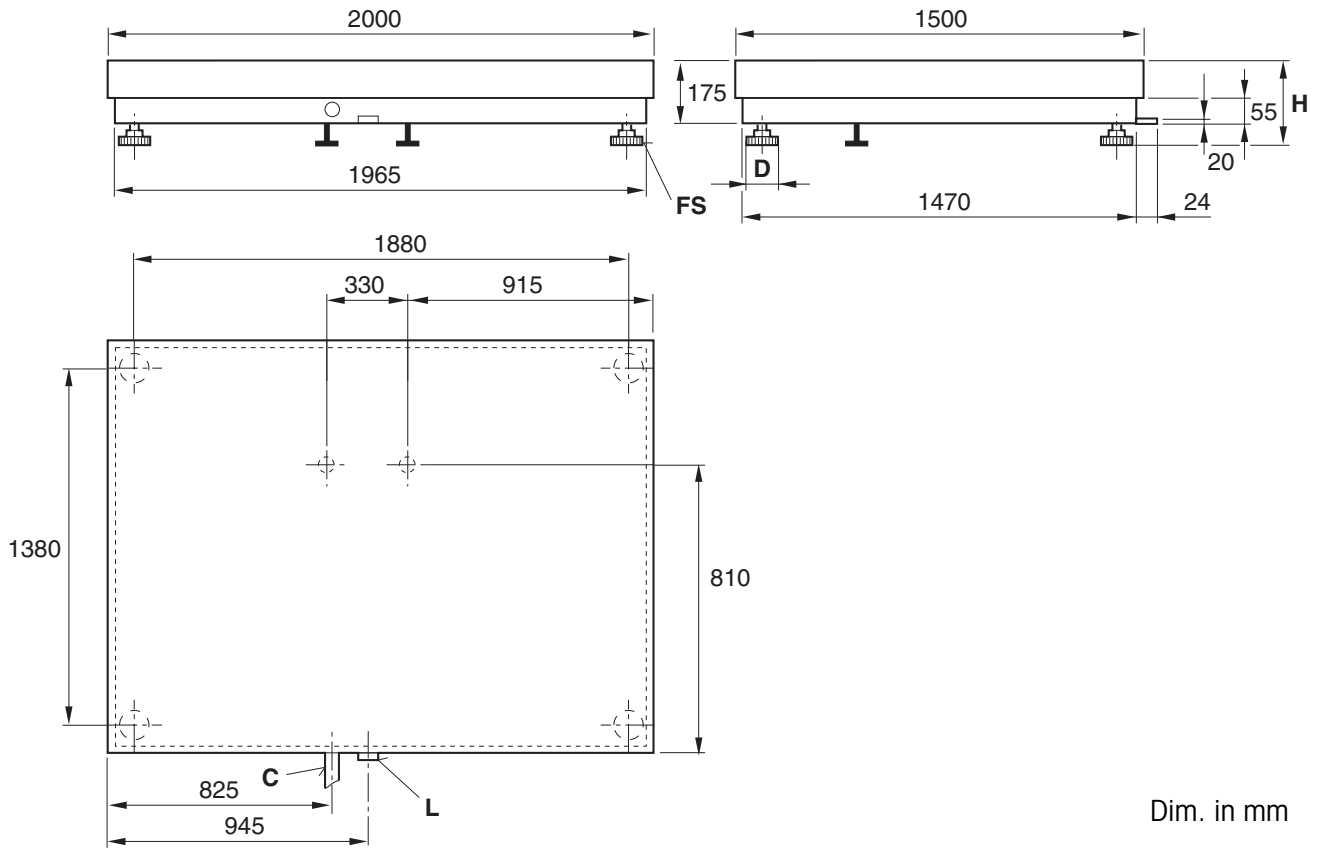

- H Adjustable with 4 foot bolts
H min. = 196 mm
H max. = 246 mm
- FS Foot bolt
Spanner size = 30 mm
Required area D = 90 mm dia.
- L Level indicator
- C Cable connection

Technical version: 08/2000

Dimensions of KN...x

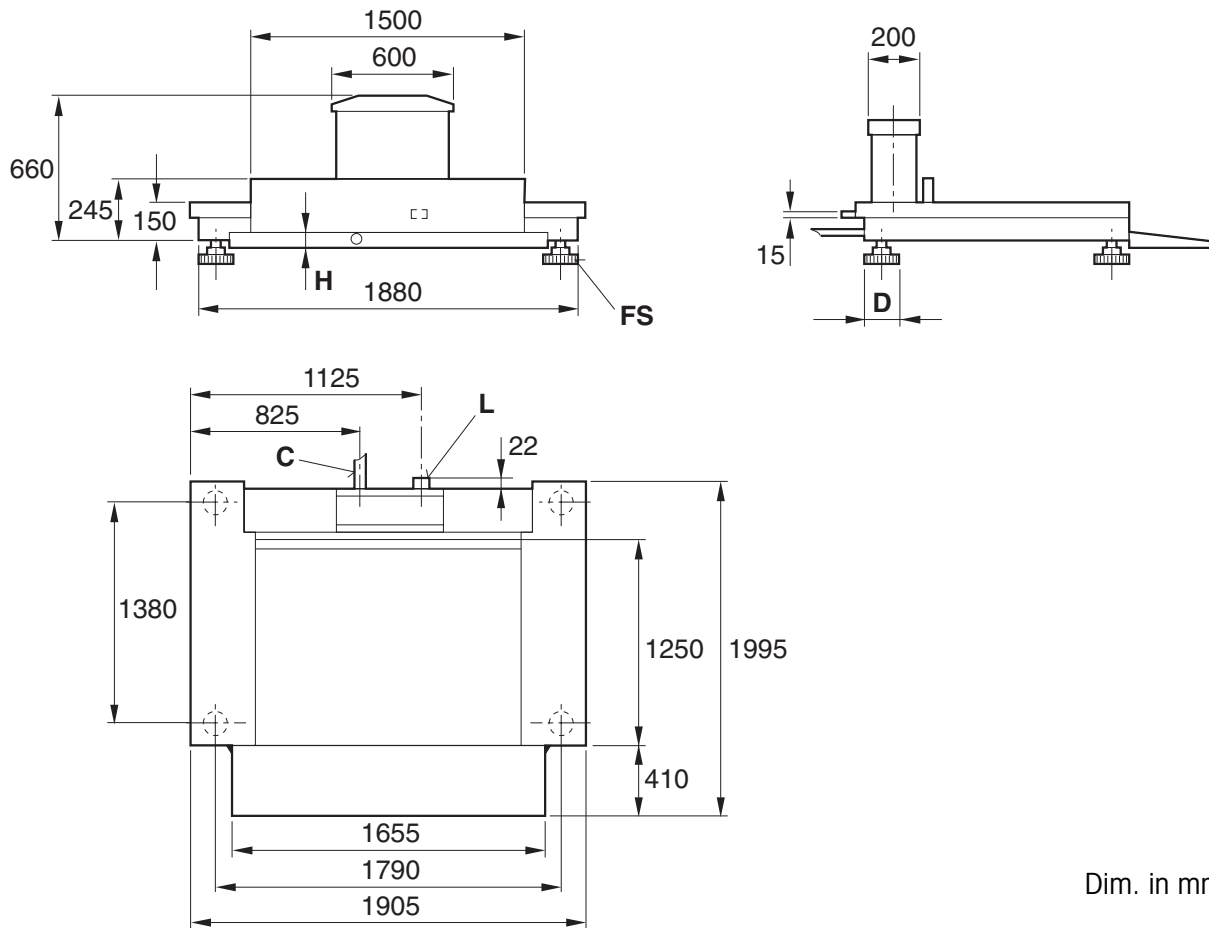

Dim. in mm

- H Adjustable with 4 foot bolts
H min. = 55 mm
H max. = 100 mm
- FS Foot bolt
Spanner size = 36 mm
Required area D = 90 mm dia.
- L Level indicator
- C Cable connection

Technical version: 08/2000



22006746A

Subject to technical changes © Mettler-Toledo (Albstadt) GmbH 04/04 Printed in Germany 22006746A

Mettler-Toledo (Albstadt) GmbH

D-72458 Albstadt

Tel. ++49-7431-14 0, Fax ++49-7431-14 232

Internet: <http://www.mt.com>