

METTLER TOLEDO
Compact scales BBA442 / BBK442

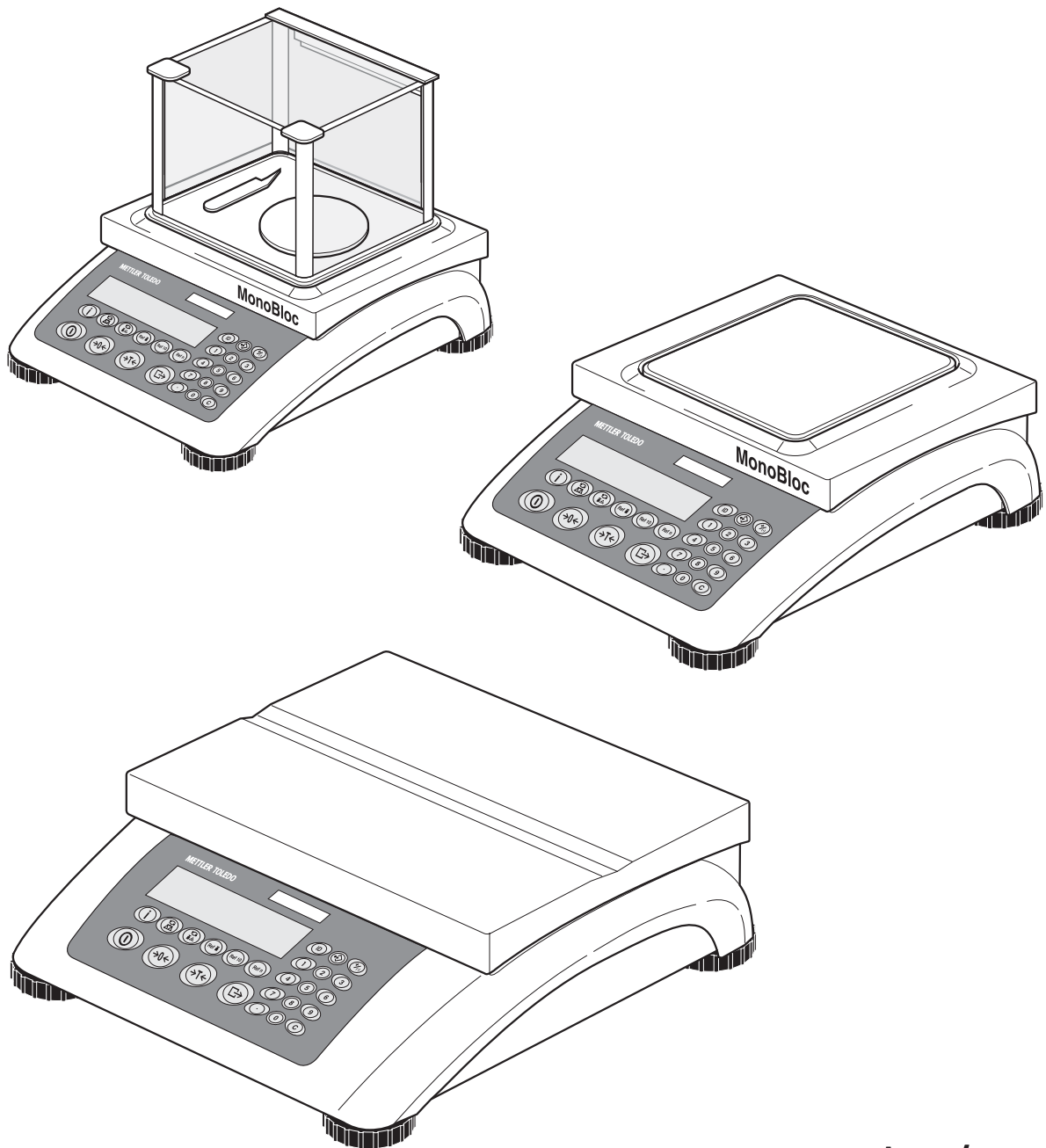



Congratulations on choosing the quality and precision of METTLER TOLEDO. Proper use according to this Operating Manual and regular calibration and maintenance by our factory-trained service team ensures dependable and accurate operation, protecting your investment. Contact us about a ServiceXXL agreement tailored to your needs and budget.

We invite you to register your product at www.mt.com/productregistration so we can contact you about enhancements, updates and important notifications concerning your product.

Table of contents

	Page
1	Introduction5
1.1	Safety instructions5
1.2	Description6
1.3	Putting into operation10
1.4	Disposal11
2	Operation12
2.1	Switching on and off12
2.2	Zeroing / Zero point correction12
2.3	Simple weighing12
2.4	Weighing with tare13
2.5	Displaying the capacity available15
2.6	Dynamic weighing15
2.7	Weighing-in to a target weight and checkweighing16
2.8	Working with identifications18
2.9	Printing results18
2.10	Displaying info19
2.11	Switching scales19
2.12	Totalizing20
2.13	Cleaning21
3	Counting22
3.1	Counting parts into a container22
3.2	Counting parts out of a container23
3.3	Counting with variable reference quantity23
3.4	Counting with minimum accuracy23
3.5	Reference optimization24
3.6	Counting with automatic reference determination24
3.7	Counting with a known average piece weight24
3.8	Counting by calling up a saved average piece weight25
3.9	Counting by calling up a saved target quantity26
3.10	Counting with two scales27
4	Settings in the menu29
4.1	Operating the menu29
4.2	Overview31
4.3	Scale settings (SCALE)35
4.4	Application settings (APPLICATION)38
4.5	Terminal settings (TERMINAL)42
4.6	Configuring interfaces (COMMUNICATION)44
4.7	Diagnosis and printing out of the menu settings (DIAGNOS)48
5	Interface description50
5.1	SICS interface commands50
5.2	TOLEDO Continuous mode52

6	Event and error messages	54
7	Technical data and accessories	56
7.1	Technical data	56
7.2	Accessories	62
8	Appendix	63
8.1	Information for certified scales in EC countries	63
8.2	Safety checks	63
8.3	Table of Geo Values	64
9	Index	67

1 Introduction

1.1 Safety instructions



CAUTION!

Do not use BBA442 / BBK442 in hazardous areas!
Our product range includes special devices for hazardous areas.



DANGER!

Electric shock hazard!

- ▲ Always pull out the mains plug before any work on the device.



DANGER!

Electric shock hazard if the mains cable is damaged!

- ▲ Check the mains cable for damage regularly and replace it immediately if it is damaged.
- ▲ On the rear side of the device, maintain a clearance of at least 3 cm in order to prevent the mains cable bending too much.



CAUTION!

On no account open the device!

The warranty is void if this stipulation is ignored. The device may only be opened by authorized persons.

- ▲ Call METTLER TOLEDO Service.



CAUTION!

Handle the compact scale with care.

The scale is a precision instrument.

- ▲ When the weighing pan has been removed, never clean the area under the load plate holder with a solid object!
- ▲ Do not put excessive loads on the scale.
- ▲ Avoid banging the weighing pan.

Note Use with foodstuffs

Parts coming into contact with foodstuffs have smooth surfaces and are easy to clean. The materials used do not splinter and are free of harmful substances.

With foodstuffs, it is recommended to use the supplied protective cover.

→ Clean the protective cover regularly and carefully.

→ Replace damaged or very dirty protective cover immediately.

1.2 Description

This user manual applies to the following types of compact scales:

- Compact scale BBA442... with strain gauge weighing cell
- Compact scale BBK442... with MonoBloc

The compact scales are available in a small and large size in various capacities and resolutions.

The power supply is carried out via a built-in power supply device, an internal rechargeable battery with an external mains adapter or an external battery.

One of the following options can also be ordered:

- Additional interface RS232 or RS485
- Ethernet interface
- USB interface
- Digital I/O
- Analog second scale interface

1.2.1 Overview

- 1 Display
- 2 Scale specifications
- 3 Load plate
- 4 Adjustable feet
- 5 Numerical keys
- 6 Function keys

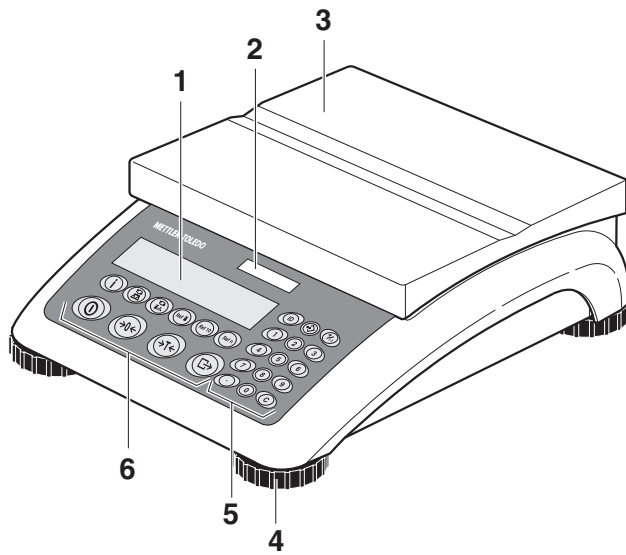

- 1 Power supply connection
- 2 Optional interface
- 3 (Standard) RS interface

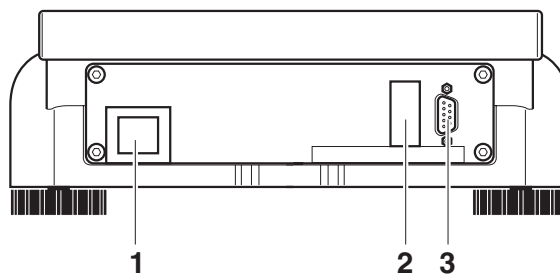



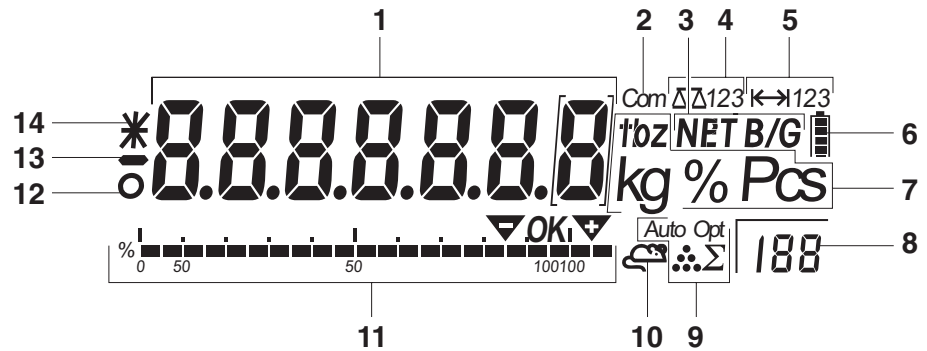

1.2.2 Display













- 1** 7-segment display, 7 digits, with decimal point
- 2** Active interface
- 3** Symbol for displaying gross and net values
- 4** Active scale
- 5** Weighing range display
- 6** Battery charge level; only present on scales with a battery
- 7** Weight units
- 8** Selected reference quantity
- 9** Symbols for optimizing the average piece weight and accumulating
- 10** Symbol for dynamic weighing
- 11** Graphic display of the weighing range, display for checkweighing
- 12** Stability monitor (goes out when a stable weight value is reached)
- 13** Sign
- 14** Identification for changed or calculated weight values, e.g. higher resolution, minimum weight not reached

1.2.3 Keypad

Main functions

Key	Function in operating mode	Function in the menu
	Switching device on / off, abort	To the last menu item –End–
	Setting scale to zero	Scrolling back
	Taring scale	Scrolling forward
	Transfer key Long key press: Calling up menu	Activating menu item Accepting selected setting

Additional functions

Key	Function
	Info key: Calling up additional information, e.g. gross weight, average piece weight, higher resolution ...
	Switching the scale
	Switching between weight value and number of pieces
	Defining average piece weight numerically
	Determining average piece weight from 10 pieces
	Determining average piece weight from any number of pieces
	Entering identification
	Memory
	Adding/subtracting
	Clear key
Keys 0 ... 9 and decimal point	Numerical keys for entering weight values, identifications ...

1.3 Putting into operation

1.3.1 Selecting or changing the location

The correct location is crucial to the accuracy of the weighing results!

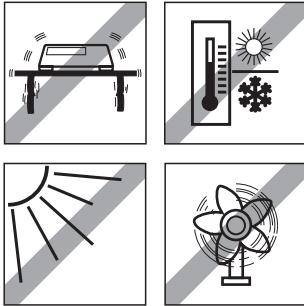

→ Select a stable, vibration-free and if possible a horizontal location.

The ground must be able to safely bear the weight of the fully loaded scale.

Observe the following environmental conditions:

- No direct sunlight
- No strong drafts
- No excessive temperature fluctuations

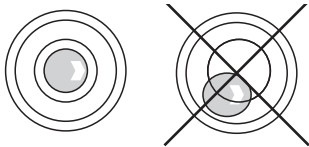

Aligning the scale

Only scales that have been aligned precisely horizontally provide accurate weighing results. The certified scales have a spirit level to simplify alignment.

→ Turn the adjustable feet of the scale until the spirit level's air bubble is inside the inner circle.

Major geographical location changes

The manufacturer adjusts each scale to the local gravity conditions (GEO value). In the event of major geographical location changes, this setting must be adjusted by a service technician. Certified scales must also be recertified observing the national certification regulations. These steps are not necessary for scales with an internal calibration weight.

1.3.2 Connecting the power supply



CAUTION!

Before connecting the scale to the mains, check whether the voltage value printed on the rating plate corresponds with the local mains voltage.

▲ Never connect the device if the voltage value printed on the rating plate is different to the local mains voltage.

→ Plug the mains plug into the socket.

After connection, the device performs a self-test. When the zero display appears, the device is ready to weigh.

→ Calibrate the device in order to obtain the greatest possible precision, see Section 4.3.2.

Note Partially certified scales (scales with first-level certification) must be certified by an authorized body or by the METTLER TOLEDO Service.

→ Call METTLER TOLEDO Service.

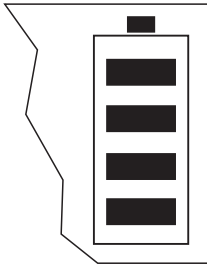

Scales with a built-in battery can work independently from the mains for approximately 30 hours in normal operation. A prerequisite for this is that the background lighting is switched off and that no peripheral devices are connected.

The device automatically switches to battery operation as soon as the mains supply is interrupted. When the mains supply is restored, the device automatically switches back to mains operation.

The battery symbol indicates the present charging level of the battery. 1 segment corresponds to approx. 25 % capacity. When the symbol flashes the battery must be charged (min. 4 hours). The charging period is extended if work is continued during charging. The battery is protected against overcharging.

The charging time of the storage battery amounts to approx. 6 hours. If the device continues to be operated during the charging process, the charging time is extended. The storage battery has a service life of approx. 1,000 charging/discharging cycles.

Note The storage battery is also suitable for permanent mains operation.

→ In order to obtain the full nominal capacity we recommend that you discharge the storage battery at regular intervals (approx. every 4 weeks) through normal operation.

1.4 Disposal



In conformance with the European Directive 2002/96 EC on Waste Electrical and Electronic Equipment (WEEE) this device may not be disposed of with domestic waste. This also applies to countries outside the EU, per their specific requirements.

→ Please dispose of this product in accordance with local regulations at the collecting point specified for electrical and electronic equipment.

If you have any questions, please contact the responsible authority or the distributor from which you purchased this device.

Should this device be passed on to other parties (for private or professional use), the content of this regulation must also be related.

Thank you for your contribution to environmental protection.

If the device is equipped with a storage battery:

The nickel metal hydride (NiMH) storage battery does not contain any heavy metals. However, it may not be disposed of with the normal refuse.

→ Observe the local regulations on the disposal of materials that are hazardous to the environment.

2 Operation

2.1 Switching on and off

Switching on → Press .

The scale conducts a display test. When the weight display appears, the scale is ready to weigh.

Switching off → Press .

Before the display goes out, -OFF- appears briefly.

2.2 Zeroing / Zero point correction

Zeroing corrects the influence of slight changes on the load plate.

- Manual**
1. Unload scale.
 2. Press .

The zero display appears.

Automatic In the case of scales that cannot be certified, the automatic zero point correction can be deactivated in the menu or the amount can be changed.

As standard, the zero point of the scale is automatically corrected when the scale is unloaded.

2.3 Simple weighing

1. Place weighing sample on scale.
2. Wait until the stability monitor  goes out.
3. Read weighing result.

2.4 Weighing with tare

2.4.1 Taring

→ Place the empty container on the scale and press .

The zero display and the symbol **NET** appear.

The tare weight remains saved until it is cleared.

2.4.2 Clearing the tare

→ Unload scale and press .

The symbol **NET** goes out, the zero display appears.

or

→ Press .

The symbol **NET** goes out, the gross weight appears in the display.

If `A.CL-tx` is activated in the menu, the tare weight is automatically cleared as soon as the scale is unloaded.

2.4.3 Automatic taring

Prerequisite

`A-tArE` is activated in the menu under `SCALE` → `tArE`, the symbol **T** flashes in the display.

The packaging material must be heavier than 9 display steps of the scale.

→ Place the container or packaging material on the scale.

The packaging weight is automatically saved as the tare weight, the zero display and the symbol **NET** appear.

2.4.4 Numerical tare weight entry

1. Enter the known tare weight numerically and press .

The entered weight is automatically saved as the tare weight, the symbol **NET** and the tare weight with a minus sign appear.

2. Place the filled container on the scale.

The net weight appears in the display.



2.4.5 Taring by calling up a saved tare value

BBA442 / BBK442 have a total of 100 memory locations for frequently used tare values, average piece weights, target weights and target quantities. In the factory setting, the memory locations 01 to 40 are reserved for tare values. The saved tare values are also preserved when the scale is switched off.

Saving tare weights

1. Determine the tare weight in one of the ways described earlier.
2. Enter the memory location number (factory setting: 1 ... 40) and keep  pressed until the confirmation appears in the display, e.g. `tArE.12`.

Note If a tare weight had already been saved under the selected memory location, the message `rEPLAcE` appears in the display.

- To save the new tare weight, press . The old tare weight is overwritten.
- To abort the save process, press . The previous memory location assignment remains valid.

Calling up tare weights

→ Enter the number of the memory location with the required tare weight (factory setting: 1 ... 40) and press  briefly.

The selected tare value is loaded from the memory and appears briefly in the display. The scale tares with the selected tare value and then displays the current net weight.

Clearing saved tare weights

1. Enter the number of the memory location with the tare weight to be cleared (factory setting: 1 ... 40) and press  briefly.

The saved tare value is displayed.

2. Press  within 2 seconds.



`CLearED` briefly appears in the display. The saved tare value is cleared.

2.4.6 Chain tare

Prerequisite

The tare function `CHAI.n.tr` is activated in the menu.

With this function it is possible to tare several times if, for example, cardboard is placed between individual layers in a container.

1. Place the first container or packaging material on the scale and press . The packaging weight is automatically saved as the tare weight, the zero display and the symbol **NET** appear.
2. Weigh the weighing sample and read/print out the result.
3. Place the second container or packaging material on the scale and press  again. The total weight on the scale is saved as the new tare weight. The zero display appears.
4. Weigh the weighing sample in the second container and read/print the result.
5. Repeat the last two steps for other containers.

2.5 Displaying the capacity available



The scale has a graphic display of the scale capacity available. The bar indicates how many per cent of the scale capacity is already occupied and what capacity is still available. In the example, approx. 65 % of the scale capacity is occupied.

2.6 Dynamic weighing

With the dynamic weighing function, it is possible to weigh restless weighing samples such as live animals. If this function is activated, the symbol  appears in the display.

With dynamic weighing, the scale calculates the mean value from 56 weighing operations within 4 seconds.

With manual start Prerequisite

`AVERAGE` -> `MANUAL` is selected in the menu.

The weighing sample must be heavier than 5 scale divisions.

1. Place the weighing sample on the scale and wait until it has stabilized.
2. Press  to start dynamic weighing. During dynamic weighing, horizontal segments appear in the display, and the dynamic result is then displayed with the symbol *.
3. Unload the scale to be able to start a new dynamic weighing operation.

With automatic start Prerequisite

AVERAGE → AUTO is selected in the menu.

The weighing sample must be heavier than 5 scale divisions.

1. Place the weighing sample on the scale.

The scale starts the dynamic weighing automatically.

During dynamic weighing, horizontal segments appear in the display, and the dynamic result is then displayed with the symbol *.



2. Unload the scale to be able to perform a new dynamic weighing operation.

2.7 Weighing-in to a target weight and checkweighing

The compact scales BBA442 / BBK442 allow the weighing-in of goods to a particular target weight within defined tolerances. With this function it is possible to check whether weighing samples are within a defined tolerance range.



The compact scales BBA442 / BBK442 have a total of 100 memory locations for frequently used tare values, average piece weights, target weights and target quantities. In the factory setting, the memory locations 81 to 90 are reserved for target weights. The saved target weights are also preserved when the scales are switched off.

2.7.1 Saving target weights

1. Enter the memory location number (factory setting: 81 ... 90) and keep  pressed until the confirmation tARGET appears in the display.
2. Enter the target weight in the defined unit, e.g. 1.5 kg, and confirm with .

The display tOLER appears and + flashes.
3. Enter the upper tolerance in the displayed weight unit, e.g. 0.1 kg, and confirm with :



-or-

→ Press , enter the upper tolerance range in per cent and confirm with .

The display tOLER appears and – flashes.
4. Enter the lower tolerance accordingly.

The scale returns to weighing mode.

Note If a target weight had already been saved under the selected memory location, the message rEPLACE appears in the display.

- To save the new target weight, press . The old target weight is overwritten.
- To abort the save process, press . The previous memory location assignment remains valid.

2.7.2 Calling up target weights

- Enter the number of the memory location with the required target weight (factory setting: 81 ... 90) and press  briefly.

The selected target weight and the tolerances are loaded from the memory and appear briefly in the display. The scale is now ready for weighing-in or checkweighing.

2.7.3 Weighing-in

1. Place the empty container on the scale and tare.
2. Fill the container with the weighing sample.



The dispensing process can be followed in the graphic display. The 50 % marking is on the far left here, so that more display segments are available for precise filling between 50 % and 100 %.

As long as the lower tolerance is not reached, the minus tolerance mark is displayed.



If the weight of the weighing sample is within the defined tolerance, the mark **OK** is visible and a short beep sounds if activated in the menu.



When the plus tolerance mark appears, the weight is above the permissible tolerance.

2.7.4 Checkweighing

1. Place the weighing sample on the scale.
2. Use the displayed mark to check whether the weighing sample is below, within or above the defined tolerance.



2.7.5 Clearing the saved target weights

1. Enter the number of the memory location with the target weight to be cleared (factory setting: 81 ... 90) and press  briefly.

The saved target weight is displayed.

2. Press  within 2 seconds.

CLEAR_{ED} briefly appears in the display. The saved target weight is cleared.

2.8 Working with identifications

Weighing series can be assigned 2 identification numbers ID1 and ID2 with up to 40 characters that are also printed out on the protocols.

If for example a customer number and an article number are assigned, it can be clearly seen on the protocol which article was weighed for which customer.

2.8.1 Entering identification

1. Enter identification and press **ID**.
IDENT 1 appears in the display.
2. If the entered identification is to be saved as ID1, press **↵**. If the entered identification is to be saved as ID2, first press **→T←**, and then press **↵**.
The scale returns to weighing mode.

2.8.2 Displaying identification

- Displaying ID1: Briefly press **ID** once.
The number currently assigned to the ID1 appears in the display. If no ID1 was assigned, no ID appears.
- Displaying ID2: Briefly press **ID** twice.
The number currently assigned to the ID2 appears in the display. If no ID2 was assigned, no ID appears.

2.8.3 Clearing identifications

1. Briefly press **ID** once to display ID1 or briefly press **ID** twice to display ID2.
2. Press **C** for as long as the identification is displayed.
The clearing is briefly confirmed with the message **CLEAREd**.

2.9 Printing results

If a printer or computer is connected to the scale, the weighing results can be printed out or sent to a computer.

- Press **↵**.
The display contents are printed out and transferred to the computer.

2.10 Displaying info

Up to 13 different values to be displayed can be configured in the menu for the key .

Depending on the configuration in the menu, see Section 4.4.5, the following values can be stored in any order (for example):

- Net quantity
- Gross weight
- Average piece weight
- Average piece weight, higher resolution
- Counting accuracy

1. Press .

The first value is displayed.

2. Press  again.

The next value is displayed.

3. Repeat as often as necessary until the weight display appears again.

Note If  is not pressed again within 5 seconds, the scale automatically changes to the weight display, even if all information has not yet been queried.

2.11 Switching scales

If a second scale or a weighing platform is connected, e. g. via the optional analog second scale interface, the currently active scale is shown in the display.

The second scale can be operated in exactly the same way as the first scale.

→ Press .

The display changes from one scale to the other.

Changing the operating mode of the second scale

The second scale can be operated as bulk scale (bulk), reference scale (ref) or auxiliary scale (auxiliary), see Section 4.6. In the factory setting the second scale operates as bulk scale.

→ To change the operating mode, keep the  key pressed until the new operating mode appears briefly in the display.

The second scale will now operate in the other operating mode. The setting in the menu has been changed automatically.

2.12 Totalizing

The compact scales BBA442 / BBK442 can totalize weight values or pieces. Individual items can also be subtracted.

A connected printer offers you the possibility of generating a printout for each individual item and/or a complete printout. For settings in the menu, see Section 4.4.2.

2.12.1 Totalizing items

1. Place the first item on the scale and press \oplus/\ominus .

The weight value or the number of pieces are saved and, if necessary, printed out.

2. Unload scale.

3. Place the next item on the scale and press \oplus/\ominus again.

The weight value and the number of pieces of the next item are added to those of the previous one.

4. Unload scale.

5. Repeat steps 3 and 4 for all other items.

2.12.2 Subtracting items

1. Place the item on the scale, press and hold down \oplus/\ominus .

The weight value or the number of pieces are subtracted and, if necessary, printed out.

2. Unload scale.

2.12.3 Completing totalizing

- When the last item has been totalized, press C .

The "Final Printout" is produced. The sum memory and the item counter are cleared. The scale is ready for the next totalizing process.

2.12.4 Calling up sum information

If the key i is assigned accordingly, the number of items, the net sum, the gross sum and the number of pieces of the current item can be called up via this key, see Section 4.4.5.

2.13 Cleaning



CAUTION!

Electric shock hazard!

- ▲ Before cleaning with a damp cloth, pull out the mains plug to disconnect the unit from the power supply.



CAUTION!

When the weighing pan has been removed, never clean the area under the load plate holder with a solid object!

This could damage the weighing cell.

Other cleaning information:

- Use damp cloths.
- Do not use any acids, alkalis or strong solvents.
- Do not clean using a high-pressure cleaning unit or under running water.
- If very dirty, remove the weighing pan, protective cover (if present) and adjustable feet and clean these items separately.
- Follow all the relevant instructions regarding cleaning intervals and permissible cleaning agents.

3 Counting



The compact scales BBA442 / BBK442 have additional functions for piece counting. The relevant settings in the menu are described in Section 4.4.1.

3.1 Counting parts into a container

1. Place the empty container on the scale and press .



The container is tared and the zero display appears.
2. Place **10** reference parts on the scale and press .

-or-

→ Place the number of pieces displayed above the key  on the scale and press .

The scale determines the average piece weight and then shows the number of pieces.
3. Add more parts to the container until the required number of pieces is reached.
4. When the piece counting is completed, press the key  to clear the result.

The scale is ready for the next weighing or counting.

- Note**
- The average piece weight remains saved in the factory setting until a new average piece weight is determined.
 - With  it is possible to switch between the number of pieces and the weighing units preset.
 - Depending on the assignment, it is possible to display the average piece weight, i. e. the weight of an individual reference unit, with .
 - If **A.CL-APW ON** is set in the menu, the average piece weight is automatically cleared after each counting operation. The average piece weight must be determined again for the next counting operation.
 - If **ACCURCY ON** is set in the menu, the accuracy achieved is briefly shown after the number of pieces is determined.

3.2 Counting parts out of a container

1. Place the full container on the scale and press $\rightarrow T \leftarrow$.

The container is tared and the zero display appears.

2. Remove **10** reference parts and press $\text{Ref } 10$.

-or-

- Remove the number of pieces displayed above the key $\text{Ref } n$ and press $\text{Ref } n$.

The scale determines the average piece weight and then shows the number of pieces removed, together with a minus sign.

3. Remove more parts from the container until the required number of pieces is reached.

3.3 Counting with variable reference quantity

Prerequisite

VAR-SPL ON must be set in the menu.

1. Place any number of reference parts on the scale.
2. Enter the number of reference parts with the numerical keypad and press $\text{Ref } n$.

The scale determines the average piece weight and then shows the number of pieces.

The rest of the counting process is as described earlier.

3.4 Counting with minimum accuracy

The item `Min.rEFW` in the menu allows to preset a minimum accuracy of 97.5 %, 99.0 % or 99.5 %. On the basis of this, the scale calculates the minimum reference weight necessary to reach the defined accuracy.

1. Place the reference parts on the scale and press $\text{Ref } 10$ or $\text{Ref } n$.
2. If the average piece weight is not sufficient to ensure the desired accuracy, `Add x PCS` appears.
3. Add the displayed number of pieces.

The scale then automatically determines the average piece weight with the larger reference quantity.



The rest of the counting process is as described earlier.

3.5 Reference optimization

The greater the reference quantity, the more accurately the scale determines the number of pieces.

3.5.1 Automatic reference optimization

rEF.OPT -> AUTO must be set in the menu for this. The symbol **Auto Opt** appears in the display.

1. Place the reference parts on the scale and press  or .
2. Place additional reference parts, max. the same number as for the first reference determination, on the scale.

The scale automatically optimizes the average piece weight with the larger number of reference parts.

The rest of the counting process is as described earlier.

Note Reference optimization can be carried out several times. If the parts differ too strongly, no automatic reference optimization is carried out.

3.6 Counting with automatic reference determination

Prerequisite

A-SMPL ON is set in the menu.

→ Place the number of pieces displayed above the key  into the container.

The scale automatically determines the average piece weight and then shows the quantity.

The rest of the counting process is as described earlier.

3.7 Counting with a known average piece weight

→ Enter the known average piece weight via the numerical keypad and press .

The scale changes the unit to PCS.

The rest of the counting process is as described earlier.



3.8 Counting by calling up a saved average piece weight

The compact scales BBA442 / BBK442 have a total of 100 memory locations for frequently used tare values, average piece weights, target weights and target quantities. In the factory setting, the memory locations 41 to 80 are reserved for average piece weights. The saved average piece weights are also preserved when the scale is switched off.

3.8.1 Saving average piece weights

1. Determine the average piece weight in one of the ways described earlier.
2. Enter the memory location number (factory setting: 41 ... 80) and keep  pressed until the confirmation appears in the display, e.g. *APW. 41*.

Note If an average piece weight had already been saved under the selected memory location, the message *rEPLACE* appears in the display.

- To save the new average piece weight, press . The old average piece weight is overwritten.
- To abort the save process, press . The previous memory location assignment remains valid.

3.8.2 Calling up average piece weights

→ Enter the number of the memory location with the required average piece weight (factory setting: 41 ... 80) and press  briefly.

The selected reference value is loaded from the memory and appears briefly in the display. The scale determines the number of pieces with the selected reference value.

3.8.3 Clearing saved average piece weights

1. Enter the number of the memory location with the average piece weight to be cleared (factory setting: 41 ... 80) and press  briefly.

The saved average piece weight is displayed.



2. Press  within 2 seconds.

*CLEAR*ED briefly appears in the display. The saved average piece weight is cleared.



3.9 Counting by calling up a saved target quantity

The compact scales BBA442 / BBK442 have a total of 100 memory locations for frequently used tare values, average piece weights, target weights and target quantities. In the factory setting, the memory locations 91 to 100 are reserved for target quantities. The saved target quantities are also preserved when the scale is switched off.

3.9.1 Saving target quantities

1. Enter the memory location number (factory setting: 91 ... 100) and keep  pressed until the confirmation `tARGET` appears in the display.
2. Enter the target quantity and confirm with .
The display `tOLER` appears and `+` flashes.
3. Enter the upper tolerance in pieces and confirm with .
The display `tOLER` appears and `-` flashes.
4. Enter the lower tolerance accordingly.
The scale returns to weighing mode.

Note If a target quantity had already been saved under the selected memory location, the message `rEPLACE` appears in the display.

- To save the new target quantity, press . The old target quantity is overwritten.
- To abort the save process, press . The previous memory location assignment remains valid.

3.9.2 Calling up target quantities

- Enter the number of the memory location with the required target quantity (factory setting: 91 ... 100) and press  briefly.

The selected target quantity and the associated tolerances are loaded from the memory and appear briefly in the display.

3.9.3 Counting in to target quantities

1. Place the empty container on the scale and tare.
2. Specify a reference.
3. Fill the container with the material being counted.



The counting-in process can be followed in the graphic display. The 50 % marking is on the far left here, so that more display segments are available for precise filling between 50 % and 100 %.

As long as the lower tolerance is not reached, the minus tolerance mark is displayed.



If the counted-in number of pieces is within the defined tolerance, the mark **OK** is visible and a short beep sounds if activated in the menu.



When the plus tolerance mark appears, the number of pieces is above the permissible tolerance.

3.9.4 Clearing saved target quantities

1. Enter the number of the memory location with the target quantity to be cleared (factory setting: 91 ... 100) and press  briefly.

The saved target quantity with tolerances is displayed.

2. Press  within 2 seconds.

CLEAR_{ED} briefly appears in the display. The saved target quantity is cleared.

3.10 Counting with two scales

For piece counting, it is possible to connect a second scale or weighing platform, e.g. a floor scale for counting a large number of pieces via the optional analog second scale interface.

The necessary settings for the application and interface parameters are described in the Sections 4.4.1, 4.6.1 and 4.6.5.

3.10.1 Counting with a reference scale

Prerequisite

The connected second scale is configured as reference scale.

1. Place the reference parts on the reference scale and press  or .

The scale determines the average piece weight and changes to the display in pieces (PCS).

2. Place the parts to be counted on the first scale.



The total quantity is displayed.

- Note**
- If `tOTAL-Ct -> bULK` is set in the menu, only the number of pieces on the bulk scale is displayed.
 - If `tOTAL-Ct -> bOTH` is set in the menu, the reference quantity is added to the bulk quantity.

3.10.2 Counting with a bulk scale

Prerequisite

The connected second scale is configured as bulk scale.

1. Place the reference parts on the first scale and press  or .

The scale determines the average piece weight and changes to the display in pieces (PCS).

2. Place the parts to be counted on the bulk scale.

The total quantity is displayed.



- Note**
- If `tOTAL-Ct -> bULK` is set in the menu, only the number of pieces on the bulk scale is displayed on the bulk scale.
 - If `tOTAL-Ct -> bOTH` is set in the menu, the reference quantity is added to the bulk quantity.

3.10.3 Counting with an auxiliary scale

- Note** This configuration allows counting of diverse parts, for example very small parts on one scale and large parts on the other scale.

Prerequisite

The connected second scale is configured as an auxiliary scale. The scale doesn't change automatically but only after pressing the  key.

1. Activate the appropriate scale.
2. Place the reference parts on this scale and press  or .

The scale determines the average piece weight and changes to the display in pieces (PCS).

3. Place the parts to be counted on the same scale.

The number of pieces is displayed.

4 Settings in the menu

Settings can be changed and functions can be activated in the menu. This enables adaptation to individual weighing requirements.



The menu consists of 6 main blocks containing various submenus on several levels.

4.1 Operating the menu

4.1.1 Calling up the menu and entering the password



The menu differentiates between 2 operating levels: Operator and Supervisor. The Supervisor level can be protected by a password. When the device is delivered, both levels are accessible without a password.

Operator menu

1. Press  and keep it pressed until CODE appears.
2. Press  again.

The menu item tErMINL appears. Only the submenu dEVICE is accessible.

Supervisor menu

1. Press  and keep it pressed until CODE appears.
2. Enter the password and confirm with .



The first menu item SCALE appears.

Note

No supervisor password has been defined when the device is first delivered. Therefore respond to the password inquiry with  when you call up the menu for the first time. If a password has still not been entered after a few seconds, the scale returns to weighing mode.

Emergency password for Supervisor access to the menu

If a password has been issued for Supervisor access to the menu and you have forgotten it, you can still enter the menu:

- Press  3 times and confirm with .

4.1.2 Selecting and setting parameters

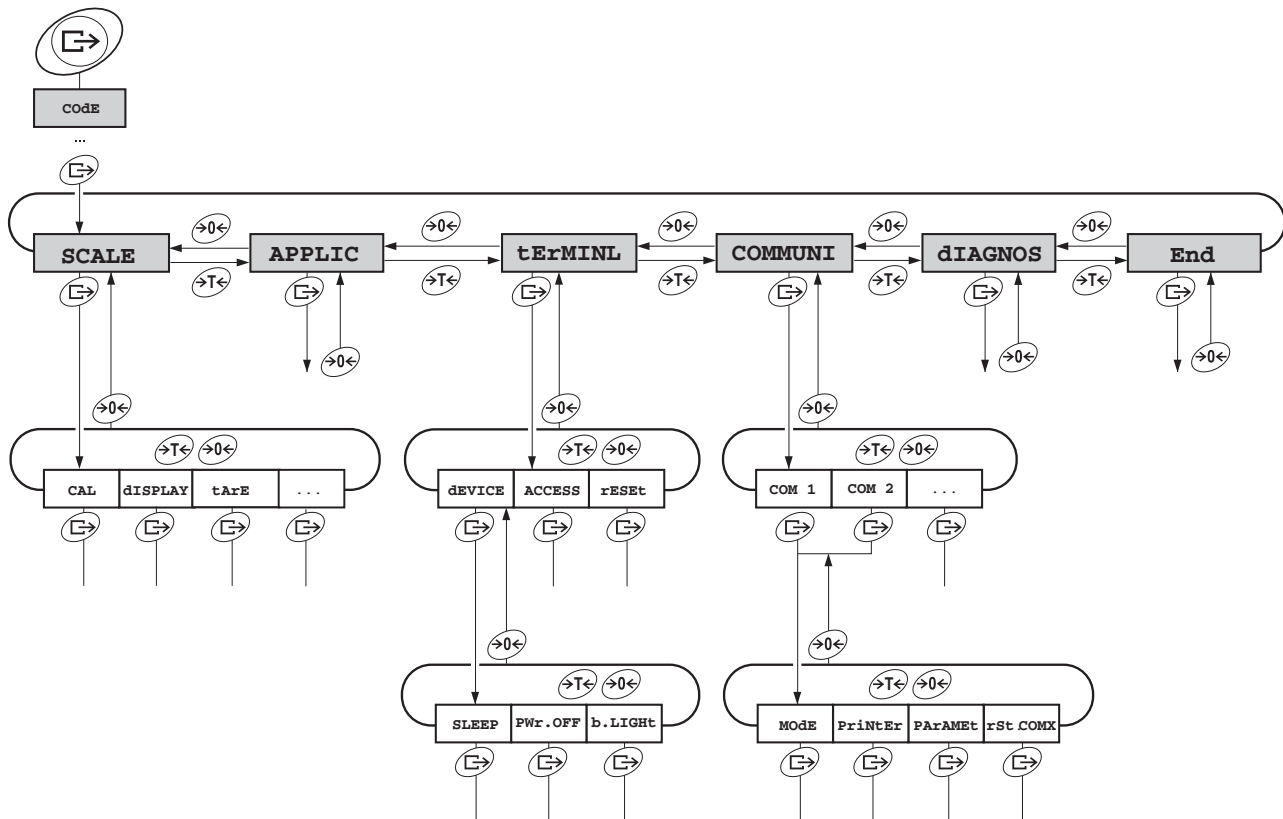

- Scrolling on one level**
- Scroll forward: Press $\rightarrow T \leftarrow$.
 - Scroll back: Press $\rightarrow 0 \leftarrow$.

- Activating menu items/
accepting selection**
- Press \rightarrow .

- Exiting menu**
1. Press $\textcircled{0}$.
The last menu item END appears.
 2. Press \rightarrow .
The inquiry SAVE appears.
 3. Confirm inquiry with \rightarrow to save the settings and return to weighing mode.
-or-
→ Press $\rightarrow T \leftarrow$ to discard changes and return to weighing mode.

4.2 Overview

Level 1	Level 2	Level 3	Level 4	Level 5	Level 6	Page	
SCALE	SCALE1/SCALE2					35	
	CAL					35	
	dISPLAY	UNIt1	g, kg , oz, lb, t			35	
		UNIt2	g, kg, oz, lb, t				
		rESOLU					
		UNt.rOLL	ON, OFF				
	tArE	A-tArE	ON, OFF			36	
		ChAIn.tr	ON , OFF				
		A.CL-tr	ON, OFF , 9d				
	ZErO	AZM	OFF; 0.5 d; 1 d; 2 d; 5 d; 10 d			36	
	rEStArt	ON/ OFF				36	
	FILtEr	VibrAt	LOW, Med , HIGH,			36	
		PrOCeSS	UNIVER , dOSING				
		StAbILI	FASt, StAndrd , PrECISE				
	FAcT	tEMP	OFF, 1K, 2K, 3K, 5K			37	
		dAY.tIM	OFF, dAY, tIME				
Min.WEiG	ON/OFF	ON, OFF			37		
rESet	SUrE?				37		
APPLIC	COUNT	VAr-SPL	ON, OFF			38	
		SPL-qtY	Sq1 ... Sq5				
		Min.reFW	OFF , 97.5%, 99.0%, 99.5%				
		rEF OPT	OFF , AUtO				
		A-SMPL	ON, OFF				
		A.CL-APW	ON, OFF				
		ACCurCY	ON, OFF				
		tOtAL.Ct	bULK , bOth				
	ACCUMUL	Print	COM1, COM2	Lot.PrNt	StdArd , tEMPLt1, tEMPLt2, AUtO.OFF		39
				FIN.PrNt	StdArd , tEMPLt1, tEMPLt2, AUtO.OFF		
			SUMMArY	OFF , ON			
		rEACH Z	ON, OFF				

Level 1	Level 2	Level 3	Level 4	Level 5	Level 6	Page		
	CHECKW	bEEPER	ON, OFF			39		
		SP.tOL-						
		SP.tOL--						
		SEnD.MOd	CONtINU, StAbLE					
		G.PrINt	NO , YES					
	MEMOrY	CONFIg				40		
		CLEAr.M	SUrE?					
	inFO.KEY	INfO 1 ...	Not.USEd, PCS NEt, GrOSS, tArE,			41		
		INfO 13	APW, HIGHrES, ACCurCY,n,G tOtAL, N tOtAL, PCS.tOtL,tArGET,dAtE,timE, HrES ON					
	AVERAGE	OFF , AUtO, MAnuAL			41			
	rESEt	SUrE?			41			
tERMINL	dEVICE	SLEEP	OFF , 1 min, 3 min, 5 min, 15 min, 30 min			42		
		PWr OFF	OFF, 1 min, 3 min , 5 min, 15 min, 30 min					
		b.LIGHT	ON, OFF , 5 sec, 10 sec, 30 sec, 1 min					
		dAtE.tim	dAtE.FOr, dAtE, timE, AM.PM					
		bEEP	ON, OFF					
	ACCESS	SUPErVI			43			
	rESEt	SUrE?			43			
COMMUNI	COM 1/COM 2	MOdE	Print		44			
			A.PrINt					
			CONtINU					
			dIALOG					
			CONt.OLd					
			dIAL.OLd					
			dt-b	GrOSS		ON, OFF		
				tArE		ON, OFF		
				nEt		ON, OFF		
			dt-G	GrOSS		ON, OFF		
				tArE		ON, OFF		
				nEt		ON, OFF		
			CONt-Wt					
			CONt-Ct					
			bArc.rd					

Level 1	Level 2	Level 3	Level 4	Level 5	Level 6	Page
			2nd.dISP			
			rEF			
			bULK			
			AuXILIA			
			InSt.Prn			
		PrINtEr	Type	ASCII, LABEL		45
			tEmPLat	StdArd, tEMPLt1, tEMPLt2		
			ASci.Fmt	LINE.Fmt	MULTI SINGLE FIXEd	
				LENGtH	1 ... 100	
				SEPARAt	, /...	
			Add LF	0 ... 9		
		PARAMet	bAUD	300 ... 38400		45
			PARity	7 nonE, 8 nonE, 7 odd, 8 odd, 7 EVEN , 8 EVEN		
			H.SHAKE	NO, XONXOFF , nEt 422, nEt 485		
			NEt.Addr	0 ... 31		
			ChECsUM	ON, OFF		
			Vcc	ON, OFF		
		rSt.COMx	SURe?			45
COMMUNI	OPtION	EtH.NET	IP.AddrS, SUBnEt, GAtEWAY			46
		USb	USb tEST			46
		diGital	IN 0 ... 3	OFF , ZERo, tArE, Print, CLEAR, rEF 10, rEF n, SCALE, inFO, Unit, tOtAL+, tOtAL-, ...		46
			OUT 0 ... 3	OFF , StAbLE, bEL.Min, AbV.Min, bEL.tOL-, AbV.tOL+, GOOD, UndErLd, OvErLd, StAr, ...		
			SEt.Pt 1			
			SEt.Pt 2			
		ANALOG	Mode	rEF, bULK , AuXILIA, bYPASS		46

Level 1	Level 2	Level 3	Level 4	Level 5	Level 6	Page
	dEF.PrN	tEMPLt1/ tEMPLt2	LINE 1 ... LINE 20	Not .used , HEAdEr, dAtE, timE, Id1, Id2, SCALE.NO, GrOSS, tArE, nEt, APW, rEF Ct, PCS, tArGET, dEVIAt, ACC NET, ACC GrS, ACC PCS, ACC Lot, StArLN, CrLF, F FEEd, ...		47
DIAGNOS	tEst SC	intErN/ExtErN				48
	KboArđ					
	dISPLAY					
	SNr					
	SNr2					
	LiSt					
	LiSt2					
	LiSt.M					
	WOrK.tim	time	SHOW.tIM			
		WEIGH	SHOW.WGH			
rESet.AL	SUrE?					





4.3 Scale settings (SCALE)

4.3.1 SCALE1/SCALE2 – Selecting scale

This menu item only appears if an analog second scale or a weighing platform is connected.

4.3.2 CAL – calibration (adjustment)

This menu item is not available for certified scales without internal calibration weight.

Internal	<p>For scales with an internal calibration weight:</p> <ol style="list-style-type: none"> 1. Unload scale. 2. Activate menu item CAL with . The scale calibrates with the internal calibration weight. -Int CAL- appears in the display. After calibration is completed, -donE- appears briefly in the display, and the scale automatically changes to the next point of the scale menu.
External	<p>For scales without an internal calibration weight:</p> <ol style="list-style-type: none"> 1. Unload scale. 2. Activate menu item CAL with . The scale determines the zero point. -0- appears in the display. The calibration weight to be placed on the scale then flashes in the display. 3. If necessary, change the weight value displayed with . 4. Place the calibration weight on the scale and confirm with . <p>The scale calibrates with the calibration weight loaded. After calibration is completed, -donE- appears briefly in the display, and the scale automatically changes to the next point of the scale menu.</p>

4.3.3 DISPLAY – weighing unit and display accuracy

UNIt1	Select weighing unit 1: g, kg, oz, lb, t
UNIt2	Select weighing unit 2: g, kg, oz, lb, t
rESOLU	Select readability (resolution), model-dependent
UNT . rOLL	When UNT . rOLL is switched on, the weight value can be displayed in all available units and as pieces with  .
Notes	<ul style="list-style-type: none"> • In the case of certified scales individual sub-items of the dISPLAY menu item may not be available or only to a limited extent, depending on the respective country. • On dual-range/dual interval scales, resolutions marked with <-> 1/2 are divided up into 2 weighing ranges/intervals, e.g. 2 x 3000 d.

4.3.4 TARE – tare function

A-tArE	Switching on/off automatic taring
CHAIIn.tr	Switching on/off chain tare
A.CL-tr	Switching on/off automatic clearing of the tare weight when the load is removed from scale Possible settings: OFF, ON, 9d

4.3.5 ZERO – automatic zero update

AZM	On certified scales, this menu item does not appear. Switching on/off automatic zero update and selecting zeroing range. Possible settings: OFF; 0.5 d; 1 d; 2 d; 5 d; 10 d
------------	---

4.3.6 RESTART – automatic saving of zero point and tare value



ON/OFF	When the Restart function is activated, the last zero point and tare value are saved. After switching off / on or after a power interruption, the device continues to work with the saved zero point and tare value.
---------------	--

4.3.7 FILTER – adaptation to the ambient conditions and the weighing type

VibrAt LOW MED HIGH	Adaptation to the ambient conditions <ul style="list-style-type: none"> • Very steady and stable environment. The scale works very quickly, but is very sensitive to external influences. • Normal environment. The scale operates at medium speed. • Restless environment. The scale works more slowly, but is insensitive to external influences.
PrOCeSS UNIVER dOSING	Adaptation to the weighing process <ul style="list-style-type: none"> • Universal setting for all weighing samples and normal weighing goods • Dispensing liquid or powdery weighing samples
StAbILI FAST StAndrd PrECISE	Adjusting the stability detection <ul style="list-style-type: none"> • The scale operates very fast. • The scale operates at medium speed. • The scale operates with the greatest possible reproducibility. <p>The slower the scale works, the greater the reproducibility of the weighing results.</p>

4.3.8 FACT – automatic temperature-dependent adjustment

This menu item appears only on scales with an internal calibration weight.



tEMP OFF 1K/2K/3K/5K	Defining the temperature difference for automatic calibration <ul style="list-style-type: none"> • Switching off automatic calibration in the case of a temperature difference • Automatic calibration in the case of a temperature change of 1 K, 2 K, 3 K or 5 K since the last adjustment
dAY . tIM dAY tIME1...3	Defining up to 7 days of the week and up to 3 times for automatic adjustment. <ul style="list-style-type: none"> • Select day of the week for the adjustment. 7 zeros appear in the display after pressing the key  . The first zero stands for Monday, the second for Tuesday, the third for Wednesday etc. <p>→ Use the key  to go to the desired day of the week and enter 1.</p> The display 0100100 means that Tuesday and Friday are selected as calibration days. <p>→ Press .</p> tIME1 appears in the display. <ul style="list-style-type: none"> • Enter the time(s) for the calibration (hours, minutes).
Note	The format for entering the time (EU or US) depends on the settings in the menu item TERMINAL-> Device, see section 4.5.1.

4.3.9 MIN.WEIG – minimum weight

This menu item appears only if the service technician has saved a minimum weight.

ON/OFF	Switching minimum weight function on/off If the weight on the scale falls below the stored minimum weight, an * appears on the display in front of the weight indicator.
---------------	---

4.3.10 RESET – resetting scale settings to factory settings

SURE?	Confirmation inquiry <ul style="list-style-type: none"> • Reset the scale settings to factory settings with  • Do not reset scale settings with 
--------------	--

4.4 Application settings (APPLICATION)

4.4.1 COUNT – settings for counting

Var-SPL ON OFF	Adaptation of the reference quantity <ul style="list-style-type: none"> The reference quantity can be changed in operating mode Counting only with defined reference quantities
SPL-qtY Sq1 ... Sq5	Reference quantity <ul style="list-style-type: none"> Define 5 fixed reference quantities
Min.reFW OFF 97.5, 99.0, 99.5	Monitoring the minimum reference weight <ul style="list-style-type: none"> No monitoring of the minimum reference weight Monitoring the minimum reference weight so that a counting accuracy of 97.5 %, 99.0 % or 99.5 % is achieved
rEF.Opt OFF AUtO	Optimizing the average piece weight <ul style="list-style-type: none"> No reference optimization Automatic reference optimization
A-SMPL ON OFF	Automatic determination of the average piece weight <ul style="list-style-type: none"> After taring, the average piece weight is determined with the next weight placed on the scale and the displayed reference quantity No automatic determination of the average piece weight
A.CL-APW ON OFF	Automatic clearing of the average piece weight <ul style="list-style-type: none"> When the load is taken off the scale after a counting operation, the average piece weight is automatically cleared. The next counting operation begins with determining the average piece weight again. The average piece weight must be cleared manually by pressing 
ACCurCY ON OFF	Displaying the counting accuracy <ul style="list-style-type: none"> After the average piece weight is determined, the counting accuracy that can be achieved is shown briefly in the display. No counting accuracy display
tOtAl.Ct bULK bOth	Counting on two scales <ul style="list-style-type: none"> Display number of pieces for the parts on the bulk scale only Display number of pieces for all parts on the bulk and the reference scale

4.4.2 ACCUMULATION – totalizing

PrINT COM 1/COM 2 LOt.PrINT FIN.PrINT SUMMArY	Configure printout for accumulation Select interface for the connected printer / computer <ul style="list-style-type: none"> • Printout for each individual item • Printout only at the end of accumulation • Additional printout of the individual items after completion of accumulation
rEACH Z ON OFF	Reach a stable zero point between two items <ul style="list-style-type: none"> • All load must first be removed from the scale before accumulation of the next item is possible • No load removal requested between two items

4.4.3 CHECKWEIGHING

bEEPEr ON OFF	Setting the beep for checkweighing <ul style="list-style-type: none"> • A short beep sounds when the target value is reached • No beep
SP.tOL- SP.tOL--	Limit for activation of the I/O relay box. The value to be entered is the percentage proportion of the lower tolerance of the target weight/target quantity. Checking the SP.Tol-- is carried out with the gross weight, for SP.Tol- with the net weight. SP.Tol- is dependent on SP.Tol--; in other words, if SP.Tol-- has not yet been reached, the SP.Tol- output will not go active. If both setpoints are used, the SP.Tol-- must be less than SP.Tol-. EXAMPLE Target weight: 2000 g tOLER+ : 2010 g tOLER- : 1990 g SP.tOL- : 010 (%) The relay box is not activated until 199 g (= 10 % of 1990 g) is reached.
SEnd.MOD CONtINU StAbLE	Defines the form in which the scale sends information to the I/O relay box <ul style="list-style-type: none"> • Information is permanently sent • Information is only sent if the weight value is stable
G.PrINT YES NO	Good Print <ul style="list-style-type: none"> • Automatic printout, if a stable weight value is present within the tolerances • No automatic printout



4.4.5 INFO-KEY – assignment of the Info key

<p>INFO1</p> <p>NOt .USED</p> <p>PCS NET</p> <p>GrOSS</p> <p>tArE</p> <p>APW</p> <p>HIGHrES</p> <p>ACCURCY</p> <p>n</p> <p>G tOtAL</p> <p>N tOtAL</p> <p>PCS.tOtL</p> <p>tArGEt</p> <p>dAtE</p> <p>timE</p> <p>HrES ON</p>	<p>Up to 13 additional values can be displayed via the key .</p> <ul style="list-style-type: none"> • Info space not occupied • Displays net weight in counting • Displays gross weight • Displays tare weight • Displays average piece weight • Shows display with a higher resolution for a short time • Displays counting accuracy • Displays number of totalized items • Displays gross sum • Displays net sum • Displays sum of pieces • Displays target value and tolerances • Displays date • Displays time • Permanently displaying weight value in higher resolution. Only for non-certified scales. In the case of certified scales, HrES ON behaves like HIGHrES.
<p>INFO2 ... INFO13</p>	<p>As per INFO1</p>

4.4.6 AVERAGE – determining the average weight for an unstable load

<p>OFF</p>	<p>Calculating average weight switched off</p>
<p>AUtO</p>	<p>Calculating average weight with automatic start of the weighing cycle</p>
<p>MAnuAL</p>	<p>Calculating average weight with manual start of the weighing cycle via </p>

4.4.7 RESET – resetting application settings to factory settings





<p>SUrE?</p>	<p>Confirmation inquiry</p> <ul style="list-style-type: none"> • Reset the application settings to factory settings with  • Do not reset the application settings with 
---------------------	---

4.5 Terminal settings (TERMINAL)



4.5.1 DEVICE – Sleep mode, energy-saving mode and display backlighting

SLEEP	<p>This menu item only appears on devices in mains operation.</p> <p>When SLEEP is activated, the scale switches off display and backlighting after the time period set when not in use. The display and backlighting are switched on again at the press of a key or if the weight changes.</p> <p>Possible settings: OFF, 1 min, 3 min, 5 min</p>
Pwr OFF OFF / 1 min / ...	<p>This menu item only appears on devices in battery operation.</p> <p>When Pwr OFF is activated, the device switches itself off automatically after approx. 3 minutes when not in use. Afterwards it has to be switched on using .</p> <p>Possible settings: OFF (switched off), 1 min, 3 min, 5 min, 15 min, 30 min</p>
b.LIGHT OFF / 5 sec / ...	<p>Switching the display backlighting on/off.</p> <p>Setting whether and after which time the background lighting is to be switched off.</p> <p>Scales with a storage battery switch the background lighting off automatically by default when no action takes place at the scale for approx. 5 seconds.</p> <p>Possible settings: OFF (switched off), 5 sec, 10 sec, 30 sec, 1 min, ON (switched on)</p>
DAte.tim DAte.FOr DAte tIME AM.PM	<p>Setting date and time</p> <ul style="list-style-type: none"> • Select type of date setting: EU or US • Enter the date in the selected format • Enter the time • Select AM/PM
bEEP ON OFF	<p>Switching beep on/off</p> <p>Switching on beep on each key press</p> <p>Switching off beep on each key press</p>
Note	This menu item is accessible without a Supervisor password.

4.5.2 ACCESS – password for Supervisor menu access



<p>SUPeRVI</p> <p>ENTeR.C</p> <p>rEtYPE.C</p>	<p>Password entry for Supervisor menu access</p> <p>Request to enter password</p> <p>→ Enter the password and confirm with </p> <p>Request to repeat the password entry</p> <p>→ Enter the password again and confirm with </p>
<p>Notes</p>	<ul style="list-style-type: none"> • The password can consist of up to 4 characters. • The key  must not be part of the password. It is required for confirming the password. • The key  may only be used in combination with another key. • If you enter an impermissible code or make a typing error in the repetition, COdE.Err. appears in the display.

4.5.3 RESET – resetting terminal settings to the factory settings

<p>SUre?</p>	<p>Confirmation inquiry</p> <ul style="list-style-type: none"> • Reset terminal settings to the factory settings with  • Do not reset the terminal settings with 
---------------------	---

4.6 Configuring interfaces (COMMUNICATION)

4.6.1 COM1/COM2 -> MODE – operating mode of the serial interface

Print	Manual data output to the printer with 
A.Print	Automatic output of stable results to the printer (e.g. for series weighing operations)
CONtINU	Ongoing output of all weight values via the interface
dIALOG	Bi-directional communication via MT-SICS commands, control of the scale via PC
CONt.OLd	As per CONtINU, see above, but with 2 fixed blanks in front of the unit (compatible with Spider 1/2/3)
dIAL.OLd	As per dIALOG, see above, but with 2 fixed blanks in front of the unit (compatible with Spider 1/2/3)
dt-b GROSS tArE nEt	DigiTOL-compatible format. <ul style="list-style-type: none"> • Transfer of the gross weight, identified with "B" • Transfer of the tare weight • Transfer of the net weight
dt-G	As per dt-b, see above, gross weight identified with "G"
Cont-Wt	TOLEDO Continuous mode
Cont-Ct	TOLEDO Continuous mode, transfer of the number of pieces
bArc.rd	For connecting a serial barcode reader for reading in from ID1 and ID2 and interface commands (automatically activates the 5 V power supply on pin 9)
2nd.dISP	For connecting a second display (automatically activates the 5-V voltage supply at Pin 9)
rEF	Data transfer from the reference scale (automatic switchover)
bULK	Data transfer from the quantity scale (automatic switchover)
AuXILIA	Data transfer from the reference or quantity scale (manual switchover)
InSt.Prn	Immediate manual data output to the printer with  (not certifiable)

4.6.2 COM1/COM2 -> PRINTER – settings for protocol printout



This menu item only appears if the mode "Print" or "A.Print" is selected.

tYPE ASCII LabEL	Select the printer type <ul style="list-style-type: none"> • ASCII printer, e.g. Sprinter 1 • Label printer, capable of printing graphics
tEmPLat StdArd tEmPLt1 tEmPLt2	Selecting protocol printout <ul style="list-style-type: none"> • Standard printout • Printout in accordance with Template 1 • Printout in accordance with Template 2
ASci.Fmt LINE.Fmt LENGtH SEPArAt Add LF	Selecting formats for the protocol printout <ul style="list-style-type: none"> • Line format: MULtI (multi-line), SINGLE (single-line) or FIXEd • Line length: 0 ... 100 characters, appears only with line format MULtI or FIXEd • Separator: ; , . / \ _ and space; appears only with line format SINGLE • Line feed: 0 ... 9

4.6.3 COM1/COM2 -> PARAMET – communication parameter











bAUd	Selecting baud rate: 300, 600, 1200, 2400, 4800, 9600, 19200, 38400 baud
PArity	Selecting parity: 7 none, 8 none, 7 odd, 8 odd, 7 even, 8 even
H.SHAKE	Select handshake: NO, XONXOFF, NET 422 (network operation via the optional RS422/RS485 interface via 4-wire bus, only for COM1), NET 485 (network operation via the optional RS422/RS485 interface via 2-wire bus, only for COM1)
NET.Addr	Assigning network address: 0 ... 31, only for NET 485
ChECsUM	Activating checksum byte (appears only in TOLEDO Continuous mode)
Vcc	Switching 5V voltage, e.g. for a bar code reader, on / off

4.6.4 COM1/COM2 -> RESET COM1/RESET COM2 – resetting serial interface to factory settings

SUR?	Confirmation inquiry <ul style="list-style-type: none"> • Reset interface settings to factory settings with  • Do not reset the interface settings with 
-------------	---

4.6.5 OPTION – configuring options

If no option is installed or is not yet configured, N.A. appears in the display.

Eth.NET IP.AddrS SUBNET GAtEWAY	Configuration of the Ethernet interface <ul style="list-style-type: none"> • Enter IP address • Enter Subnet address • Enter Gateway address
USB USb TEST	Configuration of the USB interface <ul style="list-style-type: none"> • Test of the USB interface. After the test has been passed, rEAdY appears in the display.
diGital IN 0 ... 3 OFF ZErO tArE PriNt CLEar rEF 10 rEF n SCALE inFO UNIt totAL+ totAL- StArt OUT 0 ... 3 OFF StAbLE bEL.MIN AbV.MIN bEL.tOL- AbV.tOL+ GOOd UNdErLd OVerLd StAr	Configuration of the digital inputs/outputs Configuring inputs 0 ... 3 <ul style="list-style-type: none"> • Input not assigned • Key  • Key  • Key  • Key  • Key  • Key  • Key  • Key  • Key  • Key  , short press of key • Key  , long press of key • External key to start the filling application • Configuring outputs 0 ... 3 • Output not assigned • Stable weight value • Minimum weight not reached • Minimum weight reached or exceeded • Tolerance not reached • Tolerance exceeded • Weight within the tolerance • Insufficient load • Overload • Changed/calculated value



SP.tOL-	• Switching point on, until SP.tOL- is reached (or exceeded)
SP.tOL--	• Switching point on, until SP.tOL-- is reached (or exceeded)
tARGEt	• Target value reached
bEL.SP1	• Setpoint 1 not reached
AbV.SP1	• Setpoint 1 reached or exceeded
bEL.SP2	• Setpoint 2 not reached
AbV.SP2	• Setpoint 2 reached or exceeded
SEt.Pt1	Enter value for setpoint 1
SEt.Pt2	Enter value for setpoint 2
ANALOG	Configuration of the analog second scale interface
Mode	Operating mode of the second scale
rEF	• Second scale can only be used to determine the average piece weight
bULK	• Second scale can only be used as bulk scale
AuXILIA	• No difference between reference and bulk scale, all functions available on the scale selected
BYPASS	• Second scale interface not assigned



4.6.6 DEF.PRN – configuring templates

tEMPLt1/tEMPLt2	Selecting Template 1 or Template 2
LINE 1 ... 20	Select line
NOt.USEd	• Line not used
HEAdEr	• Line as header. The contents of the header must be defined via an interface command, see Section 5.1.
dAtE	• Date
timE	• Time
ID1	• Identification 1
ID2	• Identification 2
SCALE.NO	• Scale number
GROSS	• Gross weight
tArE	• Tare weight
nEt	• Net weight
APW	• Average piece weight
rEF Ct	• Reference quantity
PCS	• Pieces
tArGEt	• Target value
dEVIAt	• Deviation from the target value

ACC.NET	• Totalized net weight
ACC.GrS	• Totalized gross weight
ACC.PCS	• Totalized number of pieces
ACC.LOt	• Totalized no. of items
StARLN	• Line with ***
CrLF	• Line feed (blank line)
F FEEd	• Page feed
tOL-	• Lower tolerance
tOL+	• Upper tolerance
ACC tAr	• Tare weights total

4.7 Diagnosis and printing out of the menu settings (DIAGNOS)

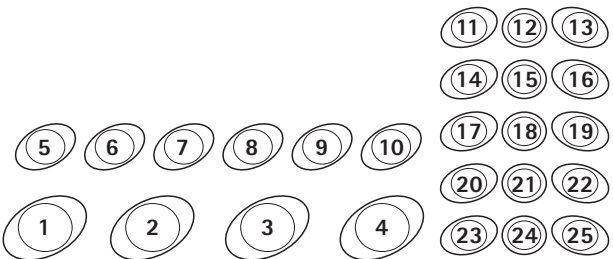
tEST SC	
Internal	<p>Testing scale with internal calibration weight</p> <ul style="list-style-type: none"> • -Int CAL- appears in the display during the test. • After completion of the test, ideally *d=0.0g briefly appears in the display, after which the scale changes to the next menu item KboArđ.
External	<p>Testing scale with external calibration weight</p> <ol style="list-style-type: none"> 1. The scale checks the zero point. -0- appears in the display. The test weight flashes in the display. 2. If necessary, change the weight value displayed with . 3. Put the calibration weight on the scale and confirm with . 4. The scale checks the calibration weight put on them. 5. After the test is completed, the deviation from the last calibration briefly appears in the display, ideally *d=0.0g, after which the scale changes to the next menu item KboArđ.

<p>KboArđ</p> <p>PUSH 1 . . . 25</p>	<p>Keyboard test</p> <ul style="list-style-type: none"> Press the keys in the following order:  <p>If the key works, the scale changes to the next key.</p> <p>Note You cannot abort the keyboard test! If you have selected the menu item KboArđ, you must press all keys.</p>
<p>dISPLAY</p>	<p>Display test: The scale displays all functioning segments</p>
<p>SNr</p>	<p>Display of the serial number</p>
<p>SNr2</p>	<p>Display of the serial number of scale 2. This menu item only appears if an analog second scale is connected.</p>
<p>LiSt</p>	<p>Printout of a list of all menu settings</p>
<p>LiSt2</p>	<p>Printout of a list of all menu settings of scale 2. This menu item only appears if an analog second scale is connected.</p>
<p>LiSt.M</p>	<p>Printout of a list of all values and settings in the memory</p>
<p>WOrK.tim</p> <p>timE</p> <p>SHOW.tim</p> <p>WEIGH</p> <p>SHOW.WGH</p>	<p>Display of the operating time of the scale and the number of weighing operations performed</p> <ul style="list-style-type: none"> Operating time in hours, e.g. 56 h Number of weighing operations, e. g. 135
<p>rESEt.AL</p> <p>SUrE?</p>	<p>Resetting all menu settings to the factory settings</p> <p>Confirmation inquiry</p> <ul style="list-style-type: none"> Reset all menu settings to the factory settings with  Do not reset the menu settings with 

5 Interface description

5.1 SICS interface commands

The compact scales BBA442 / BBK442 support the command set MT-SICS (METTLER TOLEDO **S**tandard **I**nterface **C**ommand **S**et). With SICS commands, it is possible to configure, query and operate the scales from a PC. SICS commands are divided up into various levels.

5.1.1 Available SICS commands

	Command	Meaning
LEVEL 0	@	Reset the scale
	I0	Inquiry of all available SICS commands
	I1	Inquiry of SICS level and SICS versions
	I2	Inquiry of scale data
	I3	Inquiry of scale software version
	I4	Inquiry of serial number
	I6	Inquiry of weighing parameters
	S	Send stable weight value
	SI	Send weight value immediately
	SIR	Send weight value repeatedly
	Z	Zero the scale
	ZI	Zero immediately
	LEVEL 1	D
DW		Weight display
K		Keyboard check
SR		Send and repeat stable weight value
T		Tare
TA		Tare value
TAC		Clear tare
TI		Tare immediately

In the case of Levels 0 and 1, these are commands which, if implemented, will function identically with all METTLER TOLEDO scales or weighing terminals.

In addition there are also further interface commands which apply either to the entire product series or to the particular application level. This and further information on the MT-SICS command set may be found in the MT-SICS Manual (Order Number 22 01 1 459 or at www.mt.com) or be obtained by request from your METTLER TOLEDO customer service representative.

5.1.2 Requirements for communication between scale and PC

- The scale must be connected to the RS232, RS485, USB or Ethernet interface of a PC with a suitable cable.
- The interface of the scale must be set to "Dialog" mode, see Section 4.6.1.
- A terminal program must be available on the PC, e.g. HyperTerminal.
- The communication parameters baud rate and parity must be set in the terminal program and on the scale to the same values, see Section 4.6.3.

5.1.3 Notes on network operation via the optional interface RS422/485

Up to 32 scales can be networked with the optional RS422/485 interface. In network operation, the scales must be addressed from the computer before commands can be sent and weighing results received.

Address	Hex	ASCII
0	0x30	0
1	0x31	1
2	0x32	2
...
9	0x39	9
10	0x3A	:
11	0x3B	;
...
31	0x4F	O

Description of the steps	Host	Direction	Scale
1. Host addresses the scale, e.g. with the address 3A hex.	<ESC> :	—>	
2. Host sends a SICS command, e.g. SI	SI <CRLF>	—>	
3. The scale confirms receipt of the command and sends the address back		<—	<ESC>:
4. The scale responds to the command and returns control of the bus to the host		<—	S_S__45.02_kg <CRLF>

5.2 TOLEDO Continuous mode

5.2.1 TOLEDO Continuous commands

In TOLEDO Continuous mode the scale supports the following input commands:

Command	Meaning
P	Printing out the current result
T	Taring of the scale
Z	Zero setting of the display
C	Deleting of the current value
S	Determining the reference

5.2.2 Output format in TOLEDO Continuous mode

Weight values are always transferred in TOLEDO Continuous mode in the following format:

1	Status			Field 1						Field 2						17	18
	2	3	4	5	6	7	8	9	10	11	12	13	14	15	16		
STX	SWA	SWB	SWC	MSD	-	-	-	-	LSD	MSD	-	-	-	-	LSD	CR	CHK
Field 1	Cont-Wt: 6 digits for the weight value that is transferred without comma and unit Cont-Ct: 6 characters for the number of pieces, no leading zeros, otherwise 6 blanks																
Field 2	Cont-Wt: 6 digits for the tare weight that is transferred without comma and unit Cont-Ct: 6 zeros																
STX	ASCII character 02 hex, character for "start of text"																
SWA, SWB, SWC	Status words A, B, C, see below																
MSD	Most significant digit																
LSD	Least significant digit																
CR	Carriage Return, ASCII character 0D hex																
CHK	Checksum (2-complement of the binary sum of the 7 lower bits of all the characters sent beforehand incl. STX and CR)																

Status word A								
Function	Selection	Status bit						
		6	5	4	3	2	1	0
Decimal position	X00	0	1			0	0	0
	X0					0	0	1
	X					0	1	0
	0.X					0	1	1
	0.0X					1	0	0
	0.00X					1	0	1
	0.000X					1	1	0
	0.0000X					1	1	1
Numerical increment	X1			0	1			
	X2			1	0			
	X5			1	1			

Status word B	
Function/Value	Bit
Gross/Net: Net = 1	0
Sign: Negative = 1	1
Overload/Underload = 1	2
Movement = 1	3
lb/kg: kg = 1	4
1	5
Power up = 1	6

Status word C				
Function/Value				Bit
kg/lb	g	t	oz	
0	1	0	1	0
0	0	1	1	1
0	0	0	0	2
Print request = 1				3
Extended = 1				4
1				5
Tare manually, only kg = 1				6

6 Event and error messages

Error	Cause	Remedy
Display Dark	<ul style="list-style-type: none"> • Back lighting set too dark • No mains voltage • Unit switched off • Mains cable not plugged in • Brief fault 	<ul style="list-style-type: none"> → Set back lighting (b. LIGHT) brighter → Check mains → Switch on unit → Plug in mains plug → Switch device off and back on again
Insufficient load L _ _ _ _ J	<ul style="list-style-type: none"> • Load plate not on the scale • Weighing range not reached 	<ul style="list-style-type: none"> → Place load plate on the scale → Set to zero
Overload r - - - - 7	<ul style="list-style-type: none"> • Weighing range exceeded 	<ul style="list-style-type: none"> → Unload scale → Reduce preload
- - - - -	<ul style="list-style-type: none"> • Result not yet stable 	<ul style="list-style-type: none"> → If necessary adjust vibration adapter or weigh dynamically
- - n 0 - -	<ul style="list-style-type: none"> • Function not permissible 	<ul style="list-style-type: none"> → Unload scale and set to zero
r - n 0 - 7 L - n 0 - J	<ul style="list-style-type: none"> • Zeroing not possible with overload or insufficient load 	<ul style="list-style-type: none"> → Unload scale
Err 4	<ul style="list-style-type: none"> • Reference weight too low 	<ul style="list-style-type: none"> → Select and place larger number of reference parts on the scale
Err 5	<ul style="list-style-type: none"> • No valid value from the reference scale 	<ul style="list-style-type: none"> → Check cable connection between the units → Check interface settings
Err 6	<ul style="list-style-type: none"> • No calibration 	<ul style="list-style-type: none"> → Unplug the mains plug then plug it back in; switch unit off and then back on in battery mode → Calibrate scale → Call METTLER TOLEDO Service
Err 7	<ul style="list-style-type: none"> • Average piece weight too low 	<ul style="list-style-type: none"> → Counting is not possible on this scale with this average piece weight

Error	Cause	Remedy
Err 9	<ul style="list-style-type: none"> • Unstable weight value when referencing 	<ul style="list-style-type: none"> → Ensure stable surroundings → Ensure that the weighing pan is freely movable → Adjust vibration adapter
Err 14	<ul style="list-style-type: none"> • Impermissible target value or impermissible tolerance 	<ul style="list-style-type: none"> → Repeat input with permissible values
Err 15	<ul style="list-style-type: none"> • Setting the average piece weight impermissible during weight accumulating 	<ul style="list-style-type: none"> → End weight accumulating → Reset average piece weight
Err 16	<ul style="list-style-type: none"> • Switching the weighing unit impermissible during weight accumulating 	<ul style="list-style-type: none"> → End weight accumulating → Switch weighing unit
Err 17	<ul style="list-style-type: none"> • Printout not yet ended 	<ul style="list-style-type: none"> → End printout → Repeat required action
Err 18	<ul style="list-style-type: none"> • Switching the weighing unit impermissible during dynamic weighing 	<ul style="list-style-type: none"> → End dynamic weighing → Switch weighing unit
Err 53	<ul style="list-style-type: none"> • EARAM checksum error 	<ul style="list-style-type: none"> → Unplug the mains plug then plug it back in; switch unit off and then back on in battery mode → Call METTLER TOLEDO Service
Weight display unstable	<ul style="list-style-type: none"> • Restless installation location • Draft • Restless weighing sample • Contact between weighing pan and/or weighing sample and surroundings • Mains fault 	<ul style="list-style-type: none"> → Adjust vibration adapter → Avoid drafts → Dynamic weighing → Remedy contact → Check mains
Incorrect weight display	<ul style="list-style-type: none"> • Incorrect zeroing • Incorrect tare value • Contact between weighing pan and/or weighing sample and surroundings • Scale tilted 	<ul style="list-style-type: none"> → Unload scale, set to zero and repeat weighing operation → Clear tare → Remedy contact → Level scale

7 Technical data and accessories

7.1 Technical data

7.1.1 Type key

The compact scales BBA442 / BBK442 are available with various capacities and platforms that can be seen from the complete type designation.

Example

BBA442 – **0.6 DXXS** compact scale with capacity **0.6 kg** and **round weighing pan**

BBK442 – **3 XS** compact scale with capacity **3 kg** and **extra-small platform**

BBA442 – **6 SM** compact scale with capacity **6 kg** and **small platform**

BBA442 – **35 LA** compact scale with capacity **35 kg** and **large platform**

7.1.2 General data

BBA442 / BBK442	
Applications	<ul style="list-style-type: none"> • Weighing • Dynamic weighing • Counting with fixed or variable reference quantity • Counting with reference and bulk scale • Accumulating • Numerical definition of tare weights, average piece weights and reference quantities • 100 memory locations for tare weights, average piece weights, target weights and target quantities • Checkweighing and weighing-in to target weight/target quantity
Settings	<ul style="list-style-type: none"> • Resolution selectable • Weighing unit selectable: g, kg, oz, lb, t • Taring function: manual, automatic, chain tare • Automatic zero point correction when the scale is switched on and during operation • Filter for adapting to the ambient conditions (vibration adapter) • Filter for adapting to the weighing type, e.g. dispensing (weighing process adapter) • Switch-off function, sleep mode for mains-operated devices, energy-saving mode for battery operation • Display lighting • Add mode for determining the piece weight when counting • Reference optimization • Programmable memories and identifications • Date and time • Signal tone • Graphic display of the weighing range
Accuracy class OIML/NTEP	<ul style="list-style-type: none"> • BBA4.. III • BBK4.. II
Display	<ul style="list-style-type: none"> • LCD (liquid crystal display), digits 21 mm high, with back lighting
Keypad	<ul style="list-style-type: none"> • Pressure point membrane keypad • Scratch-proof labeling
Housing	<ul style="list-style-type: none"> • Diecast aluminum housing; chromium nickel steel weighing pan • Dimensions, see Page 60
Protection Class (IEC 529, DIN 40050, EN60529)	<ul style="list-style-type: none"> • IP43 (not with Ethernet interface)

BBA442 / BBK442	
Mains connection	<p>Direct connection to the mains (MAINS supply voltage fluctuations up to $\pm 10\%$ of the nominal voltage):</p> <ul style="list-style-type: none"> • 230 V, 50 Hz, 70 mA • 240 V, 50 Hz, 70 mA • 120 V, 60 Hz, 90 mA • 100 V, 50/60 Hz, 90 mA <p>For battery operation:</p> <ul style="list-style-type: none"> • Connection via mains adapter: 90 – 264 V, 47 – 63 Hz, 300 mA • Infeed on the unit: 24 V, 1.3 A
Battery operation	If the voltage supply is interrupted, the unit automatically switches over to battery operation
Ambient conditions	<ul style="list-style-type: none"> • Use Indoor use only • Altitude up to 2000 m • Temperature range BBA4.. $-10 \dots +40 \text{ }^\circ\text{C} / 14 \dots 104 \text{ }^\circ\text{F}$ • Temperature range BBK4.. $+10 \dots +30 \text{ }^\circ\text{C} / 50 \dots 86 \text{ }^\circ\text{F}$ • Installation/overvoltage category II • Pollution degree 2 • Relative humidity Maximum relative humidity 80 % for temperatures up to $31 \text{ }^\circ\text{C} / 88 \text{ }^\circ\text{F}$, decreasing linearly to 50 % relative humidity at $40 \text{ }^\circ\text{C} / 104 \text{ }^\circ\text{F}$
Interfaces	<ul style="list-style-type: none"> • 1 RS232 interface integrated • 1 other optional interface possible
Resolution of the analog second scale interface	<ul style="list-style-type: none"> • 300000 points in noncertified configuration • 1 x 7500 points resp. 2 x 5000 points (multi range / multi interval) in certified configuration
Supply of the weighing cell	<ul style="list-style-type: none"> • 8.2 V

7.1.3 Weighing ranges and readability BBA4..

The compact scales BBA4.. with strain gauge weighing cells are supplied in the configuration 2 x 3000 d. Higher legibilities are available from the factory with the optional "Premium" weighing cells.

Capacity	Configuration			
	2 x 3000 d (standard)		1 x 6000 d (with optional "Premium" weighing cells)	
	Weighing ranges	Readability (certified)	Weighing range	Readability (certified)
3 kg	1.5 kg / 3 kg	0.5 g / 1 g	3 kg	0.5 g
6 kg	3 kg / 6 kg	1 g / 2 g	6 kg	1 g
15 kg	6 kg / 15 kg	2 g / 5 g	15 kg	2 g
35 kg	15 kg / 35 kg	5 g / 10 g	35 kg	5 g
60 kg	30 kg / 60 kg	10 g / 20 g	60 kg	10 g

7.1.4 Weighing ranges and readability BBK4..

Configurations up to 1 x 60.000 e are possible with the compact scales BBK4.. with MonoBloc technology. Certified compact scales BBK4.. are supplied as standard with an internal calibration weight.

Model	Weighing interval(s)	Readability d	Verification value e
BBK4.. – 0.6 DXXS	120 g / 610 g	0.001 g / 0.01 g	0.01 g
BBK4.. – 3 DXS	600 g / 3,100 g	0.01 g / 0.1 g	0.1 g
BBK4.. – 3 XS	3,100 g	0.01	0.1 g
BBK4.. – 6 DXS	1,200 g / 6,100 g	0.01 g / 0.1 g	0.1 g
BBK4.. – 6 XS	6,100 g	0.01	0.1 g
BBK4.. – 6 DSM	1,200 g / 6,100 g	0.1 g / 1 g	1 g
BBK4.. – 6 SM	6,100 g	0.2 g	0.2 g
BBK4.. – 15 DLA	3,500 g / 15,100 g	0.1 g / 1 g	1 g
BBK4.. – 15 LA	15,100 g	0.5 g	0.5 g
BBK4.. – 35 DLA	7,000 g / 35,100 g	0.1 g / 1 g	1 g
BBK4.. – 35 LA	35,100 g	0.1 g	1 g

7.1.5 Dimensions

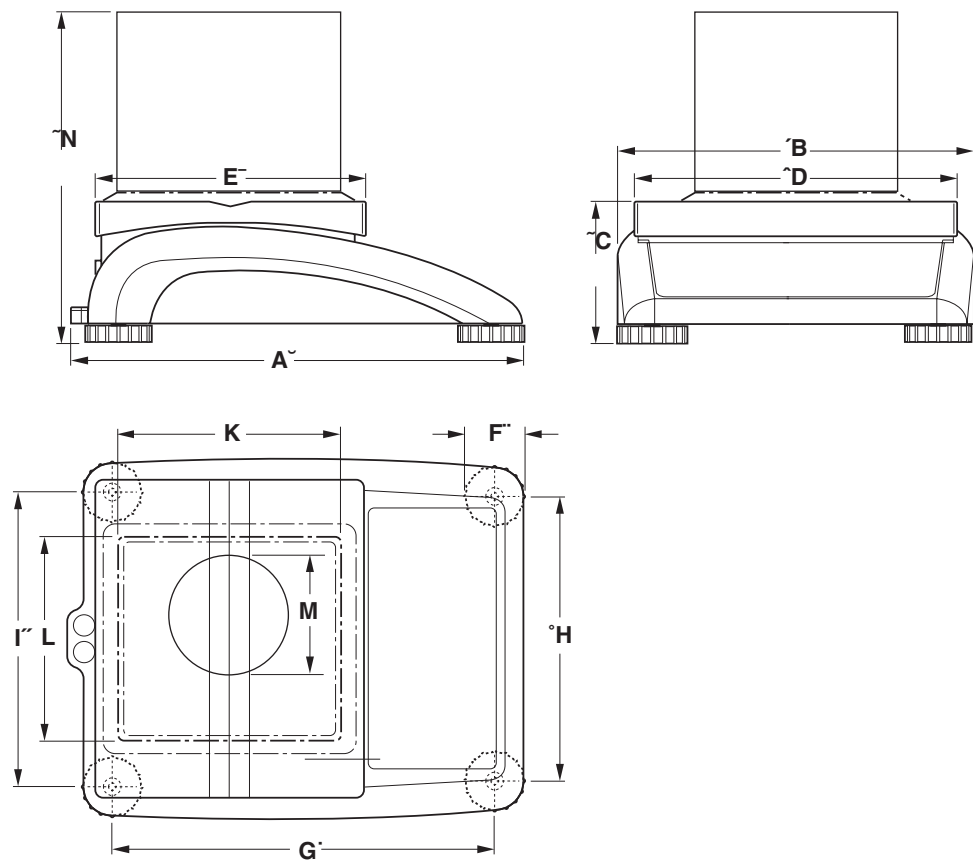

	A	B	C	D	E	F	G	H	I	K	L	M	N
XXS ¹⁾	335	265	100	240	200	46	276	208	216	165	165	100	260
XS ¹⁾	335	265	100	240	200	46	276	208	216	165	165	–	–
SM ¹⁾	335	265	100	240	200	46	276	208	216	–	–	–	–
LA ¹⁾	370	360	115	350	240	52	310	304	310	–	–	–	–

¹⁾ dimensions in mm

7.1.6 Net weights

Model	without battery	with battery	with internal calibration weight (without battery)
BBA4.. – .. SM	4.6 kg	5.3 kg	–
BBA4.. – .. LA	8.2 kg	8.9 kg	–
BBK4.. – .. XXS	–	–	6.1 kg
BBK4.. – .. XS	4.9 kg	5.6 kg	5.4 kg
BBK4.. – .. SM	4.7 kg	5.4 kg	5.2 kg
BBK4.. – .. LA	10.5 kg	11.2 kg	11.7 kg

7.1.7 Interface connections

The compact scale can be fitted with a maximum of 2 interfaces. The following combinations are possible:

COM1	COM2	Note
RS232	–	
RS232	RS232	
RS485	RS232	COM1 can be optionally operated as RS422 or RS485
RS232	Ethernet	10BaseT, RJ45
RS232	USB	USB 1.1, Type B
RS232	Digital I/O	4 x in, 4 x out, D-Sub 9
RS232	Analog second scale interface	

7.1.8 Assignment of the interface connections

Pin	RS232 (COM1/ COM2)	RS422 (4-wire, COM1)	RS485 (2-wire, COM1)	Digital I/O (COM2)	Analog Interface
1	–	–	–	GND	+ Excitation (+8.2 VDC)
2	TxD1/2	TxD1–	TxD1–/RxD1–	OUT0	+ Sense
3	RxD1/2	RxD1–	–	OUT1	Shield
4	–	–	–	OUT2	– Sense
5	GND	GND	GND	OUT3	– Excitation (GND)
6	–	–	–	INO	–
7	–	TxD1+	TxD1+/RxD1+	IN1	+ Signal
8	–	RxD1+	–	IN2	– Signal
9	VCC	VCC	VCC	IN3	–

7.2 Accessories

Designation	Order number
Protective cover for small model	21 203 207
Protective cover for large model	21 203 206
Second display RS-PD/PASM	21 302 875
Second display ADI412	22 013 978
Second display ADI412-B, with backlighting	22 013 977
Relay box 4 for connection to digital I/O interface	22 011 967
Connection cable for relay box 4, length approx. 1.5 m	21 254 225
Printer Sprinter 1 Euro version	21 253 399
Printer Sprinter 1 UK version	21 253 745
Anti-theft device	00 229 175
RS232 cable for printer Sprinter 1, 1.8 m long	21 253 677
RS232 cable for second scale, 1.8 m long	21 252 588
RS232 cable for PC, 1.8 m long	00 410 024
Glass windshield for BBK4...-(X)XS	00 225 269
Adapter plate for glass windshield for BBK4...XS	22 011 304
Special load plate 186 x 186 mm for BBK4...XS	22 013 451
Counting tweezers for BBK4...0.6 DXXS, stainless steel, anti-magnetic	22 018 833

8 Appendix

8.1 Information for certified scales in EC countries



Weighing instruments verified at the place of manufacture bear the preceding mark on the packing label and green "M" sticker on the descriptive plate. They may be set to work immediately.



Weighing instruments which are verified in two steps have no green "M" on the descriptive plate and bear the preceding identification mark on the packing label. The second step of the verification must be carried out by the approved METTLER TOLEDO Service or by the W&M authorities. Please contact METTLER TOLEDO Customer Service.

The first calibration step of the verification has been carried out at the manufacturing plant. It comprises all tests according to EN45501-8.2.2. Scales with analog connection to the weighing platform require an additional test according to EN45501-3.5.3.3. However, this test is not mandatory if the terminal bears the same serial number as the weighing platform.

If national regulations in individual countries limit the period of validity of the certification, the operator of such a scale is himself responsible for its timely re-certification.

8.2 Safety checks

The compact scales of the series BBA442 / BBK442 have been checked by accredited testing institutions. They have passed the safety checks listed below and carry the relevant test symbols. Production is subject to production monitoring by the inspection offices.

Country	Test symbol	Standard
Canada USA		CAN/CSA-C22.2 No. 1010.1-92 UL Std. No. 61010A-1
Other countries	CB Scheme (no identification)	IEC/EN61010-1:2001

8.3 Table of Geo Values

For weighing instruments verified at the manufacturer's, the geo value indicates the country or geographical zone for which the instrument is verified. The geo value set in the instrument (e.g. "Geo 18") appears briefly after switch-on or is specified on a label.

Table **GEO VALUES 3000e** shows the geo values for European countries.

Table **GEO VALUES 6000e/7500e** shows the geo values for different gravitation zones.

8.3.1 GEO VALUES 3000e, OIML Class III (European Countries)

Geographical latitude	Geo value	Country
46°22' – 49°01'	18	Austria
49°30' – 51°30'	21	Belgium
41°41' – 44°13'	16	Bulgaria
42°24' – 46°32'	18	Croatia
48°34' – 51°03'	20	Czechia
54°34' – 57°45'	23	Denmark
57°30' – 59°40'	24	Estonia
59°48' – 64°00'	25*	Finland
64°00' – 70°05'	26	
41°20' – 45°00'	17	France
45°00' – 51°00'	19*	
47°00' – 55°00'	20	Germany
34°48' – 41°45'	15	Greece
45°45' – 48°35'	19	Hungary
63°17' – 67°09'	26	Iceland
51°05' – 55°05'	22	Ireland
35°47' – 47°05'	17	Italy
55°30' – 58°04'	23	Latvia
47°03' – 47°14'	18	Liechtenstein
53°54' – 56°24'	22	Lithuania
49°27' – 50°11'	20	Luxemburg
50°46' – 53°32'	21	Netherlands
57°57' – 64°00'	24*	Norway
64°00' – 71°11'	26	
49°00' – 54°30'	21	Poland
36°58' – 42°10'	15	Portugal
43°37' – 48°15'	18	Romania

Geographical latitude	Geo value	Country
47°44' – 49°46'	19	Slovakia
45°26' – 46°35'	18	Slovenia
36°00' – 43°47'	15	Spain
55°20' – 62°00'	24*	Sweden
62°00' – 69°04'	26	
45°49' – 47°49'	18	Switzerland
35°51' – 42°06'	16	Turkey
49°00' – 55°00'	21*	United Kingdom
55°00' – 62°00'	23	

* factory setting

8.3.2 GEO VALUES 6000e/7500e OIML Class III (Height \leq 1000 m)

Geographical latitude	Geo value
00°00' – 12°44'	5
05°46' – 17°10'	6
12°44' – 20°45'	7
17°10' – 23°54'	8
20°45' – 26°45'	9
23°54' – 29°25'	10
26°45' – 31°56'	11
29°25' – 34°21'	12
31°56' – 36°41'	13
34°21' – 38°58'	14
36°41' – 41°12'	15
38°58' – 43°26'	16
41°12' – 45°38'	17
43°26' – 47°51'	18
45°38' – 50°06'	19
47°51' – 52°22'	20
50°06' – 54°41'	21
52°22' – 57°04'	22
54°41' – 59°32'	23
57°04' – 62°09'	24
59°32' – 64°55'	25
62°09' – 67°57'	26
64°55' – 71°21'	27
67°57' – 75°24'	28
71°21' – 80°56'	29
75°24' – 90°00'	30

9 Index

A		M		S	
Accessories	62	Mains connection.....	58	Safety checks	63
Adjustment	35	Memory	40	Scales types.....	6
Alignment	10	Menu		Settings	57
Ambient conditions	58	Application	38	SICS commands.....	50
Applications.....	57	Communication	44	Supervisor menu	29
Auxiliary scale.....	28	Diagnosis	48	Switching off	12
Average.....	15, 41	Operation	29	Switching on	12
Average piece weight	24	Overview	31		
		Scale	35	T	
C		Terminal	42	Tare	
Calibrate.....	35	Menu structure.....	30	Automatic	13
Capacity utilisation	15	Minimum accuracy	23	Chain tare.....	15
Chain tare.....	15			Clear	13
Checkweighing.....	16	O		Tare weight	
Configure memory	40	Operator menu.....	29	Call up	14
Continuous mode	52	Options.....	6, 46	call up.....	14
Counting parts	22			Clear	14
		P		Enter	13
D		Password.....	29	Save	14
Dimensions	60	Power supply	10	Target quantity	26
Display	8	Protocol	18	Target weight	16
Display accuracy.....	35			Call up	17
Dynamic weighing.....	15, 41	Q		Clear	17
		Quantity scales	28	Save	16
E				Terminal settings	42
Error messages	54	R		TOLEDO Continuous.....	52
		Readability	59	Totalising.....	20
F		Reference determination,		Two scales	19, 27
Filter	36	automatic.....	24	Type key	56
		Reference optimisation.....	24		
I		Reference quantity.....	23	W	
Identification	18	Reference scales	27	Weighing ranges	59
Info button	19	Reset		Weighing unit.....	35
Interface protocol.....	52	Application	41	Weighing-in	17
Interfaces		Interface	45	Weight	60
Configure.....	44	Scale	37		
Connections.....	61	Terminal	43	Z	
		RS422/RS485	51	Zeroing	12
K					
Keyboard.....	9				



22011391B

Subject to technical changes © Mettler-Toledo (Albstadt) GmbH 05/08 Printed in Germany 22011391B

Mettler-Toledo (Albstadt) GmbH

D-72458 Albstadt

Tel. ++49-7431-14 0, Fax ++49-7431-14 232

Internet: <http://www.mt.com>