

METTLER TOLEDO

Operating Instructions
METTLER TOLEDO
Viper EX SW weighing scale

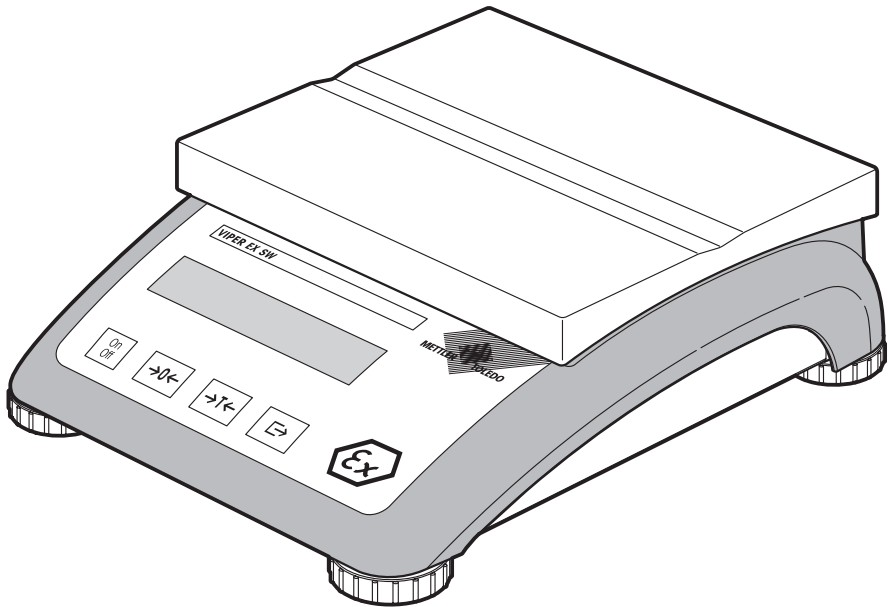

Overview

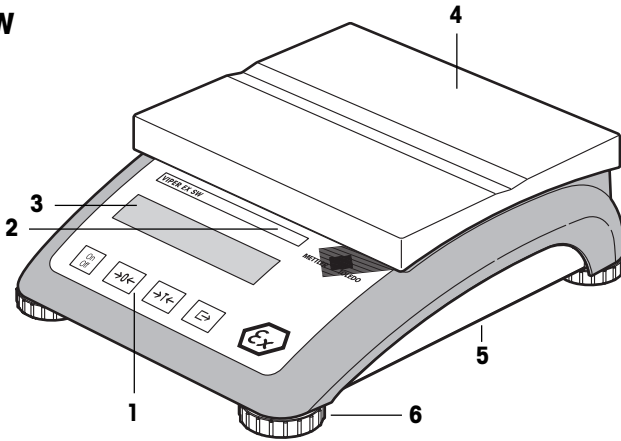

Rear of scale

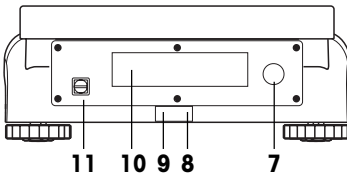

Scale specifications (example)

12	13	14	15
Max1: 3kg	Min1: 20g	e1: 1g	d1: 1g
Max2: 6kg	Min2: 40g	e2: 2g	d2: 2g

Display



- | | |
|--|---|
| <ul style="list-style-type: none"> 1 keypad 2 scale specifications 3 display 4 weighing pan 5 adhesive label for MonoBloc version 6 adjustable feet 7 opening for cable gland <ul style="list-style-type: none"> – power cable from PSUx power unit – power/data cable from PSU power unit 8 spirit level (only on certified scales and those with MonoBloc weighing cells) 9 hole for antitheft device 10 model plate 11 grounding screw | <ul style="list-style-type: none"> 12 maximum loads (ranges 1/2) 13 minimum loads (ranges 1/2) 14 verification scale interval (certified scale) (ranges 1/2) 15 max. resolutions (ranges 1/2) 16 dynamic weighing symbol 17 net symbol when weighing with tare 18 weighing unit 19 stability detector 20 changed resolution (only certified scales) 21 certification brackets (certified scales $e=10d$) 22 active interface (for master mode) 23 weighing range display 24 battery discharge status (has no function) |
|--|---|

Contents

1	Putting into service	4
1.1	Unpacking and checking contents	4
1.2	Safety and environmental protection	4
1.3	Positioning and leveling the scale	5
1.4	Connecting the power supply and grounding cable	6
2	Weighing	7
2.1	Switching on and off and zeroing	7
2.2	Simple weighing	7
2.3	Weighing with tare	7
2.4	Recording weighing results	8
2.5	Special functions (master mode)	8
3	Master mode	9
3.1	Overview and operation	9
3.2	Scale calibration (adjustment)	9
3.3	Scale settings	10
3.4	Interface configuration	11
3.5	Printing master mode settings	13
3.6	Saving settings and exiting master mode	13
3.7	Making a typical setting in master mode	13
4	Other important information	14
4.1	Error messages	14
4.2	Cleaning instructions	14
4.3	Declaration of conformity	15
4.4	Technical data	16
4.5	Accessories	18
4.6	Interface commands	18

7

Putting into service

Please read through these operating instructions carefully and adhere to them at all times. If you discover that materials are missing or that the wrong ones have been supplied, or if you have any other problems with your scale, please refer to the dealer or salesperson concerned, or if necessary to the METTLER TOLEDO representative responsible.

1.1 Unpacking and checking contents

- Remove the scale and accessories from the packaging.
- Check for completeness. The basic scope of supply comprises:
 - scale
 - weighing pan
 - operating instructions (this booklet)
 - any special accessories as per packing list
 - a PSUx power supply unit or PSU power supply unit/interface which forms an integral part of the equipment but is delivered in a separate package

1.2 Safety and environmental protection



- The scale is designed for operation in **hazardous areas of Zone 1, Zone 2, and Zone 22**. However, for this purpose the scale **must be connected to a certified METTLER TOLEDO power supply unit**:
 - PSUx power supply unit (if not using the data interface)
 - PSU power supply unit (if using the data interface)**The installation instructions for the respective power supply unit must always be observed and followed.**
- The **regulations for operating equipment in hazardous areas** must always be observed and followed.
- The scale must never be flooded or immersed in liquid, or used in environments with a danger of corrosion.
- The scale must be regularly cleaned with suitable materials.
- Never tamper with the **retaining screws for the load plate support** underneath the weighing pan.
- When the weighing pan is removed, **never insert a solid object underneath the load plate support**.



- It is not permitted to open the scale by removing the **screws in its base**.
- Only use **approved accessories and peripherals**.
- Handle the scale **carefully**; it is a precision instrument. Blows on the weighing pan must be avoided, and heavy overloads must not be placed on it.
- Important instructions when using Viper scales in the **food sector**: those parts of the scale can come into contact with food products have smooth surfaces and are easy to clean. The materials used do not splinter and are free from contaminants. Because of the danger of static charge, **a protective cover may only be used** if it is made from **anti-static material**.
- When the scale is finally **taken out of service**, observe the current environmental regulations.

1.3 Positioning and leveling the scale

The correct location is a decisive factor in ensuring accurate weighing results.

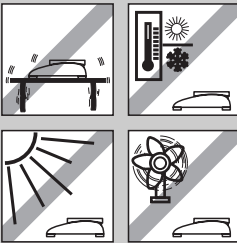

- Choose a stable and vibration-free location (particularly important for high-resolution scales using Mettler Toledo MonoBloc technology). Place the scale on a surface that is as horizontal as possible and strong enough to bear its weight when fully loaded.
- Check the ambient conditions (Section 4.4).
- Avoid:
 - direct sunlight
 - strong drafts (e.g. from fans or air conditioning systems)
 - excessive temperature fluctuations.
 - the use of radio equipment in close proximity to the scale.

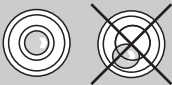

- Turn the adjustable feet so that the scale is horizontal. If a spirit level is fitted, the bubble must be located within the inner circle.

Major changes in geographical location:

Every scale is set by the manufacturer to suit the local gravitational conditions (geographical adjustment value) in the geographical zone to which the instrument is supplied. If a major change of geographical location takes place, this setting must be adjusted by a service technician or a new setting made. Certified scales must in addition be recalibrated in accordance with national certification regulations.

1.4 Connecting the power supply and grounding cable

To ensure protection against explosions, the scale may only be operated with either the PSUX or PSU power supply unit, and must be connected to the building ground by a cable with a cross section of 1–4 mm².

Important: When making the connection, always observe and follow the separate installation instructions for the PSUX or PSU power supply unit respectively.

To connect the cable of the power supply unit and the grounding cable proceed as follows:

- Unscrew the screws in the back plate and remove the back plate.
- Fasten the screwed connector on the blue cable of the power supply unit to the back plate with the locking nut.
- Connect the nine-core cable to the screw terminals of the scale according to the following table.

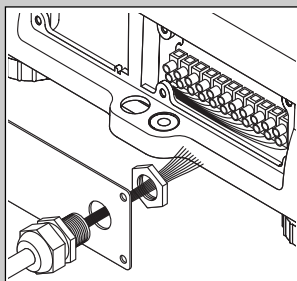

Scale		Power supply unit	
No.	Function	PSUX	PSU
1	U1	white	white
2	GND	yellow	yellow
3	U2	green	green
4	GND	brown	brown
5	U _{b1}	gray	black
6	TXD+	red	red
7	TXD–	blue	blue
8	RXD–	—	pink
9	RXD+	—	gray
10	NC	black	—
11	NC	pink	—

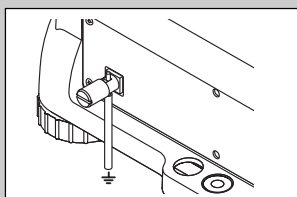

- Replace the back plate and fasten it with the screws. When doing so, take care not to trap any wires.
- Using a cable with a cross section of 1–4 mm² connect the grounding screw on the back of the scale to the building ground. Make sure the grounding cable is correctly connected to the scale and the building ground.

0.000 kg

Powering up the scale initiates a display test in which all the segments and then the software version are briefly displayed. Once the decimal zero appears in the display, the scale is ready to operate.

For maximum possible precision, adjust/calibrate the scale after installing it (Section 3.2). **Note:** Certified scales must be adjusted by an authorized organization. Please consult your dealer.

2

Weighing

This section describes how to switch the scale on and off, zero and tare it, weigh materials and record the results.

2.1 Switching on and off and zeroing

On
Off

0000 kg

→0←

- Briefly pressing the «**On/Off**» key switches the scale on or off.

The scale carries out a display test (Section 1.4). Once the weight display appears, the scale is ready to operate and automatically zeroed.

Note: When necessary, the scale can be zeroed at any time with the «→0←» key.

2.2 Simple weighing

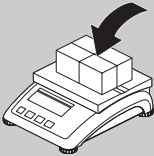

o 2.416 kg

2.420 kg

- Place the object to be weighed on the scale.

- Wait until the stability detector (a small ring in the bottom left corner of the display) disappears, then ...
- ... read the indicated weight.

2.3 Weighing with tare

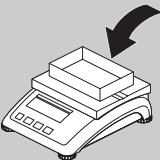

→T←

0000^{NET} kg

- Place the **empty** weighing container or packaging on the scale.

- Press the «→T←» key briefly to tare the scale. The zero display and the "NET" (net weight) symbol appear. **Note:** If the automatic tare function has been activated in master mode (Section 3.3), there is no need to press the «→T←» key.

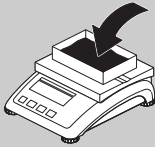

4.2 16^{NET} kg

- Place the material to be weighed in the container, then ...
- ... read the indicated net weight.

2.4 Recording weighing results



- Press the «» key to send the current weighing result to the peripheral device (printer, computer) via the interface. Factory default configures interface 1 for connection to a printer. Please refer to Section 3.4 for instructions on configuring the interface(s).

2.5 Special functions (master mode)

MASTER

In addition to simple weighing functions, the scale also has additional options and settings that can be activated in master mode (Section 3).

3

Master mode

In master mode the scale settings can be changed and the various functions activated – to adapt the scale for individual weighing needs.

3.1 Overview and operation

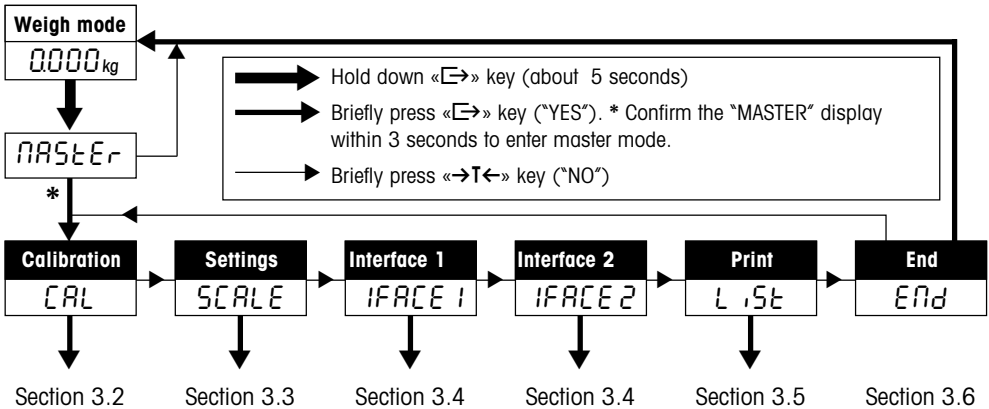

3.2 Scale calibration (adjustment)

CAL



15000

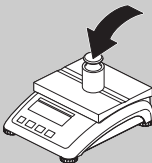

15.000 kg

This master mode block is not available with certified scales.

- Remove the load from the weighing pan and then press the «E» key to start the calibration procedure.
- The flashing display shows the calibration weight. If desired, the «T» key can be used to select other calibration weights.

- Place the indicated calibration weight on the scale and confirm with «E».

Note: The calibration procedure can be canceled at any time with the «On/Off» key.

- Wait until the calibration has been successfully completed (confirmed by the message "done" in the display) and the scale reverts to weighing mode.

3.3 Scale settings

SCALE

The second master mode block contains a total of **11 subblocks** for setting the scale and activating its functions.

Function/Display	Settings	Remarks
Resolution rESo lu	Depends on model, example: 0.01kg/0.02kg/.../0.005g Certified scales: changed settings indicated with "*" and with no weighing unit. After re-start the standard setting (see certification label) is active.	The symbol "l<—>l 1/2" appears when set for 2 weighing ranges: Example: 15 kg scale: 1. Range 0 – 6 kg Resolution 2 g 2. Range 6 – 15 kg Resolution 5 g In order to switch from the 2nd range back to the 1st range, the load must first be removed from the scale or it must be zeroed.
Weighing unit Un t	"g" ¹⁾ , "kg" ¹⁾ , "oz" ¹⁾ , "lb" ¹⁾	Factory setting as per model plate. Not available for certified scales.
Automatic zero correction A-ZEro	On ¹⁾ Off	Corrects the scale zero automatically. Not available for certified scales.
Automatic tare function A-tArE	On Off ¹⁾	Tares the scale automatically as soon as the empty weighing container is placed on the pan ("T" flashes in the display).
Automatic shutoff PIrOFF	On ("Yes") Off ("No") ¹⁾	If function is activated ("Yes" = factory setting for scales with battery), the scale switches off automatically after some 3 minutes of inactivity.
Backlighting b.LiGht	On ¹⁾ Off	
Auto memory function rEStArE	On Off ¹⁾	Last tare and zero are saved when scale switched off. Not available for certified scales.
	¹⁾ factory setting	(continued on next page)

Function/Display	Settings	Remarks
Vibration adapter <div style="border: 1px solid black; padding: 2px; display: inline-block;">U i b r A t</div>	"Med" ¹⁾ "Low" "High"	normal environment very tranquil environment (immediate stop for display) high vibration levels
Weighing process adapter <div style="border: 1px solid black; padding: 2px; display: inline-block;">P r o c E S</div>	"Univer" ¹⁾ "Dosing" "Dynamic"	normal weighing samples dispensing (e.g. of liquid or powders) restless load, e.g. animals
Reset <div style="border: 1px solid black; padding: 2px; display: inline-block;">r E S E t</div>	Resets all "SCALE" settings to the factory settings.	Confirm reset by pressing « ↵ » or cancel with « →T← ». Note: To reset the adjustments, the prompt "Std On" must be confirmed with « ↵ ».
End settings. <div style="border: 1px solid black; padding: 2px; display: inline-block;">E n d S C</div>	Exit the "SCALE" block.	Press « ↵ » to exit the "SCALE" block, or « →T← » to make further settings.
¹⁾ factory setting		

3.4 Interface configuration









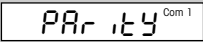
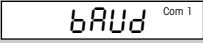

I F A C E 1

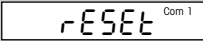
I F A C E 2

The Viper EX SW scale has a built-in current loop interface which the PSU power supply unit converts into a user-selectable interface (refer to the installation instructions for the PSU power supply unit). The interface can be configured in the "IFACE 1" block.

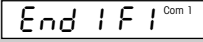
Note: The settings in "IFACE 2" have no effect.

Function/Display	Settings	Remarks
Mode <div style="border: 1px solid black; padding: 2px; display: inline-block;">M o d e <small>Com 1</small></div>	"Print" (printer) ^{1) 5)} "Cycle" (series weighing) ^{2) 5)} "Dialog" (computer) ^{3) 4) 5)}	2400 bd, 7b even, Xon/Xoff 2400 bd, 7b even, Xon/Xoff 9600 bd, 8b no parity, Xon/Xoff
Transmission protocol <div style="border: 1px solid black; padding: 2px; display: inline-block;">P r o t o l <small>Com 1</small></div>	"HONOFF" ¹⁾ "No"	Xon/Xoff protocol no protocol
(continued on next page)		

Function/Display	Settings	Remarks						
Bits and parity 	"7 Even" ¹⁾ "7 No P" "8 No P" "7 Odd"	7 data bits with even parity 7 data bits with no parity 8 data bits with no parity 7 data bits with odd parity						
Data transfer rate 	300, 600, 1200, 2400 ¹⁾ , 4800, 9600, 19200 baud	Note: For older Sprinter 1 printers select 300 baud						
Data and formatting to be transferred 	"Header" (On ¹⁾ /Off) ⁶⁾ "Gross" (On ¹⁾ /Off) "Net" (On ¹⁾ /Off) "Tare" (On ¹⁾ /Off) "4 LinF" (On ¹⁾ /Off) "F Feed" (On/Off ¹⁾) "Ln for" (Single ¹⁾ /Multi)	Report heading gross weight net weight tare 4 empty lines form feed "Single" = 1 result per line, "Multi" = all results on 1 line						
Reset 	Resets all settings of selected interface to factory settings.	Reset with «  » key (confirming "Std On" query by pressing «  » again) or cancel with «  T  ».						
End settings 	Exit the interface block.	Press «  » to exit interface block or «  T  » to make further settings.						
<div data-bbox="94 1177 351 1388" style="border: 1px solid black; padding: 5px; margin-bottom: 10px;"> METTLER-TOLEDO GmbH Heuwinkelstrasse CH-8606 Naenikon Telefon 01/944 22 11 Internet www.mt.com </div> <div data-bbox="94 1299 351 1362" style="border: 1px solid black; padding: 5px; margin-bottom: 10px;"> <table style="width: 100%; border-collapse: collapse;"> <tr> <td style="width: 10%;">G</td> <td style="width: 40%;">7.153 kg</td> </tr> <tr> <td>T</td> <td>0.422 kg</td> </tr> <tr> <td>N</td> <td>6.731 kg</td> </tr> </table> </div> <div data-bbox="396 890 1037 1347"> <p>¹⁾ Factory setting for connection to "Sprinter 1" printer.</p> <p>²⁾ Data printout when weight changes.</p> <p>³⁾ The "Dialog" mode is used for bidirectional communication of the scale with an external device (e.g. a computer). Further information is given in Section 4.6.</p> <p>⁴⁾ For using the Viper scale as the reference scale in 2-scale systems.</p> <p>⁵⁾ If this operating mode is selected, the associated default settings (see "Remarks" column) are automatically adopted.</p> <p>⁶⁾ This setting specifies whether a record header is to appear on the printouts. This consists of up to 5 lines, each with a maximum of 24 characters (e.g. company name and address). The record header is created and formatted by means of SICS commands via the interface (see Section 4.6). A typical record with a header is shown opposite.</p> </div>			G	7.153 kg	T	0.422 kg	N	6.731 kg
G	7.153 kg							
T	0.422 kg							
N	6.731 kg							

3.5 Printing master mode settings

L 1St



In this block all master mode settings can be recorded with a printer.





- Press «» key to print out the settings.
(Recommended printer: "Sprinter 1", see Section 4.5 "Accessories")

3.6 Saving settings and exiting master mode

END



In the last master mode block you can save your settings and revert to weighing mode.

- Press the «» key to exit master mode.
- Press the «» key to save the settings or the «T» key to cancel them. The scale then reverts to weighing mode.

Store ?

3.7 Making a typical setting in master mode

You want to set the readability (resolution) at 0.01kg.

MASTER



CAL



SCALE



RESOLU



00 1kg

















END



Store ?



000kg

- Hold down the «» key for about 5 seconds to access master mode, and confirm that you really want this by briefly pressing «» ("Yes") within 3 seconds.
- Skip the first master mode block "CAL" (Calibration, not available with certified scales) by pressing «T» ("No").
- Activate the block for scale settings ("Scale") and then the subblock for resolution ("Resolution") by pressing «» ("Yes") twice.
- Press «T» ("No") repeatedly until the desired resolution (0.1 kg) is displayed, then confirm by pressing «» ("Yes").
- Answer the prompt "End" with «» ("Yes") as you do not want to make more settings. If you press «T» ("No"), however, you can make further settings.
- Answer the prompt "Store?" (Save in memory) with «» ("Yes"). The scale reverts to weighing mode and operates with the new settings. If you reply with «T» ("No"), the changes will not be saved.

4

Other important information

This section gives information on error messages and instructions for cleaning your scale. It also includes the declaration of conformity and technical data.

4.1 Error messages

Overload

Reduce the load on the scale or the preload.

Underload

Place weighing pan on the scale and ensure that it can move freely.

Weight reading does not stabilize.

1. Ensure a tranquil environment.
2. Ensure that the weighing pan is free to move.
3. Change the setting of the vibration adapter (Section 3.3).
4. If necessary use the dynamic weighing function (Section 3.3).

Not possible to zero scale

Ensure that zeroing is only carried out in the permissible range and not under overload or underload conditions.

No calibration/adjustment

Disconnect the PSU or PSUx power supply unit from the power supply and then reconnect it. If the error message reappears, calibrate/adjust the scale (Section 3.2). If this still does not help, contact your dealer or local representative.

EAROM checksum error

Disconnect the PSU or PSUx power supply unit from the power supply and then reconnect it. If the error message reappears, contact your dealer or local representative.

4.2 Cleaning instructions



- Use a damp cloth (do not use acids, alkalis or strong solvents). Wet cleaning is not allowed.
- If heavily contaminated, the weighing pan and adjustable feet must be removed and cleaned separately.

- With the weighing pan removed, never use a solid object to clean underneath the load plate support!
- Observe your organization's internal rules and industry-specific regulations for cleaning intervals and permissible cleaning agents.

4.3 Declaration of conformity

We, **Mettler-Toledo (Albstadt) GmbH, Unter dem Malesfelsen 34, D-72458 Albstadt** declare under our sole responsibility that the product **Viper EX SW, Viper EX SW MB with PSU, PSUx**, to which this declaration relates is in conformity with the following directives and standards.

Directive	Applicable standard
relating to equipment and protective systems intended for use in potentially explosive atmospheres (94/9 EEC)	EN50014, EN50019, EN50020, EN50028 FMRC 3600, 3610, 3810 CSA-C22.2 No. 157-92 CSA-C22.2 No. 142-M 1997
relating to electrical equipment designed for use within certain voltage limits (73/23/EEC; amended by directive 93/68/EEC)	EN61010-1 (Safety Regulations)
relating to electromagnetic compatibility (89/336/EEC; amended by directive 93/68/EEC; 92/31/EEC)	EN61326-1 Emission Class B EN61326-1 Immunity (Industrial) AS/NZS2064.1/2, AS/NZS3548 AS/NZS4251.1, AS/NZS4252.1
relating to non-automatic weighing instruments (90/384/EWG; amended by directive 93/68/EWG) ¹⁾	EN45501 ¹⁾ (Metrological Aspects) 

¹⁾ applies only to certified scales

Albstadt, September 2002

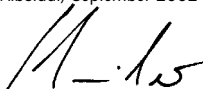

Roland Schmider, General Manager

Mettler-Toledo (Albstadt) GmbH

Heiko Carls, Quality Manager

Important notice for verified weighing instruments in EC countries

 Weighing instruments verified at the place of manufacture bear the preceding mark on the packing label and a green "M" sticker on the descriptive plate. They may be set to work immediately.

 Weighing instruments which are verified in two steps have no green "M" on the descriptive plate and bear the preceding identification mark on the packing label. The second step of the verification must be carried out by the approved Mettler-Toledo service or by the W & M authorities. Please contact your Mettler-Toledo organization.

The first step of the verification has been carried out at the manufacturing plant. It comprises all tests according to EN45501-8.2.2.

If national regulations in individual countries limit the period of validity of the certification, the operator of such a scale is himself responsible for its timely re-certification.

USA/Canada

This equipment has been tested and found to comply with the limits for a Class A digital device, pursuant to both Part 15 of the FCC Rules and the radio interference regulations of the Canadian Department of Communications. These limits are designed to provide reasonable protection against harmful interference when the equipment is operated in a commercial environment. This equipment generates, uses and can radiate radio frequency energy and, if not installed and used in accordance with the instruction manual, may cause harmful interference to radio communications. Operation of this equipment in a residential area is likely to cause harmful interference, in which case the user will be required to correct the interference at his own expense.

Canada

ICES-001 Notice for Industrial, Scientific and Medical Radio Frequency Generators: This ISM apparatus meets all requirements of the Canadian Interference-Causing Equipment Regulations. Please note that this requirement is only for generators which operate at over 10 kHz.

Avis de l'ICES-001, générateurs de radiofréquences dans le domaine industriel, scientifique et médical: Cet appareil ISM (industriel, scientifique et médical) satisfait à toutes les exigences définies par la réglementation canadienne en matière d'équipements générant des perturbations radioélectriques. Veuillez noter qu'il s'agit d'une exigence concernant uniquement les générateurs fonctionnant au-delà de 10 kHz.

4.4 Technical data

Functions	4 weighing units, vibration adapter, weighing process adapter, automatic tare function, automatic zero correction, power-saving shutoff, display backlighting, automatic saving of tare and zero									
Display	LCD (liquid crystal display), 16mm high, backlit									
Ambient conditions	The accuracy is guaranteed in the following ranges: Temperature range: -10 to +40 °C (strain gauge cells) +10 to +30 °C (MonoBloc cells) Relative humidity: 15 to 85% RH (no condensation) Overvoltage category: II Pollution degree: 2									
Explosion classification	II 2 G EEx ib IIC T4, T _{amb} -10 ... +40 °C KEMA 00 ATEX 1116X CL I, DIV 1, GP A, B, C, D FMRC and CSA									
Power supply intrinsically safe	Connect only to PSUx or PSU power supply unit! Terminal 1: U _i : 8,7 V I _i : 133 mA P _i : 1,15 W Terminal 3: U _i : 12,6 V I _i : 42 mA P _i : 0.35 W Terminal 5: U _i : 10,5 V I _i : 74 mA P _i : 0.78 W									
Total weight	<table><thead><tr><th></th><th>Strain gauge</th><th>MonoBloc</th></tr></thead><tbody><tr><td>Small platform:</td><td>4.4 kg</td><td>4.5 kg</td></tr><tr><td>Large platform:</td><td>8.0 kg</td><td>10.3 kg</td></tr></tbody></table>		Strain gauge	MonoBloc	Small platform:	4.4 kg	4.5 kg	Large platform:	8.0 kg	10.3 kg
	Strain gauge	MonoBloc								
Small platform:	4.4 kg	4.5 kg								
Large platform:	8.0 kg	10.3 kg								
Ingress protection	IP43									
Standard scope of supply	Scale complete, operating instructions									

Dimensions

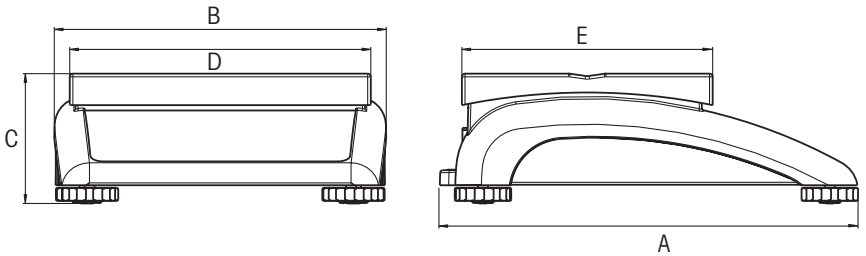

	A	B	C*	D	E
Small platform	335	265	100	240	200
Large platform	370	360	115	350	240

All dimensions in millimeters

* with adjustable feet fully screwed in

Interface technical data

The scale is equipped with a current loop interface as standard, which in the PSU power supply unit is electrically isolated and converted into a user-selectable voltage interface (e.g. according to EIA RS-232C, CCITT V24/V.28). Further details together with pin assignments will be found in the separate installation instructions for the PSU power supply unit.

4.5 Accessories

Accessories	Article No.
Power supply / interface unit	PSU / Viper Ex
Antitheft device	00229175
"Sprinter 1" printer, EURO version	21253399
"Sprinter 1" printer, UK version	21253745
RS232 cable for printer 3 m	00503755
RS232 cable for PC 3 m (9-pin D-Sub, parallel)	00504376
8-pin adapter	00503756

4.6 Interface commands

Your scale can be configured, interrogated and operated from a PC via an RS232C interface.

Preconditions

The following preconditions must be fulfilled to achieve communication between the scale and a PC:

- The scale must be connected to the PSU power supply unit.
- The PSU power supply unit must be connected by a suitable cable to the RS232C interface of a PC (see section 4.5).
- The scale interface must be set at "Dialog" mode (see Section 3.4).
- A terminal program must be available on the PC (e.g. "Hyper Terminal").
- The communications parameters (protocol, bits and parity, data transfer rate) must be set at the same values in the terminal program and in the scale (see Section 3.4).

SICS command set

Your scale supports the **Mettler Toledo Standard Interface Command Set (MT SICS)**, the SICS commands as per "Level 0" and "Level 1" being implemented. Detailed information on the interface commands is given in the "MT SICS Reference Manual" (No. 705184, only available in English).

In addition to the standard commands, scale-specific **SICS commands also exist to support product-specific characteristics. These commands** are not given in the "MT SICS Reference Manual", but in the documentation supplied with the individual scale. At the present time the Viper scale supports one single specific command for specifying the record header. This command is described below.

Specifying the record header

With this command you can define up to 5 lines, each with a maximum of 24 characters, which is printed out at the head of every record. Normally, the company name and address are printed on the record in this way. Specify the record header as follows:

- Ensure that the communication between the scale and the PC is in good working order.
- The command for defining the record header is **I31_x**, where "x" is the line number. Specify the desired record header as shown in the following example (only the required lines need be entered):

```
I31_1_"Mettler Toledo GmbH" <CR><LF>
I31_2_"Heuwinkelstrasse" <CR><LF>
I31_3_"CH-8606 Naenikon" <CR><LF>
I31_4_"Telefon 01/944 22 11" <CR><LF>
I31_5_"Internet www.mt.com" <CR><LF>
```

Please observe the following:

- Every command line must be terminated with **<CR><LF>** (corresponding to the "Enter", "Return" or "↵" key on the PC keyboard). The command is then executed immediately. To correct a line, this needs to be entered again completely.
 - The "_" symbol signifies an empty space, and in the above example serves solely to clarify the syntax. The quotation marks must be entered, as they indicate to the scale that they enclose a text string and not a command.
 - You can insert empty lines by entering an empty space instead of text.
Example: **I31_2_" " <CR><LF>** . This defines line 2 as an empty line.
 - By entering **I31_x <CR><LF>** (x = line number) you can interrogate the appropriate line.
 - With the command **I31_x_" " <CR><LF>** (x = line number) you can delete the individual line again.
- Once the record header has been completely specified (and you do not want to give any further SICS commands), you can break the connection between the scale and the PC. **Important:** for the scale to actually print out the record, the interface mode must be reset at "Print", and the setting "Header" must be activated ("On") for the data to be transferred ("defStr"). A description of these settings and a specimen record corresponding to the above example are to be found in Section 3.4.

**To give your METTLER TOLEDO products an assured future:
METTLER TOLEDO Service preserves the quality, measurement
accuracy and value of METTLER TOLEDO products for years to
come.**

**Incidentally, the scale can be adjusted to suit your needs. Ask
your METTLER TOLEDO salesperson or specialist scales dealer
for more details.**



Subject to technical changes and to the availability of the
accessories supplied with the instruments.

Design registered.
Printed on 100 % chlorine-free paper,
for the sake of our environment.

© Mettler-Toledo GmbH 2002 21203908 Printed in Switzerland 0209/2.12

Mettler-Toledo (Albstadt) GmbH, D-72423 Albstadt, Tel. +49 7431 140, Fax +49 7431 14371, Internet: <http://www.mt.com>

AT Mettler-Toledo Ges.m.b.H., A-1100 Wien, Tel. (01) 604 19 80, Fax (01) 604 28 80
AU Mettler-Toledo Ltd., Port Melbourne, Victoria 3207, Tel. (03) 9644 5700, Fax (03) 9645 3935
BE n.v. Mettler-Toledo s.a., B-1932 Zaventem, Tél. (02) 334 02 11, Fax (02) 378 16 65
BR Mettler-Toledo Indústria e Comércio Ltda., São Paulo, CEP 06465-130, Tel. (11) 421 5737, Fax (11) 725 1962
CH Mettler-Toledo (Schweiz) AG, CH-8606 Greifensee, Tel. (01) 944 45 45, Fax (01) 944 45 10
CN Mettler-Toledo Changzhou Scale Ltd., Changzhou City, Jiangsu 213001, Tel. (519) 664 2040, Fax (519) 664 1991
CZ Mettler-Toledo, s.r.o., CZ-100 00 Praha 10, Tel. (2) 72 123 150, Fax (2) 72 123 170
DE Mettler-Toledo GmbH, D-35353 Giessen, Tel. (0641) 50 70, Fax (0641) 52 951
DK Mettler-Toledo A/S, DK-2600 Glostrup, Tel. (43) 27 08 00, Fax (43) 27 08 28
ES Mettler-Toledo S.A.E., E-08038 Barcelona, Tel. (93) 223 7600, Fax (93) 223 0271
FR Mettler-Toledo s.a., F-78222 Viroflay, Tél. (01) 309 717 17, Fax (01) 309 716 16
HK Mettler-Toledo (HK) Ltd., Kowloon HK, Tel. (852) 2744 1221, Fax (852) 2744 6878
HR Mettler-Toledo, d.o.o., CR-10000 Zagreb, Tel. (1) 29 20 633, Fax (1) 29 58 140
HU Mettler-Toledo Kft, H-1173 Budapest, Tel. (1) 257 9889, Fax (1) 257 7030
IN Mettler-Toledo India Pvt Ltd, Mumbai 400 072, Tel. (22) 857 08 08, Fax (22) 857 50 71
IT Mettler-Toledo S.p.A., I-20026 Novate Milanese, Tel. (02) 333 321, Fax (02) 356 29 73
JP Mettler-Toledo K.K., Shiromi, J-Osaka 540, Tel. (6) 949 5901, Fax (6) 949 5945
KR Mettler-Toledo (Korea) Ltd., Seoul (135-090), Tel. (82) 2 518 20 04, Fax (82) 2 518 08 13
MY Mettler-Toledo (M) Sdn.Bhd., 40150 Selangor, Tel. (3) 7845 5773, Fax (3) 7845 8773
MX Mettler-Toledo S.A. de C.V., Mexico CP 06430, Tel. (5) 547 5700, Fax (5) 541 2228
NL Mettler-Toledo B.V., NL-4000 HA Tiel, Tel. (0344) 638 363, Fax (0344) 638 390
NO Mettler-Toledo A/S, N-1008 Oslo, Tel. (22) 30 44 90, Fax (22) 32 70 02
PL Mettler-Toledo, Sp. z o.o., PL-02-929 Warszawa, Tel. (22) 651 92 32, Fax (22) 651 71 72
RU Mettler-Toledo AG, 10 1000 Moskau, Tel. (095) 921 68 12, Fax (095) 921 63 53
SE Mettler-Toledo AB, S-12008 Stockholm, Tel. (08) 702 50 00, Fax (08) 642 45 62
SEA Mettler-Toledo (SEA), 40150 Selangor, Tel. (3) 7845 5373, Fax (3) 7845 3478
SG Mettler-Toledo (S) Pte. Ltd., Singapore 139959, Tel. 6890 0011, Fax 6890 0012
SK Mettler-Toledo service, s.r.o., SK-83103 Bratislava, Tel. (7) 525 2170, Fax (7) 525 2173
SI Mettler-Toledo, d.o.o., SI-1236 Trzin, Tel. (1) 562 18 01, Fax (1) 562 17 89
TH Mettler-Toledo (Thailand), Bangkok 10310, Tel. (2) 723 0300, Fax (2) 719 64 79
TW Mettler-Toledo Pac Rim AG, Taipei, Tel. (886) 2 2579 5955, Fax (886) 2 2579 5977
UK Mettler-Toledo Ltd., Leicester, LE4 1AW, Tel. (0116) 235 0888, Fax (0116) 236 5500
US Mettler-Toledo, Inc., Columbus, Ohio 43240, Tel. (614) 438 4511, Fax (614) 438 4900

For all other countries: Mettler-Toledo GmbH, PO Box VI-400, CH-8606 Greifensee, Tel. +41 1 944 22 11, Fax +41 1 944 31 70