

Operating and installation instructions

METTLER TOLEDO

- Filling with Spider 3S scales
- Digital outputs

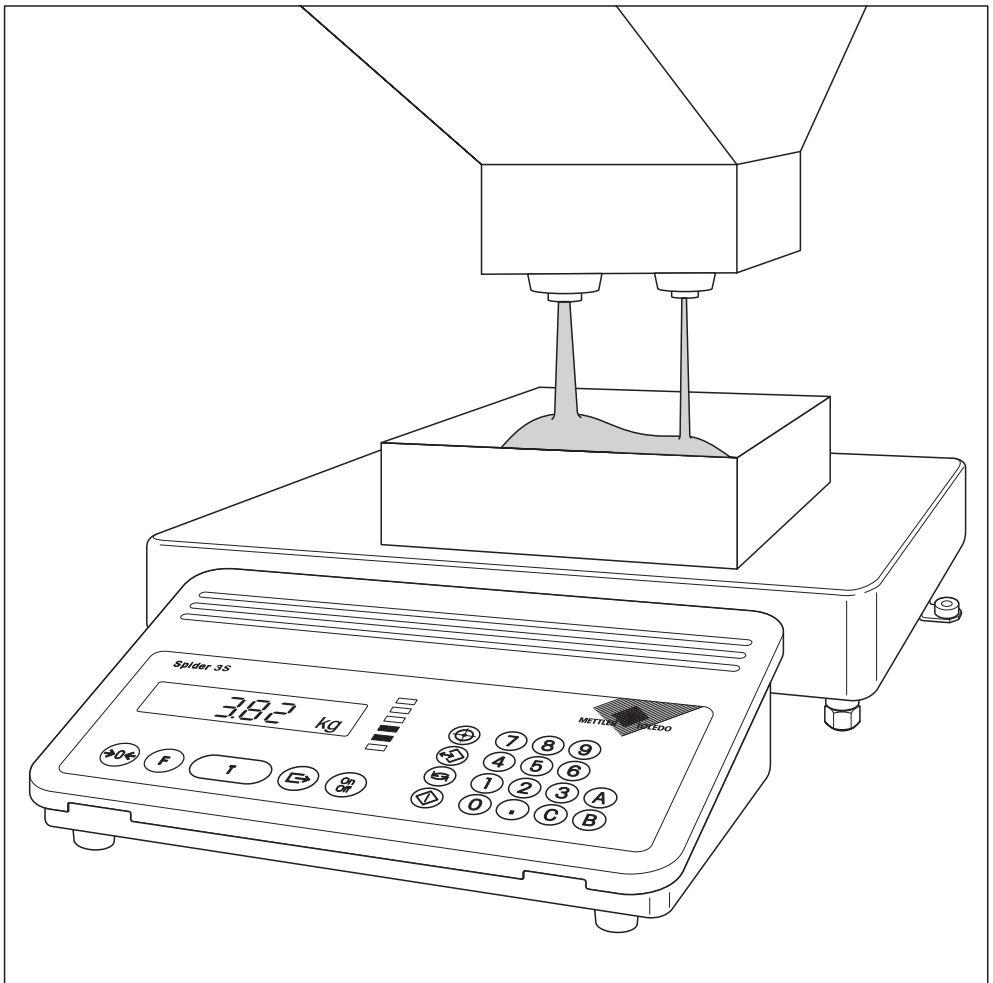

Contents

1.	Important information before you start	3
1.1	Introduction	3
1.2	What you should know about these instructions	3
1.3	Safety instructions	4
1.4	Explanation of terms used	5
2.	Setting up a filling installation	7
2.1	Block diagram	7
2.2	Specifications of the digital parallel output	8
2.3	Recommended components	9
2.4	Signal diagrams	11
3.	Entries in the master mode	12
4.	Operation	14
4.1	Entry of the filling parameters	14
4.2	Storage and recall of the filling parameters	16
4.3	Performing a filling	17
4.4	Recording of parameters and filling processes	19
5.	Error messages	20
6.	Commands for operation via a PC	21
6.1	Commands for filling	21
6.2	Commands for defining and inquiry of the filling parameters	22

1. Important information before you start

This section provides you with basic information for the filling application of your Spider 3S scale. Please read through this section carefully even if you already have experience with Spider 3S scales and make sure you comply with the safety instructions.

1.1 Introduction

The filling application is included in the standard software of newer Spider 3S scales (with SW version 3.51 and later). You thus need no additional components for the actual scale to work with the filling application. On the other hand, you must design the filling installation yourself or purchase it from an external manufacturer. These instructions provide you with all necessary details on how to set up the filling system and connect it to the Spider 3S scale.

With the filling application, valves, feed chutes and other conveying equipment for the filling of low or high viscosity, pasty, powdery or granular weighing samples can be controlled. The filling application supports systems with one or two dispensing devices (valves etc.). The LED chain shows the current status of the filling process or provides information on whether the weighing sample lies within the specified tolerances. The filling parameters (target value, limit values and tare values) can be stored and recalled when needed at any time. The filling application has a so-called learn mode which can calculate shutoff points automatically and correct them on the basis of a filling. The automatic tare monitoring prevents the start of the filling process if a wrong or no tare container is loaded.

1.2 What you should know about these instructions

Please note the following information regarding these instructions:

- These instructions are a supplement to the operating instructions you received with your Spider 3S scale. It is assumed that you are familiar with the operation of the scale and the layout and operation of the master mode.
- The same conventions apply to these instructions as for the operating instructions of the scale (see section 1 of the operating instructions for the Spider 3S scale).
- It is essential you comply with all safety instructions in the operating instructions of the Spider 3S scale!
- The filling application can be operated via a PC attached to the RS232C interface of the Spider 3S scale. Operation via a PC is not described in these instructions. Information on operation of the scale via a PC and a complete list of all commands can be found in the interface description of the Spider and Spider S scales (order number 21250163). You can obtain this documentation from your METTLER TOLEDO dealer. In section 6 of these instructions you will find only the commands for operation of the filling application.

1.3 Safety instructions

Please comply with the following instructions for a safe and trouble-free operation of your filling installation. **These instructions are intended to supplement the safety instructions given in section 1 of the operating instructions of the Spider 3S scales.**



Read through these operating instructions carefully even if you already have experience with the Spider 3S scale and with filling applications.



Filling installations with Spider 3S scales must **not be operated in hazardous areas.**



Exercise caution when pressing the keys which control the filling system: First ensure that no person is in the vicinity of the filling installation as there is a danger of injury (moving parts, discharge of materials, etc.).



Comply with all local regulations concerning the setup and operation of filling installations.



An **emergency stop** must be provided for the filling system which interrupts the power supply of the valves directly.

1.4 Explanation of terms used

Automatic redispensing

If the filling head is clogged with material and this drops down, the weighing signal may overshoot briefly and cause the shutoff point to be exceeded. The material flow is stopped although the target weight is not yet attained. If the "Redispensing" option is activated in the master mode, material will be added in small steps until the target weight is reached.

Automatic tare monitoring

Before every filling process a minimum and a maximum container weight can be specified. If the loaded container does not lie within the defined range or if no container has been loaded, the filling process can not be started.

Filling

Filling of an **empty** container which is on the scale (weighing in). If the "FILL In" option is **deactivated** in the master mode, the **full** container is on the scale and the weighing sample is removed (weighing out).

Fine feed

Material from a valve, a shaker or another feed device with fine material flow. The fine feed usually starts after the coarse feed and allows exact attainment of the target weight.

Coarse feed

Material from a valve, a shaker or another feed device with a coarse material flow for rapid filling to the vicinity of the target weight.

Learn mode

If no shutoff points are known from a previous filling, the software automatically switches to the learn mode and calculates the shutoff points automatically. In the case of systems with a single feed device (valve etc.), this remains open until 50% of the target weight is reached. Taking into account the post dispensing, the shutoff point is calculated so that the target weight is reached with the correct tolerance through repeat opening of the dispensing device. With systems having two dispensing devices, these are each opened twice.

Post dispensing

Material that continues flowing after closing of the dispensing device.

Post dispensing correction

The post dispensing correction can be switched on or off in the master mode. If the correction is switched on, the shutoff point of the subsequent filling will be automatically corrected by 50% of the deviation of the previous filling.

Safety timeout

If a weight change of at least 5 d (corresponding to 5 display intervals at the maximum resolution of 30 000 d) has not occurred 4 seconds after the start of filling, the filling process will be automatically stopped.

The following two illustrations elucidate the terms explained above and show the **typical course of a filling process** for systems with one or two dispensing devices:

Systems with 1 dispensing device (e.g. valve)

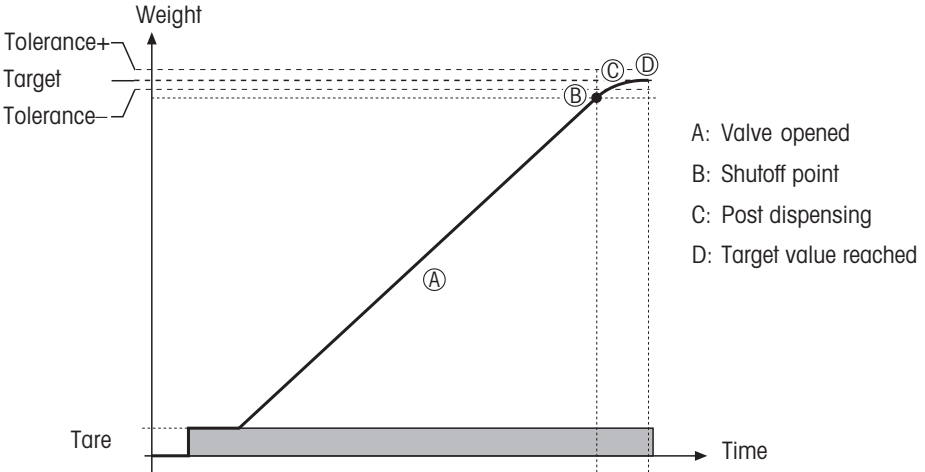

Systems with 2 dispensing devices (e.g. valves)

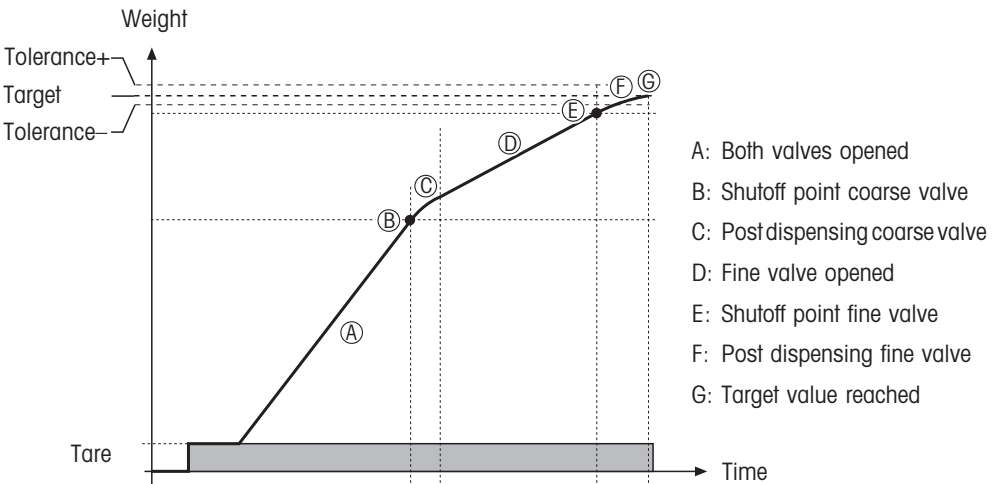

2. Setting up a filling installation

2.1 Block diagram

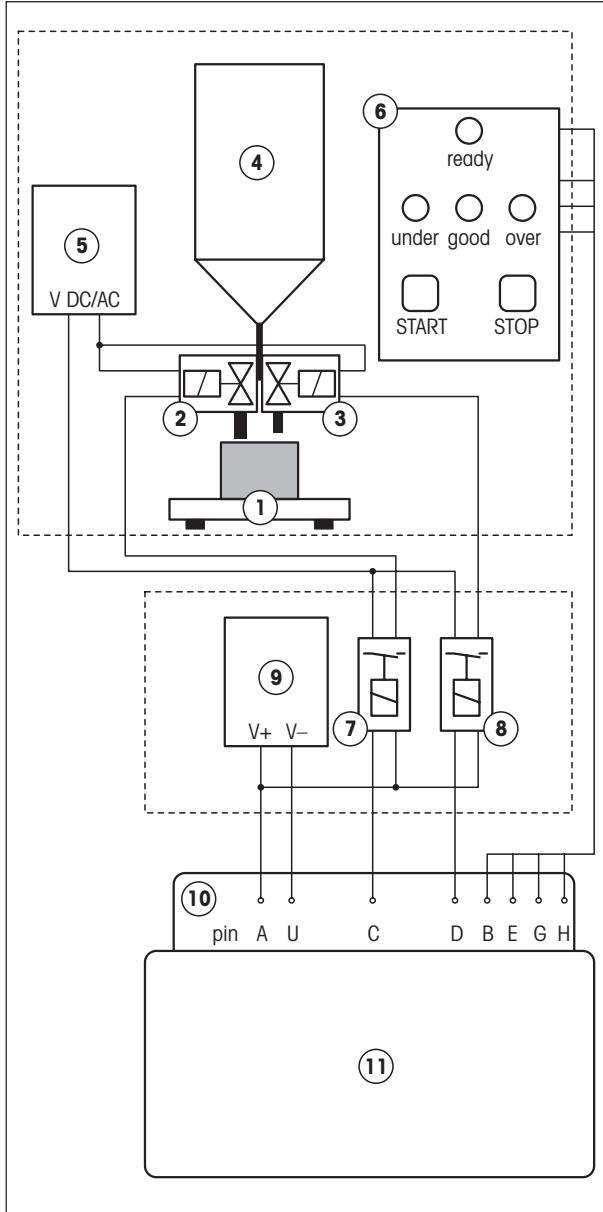

1. Weighing platform
2. Coarse feed valve
3. Fine feed valve
4. Material container
5. Power supply for valves (if valve and relay voltages are identical, a common supply can be used)
6. Display/operating terminal of the filling installation.

The Start key can be connected to pins 6 (GND) and 5 (VDC) of the RS232C interface of the Spider 3S terminal. The emergency stop must directly interrupt the power supply of the valves. On direct connection of the display lamps to the digital outputs of the Spider 3S terminal, please note: $I_{\max.} = 100 \text{ mA}$.

7. Relay coarse feed valve
8. Relay fine feed valve
9. Power supply for relay (if the relay and valve voltages are the same, a common power supply can be used)
10. Digital parallel output with the following pin assignment (see also section 6):

Valve control:

C = Coarse feed
D = Fine feed

Display:

B = Ready
E = Underfilling
G = Weight within tolerance
H = Overfilling

11. Spider 3S terminal

2.2 Specifications of the digital parallel output

Pin assignment of the socket at the Spider 3S terminal

The pins of the 19-pin socket have the following assignment:

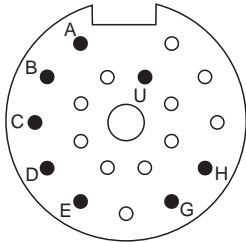

View of rear of terminal

Pin	Assignment/signal	Corresponds to LED
A	Ext. supply 5..30 VDC	—
B	Ready	Lowest red LED
C	Coarse feed on	2nd lowest red LED
D	Fine feed on	2nd highest red LED
E	Underfilling	Highest red LED
G	Weight within tolerance	Green LED
H	Overfilling	Yellow LED
U	Ext. supply GND	—

Connection of external signal lamps

On connection of external signal lamps, ensure that $I_{max} = 100\text{ mA}$ is not exceeded.

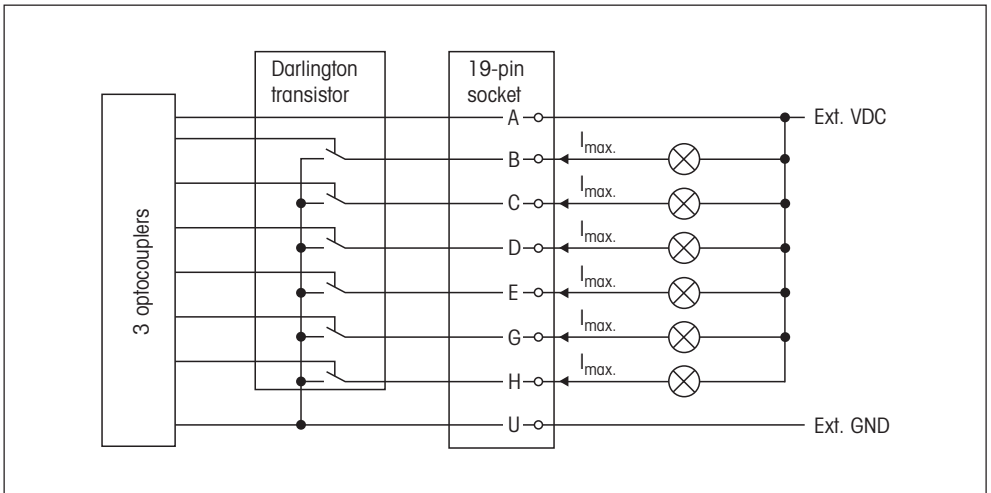

Relay connection

Up to 6 relays with a common or separate external supply can be connected.

Relay with 1 external supply

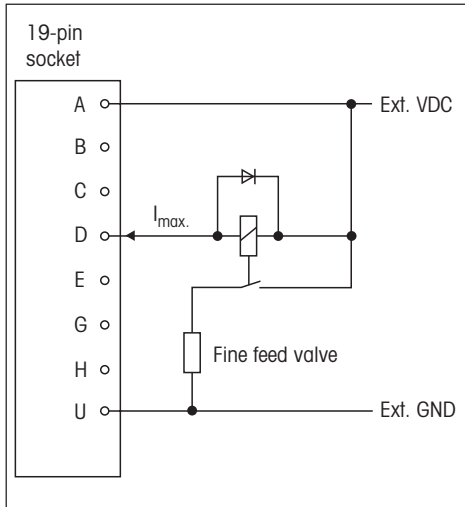

Relay with several external supplies

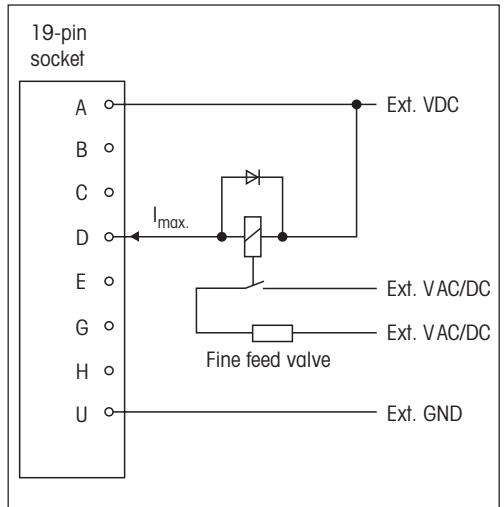

2.3 Recommended components

Power supply

Phoenix Contacts company, installation on mounting rail:

– **Input: 230 VAC**

Output: 24 VDC/1 A, type CM 62-PS-230 AC/24 DC/1, **Art. 29 43 68 6**

– **Input: 120 VAC**

Output: 24 VDC/1 A, type CM 62-PS-120 AC/24 DC/1, **Art. 29 43 39 8.**

Relay

Phoenix Contacts company, installation on mounting rail:

1 changeover contact, max. switching voltage 250 VAC, limiting continuous current 6 A, 6.2 mm width, type PLC-RSC-24DC/21, **Art. 29 66 17 1**

Manufacturer of sterile valves

Alfa Laval Saunders Limited, Cwmbran, Gwent NP44 3XX, United Kingdom

Cables and connectors

The following cables and connectors are available for the parallel output:

– **Connection cable for parallel output**, length 10 m, Art. No: 504 458

– **Coupler plug for parallel output**, 19-pin, Art. No: 504 461

The cable and the coupler plug have the following pin assignment (only pins marked by * are needed for the connection to Spider 3S, see also section 2.2):

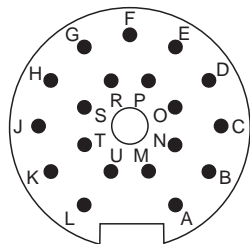

View of solder side of
coupler plug

Pin	Designation	Color	Comment
N	IN 1	gray/pink	
O	IN 2	red/blue	
P	IN 3	white/green	
R	IN 4	brown/green	
S	IN 5	white/yellow	
T	IN 6	yellow/brown	
B*	OUT 1	white	
C*	OUT 2	brown	
D*	OUT 3	green	
E*	OUT 4	yellow	
G*	OUT 5	gray	
H*	OUT 6	pink	
J	OUT 7	blue	
K	OUT 8	red	
A*	V+	black	connected internally to pin L
L	V+		
U*	V-	violet	connected internally to pin M
M	V-		
F	Shield		on housing

For the connection of an external Start key to the serial interface of the Spider 3S terminal, the **RS232C open end cable** (length 1.5 m, connector at one end) from METTLER TOLEDO can be used (Art. No. 21254280). The connector has the following pin assignment:

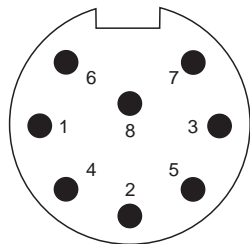

View of connector side

Pin	Designation	Color	Comment
1	Shield		on connector housing
2	TxD	white	
3	RxD	green	
6	GND	gray	
4	PONOFF (DTR)	brown	
8	BATLOW (DSR)	yellow	
7	V-ACCU	pink	
5	INPUT	blue	

2.4 Signal diagrams

Note: You will find information on the function of the LEDs in section 4.3.

Output signals for systems with 1 dispensing device

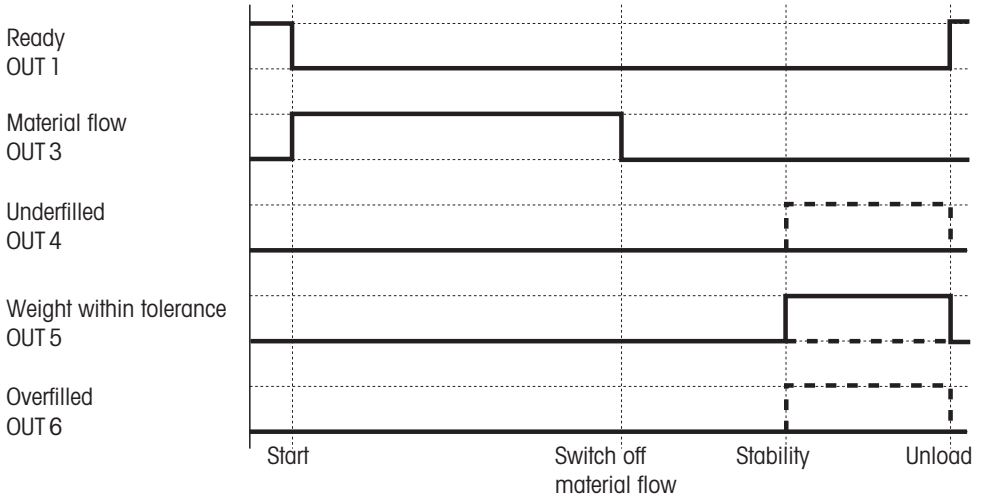

Output signals for systems with 2 dispensing devices

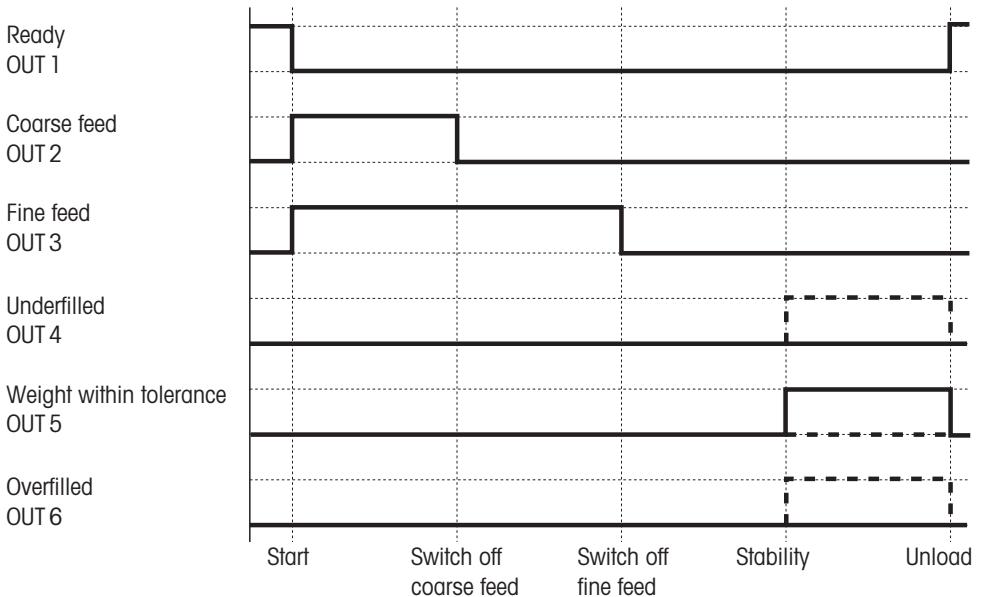

3. Entries in the master mode

For the filling application, the master mode of the Spider 3S scale has been expanded. The following illustration shows the extensions of the master mode. A complete overview of the remaining master mode parameters and instructions on operation of the master mode can be found in the operating instructions of the Spider 3S scale.

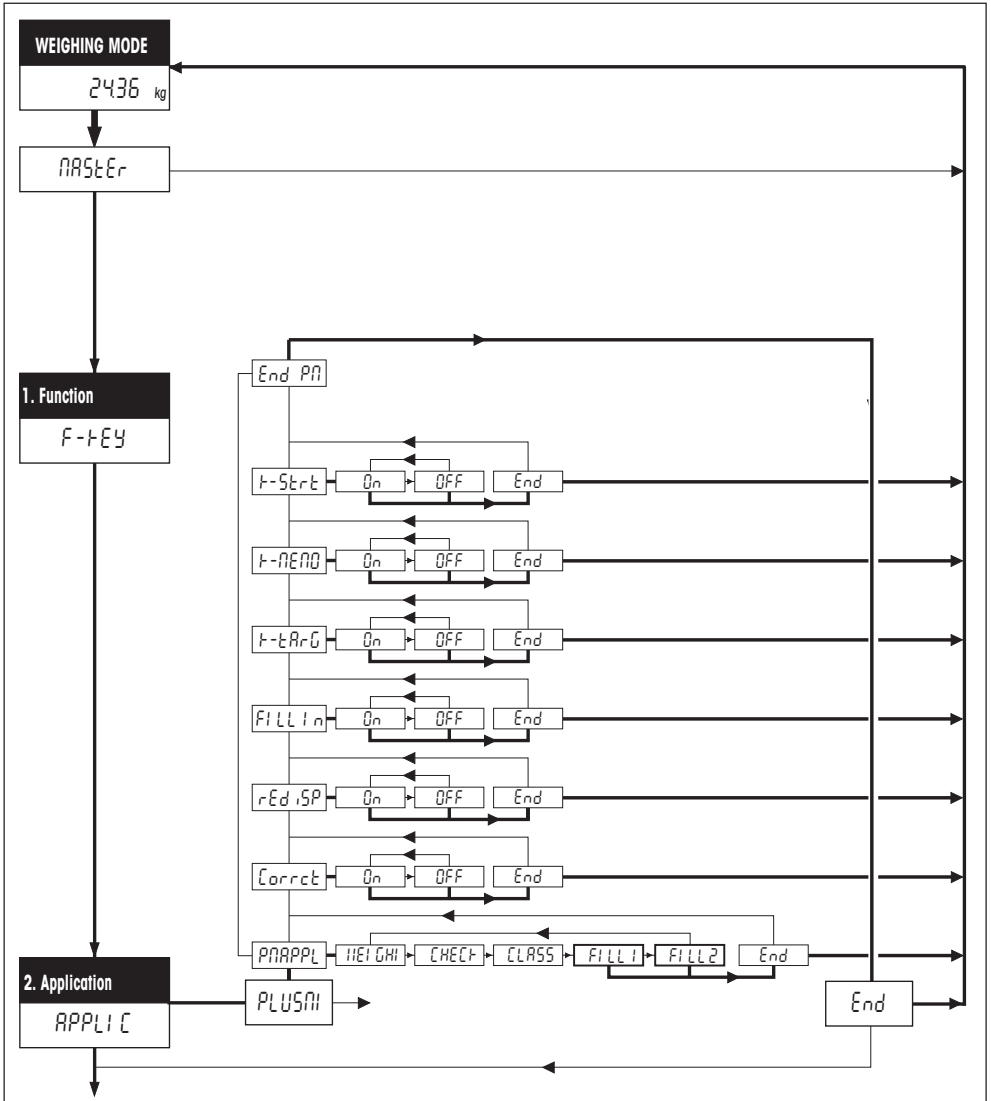

When in the master mode, first ensure that the process adapter is set to “Dosing”! Then define whether the filling system is equipped with one (“FILL 1”) or two (“FILL 2”) dispensing devices. The available filling parameters have the following meaning:

Correct

Post dispensing correction: If the post dispensing correction is activated (factory setting), the shutoff point for the next filling (or the shutoff point of the fine dispensing with systems having 2 dispensing devices) is automatically corrected (by 50% of the deviation of the previous filling).

redisp

Redispensing: If the filling head is clogged with material which drops down, the weighing signal may overshoot briefly and cause the shutoff point to be exceeded. The material flow is stopped although the target weight has not yet been reached. If the redispensing is activated (factory setting), more material is added in small steps until the target weight is reached.

FILL In

Filling: If the fill-in function is activated (factory setting), the filling application expects material to be added to an empty container. This corresponds to “weighing in” in normal weighing operation. If the fill-in function is deactivated, the filling application assumes that a full container is loaded and filling product is removed from it (corresponds to “weighing out” in normal weighing operation).

t-tArG

Target value key: If the target value key is activated (factory setting), the target weight can be reentered or confirmed on the Spider 3S terminal before every filling. If the target value key is deactivated, the stored target value can not be changed. This prevents an unintentional or unauthorized change to the target weight. Deactivation of the target value key is primarily suitable when the filling process is controlled via the terminal of the filling installation or via a PC.

t-MENO

Memory key: When the memory key is activated (factory setting), the specified filling parameters for 1 target value can be stored and recalled on the Spider 3S terminal. With a deactivated memory key, the memory is blocked, i.e. its contents can be neither changed nor recalled. Deactivation of the memory key is primarily suitable when the filling process is controlled via the terminal of the filling installation or a PC.

t-Start









Start key: When the Start key is activated (factory setting), the filling process can be triggered on the Spider 3S terminal, with a deactivated Start key this is not possible. Deactivation of the Start key is advisable if the filling process is controlled via the terminal of the filling installation or a PC.

4. Operation

This section shows you how to enter the filling parameters and perform fillings. We assume that you have already activated one of the two filling applications ("FILL 1" or "FILL 2") in the master mode and have made the desired settings.

4.1 Entry of the filling parameters

Before you can start the filling, you must enter the target weight, the admissible tolerances, the shutoff points and the tare tolerances.

- 
 - Press the target value key. The **green LED** starts to flash and prompts you to enter the **target weight**.
- 

 - You can accept the displayed value or enter a new value (e.g. 1.40 kg) using the numeric keypad. Confirm your entry by pressing the target value key again.
- 

 - The **green and the yellow LED** start to flash and prompt you to enter the **upper tolerance**. If a new target weight has been entered, the software suggests 2% of the target weight as the upper tolerance. You can accept the displayed value or enter your own value for the **admissible overfilling** (e.g. 4%) using the numeric keypad. With the «» key you can switch between the entry in percent (only whole numbers admissible) and the entry in kilograms. Confirm the selected value by pressing the target value key. If you have changed the existing value, the display briefly shows the admissible maximum weight (target weight plus admissible overfilling, in this example 1.456 kg).
- 

 - The **green and the highest red LED** start to flash and prompt you to enter the **lower tolerance**. If there is no value available from an earlier filling, the software suggests 2% of the target weight as the lower tolerance. You can accept the displayed value or enter your own value for the **admissible underfilling** (e.g. 1%) using the numeric keypad. With the «» key you can switch between the entry in percent (only whole numbers admissible) and the entry in kilograms. Confirm the selected value by pressing the target value key. If you have changed the existing value, the display briefly shows the admissible minimum weight (target value minus admissible underfilling, in this example 1.386 kg).

- The **second lowest red LED** starts to flash and prompts you to enter the **1st shutoff point**; after this has been reached the coarse feed valve should be shut off. With systems which have only 1 dispensing device ("FILL 1"), this is the only shutoff point you can specify.

1 . 1



You can accept the displayed value or enter a new value (e.g. 1.10 kg) using the numeric keypad (with the entry of 0 (zero), the shutoff point is deactivated). Confirm your entry by pressing the target value key.

- The **second highest red LED** starts to flash and prompts you to enter the **2nd shutoff point**; after this has been reached, the fine feed valve should be shut off. This input prompt appears only if you have selected the filling application "FILL 2" in the master mode (filling system with 2 dispensing devices).

1 . 3



You can accept the displayed value or enter a new value (e.g. 1.30 kg) using the numeric keypad. Confirm your entry by pressing the target value key.

- The **lowest and the highest red LED** start to flash and prompt you to enter the **minimum tare weight**. This input prompt appears only if you have activated "FILL In" in the master mode. When the container to be filled is loaded, the automatic tare monitoring checks whether this corresponds to the specified value. If this is not the case, the filling process can not be started.

. 1



You can accept the displayed value or enter a new value (e.g. 0.10 kg) using the numeric keypad. To switch off the automatic tare monitoring, enter a value of "0". Confirm your entry by pressing the target value key.

- The **lowest red and the yellow LED** start to flash and prompt you to enter the **maximum tare weight**. This input prompt appears only if you have not entered a "0" for the minimum tare weight (deactivation of the automatic tare monitoring) and only if "FILL In" is activated in the master mode.

. 1 1

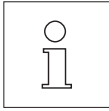

You can accept the displayed value or enter a new value (e.g. 0.11 kg) using the numeric keypad. Confirm your entry by pressing the target value key.

**Notes:**

- Instead of the target value key, you can also confirm existing or new values using the «E» key.
- The software checks your entries for plausibility and inadmissible inputs are rejected with an error messages (see section 5).

After the entry of all filling parameters, the **lowest red LED** lights up and the system is **ready for filling**.

4.2 Storage and recall of the filling parameters

You can store the current filling parameters permanently and recall them at any time.



Storage of the parameters

- To store the current parameters, enter "00" on the numeric keypad and then press and hold the memory key until ...

... storage of the parameters is briefly confirmed in the display.

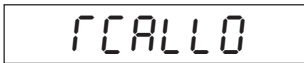

Recall of stored parameters

- To call-up the stored parameters, enter "00" on the numeric keypad and then press the memory key briefly.

The display shows a confirmation that the stored parameters have been activated and then all values are shown briefly. As soon as the lowest red LED lights up, the system is ready for the next filling using the recalled parameters.

4.3 Performing a filling

Depending on the setting in the master mode, the filling is performed in the filling mode ("FILL In" activated, factory setting) or in the removal mode ("FILL In" deactivated).



LEARN

- Place the container on the weighing pan.
- Start the filling using the Start key of the Spider 3S terminal:
 - A **brief keystroke** starts the filling in the **normal mode**.
Note: An ongoing filling can be stopped at any time by briefly pressing the Start key again.
 - A **long keystroke** starts the filling in the **learn mode** (automatic determination of the optimum shutoff points). The call-up of the learn mode is briefly confirmed in the display.

The filling process can also be started at any time **during the entry of the filling parameters** (see section 4.1) with the following exceptions:

- after entry of the upper tolerance
- after entry of the first shutoff point (concerns only the "FILL 2" application)
- after entry of the minimum tare weight (except if you have deactivated the tare monitoring by entering "0").

If you start the filling process during entry of the parameters, the parameters which have not been changed will also be used for the following weighing.

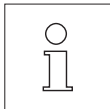

Note: With appropriate cabling, the filling process can also be started from the operating panel of the filling installation or from a PC (see section 2).

If the automatic tare monitoring is activated, the filling application checks whether the loaded container is within the specified tolerance. If this is not the case, the error message "no" appears and the filling process is not performed.

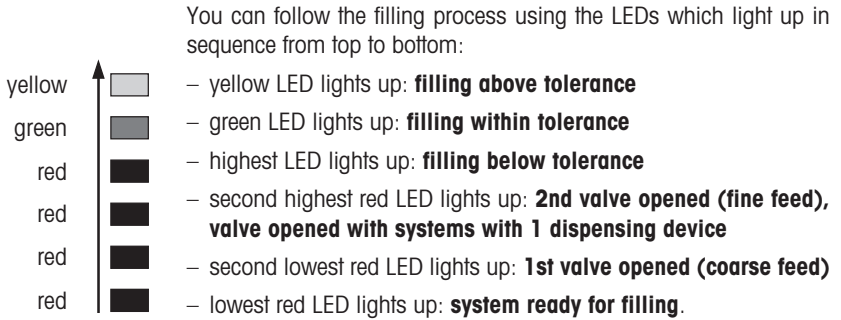

The valves can be opened at a keystroke to check their functioning and empty the filling system:



– To **open the coarse feed valve**, enter a "1" using the numeric keypad and then keep the Start key pressed.



– To **open the fine feed valve** (only with the "FILL 2" application), enter a "2" using the numeric keypad and then keep the Start key pressed.

As soon you release the Start key, the valves are reclosed.

4.4 Recording of parameters and filling processes

If a printer is attached to the Spider 3S terminal, the filling parameters and the individual filling processes are **automatically** recorded. The following specimen printouts are examples which may differ from your own records, depending on the interface configuration. You will find instructions on attachment of a printer and configuration of the interface(s) in the interface description for the Spider and Spider S scales, which you can obtain from your METTLER TOLEDO dealer.

Recording of filling parameters

Date	25.04.97
Time	18:37
TARGET	2.000 kg
TOLER. (+)	0.080 kg
TOLER. (-)	0.040 kg
LIMIT 1	1.820 kg
LIMIT 2	1.970 kg
TARA MIN	0.100 kg
TARA MAX	0.110 kg

The filling parameters are automatically recorded after completion of the entry or following recall from the memory. The following values are printed out:

- the target weight "TARGET"
- the upper and lower tolerance "TOLER. (+)" and "TOLER. (-)"
- the shutoff points "LIMIT 1" and "LIMIT 2" (only "LIMIT 1" with systems with 1 dispensing device)
- the minimum and maximum tare weight "TARA MIN" and "TARA MAX" (only if the filling mode "FILL In" is activated)

Recording of fillings in the filling mode

Date	25.04.97
Time	18:46
G	2.202 kg
T	0.190 kg
N	2.012 kg

The results of the filling process are automatically printed out on completion of the filling.

- the gross weight "G" (weight of the container on completion of the filling process)
- the tare weight "T" (weight of the empty container at the start of the filling process)
- the net weight "N" (weight of the added material)

Recording of fillings in the removal mode

Date	25.04.97
Time	18:52
G	3.898 kg
T	4.010 kg
N	-0.112 kg



The results of the removal process are automatically printed out on completion of the filling:

- the gross weight "G" (weight of the container on completion of the removal process)
- the tare weight "T" (weight of the full container at the start of the removal process)
- the net weight "N" (weight of the removed material)

5. Error messages

Error messages in the display draw your attention to incorrect operation or the failure of the filling application to perform a process properly. You will find additional, general error messages in the operating instructions of your Spider 3S scale.

The following table contains notes on interpreting the error messages and symptoms as well as details of their cause and rectification

Error message/symptom	Cause	Rectification
Following appears after pressing the Start key: 	<ul style="list-style-type: none"> – Last filling is still on scale – Tare monitoring is activated and no or a wrong container is on the scale 	<ul style="list-style-type: none"> • Remove filling • Place correct container on the scale
Following appears when entering filling parameters: 	<ul style="list-style-type: none"> – The inputted value is less than 1 d (1 display increment) 	<ul style="list-style-type: none"> • Increase value • Increase resolution of the scale in the master mode ("Resolution") .

6. Commands for operation via a PC

The following sections describe the commands for operation of the filling process via a PC. You will find a complete list of all commands supported by your Spider 3S scale in the interface description for the Spider and Spider 3S scales (see section 1.1).

6.1 Commands for filling

The SICS command set of the Spider 3S scale has been extended by the following commands for the filling application:

SAF Start filling application in normal mode

SAFL Start filling application in learn mode

Before the start of the filling, taring is automatically performed (except if the "FILL In" parameter is activated and the system is not ready for operation, i.e. the lowest red LED does not light up).

The **start of the application** is confirmed by the following messages:

SAF_A Filling application was started in the normal mode

SAFL_A Filling application was started in the learn mode

No other commands can be executed until completion of the ongoing filling.

The **execution of the filling application** is commented on with the following messages:

T_S_X_Y Confirms the performance of the taring (X = tare weight, Y = weighing unit)

S_S_X_Y Confirms the completion of the filling process (X = weight of the filled material, Y = weighing unit)

If the application can not be started or performed properly, one of the following **error messages** appears:

SAF_I or **SAFL_I**:

- The start command was understood but can not be executed at present

- The filling process was aborted after a timeout (no weight change within 4 seconds after the start) or manually (by pressing the Start key).

SAF_L oder **SAFL_L**

- The filling application ("FILL 1" or "FILL 2") was not activated in the master mode.

- Tare error. A subsequent message details the error:

“T-” = Taring range not reached

“T+” = Taring range exceeded

“TI” = Taring can not be performed at present

- The determined weight is below the lower tolerance.

6.2 Commands for defining and inquiry of the filling parameters

The "PM" command can be used to set and inquire the parameters for the filling.

PM_1_2_3_4_5_6_7_8_9_10_11_12

Sets the parameters for **filling with 1 dispensing device** ("FILL 1"):

- 1 Target weight
- 2 Weight unit for target weight
- 3 Upper tolerance
- 4 Weight unit for upper tolerance
- 5 Lower tolerance
- 6 Weight unit for lower tolerance
- 7 Shutoff point
- 8 Weight unit for shutoff point
- 9 Minimum tare weight
- 10 Weight unit for minimum tare weight
- 11 Maximum tare weight
- 12 Weight unit for maximum tare weight

Important: All parameters must always be specified! Admissible weight units are: "kg", "g", "t" (metric ton) and "lb" (pound).

PM_1_2_3_4_5_6_7_8_9_10_11_12_13_14

Sets all parameters for **filling with 2 dispensing devices** ("FILL 2"):

- 1 Target weight
- 2 Weight unit for target weight
- 3 Upper tolerance
- 4 Weight unit for upper tolerance
- 5 Lower tolerance
- 6 Weight unit for lower tolerance
- 7 1st shutoff point
- 8 Weight unit for 1st shutoff point
- 9 2nd shutoff point
- 10 Weight unit for 2nd shutoff point
- 11 Minimum tare weight
- 12 Weight unit for minimum tare weight
- 13 Maximum tare weight
- 14 Weight unit for maximum tare weight

Important: All parameters must always be entered! Admissible weight units are: "kg", "g", "t" (metric ton) and "lb" (pound).

PM_A

This **message** confirms that **all filling parameters were set**.

PM_L

This **error message** (instead of the confirmation PM_A) is the consequence of a plausibility error:

- The value of the lower tolerance is larger than or equal to the target weight
- The 2nd shutoff point is below the 1st shutoff point
- The minimum tare weight is larger than or equal to the maximum tare weight.

PM

Command for **inquiry of the current filling parameters**.

PM_A_1_2.....

Response to the “PM” inquiry command. The response format corresponds to the command formats described above for entry of the parameters (PM_1_2.....).

Note: All parameters are shown in the current weighing unit, irrespective of the unit they were entered in.

**To protect your METTLER TOLEDO product's future:
METTLER TOLEDO Service assures the quality, measuring
accuracy and preservation of value of all METTLER TOLEDO
products for years to come.
Please send for full details about our attractive terms of service.
Many thanks.**



P21254202

Subject to technical changes and to the availability
of the accessories supplied with the instruments.

Printed on recycled paper.
Because we care.

© Mettler-Toledo GmbH 1997 21254202 Printed in Switzerland 9707/2.12

Mettler-Toledo GmbH,

CH-8606 Greifensee, Switzerland

Tel. (01) 944 22 11, Fax (01) 944 30 60

Internet: <http://www.mt.com>

AT Mettler-Toledo Ges.m.b.H., A-1100 Wien, Tel. (01) 604 19 80, Fax (01) 604 28 80
AU Mettler-Toledo Ltd., Port Melbourne, Victoria 3207, Tel. (03) 9646 4551, Fax (03) 9645 3935
BE n.v. Mettler-Toledo s.a., B-1651 Lot, Tél. (02) 334 02 11, Fax (02) 378 16 65
BR Mettler-Toledo Indústria e Comércio Ltda., São Paulo, CEP 06465-130, Tel. (11) 421 5737, Fax (11) 725 1962
CA Mettler-Toledo Inc., Ontario L7R3Y8, Tel. (905) 681 7011, Fax (905) 681 1481
CH Mettler-Toledo (Schweiz) AG, CH-8606 Greifensee, Tel. (01) 944 45 45, Fax (01) 944 45 10
CN Mettler-Toledo Instr. (Shanghai) Ltd., Shanghai 200233, Tel. (21) 6485 0435, Fax (21) 6485 3351
CZ Mettler-Toledo, spol. s.r.o., CZ-12000 Praha 2, Tel. (02) 242 475 83, Fax (02) 242 475 83
DE Mettler-Toledo GmbH, D-35353 Giessen, Tel. (0641) 50 70, Fax (0641) 52 951
DK Mettler-Toledo A/S, DK-2600 Glostrup, Tel. (43) 27 08 00, Fax (43) 27 08 28
ES Mettler-Toledo S.A.E., E-08038 Barcelona, Tel. (03) 223 22 22, Fax (03) 223 02 71
FR Mettler-Toledo s.a., F-78222 Viroflay, Tél. (01) 309 717 17, Fax (01) 309 716 16
HK Mettler-Toledo (HK) Ltd., Kowloon HK, Tel. (852) 2744 1221, Fax (852) 2744 6878
HR Mettler-Toledo, d.o.o., CR-10010 Zagreb, Tel. (5) 1 660 21 89, Fax (5) 1 660 30 09
HU Mettler-Toledo, Kereskedelmi KFT, H-1173 Budapest, Tel. (01) 257 15 30, Fax (01) 257 98 89
IT Mettler-Toledo S.p.A., I-20026 Novate Milanese, Tel. (02) 333 321, Fax (02) 356 29 73
JP Mettler-Toledo K.K., Shiomi, J-Osaka 540, Tel. (6) 949 5901, Fax (6) 949 5944
KR Mettler-Toledo (Korea) Ltd., Seoul (135-090), Tel. (02) 518 20 04, Fax (02) 518 08 13
MY Mettler-Toledo (M) Sdn.Bhd., 47301 Petaling Jaya, Tel. (03) 703 2773, Fax (03) 703 8773
MX Mettler-Toledo S.A. de C.V., Mexico CP 06430, Tel. (5) 547 5700, Fax (5) 541 2228
NL Mettler-Toledo B.V., NL-4000 HA Tiel, Tel. (0344) 638 363, Fax (0344) 638 390
NO Mettler-Toledo A/S, N-1008 Oslo, Tel. (22) 30 44 90, Fax (22) 32 70 02
PL Mettler-Toledo, Sp. z o.o., PL-02-929 Warszawa, Tel. (22) 651 92 32, Fax (22) 42 20 01
RU Mettler-Toledo AG, 10 1000 Moskau, Tel. (095) 921 68 12, Fax (095) 921 63 53
SE Mettler-Toledo AB, S-12008 Stockholm, Tel. (08) 702 50 00, Fax (08) 642 45 62
SG Mettler-Toledo (S) Pte. Ltd., Singapore 139944, Tel. (65) 778 6779, Fax (65) 778 6639
SK Mettler-Toledo, spol. s.r.o., SK-83103 Bratislava, Tel. (07) 525 21 73, Fax (07) 525 21 70
SL Mettler-Toledo, d.o.o., SL-61111 Ljubljana, Tel. (06) 127 45 75, Fax (06) 127 45 75
TH Mettler-Toledo (Thailand), Bangkok 10310, Tel. (02) 719 64 80, Fax (02) 719 64 79
TW Mettler-Toledo Pac Rim AG, Taipei, Tel. (62) 579 59 55, Fax (62) 579 59 77
UK Mettler-Toledo Ltd., Leicester, LE4 1AW, Tel. (0116) 235 0888, Fax (0116) 236 5500
US Mettler-Toledo, Inc., Worthington, Ohio 43085, Tel. (614) 438 4511, Fax (614) 438 4755
US Mettler-Toledo, Inc., Hightstown, NJ 08520-0071, Tel. (609) 448 3000, Fax (609) 586 5451
For all other countries: Mettler-Toledo GmbH, PO Box VI-400, CH-8606 Greifensee, Tel. (01) 944 22 11, Fax (01) 944 31 70