

Measuring Module M 700[®] Out 700(X)

Output Module with 2 Current Outputs
and 4 Relay Outputs



52121218

METTLER TOLEDO



71954

Warranty

Defects occurring within 1 year from delivery date shall be remedied free of charge at our plant (carriage and insurance paid by sender). Sensors, fittings, and accessories: 1 year.

©2007 Subject to change without notice

Return of Products Under Warranty

Please contact our Service Team before returning a defective device. Ship the cleaned device to the address you have been given. If the device has been in contact with process fluids, it must be decontaminated/disinfected before shipment. In that case, please attach a corresponding certificate, for the health and safety of our service personnel.

Disposal

Please observe the applicable local or national regulations concerning the disposal of "waste electrical and electronic equipment".

Trademarks

The following registered trademarks are used in this instruction manual without further marking

SMARTMEDIA®

is a registered trademark of Toshiba Corp., Japan

FOUNDATION FIELDBUS™

is a trademark of Fieldbus Foundation, Austin, USA

Mettler-Toledo AG,
Process Analytics, Industrie Nord, CH-8902 Urdorf,
Tel. +41 (44) 729 62 11 Fax +41 (44) 729 26 36
Subject to technical changes.



Declaration of conformity Konformitätserklärung Déclaration de conformité



We/Wir/Nous

Mettler-Toledo GmbH, Process Analytics
Im Hackacker 15
8902 Urdorf
Switzerland

declare under our sole responsibility that the product,
erklären in alleiniger Verantwortung, dass dieses Produkt,
déclarons sous notre seule responsabilité que le produit,

Description

Beschreibung/Description

Out 700

to which this declaration relates is in conformity with the following standard(s) or other normative document(s).

auf welches sich diese Erklärung bezieht, mit der/den folgenden Norm(en) oder Richtlinie(n) übereinstimmt.

auquel se réfère cette déclaration est conforme à la (aux) norme(s) ou au(x) document(s) normatif(s).

Low-voltage directive/Nieder-
spannungs-Richtlinie/
Directive basse tension

73/23/EWG

Norm/Standard/Standard

| | | |
|-------------------------|-------------------------|---------|
| EN 60529 / 10.91 | / VDE 0470 Teil 1: | 1992-11 |
| EN 61010 Teil 1 / 03.93 | / VDE 0411 Teil 1: | 1994-03 |
| EN 61010-1 / A2 / 07.95 | / VDE 0411 Teil 1 / A1: | 1996-05 |

EMC Directive/EMV-
Richtlinie
Directive concernant la
CEM

89/336/EWG

Norm/Standard/Standard

| | | |
|---------------|--------------------------|---------|
| EN 61326 | / VDE 0843 Teil 20: | 1998-01 |
| EN 61326 / A1 | / VDE 0843 Teil 20 / A1: | 1999-05 |

Place and Date of issue
Ausstellungsort / - Datum
Lieu et date d'émission

Urdorf, August 28, 2003

Mettler-Toledo GmbH, Process Analytics

Waldemar Rauch
General Manager PO Urdorf

Christian Zwicky
Head of Marketing

METTLER TOLEDO



Declaration of conformity Konformitätserklärung Déclaration de conformité



We/Wir/Nous **Mettler-Toledo GmbH, Process Analytics**
Im Hackacker 15
8902 Urdorf
Switzerland

declare under our sole responsibility that the product,
erklären in alleiniger Verantwortung, dass dieses Produkt,
déclarons sous notre seule responsabilité que le produit,

Description
Beschreibung/Description **Out 700X**

to which this declaration relates is in conformity with the following standard(s) or other normative document(s).
auf welches sich diese Erklärung bezieht, mit der/den folgenden Norm(en) oder Richtlinie(n) übereinstimmt.
auquel se réfère cette déclaration est conforme à la (aux) norme(s) ou au(x) document(s) normalif(s).

Explosion protection **94/9/EG**
Explosionsschutzrichtlinie **KEMA 04 ATEX 2056**
Prof. contre les explosions **NL-6812 AR Arnhem, KEMA 0344**

Low-voltage directive
Niederspannungs-Richtlinie
Directive basse tension **73/23/EWG**

EMC Directive
EMV-Richtlinie
Directive concernant la CEM **89/336/EWG**

Place and Date of issue
Ausstellungsort / - Datum **Urdorf, July 16, 2004**
Lieu et date d'émission

Mettler-Toledo GmbH, Process Analytics

Waldemar Rauch
General Manager Ingold

Christian Zwicky
Head of Marketing

Mettler-Toledo GmbH

Process Analytics

Adresse Im Hackacker 15 (Industrie Nord), CH-8902 Urdorf, Schweiz
Briefadresse Postfach, CH-8902 Urdorf
Telefon 01-736 22 11
Telefax 01-736 26 36
Internet www.mt.com
Bank Credit Suisse First Boston, Zürich (Acc. 0835-370501-21-90)

| | | |
|-------------------------------|--------------------|--|
| <u>Norm/Standard/Standard</u> | 94/9/EG: | EN 50014 EN 50020 EN 50281-1-1 EN 50284 |
| | 73/23/EWG: | DIN EN 61010-1 / VDE 0411 Teil 1: 2002-08 |
| | 89/336/EWG: | DIN EN 61326 / VDE 0843 Teil 20: 2002-03 |

METTLER TOLEDO



KE Out 700X-b.doc

Contents

| | |
|---|-----------|
| Warranty | 2 |
| Disposal | 2 |
| Trademarks | 2 |
| EC Declaration of Conformity | 3 |
| Intended Use | 9 |
| Conformity with FDA 21 CFR Part 11 | 9 |
| Safety Information | 10 |
| Application in Hazardous Locations: Out 700X Module | 10 |
| Software Version | 11 |
| Modular Concept | 13 |
| Short Description..... | 14 |
| Short Description: FRONT Module..... | 14 |
| Short Description: Menu Structure..... | 15 |
| Short Description: BASE Module..... | 17 |
| Terminal Plate Out 700(X) Module | 18 |
| Inserting the Module..... | 19 |
| Wiring Examples | 20 |
| Menu Selection | 21 |
| Menu Structure | 21 |
| Passcode Entry | 22 |
| Changing a Passcode..... | 22 |
| Passcode Lost | 22 |
| Configuring the Measurement Display | 23 |
| Parameter Setting: Operating Levels..... | 25 |
| Administrator Level..... | 25 |
| Operator Level..... | 25 |
| Viewing Level | 25 |
| Parameter Setting: Lock Functions | 26 |
| Activating Parameter Setting..... | 27 |
| Documenting Parameter Setting | 28 |
| Configuring the Module | 30 |
| Messages: Default Settings and Selection Range..... | 33 |
| Device Limits..... | 33 |

Contents

| | |
|---|-----------|
| Current Outputs | 35 |
| Assignment of Measured Values: Start (4 mA) and End (20 mA) | 35 |
| Configuring the Current Output | 35 |
| Current Outputs: Characteristics | 36 |
| Output Filter | 38 |
| NAMUR Signals: Current Outputs | 39 |
| Icons in the Measurement Display | 40 |
| Limit Value, Hysteresis, Contact Type | 40 |
| Maintenance, Diagnostics | 41 |
| Activating Diagnostics | 42 |
| Message List | 42 |
| Specifications | 44 |
| Overview of Parameter Setting | 46 |
| Index | 50 |

Intended Use

The module is a general-purpose output module with 2 passive current outputs for transmission of any desired process variables and 4 electronic relay outputs for limit monitoring.

The Out 700X module is intended for operation in locations subject to explosion hazards which require equipment of Group II, device category 2(1), gas/dust.

Conformity with FDA 21 CFR Part 11

In their directive "Title 21 Code of Federal Regulations, 21 CFR Part 11, Electronic Records; Electronic Signatures" the US American health agency FDA (Food and Drug Administration) regulates the production and processing of electronic documents for pharmaceutical development and production. This results in requirements for measuring devices used for corresponding applications. The following features ensure that the M 700 modular process analysis system meets the demands of FDA 21 CFR Part 11:

Electronic Signature

Access to the device functions is regulated and limited by individually adjustable codes – "Passcodes". This prevents unauthorized modification of device settings or manipulation of the measurement results. Appropriate use of these passcodes makes them suitable as electronic signature.

Audit Trail Log

Every change of device settings can be automatically recorded and documented in the Audit Trail Log on the SmartMedia card. The recording can be encrypted.

Safety Information

Application in Hazardous Locations

Caution!

Never try to open the module! If a repair should be required, return the module to our factory.

If the specifications in the instruction manual are not sufficient for assessing the safety of operation, please contact the manufacturer to make sure that your intended application is possible and safe.

Be sure to observe during installation:

- Switch off power supply before replacing or inserting a module.
- Before commissioning it must be proved that the device may be connected with other equipment.

Application in Hazardous Locations:

Out 700X Module

When using the M 700 Out 700 X module, the stipulations for electrical installations in hazardous areas (EN 60079-14) must be observed.

When installing the device outside the range of applicability of the 94/9/EC directive, the appropriate standards and regulations in the country of use must be observed. The module has been developed and manufactured in compliance with the applicable European guidelines and standards.

Compliance with the European Harmonized Standards for use in hazardous locations is confirmed by the EC-Type-Examination Certificate.

Compliance with the European guidelines and standards is confirmed by the EC Declaration of Conformity.

There is no particular direct hazard caused by the operation of the device in the specified environment.

Software Version

Out 700(X) Module

Device Software M 700(X)

The Out 700 module is supported by software version 3.0 or higher.
The Out 700X module is supported by software version 4.0 or higher.

Module Software Out 700(X)

Software version 1.1

Query Actual Device/Module Software

When the analyzer is in measuring mode:
Press **menu** key, open Diagnostics menu.

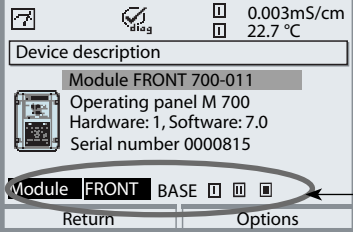
| Menu | Display | Device description |
|--|---|--|
|  |  | <p>Provides information about all modules installed: Module type and function, serial number, hardware and software version and device options.</p> <p>Select the different modules (FRONT, BASE, slots 1 - 3) using the arrow keys.</p> |

Modular Concept

Basic Unit, Measuring Module, Additional Functions

The M 700(X) is an expandable modular process analysis system. The basic unit (FRONT and BASE modules) provides three slots which can be equipped by the user with any combination of measuring or communication modules. The software capabilities can be expanded by additional functions (options). Additional functions must be ordered separately. They are supplied with a device-specific TAN for function release.

M 700(X) Modular Process Analysis System

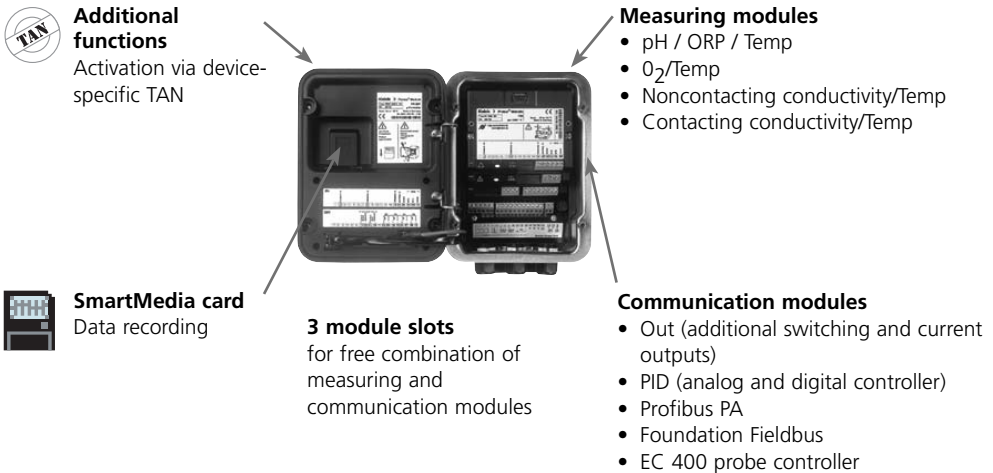

Documentation

The basic unit is accompanied by a CD-ROM containing the complete documentation.

Latest product information as well as instruction manuals for earlier software releases are available at www.mt.com/pro.

Short Description

Short Description: FRONT Module

4 captive screws

for opening the analyzer

(Caution! Make sure that the gasket between FRONT and BASE is properly seated and clean!)

Transflective LC graphic display

(240 x 160 pixels)

white backlighting, high resolution and high contrast.



Measurement display

User interface

with plaintext menus as recommended by NAMUR.

Menu texts can be switched to: German, English, French, Italian, Swedish, and Spanish.

Intuitively acquirable menu logic, based on Windows standards.

Secondary displays

2 softkeys

with context-sensitive functions.

Red LED

signals failure (On) or maintenance request/function check (flashing) according to NE 44.

Green LED

Voltage supply okay

Control panel

3 function keys

(menu, meas, enter)

and 4 arrow keys for menu selection

and data entries

5 self-sealing cable glands

M20 x 1.5

for entry of voltage supply and signal lines

Short Description: Menu Structure

Basic Functions: Calibration, Maintenance, Parameter Setting, Diagnostics

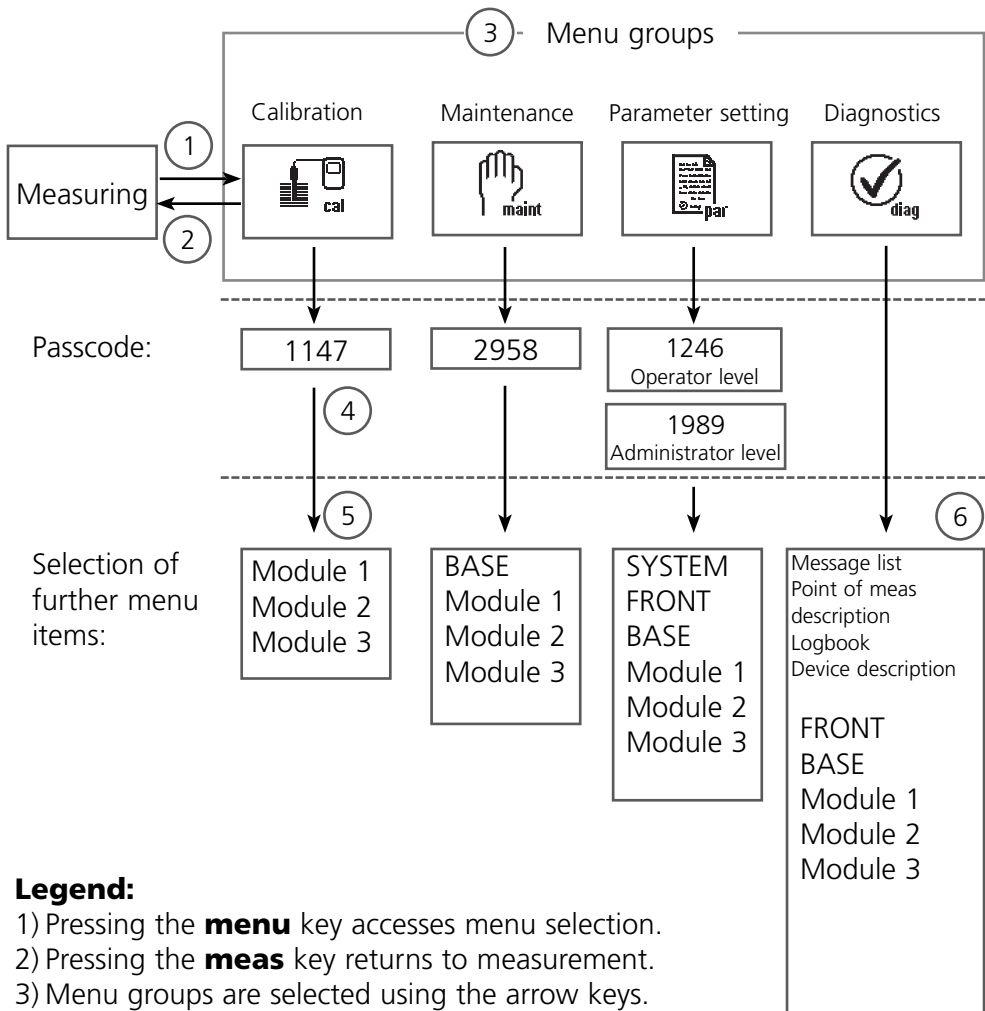

Legend:

- 1) Pressing the **menu** key accesses menu selection.
- 2) Pressing the **meas** key returns to measurement.
- 3) Menu groups are selected using the arrow keys.
- 4) Press **enter** to confirm, enter passcode.
- 5) Further menu items are displayed.
- 6) Selected functions of the Diagnostics menu can be recalled via softkey even when in measuring mode.

Short Description: FRONT Module

View into the open device (FRONT module)

Slot for SmartMedia card

- Data recording
The SmartMedia card expands the measurement recorder capacity to > 50000 records.
- Exchange of parameter sets
5 parameter sets can be stored on the SmartMedia card. The 2 internal parameter sets can be switched by remote control. Configurations can be transmitted from one analyzer to the other.
- Function expansions
are possible with additional software modules, which are released using transaction numbers (TAN)
- Software updates

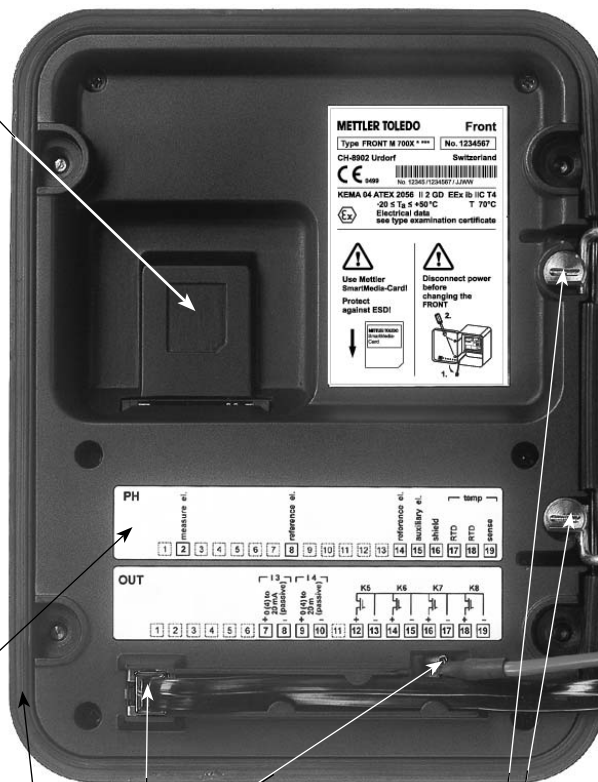

Terminal plates of "hidden" modules

Each module comes with an adhesive label containing the contact assignments. This label should be stuck to the inner side of the front (as shown). Then, the terminal assignments remain visible even if further modules are inserted.

Replacing the front module

Pull off power cord and ground wire. To separate the FRONT module from the BASE module, turn the retaining screws of the pivot hinge by 90°.

The circumferential sealing

guarantees IP 65 protection and allows spray cleaning / disinfection.

Caution! Keep clean!

Short Description: BASE Module

View into the open device (BASE module, 3 function modules installed)

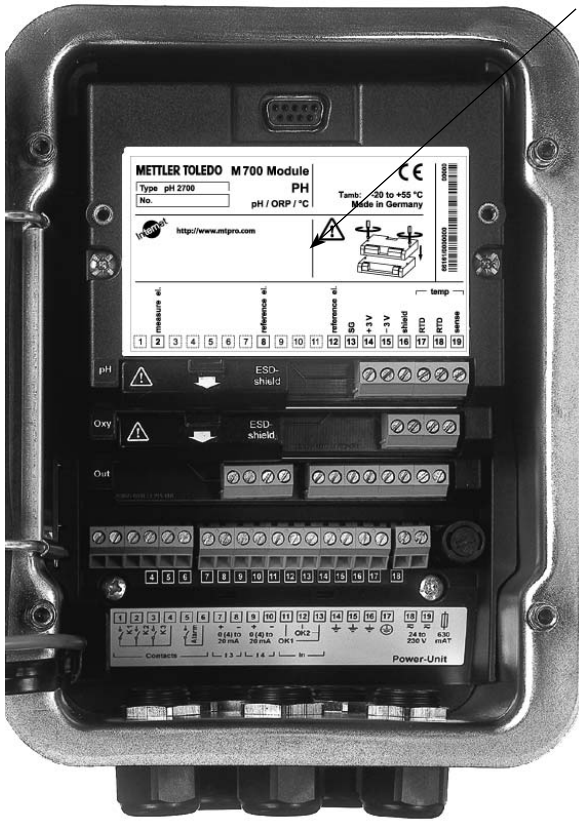

Module equipment

Module identification: Plug & Play.

Up to 3 modules can be combined as desired. Several input and communication modules are available.

BASE module

2 current outputs (free assignment of process variable) and 4 relay contacts, 2 digital inputs.

VariPower broad-range power supply, 20 ... 265 V AC/DC, suitable for all public mains supplies in the world.

Power supply units, IS version:

100 ... 230 V AC or
24 V AC/DC



Warning!

Do not touch the terminal compartment, there may be dangerous contact voltages!

Important Notice Concerning SmartMedia Card

The SmartMedia card may be inserted or replaced with the power supply switched on. Before a memory card is removed, it must be "closed" in the maintenance menu. When closing the device, make sure that the sealing is properly seated and clean.

Terminal Plate Out 700(X) Module

Terminal Plate Out 700 Module:

| | | | | | |
|--|---------|------------------|--|---------------------|--|
| METTLER TOLEDO M 700 Module | | OUT | | CE | |
| Type | Out 700 | analog / digital | | Tamb: -20 to +55 °C | |
| No. | | | | Made in Germany | |
| Internet http://www.mt.com | | | | | |
| | | | | | |

Terminal Plate Out 700X Module:

| | | | | | |
|---|-----------|------------------|--|------------------------|--|
| METTLER TOLEDO M 700X Module | | OUT | | CE | |
| Type | OUT 700 X | analog / digital | | Tamb: -20 to +50 °C | |
| No. | | | | Made in Germany/Kassel | |
| | | | | | |
| <p>Ex KEMA 04 ATEX 2056 Electr. data see type examination certificate II 2 GD EEx ib IIC T4 T 70 °C CH-8902 Urdorf Switzerland</p> <p>FM IS, CLASS I, DIV1, GRP A, B, C, D, T4 Entity, Ta = 50 °C APPROVED CLASS I, ZONE 1, AEx ib [ia], GRP IIC, T4 control dwg. 201.004-110</p> <p>SR NI, CII, DIV 2, GRP A, B, C, D with IS circuits extending into DIV 1 AIS, CI I, Zone 1, Ex ib [ia] IIC T4 control dwg. 201.004-120</p> | | | | | |
| | | | | | |

Attaching the Terminal Plates

The terminal plates of the lower modules can be stuck to the inner side of the door. This facilitates maintenance and service.



Inserting the Module

Note: Be sure to connect the shielding properly!

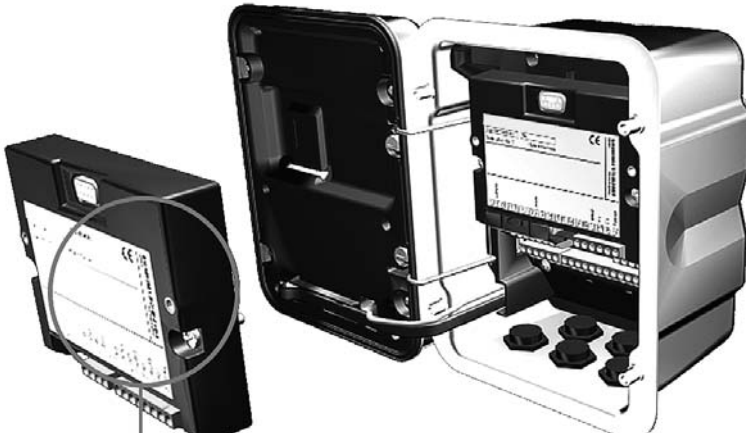

Thanks to the staggered arrangement of connectors and fastening screws the terminal strips of all modules are easy to access.

Make sure that the cable glands are tightly closed to protect against humidity.

1. Switch off power supply
2. Open the device (loosen the 4 screws at the front)
3. Place module in slot (D-SUB connector)
4. Tighten fastening screws of the module
5. Connect signal lines.
6. Close device, tighten screws at the front
7. Switch on power supply
8. Set parameters

Wiring Examples

Current Output, Relay Contacts

Wiring Example 1

Current outputs I 3, I 4 (passive, supply unit required)

Output

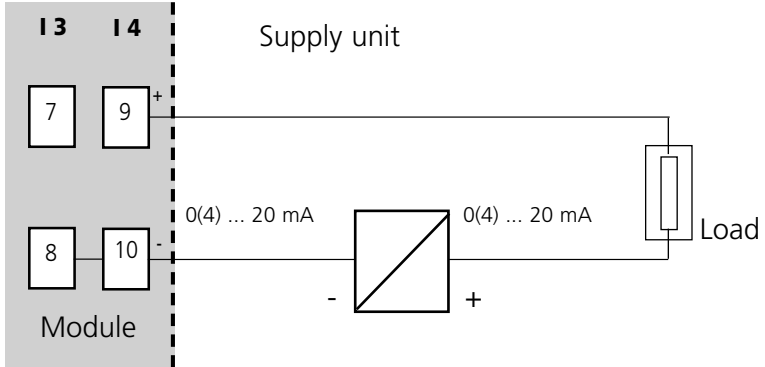

Wiring Example 2

Electronic relay contacts

Limit contact

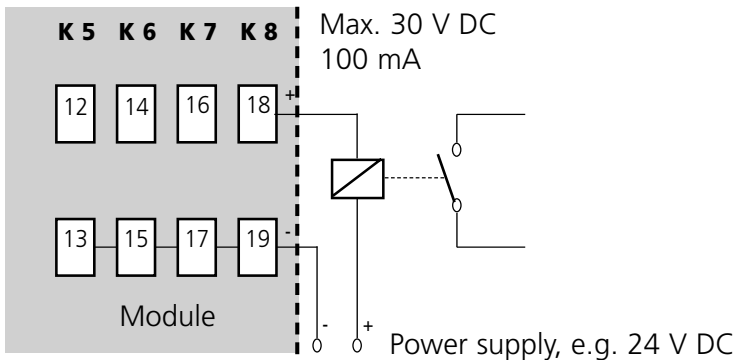

Menu Selection

After switching on, the analyzer performs an internal test routine and automatically detects the number and type of modules installed. Then, the analyzer goes to measuring mode.

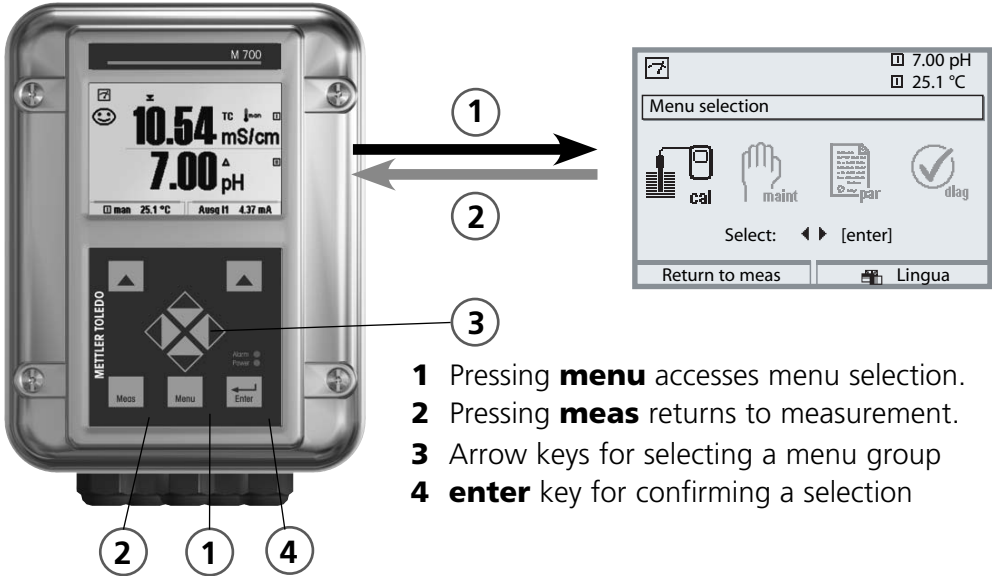

Menu Structure

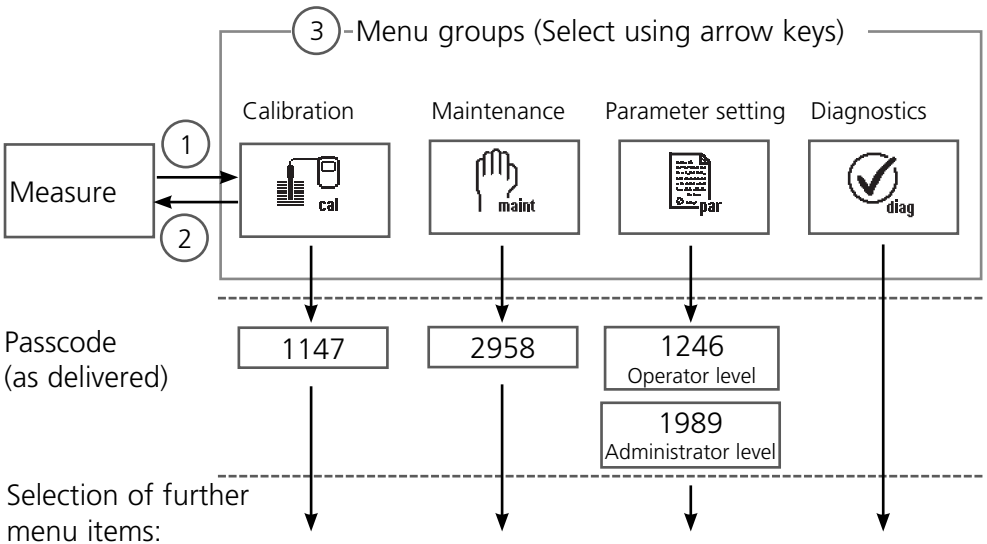

Passcode Entry

To enter a passcode

Select the position using the left/right keys, then edit the number using the up/down keys. When all numbers have been entered, confirm with **enter**.

To change a passcode

- Open the menu selection (**menu**)
- Select parameter setting
- Administrator level, enter passcode
- Select System control: Passcode entry

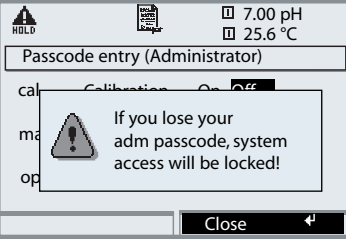
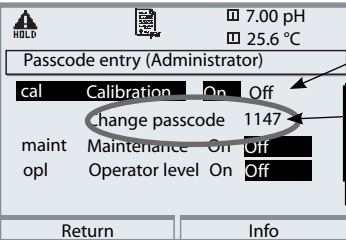
| Menu | Display | System control: Passcode entry | | | | | | | | |
|--|--|--|-------------|------|-------------|------|----------------|------|---------------------|------|
|  |   | <h3>Changing a passcode "Passcode entry" menu</h3> <p>When this menu is opened, the analyzer displays a warning (Fig.). Passcodes (factory settings):</p> <table data-bbox="568 810 919 938"> <tr> <td>Calibration</td> <td>1147</td> </tr> <tr> <td>Maintenance</td> <td>2958</td> </tr> <tr> <td>Operator level</td> <td>1246</td> </tr> <tr> <td>Administrator level</td> <td>1989</td> </tr> </table> <p>If you lose the passcode for the Administrator level, system access will be locked! Please consult our technical support!</p> <p>To change a passcode Select "On" using arrow keys, confirm with enter. Select the position using the left/right keys, then edit the number using the up/down keys. When all numbers have been entered, confirm with enter.</p> | Calibration | 1147 | Maintenance | 2958 | Operator level | 1246 | Administrator level | 1989 |
| Calibration | 1147 | | | | | | | | | |
| Maintenance | 2958 | | | | | | | | | |
| Operator level | 1246 | | | | | | | | | |
| Administrator level | 1989 | | | | | | | | | |

Configuring the Measurement Display

Select menu: Parameter setting/Module FRONT/Measurement display

Pressing **meas** (1) returns the analyzer to the measuring mode from any function.

All process variables coming from the modules can be displayed. The table on the next page describes how to configure the measurement display.

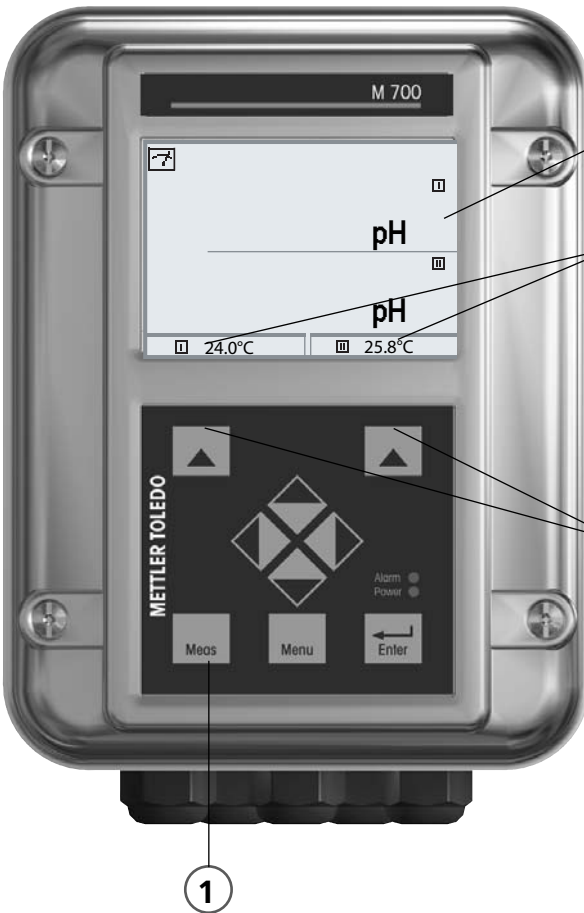

Measurement display



Typical display for 2 pH measurement points.

Secondary displays

Additional values, also date and time, can be displayed depending on the modules installed.

Softkeys

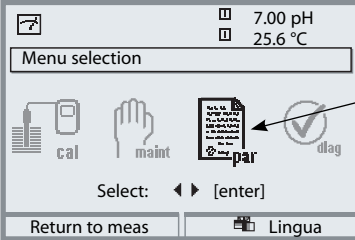
In measuring mode, the softkeys allow selection of values for the secondary displays or control of functions (user defined).

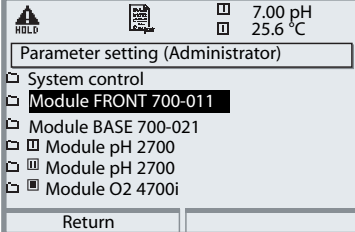
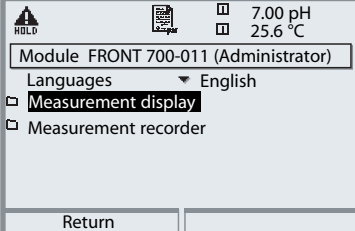
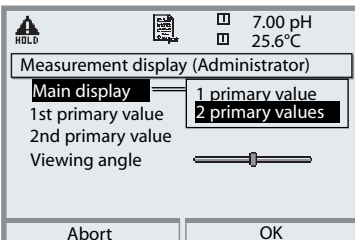
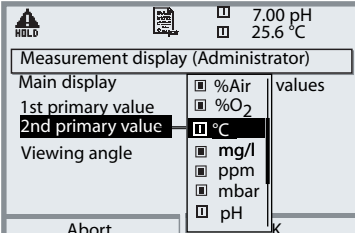
| Menu | Display | Configure measurement display |
|--|---|---|
| |  | <p>Configure measurement display Press menu key to Menu selection Select parameter setting using arrow keys, confirm with enter. Select: “Administrator level”: Passcode 1989 (default setting).</p> |
|  |  | <p>Parameter setting: Select “Module FRONT”</p> |
| |  | <p>Front module: Select “Measurement display”</p> |
| |  | <p>Measurement display: Set the number of primary values (large display) to be displayed</p> |
| |  | <p>Select process variable(s) to be displayed and confirm with enter.</p> <p>Pressing the meas key returns to measurement.</p> |

Parameter Setting: Operating Levels

Viewing level, Operator level, Administrator level

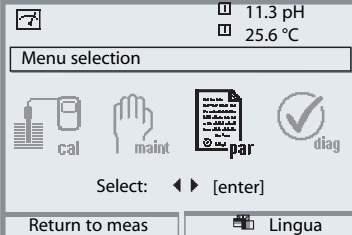
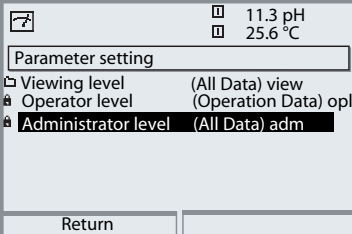
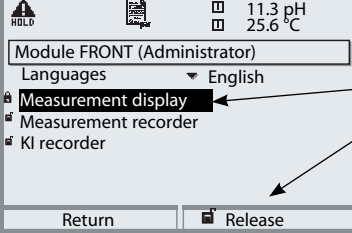
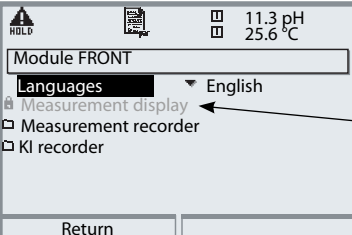

Note: HOLD mode (Setting: BASE module)

| Menu | Display | Viewing level, Operator level, Administrator level |
|--|---|--|
|  |  | <p>Call up parameter setting</p> <p>From the measuring mode: Press menu key to select menu. Select parameter setting using arrow keys, confirm with enter.</p> |
| |  | <p>Administrator level</p> <p>Access to all functions, also passcode setting. Releasing or blocking a function for access from the Operator level.</p> |
| |  | <p>Functions which can be blocked for the Operator level are marked with the "lock" symbol. The functions are released or blocked using the softkey.</p> |
| |  | <p>Operator level</p> <p>Access to all functions which have been released at the Administrator level. Blocked functions are displayed in gray and cannot be edited (Fig.).</p> <p>Viewing level</p> <p>Display of all settings. No editing possible!</p> |

Parameter Setting: Lock Functions

Administrator level: Enable / lock functions for Operator level

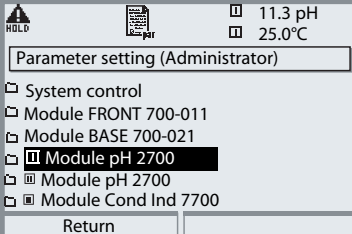
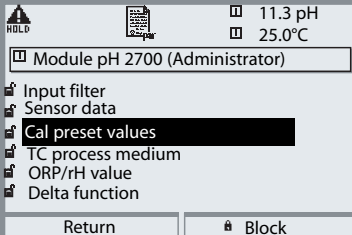
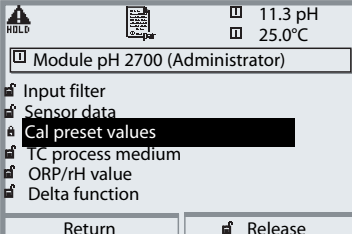
Note: HOLD mode (Setting: BASE module)

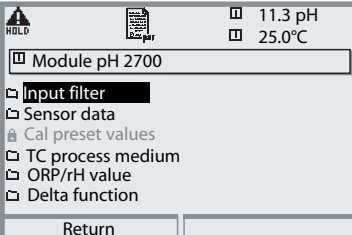
| Menu | Display | Administrator level: Enable / lock functions |
|--|---|---|
|  |  | <p>Example: Blocking access to the calibration adjustments from the Operator level</p> <p>Call up parameter setting Select Administrator level. Enter passcode (1989). Select "Module pH" (e.g.) using arrow keys, confirm with enter.</p> |
| |  | <p>Select "Cal preset values" using arrow keys. "Block" with softkey.</p> |
| |  | <p>Now, the "Cal preset values" line is marked with the "lock" icon. This function cannot be accessed from the Operator level any more. The softkey function changes to "Release".</p> |
|  |  | <p>Call up parameter setting Select <u>Operator level</u>, passcode (1246). Select "Module pH" (e.g.). Now, the locked function is displayed in gray and marked with the "lock" icon.</p> |

Activating Parameter Setting

Call up parameter setting

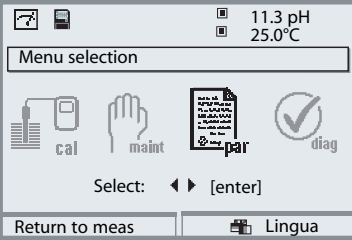
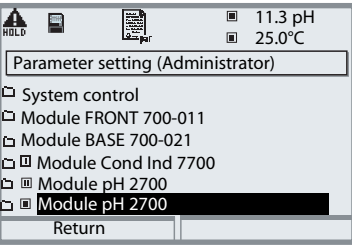
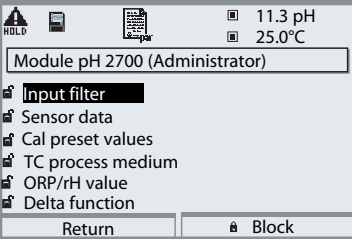
| Menu | Display | Parameter setting |
|--|--|--|
|  |  | <p>Call up parameter setting From the measuring mode: Press menu key to select menu. Select parameter setting using arrow keys, confirm with enter. Passcode as delivered: 1989</p> |
| |  | <p>Select module, confirm with enter.</p> <p>(In the Figure, the Module "pH" is selected, for example.)</p> |
| |  | <p>Select parameter using arrow keys, confirm with enter.</p> |

During parameter setting the analyzer is in HOLD mode:

Current outputs and relay contacts behave as configured (BASE module).

Documenting Parameter Setting

You must reproducibly document all parameter settings in the device to achieve a high level of system and device security according to GLP. For that purpose, an Excel file is provided (on the CD-ROM shipped with the basic device or as download at www.mt.com/pro) to enter the parameter settings.

The Excel file provides one worksheet for each module with columns for the following parameters: Factory settings, parameter set A, parameter set B. Enter your settings as parameter set A or B.

The gray cells in the parameter set B column cannot be modified since they contain sensor-specific values which cannot be changed by parameter set switchover. Here, the values listed under parameter set A apply.

Documenting Parameter Setting

| | A | B | C | D | E | F |
|----|-------|----------------------------------|-------------------------|------------------------|------------------------|---|
| 1 | | | | | | |
| 2 | 1. | Meßstelle: | | | | Zugriff über Menüpunkt: |
| 3 | | M 700 | | | | |
| 4 | 1.1. | parametrier am / von: | | | | |
| 5 | | | | | | |
| 6 | | | | | | |
| 7 | 2. | Gerätebeschreibung | Hardware | Software | Seriennummer | Diagnose / Gerätebeschreibung |
| 8 | 2.1. | Bedienfront 700-011 : | | | | Diagnose / Gerätebeschreibung / Front |
| 9 | 2.2. | M 700 Base 700-021 : | | | | Diagnose / Gerätebeschreibung / Base |
| 10 | 2.3. | Modul Steckplatz [I] : | | | | Diagnose / Gerätebeschreibung / I |
| 11 | 2.4. | Modul Steckplatz [II] : | | | | Diagnose / Gerätebeschreibung / II |
| 12 | 2.5. | Modul Steckplatz [III] : | | | | Diagnose / Gerätebeschreibung / III |
| 13 | | | | | | |
| 14 | | | | | | |
| 15 | | M 700 Front | | | | |
| 16 | 3. | M 700 Front Einstellungen | Werkseinstellung | Parametersatz A | Parametersatz B | |
| 17 | 3.1. | Sprache: | Deutsch | | | Parametrierung (Spezialist) / Modul Front ... |
| 18 | | | | | | |
| 19 | 3.1.1 | Meßwertanzeige: | | | | |
| 20 | | Hauptanzeige | 2 Hauptmeßwerte | | | Parametrierung (Spezialist) / Modul Front ... / Meß |
| 21 | | 1. Hauptmeßwert (Modul/Wert): | modulabhängig | | | |
| 22 | | 2. Hauptmeßwert (Modul/Wert): | modulabhängig | | | |
| 23 | | Anzeigeformat (pH) | xx.xx pH | | | |
| 24 | | Blickwinkel | Mitte | | | |
| 25 | | | | | | |
| 26 | 3.3. | Nebenanzeige | | | | Einstellung erfolgt über Softkeys, wenn in Matrixfu |
| 27 | | Anzeigewert, links | - | | | |
| 28 | | Anzeigewert, rechts | - | | | |
| 29 | | | | | | |
| 30 | 3.4 | Meßwertrecorder: | Option SW700-103 | | | Parametrierung (Spezialist) / Modul Front ... / Meß |
| 31 | | Zeitbasis (t / Pixel) | 1 min | | | |
| 32 | | Zeitlupe (10x) | Aus | | | |
| 33 | | Min / Max anzeigen | Ein | | | |
| 34 | 3.4.1 | Kanal 1: Meßgröße | modulabhängig | | | |
| 35 | | Anfang | 0.00 | | | |
| 36 | | Ende | 14.00 | | | |
| 37 | 3.4.2 | Kanal 2: Meßgröße | modulabhängig | | | |
| 38 | | Anfang | -50.0 | | | |
| 39 | | Ende | 150.0 | | | |

From the application window of the Excel file, select the worksheet for the module the parameter settings of which you want to document. Set the parameters of the respective module and enter the selected values in the corresponding cells of the module worksheet.

Caution!

| | |
|---|---|
| Display | During parameter setting the "HOLD" mode is active. |
|  | <p>HOLD. The NAMUR "function check" contact is active (factory setting: Module BASE, Contact K2, N/O contact). Current output response is user-defined:</p> <ul style="list-style-type: none"> • Current meas.: The currently measured value appears at the current output • Last usable value: The last measured value is held at the current output • Fixed 22 mA: The output current is at 22 mA |

Configuring the Module

Activating Parameter Setting

Note: HOLD mode active

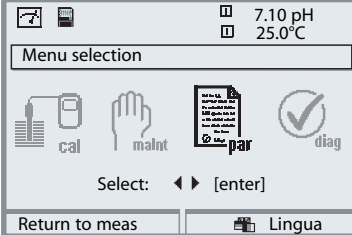
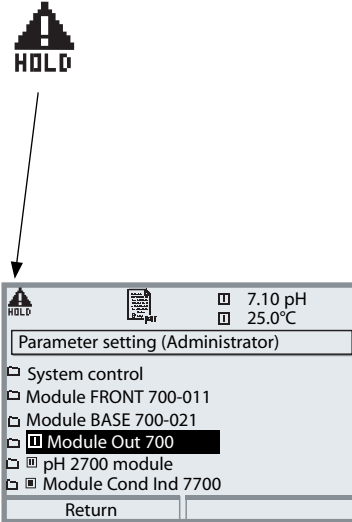
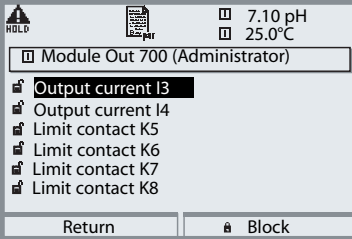
| Menu | Display | Parameter setting |
|--|---|---|
|  |  | <p>Call up parameter setting</p> <p>From the measuring mode: Press menu key to select menu. Select parameter setting using arrow keys, confirm with enter. Passcode 1989 (To change passcode: Parameter setting/System control/Passcode entry).</p> |
| |  | <p>HOLD</p> <p>During parameter setting the analyzer is in "HOLD" mode. Current outputs and relay contacts behave as configured.</p> <p>Select "Module Out 700". Confirm with enter</p> |
| |  | <p>Select parameter using arrow keys, confirm with enter.</p> |

Parameter Setting

Default Settings and Selection Range

Note: HOLD mode

| Parameter | Default | Selection / Range |
|---|---|---|
| Output current I3 <ul style="list-style-type: none"> • Process variable • Characteristic • Output • Output filter Behavior during messages <ul style="list-style-type: none"> • HOLD • 22 mA message | Off Linear 4 ... 20 mA 0000 sec Last usable value On | Depending on modules installed: Off, S/cm, °C, % by wt, g/kg, Ωcm, pH, ORP, rH, etc. Linear, trilinear, function, table 0 ... 20 mA, 4 ... 20 mA XXXX sec Current meas., Last usable value, Fixed 22mA On, Off |
| Output current I4 <ul style="list-style-type: none"> • Process variable • Characteristic • Output • Output filter Behavior during messages <ul style="list-style-type: none"> • HOLD • 22 mA message | Off Linear 4 ... 20 mA 0000 sec Last usable value On | Depending on modules installed: Off, S/cm, °C, % by wt, g/kg, Ωcm, pH, ORP, rH, etc. Linear, trilinear, function, table 0 ... 20 mA, 4 ... 20 mA XXXX sec Current meas., Last usable value, Fixed 22mA On, Off |

| Parameter | Default | Selection / Range |
|--|--|--|
| Limit contact K5 <ul style="list-style-type: none"> • Process variable • Limit value • Hysteresis • Effective direction • Contact type • ON delay • OFF delay | (Module) (Module) (Module) Min N/O 0000 sec 0000 sec | Depending on modules installed: Off, S/cm, °C, % by wt, g/kg, Ωcm, pH, ORP, rH, etc. Entry Entry Min, Max Normally open N/O, normally closed N/C XXXX entry XXXX entry |
| Limit contact K6 <ul style="list-style-type: none"> • Process variable • Limit value • Hysteresis • Effective direction • Contact type • ON delay • OFF delay | (Module) (Module) (Module) Min N/O 0000 sec 0000 sec | Depending on modules installed: Off, S/cm, °C, % by wt, g/kg, Ωcm, pH, ORP, rH, etc. Entry Entry Min, Max Normally open N/O, normally closed N/C XXXX entry XXXX entry |
| Limit contact K7 <ul style="list-style-type: none"> • Process variable • Limit value • Hysteresis • Effective direction • Contact type • ON delay • OFF delay | S/cm 07.00 μS/cm 0.100 μS/cm Min N/O 0000 sec 0000 sec | Depending on modules installed: Off, S/cm, °C, % by wt, g/kg, Ωcm, pH, ORP, rH, etc. Entry Entry Min, Max Normally open N/O, normally closed N/C XXXX entry XXXX entry |
| Limit contact K8 <ul style="list-style-type: none"> • Process variable • Limit value • Hysteresis • Effective direction • Contact type • ON delay • OFF delay | (Module) (Module) (Module) Min N/O 0000 sec 0000 sec | Depending on modules installed: Off, S/cm, °C, % by wt, g/kg, Ωcm, pH, ORP, rH, etc. Entry Entry Min, Max Normally open N/O, normally closed N/C XXXX entry XXXX entry |

Parameter Setting

Messages: Default settings and selection range

Note: HOLD mode active

| Parameter | Default | Selection / Range |
|---|---|--|
| Messages <ul style="list-style-type: none"> • pH value • ORP value • rH value • Temperature • mV value | Limits max Off Off Limits max Off | Off, device limits max., variable limits* Off, device limits max., variable limits* Off, device limits max., variable limits* Off, device limits max., variable limits* Off, device limits max., variable limits* * With "Variable limits" selected, the following parameters can be edited: <ul style="list-style-type: none"> • Failure Limit Lo • Warning Limit Lo • Warning Limit Hi • Failure Limit Hi |

Device Limits



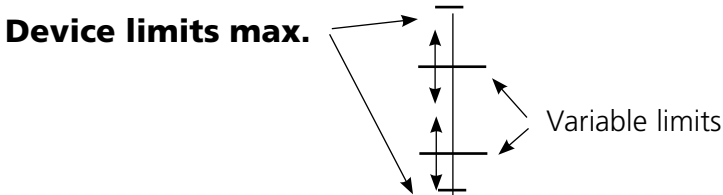

- Device limits max. Maximum measurement range of device
- Variable limits: Range limits specified

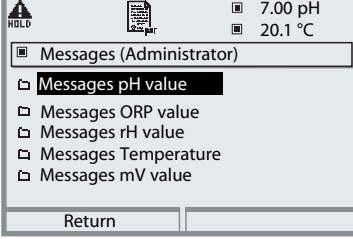
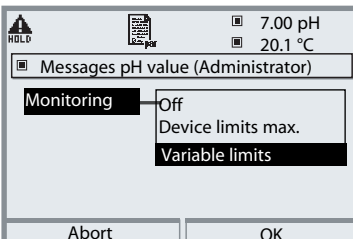
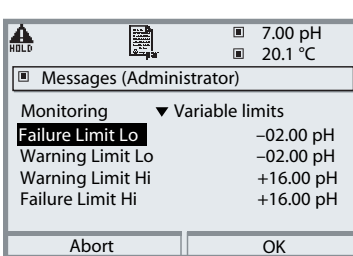

Setting the Message Parameters

Messages

Note: HOLD mode active

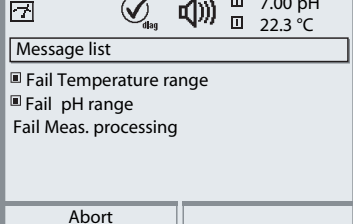
| Menu | Display | Messages |
|--|--|---|
|  |    | <h3>Messages</h3> <p>All parameters determined by the measuring module can generate messages.</p> <ul style="list-style-type: none"> Device limits max: Messages are generated when the process variable (e.g. pH) is outside the measurement range. The "Failure" icon is displayed, the NAMUR failure contact is activated (BASE module, factory setting: contact K4, N/C contact). The current outputs can signal a 22 mA message (user defined). Variable limits: For the "failure" and "warning" messages you can define upper and lower limits for message generation. Message icons:  Failure (Failure limit HiHi/LoLo)  Maintenance (Warning limit Hi/Lo) |
|  |  | <h3>Diagnostics menu</h3> <p>When the "Maintenance" or "Failure" icons are flashing in the display, you should call up the Diagnostics menu. The messages are displayed in the "Message list".</p> |

Current Outputs

Select menu: Parameter setting/Module Out

Note: HOLD mode active

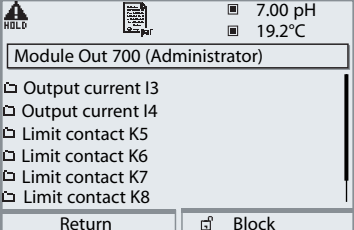
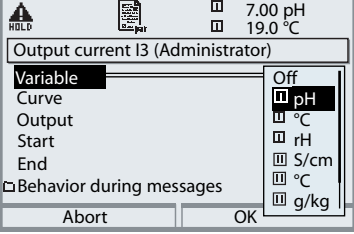
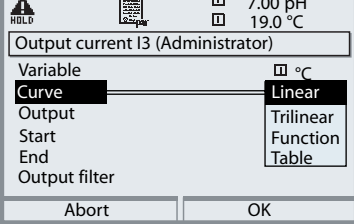
| Menu | Display | Parameter setting BASE module |
|--|--|--|
|  |  | <p>To configure current output</p> <ul style="list-style-type: none"> • Call up parameter setting • Enter passcode • Select "Module Out" • Select "Output current ..." |
| |  | <ul style="list-style-type: none"> • Select process variable |
| |  | <ul style="list-style-type: none"> • Select Curve, e.g. "linear": The measured variable is represented by a linear output current curve. The desired range of the measured variable is specified by the values for "Start" and "End". |

Assignment of Measured Values: Start (4 mA) and End (20 mA)

Example 1: Range pH 0 - 14

Example 2: Range pH 5 - 7

Advantage: Higher resolution in range of interest

Output current [mA]

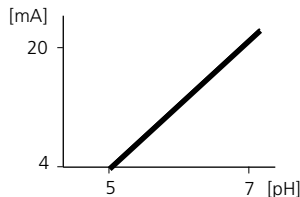
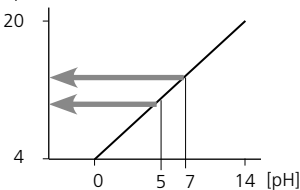

Current Outputs: Characteristics

Select menu: Parameter setting/Module BASE

• Linear characteristic

The measured variable is represented by a linear output current curve.

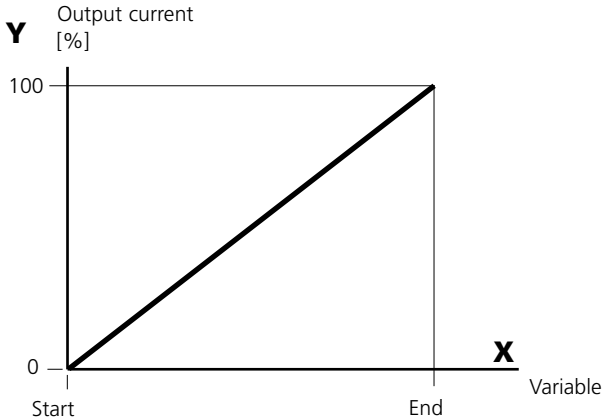

• Trilinear characteristic

Two additional corner points must be entered:

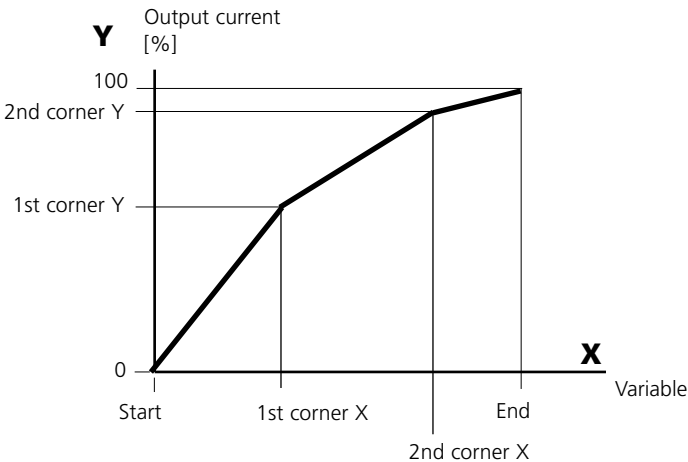

• Note: Bilinear characteristic

For a bilinear characteristic, identical parameters are entered for the two corner points (1st corner, 2nd corner).

• Function characteristic

Nonlinear output current characteristic: allows measurements over several decades, e.g. measuring very low values with a high resolution and high values with a low resolution.

Required: Entering a value for 50 % output current.

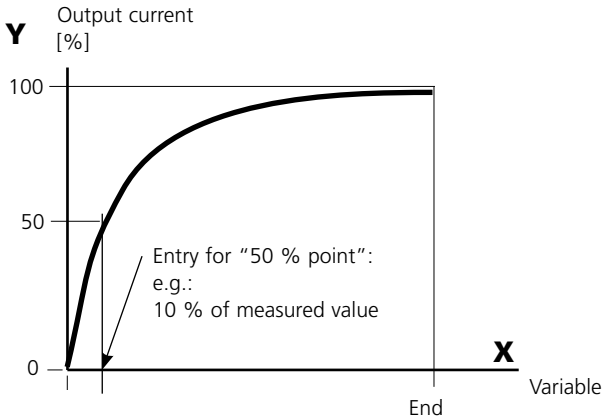

Equation

$$\text{Output current (4 ... 20 mA)} = \frac{(1+K)x}{1+Kx} 16 \text{ mA} + 4 \text{ mA}$$

$$K = \frac{E + S - 2 * X50\%}{X50\% - S} \qquad x = \frac{M - S}{E - S}$$

S: Start value at 4 mA

X50%: 50% value at 12 mA (output current range 4 to 20 mA)

E: End value at 20 mA

M: Measured value

Logarithmic output curve over one decade:

S: 10 % of maximum value

X50%: 31.6 % of maximum value

E: Maximum value

Logarithmic output curve over two decades:

S: 1 % of maximum value

X50%: 10 % of maximum value

E: Maximum value

Output Filter

Time Constant

Time Constant of Output Filter

To smoothen the current output, a low-pass filter with adjustable time constant can be switched on. When there is a jump at the input (100 %), the output level is at 63 % after the time constant has been reached.

The time constant can be set from 0 to 120 sec. If the time constant is set to 0 sec, the current output follows the input.

Notice:

The filter only acts on the current output and the current value of the secondary display, not on the measurement display, the limit values, or the controller!



Time constant 0 to 120 sec

NAMUR Signals: Current Outputs

Behavior during messages: HOLD, 22 mA signal

Behavior During Messages

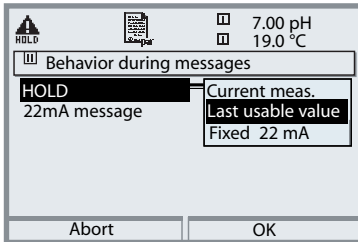

Depending on the parameter setting ("Messages") the current outputs switch to:

- Currently measured value
- Last measured value (HOLD function)
- Fixed value (22 mA)

In the case of a fault a 22 mA signal can be generated for the selected process variable (1st primary value).

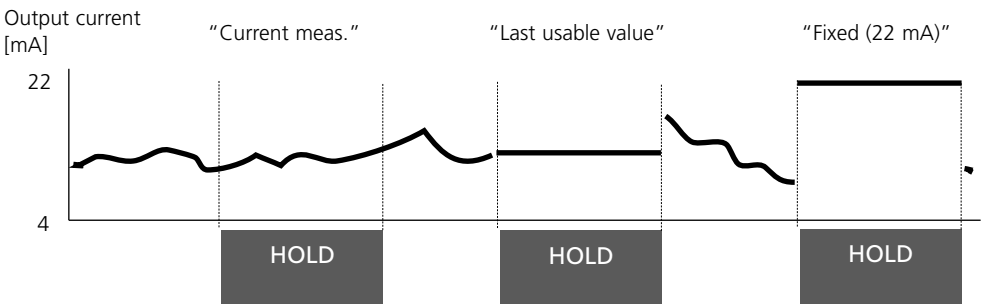

Message when the Current Range is Exceeded

As delivered, the "Maintenance request" (Warn) message is generated when the current range is exceeded (< 3.8 mA or > 20.5 mA).

This setting can be changed in the Parameter setting menu of the respective measuring module at "Messages".

To generate a "Failure" message, the limit value monitoring must be set to "Variable limits":

Parameter setting - <measuring module> - Messages - Variable limits - Failure limit ...

Enter the same values for the failure limits as for the current output:

Parameter setting - Module BASE - Output current - Variable Start / End.

Limit Value, Hysteresis, Contact Type

Parameter setting/Module Out/Relay contacts/Usage

| Menu | Display | Usage as limit value |
|------|---------|--|
| | | Relay output: Limit <ul style="list-style-type: none"> • Call up parameter setting • Enter passcode • Select "Module Out" • Select "Contact ..." • "Usage: Limit" (Fig.) |

Limit value Effective direction min

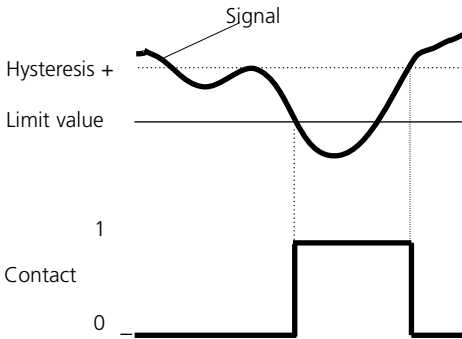

Limit value Effective direction max

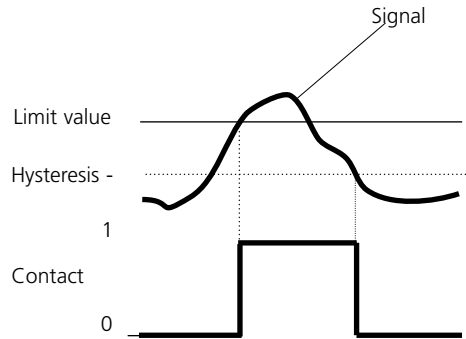

Icons in the Measurement Display:

Measured value exceeds limit: Measured value falls below limit:

Hysteresis



Tolerance band around the limit value, within which the contact is not actuated. Serves to obtain appropriate switching behavior at the output and suppress slight fluctuations of the measured variable (Fig.)

Contact Type

Specifies whether the active contact is closed (N/O) or open (N/C).

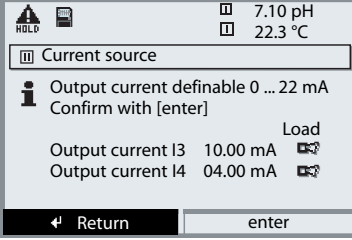

Maintenance, Diagnostics

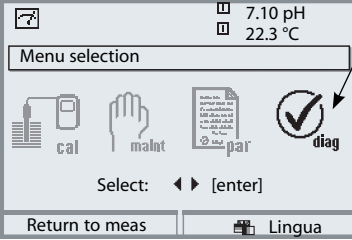
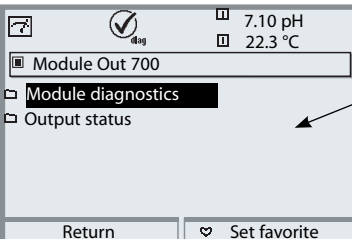
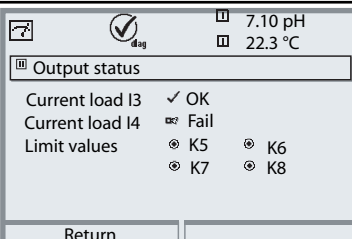
Note: During "Maintenance" the "HOLD" mode is active.

| Menu | Display | Maintenance |
|---|--|--|
|  |  | <p>Current source (maint. menu)</p> <p>For checking purposes, the output current can be manually specified. The device is in HOLD mode. Select: Maintenance menu/ Module Out 700/Current source.</p> |
| Menu | Display | Diagnostics |
|  |    | <p>Call up diagnostics</p> <p>From the measuring mode: Press menu key: select menu. Select diagnostics using arrow keys, confirm with enter. Then select "Module Out 700".</p> <p>The Diagnostics menu gives an overview of all diagnostics functions available. Functions which have been set as "Favorite" can be directly accessed from the measuring mode (see manual for basic unit).</p> <p>Diagnostics functions available:</p> <ul style="list-style-type: none"> • Module diagnostics • Function test of internal components. • Output status (Fig.) • Status of signal outputs |

Diagnostics Functions

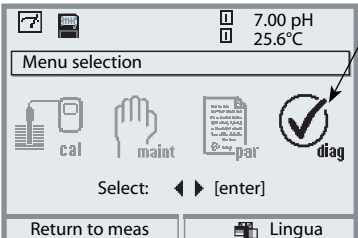
General status information of the measuring system
 Select menu: Diagnostics - Message list

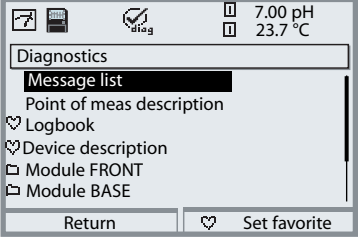
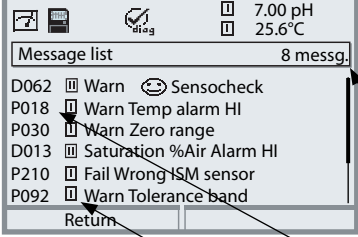
| Menu | Display | Diagnostics functions |
|--|--|---|
| |  | <p>Call up diagnostics From the measuring mode: Press menu key to select menu. Select diagnostics using arrow keys, confirm with enter.</p> |
|  |  | <p>The “Diagnostics” menu gives an overview of all functions available. Functions which have been set as “Favorite” can be directly accessed from the measuring mode.</p> |
| |  | <p>Message list Shows the currently activated warning or failure messages in plain text.</p> <p>Number of messages When there are more than 7 messages, a vertical scrollbar appears. Scroll with the up/down arrow keys.</p> <p>Message identifier See message list for description.</p> <p>Module identifier Specifies the module that has generated the message.</p> |

Messages

Out 700(X) Module

| No. | Out messages | Message type |
|------|--|--------------|
| 1008 | Meas. processing (factory settings) | FAIL |
| 1009 | Module failure (Firmware Flash check sum) | FAIL |
| 1070 | Current I3 Span | WARN |
| 1071 | Current I3 <0/4 mA | WARN |
| 1072 | Current I3 > 20 mA | WARN |
| 1073 | Current I3 Load error | FAIL |
| 1074 | Current I3 Parameter | WARN |
| 1075 | Current I4 Span | WARN |
| 1076 | Current I4 <0/4 mA | WARN |
| 1077 | Current I4 > 20 mA | WARN |
| 1078 | Current I4 Load error | FAIL |
| 1079 | Current I4 Parameter | WARN |
| 1254 | Module reset | Text |

Specifications

Specifications Out 700 Module

Current output I3, passive

Supply voltage

Load monitoring

Overrange*

Measurement error**

Start/end of scale*

Current source

0/4 ... 20 mA (22 mA), floating
(electrically connected with output I4)

3 ... 30 V, $I_{\max} = 100 \text{ mA}$, $P_{\max} = 0.8 \text{ W}$

Error message if load is exceeded

22 mA in the case of a message

< 0,25 % current value + 0.05 mA

As desired within range

0.00 ... 22.00 mA

Current output I4, passive

Galvanically connected with output I3, identical data

Limit value outputs K5 - K8

Voltage drop

Loadability

4 electronic relay outputs, polarized
floating, inter-connected

< 1.2 V

DC: $V_{\max} = 30 \text{ V}$; $I_{\max} = 100 \text{ mA}$; $P_{\max} = 0.8 \text{ W}$

* User-defined

** To IEC 746 Part 1, at nominal operating conditions

Specifications

General Data

Explosion protection

(IS module only)

ATEX: See rating plate: KEMA 03 ATEX 2056
II 2 (1) GD EEx ib [ia] IIC T4 T 70 °C

FM: NI, Class I, Div 2, GP A, B, C, D T4
with IS circuits extending into Division 1
Class I, Zone 2, AEx nA, Group IIC, T4
Class I, Zone 1, AEx me ib [ia] IIC, T4

CSA: NI, Class I, Div 2, Group A, B, C, D
with IS circuits extending into Division 1
AIS, Class I, Zone 1, Ex ib [ia] IIC, T4
NI, Class I, Zone 2, Ex nA [ia] IIC

EMC

Emitted interference
Immunity to interference

NAMUR NE 21 and
EN 61326 VDE 0843 Part 20 /01.98
EN 61326/A1 VDE 0843 Part 20/A1 /05.99
Class B
Industry

Lightning protection

EN 61000-4-5, Installation Class 2

Nominal operating conditions

Ambient temperature:
-20 ... +55 °C (Ex: max. +50 °C)
Rel. humidity: 10 ... 95 % not condensing

Transport/Storage temperature

-20 ... +70 °C

Screw clamp connector

Single wires and flexible leads up to 2.5 mm²

Overview of Parameter Setting

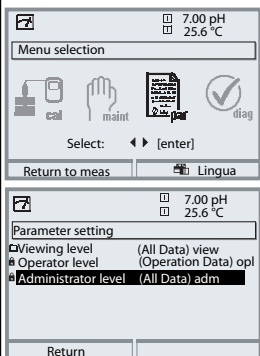

Parameter setting

Activated from measuring mode: Press **menu** key to select menu.

Select parameter setting using arrow keys, confirm with **enter**.

Administrator level

Access to all functions, also passcode setting.

Releasing or blocking a function for access from the Operator level.

Operator level

Access to all functions which have been released at the Administrator level. Blocked functions are displayed in gray and cannot be edited.

Viewing level

Only display, no editing possible!

System Control

Memory card (Option)

- Record logbook
- Register recorder
- Decimal separator
- Card full
- Format

Menu only appears with SmartMedia Card inserted.

Make sure that it is a memory card, not an update card.

Commercially available SmartMedia cards must be formatted before they can be used as memory card.

Copy configuration

The complete configuration of an analyzer can be written on a SmartMedia card. This allows transferring all device settings to other devices with identical equipment (exception: options and passcodes).

Parameter sets

- Load
- Save

2 parameter sets (A,B) are available in the analyzer.

The currently active parameter set is read on the display.

Parameter sets contain all settings except:

Sensor type, Options, System control settings

Up to 5 parameter sets (1, 2, 3, 4, 5) are available when a SmartMedia card (Option) is used.

Function control matrix

- Input OK2
- Left softkey
- Right softkey

Selecting the control element for the following functions:

- Parameter set selection
- KI recorder (Start/Stop)
- Favorites menu (selected diagnostics functions)
- EC 400 (fully automated probe controller)

Time/date

Selecting the display format, entry

Point of meas description

Can be called up in the diagnostics menu.

Release of options

A TAN is required to release an Option.

Software update

Software update from SmartMedia card (update card)

Logbook

Selecting events to be recorded

Buffer table

Entering own buffer set for automatic calibration

Factory setting

Resetting all parameters to factory setting

Passcode entry

Editing the passcodes

Parameter Setting Menu



Display Settings: FRONT Module

Languages

| | |
|---|---|
| Measurement display <ul style="list-style-type: none"> • Main display • Display format • Viewing angle | Representation of measured values on the display: <ul style="list-style-type: none"> - Selecting the number of primary values displayed (one or two) - Decimal places |
| Measurement recorder <ul style="list-style-type: none"> • Time base • Zoom function • Min/Max display | Option: 2-channel, selection of process variable, start and end |
| KI recorder | Option: See more detailed "Options" manual |

Signal Outputs and Inputs, Contacts: BASE Module

| | |
|---|---|
| Output current I1, I2 <ul style="list-style-type: none"> • Variable • Curve • Output (0/4 - 20 mA) • Output filter • Behavior during messages <ul style="list-style-type: none"> - HOLD --- Current meas. --- Last meas. value --- Fixed 22 mA - 22 mA message | <p>2 current outputs, separately adjustable</p> <p>Behavior during messages</p> <p>Output current [mA]</p> |
| Contact K4 <ul style="list-style-type: none"> • Contact type • ON delay • OFF delay | NAMUR Failure |
| Contacts K3, K2, K1 <ul style="list-style-type: none"> • Usage <ul style="list-style-type: none"> - Maintenance request - HOLD (function check) - Limit value (adjustable) - Rinse contact (adjustable) - Parameter set B active - USP output - KI recorder active - Sensoface • Conoller alarm (alarm output EC 400) • Contact type / ON/OFF delay | <p>Factory setting:</p> <p>K3: Maintenance request, K2: HOLD, K1: Limit</p> <ul style="list-style-type: none"> - Variable, limit value, hysteresis, effective direction, ... - Rinsing interval, lead times, rinse duration, logbook entry, ... |
| Inputs OK1, OK2 <ul style="list-style-type: none"> • OK1 usage <ul style="list-style-type: none"> - Signal level | <p>Optocoupler - signal inputs</p> <p>Off, HOLD (function check)</p> <p>active level switchable from 10 to 30 V or < 2 V, resp.</p> <p>For OK2 see System control/Function control matrix</p> |

Parameter Setting Menu



Out 700(X) Module

Output current I3

- Variable Depending on modules installed: **Off**, S/cm, °C, % by wt, g/kg, Ωcm, pH, ORP, rH, etc.
- Curve **Linear**, trilinear, function, table
- Output **0 ... 20 mA**, 4 ... 20 mA
- Output filter **000 s**, xxxx s

Behavior during messages

- HOLD Currently meas. value, **last meas. value**, fix 22mA
- 22 mA message **Off**, On

Output current I4

- Variable Depending on modules installed: **Off**, S/cm, °C, % by wt, g/kg, Ωcm, pH, ORP, rH, etc.
- Curve **Linear**, trilinear, function, table
- Output **0 ... 20 mA**, 4 ... 20 mA
- Output filter **0000 s** (entry xxxx s)

Behavior during messages

- HOLD Currently meas. value, **last meas. value**, fix 22mA
- 22 mA message **Off**, On

Limit contacts

K5 ... K8 (all separately definable)

- Process variable Depending on modules installed: **Off**, S/cm, °C, % by wt, g/kg, Ωcm, pH, ORP, rH, etc.
- Limit value **Entry**
- Hysteresis **Entry**
- Effective direction **Min**, Max
- Contact type **Normally open N/O**, normally closed N/C
- ON delay **0000 s** (entry xxxx s)
- OFF delay **0000 s** (entry xxxx s)

Maintenance Menu



BASE Module

Current source Output current definable 0 ... 22 mA

Out 700(X) Module

Current source Output current definable 0 ... 22 mA

Diagnostics Menu



Message list List of all warning and failure messages
Point of meas description
Logbook
Device description Hardware version, Serial no., (Module) Firmware, Options

FRONT Module

Module Diagnostics
Display test
Keypad test

BASE Module

Module diagnostics
Input/output status

Out 700(X) Module

Module diagnostics
Input/output status

Index

A

- Administrator level 25
- Application in hazardous locations 10
- Attaching the terminal plates 18

B

- BASE module 17
- Behavior during messages 39

C

- Cable glands 14
- Call up parameter setting 27
- Change passcode 22
- Configure measurement display 23
- Configuring the module 30
- Contact type 40
- Current output curves 36
- Current outputs 35, 39

D

- Device limits max. 34
- Diagnostics 41
- Diagnostics messages 42
- Disposal 2
- Documenting the settings 28

E

- EC Declaration of Conformity 3
- EMC 45

F

- FDA 21 CFR Part 11 9
- FRONT module 16

Index

G

Graphic display 14

H

Hardware and software version 11

Hysteresis 40

I

Inserting the module 19

Intended use 9

L

LED 14

Limit value 40

Limit value, icons in the measurement display 40

Linear characteristic 36

Lock functions 26

Lock icon 26

Logarithmic output curve 37

M

Maintenance 41

Menu selection 21

Menu structure 15, 21

Message icons 34

Message list 42

Messages 34

Messages, behavior of current outputs 39

Message when the current range is exceeded 39

Modular concept 13

Module equipment 17

Modules 16

Index

O

- Operating levels 25
- Operator level 25
- Output filter 38
- Overview of parameter setting 46

P

- Parameter setting 28
- Parameter setting, overview 46
- Parameter setting documentation 28
- Passcode entry 22
- Passcode lost 22

Q

- Query actual device/module software 11

R

- Release (softkey function) 26
- Replacing the front module 16
- Return of products 2

S

- Safety information 10
- Screw clamp connector 45
- Sealing 16
- Secondary displays 14, 23
- Sensor data parameters 31
- Serial number 11
- Shield 19
- Short description 14
- Slot for SmartMedia card 16
- SmartMedia card 16
- Softkeys 14, 23
- Software version 11

Index

Specifications 44

Start (4 mA) and end (20 mA) 35

T

Table of contents 7

Terminal compartment 17

Terminal plates 16, 18

Trademarks 2

V

Variable limits 34

Viewing level 25

W

Warranty 2

Wiring examples 20

