

pH Transmitter 2800 X

Your Consultant:

02/97
52 120 694

Mettler-Toledo GmbH, Process, Postfach, 8902 Urdorf, Switzerland
Phone +41 (01) 736 22 11, Fax +41 (01) 736 26 36



Warranty

Defects occurring within 3 years from delivery date shall be remedied free of charge at our works (carriage and insurance paid by sender).
Accessories and display backlighting: 1 year

Safety Information

Be sure to read and observe the following requirements!

Before connecting the apparatus to mains, make sure that the mains voltage corresponds to the voltage rating given on the nameplate.

Opening the apparatus exposes live parts. Therefore, the apparatus shall not be opened. If repair should be required, return the apparatus to our factory.

If opening the apparatus is inevitable, it shall first be disconnected from all voltage sources.

Make sure that the mains plug has been pulled out.

Repair or adjustment of an opened apparatus under voltage shall be carried out only by a skilled person who is aware of the hazard involved.

Remember that the voltage across accessible parts of the open apparatus may be dangerous to life.

Whenever it is likely that the protection has been impaired, the apparatus shall be made inoperative and secured against any unintended operation.

The protection is likely to be impaired if, for example:

- the apparatus shows visible damage
- the apparatus fails to perform the intended measurements
- after prolonged storage at temperatures above 70 °C
- after severe transport stresses

Before recommissioning the apparatus, a professional routine test according to EN 61010–1 shall be performed. This test should be carried out at our factory.

Installation and Commissioning



Installation of the pH Transmitter 2800X must be carried out only by specially trained personnel in accordance with the relevant regulations and this instruction manual. Be sure to observe the technical specifications and input ratings.

For information on installation, refer to chapter 1.



Commissioning of the pH Transmitter must be carried out only by specially trained personnel in accordance with the relevant regulations and this instruction manual.

Before first start-up, a *complete parameter setting* procedure must be performed by a system administrator.



At ambient temperatures below 0 °C LC display readability might be restricted. This does *not* affect instrument function.



Real-time clock, logbook, cal record and sensor statistics are battery backed for approx. 1 year. After longer power outages these data can be lost. In that case the pH Transmitter displays "Warn Time/Date" and the date is reset to 01-01-1990. Time and date must be updated.

Information on Electromagnetic Compatibility

Compliance with Interference Immunity Requirements

The pH Transmitter 2800X provides an immunity to radiated interferences of 10 V/m (according to NAMUR requirements). This field strength is generated for example by portable transceivers with approx. 10 W output (radiotelephone) at a distance of 1 m.

All inputs and outputs of the pH Transmitter 2800X are electrically isolated to each other.



The pH Transmitter 2800X meets the following generic standards:

- Electromagnetic Emission
EN 50081–1 01.92 Domestic, Commercial and Light Industry
prEN 50081–2 08.92 Industry
- Immunity to Interference
EN 50082–1 01.92 Domestic, Commercial and Light Industry
prEN 50082–2 07.93 Industry

and can therefore be used on residential, commercial and light industrial premises and in industry.

Package Contents and Unpacking

Unpack the instrument carefully.
Check the delivery for transport damages and for completeness.

The package should contain:

- the pH Transmitter 2800X
- this instruction manual
- any accessories ordered
(for available accessories, see chapter 10)

Applications

The pH Transmitter 2800X and the pH Transmitter 2800X-pH continuously measure pH and temperature in liquids. The pH Transmitter 2800X-COND also permits conductivity measurements.

The pH Transmitter is designed for industrial applications.

The weatherproof case is IP 65 protected and allows direct wall mounting on site.

All instruments of the pH Transmitter 2800X Series are approved for applications in hazardous areas.

Description of this Manual

This manual describes

- what you can do with the pH Transmitter 2800X
- how to operate the pH Transmitter 2800X
- what you have to know for installation and mounting



Warning

Warning means that ignoring the given instructions may lead to malfunction or damage of the instrument or other equipment and to personal injury.



Note

Notes call your attention to important information.

Remarks on Representation

The keys of the pH Transmitter 2800X are represented as follows:

meas , cal , maint , par , diag

◀ , ▶ , ▲ , ▼ , enter

A term printed in **bold-faced text** is explained in chapter 15: "Technical Terms".

Italics are used to emphasize certain information.

The representation of a menu in this manual can slightly differ from the display of your pH Transmitter 2800X. This depends on the options your instrument is equipped with.



If the behavior of your instrument differs from the description in this manual, check if the manual corresponds to the software version of your instrument: see page 6–4.

Blank page.

Contents

Safety Information	III
Installation and Commissioning	IV
Information on Electromagnetic Compatibility	V
Compliance with Interference Immunity Requirements	V
Package Contents and Unpacking	VI
Applications	VI
Description of this Manual	VII
Remarks on Representation	VII
1 Information on Mounting, Installation and Maintenance	1-1
Mounting	1-1
How to mount the pH Transmitter 2800 in the ZU 0124 protective case	1-5
Installation	1-7
Maintenance and Cleaning	1-8
2 Capabilities of the pH Transmitter 2800X	2-1
Overview on the pH Transmitter 2800X	2-1
The pH Measurement	2-3
SensoCheck® Electrode Monitoring	2-5
ORP Measurement	2-6
Simultaneous pH and ORP Measurement	2-7
rH Measurement	2-8
Temperature Detection	2-8
The Passive Outputs/Inputs	2-9
The Interface	2-10
Unical® 79 (X) for Fully Automatic Calibration	2-10
Typical Wirings	2-11
Terminal Assignments	2-12

3	Operating the pH Transmitter 2800X	3-1
	The User Interface	3-1
	The Measuring Mode	3-2
	The Measurement Recorder	3-4
	The Menu Structure	3-5
	Menu Operation	3-6
4	Parameter Setting	4-1
	Language Selection	4-1
	The Three Levels of Parameter Setting	4-1
	The Factory Setting	4-3
	The Measurement Display	4-3
	The Input Filter	4-4
	Temperature Detection	4-4
	Temperature Compensation of the Measured Medium	4-5
	The Calimatic® Buffer Set	4-6
	The Tolerance Band Calibration	4-7
	ORP Check	4-8
	Nominal Electrode Zero and Nominal Electrode Slope	4-8
	rH Measurement	4-9
	The Delta Function	4-11
	Current Output 1	4-12
	Outputs/Inputs 2 and 3	4-12
	The Alarm Settings	4-19
	The NAMUR Contacts	4-22
	The V24 / 20 mA Interface/Unical®	4-24
	Setting the Clock	4-30
	Point of Measurement/Note	4-30
	Device Diagnostics	4-30
	Measurement Recorder	4-31
	Passcode Entry	4-32
	Release of Options	4-34

5	Calibration	5-1
	Why do you have to calibrate?	5-1
	Monitoring Functions for Calibration	5-1
	The Calibration Menu	5-2
	What does "First Calibration" mean?	5-3
	Temperature Compensation during Calibration	5-4
	Single- or Dual-Point Calibration?	5-5
	Automatic Calibration with Calimatic®	5-6
	Calibration with Manual Entry of Buffer Values	5-8
	Calibration by Entry of Premeasured Electrode Data	5-10
	Calibration by Sampling	5-10
	ORP Check	5-11
	pH Calibration with Unical®	5-13
6	The Diagnostics Menu	6-1
	The Message List	6-1
	The Electrode Records	6-1
	The Logbook	6-4
	The Device Description	6-4
	The Device Diagnostics	6-5
	Measurement Recorder (Listing)	6-6
7	The Maintenance Menu	7-1
	Measurement Point Maintenance	7-1
	The Current Source Function	7-2
	Temperature Probe Adjustment	7-2
	Manual Entry of Controller Output	7-3
8	Error Messages	8-1

9	Interface Commands	9-1
	Contents	9-1
	Transmission behavior	9-3
	VALUE Commands: Query measured values	9-4
	STATUS Commands: Query messages and states	9-5
	PARAMETER Commands: Query settings and set parameters	9-9
	DEVICE Commands: Device Description	9-23
	COMMAND Commands: Control Commands	9-23
10	Product Line and Accessories	10-1
11	Specifications	11-1
	EMC Test Records	11-5
	Certificate of Conformity	11-6
12	Buffer Charts	12-1
13	Unical[®] Programs	13-1
	Unical [®] Program (dual-point calibration)	13-1
	Unical [®] Program (single-point calibration)	13-2
	Unical [®] Program (ORP check)	13-3
	Unical [®] Program (original for copy)	13-4
14	Appendix	14-1
	PROM Replacement	14-2
15	Technical Terms	15-1
16	Index	16-1

1 Information on Mounting, Installation and Maintenance

Mounting



- The weatherproof enclosure allows direct wall mounting. For dimension drawing, see Fig. 1-1.
- With ZU 0126 mounting plate and ZU 0125 bracket kit, the instrument can also be post or pipe mounted. For dimension drawing, see Fig. 1-2.



- ZU 0123 protective hood provides additional protection against direct weather exposure and mechanical damage. For dimension drawing, see Fig. 1-2.
For mounting the protective hood, you require ZU 0126 mounting plate.



- ZU 0124 protective case provides optimum protection against dust, moisture and mechanical damage. For dimension drawing, see Fig. 1-3.
With ZU 0128 bracket kit, the protective case can also be post or pipe mounted.

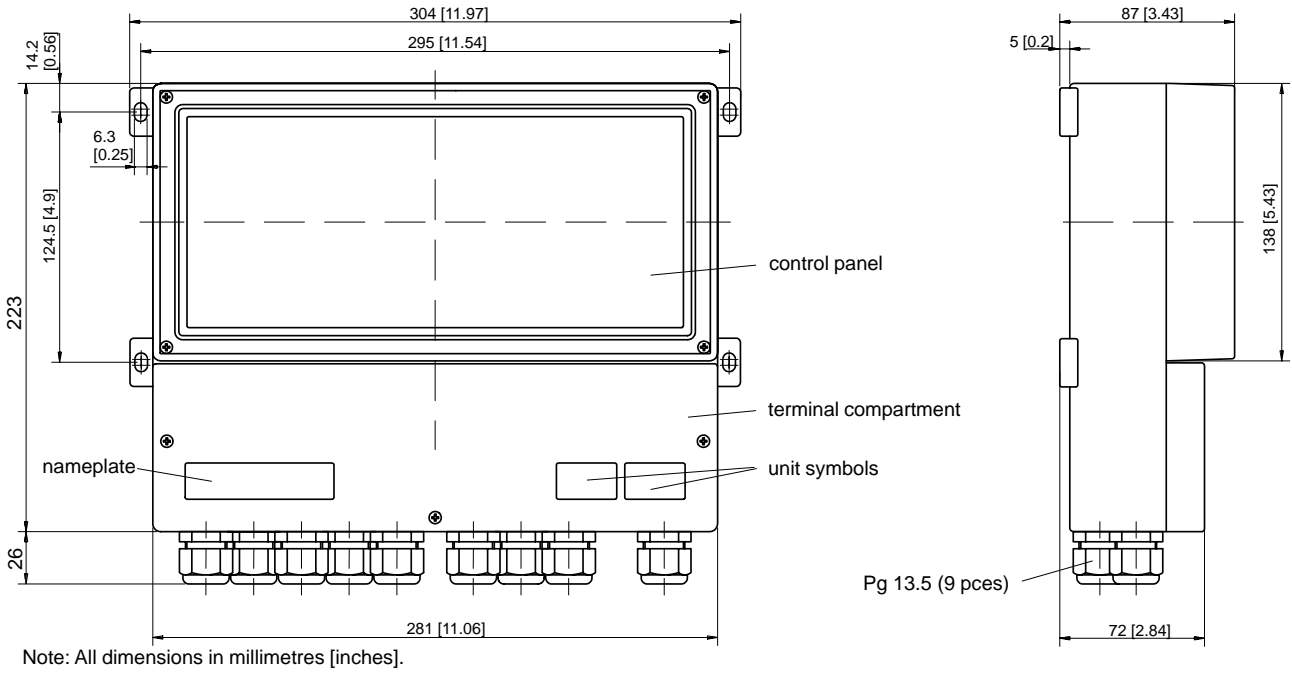

Fig. 1-1 Dimension Drawing pH Transmitter 2800X

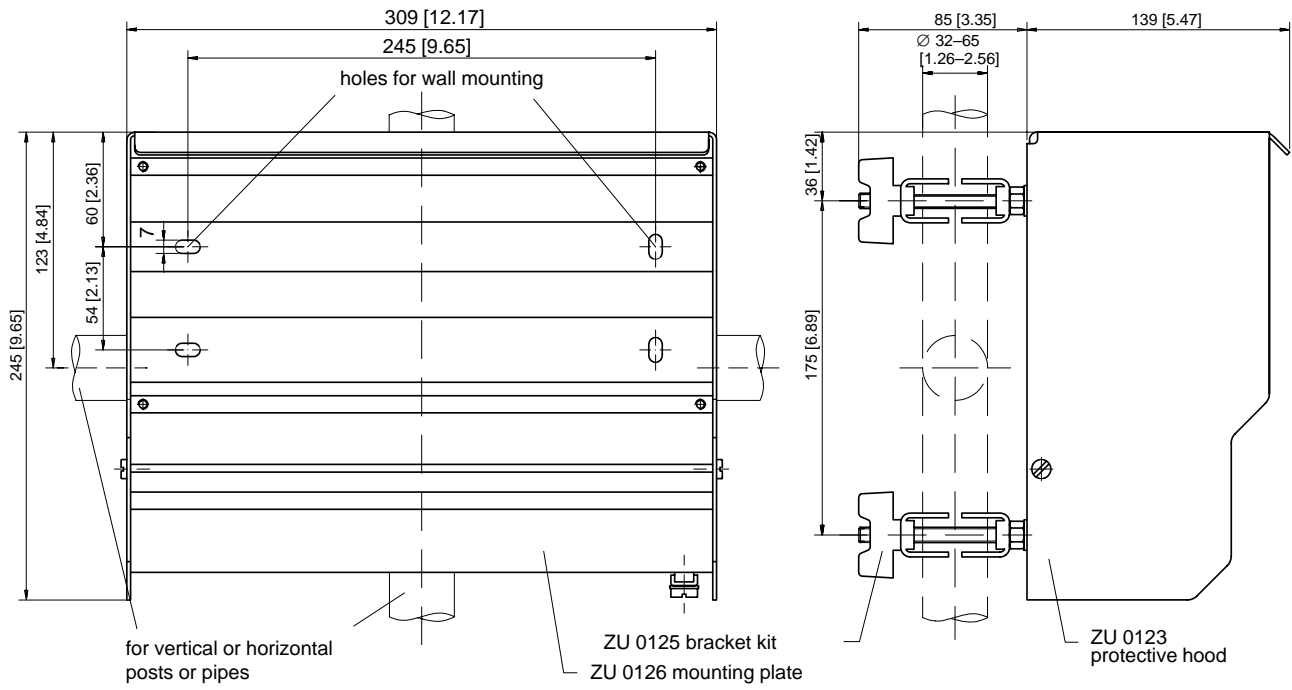

Fig. 1-2 Dimension Drawing ZU 0126 Mounting Plate and ZU 0123 Protective Hood

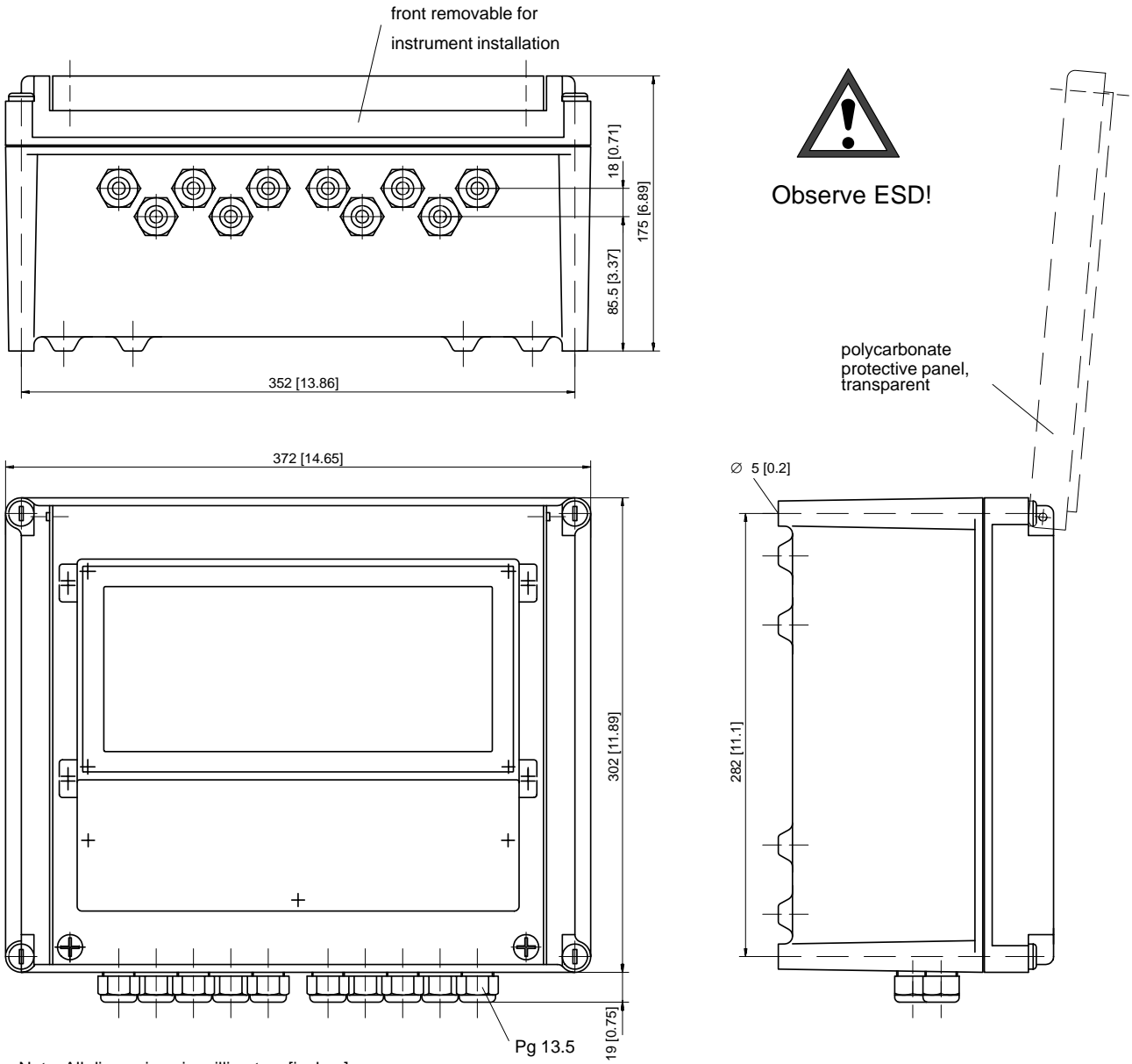

Fig. 1-3 Dimension Drawing ZU 0124 Protective Case

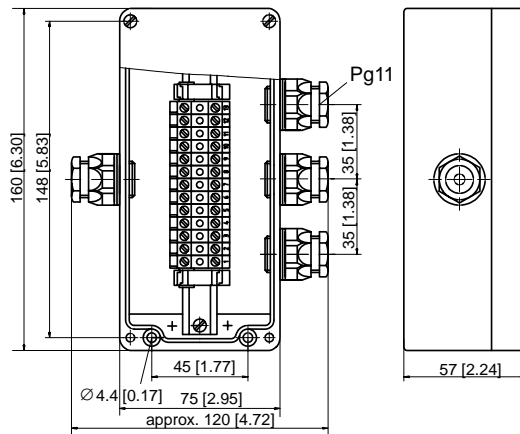
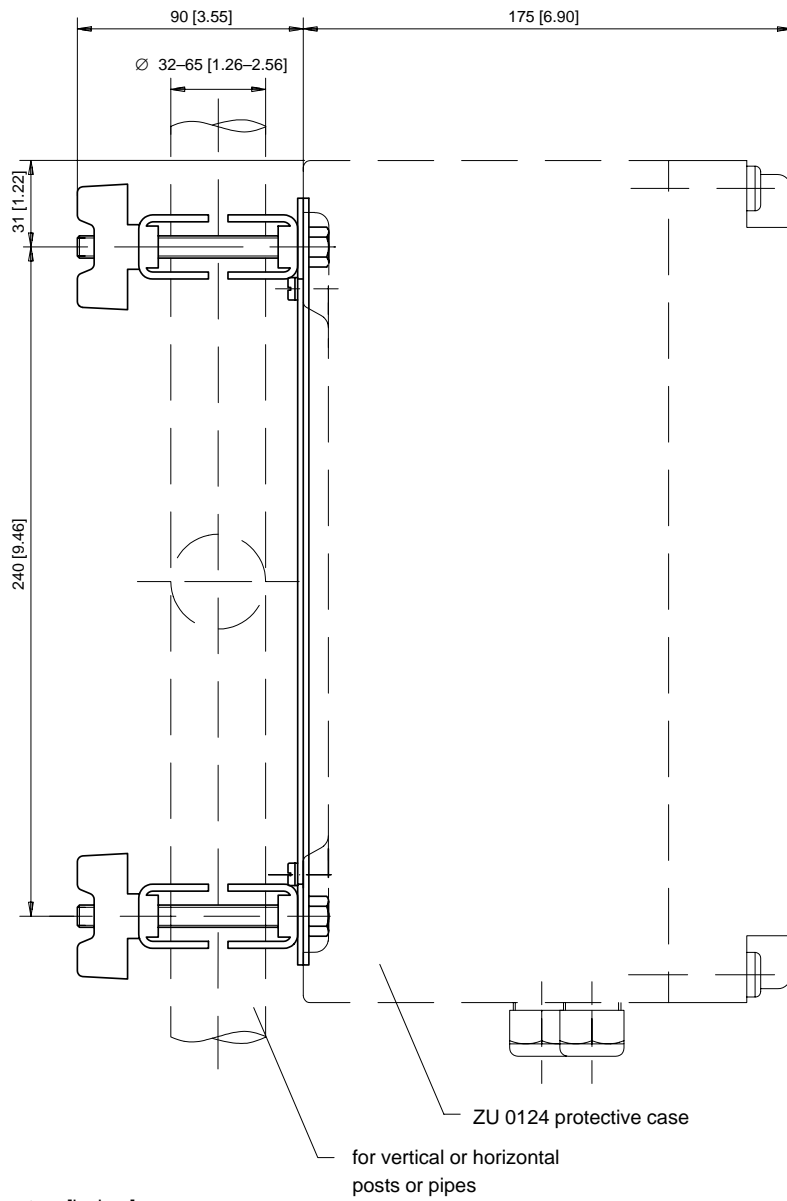

Fig. 1-4 ZU 0074X Terminal Box



Note: All dimensions in millimetres [inches].

Fig. 1-5 ZU 0128 Bracket Kit for ZU 0124 Protective Case

How to mount the pH Transmitter 2800 in the ZU 0124 protective case

Construction

The pH Transmitter 2800X is screwed to the cabinet of the protective case via two support rails. The connection leads are passed through extension pieces to the bottom part of the protective case where they are sealed by Pg threaded cable glands.

Mounting Instructions

- Unscrew all Pg threaded cable glands and their gaskets from the pH Transmitter 2800X and save them for later mounting.
- Screw the included extensions (3) with their corresponding gaskets (2) at the positions of the Pg cable glands.
- Screw the two support rails (4), using two M4x8 screws and two 4.3 toothed lock washers each, *in the same direction* into the cabinet of the protective case.
Do not tighten the screws before having aligned the complete unit!
- Screw the pH Transmitter 2800X (using four M5x16 screws and four 5.3 washers) onto the two support rails. *Do not tighten the screws before having aligned the complete unit!*
- Push the four threaded inserts (5) evenly into the free blind holes at the lid of the protective case and spread them a bit apart.
- Screw the front cover (6) to the lid of the protective case using four screws and toothed lock washers. *Caution! The lid window must be hinged at its bottom part!*
- Place the lid onto the opening of the cabinet to align the pH Transmitter 2800X in the protective case.
- Screw the Pg cable glands with gaskets into the extension pieces.
- Remove the lid and hand-tighten all fastening screws.
- Make the electrical connections to the pH Transmitter 2800X (see page 1–7).
- Fasten the lid to the cabinet using the four assembly screws.

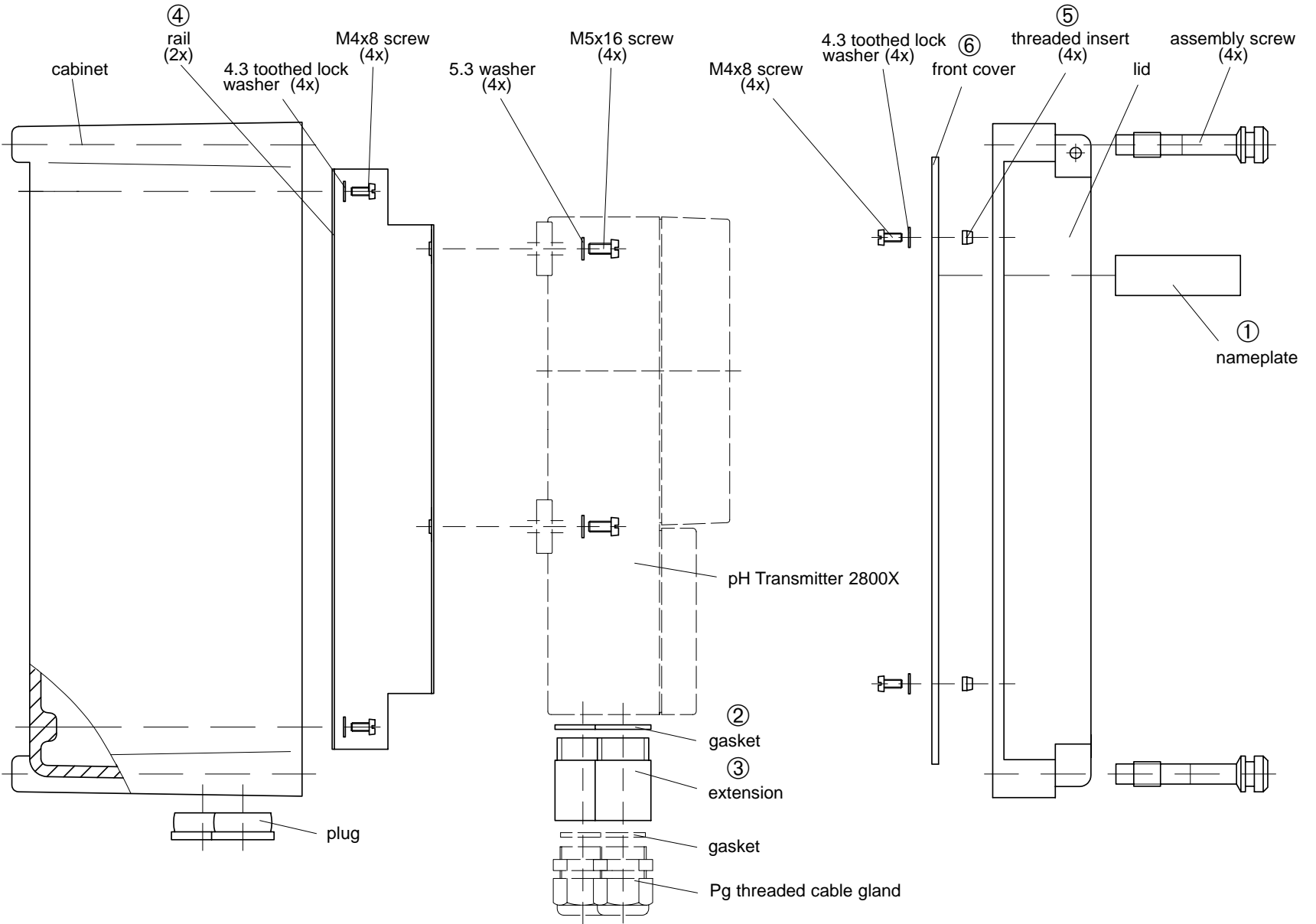

Fig. 1-6 Mounting the pH Transmitter 2800X in the Protective Case

Installation



Installation of the pH Transmitter 2800X must be carried out only by specially trained personnel in accordance with the relevant regulations and this instruction manual. Make sure that the technical specifications and input ratings are observed.



Commissioning of the pH Transmitter 2800X must be carried out only by specially trained personnel in accordance with the relevant regulations and this instruction manual.

Before first start-up, a *complete parameter setting* procedure must be performed by a system administrator.



Observe the requirements of the Certificate of Conformity and the relevant national installation regulation.

Before connecting power supply, make sure that your mains supply corresponds to the ratings on the instrument's nameplate:

- 230 Vac
- 115 Vac (option 363)
- 24 Vac/dc (option 298)



After connection of power supply current outputs and contacts are frozen at the state before power failure for approx. 10 s. This ensures that after power-on no invalid messages are generated.

To connect the pH Transmitter 2800X, open the cover of the terminal compartment (lower part of the instrument) by removing the three screws. The terminals are suitable for solid wires and stranded wires up to 2.5 mm².

At the left side of terminal 1 there is a connecting strap with two clamping screws for connecting the electrode cable shield (Fig. 2-13, Pg. 2-12).

This strap is electrically connected to terminal 3! (See also wiring examples on pages 2-5 ff.)



As delivered, all terminals are open in order to allow easy insertion of the connecting wires. If the terminals are only half open, it may occur that the wire is pushed below the contacting element and thus does not contact when the terminal is closed.



Should your pH Transmitter be supplied with a German assignment label, simply pull it out and turn it over to read the English text.

Maintenance and Cleaning

The pH Transmitter 2800X is maintenance free.

To remove dust, dirt and stains, the outer surfaces of the instrument may be wiped using a soft, non-fluffing cloth moistened with water. If required, you may also use a mild detergent.



When operating the pH Transmitter within a hazardous area, prevent electrostatical charging! Never wipe the unit with a dry cloth, for example.

2 Capabilities of the pH Transmitter 2800X

Overview on the pH Transmitter 2800X



Commissioning of the pH Transmitter 2800X must be carried out only by specially trained personnel in accordance with the relevant regulations and this instruction manual.

Before first start-up, a *complete parameter setting* procedure must be performed by a system administrator.

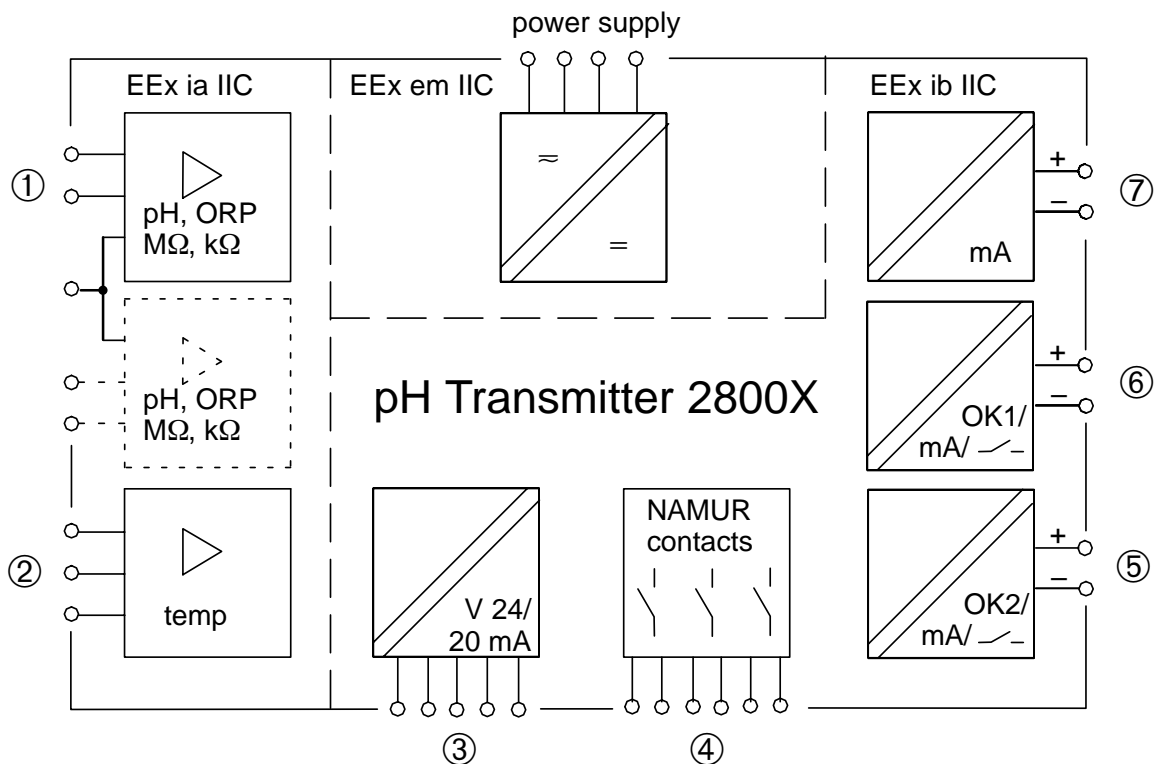

Fig. 2-1 System Functions pH Transmitter 2800X

Fig. 2-1 shows the versatile system functions. In addition to inputs for measuring and reference electrode ① and temperature probe ② you can connect an equipotential bonding electrode that at the same time serves as auxiliary electrode for electrode monitoring.

With a suitable electrode – e.g. platinum – you can simultaneously measure ORP. This allows not only to detect pH and ORP, but also to calculate and indicate the pH-compensated ORP, the so-called rH value.

The instrument provides a galvanically separated standard current output (0(4) to 20 mA) ⑦ and two passive outputs ⑥ and ⑤ that can be assigned to the measured variables pH, mV, ORP, rH or temperature. The passive outputs can be defined either as current outputs (current sink, power supply unit required), as switching or controller outputs or as SPC control inputs (OK1, OK2).

Via a serial V24/20 mA interface ③ you can completely remote control the pH Transmitter 2800X and read out all measured data and status messages, even over large distances. Optionally you can also use the interface for controlling a fully automatic Unical® pH measuring installation.

The NAMUR contacts ④ can control signalling units for functional check, warning (maintenance required) and failure directly on site.



Commissioning of the pH Transmitter 2800X must be carried out only by specially trained personnel in accordance with the relevant regulations and this instruction manual.

Before first start-up, a *complete parameter setting* procedure must be performed by a system administrator.

The pH Measurement

Fig. 2-2 shows how to connect a combination pH electrode to the pH Transmitter 2800X. *Terminals 2, 3, 4 and 5 must be jumpered!*

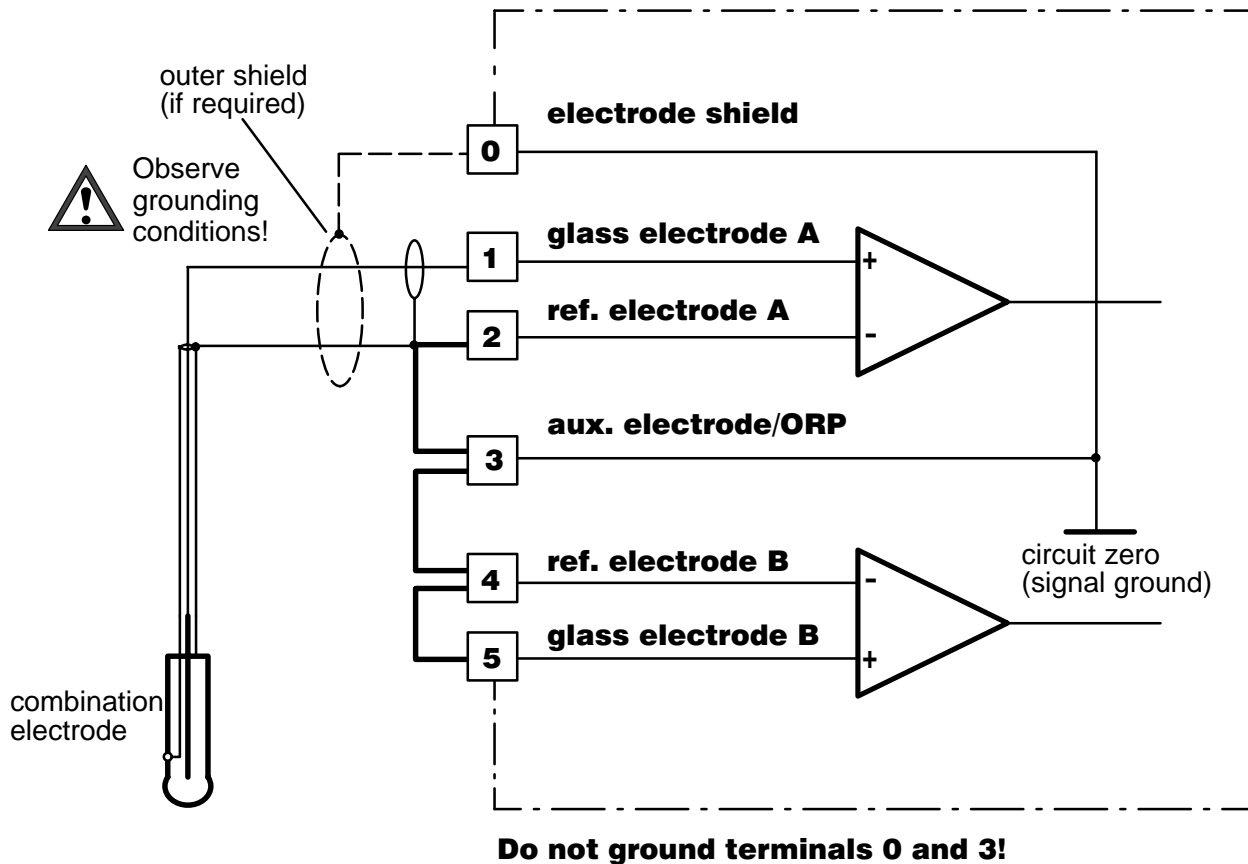
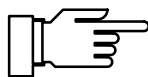

Fig. 2-2 Wiring of pH input for simple pH measurement with impedance measurement of glass electrode



For information on how to use SensoCheck[®] electrode monitoring also for monitoring the reference electrode, refer to Pg. 2-5.

In the case of interferences (e.g. from mains), it can be useful to remove the jumper across 2 and 3 and to connect terminal 0 or 3 with a conducting vessel wall. Now the interferences will be diverted via the vessel wall and not via the reference electrode (see Fig. 2-3).

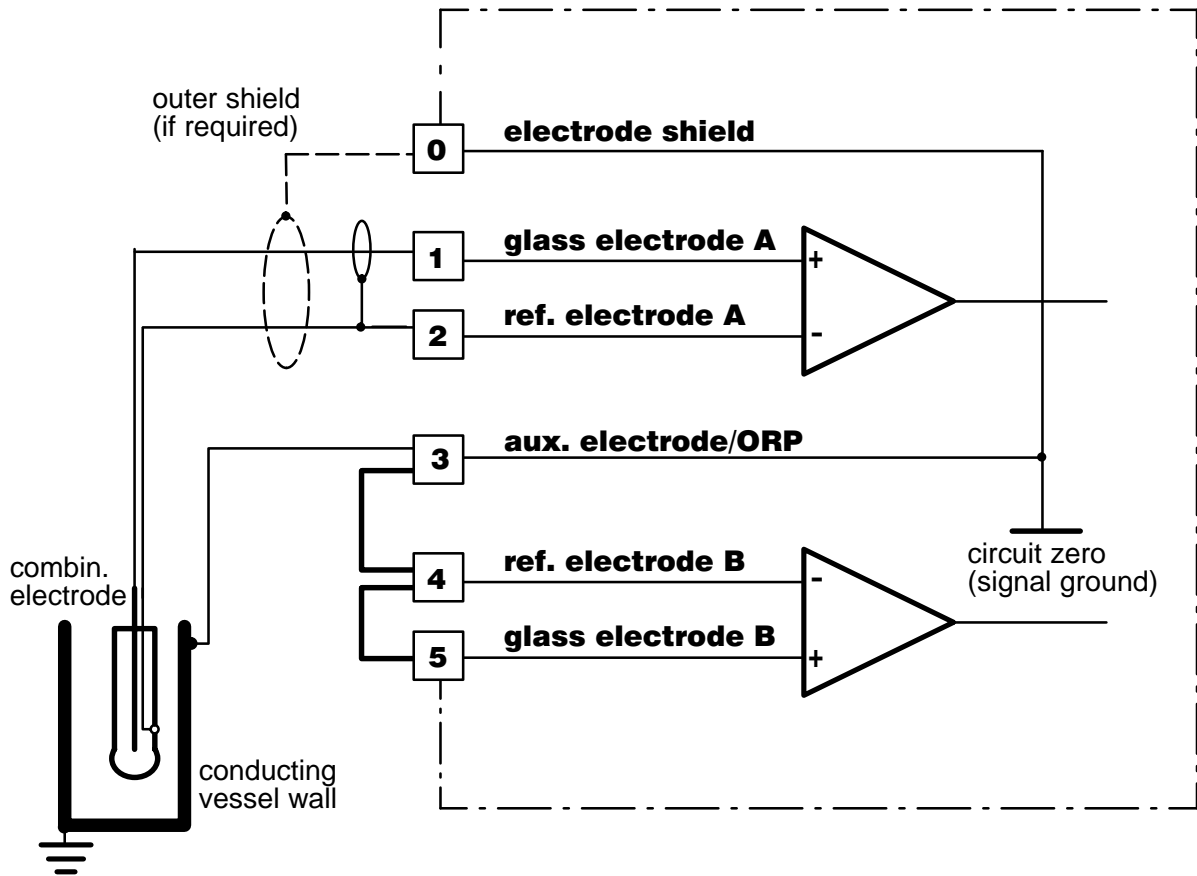

Fig. 2-3 Wiring of pH input with impedance measurement of glass and reference electrode in the case of interferences (e.g. from mains)

SensoCheck® Electrode Monitoring

SensoCheck® electrode monitoring measures the impedances of glass and reference electrodes. This measurement is taken continuously together with pH measurement.

The electrode impedances are a good indicator for electrode status, contamination (of reference electrode), glass breakage (of glass electrode), ageing and open circuit conditions.

If you only want to monitor the glass electrode impedance, you can connect the electrode system as shown in Fig. 2-2, Pg. 2-3.

To measure the reference electrode impedance, you require an auxiliary electrode or a conducting vessel wall. Refer to Fig. 2-4 for wiring. This allows you to monitor the reference electrode.

Instead of using an auxiliary electrode, you can also connect terminal 3 to the test medium vessel if it is metallically conducting (see Pg. 2-4). The vessel may be grounded (see Pg. 2-3).

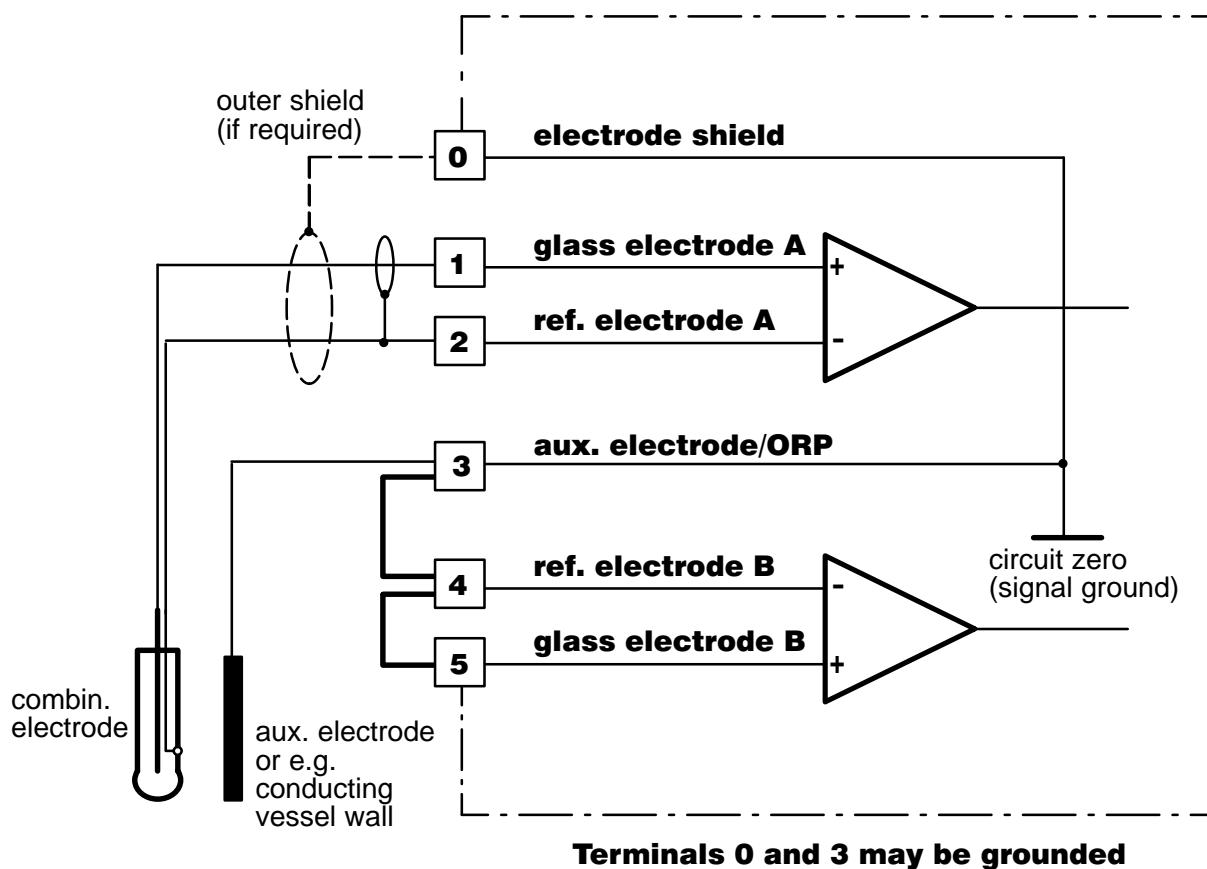

Fig. 2-4 Wiring of pH input with impedance measurement of glass and reference electrode

ORP Measurement

When measuring oxidation–reduction potential (ORP), an indication must be made as to which electrode was used as reference and whether the result has been converted to the standard hydrogen electrode.

Specification of ORP is completed by indicating the sensing electrode in use (e.g. "platinum"), measuring temperature and pH value.

Differential voltages of reference electrodes compared to standard hydrogen electrode (± 5 mV, at 25 °C):

Reference Electrode		Differential Voltage
Ag/AgCl	KCl 1 molar	+236 mV
Ag/AgCl	KCl 3 molar	+207 mV
Ag/AgCl	KCl 3.5 molar	+200 mV
Ag/AgCl	KCl saturated	+197 mV
Argenthal	KCl 3 molar	+207 mV
Hg/Hg ₂ Cl ₂	KCl 3.5 molar	+252 mV (Calomel)
Hg/Hg ₂ Cl ₂	KCl saturated	+244 mV (Calomel)
Thalamid	KCl 3.5 molar	-571 mV

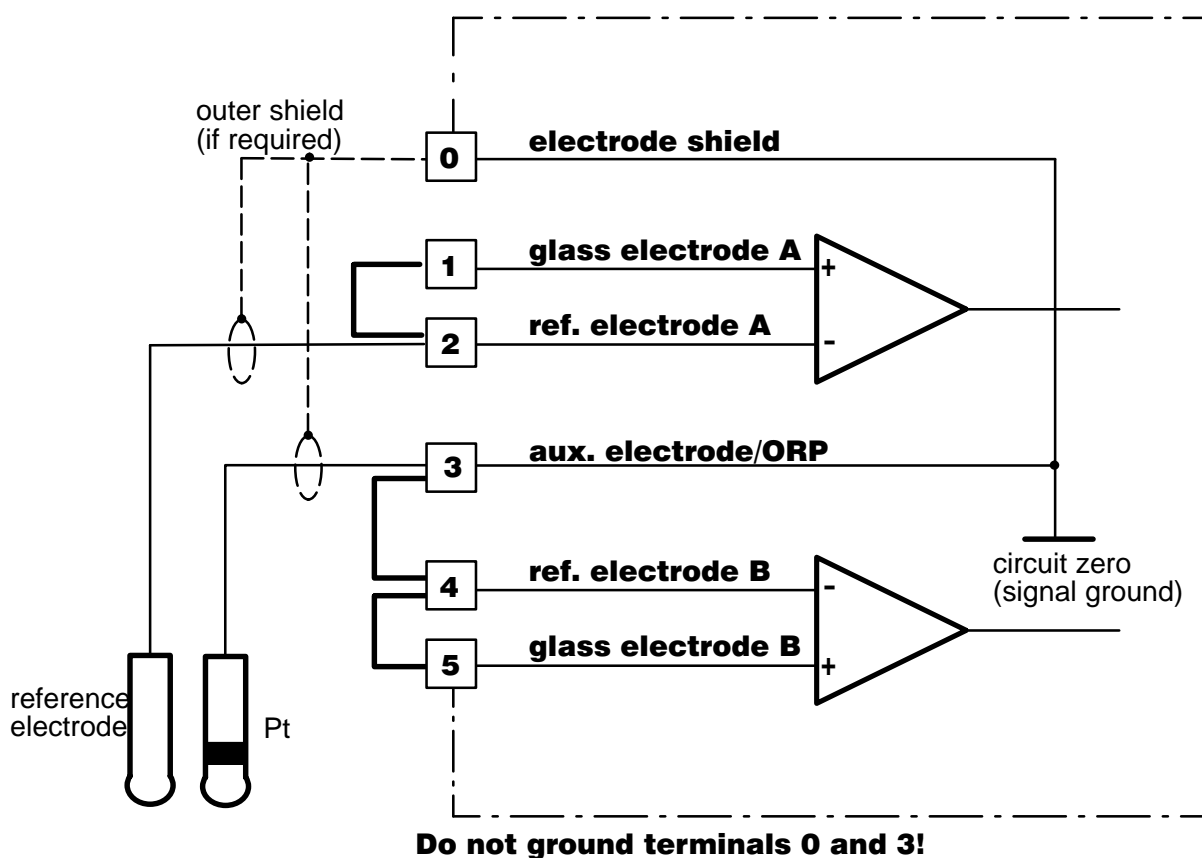

Fig. 2–5 Wiring of pH Transmitter 2800X for ORP measurement

Simultaneous pH and ORP Measurement

If you use a platinum electrode as auxiliary electrode, you can *simultaneously* measure pH and ORP.

If your pH Transmitter 2800X is equipped with additional current outputs (option 427), you can simultaneously output pH and ORP and temperature.

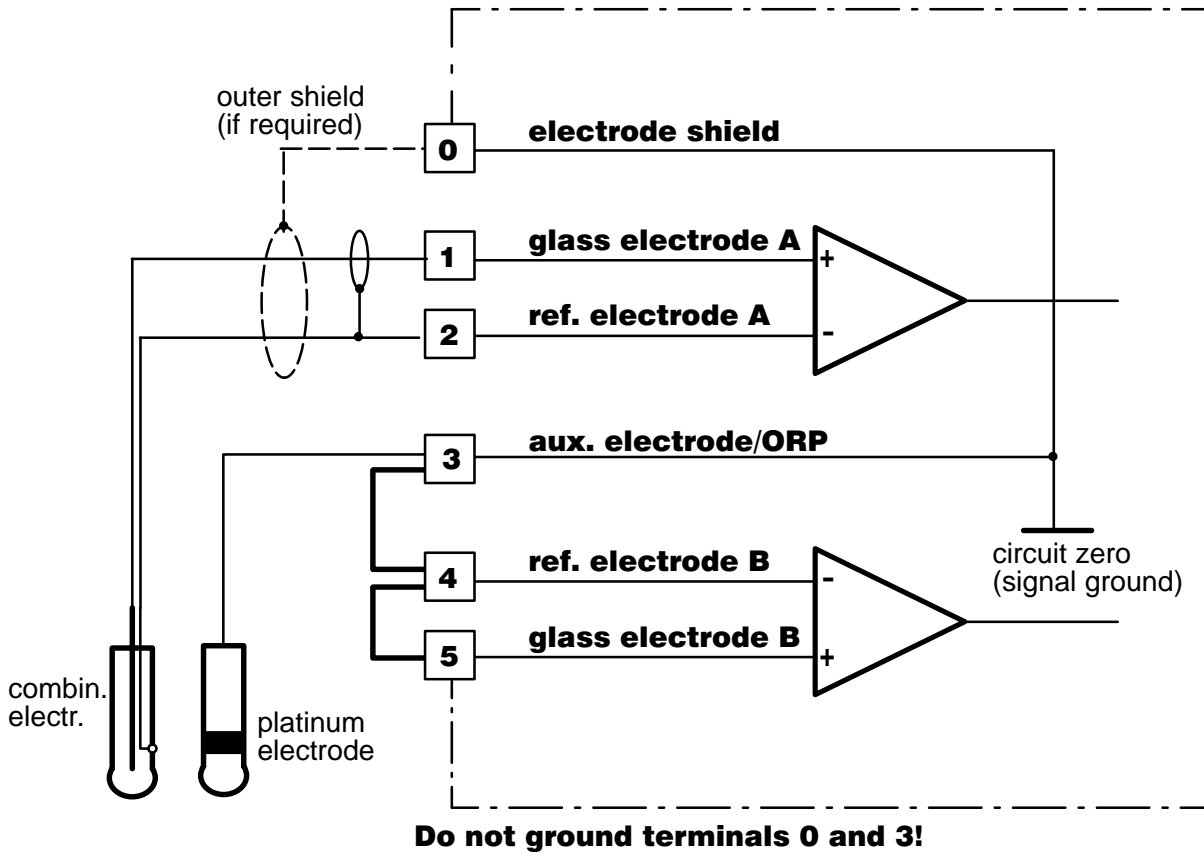

Fig. 2-6 Wiring of pH input for impedance measurement of glass and reference electrode with simultaneous ORP measurement

rH Measurement

The pH Transmitter 2800X calculates the rH value from two separately measured values (pH and ORP).

Direct calibration of rH measurement is not possible, but the pH electrode system can be calibrated separately.

You can use a combination electrode for pH measurement. The additionally required metal (platinum) electrode is connected to terminal 3 (auxiliary electrode). It also serves as auxiliary electrode for impedance measurement to permit electrode monitoring (see Fig. 2–6).

Temperature Detection

Why Temperature Compensation?

There are two important reasons for determining the temperature of process or buffer solution, resp.:

- The slope of the pH electrode system is temperature dependent. Therefore the measured voltage must be corrected for the temperature influence (Nernst equation).
- The pH value of the buffer solution is temperature dependent. For calibration, the buffer solution temperature must therefore be known in order to choose the actual pH value from the buffer chart.

Automatic Temperature Compensation

For automatic temperature compensation, the pH Transmitter 2800X detects the process temperature using a Pt 100/Pt 1000 temperature probe (opt. 456 Pt 100/ NTC 30 kΩ, opt. 476 NTC 30 kΩ/ Pt 1000).

3–wire configuration of the Pt 100/Pt 1000 temperature probe eliminates the temperature measurement error caused by the lead resistance. The leads to terminals 6 and 8 must have equal cross sections.

For 2–wire configuration, connect the Pt 100/ Pt 1000 to terminals 6 and 8. *Terminals 7 and 8 must be jumpered.*

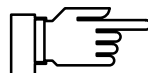
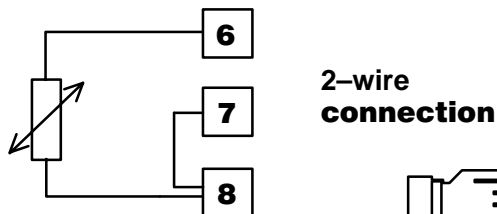
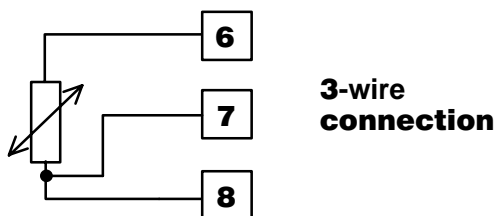

The Passive Outputs/Inputs

If your pH Transmitter is equipped with option 427 (additional passive outputs/inputs), it provides two further outputs in addition to the current loop. These outputs are passive and must be supplied via an additional power supply (e.g. repeater power supply WG 20). They can be set as 0(4) to 20 mA current loops for any desired variable, as switching or controller outputs or as SPC inputs (OK1/OK2), e.g. for the Unical[®] controller.

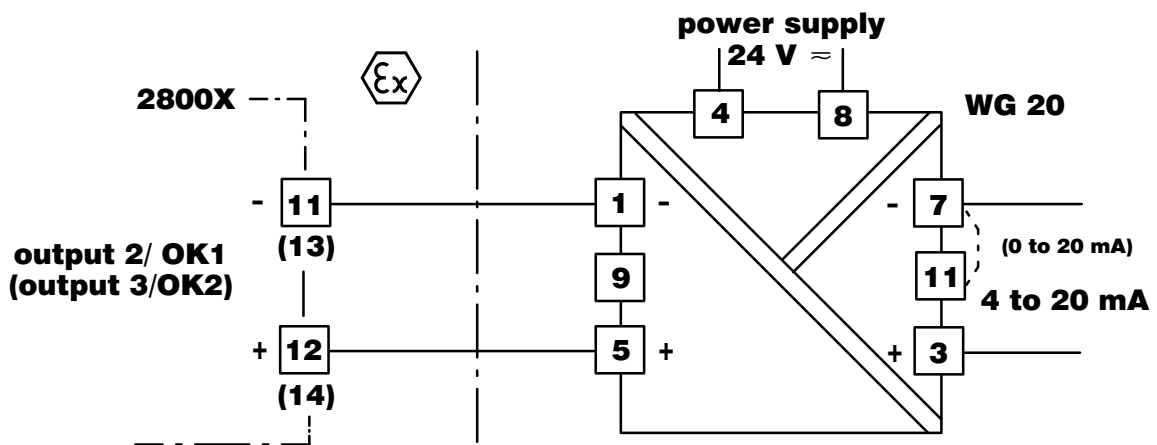

Fig. 2-7 Wiring of passive outputs/inputs as current outputs using Model WG 20

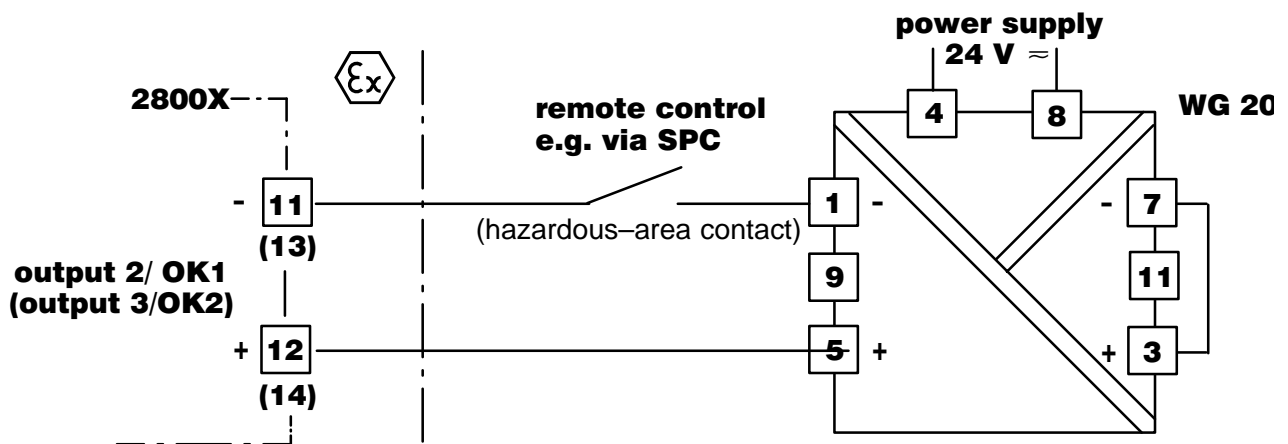

Fig. 2-8 Wiring of the passive outputs/inputs as SPC inputs using Model WG 20

The Interface

If your pH Transmitter is equipped with option 419 (interface), it can be completely remote controlled and configured via the V24/20 mA interface. All measured values, records, messages and settings can be read out.

For hazardous/non-hazardous area separation and for converting the V 24/20 mA signal in an RS 232 protocol, you can use the ZU 0098 X CL converter.

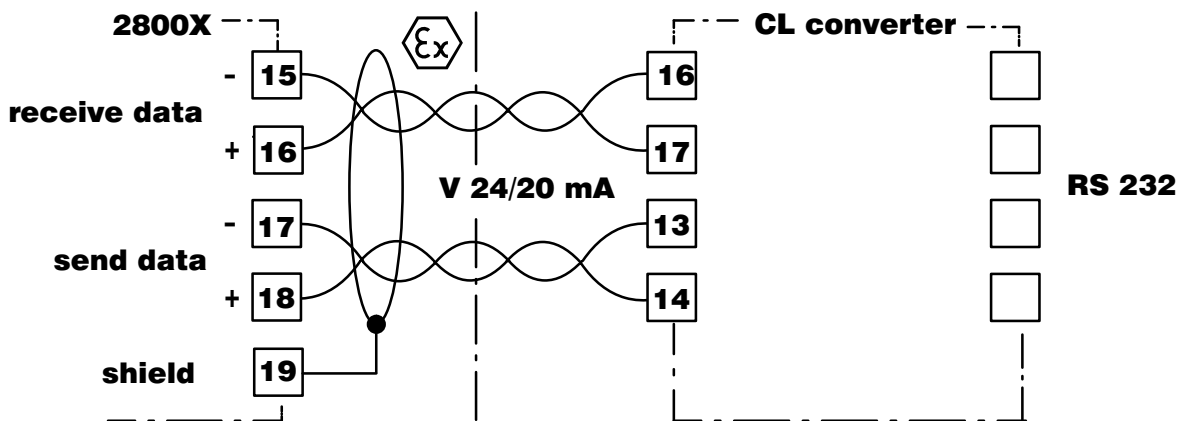

Fig. 2-9 Wiring of interface with ZU 0098 X CL converter

Unical[®] 79 (X) for Fully Automatic Calibration

If your pH Transmitter is equipped with option 420 (Unical[®] interface and Unical[®] sequencing control), you can control the Unical[®] 79 (X) electro-pneumatically controller via the interface. Unical[®] 79 (X) and a remote calibration probe allow fully automatic leaning and calibration of the pH or ORP electrode system.

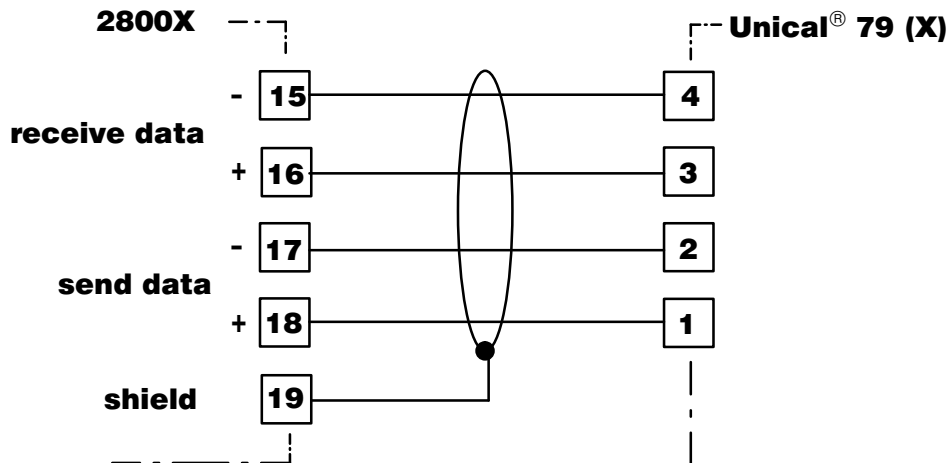

Fig. 2-10 Wiring of interface for control of Unical[®] 79 (X)

Terminal Assignments

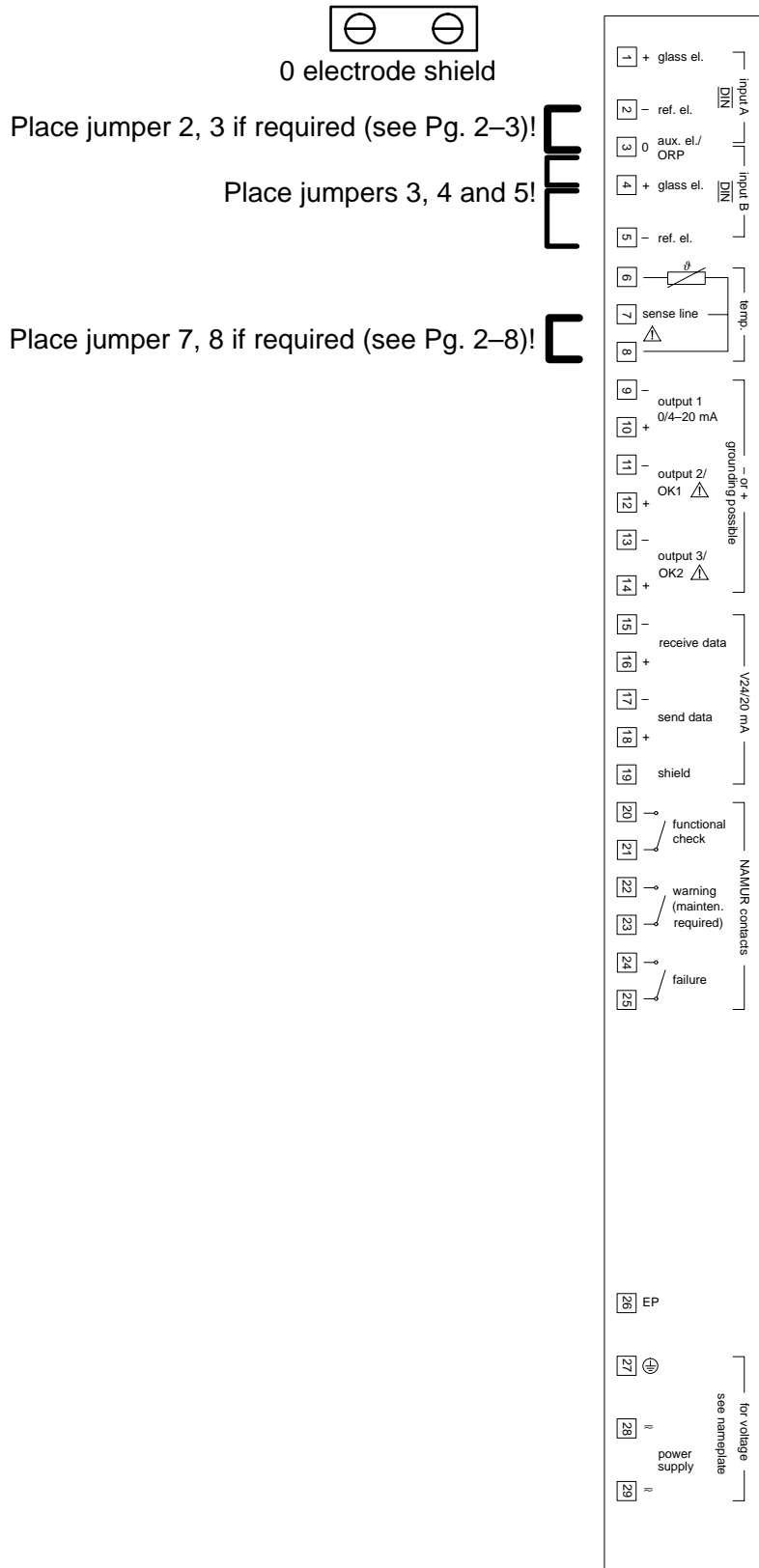

Fig. 2–13 Terminal Assignments

3 Operating the pH Transmitter 2800X



Commissioning of the pH Transmitter 2800X must be carried out only by specially trained personnel in accordance with this instruction manual. Before first start-up, a *complete parameter setting* procedure must be performed by a system administrator.

The User Interface

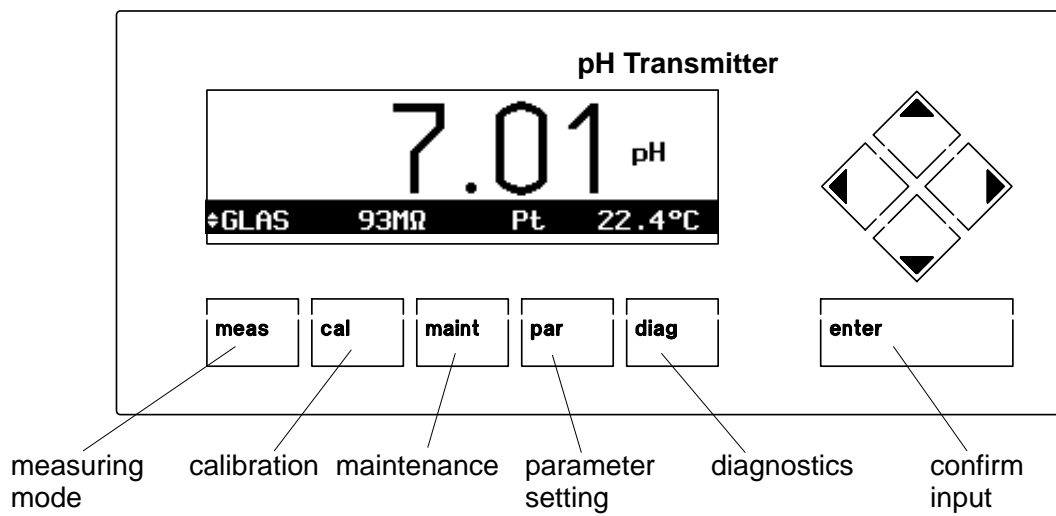
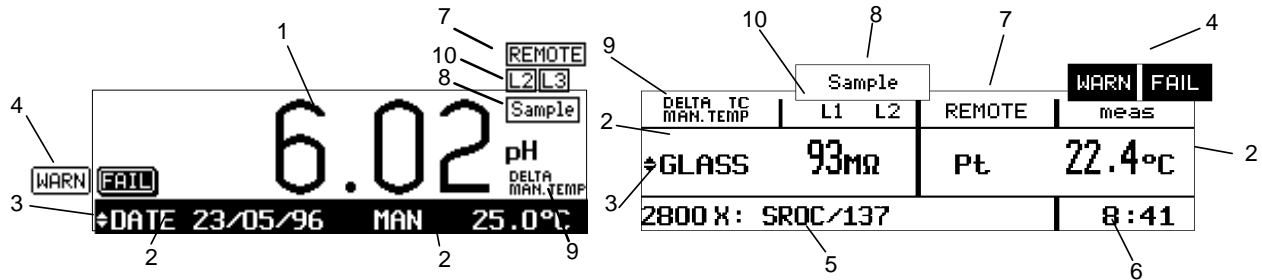

Fig. 3-1 User Interface of the pH Transmitter 2800X

The Measuring Mode











In measuring mode two different types of numeric displays are available. If your instrument is equipped with option 448 (measurement recorder) the variation of any two measured values can also be represented graphically. By pressing **meas** you can switch between the different types of representation.



The display consists of the following elements:

- 1 The measured value on the main display is selected during parameter setting (see Pg. 4–3)
- 2 The measured values on the additional displays are selected using ▲ and ▼.
- 3 The selection symbol ◆ indicates which additional display can be edited. By pressing ◀ and ▶ you can switch between the additional displays.
- 4 NAMUR messages: warning (maintenance required) and failure
- 5 measurement point or note (switching with **enter**)
- 6 current time
- 7 remote control via interface active, keypad blocked
- 8 sampling for calibration
- 9 indication of dependencies of the measured variables
- 10 limit values exceeded

Keypad Assignment in Measuring Mode

	switches between different types of measured value representations. With option 448 also to measurement recorder.
   	activate calibration, parameter setting, maintenance or diagnostics
	switches between measurement point and note
 	select additional display for changing the measured variable
 	change the measured variable on the additional display
	Refer to page 4–3, for an overview on the measured variables that can be displayed.

The Measurement Recorder

With the integrated measurement recorder (option 448) the pH Transmitter 2800X provides you a two-channel "on-site recorder". For optical representation of the process variations or, for example, for controller optimizing, the measurement recorder continuously registers two user-defined measured variables and represents them graphically side by side, with parallel time, on the system display. Measured variable, measurement range, type of recording and time feed are user defined within broad limits (see Pg. 4-31). The last 500 measured values are stored with time and date in the recorder storage of you pH Transmitter. They can also be displayed numerically (see Pg. 6-6).



The option 448 (measurement recorder) can be retrofitted via TAN (see Pg. 4-34).

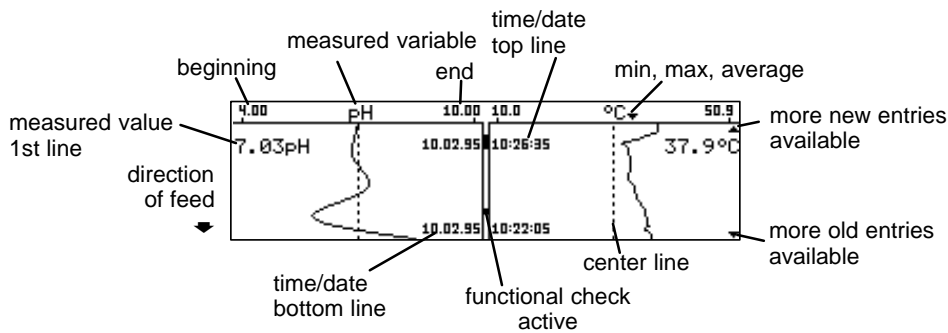

The Keypad Assignment for the Measurement Recorder

- meas** changes to measurement display
- cal** **par** **maint** **diag** activate calibration, parameter setting, maintenance or diagnostics
- enter** jump to current entry
- Left Arrow** **Right Arrow** go to next or previous page
- Up Arrow** **Down Arrow** go to next or previous line
- Up Arrow** + **enter** jump to current entry
- Down Arrow** + **enter** jump to oldest entry

The Menu Structure

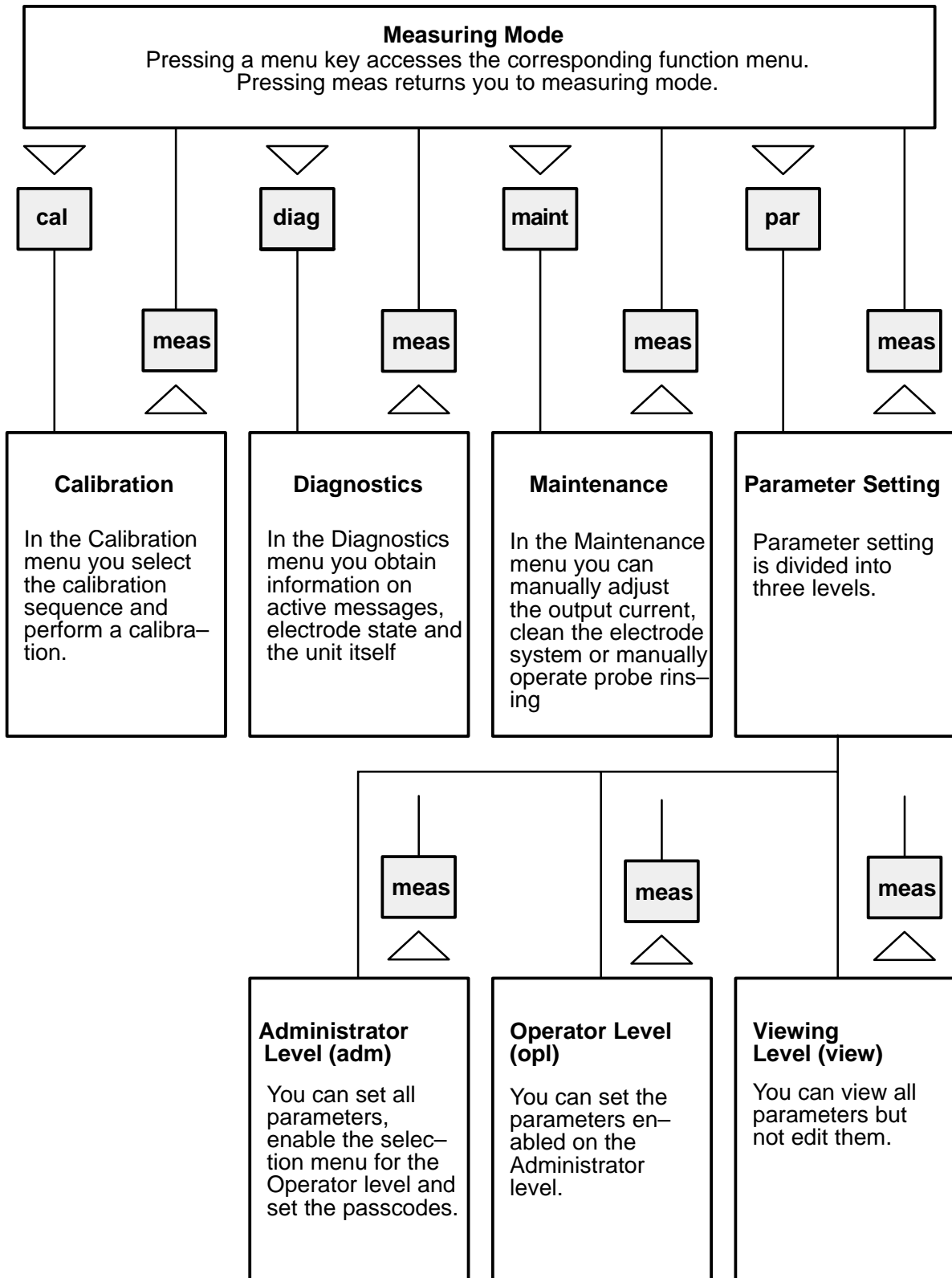
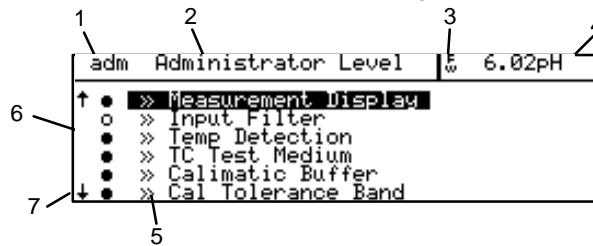

Fig. 3-2 Menu Structure

Menu Operation

When calibration, maintenance, parameter setting or diagnostics are active, the display shows the corresponding menu for operating the functions. Operator guidance is supported by a 7-line plain-text display with information texts. During operation measurement display (4) and active status messages (3) remain visible.



The menu display consists of the following elements:

- 1 This abbreviation indicates in which menu you currently are:
 - cal Calibration menu
 - maint Maintenance menu
 - view Parameter Setting, Viewing level
 - opl Parameter Setting, Operator level
 - adm Parameter Setting, Administrator level
 - diag Diagnostics menu
 - par Parameter Setting, language selection
- 2 The menu title informs you on the menu level, on which you currently are.
- 3 The status display indicates active warning (w) and/or failure messages (F).
- 4 The measured value remains visible in the menu.
- 5 The symbol » indicates that there is a submenu below this menu line.
- 6 The marker setting is only visible in the Parameter Setting menu. On the Administrator level you can block individual menu lines for the Operator level (see Pg. 4-2).
- 7 In longer menus it is not possible to display all lines at the same time. The symbols ↑ and ↓ indicate that there are further menu lines.

Keypad Assignments during Menu Operation:

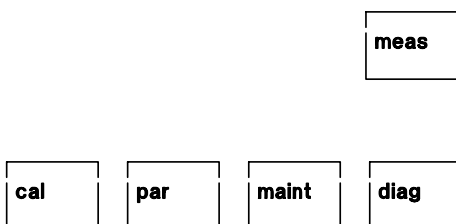

Exits the menu system and returns to measuring mode. In the Calibration or Maintenance menu you are prompted to confirm that your installation is ready for measurement.

Abort: To abort an entry (without storing the value) or to exit a submenu you can press the menu key. That means, parameter setting can be aborted using **par**, diagnostics using **diag**, etc.

```

adm Administrator Level | 7.01pH
↑ ● » Measurement Display
  ● » Input Filter
  ● » Temp Detection
  ● » TC Test Medium
  ● » Calimatic Buffer
↓ ● » Cal Tolerance Band

```

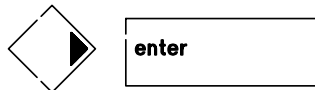
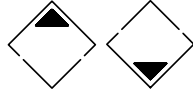

How to select a menu item:

The desired menu line is selected using the scrolling keys. The selected line is marked by a dark bar (inverted representation).

The scrolling keys provide a repeat function: When the key is held down, the lines are scrolled through.

Pressing **▶** or **enter** accesses the next (lower) menu level.

```

adm Measurement Display | 7.01pH
» Variable [pH]
  Display Format xx.xx xx.x
  Viewing Angle -2 -1 0 +1 +2
« Return [par]

```

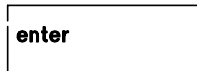
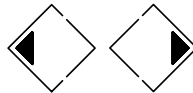

How to change a setting:

Pressing a cursor key changes the setting. The selected position is marked by a dark bar (inverted representation).

The entry position flashes because it has been modified but not yet stored.

Pressing **enter** stores the new setting. Flashing stops.

Pressing the menu key (e.g. **par**) instead of **enter** restores the old setting.

```

adm Alarm 0 [pH] | 7.01pH
» Alarm 0 [pH]
  Alarm 0 [pH] On Off
  Failure Limit Lo -02.00 pH
  Warning Limit Lo -02.00 pH
  Warning Limit Hi +16.00 pH
  Failure Limit Hi +16.00 pH
↓

```

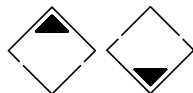
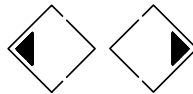

How to change numeric values:

displace the cursor within the input area to select the input position.

If the input value has a sign, it can be selected using **◀**.

If you edit numeric values whose input area covers several decades (e.g. conductivity), the symbol \Leftrightarrow appears in front of the numbers. Now you can displace the decimal point using the cursor keys.

Pressing a scrolling key scrolls the numbers from 0 through 9 or changes the sign.

Pressing **enter** stores the edited setting.

Pressing a menu key (e.g. **par**) instead of **enter** restores the old setting.

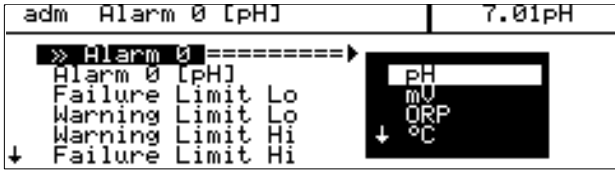

How to select parameters in a roll-up menu:

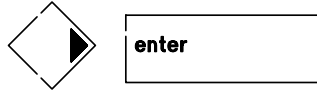

Pressing **▶** or **enter** accesses roll-up selection. An inverted menu is displayed.

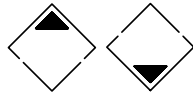

The desired menu line is selected using the scrolling keys. The selected line is marked by a dark bar (inverted representation).

The entry line flashes because it has been modified but not yet stored.



Pressing **enter** stores the new setting. Flashing stops.

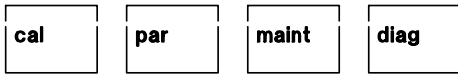

Pressing the menu key (e.g. **par**) instead of **enter** restores the old setting.

4 Parameter Setting



Commissioning of the pH Transmitter 2800X must be carried out only by specially trained personnel in accordance with this instruction manual. Before first start-up, a *complete parameter setting* procedure must be performed by a system administrator.

Language Selection

When you access parameter setting you can select the language for displays and menu texts. You can choose between German, English, French, Italian and Spanish.

par	Parameter Setting	7.01pH
» Language	Deutsch	
» Viewing Le	English	ll Data) view
» Operator L	Français	on Data) opl
» Administra	Italiano	ll Data) adm
« Return to	Español	par]

The Three Levels of Parameter Setting

The Parameter Setting menu is subdivided into a Viewing, Operator and an Administrator level according to the user's degree of specialization.

adm	Parameter Setting	7.01pH
» Language	[English]	
» Viewing Level	(All Data)	view
» Operator Level	(Operation Data)	opl
» Administrator Level	(All Data)	adm
« Return to measurement	[par]	

- On the Viewing level the settings can be displayed but not edited.
- On the Operator level only marked menu items are enabled for parameter setting.
- On the Administrator level all parameter setting functions can be accessed. In addition, you can mark certain menu items to configure an optimal menu for the Operator level. Passcodes protect the Operator and Administrator level against unauthorized access. For the Operator level, they can be disabled if required.

The levels are identified by abbreviations in the upper left corner of the display:

view – Viewing level
opl – Operator level
adm – Administrator level

Access to the Operator level can be protected by a passcode if required. Access to the Administrator level is always protected by a passcode.

The Viewing Level

On the Viewing level you can display all instrument settings.

Settings cannot be edited!

```

opl Operator Level | 7.01pH
● >> Measurement Display
○ >> Input Filter
● >> Temp Detection
● >> TC Test Medium
● >> Calimatic Buffer
↓ ● >> Cal Tolerance Band
    
```

The Operator Level

On the Operator level you can only edit certain parameters (menu items) of the pH Transmitter that have been enabled on the Administrator level.

If a menu item has been enabled can be seen from the dot in front of the corresponding menu item.

- This menu item can be edited.
- This menu item has been locked: It *cannot* be edited. The menu item is skipped during scrolling. However, it can be read out on the Viewing level.

Access to the Operator level can be protected by a passcode.

The Administrator Level

On the Administrator level you can edit all instrument settings including the passcodes. In addition, the marker function allows to lock individual menu items to prevent access from the Operator level.



As delivered, all menu items are enabled.

Access to the Administrator level is always protected by a passcode.

```

adm Administrator Level | 7.01pH
Marker Setting:
● [+][+] Select Marker
● [+][+] Change Setting
● [enter] Accept Setting
<< Return [par] >> Proceed [enter]
    
```

The Marker Setting

An information text explains the marker setting on the Administrator level.

The marker setting allows to enable or disable individual menu items of the Parameter Setting (except "Passcode Entry") for the Operator level:

- This menu item has been enabled: It can be edited on the Operator level.
- This menu item is locked: It *cannot* be edited on the Operator level. However, it can be read out on the Viewing level.

How to set a marker

```

adm Administrator Level | 7.01pH
○ >> Factory Setting
● >> Measurement Display
○ >> Input Filter
● >> Temp Detection
● >> TC Test Medium
↓ ● >> Calimatic Buffer
    
```

Press ◀ to select the marker.

Press ▼ or ▲ to enable (●) or lock (○) the menu item.

Confirm the setting with **enter**.

```
adm Factory Setting | 7.01pH
● The factory setting erases
| all your set parameters!
» Parameter Set => 2800(X) ed>
Factory Setting      Quit
```



The Factory Setting

On the Administrator level you can reset all settings to the initial factory setting.

Before a new start-up of the pH Transmitter 2800X a *complete parameter setting* procedure must be performed by a system administrator.

```
7.02 pH
MAN. TEMP
REF 4.9kΩ ± Pt 22.4°C
```

```
adm Measurement Display | 7.01pH
» Variable =====>
Display Format  ×
Viewing Angle -
« Return [par]  ↓
                pH
                mV
                ORP
                rH
                .x
                +1 +2
```

The Measurement Display

During parameter setting you can define which of the values measured will be read out on the large display. The following variables can be displayed:

- pH value
- mV value
- ORP value
- rH value
- measured temperature (°C)
- time

The following variables can be read out on the additional displays:

- MAN manual measuring temp (°C)
- OUTP1 output current 1
- OUTP2 output current 2
(only with option 427)
- OUTP3 output current 3
(only with option 427)
- Xw controller setpoint
(only with option 353
and active controller)
- CTL-Y controller output
(manipulated variable)
(only with option 353
and active controller)
- REF reference electrode impedance
- GLASS glass electrode impedance
- DATE date
- CTIME calibration timer



For information on how to select the variable on the additional display, refer to Pg. 3–2.

```
adm Measurement Display | 7.01pH
» Variable [pH]
Display Format xx.xx xx.x
Viewing Angle -2 -1 0 +1 +2
« Return [par]
```

```
adm Measurement Display | 7.01pH
» Variable [pH]
Display Format xx.xx xx.x
Viewing Angle -2 -1 0 +1 +2
« Return [par]
```

With "Variable pH" selected, you can select "Display Format" to define if the pH value will be displayed with one (xx.x) or two (xx.xx) digits behind the decimal point.

The menu item "Viewing Angle" allows you to adjust the viewing angle of the display. When the pH Transmitter is mounted at a very high or very low position, you can adjust the viewing angle for optimum display readability. Select the desired viewing angle using ◀ and ▶ (+ means viewing angle upwards and – means viewing angle downwards) and confirm your choice with **enter**.

The angle is changed immediately.

```
adm Input Filter | 7.01pH
Pulse Suppression On Off
« Return [par]
```

The Input Filter

For pH measurement with increased immunity to interference, you can activate an input filter. When the filter is activated, momentary interference pulses will be suppressed, and slow changes in the measured value will be detected.

If you want to measure fast changes in the measured value, you must turn off the input filter.

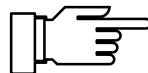

Temperature Detection

Why Temperature Compensation?

There are two important reasons for determining the temperature of process or buffer solution, resp.:

- The slope of the pH electrode system is temperature dependent. Therefore the measured voltage must be corrected for the temperature influence (Nernst equation).
- The pH value of the buffer solution is temperature dependent. For calibration, the buffer solution temperature must therefore be known in order to choose the actual pH value from the buffer chart.

During parameter setting you define if process and/or calibration temperature are automatically measured or must be entered manually.



```
adm Temp Detection | 7.01pH
Pt100/Pt1000 Temp Probe
Measuring Temp Auto Manual
Cal Temp Auto Manual
« Return [par]
```

Automatic Temperature Compensation

For automatic temperature compensation, the pH Transmitter 2800X detects the process temperature using a Pt 100/Pt 1000 temperature probe (option 456: Pt 100/NTC 30 kΩ, option 476: NTC 30 kΩ/Pt 1000).



For automatic temperature compensation, there *must* be a temperature probe in the process medium. This probe must be connected to the Pt 100/ Pt 1000 input of the pH Transmitter 2800X! If no temperature probe is connected, you must select manual entry of measuring temperature.

Manual Temperature Compensation



Manual temperature compensation only makes sense if the process is running at a constant temperature!

With "Measuring Temp Manual" selected, "MAN.TEMP" will be read in the lower right corner of the display in measuring mode. The reading "MAN.TEMP" will *not* appear if the measuring temperature is read on the measurement display. You can read out the manually defined temperature on the additional display (see page 3–2).



With "Measuring Temp Manual" selected, automatic temperature measurement continues, and display, limit values and alarm messages are controlled by the measured value.

adm Temp Detection	7.01pH
Pt100/Pt1000 Temp Probe	
Measuring Temp	Auto <input checked="" type="checkbox"/> Manual
Manual:	+025.0 °C
Cal Temp	Auto <input checked="" type="checkbox"/> Manual
Manual:	+025.0 °C
<< Return [par]	

You must enter the process temperature:

Measure the temperature of the measured medium using a glass thermometer, for example,

or

make sure that the temperature of the measured medium is at a constant level, e.g. using a thermostat.



Manual compensation of the calibration temperature only makes sense if the temperature probe remains in the process medium during calibration.

Temperature Compensation of the Measured Medium

Ultrapure Water

adm TC Test Medium pH	7.01pH
<input checked="" type="checkbox"/> User-Defined Chart or Ultrapure Water with Traces of Impurity <input type="checkbox"/> TC Off <input checked="" type="checkbox"/> Ultrapure Water Chart << Return [par]	

If you measure "ultrapure water", the pH value can be correspondingly calculated for the correct temperature.

It is corrected according to the following equation:

$$\text{pH}(25\text{ °C}) = \text{pH}(T) + \text{corr}(T)$$

pH(25 °C) pH corrected for 25 °C
 pH(T) pH measured at T[°C]
 corr(T) correction value [pH] from chart

The correction chart stored for the pH Transmitter 2800X has been calculated for completely dissociated electrolytes (strong acids and bases) and for the weakly dissociating electrolyte ammonia. This is of special interest for power plant applications where the pH determining substance is mainly ammonia.

Chart

adm	TC Test Medium pH	7.01pH
↑	TC Off Ultrapure Water	Chart
	TC at 00°C:	+00.00 %
	TC at 05°C:	+00.00 %
	TC at 10°C:	+00.00 %
	TC at 15°C:	+00.00 %
↓	TC at 20°C:	+00.00 %

When measuring media with a known temperature behavior, the output pH value can be corrected via a chart. TC can be entered for temperatures between 0 and +95 °C in 5 °C steps. Then the output pH value is corrected by the corresponding TC value depending on the measuring temperature. Intermediate values are linearly interpolated. In the case of lower or higher temperatures (< 0 °C or > +95 °C) the last chart value is used for calculation.

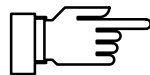

If delta function has been activated simultaneously (see Pg. 4–11) with TC correction, first TC is corrected and then the delta value subtracted. If TC correction is enabled for the measured media, the display indicates "TC" during measuring mode.

The Calimatic® Buffer Set

adm	Calimatic Buffer	7.01pH
●	Select Buffer Set	
█	Mettler Toledo 2.00 4.01 7.00 9.21	
»	Buffer Set [Mettler Toledo]	
«	Return [par]	

For automatic calibration via Calimatic®, you must define the buffer set you want to use. For calibration, you must then use buffer solutions from this buffer set, the sequence being irrelevant. On the informations display you can see the selected buffer set with the nominal values of the individual buffer solutions.

adm	Calimatic Buffer	7.01pH
●	Select Buffer Set	
█	Mettler Toledo 2	Mettler Toledo
»	Buffer Set =====>	Merck/Riedel
		DIN 19267
«	Return [par]	Ciba

The roll-up menu shows all available buffer sets. Options 370 to 379 (buffer sets to customer specifications) extend the listing.



The buffer sets of options 370 to 379 (buffer sets to customer specifications) can be retrofitted via TAN, if available (see Pg. 34).

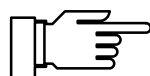

For buffer charts, refer to chapter 12.

The Tolerance Band Calibration



You can only make use of tolerance band calibration if your pH Transmitter is equipped with option 447 (tolerance band calibration and tolerance band recorder).

Why Tolerance Band Calibration?

Tolerance band calibration prevents that slight calibration scatters of zero and slope as they usually occur in practice immediately lead to a readjustment of the calibration data and thus to a shifting of the measured value. The values are only readjusted if the data lie out of user-defined tolerance bands, that means only in the case of significant changes.

Tolerance Band Calibration and Tolerance Band Recorder

The tolerable error limits are defined for zero and slope.

```
adm Cal Tolerance Band | 7.01pH
● Calibration data taken over when
  tolerance band exceeded
Tolerance Band Check   On Off
Tolerance Zero         +00.20 pH
↓ Tolerance Slope      002.0 mV/pH
```



The tolerance band recorder graphically represents the determined calibration data and the adjusted tolerance bands on the display. Drift due to ageing or calibration scatters can be identified at a glance. This helps to draw conclusions on electrode life and the required calibration interval.

```
adm Cal Tolerance Band | 7.01pH
● Calibration data taken over when
  tolerance band exceeded
Tolerance Band Check   On Off
<< Return [par]
```

If the zero and slope values determined during calibration remain within the tolerance bands, the new data are not taken over. The measured value is not changed. If one of the calibration values lies out of the tolerance band, **both** values are taken over as new calibration data. In the cal record you can see if the data have been taken over ("New EI Data") or if the old calibration data can still be tolerated ("Old EI Data").

```
diag Cal Record | 7.01pH
Last Calibration      13.02.96 08:06
Cal Tolerance Band:  New ei data
Cal Mode             Manual Entry
Zero                 +07.00 pH
↓ Slope              +058.0 mV/pH
<< Return [diag] [↑][↓] Scrolling
```

With tolerance band control disabled, every calibration is directly taken over. There is no tolerance band entry in the cal record. The tolerance band recorder represents the calibration data without tolerance limits.

If you want to use the cal tolerance band but your pH Transmitter is not equipped with option 447, you can retrofit the option. See Release of Options on page 4–34.



adm	ORP Check	7.01pH
█	Test Period	0010 s
	Test Difference	+0010 mV
	<< Return	[par]

ORP Check

For ORP measurements it is not useful to standardize the electrode. As a check on the electrode its running-in behavior is evaluated under defined conditions. For this purpose you can enter the parameters test difference and test period.

The pH Transmitter 2800X allows to check electrode systems with a reference electrode of the type "3 mol/l KCl-Ag/AgCl".

As reference solution the redox buffer solution rH 28.4 (Mettler Toledo, order number 20 9881 250) is used. If the differential voltage between electrode potential and setpoint of the reference solution falls below the test difference within the preset test period, the electrode system is considered stable, checking is terminated.

If the electrode system only reaches the test difference after the test period has elapsed, the warning message "Warn Probe Unstable" is activated. If the voltage value does not fall below the test difference even after the double test period has elapsed, the failure message "Fail Probe Failure" is activated.

Nominal Electrode Zero and Nominal Electrode Slope

The Option 356 (integrated as standard in all instruments) allows to define the nominal zero and slope of the electrode if you use electrodes with a zero point other than pH 7.

adm	Nominal: Zero/Slp	7.01pH
●	Adm. Setting Span for Cal	
█	Zero ± 1 pH, Slope ± 5.5 mV/pH	
█	Nominal Zero	+07.00 pH
	Nominal Slope	055.5 mV/pH
	<< Return	[par]



Here, automatic calibration via Calimatic® can also be performed for electrode systems with a zero point at pH = 4.6, for example.

Calibration is valid if electrode zero deviates by $< \pm 1$ pH unit and slope by $< \pm 5.5$ mV/pH from the nominal value.

adm rH Value	7.01pH
Calculate rH with factor	Yes No
>> Reference Electrode	
<< Return [par]	

rH Measurement

The pH Transmitter 2800X calculates the rH value from two separately measured values (pH and ORP).

Direct calibration of rH measurement is not possible, but the pH electrode system can be calibrated separately.

You can use a combination electrode for pH measurement. The additionally required metal (platinum) electrode also serves as auxiliary electrode for impedance measurement to permit electrode monitoring. (For wiring see Fig. 2–6 on Pg. 2–7.)

The electrode system is calibrated using ordinary pH buffer solutions, since the additional platinum electrode can be regarded as practically calibration-free.

After pH calibration, pH and rH value can be checked using rH buffer solutions.

adm Reference Electrode	7.01pH
A Silver Chloride	Ag/AgCl, KCl 1m
B Silver Chloride	Ag/AgCl, KCl 3m
C Thalamid	Hg, TI/TlCl, KCl 3.5m
D Mercury Sulfate	Hg/Hg2SO4, K2SO4 sat.
Select electrode	A B C D
<< Return [par]	

In the Parameter Setting menu you can choose between different reference electrodes whose temperature dependent reference potentials E_{ref} against standard hydrogen electrode (SHE) are listed in the pH Transmitter 2800X:

- Silver Chloride Ag/AgCl, KCl 1M
- Silver Chloride Ag/AgCl, KCl 3M
- Thalamid Hg, TI/TlCl, KCl 3.5M
- Mercury Sulfate Hg/Hg₂SO₄, K₂SO₄ saturated

Theory of rH Measurement

Reduction–oxidation (redox) behavior of substances in an aqueous solution is correctly described by specifying the potential E_H across a chemically indifferent metallic electrode and the standard hydrogen electrode (SHE), as well as the measuring temperature.

Since in most cases ORP measurement is pH dependent, you must also indicate the pH value.

The sensing electrode is a chemically nonreactive, electron–sensitive electrode consisting of a noble metal, such as platinum.

The SHE is usually not employed as reference electrode, but an electrode that is easier to handle, such as an Ag/AgCl electrode. Its temperature–dependent potential E_{ref} related to SHE must be known. It must be added to the measured potential.

$$E_H = \text{ORP} + E_{ref}$$

Another measure for redox behavior is the **rH value**.

It is calculated from the so-called pe value which describes redox behavior and the pH value.

The pe value is a theoretical auxiliary value calculated by multiplication of E_H and $1/E_N$ (reciprocal of Nernst potential).

The rH value is defined as follows:

$$rH = (pe+pH) \cdot 2 \quad \text{or} \quad rH = (E_H/E_N + pH) \cdot 2$$

The pH Transmitter 2800X processes this equation in the following way:

$$rH = (((ORP + E_{ref}) / E_N) + pH) \cdot 2 \cdot \text{factor.}$$

with

ORP: potential measured across platinum and reference electrode

E_{ref} : listed, temperature-dependent potential of reference electrode against SHE (user defined)

E_N : Nernst potential (temperature dependent)

pH: currently measured pH value

"2": theoretical factor for rH value

factor: additional, empirical factor (user defined, standard: 1)

Thus, two potentials across three electrodes are required for rH measurement:

Glass electrode against reference electrode (pH electrode system) and platinum electrode against reference electrode (ORP electrode system).

ORP and pH are combined to form the rH value to obtain a pH-independent measure for redox behavior. However, this is only valid if the following conditions apply, among others:

- Protons play a decisive role in the reaction.
- Preferably exactly one mol of protons is transformed.
- The range for pH variation is as low as possible.

The rH value can also be measured "directly" by measuring the potential across a platinum and a glass electrode of a so-called rH electrode system. However, from this value you can neither calculate the pH nor the ORP value. Therefore, automatic calculation of rH as provided by the pH Transmitter 2800X should be preferred.

adm rH Value	7.01pH
Calculate rH with factor	Yes No
Factor	01.00
>> Reference Electrode	
<< Return [par]	

The factor "2" in the equation for determining the rH value results from the fact that an H₂ molecule dissociates into two protons.

The equation also includes a user defined additional factor for some special empirical measurement procedures used in the chemical production industry.



The equation for determining the theoretical rH value only applies if you have set "Calculate rH with factor No" or if you have set the factor to 1 during parameter setting.

The Delta Function

adm Delta Function	7.01pH
>> Delta Function ==>	Off
<< Return [par]	
	PH mV ORP

The delta function allows calculation and direct indication and output of differential values for the measured pH, mV and ORP values.

This is used for example to directly relate a measured ORP value to a standard hydrogen electrode.

adm Delta Function	7.01pH
>> Delta Function	[pH]
Delta Value	+01.00 pH
<< Return [par]	

To do so, enter a delta value that will be subtracted from the selected measured variable.

$$\text{Output Value} = \text{Measured Value} - \text{Delta Value}$$



Current outputs, controller and limit values are driven by the output value. It is also read on the displays. In measuring mode "DELTA" appears on the display.

If TC correction is activated at the same time, first, TC correction is carried out and then the delta value subtracted.

Current Output 1

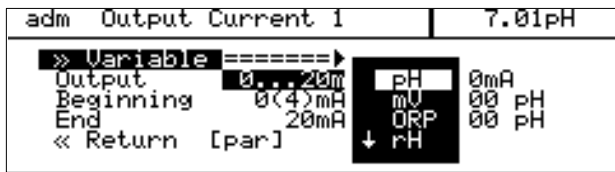

The current output provides an impressed standard current of 0 to 20 mA or 4 to 20 mA. The output current can be read out on an additional display (see page 3–2).

You can assign the output current to any of the following variables:

- pH value
- measured mV value
- ORP value
- rH value
- measured temperature (°C)

Output current will be frozen at its last value:

- during calibration
- during current source function (manual entry)
- in menu "maint Meas. Point Maint."
- after the corresponding interface command

Outputs/Inputs 2 and 3

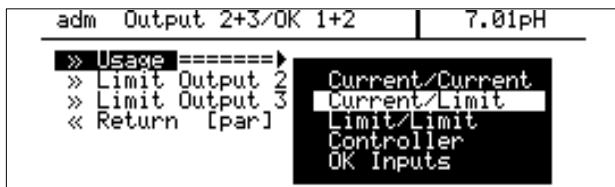

If your pH Transmitter is equipped with option 427 (two additional passive outputs/inputs), you can either simultaneously output two further measured variables via the additional current outputs, use the outputs as limit switches or as SPC control inputs (OK inputs).

If your pH Transmitter is additionally equipped with option 353 (controller function), the outputs can also be used as controller outputs.

Defined as Current Outputs

If outputs 2 and 3 are defined as current outputs, the following variables can be output:

- pH value
- measured mV value
- ORP value
- rH value
- measured temperature

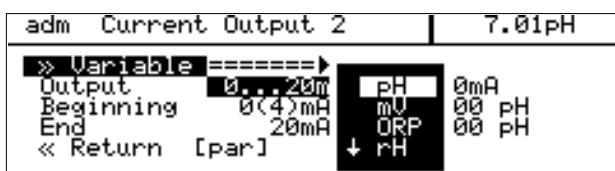

```

adm Current Output 2 | 7.01pH
» Variable [pH]
Output 0...20mA 4...20mA
Beginning 0(4)mA -02.00 pH
End 20mA +16.00 pH
« Return [par]

```



The current outputs are separately definable. Besides the measured variable, you can set the output current (0 to 20 mA or 4 to 20 mA), beginning and end of scale.

Outputs 2 and 3 are passive. They require an additional power supply (e.g. WG 21 repeater power supply). If this supply is missing, the pH Transmitter displays the error message "Fail Current Load".

Defined as Limit Contacts

```

adm Limit Output 2 | 7.01pH
» Variable ----->
Direction [pH]
Limit 1 [pH]
Hysteresis [pH]
Limit Contact [pH]
« Return [par]

```

If outputs 2 and 3 are defined as limit contacts, they can be controlled by the following variables:

- pH value
- measured mV value
- ORP value
- rH value
- measured temperature

```

adm Limit Output 2 | 7.01pH
» Variable [pH]
Direction [pH]
Limit 1 Min Max
Hysteresis +00.20 pH
Limit Contact N/O N/C
« Return [par]

```

Each of the two contacts can be set separately:

- The *measured variable* controls the limit contact.
- The *effective direction* determines if the contact will be activated when the measured value falls below (Min) or exceeds (Max) the limit value.
- *Limit values 2 and 3* (L2, L3) determine the switching threshold.
- The *hysteresis (deadband)* defines how far the measured value must exceed (min) or fall below (max) the limit value until the contact returns to its rest position.
- *Normally open or normally closed contact* defines if the active contact is closed (N/O) or open (N/C).

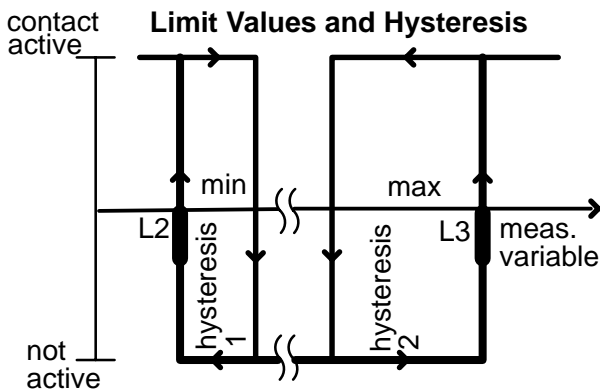

```

7.01 [L2][L3] pH
MAN. TEMP
7.01pH OUTPUT 10.01mA

```

If the measured value exceeds the preset limits, "L2" and/or "L3" will appear in the upper right corner of the display. Contact 2 and/or contact 3 are active.



During calibration the limit contacts are disabled!
 During sample calibration, the "L2"/"L3" display is covered by "Sample"
 When the pH Transmitter is in remote status during interface operation, the "L2"/"L3" display is covered by "Remote"!

Defined as Controller



You can only make use of the controller function if your pH Transmitter is equipped with option 353.



The pH Transmitter provides a bidirectional PI controller that allows quasi continuous (switched) control or an analog controller.

You can choose between four controller types:

- pulse frequency controller (pulsed)
- pulse length controller (pulsed)
- 3-way mixing valve (analog)
- straightway valves (analog)

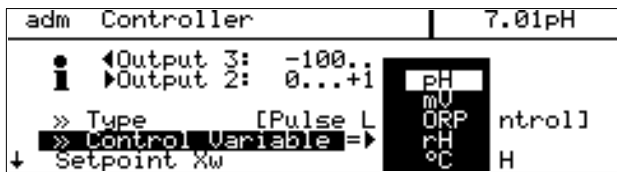

You can define as **controlled variables**:

- pH value
- measured mV value
- ORP value
- rH value
- measured temperature value (°C)



In measuring mode the present value of the controller output (CTL-Y [%]) and the controller setpoint (X_w) can be read out on the additional display.

With the user defined **feed time alarm**, you can monitor how long the controller output is at +100 % or -100 %, that is how long the valve is fully open.
 If this time is exceeded, the feed chemical (acid or base) might be missing or the valve might be defective.

```

adm Controller | 7.01pH
● ◀Output 3: -100...0 %
┃ ▶Output 2: 0...+100 %

» Type [Pulse Length Control]
» Control Variable [pH]
Setpoint Xw +07.00 pH
Neutral Zone +00.00 pH
Minimum ON Time 0001 s
◀Beginning Control +00.00 pH
◀Corner X +04.00 pH
◀Corner Y +050.0 %
◀Reset Time 0000 s
◀Period 0010 s
▶End Control +14.00 pH
▶Corner X +10.00 pH
▶Corner Y +050.0 %
▶Reset Time 0000 s
▶Period 0010 s
Cal/Maint active Y=const Y=0%
◀ Return [par]

```

The Control Characteristic

Fig. 4–3 shows the characteristic of the controller in the pH Transmitter 2800X. All points of the curve are user definable:

- *Beginning of control* and *end of control* define the control range. Outside the control range, the controller output is fixed at +100 % or –100 %, respectively.
- It is controlled according to the *setpoint*.
- In the *neutral zone* no control is exerted. The neutral zone is symmetrical to the setpoint. Its width is user definable.
- *Corner point X* and *corner point Y* are user definable corner points for the two control ranges (◀: controlled variable < setpoint and ▶: controlled variable > setpoint). This allows you to define two different slopes to obtain an optimum control characteristic for strongly nonlinear titration curves, for example.
- The *reset time* determines the I-action component of the controller. The setting "Reset Time 0000 s", turns the I-action component off. Reset time can be defined separately for each of the two control ranges (◀: controlled variable < setpoint and ▶: controlled variable > setpoint).
- *Cal/Maint Active* allows to select if the controller output is frozen at its last value during calibration and maintenance (Y = const) or if the controller output goes to 0 % (Y = 0 %).

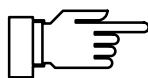

For test purposes, the controller output (manipulated variable Y) can be manually entered in the Maintenance menu (see page 7–3).

The Controller Output

For the pulse length and pulse frequency controller and the straightway valve the controller output (manipulated variable) is output via the outputs 2 and 3.

- Output 2 operates in the controller output range of 0 to +100 %.
- Output 3 operates in the controller output range of 0 to –100 %.

For the 3-way-mixing valve the controller output is only output via output 2.

- Output 2 operates in the controller output range of 0 to +100 %.

If set as digital controller, the outputs are used as contacts. This allows to control valves of feeding pumps, for example. Contact ON time or switching frequency, resp., vary according to the controller output.

If set as analog controller, the outputs are used as current outputs, either 0 to 20 mA or 4 to 20 mA. The valve type determines the behavior of the two output currents. You can choose between a 3-way mixing valve or two straightway valves.

The current controller output and setpoint values can be read out on the additional displays (see Pg. 3-2).

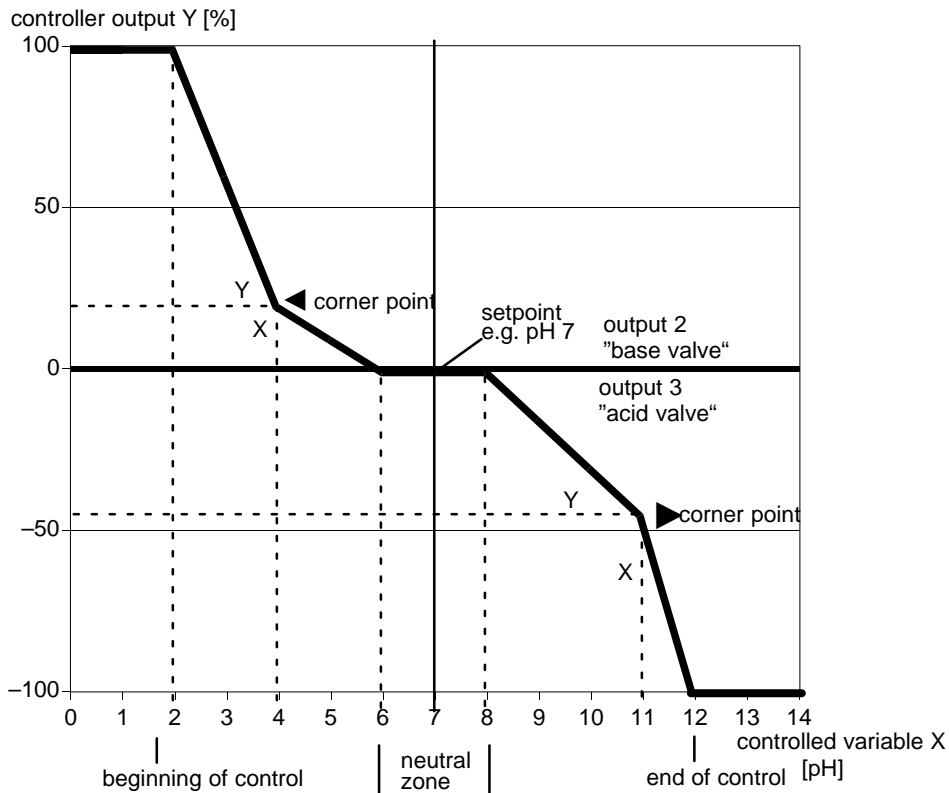
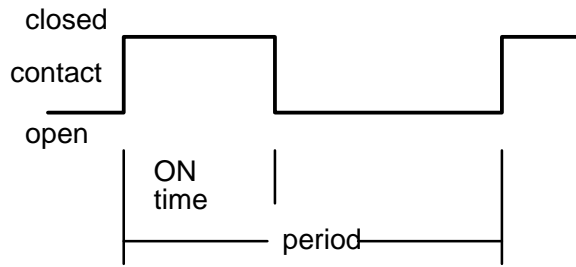

Fig. 4-3 Control Characteristic



The Pulse Length Controller

The pulse length controller controls valves used as actuators. The pulse length controller switches the contacts on, the ON time depending on the controller output.

The *period* is constant. It can be separately defined for each of the two control ranges to adjust for two different valve types, for example.

A *minimum ON time* is maintained even if the controller output takes corresponding values. This helps to allow for the reaction time of a valve, for example.

If the minimum ON time is set to 0, there is still a minimum ON time of 0.25 s for technical reasons.

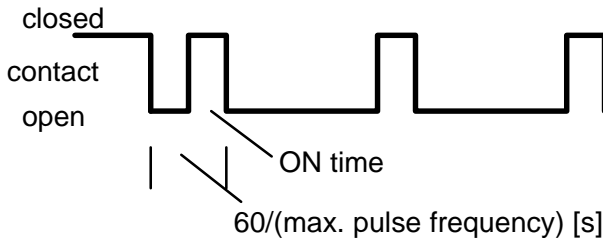

The Pulse Frequency Controller

The pulse frequency controller controls (frequency controlled) feeding pumps used as actuators. The pulse frequency controller varies the frequency at which the contacts are switched on.

You can define a maximum pulse frequency [p/min]. It depends on the feeding pump in use.

The maximum value to be entered is 120 p/min.

ON time is constant.

It is automatically calculated from the user-defined maximum pulse frequency:

$$\text{ON time [s]} = 30 / \text{max. pulse frequency [p/min]}$$

The 3-Way Mixing Valve

For the 3-way mixing valve, only output 2 is active. A controller output of $Y = 0\%$ corresponds to a current of 10 or 12 mA. Output 3 always remains at 0 or 4 mA, respectively.

The Straightway Valves

With the setting "Straightway Valves" both outputs are active. Output 2 is active if the controlled variable is lower than the setpoint. Output 3 is active if the controlled variable is higher than the setpoint. The inactive output remains at 0 or 4 mA, respectively.

Error Messages for Controller Settings

The controller is turned off (controller output $Y = 0\%$) and the alarm message "Warn Control Parameter" will be activated if any of the following conditions applies:

All Controller Types:

- $\text{beginning} \geq \text{setpoint} - \text{neutral zone} / 2$
- $\blacktriangleleft \text{corner } X < \text{beginning}$
- $\blacktriangleleft \text{corner } X > \text{setpoint} - \text{neutral zone} / 2$
- $\text{end} \leq \text{setpoint} + \text{neutral zone} / 2$
- $\blacktriangleright \text{corner } X < \text{setpoint} + \text{neutral zone} / 2$
- $\blacktriangleright \text{corner } X > \text{end}$
- $\blacktriangleleft \text{corner } Y > 100\%$
- $\text{neutral zone} < 0$
- $\blacktriangleright \text{corner } Y > +100\%$

Pulse Length Controller Only:

- $\blacktriangleleft \text{period} < \text{min. ON time} * 2$
- $\blacktriangleright \text{period} < \text{min. ON time} * 2$

Pulse Frequency Controller Only:

- $\text{max. pulse frequency} \leq 0 \text{ p/min}$
- $\text{max. pulse frequency} > 120 \text{ p/min}$

With the user defined **feed time alarm** (see Pg. 4–20), you can monitor how long the controller output is at $+100\%$ or -100% , that is how long the valve is fully open.

If this time is exceeded, the feed chemical (acid or base) might be missing or the valve might be defective.

```

adm OK Inputs | 7.01pH
├── OK1 acts on Cal
├── OK2 acts on Maint
├── >> Input OK1 [disabled]
├── >> Inputs OK1,OK2 [normal]
├── << Return [par]

```

Defined as SPC Control Inputs

The floating OK1/OK2 inputs allows remote control of calibration and maintenance functions:

The pH Transmitter 2800X distinguishes between two operating modes:

- **Without Unical®** interface or Unical® control disabled:

OK1: "blocks cal"

A "1" blocks calibration. The calibration menu cannot be accessed.

"Inactive"

no control function, input OK1 has no function.

OK2: A "1" activates the maintenance function. The pH Transmitter 2800X immediately goes to measurement point maintenance.

The OK1 and OK2 inputs can be used with inverted operation. With the setting "inverse" the input states "0" and "1" are interchanged (active at 0 volts).



The pH Transmitter 2800X immediately goes to maintenance mode if there is no voltage at OK2!

- **With Unical®** interface and activated Unical® control:

OK1: "blocks Cal"

A "1" blocks all calibration and rinsing intervals. After the blocking signal has ceased, a calibration or rinsing procedure is performed if it has been requested by the timer.

"starts Cal"

A "1" releases a Unical® calibration cycle.

OK2: A "1" releases a rinsing cycle. The pH Transmitter remains in maintenance position as long as the "1" signal is applied at input OK2. With "0" the maintenance position is exited and the rinsing cycle is continued until program end.

The Alarm Settings

```

adm Alarm 0 [pH] | 7.01pH
├── >> Alarm 0 [pH]
├── Alarm 0 [pH] On Off
├── Failure Limit Lo -02.00 pH
├── Warning Limit Lo -02.00 pH
├── Warning Limit Hi +16.00 pH
├── Failure Limit Hi +16.00 pH
└── ↓

```

The pH Transmitter 2800X allows to evaluate up to 10 different warning and alarm messages. These alarms are numbered from 0 through 9. For each alarm, you can separately set measured variable and lower and upper limits for warning and failure messages. In addition, each alarm can be enabled or disabled. The alarm limits remains stored even if alarm is disabled.

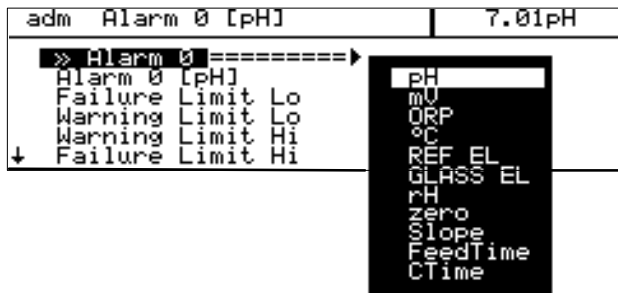

You can define warning and alarm limits for each of the following process variables:

- pH value
- measured mV value
- ORP value
- measured temperature
- reference electrode impedance
- glass electrode impedance
- rH value
- electrode system zero
- electrode system slope
- feed time (controller output: $\pm 100\%$)
(only with controller enabled)
- cal timer

You can define four independent alarm limits for each of these variables (except cal timer and feed time):

- Failure Limit Lo
If the measured value *falls below* this limit, NAMUR contact "Failure" will be activated, the display will read "FAIL".
- Warning Limit Lo
If the measured value *falls below* this limit, NAMUR contact "Warning" will be activated, the display will read "WARN".
- Warning Limit Hi
If the measured value *exceeds* this limit, NAMUR contact "Warning" will be activated, the display will read "WARN".
- Failure Limit Hi
If the measured value *exceeds* this limit, NAMUR contact "Failure" will be activated, the display will read "FAIL".



The activated alarm messages can be read in the Diagnostics menu "Message List" (see page 6-1).

The Cal Timer

adm Alarm 0 [CTime]	7.01pH
> Alarm 0	[CTime]
Alarm 0 [CTime]	On Off
Warning Limit Hi	0048 h
Failure Limit Hi	0072 h
<< Return [par]	

The cal timer allows you to monitor if the electrode system is regularly calibrated.

The cal timer counts the time passed since the last calibration. When the preset time is reached, a message will be activated.

In the menu "Alarm Settings" you can preset one interval each for a warning and a failure message.

The cal timer count can be read out on the additional display (see page 3–2).

SensoCheck® Electrode Monitoring

SensoCheck® electrode monitoring measures the impedances of glass and reference electrodes.

This measurement is taken continuously together with pH measurement.

The electrode impedances are a good indicator for electrode status, contamination (of reference electrode), glass breakage (of glass electrode), ageing and open circuit conditions.

adm Alarm 5 [GLASS EL]	7.01pH
> Alarm 5	[GLASS EL]
Alarm 5 [GLASS EL]	On Off
Failure Limit Lo	0015 MΩ
Warning Limit Lo	0045 MΩ
Warning Limit Hi	0120 MΩ
Failure Limit Hi	0150 MΩ

The absolute electrode impedance values depend strongly on manufacturer and type.

Therefore you must take a new electrode system to determine the setpoints for the electrode system in use.

To do so, you can read out the values for glass and reference electrode impedance on the additional display (see page 3–1) or take them from the data listed in the calibration record (see page 6–1).

During parameter setting of "Alarm Settings" you set the limits for warning and failure messages. If the value for glass or reference electrode impedance exceeds such a preset limit, a warning or failure message, respectively, will be activated.

adm Alarm 6 [REF EL]	7.01pH
> Alarm 6	[REF EL]
Alarm 6 [REF EL]	On Off
Failure Limit Lo	001.0 kΩ
Warning Limit Lo	002.0 kΩ
Warning Limit Hi	010.0 kΩ
Failure Limit Hi	014.0 kΩ



Higher value for glass electrode impedance exceeded: Glass or cable broken or electrode system dry.

Higher value for reference electrode impedance exceeded: Reference electrode contaminated.

Lower value for reference electrode impedance exceeded: Short circuit.

Glass electrode and reference electrode impedance can be read out on the additional display (see page 3–2).

Information on Impedance Measurement

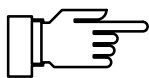

To assure correct monitoring of the glass electrode impedance, you must connect the electrode system using suitable leads with sufficiently low lead capacitance.

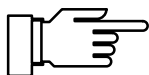

When using a pH isolation amplifier, electrode monitoring is not possible!

The electrode impedances are measured dynamically at a low alternating voltage. The resulting values for the glass electrode are approx. 0.8 times the values of static measurement to IEC 746–2. The electrode lead capacitance has no influence as long as it does not exceed 2 nF (corresponding to approx. 20 m lead length). Since the low-resistance reference electrode impedance can only be detected via the measured electrolyte, the electrolyte conductivity influences the total impedance measured. Here, the resulting impedance values can be considerably higher than with measurement to IEC 746–2.

If you use a reference electrode with very low resistance ($< 100 \Omega$), you can connect a 100Ω resistor in series so that the range for the pH Transmitter 2800X will not be exceeded.

The impedances are continuously evaluated according to a mean value calculated after several measurements. If the alarm window (defined by a minimum and a maximum value) is exceeded, a warning or failure message will be activated. Since the electrode impedances – especially glass membrane impedance – are temperature dependent, they are calculated for a reference temperature of $25 \text{ }^\circ\text{C}$. This allows you to read out and evaluate comparable impedance values even with strongly varying measuring temperatures. It also makes it easier to define appropriate ranges for electrode monitoring.

The NAMUR Contacts

The three NAMUR contacts functional check, warning (maintenance required) and failure are provided as standard.

- *Functional check* is activated:
 - during calibration:
Calimatic[®] (automatic calibration), manual, data entry and ORP check, **not** with sample calibration
 - during maintenance:
current source, measurement point mainte-

nance, manual controller
during parameter setting:
 on Operator level (opl) and Administrator level (adm), and
during a Unical® cycle.

- **Warning** (maintenance required) is activated if a value has exceeded (or fallen below, resp.) a preset "Warning Limit Hi" or "Warning Limit Lo", or if other warning messages have been activated.
 That means that the measuring installation is still functioning properly but should be maintained, or that certain process parameters have reached a value that requires intervention. Warning is *disabled* during "Functional Check".
- **Failure** is activated if a value has exceeded (or fallen below, resp.) a preset "Failure Limit Hi" or "Failure Limit Lo", if the range limits of the pH Transmitter 2800X have been exceeded, or if other failure messages have been activated.
 That means that the measuring installation is *not* properly functioning any more, or that certain process parameters have reached a critical value. Failure is *disabled* during "Functional Check".

adm	NAMUR Contacts	7.01pH
●	3 Contacts: Functional Check.	
!	Warning (Maintenance!), Failure	
	NAMUR Contacts	N/O N/C
	Failure Delay	0000 s
	Warning Delay	0000 s
↓	Func Check Fall delay	0000 s

You can set the three NAMUR contacts as normally open contacts (active: closed) or as normally closed contacts (active: open).

You can define a **delay time** for both the warning and the failure contact. If an alarm message is released, the contact will only be activated after this preset delay time.

Off-delay for functional check prevents momentary drop-out of the contact, e.g. during transition from measurement point maintenance to calibration.



For safe operation, the NAMUR contacts must be set as *normally closed contacts*. Only this ensures that power failure will activate an alarm message!

```

adm Interface/Unical | 7.01pH
┌───────────────────┴───────────────────┐
Mode U24/20mA Unical
>> Baud Rate [1200]
>> Data Bit/Parity [8/No]
Write Protection On Off
<< Return [par]
    
```

The V24 / 20 mA Interface/Unical®

If the pH Transmitter 2800X is equipped with option 419, the interface can be used as V 24/20 mA interface. With option 420 it serves as Unical® interface. If your pH Transmitter is equipped with both options, you can choose how you want to operate the interface.

The V24/20 mA Interface

To operate the pH Transmitter 2800X at a PC, you can use the ZU 0098X CL converter to convert the V24 signal in an RS 232 signal and achieve IS/ non-IS separation.

The serial V24/20 mA interface allows to:

- read out all measured values
- query the instrument status including limit and alarm messages, device diagnostics and log-book
- perform complete parameter setting

For description of the complete command set and the transmission protocol, refer to chapter 9.



If the instrument is in remote status during interface operation, the reading "Remote" appears in the upper right corner of the display in measuring mode.

The keypad is locked for all entries!

You can press **meas** to return to "local" status. (You are prompted for confirmation.) The keypad will be enabled.

The Interface Parameters

```

adm Interface/Unical | 7.01pH
┌───────────────────┴───────────────────┐
Mode U24/20mA Unical
>> Baud Rate [1200]
>> Data Bit/Parity [8/No]
Write Protection On Off
<< Return [par]
    
```

Baud Rate (transmission speed):

The baud rate is specified in bits/second. For the pH Transmitter 2800X you can select baud rates from 110 to 1200 bauds.

Data Bits (data length):

The pH Transmitter 2800X transmits either data lengths of 7 bits or 8 bits. The pH Transmitter only uses characters that can be transmitted as well in 7-bit mode as well as in 8-bit mode. The setting only serves for adaptation to the controlling computer.

Parity (transmission error identification):

The parity is an additional bit that supplements the

data bits in a way that always an even number (parity even) or an odd number (parity odd) of logical "1"s is transmitted. In the case of parity error the error message "Warn V24-Syntax" appears.

You can choose between the baud rates 110, 150, 300, 600 or 1200 bauds, and the transmission formats "7 Bits/Parity Even", "7 Bits/Parity Odd" or "8 Bits/No Parity".

The interface is permanently set to 1 stop bit.

To protect the instrument against unauthorized access also in interface mode, you can set a write protection.

With write protection enabled, parameter or control commands can only be released after the write protection has been disabled via an interface command together with the administrator passcode (see page 9–24). Reading of measured values, parameters and status information is possible even with write protection enabled.

After having sent the last control command, write protection can be reactivated by an interface command or by pressing the **meas** key.



With write protection enabled, all attempts to write without previous disabling of write protection or by using a wrong passcode will be recorded in the logbook.



As supplied, write protection is disabled.

Remote Calibration with Unical® 79 (X)



If you want to use Unical® but your pH Transmitter is not equipped with option 420, this option can be retrofitted. See Release of Options on page 4–34.

Please refer to the supplied Unical® manual for installation, start-up and maintenance of Unical®.

With Unical® 79 (X) the pH electrode system can be automatically calibrated, cleaned with a cleaning medium and its functioning can be checked. The sequences can be configured as desired.

The remote calibration probe is controlled via the Unical® 79 (X) pneumatical controller. Unical® 79 (X) generates all required pneumatical control and feedback signals and supplies rinsing water and buffer solutions for calibrating the electrode system.

Each type of remote calibration probe requires the corresponding version of Unical® 79:

Unical® 79/. for operation in normal environment

Unical® 79/.X for operation in hazardous areas

Unical® 79/2(X) for METTLER TOLEDO InTrac 776/777-SPR remote calibration probe

adm Unical	7.00pH
Unical	On Off
CAL Interval	024.0 h
Rinse Interval	001.0 h
» Unical Program	
« Return [par]	

With Unical® control disabled, all outputs are inactive, i.e. when the probe is connected, it is in "position Cal"!

Interval times last from the beginning of one remote calibration program to the beginning of the next remote calibration program. Different intervals are monitored for calibration and rinsing programs.



A timer-controlled remote calibration program can be turned off by setting the corresponding interval time to "000.0 h".



Before starting the remote calibration program, you must set all program steps!

```

adm Unical Program | 7.00pH
● □ Cal Step          ■ Cal+Maint
| ○ Output disabled  ● enabled
■ 01 oA8 Pos Cal E2 Pos Cal 0006s
■ 02 ●A2 Water E3 Water 0010s
■ 03 oA2 Water ---- 0002s
□ 04 ●A1 Level ---- 0003s
□ 05 ●A5 Pump 1 E5 Buffer 1 0005s
□ 06 oA5 Pump 1 ---- 0005s
□ 07 Cal Buffer 1
□ 08 ●A2 Water E3 Water 0005s
□ 09 oA2 Water ---- 0002s
□ 10 ●A6 Pump 2 E6 Buffer 2 0005s
□ 11 oA6 Pump 2 ---- 0005s
□ 12 oA1 Level ---- 0001s
□ 13 Cal Buffer 2
□ 14 ●A2 Water E3 Water 0005s
□ 15 oA2 Water ---- 0002s
■ 16 Wait Position
■ 17 ●A2 Water E3 Water 0008s
■ 18 oA2 Water ---- 0002s
■ 19 ●A8 PosMeas E1 PosMeas 0006s
■ 20 Program End
<< Return [par]

```

The complete Unical® program is listed in the submenu "Unical Program". The abundant information of each program step can only be represented in an abbreviated manner. The program can be started via the Maint or Cal menu or via the OK inputs. The program starts with program step 01 and then executes all steps until program end or step 50. The program distinguishes between rinsing and calibration program. In the calibration program all program steps are executed, while in the rinsing program only those steps are executed that have been enabled for Cal+Maint (■).

There are two types of program steps:

Timer-controlled program steps are active for a user-defined time. After elapsing of this time the next program step follows immediately.

Example:

```

■ 05 ○A5 Pump 1 E5 Buffer 1 0005s
① ② —————③—————④————— ⑤

```

- ① ■ Step is valid for calibration and rinsing program
 - Step is only valid for calibration program
- ② Program step number
- ③ Control of outputs A1 to A8, the text shows the assignment of the output channel.
 - output is enabled
 - output is disabled
- ④ Query of feedback inputs E1 to E6, the text shows the assignment of the input. Feedback is evaluated at the end of the step time. If there has not been a feedback, a corresponding warning message is activated (see Pg. 8-1).
- ⑤ The step time defines the duration of the program step. If the time has been set to 0000s, feedback is only evaluated after a waiting time required for technical reasons.

Measurement On

Start measurement. When Unical® program is started, the measurement is automatically turned off. If, for example, the current output should follow the measured value during the Unical® cycle, this program command unfreezes the outputs. The NAMUR message "functional check" becomes inactive.

Measurement Off

Turn off measurement. The outputs are frozen or turned off again. NAMUR message "functional check" is active.

Blank Step

To bridge waiting times or test feedback signals without changing the output.

Program steps with function activations provide no time information. They activate device–internal functions such as calibration. Example:

□ 07 Cal Buffer 1

① ② ———③———

- ① ▪ Step is valid for calibration and rinsing program
 - Step is only valid for calibration program

② Program step number

③ Function description, e.g. 1st calibration step of a Calimatic® calibration.

Cal Buffer 1

starts calibration with 1st buffer (no start if there has been an error in the feedback signals, e.g. buffer solution).

Cal Buffer 2

starts calibration with 2nd buffer (no start if there has been an error in the feedback signals, e.g. buffer solution).

ORP Check

starts ORP check (no start if there has been an error in the feedback signals, e.g. buffer solution).

Controller Off

turns controller off (Y = 0 %). During program start the controller output (manipulated variable) is frozen.

Wait Position

The pH Transmitter 2800X remains in this program line if you are in the Maint menu "Meas. Point Maint." or if OK2 input is active.

Every program should contain a wait position!

Program End

Unical program end: This command terminates program execution.

adm	Unical Program	7.00pH
↑	□04 ●A1 Level	---- 0003s
	□05 ●A5 Pump	er 1 0005s
	□06 ○=====	
	□07 Cal Buffe	
	□08 ●A2 Water	r 0005s
↓	□09 ○A2 Water	0002s

The Unical program is made up like a menu. Pressing **enter** allows to edit or erase the program step or insert a new one. Select the desired entry from the roll-up menu and confirm with **enter**.

```

adm Unical Step 05 | 7.00pH
» Function [●A5 Pump 1]
» Execute [Cal]
» Check-Back [E5 Buffer 1]
Step Time 0005 s
» Display Text [Buffer 1]
« Return [par]

```

```

Unical Active | 7.00pH
Rinsing Program
02: Rinsing Water 0006 s
Check-Back: E3 Water ok
40% 0 50 100

```

You will see a menu that contains all parameters of the selected step:

Function indicates control of outputs A1 to A8 or function activations.

Execute determines if the program step is always executed [Cal+Maint] or only during calibration program [Cal].

Check-Back checks reactions of the remote calibration probe via checkback inputs E1 to E6. You can check for active input (e.g. E3 water) or inactive input (e.g. E3 inactive) or turn off the check-back signal [---].

Step time indicates the total duration of the program step. With step time 0000s only the check-back signal is evaluated.

In the roll-up menu *Display Text* you select a text for representing the program sequence on the display.



The program should include the step Wait Position at a suitable place. If a maintenance cycle is started (e.g. via OK2), the pH Transmitter 2800X remains in wait position until the signal "Maintenance" is reset. In this state a calibration can be started via OK1, for example. When the signal "Maintenance" is reset, all steps following the wait position are executed.



On pages 13–1 ff you will find Unical program examples for the most important applications and a form (original for copy) for creating individual Unical programs.



If the pH Transmitter 2800X recognizes a Unical error during a calibration cycle (the queried check-back input E1 to E8 does not supply the desired signal), calibration is not executed. The error message must be reset by manually starting a calibration or rinsing program.



For maintenance work at Unical® 79 or remote calibration probe, you must actuate the maintenance switch (service switch) in the Unical® to lock the Unical® system!

```

adm Set Clock | 7.01pH
-----
>> Date Format =====>
Time          10:11:28
Date          12/06/96
<< Return [par]
    
```

```

adm Set Clock | 7.01pH
-----
>> Date Format          [DD/MM/YY]
Time          10:12:15
Date          12/06/96
<< Return [par]
    
```

Setting the Clock

In the roll-up menu *Date Format* you can select the desired type of representation.

On pressing **enter**, the clock starts running at the entered value. Pressing **par** aborts the entry (undo). The clock keeps the old time.

```

adm Point of Measurement | 7.01pH
-----
● Enter 0...9A...Z-+/-
  using [↑][↓]
Measurement Point  SR0C/137.....
Note
<< Return [par]
    
```

Point of Measurement/Note

In the Point of Measurement menu you can specify the point of measurement according to DIN 19227. In addition, you can enter a note. Each entry can include up to 15 characters. In measuring mode there is a display with the tag number or the note beneath the additional displays. Pressing **enter** switches between the indications.



Via the serial interface you can, for example, enter user information as note that will then be indicated on the display. For parameter setting, you can use the characters 0 to 9, A to Z and -, +, /.

```

adm Device Diagnostics | 7.01pH
-----
Self test      On Off
Interval time  0024 h
<< Return [par]
    
```

Device Diagnostics

The pH Transmitter 2800X can regularly perform an automatic self test (memory test). In the case of memory error the warning message "Warn Device Diagnostics" is released. Automatic self test is only performed when the instrument is in measuring mode and the interval is not set to 0000 h. During testing measurement is continued in the background. All outputs remain active.

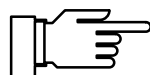

The instrument tests can be executed manually in the diagnostics menu "Device Diagnostics". The respective results are displayed (see Pg. 6-5).



Measurement Recorder

If you want to use the measurement recorder but your pH Transmitter is not equipped with option 448, you can retrofit the option. See Enabling of Options on page 4–34.

”On–Site Recorder“

For optical representation of the process sequence or for controller optimizing, for example, the integrated measurement recorder continuously registers two selectable measured variables and represents them graphically side by side, with parallel time, on the display. Measured variable, measurement range, recording method and feed (pixels per time) are user defined within broad limits. The last 500 measured values are available with time and date, as graphic and as numeric values.

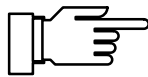

A very effective application is the simultaneous display of reference and glass electrode impedances of the pH electrode system, allowing for the first time graphic detection of a beginning sensor defect.

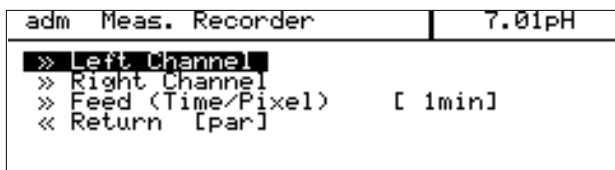

The measurement recorder is adjustable like an ordinary recorder: *Right* and *left channel* are independently definable. *Feed* (time per pixels) applies to both channels.

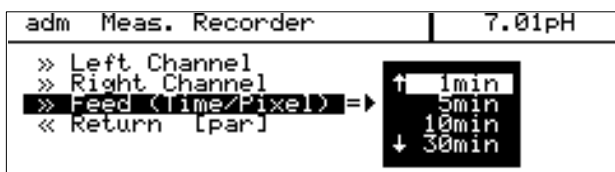

For the feed you can choose between 2 seconds and 10 hours per recorder entry. With the setting 2 seconds, the recorder shows the data of the last 16 minutes, with the setting 10 hours, the data of the last 7 months.

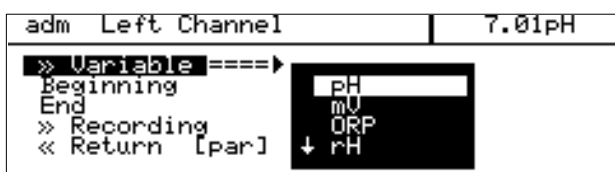

Right and left channel:
Select the controlling measured variable for the channel from the *Variable* roll-up menu. The following variables are available:

- pH value
- measured mV value
- measured ORP (redox) value
- rH value
- measured temperature (°C)
- OUTP1 output current 1
- OUTP2 output current 2
 (only with option 427)
- OUTP3 output current 3
 (only with option 427)

```

adm Left Channel | 7.01pH
-----
> Variable      [pH]
Beginning      +00.00 pH
End            +14.00 pH
> Recording     [Snapshot]
< Return      [par]
    
```

```

adm Left Channel | 7.01pH
-----
> Variable
Beginning
End
> Recording ==> Snapshot
< Return [par]
                Min Value
                Max Value
                Average
    
```

- REF-EL reference electrode impedance
- GLASS-EL glass electrode impedance

Beginning and *End* determines the recording range. The values only have influence on the graphical representation on the display. All measured values are stored with complete number of digits.

In the *Recording* roll up menu you can choose between four methods:

- **Snapshot**
The currently measured value is recorded after expiration of the feed time.
- **Min Value**
Each measured value is checked in the measurement recorder. The lowest value within the feed time is entered in the recorder memory.
- **Max Value**
Each measured value is checked in the measurement recorder. The highest value within the feed time is entered in the recorder memory.
- **Average**
The measurement recorder calculates each measured value in the average value, i.e. the value entered in the recorder memory is the arithmetical average from all measured values within the feed time.
Since the measured pH is a logarithmical entity, it is only partially suitable.

Passcode Entry

Access to the Calibration menu, Maintenance menu, Parameter Setting on Operator level and Administrator level can be protected by passcodes.

You can set or disable each passcode individually. (Administrator passcode cannot be disabled.)



When a passcode is disabled, there is no protection against unauthorized access to the corresponding menu!

For safety reasons, you should not use the standard passcodes!

The factory set passcodes are the same for all instruments. Therefore, you should define your own passcodes.

```

adm Passcode Entry | 7.01pH
---|---
cal Calibration    On Off
maint Maintenance On Off
opl Operator Level On Off
Change passcode 1246
> adm Administrator Level
< Return [par]

```

Only if a passcode is enabled, the line "Change passcode" is displayed. The passcode remains stored even if it has been disabled.

Setting the Administrator Passcode



If you have lost the administrator passcode, system access is locked! The Administrator level cannot be accessed for parameter setting. The locked menu items cannot even be edited on the Operator level.

```

adm Passcode Entry | 7.01pH
---|---
● If you lose your adm passcode,
  system access will be locked!
adm Administrator Level 1989
< Return [par]

```

Contact in this case:

Mettler Toledo GmbH
 Hotline
 Im Hackacker 15
 8902 Urdorf
 Switzerland
 Phone: +41-1-736 2214
 Fax: +41-1-736 2636

```

adm Passcode Entry | 7.01pH
---|---
● If you lose your adm passcode,
  system access will be locked!
Repeat entry: 1989

```

After having entered the administrator passcode you are prompted to repeat the input for reasons of safety.

*If the second entry does not correspond to the first entry or if you abort by pressing **par**, the administrator passcode will not be changed.*

If you set the administrator passcode to "0000", Administrator level can be accessed without passcode entry, by pressing **enter** at the passcode prompt.



If you set the administrator passcode to "0000", menus and instrument settings will not be protected against unauthorized access!

Unauthorized change of parameter settings can lead to instrument malfunction and wrong measured value outputs!

Factory Set Passcodes

The pH Transmitter is shipped with the following passcode settings:

- Calibration Passcode: 1 1 4 7
- Maintenance Passcode: 2 9 5 8
- Operator Passcode: 1 2 4 6
- Administrator Passcode: 1 9 8 9



Release of Options

Software options can be retrofitted at any time even on site, without dismounting the instrument. To do so, you require an instrument-specific unequivocal transaction number (TAN).

To release an option, you require:

- the desired option number,
- the instrument designation (pH Transmitter 2800X)
- and the serial number of your instrument.

You can see these data in the Diagnostics/Device Description (see Pg. 6–4). The price for the option is taken from the currently valid price list.

For a listing of available options, refer to page 10–2.

The transaction number (TAN) can be obtained from your supplier.

Option Release using Transaction Number (TAN):

```
adm Release of Options | 7.01pH
● Release of
i valid tran
» Option ==> 353 Controller
TAN          354 Logbook
             356 Nom. Zero/Slp
             371 Buffer .1
« Return [p]
```

```
adm Release of Options | 7.01pH
● Release of options only with
i valid transaction number (TAN)
» Option [354 Logbook]
TAN      6BD5F0E0
« Return [par]
```

```
adm Release of Options | 7.01pH
● Release of options only with
i valid transaction number (TAN)
» Option [354 Logbook]
Status   Enabled Blocked
« Return [par]
```

1. Select the desired option from the *Option* roll-up menu. Collect option number, instrument designation and serial number and contact the above mentioned address.
2. Enter the transaction number you have received and confirm your entry with **enter**.
3. With correct TAN you can enable or disable the option. This transaction number can be reused at any time for enabling or disabling options of this pH Transmitter 2800X.

5 Calibration

Why do you have to calibrate?

Every **pH electrode system** has its individual **zero point** and its individual **slope**. Both values are altered by ageing and wear. For sufficiently high accuracy of pH measurement, the instrument must be regularly adjusted for the electrode system data (calibration). The pH Transmitter 2800X corrects the voltage delivered by the electrode system according to electrode zero and slope and displays it as pH value.

For calibration, the electrode system is immersed in (one or two) **buffer solutions** whose pH value is exactly known. The pH Transmitter 2800X measures the voltages from the electrode system and the buffer solution temperature and automatically calculates electrode system zero and slope.



Without calibration every pH meter delivers an imprecise or wrong output value! Especially after replacing the electrode system you *must* perform a calibration!

Monitoring Functions for Calibration

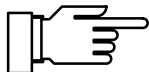

The pH Transmitter 2800X provides comprehensive functions for monitoring correct calibration performance and electrode system state. This allows documentation for quality management to ISO 9000 and **GMP**.

- SensoCheck[®] monitors the electrode system state by measuring **glass and reference electrode impedances**. (See page 4–21)
- Regular calibration can be monitored by a **cal timer**. (See page 4–21.)
- The **calibration record** (GMP) provides all relevant data of the last calibration. (See page 6–1.)
- The **electrode statistics** show the behavior of the electrode system parameters during the last three calibrations compared to the **First Calibration**. (See page 6–2.)

- **Tolerance band calibration** (option 447) prevents that slight calibration scatters of zero and electrode slope as they usually occur in practice lead to a readjustment of the calibration data and thus to an often disliked shifting of the measured value. The data are only readjusted if they are out of user-defined tolerance bands, i.e. only in the case of significant changes (see Pg. 4–7).
- The **tolerance band recorder** (option 447) graphically displays the determined calibration data and the adjusted tolerance bands. Drift due to ageing or calibration scatters can be identified at a glance. This helps to draw conclusions on electrode life and the required calibration interval (see Pg. 6–3).
- The **logbook** provides time and date stamped records of calibrations performed within the last 200 events. (See page 6–4.)
- For zero point, electrode system slope, glass and reference electrode impedance, you can define limits for a **warning** and a **failure message** each. (See page 4–19.) This permits automatic monitoring of electrode system state and ageing using the calibration data.
- In combination with Unical® 79 (X) you can automatically calibrate and clean your electrode system using a remote calibration probe (see Pg. 4–26).

The Calibration Menu



If you calibrate automatically using Unical® 79 (X) remote calibration probe, please refer to the calibration remarks on page 5–13.

```

cal Calibration | 7.01pH
├── Calimatic: Automatic Calibration
├── Manual:
├── Data Entry: Passcode: 1147
├── Sample Cal
├── ORP Check
└── Return to measurement [cal]
    
```

If calibration is protected by a passcode, you must enter the correct passcode to access the Calibration menu.

The calibration passcode can be edited or disabled on the Administrator level (see Pg. 4–32).

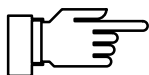

Opening the Calibration menu (by pressing **cal** or and entering the calibration passcode, if required) activates NAMUR contact "functional check". It is deactivated when you exit the menu.

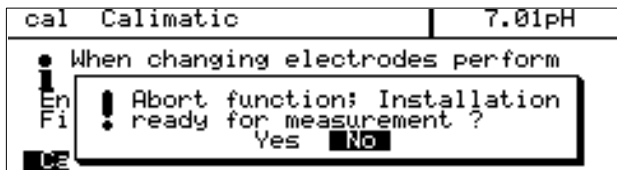

If you press **meas** before calibrating with the first buffer, you are prompted to confirm your decision to abort calibration.

If you abort, the old calibration data will remain valid.

If you press **meas** *after* having calibrated with the first buffer, you are prompted again to confirm your decision to abort calibration.

If you abort, the *new zero point* will be stored, but the *old slope* value remains valid.

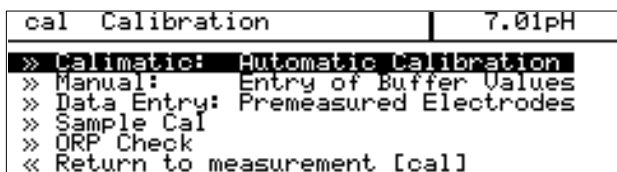

Five different calibration procedures are available:

- automatic buffer recognition by Calimatic®
- manual entry of buffer values
- entry of premeasured electrode system data
- calibration by sampling
- ORP check



When you activate the Calibration menu, the pH Transmitter 2800X automatically suggests the previous calibration sequence.

What does "First Calibration" mean?

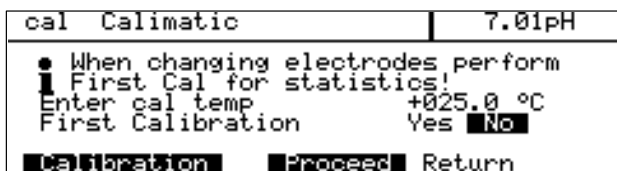

During a "First Calibration", the electrode system data are stored as reference values for **electrode statistics**.

The Diagnostics menu "Electrode Statistics" shows the deviations of zero, slope, and glass and reference electrode impedances of the last three calibrations with respect to the reference values of the First Calibration. This allows to evaluate drift behavior and aging of the electrode system.

When do you have to perform a First Calibration?



Each time you replace the electrode system you must perform a First Calibration! The tolerance band recorder (option 447) is reset with every First Calibration. This prevents that the data of old and new electrode system are confused.

Temperature Compensation during Calibration

Why Temperature Compensation?

There are two important reasons for determining the buffer solution temperature:

- The slope of the pH electrode system is temperature dependent. Therefore the measured voltage must be corrected for the temperature influence (Nernst equation).
- The pH value of the buffer solution is temperature dependent. For calibration, the buffer solution temperature must therefore be known to choose the actual pH value from the buffer chart.



During parameter setting, you define if calibration temperature is automatically measured or must be entered manually (see page 4–4).

Automatic Temperature Compensation

For automatic cal temp detection, the pH Transmitter 2800X detects the buffer solution temperature using a Pt 100/Pt 1000 temperature probe. Optionally you can also use an NTC 30 k Ω (option 456 "Pt 100 /NTC 30 k Ω " or option 476 "NTC 30 k Ω /Pt 1000).



For automatic temperature compensation, there *must* be a temperature probe in the buffer solution. This probe must be connected to the Pt 100/ Pt 1000 input of the pH Transmitter 2800X! Otherwise you must select manual entry of calibration temperature.



When "Cal Temp" has been set to "Auto", "Measured Cal Temp" is read in the menu. When "Cal Temp" has been set to "Manual", "Enter cal temp" is read in the menu.

Single- or Dual-Point Calibration?

For the calibration sequences

- automatic calibration with Calimatic®
- calibration with manual entry of buffer values

you can choose between single-point calibration and dual-point calibration.

Dual-Point Calibration

The electrode system is calibrated with two buffer solutions. This allows to determine zero and slope of the electrode system.



Dual-point calibration is required if

- the pH value strongly fluctuates,
- there is a great difference between measured pH value and electrode system zero,
- pH measurement must be very accurate, or
- the electrode system is subjected to strong wear.

Single-Point Calibration

The electrode system is only calibrated with one buffer solution.

Only the zero point of the electrode system is determined and taken into account by the pH Transmitter 2800X.

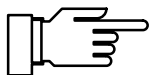

Single-point calibration is suitable and permissible if the measured values lie near the electrode system zero so that slope changes do not have a great effect.

Automatic Calibration with Calimatic®

For automatic calibration with Calimatic®, the electrode system is immersed in one or two buffer solutions.

From the measured electrode system potential and temperature, the pH Transmitter 2800X *automatically* recognizes the nominal buffer value.

The sequence of buffer solutions is irrelevant, however they must belong to the **buffer set** selected during parameter setting (see page 4–6). Temperature dependence of the nominal buffer value is taken into account by Calimatic®.



All calibration data are related to a reference temperature of 25 °C.

During calibration, output currents are frozen at their last values, limit contacts are disabled, controller output can either be frozen or set to zero (see page 4–15).

Calibration of electrode systems with zero point other than pH 7

The Option 356 (integrated as standard in all instruments) allows to define the nominal zero and slope of the electrode (see page 4–8).

Then, also an electrode system with zero point at pH = 4.6, for example, can be automatically calibrated using Calimatic®.



Calibration is valid if zero point deviates by $< \pm 1$ pH unit and slope by $< \pm 5.5$ mV/pH from the nominal value.

What you have to know for calibration



Use only new, undiluted buffer solutions! The buffer solutions must belong to the selected buffer set (see page 4–6)!



For measurement of reference electrode impedance (jumper removed from terminals 2 and 3), the buffer solution must be electrically connected to terminal 3 during calibration (see page 2–5).

To do so, immerse an auxiliary electrode in the buffer solution and connect the auxiliary electrode to terminal 3.

The Calibration Sequence

```

cal Calimatic | 7.01pH
● Immerse electrodes in 1st buffer!
┃ Output current frozen,

Buffer Set [Mettler Toledo]
Calibration Start Return
  
```

Remove the electrode system and immerse it in the first buffer solution. Start calibration.

```

cal Calimatic | 7.01pH
● Calibration with 1st buffer running
┃ Zero Correction
  Electrode Potential -0000 mV
● Calibration Temp +025.0 °C
○ Nominal Buffer Value +07.00 pH
  Response Time 0016 s
  
```

When the pH Transmitter 2800X has recognized the buffer solution, the nominal buffer value is displayed.

From the **response time** you see how much time the electrode system needs until the measured voltage has stabilized.



To reduce waiting time until stabilization of measured voltage, you can press **cal**. However this *reduces accuracy of the calibration values!*



If electrode system potential or measured temperature strongly fluctuate, calibration is stopped after 2 min.

```

cal Calimatic | 7.00pH
● Immerse electrodes in 2nd buffer!
┃ For single-point calibration (zero)
  select: 'Calibration Abort'

Calibration Start Abort
  
```

Rinse electrode system thoroughly. For *dual-point calibration* immerse the electrode system in the second buffer solution and start the second calibration step. Calibration is performed with the second buffer.

For *single-point calibration*, install the electrode system and select "Calibration Abort" to exit the menu.

```

cal Calimatic | 7.00pH
Zero +06.99 pH
● Slope 058.0 mV/pH
┃ Impedance Glass 0090 MΩ
  Impedance Ref 006.9 kΩ

Calibration End Repeat
  
```

After a successful calibration, the electrode data are displayed.

If an error has occurred, an error message is displayed. Calibration must be repeated.

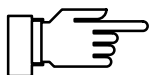

If your pH Transmitter is equipped with option 447, each calibration is stored in the tolerance band recorder (see page 4–7).

```

cal Calimatic | 7.00pH
Zero +06.99 pH
● Slope 058.0 mV/pH
┃ Impedance Glass 0090 MΩ
  Impedance Ref 006.9 kΩ
  Cal Tolerance Band: Old el data

Calibration End Repeat
  
```

With option 447 and cal tolerance band enabled, calibration data are *not* taken over *from every calibration*. The line "Cal Tolerance Band" informs you if the tolerance limit has been exceeded and the calibration data have been taken over ("New el data") or if calibration data have not been taken over because they are within the tolerance band ("Old el data").

Calibration with Manual Entry of Buffer Values

For calibration with manual entry of buffer values, the electrode system is immersed in one or two buffer solutions.

The pH Transmitter 2800X displays the measured temperature.

Then you have to enter the *temperature corrected buffer values*. To do so, look at the buffer chart (e.g. on the bottle) and enter the buffer value belonging to the displayed temperature. For intermediate temperature values, you must interpolate.

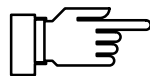

All calibration data are related to a reference temperature of 25 °C.

During calibration, output currents are frozen at their last values, limit contacts are disabled, controller output can either be frozen or set to zero (see page 4–15).

What you have to know for calibration

Use only new, undiluted buffer solutions!



For measurement of reference electrode impedance (jumper removed from terminals 2 and 3), the buffer solution must be electrically connected to terminal 3 during calibration.

To do so, immerse an auxiliary electrode in the buffer solution and connect the auxiliary electrode to terminal 3.

The Calibration Sequence

```
cal Manual Entry | 7.00pH
● When changing electrodes perform
| First Cal for statistics!
Enter cal temp      +025.0 °C
First Calibration   Yes No
First Buffer Solution +07.00 pH
Calibration Proceed Return
```

Remove the electrode system and immerse it in the first buffer solution.

The measured cal temperature is displayed or must be entered manually.

Enter the temperature–corrected first buffer value.



You must enter the temperature–corrected buffer value. To do so, look at the buffer chart and enter the buffer value belonging to the displayed calibration temperature.

```
cal Manual Entry | 7.00pH
● Immerse electrodes in 1st buffer!
| Output current frozen,
Calibration Start Return
```

Start calibration.

```

cal Manual Entry | 7.00pH
● Calibration with 1st buffer running
| Zero Correction
  Electrode Potential -0000 mV
o Calibration Temp +025.0 °C
● Nominal Buffer Value +07.00 pH
  Response Time 0004 s

```

From the **response time** you see how much time the electrode system needs until the measured voltage has stabilized.



To reduce waiting time until stabilization of measured voltage, you can press **cal**. However this *reduces accuracy of the calibration values!*



If electrode system potential or measured temperature strongly fluctuate, calibration is stopped after 2 min.

```

cal Manual Entry | 7.00pH
● Immerse electrodes in 2nd buffer!
| For single-point calibration (zero)
  select: 'Calibration Abort'
Second Buffer Solution +09.00 pH
Calibration Start Abort

```

Rinse electrode system thoroughly. For *dual-point calibration* immerse the electrode system in the second buffer solution.

Enter the temperature-corrected second buffer value and start calibration.

For *single-point calibration*, you can select "Calibration Abort" to exit the menu.

```

cal Manual Entry | 7.00pH
Zero +06.99 pH
● Slope 058.0 mV/pH
| Impedance Glass 0090 MΩ
  Impedance Ref 006.9 kΩ
Calibration End Repeat

```

After a successful calibration, the electrode data are displayed.

If an error has occurred, an error message is displayed. Calibration must be repeated.

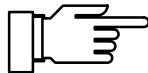

If your pH Transmitter is equipped with option 447, each calibration is stored in the tolerance band recorder (see page 4-7).

```

cal Manual Entry | 7.00pH
Zero +06.99 pH
● Slope 058.0 mV/pH
| Impedance Glass 0090 MΩ
  Impedance Ref 006.9 kΩ
  Cal Tolerance Band: Old el data
Calibration End Repeat

```

With option 447 and cal tolerance band enabled, calibration data are *not* taken over *from every calibration*. The line "Cal Tolerance Band" informs you if the tolerance limit has been exceeded and the calibration data have been taken over ("New el data") or if calibration data have not been taken over because they are within the tolerance band ("Old el data").

Calibration by Entry of Premeasured Electrode Data

You can directly enter the values for zero, slope and isothermal intersection potential of an electrode system. The values must be known, that is, they must have been determined in the laboratory, for example.



When you enter an isothermal intersection potential V_{iso} , this value remains stored for the calibration sequences during Calimatic[®], Manual Entry, and Sample Calibration.



See page 15–2 for an explanation of the isothermal intersection potential.

cal Data Entry		7.00pH
●	Output current frozen,	
I	controller: Y=0%	
First Calibration		Yes No
Zero	+06.99	pH
Slope	058.0	mV/pH
Isotherm Potential	+0000	mV
« Return [cal]		

Enter the premeasured values in the menu "Data Entry".

If your pH Transmitter is equipped with option 447, the calibration data are stored in the tolerance band recorder. The values of Data Entry are *always* taken over, even if they lie *within* the cal tolerance band!

Calibration by Sampling

If the electrode system cannot be removed for reasons of sterility (e.g. in biotechnical processes) electrode system zero can be calibrated by "sampling".

To do so, the pH Transmitter 2800X stores the currently measured process value.

Immediately afterwards you take a sample from the process. The pH value of the sample is measured in the laboratory.

The laboratory value is entered into the pH Transmitter 2800X which calculates the electrode system zero from the difference between measured value and laboratory value (this method only allows single-point calibration).

The Calibration Sequence

For sampling, open the Cal menu "Sample Calibration". The measured sample temperature and the currently measured pH of the medium are displayed and stored.

To exit calibration, press **cal**.

cal Sample Cal		7.00pH
●	Sample Temp	+025.0 °C
I	Stored Sample	+07.00 pH
« Return [cal]		

7.00		Sample
pH		MAN. TEMP
TIME	9:25	OUTP1 10.00mA

MAN. TEMP	Sample		meas
+	7.00pH	OUTP1	10.00mA
2800X: SROC/137			9:28

Take sample

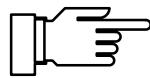

cal	Sample Cal	7.00pH
●	Sample Temp	+025.0 °C
■	Stored Sample	+07.00 pH
	Lab Value	+07.00 pH
	« Return [cal]	

In measuring mode the word "Sample" indicates that a sample value has been stored for calibration. The pH Transmitter expects entry of the laboratory value. Until that, it uses the old zero value for measurement.

(If the pH Transmitter is in remote status during interface operation, "Sample" can be covered by "Remote".)

Take a sample from the process and measure the pH value of the sample, e.g. in the laboratory.

Please note that the pH value of the sample is temperature dependent. Therefore, laboratory measurement should be performed at the sample temperature read on the display.

You should transport the sample in an insulated container (Dewar) to maintain its temperature. The pH value of the sample can also be altered through escape of volatile substances.

After having determined the pH value of the sample, open the Cal menu "Sample Calibration" again.

The measured sample temperature and the stored pH value are displayed.

Enter the measured pH value of the sample ("Lab Value"). New electrode system zero is automatically calculated and stored.

If your pH Transmitter is equipped with option 447, the calibration data are stored in the tolerance band recorder. The values of Data Entry are always taken over, even if they lie *within* the cal tolerance band!

ORP Check

For ORP measurements, electrode standardization is not suitable. As a check on the electrode system the running-in behavior is analyzed under defined conditions. To do so, enter the parameters **test difference** and **test period** (see page 4–8).

cal	ORP Check	7.00pH
●	Immerse electrodes in redox buffer	
■	Output current frozen, controller: V=0%	
	Redox Buffer rH 28.4 Mettler Toledo	
	Check	Start Return

The pH Transmitter 2800X permits checking of electrode systems with a "3mol/l KCl-Ag/AgCl" reference electrode.

Reference solution is rH 28.4 redox buffer solution (by Mettler Toledo, Ref. No. 20 9881 250). The temperature compensation chart for this buffer solution is stored in the pH Transmitter 2800X.

To check the electrode system, immerse it in a conditioning solution whose make up depends on the application.

cal ORP Check		7.00pH
•	Check with redox buffer running	
	Testing Period	0010 s
o	Buffer Value	+0220 mV
•	Electrode Potential	-0000 mV
	Response Time	0008 s

cal ORP Check		F 7.00pH
!	Fail Sensor Failure	
Check	End	Repeat

After that, immerse the electrode system (after rinsing if required) in the redox buffer solution and start the checking procedure. The voltage difference between electrode potential and setpoint of the buffer solution is evaluated and displayed.

If this differential voltage falls below the **testing difference** within the preset **testing period**, the electrode system is considered stable, checking is terminated.

If the electrode system only reaches testing difference after the **testing period has expired**, the message "Warn Probe Unstable" is displayed.

If the value does not fall below the testing difference after the **testing period has expired twice**, the message "Fail Probe Failure" is displayed.

When taking ORP measurements an indication must be made as to which electrode was used as reference and whether the result has been converted to the standard hydrogen electrode. **Direct conversion to the standard hydrogen electrode can be made using the delta function.** (see Pg. 4–11). Specification of ORP is completed by indicating the measuring electrode in use (e.g. "platinum"), measuring temperature, and pH value.

Standard potentials [mV] of some reference electrodes

(Voltages [mV] related to standard hydrogen electrode)

Data: Galster; pH-Messung, Weinheim. VCH, 1990 (partially interpolated/extrapolated)

Temp °C	"Silver chloride", "Argenthal", "Silamid" Ag/AgCl, KCl				"Calomel" Hg/Hg ₂ Cl ₂ , KCl			"Thalamid" Tl,Hg/TlCl,KCl	"Mercury sulphate" Hg/Hg ₂ SO ₄ , K ₂ SO ₄
	1mole/l	3 mole/l	3.5 mol/l	saturated	0.1 mole/l	1 mole/l	saturated	3.5 mole/l	saturated
0	249.3	224.2	222.1	220.5	333.8	285.4	260.2	-558.5	671.8
5	246.9	220.9	218.7	216.1	334.1	284.7	257.2	-561.0	667.6
10	244.4	217.4	215.2	211.5	334.3	283.9	254.1	-563.5	663.5
15	241.8	214.0	211.5	206.8	334.2	282.7	250.9	-566.0	659.4
20	239.6	210.5	207.6	201.9	334.0	281.5	247.7	-568.6	655.3
25	236.3	207.0	203.7	197.0	333.7	280.1	244.4	-571.3	651.3
30	233.4	203.4	199.6	191.9	333.2	278.6	241.1	-574.0	647.3
35	230.4	199.8	195.4	186.7	332.4	277.0	237.7	-576.7	643.3
40	227.3	196.1	191.2	181.4	331.6	275.3	234.3	-579.6	639.2
45	224.1	192.3	186.8	176.1	330.6	273.5	230.8	-582.5	635.1
50	220.8	188.4	182.4	170.7	329.6	271.6	227.2	-585.4	630.9
55	217.4	184.4	178.0	165.3		269.5	223.6	-588.5	626.6
60	213.9	180.3	173.5	159.8		267.3	219.9	-591.6	622.6
65	210.4	176.4	169.0	154.3		264.8	216.2	-594.8	617.7
70	206.9	172.1	164.5	148.8		262.2	212.4	-598.0	613.3
75	203.4	167.7	160.0	143.3				-601.4	608.4
80	199.9	163.1	155.6	137.8				-604.8	603.4
85	196.3	158.3	151.1	132.3				-608.3	598.4
90	192.7	153.3	146.8	126.9				-611.9	593.1
95	189.1	148.1	142.5	121.5				-615.6	578.6

pH Calibration with Unical®

```

cal Calibration | 7.00pH
» Unical
« Return to
    Passcode: 1147
  
```

If calibration is passcode protected, you must enter the correct calibration passcode to access the Calibration menu.

```

cal Calibration | 7.00pH
» Unical
« Return to measurement [cal]
  
```

With Unical® control enabled you can start the calibration program for Unical® remote calibration probe in the Calibration menu.

```

cal Unical | 7.00pH
● Automatic run of
  Unical calibration program
First Calibration Yes No
Unical Start Return
  
```

With a new electrode system you must perform a First Calibration to store the calibration values as reference for electrode statistics. To do so, select "First Calibration Yes".

When you start Unical®, the Calibration menu is exited and Unical® calibration program is started.

```

Unical Active | 7.00pH
Calibration Program
01: Probe Cal 0002 s
Check-Back: E2 Pos Cal ok
67% 0 50 100
  
```

The calibration program executes all steps of the Unical® program. The type of calibration (single or dual point) is defined in your Unical® program (see page 4–27).



Please note that **no** calibration step is activated if a Unical® error has occurred (query of checkback messages).

```

cal Calimatic | 7.00pH
● Calibration with 1st buffer running
  Zero Correction
  Electrode Potential +0000 mV
  Calibration Temp +050.0 °C
  Nominal Buffer Value +07.00 pH
  Response Time +0016 s
  
```

During calibration the pH Transmitter 2800X indicates the calibration procedure in the display. If calibration errors occur, the corresponding error message will be displayed.

```

Unical Active | 7.00pH
Calibration Program
19: Probe Measurement 0003 s
Check-Back: E1 PosMeas ok
50% 0 50 100
  
```

After the last program step the pH Transmitter automatically returns to measuring mode (depending on Unical® program).

Blank page.

6 The Diagnostics Menu

diag Diagnostics	7.00pH
» Message List	2 Messg.
» El Protocols	
» Logbook	
» Device Description	
» Device Diagnostics	
» Meas. Recorder (List)	
<< Return to measurement [diag]	



The Diagnostics menu provides all relevant information on instrument status.

During diagnostics all measurement functions of the pH Transmitter 2800X remain active. All outputs are operated. Messages (warning and failure) are output via the NAMUR contacts.

If no key is pressed within **20 minutes**, the Diagnostics menu is exited automatically.

The Message List

diag Message List	7.00pH
Warn Lo Glass El	
Fail Lo Glass El	
<< Return [diag]	

The message list displays the currently active warning and failure messages in plain text.

For description of messages, refer to chapter 8.

The Electrode Records

The Calibration Record

diag Cal Record	7.00pH
Last Calibration	01/06/96 09:31
Cal Tolerance Band:	New el data
Cal Mode	Manual Entry
Zero	+06.99 pH
Slope	+058.0 mV/pH
Isotherm Potential	+0000 mV
1st Buffer Value	+07.00 pH
Electr Potential	-0000 mV
Cal Temp	+025.0 °C
Response Time	+0009 s
2nd Buffer Value	+09.00 pH
Electr Potential	-0000 mV
Cal Temp	+025.0 °C
Response Time	+0009 s
<< Return [diag] [↑][↓] Scrolling	

The calibration record contains all relevant data of the last calibration required for documentation according to ISO 9000 and GMP.

- date and time of last calibration
- cal tolerance band: new data/old data (if tolerance band calibration enabled)
- calibration mode (e.g. Calimatic®)
- zero point of electrode system
- slope of electrode system
- isothermal intersection voltage V_{iso}

For 1st and 2nd buffer:

- nominal buffer value
- (measured) electrode potential
- calibration temperature
- response time of electrode system until measured voltage has stabilized



For some calibration procedures, such as Data Entry, not all data are available. The respective positions are then covered by a grey bar.

diag Statistics		7.02pH	
Zero			
1st Cal	+06.99 pH	01/06/96	09:46
Diff	-00.00 pH	03/06/96	09:48
Diff	+00.02 pH	05/06/96	09:49
Diff	+00.02 pH	07/06/96	09:51
Slope			
1st Cal	+058.0 mV/pH	01/06/96	09:46
Diff	+000.0 mV/pH	07/06/96	09:51
Impedance Glass El			
1st Cal	+0000 M Ω	01/06/96	09:46
Diff	+0000 M Ω	03/06/96	09:48
Diff	-0000 M Ω	05/06/96	09:49
Diff	+0000 M Ω	07/06/96	09:51
Impedance Ref El			
1st Cal	+106.9 k Ω	01/06/96	09:46
Diff	+000.0 k Ω	03/06/96	09:48
Diff	-000.2 k Ω	05/06/96	09:49
Diff	+000.0 k Ω	07/06/96	09:51
El Response Time			
1st Cal	+0019 s	01/06/96	09:46
	+0009 s	03/06/96	09:48
	+0009 s	05/06/96	09:49
	+0010 s	07/06/96	09:51
« Return [diag] [↑][↓] scrolling			

Statistics

When you perform a **First Calibration** (see page 5–3), the following values are stored as **reference values**:

- date and time of First Calibration
- zero point of electrode system
- slope of electrode system
- glass electrode impedance
- reference electrode impedance
- electrode system response time of First Calibration

When you then perform ordinary calibrations, the following data will be listed in the electrode statistics for the *last three calibrations*:

- date and time of calibration
- *deviation* of zero point from First Calibration to calibration
- *deviation* of electrode system slope
- *deviation* of glass electrode impedance
- *deviation* of reference electrode impedance
- electrode system response time during calibration



This provides you with important information on electrode system state, ageing and the time for the next due calibration.

If the time between two calibrations is less than 6 minutes, the pH Transmitter interprets the second calibration as repetition of the first one (e.g. when an error has occurred). It does not store a new record. The last calibration record is overwritten.

The Tolerance Band Recorder (Graphic)

This option (tolerance band recorder) can be retrofitted via TAN (see page 4–34).

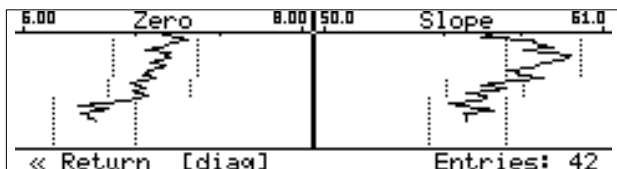

From the graphical representation of the electrode data, drift due to ageing or calibration scatters of the last 45 calibrations can be recognized at a glance. This allows to draw conclusions on electrode life and the required calibration interval.

The dotted lines indicate the user-defined tolerance band range. If zero and/or slope of the electrode system leave their tolerance bands, the data are taken over as calibration data (new el. data) and the tolerance band limits are displaced (symmetrically to the new electrode data).

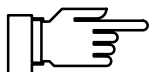

Entries in the tolerance band recorder *cannot be edited!*

If your pH Transmitter is equipped with option 419 (remote interface), the contents of the tolerance band recorder can be read out and evaluated automatically.

The Tolerance Band Recorder (Listing)

This option (tolerance band recorder) can be retrofitted via TAN (see page 4–34).



```
diag T Band Recorder | 7.02pH
Display: DATE TIME ZERO SLOPE STATUS
● STATUS: ■/□: new/old EL Data
i C1/C2: Calimatic 1/2 Pt.
M1/M2: Cal Manual 1/2 Pt.
D: Data Entry S: Cal Sample
<< Return [diag] >> Proceed [enter]
```

```
diag T Band Recorder | 7.02pH
07/06/96 09:51 +07.01pH +058.0mV ■ M1
05/06/96 09:49 +07.01pH +058.0mV □ M1
03/06/96 09:48 +06.99pH +058.0mV □ M1
01/06/96 09:46 +06.99pH +058.0mV ■ C1
<< Return [diag]
```

As supplement to the graphical representation the listing of the tolerance band recorder shows the exact data of the last 45 calibrations. The listing includes:

- time and date of calibrations
- determined zero and slope values
- electrode data taken over (■) or tolerated (□)
- calibration mode:
 C1/C2 = Calimatic® 1–/2–point calibration
 M1/M2 = manual 1–/2–point calibration
 D = data entry
 S = sampling



diag Logbook		7.02pH
↑	01/06/96 09:39	Diagnostics Active
	01/06/96 09:39	Measurement Active
	01/06/96 09:39	□ Fail Lo Glass El
	01/06/96 09:39	□ Warn Lo Glass El
↓	01/06/96 09:38	adm Setting
« Return [diag] [↑][↓] Scrolling		

The Logbook

This option (logbook) can be retrofitted via TAN (see page 4–34).

The logbook contains the last 200 events with date and time and displays them:

- instrument in measuring mode
- instrument turned on/off
- ■: start of warning and failure messages
- □: end of warning and failure messages
- calibration messages
- parameter setting, calibration, maintenance or diagnostics activated

The logbook entries can be used for quality management documentation to ISO 9000 and GMP.

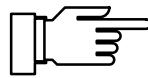

Logbook entries *cannot be edited!*

If the pH Transmitter is equipped with option 419 (remote interface), the logbook contents can be read out and automatically documented (refer to page 9–8).

The Device Description

diag Device Description		7.02pH
Model	2800X	
Serial No.	0000000	
Version	Hardw: 1	Softw: 2.0
PRG Module	SP08Z20000/0	
↓ Options	353;354;356;419;420;427	
« Return [diag] [↑][↓] Scrolling		

The device description provides information on instrument type, serial number and options.

You read:

- model designation,
- serial number,
- hardware and software version,
- instrument options,
- program module code,

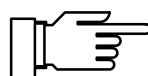

The software version must correspond to the version indicated at the bottom right of the second page of this manual.

The options for *power supply* are *not* displayed. They are indicated on the nameplate (on the terminal compartment cover).

The Device Diagnostics

The device diagnostics allows you to perform comprehensive tests to check the function of the pH Transmitter 2800X.

This permits quality management documentation to ISO 9000.

Instrument settings and parameters are not affected.

In the Device Diagnostics menu you see when each test was performed and what the result was.

Pressing **enter** starts the selected test.

diag	Device Diagnostics	7.02pH
RAM Test	13/02/96 08:14	ok
EPROM Test	13/02/96 08:15	ok
EEPROM Test	13/02/96 08:14	ok
Display Test	13/02/96 08:14	executed
Keypad Test	13/02/96 08:14	ok
<< Return [diag]		

Memory Test

Select "RAM Test", "EPROM Test" or "EEPROM Test".

The pH Transmitter calculates the CRC check sum from the available data and compares them with the setpoint.

diag	RAM Test
i Non-Destructive RAM Test	
25%	0 50 100

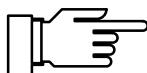

If "Failure" is read in the menu after testing has been terminated, the pH Transmitter must be returned to the manufacturer for repair.

Display Test

Several test patterns will be displayed allowing you to check if all pixels, lines and columns function perfectly.

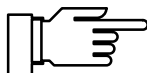

If there are disturbances in the test patterns, you should return the instrument to the manufacturer for repair.

Keypad Test

You must press each key *once*. Keys that have been pressed are highlighted.

diag	Keypad Test
i Press each key once	
i Abort: [diag] [diag]	
[mes]	[cal] [maint] [par] [diag] [enter]



If "Keypad Test Failure" is read on the display after you have pressed all keys, you must return the pH Transmitter to the manufacturer for repair.

Measurement Recorder (Listing)



This option (measurement recorder) can be retrofitted via TAN (see Pg. 4-34).

diag Meas. Recorder				7.02pH
↑	07/06/96	10:08	+07.02pH	-099.9°C
	07/06/96	10:07	+07.02pH	-099.9°C
	07/06/96	10:06	+07.02pH	-099.9°C
	07/06/96	10:05	+07.02pH	-099.9°C
↓	07/06/96	10:04	+07.02pH	-099.9°C
« Return [diag] [↑][↓] Scrolling				

In addition to the graphical representation of the measurement recorder (see page 3-2) the Diagnostics menu provides the last 500 measured value pairs from the recorder memory as listing. Each recorder entry occupies one display line. The measured values from both channels are recorded with date and time. If required, the symbols for min (▼), max (▲) or average value (~) are indicated after the unit symbol.



The entries from the measurement recorder *cannot be edited!*

If the pH Transmitter is equipped with option 419 (remote interface), the recorder contents can be read out and automatically documented (refer to page 9-8).

- *Unical Calimatic*
starts the calibration program (from program step 01 until wait position), before that you are asked if you want to perform a First Calibration. If a calibration passcode has been set, it must be entered to perform calibration.
- *Message List*
This menu item displays the message list (without enabling the outputs) that provides all active messages (see page 6–1).

The Current Source Function



During current source function, the output currents do *not* follow the measured value! The values can be entered manually. NAMUR contact "Functional Check" is active.

Therefore, you must be sure that the connected peripherals (control room, controller, indicator) will not interpret the current value as measured value!

```

maint Current Source | 7.02pH
● Output current definable 0...20.5mA
| Confirm with [enter]
Output Current 1    10.02 mA
Current Output 2    10.02 mA Load!!!
Current Output 3    00.00 mA
<< Return [maint]
    
```

During current source function you can manually set the values for the output currents, e.g. to check the connected peripheral devices.



If current load is exceeded or the circuit is interrupted, the message Load!!! is displayed.

Temperature Probe Adjustment



During temperature probe adjustment you compensate for the individual temperature probe tolerance and the influence of the lead resistances to increase accuracy of temperature measurement.

This adjustment may only be performed after process temperature has been precisely measured using a calibrated reference thermometer! The reference thermometer must have an accuracy better than 0.1 °C.

Adjustment without precise measurement might result in strong deviations of the displayed pH value!

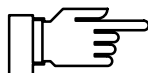

To make adjustment easier, set "Measurement Display: Meas Variable °C" (see page 4–3).

```

maint Adjust Temp Probe | 27.0 °C
● Probe Tolerance and Lead Adjustment
| Enter measured process temp
Installation Adjustment On Off
<< Return [maint]
    
```

If measurement display has been set correspondingly, the *temperature measured by the temperature probe* is now read in the upper right corner of the display.

```

maint Adjust Temp Probe | 26.9 °C
● Probe Tolerance and Lead Adjustment
i Enter measured process temp
Installation Adjustment On Off
Process Temp: +027.0 °C
<< Return [maint]

```

Enable installation adjustment and enter the process temperature measured by the reference thermometer.

Now the *adjusted temperature measured by the temperature probe* will be read in the upper right corner of the display.



Permissible adjustment range is ± 5 °C from the value measured by the temperature probe.

Manual Entry of Controller Output

If your pH Transmitter is equipped with a controller function (option 353) and the controller has been enabled during parameter setting, you can manually adjust the controller output (manipulated variable Y) for test purposes or for starting a process.



If you manually adjust the controller output, *automatic control* of the controlled variable *stops!*

Therefore, you must be sure that the connected actuators and the control loop will be monitored correspondingly!

```

maint Manual Controller | 7.02pH
● Output 3: -100...0 %
i Output 2: 0...+100 %
Controller Output -010.0 %
<< Return [maint]

```

You can enter the controller output in the range -100 % to +100 % e.g. to check connected actuators.

When you exit manual controller input, the pH Transmitter switches back to automatic controller operation.

For the PI controller (reset time $\neq 0$) switch-over is bump-free. This allows to rapidly start processes with large time constants or dead times.



For analog controller types the message Load!!! is displayed if controller load is exceeded or the circuit interrupted.

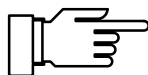

The user-defined **feed time alarm** allows to monitor the time during which the controller output is at +100 % or -100 %, i.e. the valve is fully open. If this time has been exceeded, this might be in an indication for missing titrans or a defective valve.

Blank page.

8 Error Messages



These error messages are valid for all instruments of the pH Transmitter 2800X Series. Therefore, this listing also includes messages that cannot appear in your pH Transmitter.

Error Message (Display in Diagnostics Menu "Message List")	Possible Error Causes and Remedies	Error Code
Fail Control Load	Analog controller: load too high or circuit interrupted	127
Fail CRC Error par	CRC data error during parameter setting: Check complete settings on the Administrator level!	110
Fail Current1 Load	Current output 1: load too high or circuit interrupted	100
Fail Current2 Load	Current output 1: load too high or circuit interrupted	104
Fail Current3 Load	Current output 1: load too high or circuit interrupted	126
Fail Hi Cal Time	Cal timer above failure limit	088
Fail Hi Cal Time A	Cal timer channel A above failure limit	232
Fail Hi Cal Time B	Cal timer channel B above failure limit	236
Fail Hi Cell Const	Cell constant > 200.0 cm ⁻¹ or above failure limit	058
Fail Hi Conductance	Measured value > 300 mS or above failure limit	072
Fail Hi Cond Value	Measured value > 2000 mS/cm or above failure limit	050
Fail Hi El Slope	Slope of electrode system > 61 mV/pH (Option 356: > 61 mV/pH or > (nominal slope + 5.5 mV/pH)) or above failure limit	021
Fail Hi El Slope A	Slope of electrode system channel A > 61 mV/pH (Option 356: > 61 mV/pH or > (nominal slope + 5.5 mV/pH)) or above failure limit	214
Fail Hi El Slope B	Slope of electrode system channel B > 61 mV/pH (Option 356: > 61 mV/pH or > (nominal slope + 5.5 mV/pH)) or above failure limit	218
Fail Hi El Zero	Electrode zero > pH 8 (Option 356: > (nominal zero point + 1 pH unit)) or above failure limit	017
Fail Hi El Zero A	Electrode zero channel A > pH 8 (Option 356: > (nominal zero point + 1 pH unit)) or above failure limit	206
Fail Hi El Zero B	Electrode zero channel B > pH 8 (Option 356: > (nominal zero point + 1 pH unit)) or above failure limit	210
Fail Hi Feed Time	Controller: Feed time above failure limit	111
Fail Hi Glass El	Glass electrode impedance above failure limit	029
Fail Hi Glass El A	Glass electrode impedance channel A above failure limit	198
Fail Hi Glass El B	Glass electrode impedance channel B above failure limit	202
Fail Hi mV Value	Measured value > +2000 mV or above failure limit	005
Fail Hi mV Value A	Measured value channel A > +2000 mV or above failure limit	164
Fail Hi mV Value B	Measured value channel B > +2000 mV or above failure limit	168
Fail Hi ORP	Measured value > +2000 mV or above failure limit	013

Error Message (Display in Diagnostics Menu "Message List")	Possible Error Causes and Remedies	Error Code
Fail Hi ORP A	Measured value channel A > +2000 mV or above failure limit	172
Fail Hi ORP B	Measured value channel B > +2000 mV or above failure limit	176
Fail Hi pH Diff A–B	pH difference channel A–B above failure limit	158
Fail Hi pH Diff A–M	pH difference channel A–M above failure limit	160
Fail Hi pH Diff B–M	pH difference channel B–M above failure limit	162
Fail Hi pH Value	Measured value > pH 16 or above failure limit	001
Fail Hi pH Value A	Measured value channel A > pH 16 or above failure limit	150
Fail Hi pH Value B	Measured value channel B > pH 16 or above failure limit	154
Fail Hi Ref EI	Reference electrode impedance above failure limit	033
Fail Hi Ref EI A	Reference electrode impedance channel A above failure limit	190
Fail Hi Ref EI B	Reference electrode impedance channel B above failure limit	194
Fail Hi rH Value	Measured value > 200 rH or above failure limit	009
Fail Hi Slope Diff M–A	Slope difference channel M–A above failure limit	222
Fail Hi Temp Diff A–B	Temperature difference channel A–B above failure limit	188
Fail Hi Temperature	Measured value > 250 °C or above failure limit	080
Fail Hi Temperature A	Measured value channel A > 250 °C or above failure limit	180
Fail Hi Temperature B	Measured value channel B > 250 °C or above failure limit	184
Fail InCheck	pH input overdrive	139
Fail Lo Cell Const	Cell constant < 0.01 cm ⁻¹ or below failure limit	061
Fail Lo Cond Value	Measured value < 0 or below failure limit	053
Fail Lo Conductance	Measured value < 0 or below failure limit	075
Fail Lo EI Slope	Slope of electrode system < 50 mV/pH (Option 356: < 50 mV/pH or < (nominal slope – 5.5 mV/pH)) or below failure limit	024
Fail Lo EI Slope A	Slope of electrode system channel A < 50 mV/pH (Option 356: < 50 mV/pH or < (nominal slope – 5.5 mV/pH)) or below failure limit	217
Fail Lo EI Slope B	Slope of electrode system channel B < 50 mV/pH (Option 356: < 50 mV/pH or < (nominal slope – 5.5 mV/pH)) or below failure limit	221
Fail Lo EI Zero	Electrode zero < pH 6 (Option 356: < pH 0 or < (nominal zero point – 1 pH unit)) or below failure limit	020
Fail Lo EI Zero A	Electrode zero channel A < pH 6 (Option 356: < pH 0 or < (nominal zero point – 1 pH unit)) or below failure limit	209
Fail Lo EI Zero B	Electrode zero channel B < pH 6 (Option 356: < pH 0 or < (nominal zero point – 1 pH unit)) or below failure limit	213
Fail Lo Glass EI	Glass electrode impedance below failure limit	032
Fail Lo Glass EI A	Glass electrode impedance channel A below failure limit	201
Fail Lo Glass EI B	Glass electrode impedance channel B below failure limit	204
Fail Lo mV Value	Measured value < –2000 mV or below failure limit	008
Fail Lo mV Value A	Measured value channel A < –2000 mV or below failure limit	167
Fail Lo mV Value B	Measured value channel B < –2000 mV or below failure limit	171

Error Message (Display in Diagnostics Menu "Message List")	Possible Error Causes and Remedies	Error Code
Fail Lo ORP Value	Measured value < -2000 mV or below failure limit	016
Fail Lo ORP Value A	Measured value channel A < -2000 mV or below failure limit	175
Fail Lo ORP Value B	Measured value channel B < -2000 mV or below failure limit	179
Fail Lo pH Value	Measured value < pH -2 or below failure limit	004
Fail Lo pH Value A	Measured value channel A < pH -2 or below failure limit	153
Fail Lo pH Value B	Measured value channel B < pH -2 or below failure limit	157
Fail Lo Ref El	Reference electrode impedance below failure limit	036
Fail Lo Ref El A	Reference electrode impedance channel A below failure limit	193
Fail Lo Ref El B	Reference electrode impedance channel A below failure limit	197
Fail Lo rH Value	Measured value < 0 rH or below failure limit	012
Fail Lo Temperature	Measured value < -50 °C or below failure limit (NTC < -20 °C)	083
Fail Lo Temperature A	Measured value channel A < -50 °C or below failure limit (NTC < -20 °C)	183
Fail Lo Temperature B	Measured value channel B < -50 °C or below failure limit (NTC < -20 °C)	187
Fail Probe Position	Unical®: Probe does not reach its end position or is pressed out of end position by process medium pressure	128
Fail System Failure	Device adjustment defective (EEPROM error), wrong program module	138
Fail TC Range	Error in settings for ultrapure water	069
Fail Unical	Unical®: communications error, defective cable, power failure	118
Warn V24 Overflow	Interface error: buffer overflow, too many characters received without message terminator	092
Warn V24 Syntax	Interface error: parity or framing error	093
Warn Buf Unknown	Buffer not stored in Calimatic® buffer set	037
Warn Buf Interchanged	Only for manual calibration: Wrong buffer sequence	039
Warn Cal Temp	Manual calibration temperature < -50 °C or > +250°C (Calimatic®: < 0 °C or > +100°C)	105
Warn Cell Const	Cond cal: cell constant < 0.01 or > 199.9 cm ⁻¹	067
Warn Cond Lead >10Ω	Error during RealCon® adjustment	070
Warn Control Parameter	Parameter error of controller, see Pg. 4-14	109
Warn Current1 <0/4 mA	Current output 1: Output current below defined initial value	098
Warn Current1 > 20 mA	Current output 1: Output current above defined end value	099
Warn Current1 Span	Current output 1: Initial and end value too close	097
Warn Current2 <0/4 mA	Current output 2: Output current below defined initial value	102
Warn Current2 > 20 mA	Current output 2: Output current above defined end value	103
Warn Current2 Span	Current output 2: Initial and end value too close	101
Warn Current3 <0/4 mA	Current output 3: Output current below defined initial value	124
Warn Current3 > 20 mA	Current output 3: Output current above defined end value	125
Warn Current3 Span	Current output 3: Initial and end value too close	123
Warn Current Parameter	Current parameter error (only for pH Transmitter 2800X-COND)	065

Error Message (Display in Diagnostics Menu "Message List")	Possible Error Causes and Remedies	Error Code
Warn Device Diagnostics	Error during self test	137
Warn Hi Cal Time	Cal timer above warning limit	089
Warn Hi Cal Time A	Cal timer channel A above warning limit	233
Warn Hi Cal Time B	Cal timer channel B above warning limit	237
Warn Hi Cell Const	Cell constant above warning limit	059
Warn Hi Cond Value	Measured conductivity above warning limit	051
Warn Hi EI Slope	Slope of electrode system above warning limit	022
Warn Hi EI Slope A	Slope of electrode system channel A above warning limit	215
Warn Hi EI Slope B	Slope of electrode system channel B above warning limit	219
Warn Hi EI Zero	Zero point of electrode system above warning limit	018
Warn Hi EI Zero A	Zero point of electrode system channel A above warning limit	207
Warn Hi EI Zero B	Zero point of electrode system channel B above warning limit	211
Warn Hi Feed Time	Controller: Feed time above warning limit	112
Warn Hi Glass EI	Glass electrode impedance above warning limit	030
Warn Hi Glass EI A	Glass electrode impedance channel A above warning limit	199
Warn Hi Glass EI B	Glass electrode impedance channel B above warning limit	203
Warn Hi mV Value	Measured mV value above warning limit	006
Warn Hi mV Value A	Measured mV value channel A above warning limit	165
Warn Hi mV Value B	Measured mV value channel B above warning limit	169
Warn Hi ORP Value	Measured ORP value above warning limit	014
Warn Hi ORP Value A	Measured ORP value channel A above warning limit	173
Warn Hi ORP Value B	Measured ORP value channel B above warning limit	177
Warn Hi pH Diff A-B	pH differential value channel A–B above warning limit	159
Warn Hi pH Diff A-M	pH differential value channel A–M above warning limit	161
Warn Hi pH Diff B-M	pH differential value channel B–M above warning limit	163
Warn Hi pH Value	Measured pH value above warning limit	002
Warn Hi pH Value A	Measured pH value channel A above warning limit	151
Warn Hi pH Value B	Measured pH value channel B above warning limit	155
Warn Hi Ref EI	Reference electrode impedance above warning limit	034
Warn Hi Ref EI A	Reference electrode impedance channel A above warning limit	191
Warn Hi Ref EI B	Reference electrode impedance channel B above warning limit	195
Warn Hi rH Value	Measured rH value above warning limit	010
Warn Hi Slope Diff M-A	Slope difference channel M–A above warning limit	223
Warn Hi Temp Diff A-B	Temperature difference channel A–B above warning limit	189
Warn Hi Temperature	Measured temperature above warning limit	081
Warn Hi Temperature A	Measured temperature channel A above warning limit	181
Warn Hi Temperature B	Measured temperature channel B above warning limit	185
Warn Hi Viso	Input value isothermal intersection potential $V_{iso} > +200$ mV (Option 356: $> +1000$ mV)	026
Warn Hi Viso A	Input value isothermal intersection potential channel A $V_{iso} > +200$ mV (Option 356: $> +1000$ mV)	225

Error Message (Display in Diagnostics Menu "Message List")	Possible Error Causes and Remedies	Error Code
Warn Hi Viso B	Input value isothermal intersection potential channel A $V_{iso} > +200$ mV (Option 356: $> +1000$ mV)	229
Warn Identical Buf	Calibration with identical buffer solutions	038
Warn Lo Cell Const	Cell constant below warning limit	060
Warn Lo Cond Value	Measured conductivity below warning limit	052
Warn Lo EI Slope	Slope of electrode system below warning limit	023
Warn Lo EI Slope A	Slope of electrode system channel A below warning limit	216
Warn Lo EI Slope B	Slope of electrode system channel B below warning limit	220
Warn Lo EI Zero	Zero point of electrode system below warning limit	019
Warn Lo EI Zero A	Zero point of electrode system channel A below warning limit	208
Warn Lo EI Zero B	Zero point of electrode system channel B below warning limit	212
Warn Lo Glass EI	Glass electrode impedance below warning limit	031
Warn Lo Glass EI A	Glass electrode impedance channel A below warning limit	200
Warn Lo Glass EI B	Glass electrode impedance channel B below warning limit	204
Warn Lo mV Value	Measured mV value below warning limit	007
Warn Lo mV Value A	Measured mV value channel A below warning limit	166
Warn Lo mV Value B	Measured mV value channel B below warning limit	170
Warn Lo ORP Value	Measured ORP value below warning limit	015
Warn Lo ORP Value A	Measured ORP value channel A below warning limit	175
Warn Lo ORP Value B	Measured ORP value channel B below warning limit	179
Warn Lo pH Value	Measured pH value below warning limit	003
Warn Lo pH Value A	Measured pH value channel A below warning limit	152
Warn Lo pH Value B	Measured pH value channel B below warning limit	156
Warn Lo Ref EI	Reference electrode impedance below warning limit	035
Warn Lo Ref EI A	Reference electrode impedance channel A below warning limit	192
Warn Lo Ref EI B	Reference electrode impedance channel B below warning limit	196
Warn Lo rH Value	Measured rH value below warning limit	011
Warn Lo Temperature	Measured temperature below warning limit	082
Warn Lo Temperature A	Measured temperature channel A below warning limit	182
Warn Lo Temperature B	Measured temperature channel B below warning limit	186
Warn Lo Viso	Input value isothermal intersection potential $V_{iso} < -200$ mV (Option 356: < -1000 mV)	027
Warn Lo Viso A	Input value isothermal intersection potential channel A $V_{iso} < -200$ mV (Option 356: < -1000 mV)	226
Warn Lo Viso B	Input value isothermal intersection potential channel B $V_{iso} < -200$ mV (Option 356: < -1000 mV)	230
Warn Ref Temp	Cond: Reference temp for TC calculation out of permissible range (-50 to $+250$ °C)	063
Warn Sensor Unstable	No stable end value for calibration after 2 min	106
Warn TC	Cond: TC linear < 0.00 or > 20.00 %/K	064
Warn TC Range	Calculation of TC of ultrapure water not within chart	066

Error Message (Display in Diagnostics Menu "Message List")	Possible Error Causes and Remedies	Error Code
Warn Time/Date	Clock had to be automatically initialized: Time must be set again!	108
Warn Unical Air	Checkback error at input E7 (no compressed air)	135
Warn Unical E1 PosMeas	Checkback error at input E1 (probe not in measurement position)	129
Warn Unical E2 Pos Cal	Checkback error at input E2 (probe not in cal position)	130
Warn Unical E3 Water	Checkback error at input E3 (no water)	131
Warn Unical E4 Input4	Checkback error at input E4 (free input)	132
Warn Unical E5 Buffer1	Checkback error at input E5 (no buffer solution 1)	133
Warn Unical E6 Buffer2	Checkback error at input E6 (no buffer solution 2)	134
Warn V24 Overflow	Interface error: Buffer overflow, too many characters received without terminator	092
Warn V24 Parameter	Interface error: Command parameter error	095
Warn V24 Syntax	Interface error: Parity or framing error	093
Warn V24 Syntax (no display)	Interface error: Command syntax error or command not available	094
Warn Variable Unstable	Cal: Measured value too unstable	068
Warn Write Protection	Interface error: Attempt to write without previous disabling of write protection	116

9 Interface Commands

Contents

Transmission behavior	9-3
VALUE Commands: Query measured values	9-4
STATUS Commands: Query messages and states	9-5
Query limit values (only with option 427)	9-6
Query electrode statistics	9-6
Query calibration record of last calibration	9-7
Query test results of device diagnostics	9-7
Logbook: Query entries (only with option 354)	9-8
Query measurement recorder (only with option 448)	9-8
Query tolerance band recorder (only with option 447)	9-8
PARAMETER Commands: Query settings and set parameters	9-9
Select operator language	9-9
Measurement Display	9-9
Parameter Setting of Left Additional Display	9-10
Parameter Setting of Right Additional Display	9-10
Input Filter	9-11
Temperature Detection	9-11
TC Measured Medium	9-11
Calimaticr Buffer Set	9-12
Cal Tolerance Band (only with option 447)	9-12
ORP Check	9-12
Nominal Zero Point/Nominal Slope (only with option 356)	9-13
rH Value	9-13
Delta Function	9-13

Output Current 1	9-13
Outputs 2 + 3 / SPC Inputs OK1, OK2 (only with option 427)	9-14
» ... » Current Output 2 (only with option 427)	9-14
» ... » Current Output 3 (only with option 427)	9-14
» ... » Limit Value Output 2	9-15
» ... » Limit Value Output 3	9-15
» ... » Controller (only with option 353 + option 427)	9-16
» ... » SPC Inputs (option 427 + inputs active)	9-17
Alarm Settings	9-17
» ... » Alarm 0 [...] to	
» ... » Alarm 9 [...]	9-17
NAMUR Contacts	9-18
Remote Interface / Unical® (only with option 420)	9-18
Unical® (provided, but remote interface active)	9-19
Set clock	9-20
Measurement Point	9-20
Device Diagnostics	9-20
Measurement Recorder (only with option 448)	9-20
Calibration	9-22
Temperature Probe Adjustment	9-22
DEVICE Commands: Device Description	9-23
COMMAND Commands: Control Commands	9-23
Calibration Commands	9-23
Device Diagnostics	9-23
Clock	9-23
Measurement Point Maintenance	9-24
ORP Check	9-24
Current Source Function	9-24
Parameter Setting Administrator Level	9-24
Controller (only with option 353)	9-24
Temperature Probe Adjustment	9-24
V 24 / 20 mA Interface	9-24
Calibration Example	9-25

Transmission behavior



For fault-free data exchange between the connected computer and the pH Transmitter 2800X, the parameter settings of both devices must match (also see Pg. 4–24).

Read/Write

- Read commands:
Read commands (queries) always supply an answer.
- Write commands:
For write commands the answer depends on the parameter setting.

The command “WPMSR1” switches on the check-back signal following write commands. The check-back signal is output as an empty string (message terminators only). The check-back signal acknowledges the complete processing of the received command. The receiving buffer is released again. The check-back signal does not mean that the command has been transmitted fault-free! With the check-back signal switched off, it is necessary to wait until the processing time of the pH Transmitter 2800X runs out. This may vary greatly. To avoid transmission errors, the waiting time should be at least one second.

Parameter setting strings

The characters of the standard ASCII character set (numbers 0 – 9, lower-case and upper-case letters, special characters such as +, – ...) are used.

Spaces (blanks) in the parameter setting string are read over. Therefore, they can be used as often as desired for formatting. No spaces may be used in numerical parameters.

Answers of the pH Transmitter 2800X contain only upper-case letters.

Each parameter setting string must be ended with a message terminator. A <cr> (carriage return), <lf> (line feed) or a combination of the two can be transmitted. The pH Transmitter 2800X does not begin processing the received command until the message terminator is received.

Without message terminators the receiving buffer fills up. When the receiving buffer is full, the error message “Warn V24 Overflow” appears.

Numerical parameters

Numerical parameters can be entered as desired with or without an exponent. Additional digits to the right of the decimal point are ignored. Parameters can only be transmitted in their basic units, e.g., "124 mV" is represented as "124E-3" in volts.

The pH Transmitter 2800X always selects the shortest possible display form, i.e., "pH 7.00" is transmitted as "7".

VALUE Commands: Query measured values

With the value commands, all measured values of the pH Transmitter 2800X can be queried. Value commands are read commands. As a result, the device status of the pH Transmitter 2800X is not changed.

Command	Meaning
RV0	Query measured pH value
RV1	Query measured mV value
RVUH	Query measured ORP value
RV2	Query measured temperature
RV6	Query measured rH value
RVRR	Query reference electrode impedance
RVRG	Query glass electrode impedance
RVI1	Query output current 1
RVI2	Query output current 2 (only with option 427 + current 2 active)
RVI3	Query output current 3 (only with option 427 + current 2 active)
RVYCI	Query controller output (only with option 353 + controller active)
RVTCA	Query cal timer count
RVDID	Query OK inputs (with option 427 + OK inputs selected) "0" no OK input active "1" only OK1 active "2" only OK2 active "3" OK1 and OK2 active
RVTRT	Query time "hhmmss"
RVDRT	Query date "ddmmyy" (sequence depending on setting)

STATUS Commands: Query messages and states

With the status commands, the device messages, such as the NAMUR messages Functional check, Warning (maintenance required) and Failure can be read out, device states monitored and the logs interrogated. With the status commands, data can be accessed which can be used for QM documentation to ISO 9000. Status commands are read commands. As a result, the device status of the pH Transmitter 2800X is not changed.

Command	Function	Response	Meaning
RSF1	Query first failure message	xxx	
RSFA	Query all failure messages	xxx;xxx ...	
RSW1	Query first warning message	xxx	
RSWA	Query all warning messages	xxx;xxx ...	

Command	Function	Response	Meaning
RSP	Query device status ("menu")	00	measuring mode
		01	parameter setting opl, adm
		02	calibration cal
		08	maintenance maint
		0A	maintenance maint + calibration cal

Command	Function	Bit	Meaning
RSU	Query device status (messages, limits, SRQS)	1 : FAIL	"1" if one or more failure messages are active
		2 : WARN	"1" if one or more warning messages are active
		3 : FCT	"1" if functional check is active
		4 : LIMIT	"1" if limit 2 and/or limit 3 is active (option 427)
		5 : FROST	"1" if outputs are frozen (e.g. during calibration)
		6 :	always "1"
		7 : SRQS	"1" if there has been a status change since last query
		8 :	always "0"

The pH Transmitter 2800X automatically sets bit 7 of device status (service request) in the case of status change. This happens, for example, when an error message occurs. The SRQS bit is reset when status is read using the RSU command.

Query limit values (only with option 427)

Command	Function	Response	Meaning
RSL	Query limit value messages	0	no limit value message
		1	limit value output 2 active
		2	limit value output 3 active
		3	both limit values active

Query electrode statistics

Command	Function	Parameter
RSSTT <i>m</i>	Query time of calibration	<i>m</i> = 0...3
RSSTD <i>m</i>	Query date of calibration	<i>m</i> = 0...3
RSSTZ0	Query zero point of electrode system	
RSSTS0	Query slope of electrode system	
RSSTRG0	Query glass electrode impedance	
RSSTRR0	Query reference electrode impedance	
RSSTTR <i>m</i>	Query electrode response time	<i>m</i> = 0...3
RSSTZD <i>m</i>	Query deviation of zero point	<i>m</i> = 1...3
RSSTSD <i>m</i>	Query deviation of slope	<i>m</i> = 1...3
RSSTRGD <i>m</i>	Query deviation of glass electrode impedance	<i>m</i> = 1...3
RSSTRRD <i>m</i>	Query deviation of reference electrode impedance	<i>m</i> = 1...3

First Calibration = data record 0

Query calibration record of last calibration

Command	Function
RSCPT	Query calibration time
RSCPD	Query calibration date
RSCPA	Query calibration mode ("0" = auto, "1" = man, "2" = data, "3" = sample)
RSCPCT	Query calibration tolerance band ("0" = old EL data, "1" = new EL data)
RSCP1NB	Query nominal value of 1st buffer
RSCP11	Query electrode system potential with 1st buffer
RSCP12	Query calibration temperature with 1st buffer
RSCP1TR	Query response time with 1st buffer
RSCP2NB	Query nominal value of 2nd buffer
RSCP21	Query electrode system potential with 2nd buffer
RSCP22	Query calibration temperature with 2nd buffer
RSCP2TR	Query response time with 2nd buffer

Query test results of device diagnostics

Command	Test	Result	Meaning
RSTETR	RAM test	time	"0" = ok "2" = failure
RSTEDR		date	
RSTERR		result	
RSTETP	EPROM test	time	"0" = ok "2" = failure
RSTEDP		date	
RSTERP		result	
RSTETE	EEPROM test	time	"0" = ok "2" = failure
RSTEDE		date	
RSTERE		result	
RSTETDI	display test	time	"0" = executed "2" = failure
RSTEDDI		date	
RSTERDI		result	
RSTETKY	keypad test	time	"0" = ok "2" = failure
RSTEDKY		date	
RSTERKY		result	

Logbook: Query entries (only with option 354)

For complete interrogation of the logbook, first use the command "RSLOO" to read the oldest entry. Then use the command "RSLOOC" until an empty string (message terminators only) is received as an answer. The empty string means that there are no more entries.

If only new logbook entries are to be read which have not yet been read out via the interface, use the command "RSLOOC" immediately.

Command	Function
RSLOO	Query oldest entry
RSLOOC	Query following entry
RSLON	Query latest entry
RSLONC	Query previous entry

Query measurement recorder (only with option 448)

For complete interrogation of the measurement recorder, first use the command "RSRCO" to read the oldest entry. Then use the command "RSRCOC" until an empty string (message terminators only) is received as an answer. The empty string means that there are no more entries.

If only new recorder entries are to be read which have not yet been read out via the interface, use the command "RSRCOC" immediately until an empty string is received. The recorder has stored the last 500 measured values with date and time.

Command	Function
RSRCO	Query oldest entry
RSRCOC	Query following entry
RSRCN	Query latest entry
RSRCNC	Query previous entry

Query tolerance band recorder (only with option 447)

For complete interrogation of the tolerance band recorder, first use the command "RSCRO" to read the oldest entry. Then use the command "RSCROC" until an empty string (message terminators only) is received as an answer. The empty string means that there are no more entries.

If only new recorder entries are to be read which have not yet been read out via the interface, use the command "RSCROC" immediately until an empty string is received. The recorder has stored zero and slope values of the last 45 calibrations with date and time.

Command	Function
RSCRO	Query oldest entry
RSCROC	Query following entry
RSCRN	Query latest entry
RSCRNC	Query previous entry

PARAMETER Commands: Query settings and set parameters

With the parameter commands, all functions of the pH Transmitter 2800X can be defined via the computer interface (with the exception of the interface transmission parameters).



With the parameter commands, all device parameters can be read and written! Therefore, the correctness of the transmitted commands is particularly important. Transmission in the point-to-point mode is not secured with checksums. To avoid incorrect settings, it is therefore advisable to read back important parameters for a comparison.



With the first write command, the controlling computer (PC, SPS, ...) assumes control of the pH Transmitter 2800X. Security prompts must then be implemented in the computer! With the command "WCOMIN0" (go to local) the computer returns control to the pH Transmitter 2800X. The pH Transmitter 2800X restarts in the measuring mode. Read commands cause no status changes and do not influence the system functions. The pH Transmitter 2800X continues to be in control.

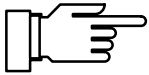

When the write protection is switched on, any write attempts without switching off the write protection beforehand or with an invalid passcode are entered in the logbook. As delivered, write protection is disabled.

If parameter setting is called up with the device keypad, the NAMUR message Functional Check is set. Warning and failure contacts are deactivated until parameter setting is completed. If device parameters are changed via the RS 485 interface, all messages are released. As a result, temporary messages may occur when changing parameters which would have been suppressed had the keypad been used.

- WCOM01 With the interface command "WCOM01" the device can be switched to the parameter setting mode. The NAMUR message Functional Check is then set and with it the warning and failure contact also deactivated in the interface mode. Return to the measuring mode with "WCOM00".
- WCOU1 If all device functions are to be frozen during parameter setting, use the command "WCOU1". The function check is set, and the warning and failure contact deactivated. The output current and controller are also frozen and the limit-value contacts are inactive. Unfreeze the device functions with "WCOU0".

Select operator language

- RPLAA Query selected language
- WPLAA0 Select "German" as operator language
- WPLAA1 Select "English" as operator language
- WPLAA2 Select "French" as operator language
- WPLAA3 Select "Italian" as operator language
- WPLAA4 Select "Spanish" as operator language

Measurement Display

- RPDIMM Query marker
- WPDIMM0 Set marker "Off"
- WPDIMM1 Set marker "On"

RPDIMA	Query measured variable assigned
WPDIMA0	Assign pH value to measurement display
WPDIMA1	Assign mV value to measurement display
WPDIMAUH	Assign ORP to measurement display
WPDIMA6	Assign rH value to measurement display
WPDIMA2	Assign measured temperature to measurement display
WPDIMATRT	Assign time to measurement display
RPDIMD	Measurement display: Query number of indicated pH digits
WPDIMD0	Display pH value with 1 digit behind decimal point (xx.x)
WPDIMD1	Display pH value with 2 digits behind decimal point (xx.xx)
RPDIMVA	Query viewing angle
WPDIMVAn	Adjust viewing angle (n = "-2", "-1", "0", "+1", "+2",)

Parameter Setting of Left Additional Display

RPDISLA	Query measured variable assigned	
WPDISLA0	Display pH value	
WPDISLA1	Display mV value	
WPDISLAUH	Display ORP	
WPDISLA6	Display rH value	
WPDISLA2	Display measured temperature	
WPDISLARR	Display reference electrode impedance	
WPDISLARG	Display glass electrode impedance	
WPDISLAI1	Display output current 1	
WPDISLAI2	Display output current 2	(only option 427 + current 2 active)
WPDISLAI3	Display output current 3	(only option 427 + current 3 active)
WPDISLAYCI	Display controller output Y	(only option 353 + controller active)
WPDISLADCI	Display controller setpoint X_w	(only option 353 + controller active)
WPDISLATCA	Display calibration timer	
WPDISLATRT	Display time	
WPDISLADRT	Display date	
WPDISLATM	Display manually adjusted temperature	

Parameter Setting of Right Additional Display

RPDISRA	Query measured variable assigned
WPDISRA0	Display pH value
WPDISRA1	Display mV value
WPDISRAUH	Display ORP
WPDISRA6	Display rH value
WPDISRA2	Display measured temperature
WPDISRARR	Display reference electrode impedance

WPDISRARG	Display glass electrode impedance	
WPDISRAI1	Display output current 1	
WPDISRAI2	Display output current 2	(only option 427 + current 2 active)
WPDISRAI3	Display output current 3	(only option 427 + current 3 active)
WPDISRAYCI	Display controller output Y	(only option 353 + controller active)
WPDISRADCI	Display controller setpoint X_w	(only option 353 + controller active)
WPDISRATCA	Display calibration timer	
WPDISRATRT	Display time	
WPDISRADRT	Display date	
WPDISRATM	Display manually adjusted temperature	

Input Filter

RPIFM	Query marker	
WPIFM0	Set marker "Off"	
WPIFM1	Set marker "On"	
RPIF	Query input filter setting, pulse suppression	
WPIF0	Disable input filter	
WPIF1	Enable input filter	

Temperature Detection

RPTOMM	Query marker	
WPTOMM0	Set marker "Off"	
WPTOMM1	Set marker "On"	
RPTOT	Query temperature probe setting	(only option 476)
WPTOT0	Set NTC temperature probe	(only option 476)
WPTOT1	Set Pt 1000 temperature probe	(only option 476)
RPTOMA	Query measuring temperature detection	
WPTOMA0	Set measuring temperature detection "manual"	
WPTOMA1	Set measuring temperature detection "automatic"	
RPTMMV	Query manual temperature detection	
WPTMMV p	Set manual measuring temperature p	
RPTOCA	Query calibration temperature detection	
WPTOCA0	Set calibration temperature detection "manual"	
WPTOCA1	Set calibration temperature detection "automatic"	
RPTMCV	Query manual calibration temperature	
WPTMCV p	Set manual calibration temperature p	

TC Measured Medium

RPTCM	Query marker	
WPTCM0	Set marker "Off"	
WPTCM1	Set marker "On"	
RPTCS	Query TC adjustment	
WPTCS0	Set TC "Off"	

WPTCS1	Set TC "ultrapure water"
WPTCS2	Set TC "Chart"
RPTCVnn	TC test medium pH, query chart value at temperature <i>nn</i> °C
WPTCVnnp	Set TC value <i>p</i> at temp <i>nn</i> °C (temp <i>nn</i> = 00 to 95 in 5 °C steps)

Calimatic® Buffer Set

RPCASM	Query marker	
WPCASM0	Set marker "Off"	
WPCASM1	Set marker "On"	
RPCASA	Query Calimatic® buffer set	
WPCASA1	Select buffer set Merck/Riedel	
WPCASA2	Select buffer set Mettler Toledo (former Ingold)	
WPCASA3	Select buffer set DIN 19 267	
WPCASA4	Select buffer set Ciba (94)	
WPCASA01	Select customer specific buffer set	(option 371)
WPCASA04	Select customer specific buffer set	(option 374)
WPCASA05	Select customer specific buffer set	(option 375)
WPCASA06	Select customer specific buffer set	(option 376)
WPCASA07	Select customer specific buffer set	(option 377)
WPCASA08	Select customer specific buffer set	(option 378)

Cal Tolerance Band (only with option 447)

RPCATM	Query marker
WPCATM0	Set marker "Off"
WPCATM1	Set marker "On"
RPCATA	Query tolerance band check
WPCATA0	Set tolerance band check "Off"
WPCATA1	Set tolerance band check "On"
RPCATZ	Query tolerance band for zero point
WPCATZp	Set zero point tolerance band <i>p</i>
RPCATS	Query tolerance band for slope
WPCATSp	Set slope tolerance band <i>p</i>

ORP Check

RPREM	Query marker
WPREM0	Set marker "Off"
WPREM1	Set marker "On"
RPRET	Query test time
WPRETp	Set test time <i>p</i>
RPRED	Query test difference
WPREDP	Set test difference <i>p</i>

Nominal Zero Point/Nominal Slope (only with option 356)

RPCA0NM	Query marker
WPCA0NM0	Set marker "Off"
WPCA0NM1	Set marker "On"
RPCA0NZ	Query entered nominal zero point
WPCA0NZ p	Set nominal zero point p
RPCA0NS	Query entered nominal slope
WPCA0NS p	Set nominal slope p

rH Value

RPREFM	Query marker
WPREFM0	Set marker "Off"
WPREFM1	Set marker "On"
RPREFS	Query prompt "Calculate rH with correction factor"
WPREFS0	Set "Calculate rH with factor Off"
WPREFS1	Set "Calculate rH with factor On"
RPREFV	Query correction factor
WPREFV p	Set correction factor p
RPRERT	Query reference electrode type
WPRERT0	Set type A silver chloride (Ag/AgCl, KCl 1 M)
WPRERT1	Set type B silver chloride (Ag/AgCl, KCl 3 M)
WPRERT2	Set type C Thalamid (Hg, TI/TICI, KCl 3.5 M)
WPRERT3	Set type D mercury sulfate (Hg/Hg ₂ SO ₄ , K ₂ SO ₄ sat.)

Delta Function

RPFDM	Query marker setting
WPFDM0	Set marker "Off"
WPFDM1	Set marker "On"
RPFDA	Query delta function
WPFDA0	Set: "Delta Function Off"
WPFDA1	Set: "Delta Function pH"
WPFDA1	Set: "Delta Function mV"
WPFDAUH	Set: "Delta Function ORP"
RPFDV	Query delta value
WPFDV p	Set delta value p

Output Current 1

RPOC1M	Query marker
WPOC1M0	Set marker "Off"
WPOC1M1	Set marker "On"
RPOC1A	Query measured variable assigned
WPOC1A0	Assign pH value as measured variable
WPOC1A1	Assign mV value as measured variable

WPOC1AUH	Assign ORP value as measured variable
WPOC1A6	Assign rH value as measured variable
WPOC1A2	Assign measuring temperature as measured variable
RPOC1Z	Query operating mode 0 – 20 mA / 4 – 20 mA
WPOC1Z0	Set operating mode 0 – 20 mA
WPOC1Z1	Set operating mode 4 – 20 mA
RPOC1L	Query initial value
WPOC1Lp	Set initial value <i>p</i>
RPOC1H	Query end value
WPOC1Hp	Set end value <i>p</i>

Outputs 2 + 3 / SPC Inputs OK1, OK2 (only with option 427)

RPDOM	Query marker	
WPDOM0	Set marker "Off"	
WPDOM1	Set marker "On"	
RPDOS	Query usage	
WPDOS1	Set current / current	
WPDOS2	Set controller	(option 353)
WPDOS3	Set current / limit value	
WPDOS4	Set limit value / limit value	
WPDOS5	OK inputs	

» . . . » **Current Output 2** (only with option 427)

RPOC2A	Query measured variable assigned
WPOC2A0	Assign pH value as measured variable
WPOC2A1	Assign mV value as measured variable
WPOC2AUH	Assign ORP value as measured variable
WPOC2A6	Assign rH value as measured variable
WPOC2A2	Assign measuring temperature as measured variable
RPOC2Z	Query operating mode 0 – 20 mA / 4 – 20 mA
WPOC2Z0	Set operating mode 0 – 20 mA
WPOC2Z1	Set operating mode 4 – 20 mA
RPOC2L	Query initial value
WPOC2Lp	Set initial value <i>p</i>
RPOC2H	Query end value
WPOC2Hp	Set end value <i>p</i>

» . . . » **Current Output 3** (only with option 427)

RPOC3A	Query measured variable assigned
WPOC3A0	Assign pH value as measured variable
WPOC3A1	Assign mV value as measured variable
WPOC3AUH	Assign ORP value as measured variable
WPOC3A6	Assign rH value as measured variable

WPOC3A2	Assign measuring temperature as measured variable
RPOC3Z	Query operating mode 0 – 20 mA / 4 – 20 mA
WPOC3Z0	Set operating mode 0 – 20 mA
WPOC3Z1	Set operating mode 4 – 20 mA
RPOC3L	Query initial value
WPOC3L <i>p</i>	Set initial value <i>p</i>
RPOC3H	Query end value
WPOC3H <i>p</i>	Set end value <i>p</i>

» . . . » **Limit Value Output 2**

RPLI2A	Query measured variable assigned
WPLI2A0	Assign pH value as measured variable
WPLI2A1	Assign mV value as measured variable
WPLI2AUH	Assign ORP value as measured variable
WPLI2A6	Assign rH value as measured variable
WPLI2A2	Assign measuring temperature as measured variable
RPLI2D	Query effective direction
WPLI2D0	Set effective direction Min
WPLI2D1	Set effective direction Max
RPLI2V	Query limit value 2
WPLI2V <i>p</i>	Set limit value 2 <i>p</i>
RPLI2H	Query hysteresis
WPLI2H <i>p</i>	Set hysteresis <i>p</i>
RPLI2CN	Query limit contact 2
WPLI2CN0	Set limit contact 2 as normally closed
WPLI2CN1	Set limit contact 2 as normally open

» . . . » **Limit Value Output 3**

RPLI3A	Query measured variable assigned to limit value 3
WPLI3A0	Assign pH value as measured variable
WPLI3A1	Assign mV value as measured variable
WPLI3AUH	Assign ORP value as measured variable to limit value 3
WPLI3A6	Assign rH value as measured variable
WPLI3A2	Assign measuring temperature as measured variable
RPLI3D	Query effective direction
WPLI3D0	Set effective direction Min
WPLI3D1	Set effective direction Max
RPLI3V	Query limit value 3
WPLI3V <i>p</i>	Set limit value 3 <i>p</i>
RPLI3H	Query hysteresis
WPLI3H <i>p</i>	Set hysteresis <i>p</i>

RPLI3CN	Query limit contact 3
WPLI3CN0	Set limit contact 3 as normally closed
WPLI3CN1	Set limit contact 3 as normally open
» . . . » Controller (only with option 353 + option 427)	
RPCITA	Query controller type
WPCITA0	Set pulse length controller (switching controller)
WPCITA1	Set pulse frequency controller (switching controller)
WPCITA2	Set 3-way mixing valve (analog controller)
WPCITA3	Set straightway valves (analog controller)
RPCIA	Query controlled variable
WPCIA0	Set pH as controlled variable
WPCIA1	Set mV as controlled variable
WPCIAUH	Set ORP as controlled variable
WPCIA6	Set rH as controlled variable
WPCIA2	Set measuring temperature as controlled variable
RPCID	Query setpoint X_w
WPCID p	Set setpoint $X_w p$
RPCINZ	Query neutral zone
WPCINZ p	Set neutral zone p
RPCILT	Query minimum ON time (pulse length controller)
WPCILT p	Set minimum ON time p
RPCILF	Query maximum pulse frequency (pulse frequency controller)
WPCILF p	Set maximum pulse frequency p
RPCIBV	Query ◀ beginning of control
WPCIBV p	Set ◀ beginning of control p
RPCIBX	Query ◀ corner point X
WPCIBX p	Set ◀ corner point X p
RPCIBY	Query ◀ corner point Y
WPCIBY p	Set ◀ corner point Y p
RPCIBT	Query ◀ reset time
WPCIBT p	Set ◀ reset time p
RPCIBP	Query ◀ period (pulse length controller)
WPCIBP p	Set ◀ period p
RPCIEV	Query ▶ end of control
WPCIEV p	Set ▶ end of control p
RPCIEX	Query ▶ corner point X
WPCIEX p	Set ▶ corner point X p
RPCIEY	Query ▶ corner point Y

WPCIEY p	Set ► corner point Y p
RPCIET	Query ► reset time
WPCIET p	Set ► reset time p
RPCIEP	Query ► period (pulse length controller)
WPCIEP p	Set ► period p
RPCIZ	Query analog controller output 0 to 20 mA / 4 to 20 mA
WPCIZ0	Set operating mode 0 to 20 mA
WPCIZ1	Set operating mode 4 to 20 mA
RPCIC	Query controller behavior for cal/maint
WPCIC0	Set Y = 0 %
WPCIC1	Set Y = const.

» . . . » **SPC Inputs** (option 427 + inputs active)

RPIDS	Query OK1 setting
WPIDS0	locks cal
WPIDS1	inactive / starts cal (with Unical® ON)
RPIDP	Query inputs OK1, OK2
WPIDP0	normal
WPIDP1	inverse

Alarm Settings

RPALM	Query marker
WPALM0	Set marker "Off"
WPALM1	Set marker "On"

» . . . » **Alarm 0 [. . .] to**
 » . . . » **Alarm 9 [. . .]**

The pH Transmitter 2800X can store up to 10 alarms. To each alarm n (0 – 9) you can assign a measured variable. For each selected variable you can define an upper and a lower warning and failure limit each. For differential alarms, it is sufficient to define the upper limits only.

WPAL n A	Alarm n , query measured variable assigned
WPAL n A0	Assign alarm n to measured pH value
WPAL n A1	Assign alarm n to measured mV value
WPAL n AUH	Assign alarm n to measured ORP
WPAL n A6	Assign alarm n to rH value
WPAL n A2	Assign alarm n to measuring temperature
WPAL n ARR	Assign alarm n to reference electrode impedance
WPAL n ARG	Assign alarm n to glass electrode impedance
WPAL n AZ	Assign alarm n to zero point of electrode system
WPAL n AS	Assign alarm n to slope of electrode system
WPAL n AT	Assign alarm n to cal timer
WPAL n AYT	Assign alarm n to feed time

(option 353 + controller active)

RPALnS	Alarm <i>n</i> , query setting
WPALnS0	Set alarm <i>n</i> "Off"
WPALnS1	Set alarm <i>n</i> "On"
RPALnFL	Alarm <i>n</i> , query setting failure low
WPALnFLp	Alarm <i>n</i> , set failure low <i>p</i>
RPALnWL	Alarm <i>n</i> , query setting warning low
WPALnWLp	Alarm <i>n</i> , set warning low <i>p</i>
RPALnWH	Alarm <i>n</i> , query setting warning high
WPALnWHp	Alarm <i>n</i> , set warning high <i>p</i>
RPALnFH	Alarm <i>n</i> , query setting failure high
WPALnFHp	Alarm <i>n</i> , set failure high <i>p</i>

NAMUR Contacts

RPCNM	Query marker
WPCNM0	Set marker "Off"
WPCNM1	Set marker "On"
RPCNUO	Query normally open/normally closed contact
WPCNUO0	Set normally closed contact
WPCNUO1	Set normally open contact
RPCNUOTF	Query failure delay
WPCNUOTFp	Set failure delay <i>p</i>
RPCNUOTW	Query warning delay
WPCNUOTWp	Set warning delay <i>p</i>
RPCNUOTD	Query functional check delay
WPCNUOTDp	Set functional check delay <i>p</i>

Remote Interface / Unical[®] (only with option 420)

RPINM	Query marker setting
WPINM0	Set marker "Off"
WPINM1	Set marker "On"
RPINWP	Query write protection
WPINWP0	Set write protection "Off"
WPINWP1	Set write protection "On"
RPMSR	Query ready message
WPMSR0	Set: no return after write command
WPMSR1	Set: Send return after write command

Unical[®] (provided, but remote interface active)

RPUCS	Query Unical [®]
WPUCS0	Set Unical [®] "Off"
WPUCS1	Set Unical [®] "On"
RPUCTC	Query cal interval
WPUCTC <i>p</i>	Set cal interval <i>p</i>
RPUCTR	Query rinsing interval
WPUCTR <i>p</i>	Set rinsing interval <i>p</i>
RPUCP <i>ss</i>	Query program step <i>ss</i> (<i>ss</i> = 01 – 50)
WPUCP <i>ss Fff Mm Rrr Tttt Ddd</i>	Set program step <i>ss</i> <i>ss</i> = Unical [®] step(01 – 50) <i>ff</i> = Function (FUNCTION No.) "01" = ○ A1 level "03" = ○ A2 water "05" = ○ A3 outp.3 "07" = ○ A4 outp.4 "09" = ○ A5 pump 1 "11" = ○ A6 pump 2 "13" = ○ A7 outlet "15" = ○ A8 pos cal "17" = measurement off "19" = empty step "21" = cal buffer 2 "23" = controller off "25" = program end <i>m</i> = Execution (MODE) "1" = cal <i>rr</i> = Checkback (REPLAY) "01" = E1 pos meas "02" = E2 pos cal "03" = E3 water "04" = E4 inp. 4 "05" = E5 buffer 1 "06" = E6 buffer 2 "07" = - - - - <i>ttt</i> = Step Time (TIME) [s] <i>dd</i> = Display Text (DISPLAY MESSAGE No.) "01" = probe cal "03" = rinsing water "05" = buffer solution 2 "07" = conditioning solution "09" = hot vapor "11" = compressed air "13" = additional function "02" = ● A1 level "04" = ● A2 water "06" = ● A3 outp.3 "08" = ● A4 outp.4 "10" = ● A5 pump 1 "12" = ● A6 pump 2 "14" = ● A7 outlet "16" = ● A8 pos cal "18" = measurement on "20" = cal buffer 1 "22" = ORP check "24" = wait position "2" = cal + maint "08" = E1 inactive "09" = E2 inactive "10" = E3 inactive "11" = E4 inactive "12" = E5 inactive "13" = E6 inactive "02" = probe measurement "04" = buffer solution 1 "06" = redox buffer "08" = solvent "10" = level measurement "12" = lead time

Set clock

RPRTM	Query marker
WPRTM0	Set marker "Off"
WPRTM1	Set marker "On"
RPRTDF	Query date format
WPRTDF0	Set date format "DD.MM.YY"
WPRTDF1	Set date format "DD/MM/YY"
WPRTDF2	Set date format "MM/DD/YY"
WPRTDF3	Set date format "YY-MM-DD"



For setting time/date: see page 9–23

For query of time/date: see page 9–4

Measurement Point

RPUAM	Query marker
WPUAM0	Set marker "Off"
WPUAM1	Set marker "On"
RPUAW	Query measurement point
WPUAWaaaaaa...	Set measurement point <i>a</i> = ASCII character: blank, "0" to "9", "A" to "Z", "-", "+", "/" (max. 15 characters)
RPUAN	Query note
WPUAaaaaaaaa...	Write note (<i>a</i> = max 15 ASCII characters)

Device Diagnostics

RPTEM	Query marker
WPTEM0	Set marker "Off"
WPTEM1	Set marker "On"
RPTES	Query self test
WPTES0	Disable self test
WPTES1	Enable self test
RPTETI	Query interval [h]
WPTETIp	Set interval <i>p</i> [h]

Measurement Recorder (only with option 448)

RPRCM	Query marker
WPRCM0	Set marker "Off"
WPRCM1	Set marker "On"

RPRCDI	Query system display	
WPRCDI0	Measuring mode, measurement display	
WPRCDI1	Measurement recorder	
WPRCDI2	Measuring mode, status display	
RPRCLA	Left channel, query measured variable assigned	
WPRCLA0	Assign measured pH value	
WPRCLA1	Assign measured mV value	
WPRCLAUH	Assign measured ORP	
WPRCLA6	Assign rH value	
WPRCLA2	Assign measuring temperature	
WPRCLAI1	Assign output current 1	
WPRCLAI2	Assign output current 2	(option 427 + current 2 active)
WPRCLAI3	Assign output current 3	(option 427 + current 3 active)
WPRCLARR	Assign reference electrode impedance	
WPRCLARG	Assign glass electrode impedance	
RPRCLL	Left channel, query initial value	
WPRCLL p	Set initial value p	
RPRCLH	Left channel, query end value	
WPRCLH p	Set end value p	
RPRCLS	Left channel, query recording	
WPRCLS0	Record instantaneous value	
WPRCLS1	Record min value (▼)	
WPRCLS2	Record max value (▲)	
WPRCLS3	Record average value (~)	
RPRCRA	Right channel, query measured variable assigned	
WPRCRA0	Assign measured pH value	
WPRCRA1	Assign measured mV value	
WPRCRAUH	Assign measured ORP	
WPRCRA6	Assign rH value	
WPRCRA2	Assign measuring temperature	
WPRCRAI1	Assign output current 1	
WPRCRAI2	Assign output current 2	(option 427 + current 2 active)
WPRCRAI3	Assign output current 3	(option 427 + current 3 active)
WPRCRARR	Assign reference electrode impedance	
WPRCRARG	Assign glass electrode impedance	
RPRCRL	Right channel, query initial value	
WPRCRL p	Set initial value p	
RPRCRH	Measurement recorder, right channel, query end value	

WPRCRHp	Set end value p
RPRCRS	Measurement recorder, right channel, query recording
WPRCRS0	Record instantaneous value (snapshot)
WPRCRS1	Record min value (▼)
WPRCRS2	Record max value (▲)
WPRCRS3	Record average value (~)
RPRCT	Measurement recorder, query time feed (time/pixel)
WPRCT2S	Set time feed 2s
WPRCT5S	Set time feed 5s
WPRCT10S	Set time feed 10s
WPRCT30S	Set time feed 30s
WPRCT1M	Set time feed 1min
WPRCT5M	Set time feed 5min
WPRCT10M	Set time feed 10min
WPRCT30M	Set time feed 30min
WPRCT1H	Set time feed 1h
WPRCT2H	Set time feed 2h
WPRCT5H	Set time feed 5h
WPRCT10H	Set time feed 10h

Calibration

RPCABb	Query manual buffer b
WPCABbp	Set manual buffer p ($b = 0$ or 1)
RPCAP	Query sample value
WPCAPp	Set lab value p
RPCA0Z	Query current electrode zero point
WPCA0Zp	Set electrode zero point p (data calibration)
RPCA0S	Query current electrode slope
WPCA0Sp	Set electrode slope p (data calibration)
RPCA0U	Query current isothermal intersection potential V_{iso}
WPCA0Up	Set V_{iso} p (data calibration)

Temperature Probe Adjustment

RPTFS	Query temperature probe adjustment
WPTFS0	Disable temperature probe adjustment
WPTFS1	Enable temperature probe adjustment

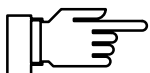

For setting the adjustment value, see page 9–24

DEVICE Commands: Device Description

With the device commands the device description can be read out.

RDMF	Query manufacturer
RDUN	Query device type
RDUS	Query serial number
RDUV	Query software/hardware version: "20;01" means "software version 2.0, hardware version 1"
RDUP	Query option numbers
RDUM	Query program module

COMMAND Commands: Control Commands

The pH Transmitter 2800X can be controlled with the "command" commands. "Command" commands are write commands which call up functions or change device states.



With the first write command, the controlling computer (PC, SPS, ...) assumes control over the pH Transmitter 2800X. Many safety prompts must then be implemented in the computer! With the command "WCOMIN0" (go to local), the computer returns control to the pH Transmitter 2800X. The pH Transmitter 2800X restarts in the measuring mode.



When the write protection is switched on, any write attempts without switching off the write protection beforehand or with an invalid passcode are entered in the logbook.

As delivered, write protection is disabled.

Calibration Commands

WCCAA1	Calibrate Calimatic® using buffer 1
WCCAA2	Calibrate Calimatic® using buffer 2
WCCAM1	Calibrate manually using buffer 1
WCCAM2	Calibrate manually using buffer 2
WCCAPT	Take pH sample
WCCAPC	Process pH sample
WCCASTI	Store present data record as First Calibration



See also calibration example on page 9–25

Device Diagnostics

WCTEA	Start device diagnostics (self test)
-------	--------------------------------------

Clock

WCRTThmmss	Set time <i>hhmmss</i>
WCRTDddmmyy	Set date <i>ddmmyy</i> (format depending on setting)

Measurement Point Maintenance

WCOM08MA Enable measurement point maintenance (output currents and controller output frozen, limit values disabled)

ORP Check

WCCAR1 Start ORP check

Current Source Function

WCOM08CS Enable current source function

WCCSI1 p Set output current 1 to value p

WCCSI2 p Set output current 2 to value p (option 427 + current 2 active)

WCCSI3 p Set output current 3 to value p (option 427 + current 3 active)

Parameter Setting Administrator Level

WCOM00 Return to measuring mode

WCOM01 Activate Parameter Setting menu (functional check active)

WCPZM0 Erase all markers

WCPZM1 Set all markers

WCOU0 Unfreeze output currents, enable controller output and limit values

WCOU1 Freeze output currents, controller turned off/frozen, limit values disabled

Controller (only with option 353)

WCOM08CI Enable manual controller (option 353 + controller active)

WCCIM p Set controller output to value p (option 353 + controller active)

Temperature Probe Adjustment

WCTFV p Start temp pprobe adjustment at p °C.
(For installation adjustment On/Off, see WPTFSn)

V 24 / 20 mA Interface

WCOMIN0 Goto local (activate write protection)
This write command is no violation of write protection!

WCDIW0aaaa... Write free text as display message: max. 40 characters,
Can only be written on bottom display line during functions such as
current source, maintenance, etc!
 a = ASCII character: blank, "0" ... "9", "A" ... "Z", "-", "+", "/"

WCINPW $pppp$ Deactivate write protection, $pppp$ = administrator passcode,
required for writing parameters and control commands

WCINPD Activate write protection
(For write protection On/Off, see page 9–18, Remote Interface/Unical[®],
WPINWPn)

Calibration Example

The following example shows the sequence of calibration commands for a 2–point calibration using Calimatic® via pH Transmitter 2800X remote interface control.

Command	Explanation
WCOU1	Turn off/freeze currents and controller, limit values disabled → <i>Remove electrode system and immerse it in buffer 1</i>
WCCAA1	Start calibration using first buffer
RSP	Regularly query RSP (wait until cal mode terminated) Response: "02" for cal "00" for measurement (cal terminated)
RSWA	Query warnings, possible cal errors: 037 - Warn Buf Unknown (buffer not identified) 105 - Warn Cal Temp (calibration at wrong temperature) 106 - Warn Sensor Unstable (unstable even after 2 min.)
RSFA	Query failures, possible cal errors: 017 - Fail Hi El Zero (zero point out of 020 - Fail Lo El Zero permitted range) → <i>Immerse electrode system in buffer 2</i>
WCCAA2	Start calibration using second buffer
RSP	Regularly query RSP (wait until cal mode exited) Response: "02" for cal "00" for measurement (cal terminated)
RSWA	Query warnings, possible cal errors: 037 - Warn Buf Unknown (buffer not identified) 038 - Warn Identical Buf (buffer 1 and 2 identical) 105 - Warn Cal Temp (calibration at wrong temperature) 106 - Warn Sensor Unstable (unstable even after 2 min.)
RSFA	Query failures, possible cal errors: 017 - Fail Hi El Zero (zero point out of 020 - Fail Lo El Zero permitted range) 021 - Fail Hi El Slope (slope out of 024 - Fail Lo El Slope permitted range) → <i>Reinstall electrode system</i>
WCOU0	Unfreeze currents, controller, limit values

End of calibration

New electrode system and statistics

If you replace the electrode system and make use of statistics, we recommend to perform a First Calibration. To do so, you must enter the following command after calibration:

WCCASTI The last calibration is taken as First Calibration

Statistics data are erased, the current (most recent) data record is entered as data record 0 (FirstCal) and tolerance band recorder is reset.

Commands for readout of calibration data (see also Pg. 9–23):

RPCA0Z Read out zero point of electrode system

RPCA0S Read out slope of electrode system

The write commands correspond to Cal/Data Entry

10 Product Line and Accessories

Instruments	Ref. No.
pH Transmitter 2800X	pH 2800X
pH Transmitter 2800X-pH	pH 2800X-pH
Mounting Accessories	
Mounting plate, press-drawn section of AlMg3 anodized 20 µm, (not required for direct wall mounting)	ZU 0126
Bracket kit, hot-galvanized clips, stainless-steel screws, anodized aluminum wing nuts, (only in conjunction with ZU 0126 mounting plate)	ZU 0125
Protective hood, aluminum AlMg1 anodized 25 µm, (only in conjunction with ZU 0126 mounting plate)	ZU 0123
Protective polyester case, IP 65, protective Makrolon cover, complete with mounting kit	ZU 0124
Bracket kit for protective case, hot-galvanized clips, stainless-steel screws, anodized aluminum wing nuts, (only in conjunction with ZU 0124)	ZU 0128
CL converter IS/non-IS separation and interface conversion (V 24/20 mA – RS 232 C)	ZU 0098 X
Further Accessories	
Input socket for mounting instead of Pg cable glands	
Input socket for combination or glass electrode with DIN plug	ZU 0160
Input socket for combination or glass electrode with Mettler Toledo SK 7/Schott 9903 screwed plug and equivalent types	ZU 0161

Options	TAN	Ref. No.
Power supply 24 Vac/dc		298
Power supply 115 Vac		363
Controller function (only in conjunction with option 427)	x	353
Logbook	x	354
Nominal zero point and slope of electrode system user-defined	x	356
Buffer set to customer requirements	(x)	357
V 24/20 mA interface (not in conjunction with option 420 or 421)	x	419
Unical [®] interface and Unical [®] sequencing control (not in conjunction with option 419 or 421)	x	420
Fieldbus interface (under preparation)		421
Two additional passive outputs (2 and 3)	x	427
Tolerance band calibration and tolerance band recorder	x	447
Measurement recorder	x	448
Temperature probe Pt 100/NTC 30 k Ω instead of Pt 100/Pt 1000		456
Temperature probe NTC 30 k Ω /Pt 1000 instead of Pt 100/Pt 1000		476
Language selection: German, English, French, Italian and Swedish instead of German, English, French, Italian and Spanish		477

Measurement Error (± 1 Count)	pH value	< 0.01								
	electrode potential	< 0.1 % of measured value								
	ORP	< 0.1 % of measured value								
Impedance Measurement Error (± 1 Count)	glass electrode	< 10 % 2 to 200 MΩ								
		< 20 % < 2 MΩ / > 200 MΩ								
	reference electrode	< 10 % 0.5 to 50 kΩ								
		< 20 % < 0.5 kΩ / > 50 kΩ								
Perm. Cable Capacitance	pH < 2 nF	(approx. 20 m measuring cable length)								
Permissible Voltage ORP + pH (mV)	± 2 V, terminals 1, 2 against terminal 3									
Electrode Standardization	Operating Modes ^{*)}									
	<ul style="list-style-type: none"> ● Calimatic[®] automatic calibration and buffer identification with four fixed buffer sets: <table style="margin-left: 20px; border: none;"> <tr> <td>Mettler Toledo technical trade buffers</td> <td>2.00/4.01/7.00/9.21</td> </tr> <tr> <td>Merck/Riedel de Haën</td> <td>2.00/4.00/7.00/9.00/12.00</td> </tr> <tr> <td>techn. buffers DIN 19267</td> <td>1.09/4.65/6.79/9.23/12.75</td> </tr> <tr> <td>Ciba (94)</td> <td>2.06/4.00/7.00/10.00</td> </tr> </table> ● customer specific buffer sets (option 357) ● input of individual buffer values ● sample calibration ● input of premeasured calibration data ● automatic check of redox electrodes 		Mettler Toledo technical trade buffers	2.00/4.01/7.00/9.21	Merck/Riedel de Haën	2.00/4.00/7.00/9.00/12.00	techn. buffers DIN 19267	1.09/4.65/6.79/9.23/12.75	Ciba (94)	2.06/4.00/7.00/10.00
Mettler Toledo technical trade buffers	2.00/4.01/7.00/9.21									
Merck/Riedel de Haën	2.00/4.00/7.00/9.00/12.00									
techn. buffers DIN 19267	1.09/4.65/6.79/9.23/12.75									
Ciba (94)	2.06/4.00/7.00/10.00									
Calibration Ranges	zero	pH = 6 to 8								
	slope	50 to 61 mV/pH (25 °C)								
	V _{iso}	-200 to +200 mV								
Nominal Electrode Zero and Slope ^{*)} (Option 356)	zero	pH = 0 to 14								
	adjustment range	Δ pH = ± 1								
	slope	25 to 61 mV/pH								
	adjustment range	± 5.5 mV/pH								
	V _{iso}	-1000 to +1000 mV								
	e.g. for Antimony probes									
Temperature Input	-50.0 to +250 °C									
	Pt 100 / Pt 1000 (automatic selection)									
	2- or 3-wire connection									
	Meas. current approx. 4 mA (Pt 100) or approx. 0.4 mA (Pt 1000)									
	for option 456, 476 NTC range: -20 to +130 °C									
Temperature Measurement Error (± 1 Count)	< 0.2 % of measured value ± 0.3 K									
Temperature Compensation pH ^{*)}	automatic	with Pt 100 / Pt 1000 option 456: with Pt 100 / NTC 30 kΩ option 476: with NTC 30 kΩ / Pt 1000								
	manual	-50.0 to +250 °C								
Current Output 1^{*)} EEx ib IIC	0 to 20 mA or 4 to 20 mA, max. 10 V, floating user defined for pH, mV, ORP, rH, °C error message if load is exceeded									
Output Current Error	< 0.25 % of measured value ± 20 μA									
Current Source Function	0.00 mA to 20.50 mA									
Output 2 (passive)^{*)} EEx ib IIC (Option 427)	0 to 20 mA or 4 to 20 mA, floating, supply voltage 1 to 30 V, P _{max} 0.8 W (power supply unit required) user defined for pH, mV, ORP, rH, °C or as continuous controller output error message if supply voltage falls below specification									
Output Current Error	< 0.5 % of measured value ± 20 μA									
Current Source Function	0.00 mA to 20.50 mA									

Defined as Switching Output	switching controller output or limit value output ratings: DC $V_{\max} = 30\text{ V}$; $I_{\max} = 100\text{ mA}$; $P_{\max} = 0.8\text{ W}$ voltage drop: $< 1\text{ V}$	
Defined as OK 1 SPC Controller Input	blocks calibration or starts Unical [®] calibration cycle switching voltage: 2 to 28 V, input current: 10 mA hazardous area ratings: DC $V_{\max} = 30\text{ V}$; $I_{\max} = 100\text{ mA}$; $P_{\max} = 0.8\text{ W}$	
Output 3 (Passive)* EEx ib IIC (Option 427)	0 to 20 mA or 4 to 20 mA, floating, supply voltage 1 to 30 V, $P_{\max} 0.8\text{ W}$ (power supply unit required) user defined for pH, mV, ORP, rH, °C or as continuous controller output error message if supply voltage falls below specifications	
Output Current Error	$< 0.5\%$ of measured value $\pm 20\ \mu\text{A}$	
Current Source Function	0.00 mA to 20.50 mA	
Defined as Switching Output	switching controller output or limit value output ratings: DC $V_{\max} = 30\text{ V}$; $I_{\max} = 100\text{ mA}$; $P_{\max} = 0.8\text{ W}$ voltage drop: $< 1\text{ V}$	
Defined as OK 2 SPC Controller Input	activates maintenance function or starts Unical [®] rinsing cycle switching voltage: 2 to 28 V, input current: 10 mA hazardous area ratings: DC $V_{\max} = 30\text{ V}$; $I_{\max} = 100\text{ mA}$; $P_{\max} = 0.8\text{ W}$	
Beginning/End of Scale* (Current Output 1 to 3) Spans*)	user defined within pH, mV, ORP, rH, °C range	
	pH value	1.00 to 20.00
	electrode potential	100 to 2000 mV
	ORP (redox potential)	100 to 2000 mV
	rH value	10.0 to 200.0
	temperature	10.0 to 300.0 °C
Switching Contacts* EEx ib IIC	3 NAMUR contacts (floating)	functional check warning / maintenance required failure
	contact ratings	DC $< 60\text{ V} / 500\text{ mA} < 10\text{ W}$
	user defined	N/C or N/O, delay for warning and failure, off-delay for functional check
Interface (Optional) EEx ib IIC	V24/20 mA (option 419) transmit loop passive, $V_{\max} 30\text{ V}$, $I_{\max} 47.5\text{ mA}$, $P_{\max} 175\text{ mW}$ receive loop passive, $V_{\max} 30\text{ V}$, $I_{\max} 47.5\text{ mA}$, $P_{\max} 175\text{ mW}$ baud rate 110/150/300/600/1200 data bits/parity 7/even, 7/odd, 8/no or Unical [®] interface (option 420) passive serial 4-wire interface to Unical user-defined 50-step sequencing control monitoring and evaluation of probe checkback messages or fieldbus (under preparation, option 421) bus coupling intrinsically safe, with bus supply of fieldbus interface, transmission rate 31.25 kbauds to IEC 1158-2	

PI Controller (Option 353)	quasi-continuous switching controller via outputs 2 and 3 pulse duration or pulse frequency user defined or continuous controller via outputs 2 and 3 user defined for pH, mV, ORP, rH and °C		
Clock	real-time clock with date, self-contained date format user defined		
Records	for quality management documentation to ISO 9000 ff., retrievable via display and remote interface		
Logbook (Option 354)	recording of	function activations, appearance and disappearance of warning and failure messages, with date and time	storage capacity 200 entries available
Instrument Self Test	test of RAM, EPROM, EEPROM, display and keypad		
Electrode Statistics	electrode data from the last three calibrations and First Calibration		
pH Calibration Record	all relevant data from last pH calibration for documentation to GMP		
Tolerance Band Recorder (Option 447)	registers zero and slope of electrode system and adjusted tolerance band, graphic representation on display		
Data Retention in case of Power Failure	parameters and calibration data		> 10 years (EEPROM)
	logbook, statistics, cal record		> 1 year (lithium battery)
	clock reserve power		> 1 year (lithium battery)
	according to NAMUR NE 32 no battery replacement required		
Explosion Protection	EEx em ib [ia] IIC T6		
Protection Against Electrical Shock	protective separation of all extra-low voltage circuits against power supply and switching contacts to VDE 0100 Part 410 as defined in DIN VDE 0106 Part 101		
RFI Suppression	to EN 50081-1 and EN 50081-2		
Immunity to ESD	to EN 50082-1 and EN 50082-2 and NAMUR EMC recommendation NE 21 for process and laboratory equipment		
Power Supply		AC 230 V	-15 % +10 % < 8 VA 48 to 62 Hz
	optional	AC 115 V	-15 % +10 % < 8 VA 48 to 62 Hz
	or	AC/DC 24V	AC: -15 % +10 % < 8 VA DC: -15 % +20 % < 8 W
	Protection Class I		
Temperature	operating/environmental		-20 to +50 °C
	transport and storage		-20 to +70 °C
Enclosure	case with separate terminal compartment, suitable for outdoor mounting material: polycarbonate (Lexan) protection: IP 65		
Cable Glands	9 Pg-threaded cable glands Pg 13.5		
Dimensions (W x H x D)	304 x 250 x 87 mm		
Weight	approx. 4 kg		

*) user defined 1) Oxidation Reduction Potential 2) doubles every 10 K

EMC Test Records

Declaration of Conformity
Konformitätserklärung
Déclaration de conformité
Declaración de Conformidad
Verklaring de overeenstemming
Dichiarazione di conformità



We/Wir/Nous/Wij/Noi: **Mettler Toledo GmbH, Process**
Im Hackacker 15
CH-8902 Urdorf

declare under our sole responsibility that the product,
erklären, in alleiniger Verantwortung, daß dieses Produkt,
déclarons sous notre seule responsabilité que le produit,
declaramos, bajo nuestra sola responsabilidad, que il producto,
verklaren onder onze verantwoordelijkheid, dat het product,
dichiariamo sotto nostra unica responsabilità, che il prodotto,

pH Transmitter 2800(X)

to which this declaration relates is in conformity with the following standard(s) or other normative document(s).
auf das sich diese Erklärung bezieht, mit der/den folgenden Norm(en) oder Richtlinie(n) übereinstimmt.
auquel se réfère cette déclaration est conforme à la (aux) norme(s) ou au(x) document(s) normatif(s).
al que se refiere esta declaración es conforme a la(s) norma(s) u otro(s) documento(s) normativo(s).
waarnaar deze verklaring verwijst, aan de volende norm(en) of richtlijn(en) beantwoordt.
a cui si riferisce questa dichiarazione è conforme alla/e seguente/i norma/e o documento/i normativo/i.

CE Conformity / CE Konformität / Conformité CE

89/336/EEC EMC Directive / EMV-Richtlinien / Directive concernant la CEM

EN 50081-1, EN 50081-2

EN 50082-1, EN 50082-2

Urdorf 1996

Certificate of Conformity

Physikalisch-Technische Bundesanstalt

Braunschweig und Berlin



(1) **CERTIFICATE OF CONFORMITY**

(2) **PTB No. Ex-96.D.2039**

(TRANSLATION)

(3) This certificate is issued for the electrical apparatus
pH-, pH/pH-, pH-Conductivity-Transmitter type 2700 Opt. ...

(4) manufactured by Mettler-Toledo AG
CH-8902 Urdorf

(5) This electrical apparatus and any acceptable variation thereto is specified in the Schedule to this Certificate of Conformity.

(6) The Physikalisch-Technische Bundesanstalt, being an Approved Certification Body in accordance with article 14 of the Council Directive of the European Communities of December 18, 1975 (76/117/EEC), confirms that this electrical apparatus has been found to comply with the harmonized European Standards

Electrical apparatus for potentially explosive atmospheres

EN 50 014:1977 + A1...A5 (VDE 0170/0171 Part 1/1.87) General Requirements

EN 50 020:1977 + A1...A5 (VDE 0170/0171 Part 7/4.92) Intrinsic Safety "i"

EN 50 019:1977 + A1...A5 (VDE 0170/0171 Part 6/5.92) Increased Safety "e"

EN 50 028:1987 (VDE 0170/0171 Part 9/7.88) Encapsulation "m"

after the apparatus has been successfully subjected to pattern evaluation. The results of this pattern evaluation have been recorded in a confidential test report.

(7) The apparatus marking shall include the code:

EEx em ib [ia] IIC T6

(8) The manufacturer shall be responsible for ensuring that any apparatus bearing the above marking conforms to the test documents specified in the Schedule to this certificate and that the routine verifications and tests prescribed have been carried out successfully.

(9) The electrical apparatus may be marked with the Distinctive Community Mark according to Annex II to the Council Directive of February 6, 1979 (79/196/EEC). A facsimile of this mark is printed on this sheet of the certificate.

By order

Braunschweig, 27.03.1996

Gruber

Techn. Regierungsoberamtsrat





Test certificates without signature and official stamp shall not be valid.
The certificates may be circulated only without alteration.
Extracts or alterations are subject to approval by the Physikalisch-Technische Bundesanstalt.
In case of dispute, the German text shall prevail.

Physikalisch-Technische Bundesanstalt

1. SUPPLEMENT
to Certificate of Conformity PTB No. Ex-96.D.2039
(TRANSLATION)

manufactured by Mettler-Toledo AG
CH-8902 Urdorf

In future the type designation of the pH-, pH/pH-, pH-Conductivity-Transmitter type 2700 Opt. ... will be changed into type 2800 X Opt. all other data remain unchanged

By order   Braunschweig, 18.06.1996

Dr.-Ing. Johannsmeyer
Oberregierungsrat

EEx em ib [ia] IIC T6 Sheet 1/1

Physikalisch-Technische Bundesanstalt

SCHEDULE
to Certificate of Conformity PTB No. Ex-96.D.2039

The pH-, pH/pH-, pH-Conductivity-Transmitter type 2700 Opt. ... is used for recording and processing of electrochemical values. The power supply unit has been designed in the type of protection "Encapsulation" ("m").
The maximum permissible ambient temperature is 50 °C.

Electrical data

Auxiliary supply circuit type of protection "Increased Safety" EEx e
(terminals 26, 27, 28, 29) 230 V AC -15% +10%, ca. 8 VA
115 V AC -15% +10%, ca. 8 VA
100 V AC -15% +10%, ca. 8 VA
24 V AC/DC -15% +10%, ca. 8 VA respectively
-15% +20%, ca. 8 W

pH-measuring circuit type of protection "Intrinsic Safety" EEx ia IIC
1(A) (terminals 1, 2, 3) and with the following maximum values for each circuit:
2(B) (terminals 3, 4, 5) output characteristic: linear
 $U_o = 12 \text{ V}$
 $I_o = 13 \text{ mA}$
 $P_o = 20 \text{ mW}$
 $R_i = 478 \text{ } \Omega$
 $C_i = 24 \text{ nF}$
 $L_i = \text{negligibly small}$
maximum permissible external capacitance = 440 nF
maximum permissible external inductance = 5 mH

LF-measuring circuit type of protection "Intrinsic Safety" EEx ia IIC
(terminals 3, 4, 5) with the following maximum values:
output characteristic: linear
 $U_o = 6,2 \text{ V}$
 $I_o = 12 \text{ mA}$
 $P_o = 19 \text{ mW}$
 $R_i = 520 \text{ } \Omega$
 $C_i = 1,2 \text{ } \mu\text{F}$
 $L_i = \text{negligibly small}$
maximum permissible external capacitance = 500 nF
maximum permissible external inductance = 2 mH

Temperature measuring circuit type of protection "Intrinsic Safety" EEx ia IIC
(terminals 6, 7, 8) with the following maximum values:
output characteristic: linear
 $U_o = 12 \text{ V}$
 $I_o = 4 \text{ mA}$
 $P_o = 7 \text{ mW}$
 $R_i = 1,55 \text{ k}\Omega$
 $C_i = 55 \text{ nF}$
 $L_i = 0,22 \text{ mH}$
maximum permissible external capacitance = 475 nF
maximum permissible external inductance = 1,8 mH

Sheet 1/3

Physikalisch-Technische Bundesanstalt

Schedule to Certificate of Conformity PTB No. Ex-96.D.2039

Output circuit 1 type of protection "Intrinsic Safety" EEx ib IIC
(terminals 9, 10) with the following maximum values:
output characteristic: trapezoidal
 $U_o = 14,3 \text{ V}$
 $I_o = 89 \text{ mA}$
 $P_o = 380 \text{ mW}$
 $R_i = 190 \text{ } \Omega$
 $C_i = 100 \text{ nF}$
 $L_i = \text{negligibly small}$
maximum permissible external capacitance = 580 nF
maximum permissible external inductance = 5 mH

or

output characteristic: rectangular
 $U_o = 14,3 \text{ V}$
 $I_o = 30 \text{ mA}$
 $P_o = 360 \text{ mW}$
 $R_i = 190 \text{ } \Omega$
 $C_i = 100 \text{ nF}$
 $L_i = \text{negligibly small}$
maximum permissible external capacitance = 62 nF
maximum permissible external inductance = 0,5 mH

Output circuit 2,3 type of protection "Intrinsic Safety" EEx ib IIC
(terminals 11, 12 and 13, 14) only for connection to certified intrinsically safe circuits
with the following maximum values:
 $U_i = 30 \text{ V}$
 $I_i = 100 \text{ mA}$
 $P_i = 0,8 \text{ W}$
 $C_i = 50 \text{ nF}$
 $L_i = \text{negligibly small}$

Interface circuit type of protection "Intrinsic Safety" EEx ib IIC
Rx/D and screen only for connection to certified intrinsically safe circuits
(terminals 15, 16, 19) with the following maximum values:
 $U_i = 30 \text{ V}$
 $I_i = 47,5 \text{ mA}$
 $P_i = 175 \text{ mW}$
 $C_i = 25 \text{ nF}$
 $L_i = \text{negligibly small}$

Interface circuit type of protection "Intrinsic Safety" EEx ib IIC
Tx/D and screen only for connection to certified intrinsically safe circuits
(terminals 17, 18, 19) with the following maximum values:
 $U_i = 30 \text{ V}$
 $I_i = 100 \text{ mA}$
 $P_i = 350 \text{ mW}$
 $C_i = 25 \text{ nF}$
 $L_i = \text{negligibly small}$

Sheet 2/3



Physikalisch-Technische Bundesanstalt

Schedule to Certificate of Conformity PTB No. Ex-96.D.2039

Switch output circuit 1,2,3 type of protection "Intrinsic Safety" EEx ib IIC
(terminals 20, 21 and 22, 23 only for connection to certified intrinsically safe circuits
and 24,25) with the following maximum values:
 $U_i = 50 \text{ V}$
 $I_i = 500 \text{ mA}$
 $P_i = 10 \text{ W}$
 $C_i = \text{negligibly small}$
 $L_i = \text{negligibly small}$

The auxiliary supply circuit is safely galvanically separated from all intrinsically safe circuits up to a peak value of 375 V of the nominal voltage. The pH-measuring circuit, the LF-measuring circuit and the temperature measuring circuit are galvanically connected. The intrinsically safe circuits are safely galvanically separated from each other and from the circuits mentioned above up to a peak value of 60 V of the nominal voltage.

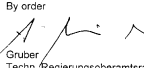
Test document
Certificate of Conformity PTB No. Ex-96.D.2038

By order   Braunschweig, 27.03.1996

Gruber
Techn. Regierungsberatersrat

Sheet 3/3

Blank page.

12 Buffer Charts

"Mettler Toledo" Mettler Toledo technical buffers, (correspond to Ingold technical buffers)

°C	pH			
0	2.03	4.01	7.12	9.52
5	2.02	4.01	7.09	9.45
10	2.01	4.00	7.06	9.38
15	2.00	4.00	7.04	9.32
20	2.00	4.00	7.02	9.26
25	2.00	4.01	7.00	9.21
30	1.99	4.01	6.99	9.16
35	1.99	4.02	6.98	9.11
40	1.98	4.03	6.97	9.06
45	1.98	4.04	6.97	9.03
50	1.98	4.06	6.97	8.99
55	1.98	4.08	6.98	8.96
60	1.98	4.10	6.98	8.93
65	1.99	4.13	6.99	8.90
70	1.99	4.16	7.00	8.88
75	2.00	4.19	7.02	8.85
80	2.00	4.22	7.04	8.83
85	2.00	4.26	7.06	8.81
90	2.00	4.30	7.09	8.79
95	2.00	4.35	7.12	8.77

"Merck/Riedel" Merck buffer Titrisoles and ready-to-use buffer solutions,
Riedel buffer Fixanales and ready-to-use buffer solutions

°C	pH				
0	2.01	4.05	7.13	9.24	12.58
5	2.01	4.04	7.07	9.16	12.41
10	2.01	4.02	7.05	9.11	12.26
15	2.00	4.01	7.02	9.05	12.10
20	2.00	4.00	7.00	9.00	12.00
25	2.00	4.01	6.98	8.95	11.88
30	2.00	4.01	6.98	8.91	11.72
35	2.00	4.01	6.96	8.88	11.67
40	2.00	4.01	6.95	8.85	11.54
45	2.00	4.01	6.95	8.82	11.44
50	2.00	4.00	6.95	8.79	11.33
55	2.00	4.00	6.95	8.76	11.19
60	2.00	4.00	6.96	8.73	11.04
65	2.00	4.00	6.96	8.72	10.97
70	2.01	4.00	6.96	8.70	10.90
75	2.01	4.00	6.96	8.68	10.80
80	2.01	4.00	6.97	8.66	10.70
85	2.01	4.00	6.98	8.65	10.59
90	2.01	4.00	7.00	8.64	10.48
95	2.01	4.00	7.02	8.64	10.37

"DIN" Technical buffer solutions to DIN 19 267

°C	pH				
0	1.08	4.67	6.89	9.48	13.95*
5	1.08	4.67	6.87	9.43	13.63*
10	1.09	4.66	6.84	9.37	13.37
15	1.09	4.66	6.82	9.32	13.16
20	1.09	4.65	6.80	9.27	12.96
25	1.09	4.65	6.79	9.23	12.75
30	1.10	4.65	6.78	9.18	12.61
35	1.10	4.65	6.77	9.13	12.45
40	1.10	4.66	6.76	9.09	12.29
45	1.10	4.67	6.76	9.04	12.09
50	1.11	4.68	6.76	9.00	11.98
55	1.11	4.69	6.76	8.96	11.79
60	1.11	4.70	6.76	8.92	11.69
65	1.11	4.71	6.76	8.90	11.56
70	1.11	4.72	6.76	8.88	11.43
75	1.11	4.73	6.77	8.86	11.31
80	1.12	4.75	6.78	8.85	11.19
85	1.12	4.77	6.79	8.83	11.09
90	1.13	4.79	6.80	8.82	10.99
95	1.13*	4.82*	6.81*	8.81*	10.89*

* extrapolated

"Ciba (94)" Ciba (94) buffers,
Nominal values: 2.06, 4.00, 7.00, 10.00

°C	pH			
0	2.04	4.00	7.10	10.30
5	2.09	4.02	7.08	10.21
10	2.07	4.00	7.05	10.14
15	2.08	4.00	7.02	10.06
20	2.09	4.01	6.98	9.99
25	2.08	4.02	6.98	9.95
30	2.06	4.00	6.96	9.89
35	2.06	4.01	6.95	9.85
40	2.07	4.02	6.94	9.81
45	2.06	4.03	6.93	9.77
50	2.06	4.04	6.93	9.73
55	2.05	4.05	6.91	9.68
60	2.08	4.10	6.93	9.66
65	2.07	4.10	6.92	9.61
70	2.07	4.11	6.92	9.57
75	2.04	4.13	6.92	9.54
80	2.02	4.15	6.93	9.52
85	2.03	4.17	6.95	9.47
90	2.04	4.20	6.97	9.43
95	2.05*	4.22*	6.99*	9.38*

* extrapolated

13 Unical[®] Programs

Unical[®] Program (dual–point calibration)

Parameter	Interval	Remarks
cal interval	024.0 h	executes all program steps
rinsing interval	001.0 h	executes marked program steps (■)

Program Name		PH2/2 2–point pH calibration		(factory setting)	
Programmer		Mettler–Toledo			
Date		3–28–95			
No	Output	Input	Time	Display Text	Remarks
■ 01	○A8 pos cal	E2 pos cal	0006 s	Probe Cal	
■ 02	●A2 water	E3 water	0010 s	Rinsing Water	
■ 03	○A2 water	—	0002 s	Rinsing Water	
□ 04	●A1 level	—	0003 s	Level Measurement	
□ 05	●A5 pump 1	E5 buffer 1	0005 s	Buffer 1	suck in buffer
□ 06	○A5 pump 1	—	0005 s	Buffer 1	press buffer
□ 07	cal buffer 1				Calimatic [®] 1st buffer
□ 08	●A2 water	E3 water	0005 s	Rinsing Water	
□ 09	○A2 water	—	0002 s	Rinsing Water	
□ 10	●A6 pump 2	E6 buffer 2	0005 s	Buffer 2	suck in buffer
□ 11	○A6 pump 2	—	0005 s	Buffer 2	press buffer
□ 12	○A1 level	—	0001 s	Level Measurement	
□ 13	cal buffer 2				Calimatic [®] 2nd buffer
□ 14	●A2 water	E3 water	0005 s	Rinsing Water	
□ 15	○A2 water	—	0002 s	Rinsing Water	
■ 16	wait position				rest position
■ 17	●A2 water	E3 water	0008 s	Rinsing Water	
■ 18	○A2 water	—	0002 s	Rinsing Water	
■ 19	●A8 pos meas	E1 pos meas	0006 s	Probe Measurement	
■ 20	end of program				

Unical[®] Program (single-point calibration)

Parameter	Interval	Remarks
cal interval	024.0 h	executes all program steps
rinsing interval	001.0 h	executes marked program steps (■)

Program Name	:	PH1/2 1-point pH calibration			
Programmer	:	Mettler-Toledo			
Date	:	3-28-95			
No	Output	Input	Time	Display Text	Remarks
■ 01	○A8 pos cal	E2 pos cal	0006 s	Probe Cal	
■ 02	●A2 water	E3 water	0010 s	Rinsing Water	
■ 03	○A2 water	—	0002 s	Rinsing Water	
□ 04	●A1 level	—	0003 s	Level Measurement	
□ 05	●A5 pump 1	E5 buffer 1	0005 s	Buffer 1	suck in buffer
□ 06	○A5 pump 1	—	0005 s	Buffer 1	press buffer
□ 07	○A1 level	—	0001 s	Level Measurement	
□ 08	cal buffer 1				Calimatic [®] 1st buffer
■ 09	wait position				rest position
■ 10	●A2 water	E3 water	0008 s	Rinsing Water	
■ 11	○A2 water	—	0002 s	Rinsing Water	
■ 12	●A8 pos meas	E1 pos meas	0006 s	Probe Measurement	
■ 13	end of program				

Unical® Program (ORP check)

Parameter	Interval	Remarks
cal interval	024.0 h	executes all program steps
rinsing interval	001.0 h	executes marked program steps (■)

Program Name		: RDX/2 ORP Check			
Programmer		: Mettler–Toledo			
Date		: 3–28–95			
No	Output	Input	Time	Display Text	Remarks
■ 01	○A8 pos cal	E2 pos cal	0006 s	Probe Cal	
■ 02	●A2 water	E3 water	0010 s	Rinsing Water	
■ 03	○A2 water	—	0002 s	Rinsing Water	
□ 04	●A1 level	—	0003 s	Level Measurement	
□ 05	●A5 pump 1	E5 buffer 1	0005 s	Conditioning Sol	suck in conditioning solution
□ 06	○A5 pump 1	—	0005 s	Conditioning Sol	press conditioning solution
□ 07	empty step	—	0015 s	Lead Time	exposure time
□ 08	●A2 water	E3 water	0010 s	Rinsing Water	
□ 09	○A2 water	—	0002 s	Rinsing Water	
□ 10	●A6 pump 2	E6 buffer 2	0005 s	Redox Buffer	suck in redox buffer
□ 11	○A6 pump 2	—	0005 s	Redox Buffer	press redox buffer
□ 12	○A1 level	—	0001 s	Level Measurement	
□ 13	ORP check				start ORP check
■ 14	wait position				rest position
■ 15	●A2 water	E3 water	0008 s	Rinsing Water	
■ 16	○A2 water	—	0002 s	Rinsing Water	
■ 17	●A8 pos meas	E1 pos meas	0006 s	Probe Measurement	
■ 18	end of program				

Unical[®] Program (original for copy)

Parameter	Interval	Remarks
cal interval	h	
rinsing interval	h	

Program Name : Programmer : Date :	Page 1
------------------------------------------	--------

No.	Output	Input	Time	Display Text	Remarks
<input type="checkbox"/> 01			s		
<input type="checkbox"/> 02			s		
<input type="checkbox"/> 03			s		
<input type="checkbox"/> 04			s		
<input type="checkbox"/> 05			s		
<input type="checkbox"/> 06			s		
<input type="checkbox"/> 07			s		
<input type="checkbox"/> 08			s		
<input type="checkbox"/> 09			s		
<input type="checkbox"/> 10			s		
<input type="checkbox"/> 11			s		
<input type="checkbox"/> 12			s		
<input type="checkbox"/> 13			s		
<input type="checkbox"/> 14			s		
<input type="checkbox"/> 15			s		
<input type="checkbox"/> 16			s		
<input type="checkbox"/> 17			s		
<input type="checkbox"/> 18			s		
<input type="checkbox"/> 19			s		
<input type="checkbox"/> 20			s		
<input type="checkbox"/> 21			s		
<input type="checkbox"/> 22			s		
<input type="checkbox"/> 23			s		
<input type="checkbox"/> 24			s		
<input type="checkbox"/> 25			s		

Program Name : Page 2
 Programmer :
 Date :

No.	Output	Input	Time	Display Text	Remarks
<input type="checkbox"/> 26			s		
<input type="checkbox"/> 27			s		
<input type="checkbox"/> 28			s		
<input type="checkbox"/> 29			s		
<input type="checkbox"/> 30			s		
<input type="checkbox"/> 31			s		
<input type="checkbox"/> 32			s		
<input type="checkbox"/> 33			s		
<input type="checkbox"/> 34			s		
<input type="checkbox"/> 35			s		
<input type="checkbox"/> 36			s		
<input type="checkbox"/> 37			s		
<input type="checkbox"/> 38			s		
<input type="checkbox"/> 39			s		
<input type="checkbox"/> 40			s		
<input type="checkbox"/> 41			s		
<input type="checkbox"/> 42			s		
<input type="checkbox"/> 43			s		
<input type="checkbox"/> 44			s		
<input type="checkbox"/> 45			s		
<input type="checkbox"/> 46			s		
<input type="checkbox"/> 47			s		
<input type="checkbox"/> 48			s		
<input type="checkbox"/> 49			s		
<input type="checkbox"/> 50			s		

Blank page.

14 Appendix



Warning

Remember that the voltage across accessible parts of the open apparatus may be dangerous to life.

If opening the apparatus is inevitable, it shall first be disconnected from all voltage sources.

Make sure that the mains plug has been pulled out.

Operations on an opened apparatus shall be carried out only by a skilled person who is aware of the hazard involved.

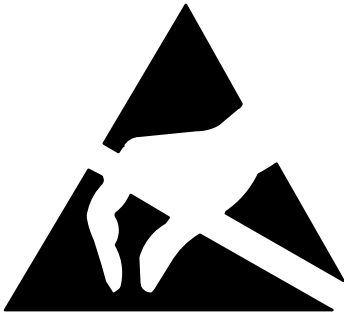

Caution

Observe the handling precautions for ESD sensitive components when acting on the opened apparatus!

PROM Replacement

You need:

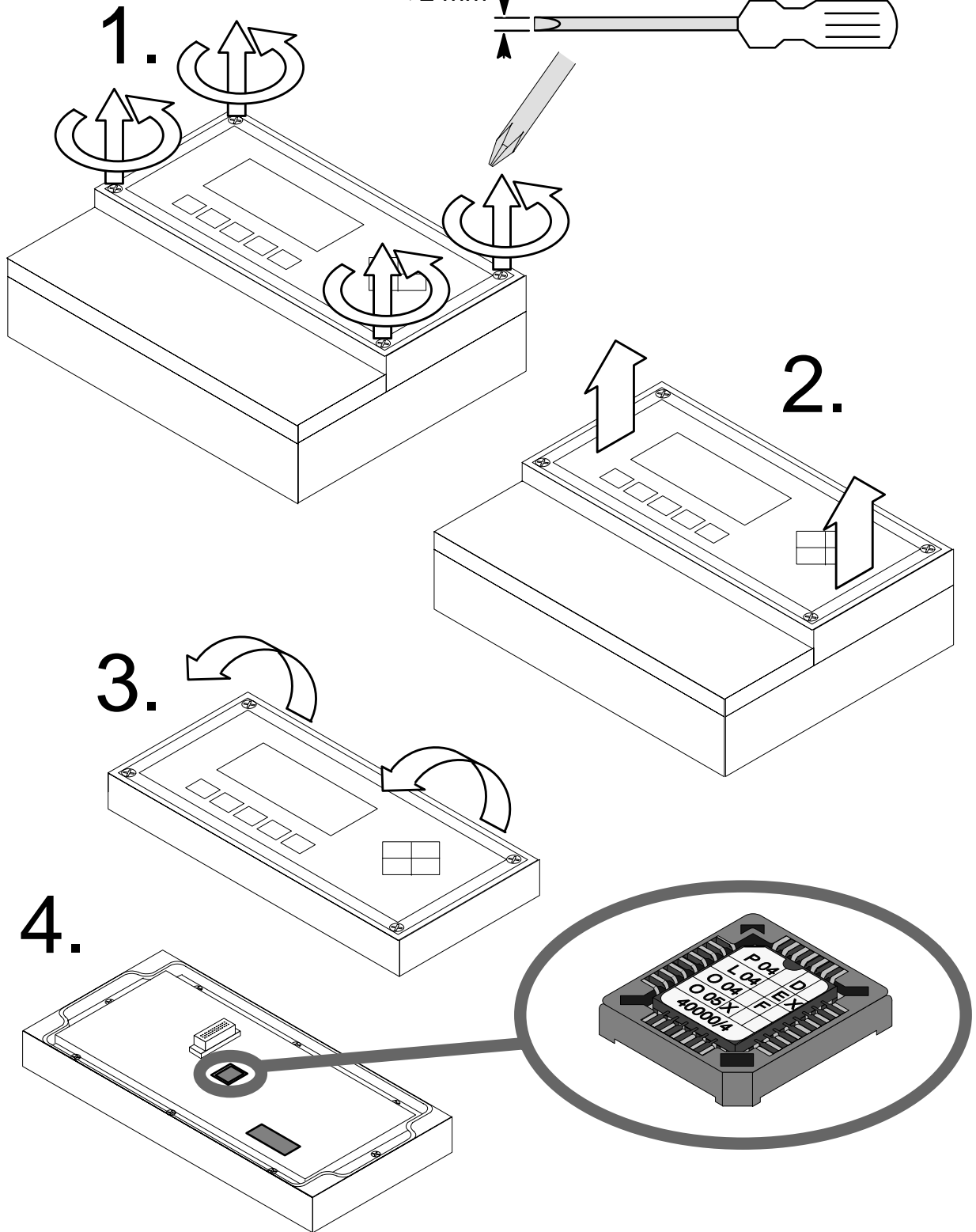
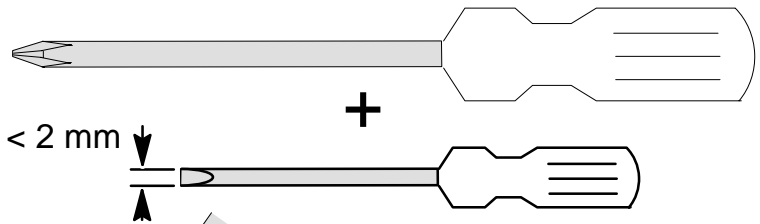

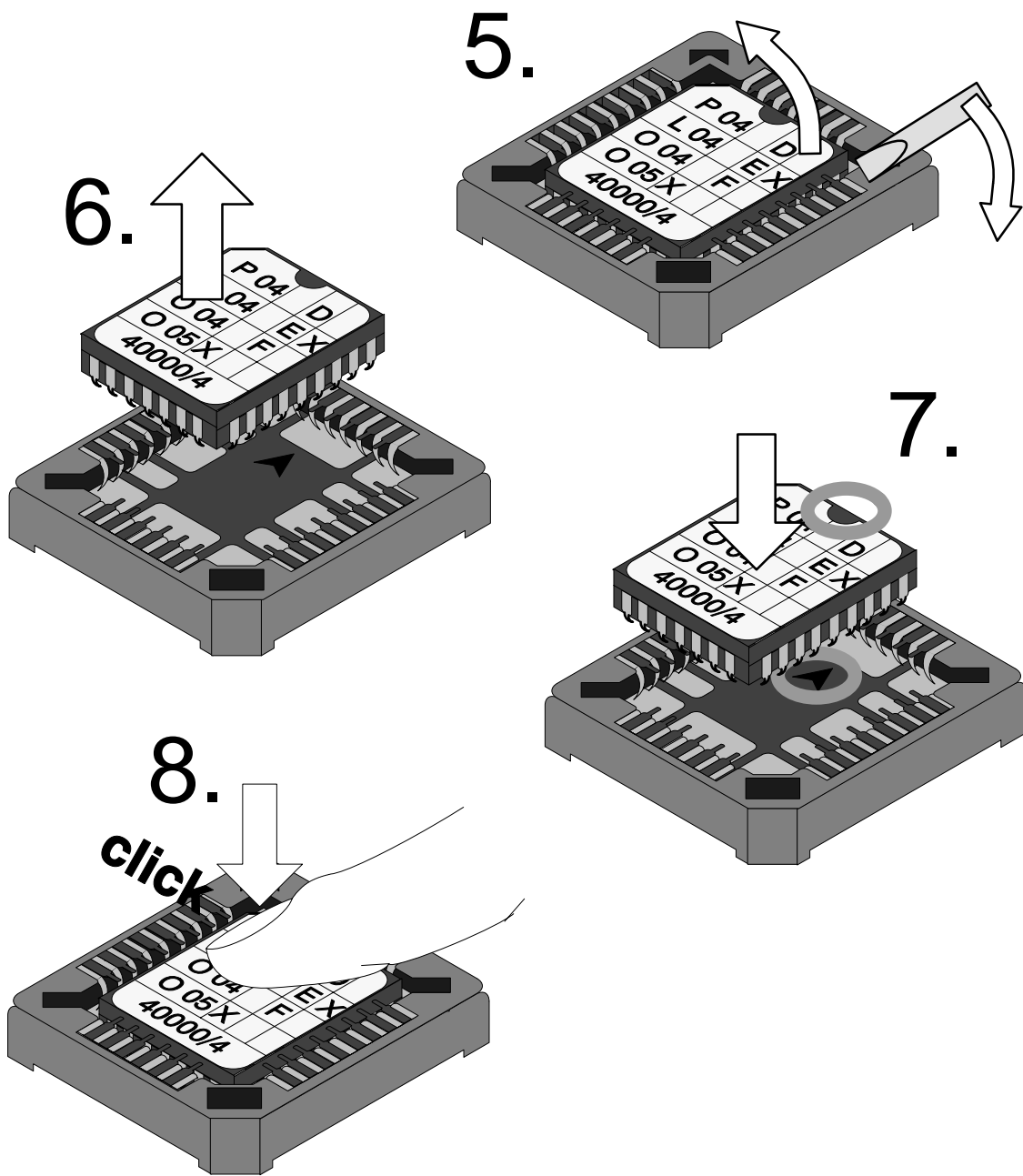

9. Remount the instrument in reverse sequence.



If you have replaced the upper part of the enclosure, all parameters must be set again.

Blank page.

15 Technical Terms

3–wire connection	Connection of the Pt 100/Pt 1000 temperature probe with a (third) sense line to compensate for the lead resistances; required for exact temperature measurement with long leads.
additional display	Two small displays that appear at the lower left and right sides of the main display during measuring mode. The measured variables displayed can be selected using ▲ / ▼ and ◀ / ▶.
Administrator level	"adm" – menu level of parameter setting. All instrument settings and the passcodes can be edited.
administrator passcode	Protects access to Administrator level; can be edited on the Administrator level
alarm limit	For each measured variable, you can define high and low warning and failure limits, respectively. Alarm can be activated individually for each variable. When an alarm limit is exceeded, an error message will be displayed and the corresponding NAMUR contact be activated.
auxiliary electrode	Metallic rod (e.g. platinum), required for monitoring the reference electrode impedance
buffer set	Contains a selection of buffer solutions for automatic calibration using Knick Calimatic®. The buffer set must be entered.
cal	Menu key for Calibration menu
Calibration menu	Menu for calibrating the Process Unit
calibration passcode	Protects access to calibration; can be edited or disabled on the Administrator level
calibration record	The calibration record provides all relevant data of the last calibration for documentation according to GMP.
calibration sequence	From the Calibration menu, you can select four sequences: automatic calibration with Calimatic®, calibration with manual entry of buffer values, data entry of premeasured electrode systems, sample calibration.
cal timer	Counts the time passed since the last calibration. Cal timer count can be monitored via alarm limits.
cal tolerance band	Tolerance range for zero and slope of the pH electrode system. The new calibration values are only taken over if a tolerance limit has been exceeded.

combination electrode	Glass and reference electrode combined into one package
controlled variable	User defined variable that acts on the controller
cursor keys	◀ and ▶ – select entry positions or digits during number entry.
diag	Menu key for Diagnostics menu
Diagnostics menu	Displays all relevant information on instrument status
electrode statistics	The electrode statistics provide the electrode data of the last three calibrations and the First Calibration.
electrode system slope	Specified in mV/pH; is different for each electrode system and changes with age and wear
enter	Key for confirming entries
equipotential bonding electrode	Connects measured solution to measuring circuit of Process Unit
failure	Alarm message and NAMUR contact; indicates that equipment does not function properly or that certain process parameters have reached a critical value. Failure is <i>not</i> enabled during "functional check".
feed time alarm	Monitors time during which the controller output is at 100 %
First Calibration	During First Calibration, the electrode data are stored as reference values for electrode statistics.
functional check	NAMUR contact – always enabled when the Process Unit does <i>not</i> output the selected measured value
GMP	Good Manufacturing Practice: guidelines for performance and documentation of procedures in manufacturing.
information display	Information text for operator guidance or indication of instrument status; marked with i .
interval	Time from beginning of one rinsing cycle until beginning of the next rinsing cycle, user defined
isothermal intersection potential	The isothermal intersection point is the point of intersection between two calibration lines at two different temperatures. The potential difference between the electrode system zero point and this intersecting point is the isothermal intersection potential " V_{ISO} ". It may cause measuring errors depending on the temperature. These measuring errors can be compensated by defining the " V_{ISO} " value. These measuring errors are avoided by calibrating at measuring temperature or at an invariable temperature.

language selection	On the Parameter Setting level you can select the operating language of the unit. Language can be selected without passcode entry.
limit contacts	Controlled by a user-defined measured value. Are activated when the value falls below or exceeds the limit, depending on the user-defined effective direction
logbook	The logbook shows the last 200 events with date and time, e.g. calibrations, warning and failure messages, power failure etc. This permits quality management documentation to ISO 9000.
main display	Large measurement display in measuring mode. You can select a measured variable to be displayed.
maint	Menu key for Maintenance menu
Maintenance menu	The Maintenance menu comprises all functions for maintaining the sensors and adjusting connected measuring equipment.
maintenance passcode	Protects access to maintenance, can be edited or disabled on the Administrator level
manipulated variable	Controller output – controls outputs 2 and 3
meas	Menu key – allows return to measuring mode from all other menus.
measurement recorder	Two-channel recorder for optical representation of the process sequence on the system display. For each channel you can define one measured variable.
measuring mode	When no menu function is activated, the instrument is in measuring mode. The selected measured value is output. Pressing meas always returns you to measuring mode.
message list	The message list shows the number of currently activated messages and displays the individual warning or failure messages in plaintext.
menu	Pressing a menu key (cal , diag , maint , or par) gives access to a menu, from which you can select the corresponding functions.
menu level	The menu is divided into several menu levels. You can switch between different levels by pressing the menu key or the cursor keys ◀ and ▶.
mode selector	The mode selector on the Unical® makes it possible to switch back and forth between "Run" (normal operation) and "Service" (probe in "Rinsing" position, remote control switched off and electrode can be replaced).

NAMUR	German committee for measurement and control standards in chemical industry
NAMUR contacts	"functional check", "warning" and "failure" – indicate status of measured variable and Process Unit
Operator level	"opl" – menu level of parameter setting. You can edit the instrument settings that have been enabled on the Administrator level.
operator passcode	Protects access to the Operator level; can be edited or disabled on the Administrator level
ORP	Oxidation Reduction Potential – measured across reference electrode and an auxiliary (platinum) electrode
ORP check	Checks the running-in behavior of the redox electrode system under defined conditions. To do so, you can enter testing difference and testing time.
par	Menu key for Parameter Setting menu
Parameter Setting menu	The Parameter Setting menu is divided into three submenus: Viewing level (view), Operator level (opl) and Administrator level (adm).
parameter setting step	Input step in a submenu during which a parameter can be entered or edited
passcode protection	The passcode protection protects access to calibration, maintenance, Operator and Administrator level. The passcodes can be edited or disabled on the Administrator level.
pH electrode system	A pH electrode system consists of glass and reference electrode. If the two electrodes are combined in a single package, they are called combination electrode.
point of measurement	Can be defined for identifying the Process Unit; can be displayed in the diag menu or read out via remote interface
pulse suppression	To increase immunity to interference, transient interferences are suppressed by a disconnectable input filter, while slow changes of the measured value are immediately detected.
recorder	See measurement recorder
remote calibration probe	See Unical [®]
remote calibration probe program	User-defined sequence for rinsing and cleaning the pH electrode system, see also Unical [®] program.
response time	Time from start of a calibration step until stabilization of the electrode system potential

rinsing program	User-defined procedure for rinsing the pH electrode with the Unical [®] remote calibration probe, only marked program steps are executed.
scrolling key	▲ and ▼ – for selecting menu lines or entering numeric digits
service position	The mode selector on the Unical [®] remote calibration probe has been set to "Service" (probe in "Rinsing" position, remote control switched off and electrode can be replaced).
TAN	Transaction number for later equipment with software options.
temperature coefficient	With temperature compensation enabled, the temperature coefficient is used to convert the measured value to the respective value at reference temperature.
temperature compensation	Serves for referring the measured value to a reference temperature.
tolerance band recorder	The tolerance band recorder displays the 45 last pH calibrations graphically or as table. This allows to draw conclusions on electrode life and the required calibration intervals.
Unical[®]	Remote calibration probe for automatic rinsing, cleaning and calibration of the pH electrode system. With option 420, it can be remote controlled via pH Transmitter 2800X.
Viewing level	"view" – menu level of parameter setting; display of all configuration settings, no editing possible
wait position	Unical [®] program: user-defined position of the probe during menu "Meas. Point maint." or while OK2 input is active.
warning (maintenance required)	Alarm message and NAMUR contact; means that measuring equipment still operates properly but should be maintained, or that certain process parameters have reached a value that requires intervention Warning is <i>not</i> enabled during "functional check".
zero point	pH value at which the pH electrode system delivers a voltage of 0. Zero point is different for each electrode system and changes with age and wear.

Blank page.

16 Index

3-way mixing valve, 4-17

3-wire connection, definition, 15-1

A

additional display
definition, 15-1
interface commands, 9-10
measured variables, 4-3

Administrator level, 4-2
definition, 15-1

administrator passcode, 4-33
definition, 15-1

alarm, interface commands, 9-17

alarm limit, definition, 15-1

alarm settings, 4-19
interface commands, 9-17

appendix, 14-1

auxiliary electrode, definition, 15-1

B

bracket kit, 1-1

buffer charts, 12-1

buffer set
definition, 15-1
parameter setting, 4-6

C

cal, definition, 15-1

cal timer, 4-21
definition, 15-1

cal timer alarm, 4-20

cal tolerance band, 4-7, 5-7, 5-9, 6-2, 15-1
interface commands, 9-12

calibration, 5-1
data entry of premeasured electrodes, 5-10
freeze outputs, 5-6, 5-8
interface commands, 9-22
manual entry of buffer values, 5-8
monitoring functions, 5-1
ORP check, 5-11
sampling, 5-10
Unical, 5-13

calibration commands, interface commands,
9-23

calibration example, interface commands, 9-25

Calibration menu, 5-2
definition, 15-1

calibration passcode, definition, 15-1

calibration program, 7-2

calibration record, 6-1
definition, 15-1
interface commands, 9-7

calibration sequence, definition, 15-1

Calimatic, 5-6, 7-2
define buffer set, 4-6

Calimatic buffer set, 5-6
interface commands, 9-12

Certificate of Conformity, 11-6

checkback Unical, 4-29

cleaning, 1-8

clock
interface commands, 9-20, 9-23
setting, 4-30

COMMAND, interface commands, 9-23

conditioning solution, 5-11

controlled variable, definition, 15-2

controller, 4–14
beginning of control, 4–15
control characteristic, 4–15
controlled variable, 4–14
end of control, 4–15
interface commands, 9–16, 9–24
manipulated variable, 4–15
manual, 7–3
parameter setting, error messages, 4–18
pulse frequency controller, 4–17
pulse length controller, 4–17

corner point, 4–15

current output 1, 4–12
interface commands, 9–13

current output 2, interface commands, 9–14

current output 3, interface commands, 9–14

current outputs 2 and 3, 4–12

current source function, 7–2
interface commands, 9–24

cursor key, definition, 15–2

D

date, interface commands, 9–20, 9–23

date format, 4–30

deadband, 4–13

delay time, 4–23

delta function
interface commands, 9–13
setting, 4–11

DEVICE, interface commands, 9–23

device description, 6–4

device diagnostics, 4–30, 6–5
interface commands, 9–20, 9–23

diag, definition, 15–2

Diagnostics menu, definition, 15–2

display, viewing angle adjustment, 4–4

dual–point calibration, 5–5

E

effective direction, 4–13

electrode monitoring, 2–5, 4–21

electrode record, 6–1

electrode statistics, 6–2
definition, 15–2
interface commands, 9–6

electrode system slope, definition, 15–2

EMC test records, 11–5

enter, definition, 15–2

equipotential bonding electrode, definition,
15–2

error messages, 7–1

F

factory setting, reset to, 4–3

failure, 4–23
definition, 15–2

feed time alarm, definition, 15–2

First Calibration, 5–3, 5–13
definition, 15–2

functional check, 4–22
definition, 15–2

G

GMP, definition, 15–2

H

hysteresis, 4–13

I

impedance measurement, information, 4–22

input filter, 4–4
interface commands, 9–11

installation, 1–7

interface
command set, 9–4
transmission behavior, 9–3
write protection, 4–25

interface commands, 9–1

interval, definition, 15–2

isothermal intersection potential, explanation, 15–2

L

language selection, 4–1, 15–3
interface commands, 9–9

limit contacts, 4–13
definition, 15–3
effective direction, 4–13
hysteresis, 4–13

limit value output 2, interface commands, 9–15

limit value output 3, interface commands, 9–15

limit values, interface commands, 9–6

logbook, 6–4
definition, 15–3
interface commands, 9–8

M

main display, definition, 15–3

maint, definition, 15–3

maintenance, 1–8

Maintenance menu, definition, 15–3

maintenance passcode, definition, 15–3

manipulated variable, definition, 15–3

marker setting, 4–2

meas, definition, 15–3

measurement display, 4–3
interface commands, 9–9

measurement point
interface commands, 9–20
note, 4–30

measurement point maintenance, 7–1
interface commands, 9–24

measurement recorder, 4–31, 15–3
average, 4–32
interface commands, 9–8, 9–20
max value, 4–32
min value, 4–32
snapshot, 4–32

measuring mode, 3–2
definition, 15–3

memory test, 4–30

menu, definition, 15–3

menu level, definition, 15–3

menu operation, 3–6
keypad assignments, 3–6

menu structure, 3–5

message list, 6–1, 7–2
definition, 15–3

mode selector, definition, 15–3

mounting, 1–1

mounting plate, 1–1

mV alarm, 4–20

N

NAMUR, definition, 15–4

NAMUR contacts, 4–22
definition, 15–4
interface commands, 9–18

neutral zone, 4–15

new el data, 4–7

nominal slope
 interface commands, 9–13
 parameter setting, 4–8

nominal zero, parameter setting, 4–8

nominal zero point, interface commands, 9–13

note, 4–30

O

off–delay, 4–23

OK 1/OK 2, 4–12

OK inputs, 4–19
 interface commands, 9–17

old el data, 4–7

Operator level, 4–2
 definition, 15–4

operator passcode, definition, 15–4

options, release, 4–34

optocoupler inputs, 4–12

ORP, definition, 15–4

ORP alarm, 4–20

ORP check, 4–8, 5–11, 15–4
 interface commands, 9–12, 9–24

ORP measurement, 2–6
 simultaneous with pH value, 2–7
 wiring, 2–6

output current 1, interface commands, 9–13

output current 2, interface commands, 9–14

output current 3, interface commands, 9–14

outputs 2 + 3, interface commands, 9–14

P

par, definition, 15–4

parameter setting
 Administrator level, 4–2
 interface commands, 9–24
 marker setting, 4–2
 factory setting, 4–3
 interface commands, 9–9
 language selection, 4–1
 Operator level, 4–2
 Viewing level, 4–1

Parameter Setting menu, definition, 15–4

parameter setting step, definition, 15–4

passcode entry, 4–32

passcode protection, definition, 15–4

passcodes, factory settings, 4–33

pH alarm, 4–20

pH electrode system, definition, 15–4

pH measurement
 simultaneous with ORP measurement, 2–7
 wiring, 2–3

point of measurement
 definition, 15–4
 interface commands, 9–20
 note, 4–30

power supply, 1–7

PROM, replacement, 14–2

protective case, 1–1
 mounting, 1–5

protective hood, 1–1

pulse suppression, 15–4

R

recorder, definition, 15–4

remote calibration probe, 4–26
 description, 4–26

remote calibration probe program, 15–4

remote interface
 command set, 9–4
 interface commands, 9–24
 transmission behavior, 9–3
 write protection, 4–25

reset time, 4–15

response time, definition, 15–4

rH alarm, 4–20

rH measurement, 2–8, 4–9
 information, 4–9

rH value, interface commands, 9–13

rinsing program, 7–1
 definition, 15–5

S

sample calibration, 5–10

scrolling key, definition, 15–5

self test, 4–30

SensoCheck, 2–5, 4–21

setpoint, 4–15

single–point calibration, 5–5

slope alarm, 5–2
 interface commands, 4–20

software retrofitting, 4–34

specifications, 11–1

STATUS, interface commands, 9–5

straightway valve, 4–17

T

TAN, 4–34
 definition, 15–5

TC chart, 4–6

TC measured medium, 4–5
 chart, 4–6
 interface command, 9–11

temperature alarm, 4–20

temperature coefficient, definition, 15–5

temperature compensation, 2–8, 4–4
 automatic, 2–8, 4–4
 definition, 15–5
 manual, 4–5

temperature detection, 2–8, 4–4, 5–4
 interface commands, 9–11

temperature probe adjustment, 7–2
 interface commands, 9–22, 9–24

terminal assignments, 2–12

terminology, 15–1

test difference, 4–8, 5–11

test period, 4–8, 5–11

test results, device diagnostics, interface commands, 9–7

tolerance band calibration, 4–7, 5–2

tolerance band recorder, 4–7, 5–2, 6–2
 definition, 15–5
 interface commands, 9–8

transaction number, 4–34

U

Unical, 4–26, 5–13
 definition, 15–5
 interface commands, 9–18, 9–19

Unical Calimatic, 7–2

Unical factory setting, 13–1

Unical interface, 4–24

Unical program, 4–27
 examples, 13–1

user interface, 3–1

V

V 24 / 20 mA interface, 4–24
 command set, contents, 9–1
 interface commands, 9–24
 transmission behavior, 9–3
 write protection, 4–25

VALUE, interface commands, 9–4

viewing angle adjustment, 4–4
 interface commands, 9–10

Viewing level, 4–1
 definition, 15–5

W

wait position, 4–29, 7–1
 definition, 15–5

warning, 4–23
 definition, 15–5

Z

zero point, definition, 15–5

zero point alarm, 4–20, 5–2