

METTLER TOLEDO

Operating instructions
METTLER TOLEDO
Spider 3S Scales

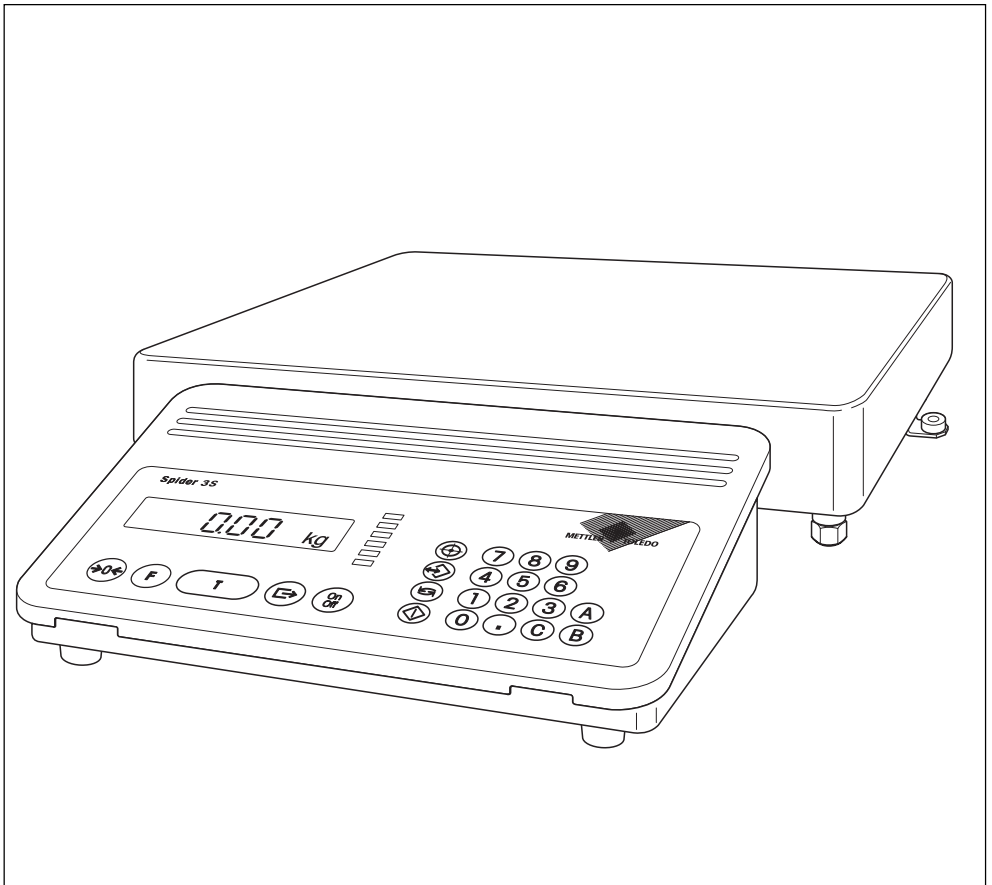

Overview of your scale

Overview

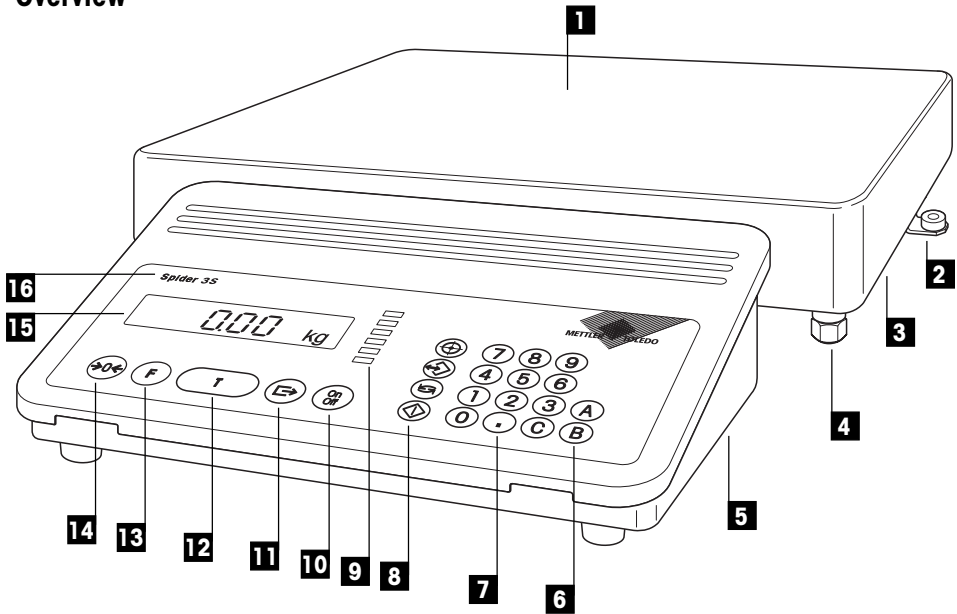

Display

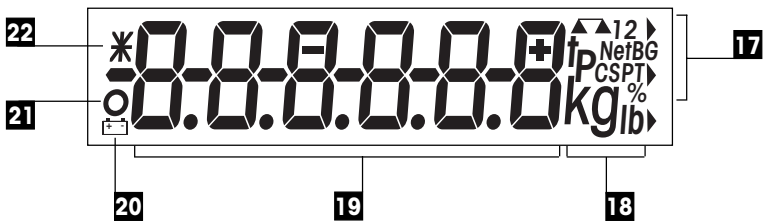

Connections (rear of terminal)

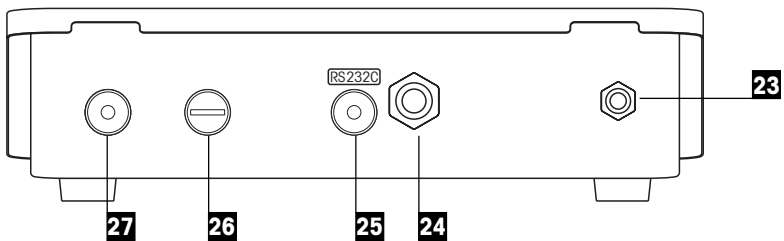

Display, controls and connections of your scale

Overview

No.	Designation
1	Weighing pan
2	Level (with certified scales only)
3	Weighing platform
4	Leveling foot
5	Terminal
6	ID keys
7	Numeric keys
8	Application keys
9	LED chain for plus/minus applications
10	On/off key
11	Transfer key
12	Tare key
13	Function key
14	Zeroing key
15	Display (see also expanded view)
16	Model designation

Display

No.	Designation
17	Display for special functions
18	Weighing units (kg, g, lb, t)
19	Alphanumeric display
20	Symbol for discharged battery (option)
21	Stability detector
22	Special symbol

Connections (rear of terminal)

No.	Designation
23	Connection cable terminal-platform
24	Power cable
25	Serial interface RS232C
26	Free output for options
27	Connection for outputs

Please see section 9.1 for specifications of the power supply, the platform supply and the RS232C interface.

Contents

1.	Getting to know your Spider S scale	6
1.1	Introduction	6
1.2	Overview of the Spider 3S scales	6
1.3	A wide range of optional equipment	6
1.4	What you should know about these instructions	7
1.5	Safety has priority	7
1.6	Declaration of conformity and safety tests	8
2.	Putting the scale into operation	10
2.1	For those in a great hurry	10
2.2	Unpacking and checking the standard equipment	11
2.3	Selecting or changing the location	11
2.4	Leveling the scale	12
2.5	Power supply	13
3.	Weighing made simple	14
3.1	Switching the scale on and off	14
3.2	Switching the display illumination on and off	14
3.3	Zeroing the scale	15
3.4	Taring the scale	15
3.5	Printing out the weighing result and transferring data	17
4.	The master mode	18
4.1	What is the master mode?	18
4.2	Operation in the master mode	19
4.3	Selecting a function	22
4.4	Selecting the assignment of the application keys	23
4.5	Selecting the resolution of the weighing result	25
4.6	Switching the automatic zero correction on or off	25
4.7	Switching the automatic taring function on or off	26
4.8	Activating or deactivating the automatic shutdown	26
4.9	Switching the automatic backup on or off	26
4.10	Setting the vibration adapter	27
4.11	Setting the process adapter	27
4.12	Configuring interface 1	28
4.13	Configuring interface 2 (optional equipment)	29

4.14	Printing out the settings	29
4.15	Resetting the settings to the factory settings	30
4.16	Setting the date and time	31
4.17	Exiting the master mode	32
5.	Special functions	33
5.1	Weighing in with automatic taring	33
5.2	Displaying gross weight	34
5.3	Switching weighing unit	34
5.4	Switching on control mode	34
5.5	Displaying date and time	35
5.6	Using the ID keys	36
6.	Plus/minus applications	37
6.1	Weighing in	37
6.2	Checkweighing	40
6.3	Classifying	43
6.4	Filling	46
6.5	Notes on recording the applications	46
7.	Piece counting, totalization and formula weighing	47
7.1	Notes on the application keys	47
7.2	Piece counting	47
7.3	Totalization	53
7.4	Formula weighing	55
7.5	Notes on recording applications	57
8.	Further important information regarding your scale	58
8.1	When faults appear	58
8.2	Notes on caring for your scale	60
8.3	Notes on the interface	61
8.4	Overview of the master mode	62
9.	Technical data	64
9.1	General data and standard equipment of the Spider 3S scales	64
9.2	Data for individual models	65

1. Getting to know your Spider S scale

This section provides you with detailed information on your Spider S scale. Please read this section through carefully even if you already have experience with METTLER TOLEDO balances and scales and be sure to familiarize yourself with the safety instructions!

1.1 Introduction

Thank you for deciding to purchase a scale from METTLER TOLEDO.

The industrial scales of the Spider S line combine a wide range of weighing functions and setting possibilities with exceptional ease of operation and ruggedness. The weighing platform and the terminal have IP67 degree of protection. The Spider S scales are thus eminently suitable for use in production environments which necessitate frequent cleaning using a water jet (e.g. in the chemical industry and in food production). Further, the comprehensive sealing of the entire scale ensures hygienically perfect conditions as the ingress of foreign substances is virtually completely impossible. The integral interface ensures problem-free data interchange with numerous peripherals and thanks to the easily surveyed and attractively styled terminal your Spider S scale looks well in any environment. Please read through these operating instructions very carefully so that you can exploit all the possibilities offered by your scale to the full.

1.2 Overview of the Spider 3S scales

Different models of the Spider 3S scale are available. All scales have the same terminal, but differ in their weighing range and the size of the weighing platform. All Spider 3S scales have the following equipment features in common:

- Compact and rugged, industrial construction with a housing made of stainless steel. All materials used are resistant to moisture, resistant to most chemicals and suitable for use in the food industry. The weighing platform and the terminal meet the requirements of IP67 degree of protection.
- Integrated functions for special applications
- LED chain for support of the plus/minus weighing applications
- Built-in RS232C serial interface.
- Convenient keypad and large size, illuminated display
- Universal expandability through an extensive range of optional equipment

Your Spider scale has a CE declaration of conformity (see section 1.6) and METTLER TOLEDO as the manufacturer has been awarded ISO 9001/EN 29001 certification. Certified versions of Spider S scales are also available, please ask your METTLER TOLEDO dealer.

1.3 A wide range of optional equipment

The wide range of optional equipment expands the application possibilities of your Spider S scale. For inquiries or orders, your local METTLER TOLEDO dealer will be pleased to help you.

1.4 What you should know about these instructions

These instructions contain orientation aids which facilitate your search for the desired information:

- Work steps are marked by “•”, whereas enumerations are preceded by a “–”.
- Key designations are enclosed in double angle brackets (e.g. «**On/Off**» or «**↔**»).
- Some keys of your Spider S scale have two assignments, i.e. two different functions can be called up with a single key, depending on whether the key is pressed briefly or pressed and held:



- This symbol indicates a brief keystroke.



- This symbol indicates a long, sustained keystroke (approx. 5 seconds).

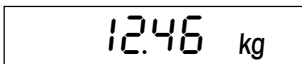

- This representation symbolizes the current display of your scale.



- These symbols indicate safety and hazard instructions. If these are not complied with, personal injuries to the user, damage to the scale or other tangible assets or malfunctions could result.

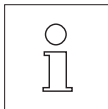

- This symbol indicates additional information and instructions which facilitate your handling of the scale and contribute to proper and economical use.

1.5 Safety has priority

Please note the following instructions for safe and problem-free operation of your Spider S scale.

- Read through these operating instructions carefully, even if you are already familiar with METTLER TOLEDO balances and scales.
- It is essential to note the instructions in section 2 when putting your new scale into operation.



- The Spider S scales must not be operated in a hazardous environment.



- **It is essential you note and comply with the cleaning instructions for your scale (section 8). The water tightness of your scale is assured only if the correct cleaning procedure is followed. This is a prerequisite for protection of the terminal and weighing platform to IP76 requirements!**

- Ensure that the voltage value printed on the model plate of your Spider S scale matches the local line voltage.

- Use only optional equipment and peripherals supplied by METTLER TOLEDO with your Spider S scale, these have been optimally matched to your scale.

- Your Spider S scale has a rugged construction, but it is still a **precision instrument** – treat it with the appropriate care and it will thank you with years of trouble-free operation.



- **Open neither the terminal nor the weighing cell**, they contain no parts which can be maintained, repaired or replaced by the user. Should the terminal or the weighing cell be opened, the warranty becomes null and void. Do not attempt to clean the interior of the weighing platform with solid objects. In the unlikely event you should experience problems with your scale, please contact your responsible METTLER TOLEDO dealer.

1.6 Declaration of conformity and safety tests

We, as manufacturer with sole responsibility, attest that the product to which this declaration relates is in conformity with the EC Directives stated below.

Notes: An EC type examination certificate has been obtained for certified scales and those subject to compulsory verification. The year of the first calibration is given next to the CE mark. Scales of this type are factory-certified and bear the designation «M» on the instrument itself and on its packaging. If the M is on a plain background, the scale may be put into service immediately. If the background is divided and hatched, the scale must be calibrated locally at its place of use by a certified METTLER TOLEDO Service facility. If the validity of the calibration is for a period limited by the country's national regulations, the operator of a scale of this type has sole responsibility for ensuring repeat certification in good time.

Scales and Terminals Spider 3S

Mark	EC Directive	Compliant with standard
	73/23EEC Low Voltage	EN61010-1:1993 EN61010-1/A2:1995 (Safety requirements)
	89/336EEC EMC	EN55011:1991 Radio interferences EN50082-1:1992 Immunity
	90/384EEC ¹⁾ Not automatic scales	EN45501:1992 ¹⁾ Not automatic scales

¹⁾ Applies only to certified scales (approval/test certificate no. T2867/TC2518)

Mettler-Toledo GmbH
Industrial BA IND-N
Nänikon, September 1996

Johannes Schmid
Manager
Business Area Industrial

Stephan Hermanns
Manager
Product Area Precision Scales

The scales and terminals of the Spider 3S range have been examined by accredited testing agencies. They have passed the **safety tests** listed below and carry the corresponding marks of conformity. The production is subject to process inspection by the testing authorities.

Country	Mark of conformity	Standard
Germany		EN61010-1:1993 EN61010-1/A2:1995 EN50082-1:1992 EN55011:1991

USA/Canada

This equipment has been tested and found to comply with the limits for a Class A digital device, pursuant to both Part 15 of the FCC Rules and the radio interference regulations of the Canadian Department of Communications. These limits are designed to provide reasonable protection against harmful interference when the equipment is operated in a commercial environment. This equipment generates, uses and can radiate radio frequency energy and, if not installed and used in accordance with the instruction manual, may cause harmful interference to radio communications. Operation of this equipment in a residential area is likely to cause harmful interference, in which case the user will be required to correct the interference at his own expense.

Cet appareil a été testé et s'est avéré conforme aux limites prévues pour les appareils numériques de classe A et à la partie 15 des règlements FCC et à la réglementation des radio-Interférences du Canadian Department of communications. Ces limites sont destinées à fournir une protection adéquate contre les interférences néfastes lorsque l'appareil est utilisé dans un environnement commercial. Cet appareil génère, utilise et peut radier une énergie à fréquence radioélectrique; il est en outre susceptible d'engendrer des interférences avec les communications radio, s'il n'est pas installé et utilisé conformément aux instructions du mode d'emploi. L'utilisation de cet appareil dans les zones résidentielles peut causer des interférences néfastes, auquel cas l'exploitant sera amené à prendre les dispositions utiles pour pallier aux interférences à ses propres frais.

2. Putting the scale into operation

In this section you will learn how you unpack and set up your new scale and prepare it for operation. On completion of the steps described in this section, your scale is ready for operation.

2.1 For those in a great hurry

If you are already familiar with the Spider S scales, the following short-form instructions comprising 5 steps will suffice for putting your new scale into operation. All other users are advised to study the following sections, which describe the individual steps in detail.

Nothing could be simpler!

1

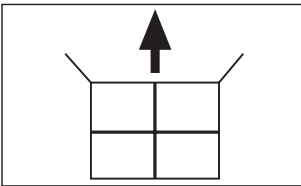

- Unpack

2

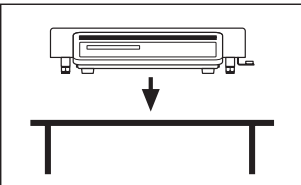

- Set up

3

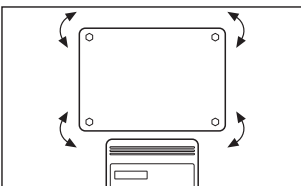

- Level

4

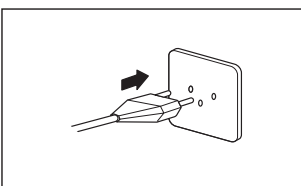

- Connect to power supply:
First check whether the voltage printed on the model plate of the scale matches your local line voltage. **If this is not the case, on no account connect the scale to the power supply**, but contact your METTLER TOLEDO dealer!

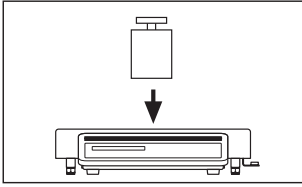

- Weigh!

2.2 Unpacking and checking the standard equipment

Before you set up your new scale and put it into operation, you should check whether you have received all accessories that are part of the standard equipment of your scale.

- Open the packaging carton and pull the scale together with the protective cushioning out of the carton. Remove the protective cushioning.
- Check the delivery for completeness. The following parts are included in the standard equipment:
 - Terminal and weighing platform with mounted weighing pan and level (with certified scales only)
 - Operating instructions
 - 2 keypad stickers each for piece counting and totalization as well as for formula weighing and inscription of the ID keys
 - Open-end wrench to level the scale
- Store all parts of the packaging. This packaging guarantees the best possible protection for the transport of your scale.
- Check the scale for any damage. Notify your METTLER TOLEDO dealer immediately if you have any complaints. On no account put the scale into operation if you discover any external damage!



2.3 Selecting or changing the location

For your own safety, heed the following instructions regarding selection of the location. Also bear in mind that your scale is a precision instrument and will thank you for an optimum location with high accuracy and dependability.



- Never operate the scale in a hazardous environment.

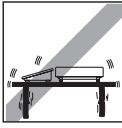

- Firm, vibration-free position as horizontal as possible. The foundation must be capable of safely supporting the weight of the fully loaded scale.



- Temperature range from -10°C to +40°C

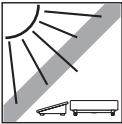

- No direct sunlight

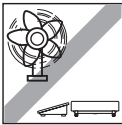

- No excessive drafts (e.g. from fans)

Note: If you have a **certified scale** and move this to a location far removed from the original site, please contact the local METTLER TOLEDO dealer at the new destination to have the scale recalibrated.

2.4 Leveling the scale

To compensate any minor unevenness at its location, the scale can be leveled:

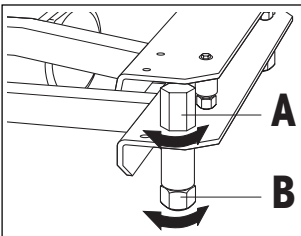

- Lift off the weighing pan. Loosen the lock nuts ("A") of the leveling feet (if necessary, use the open-end wrench supplied). Turn the adjustable feet ("B") until the scale is level, or ...

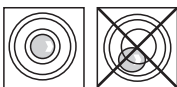

... the air bubble is located in the center of the level (only certified scales have a level).

- To prevent unintentional alteration of the leveling feet, tighten the lock nuts of all leveling feet using the open-end wrench supplied and then replace the weighing pan. **You should relevel the scale after every location change.**

2.5 Power supply

On delivery, the scale is set to the line voltage of the country of destination.



- First check whether the voltage printed on the model plate of the scale matches the local line voltage. **If this is not the case, on no account connect the scale to the power supply**, but contact your METTLER TOLEDO dealer.

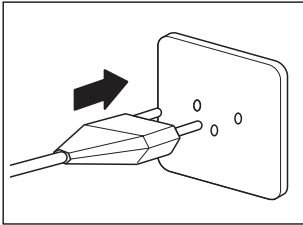

- Connect the scale terminal to the power supply.



Route the power cable so that it does not touch the weighing pan and such that it can never hinder your daily operations nor be damaged!

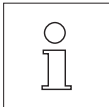

After connection to the power supply, the scale performs a self-test in which all display segments light up briefly. In addition, information specific to the scale is displayed briefly (software version etc.). This information is displayed each time the scale has been disconnected from the power supply and then reconnected. **We advise you to disconnect the scale from the power supply if it will not be used for a lengthy period.**

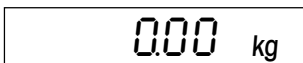

On completion of the self-test, your scale is ready for operation.

3. Weighing made simple

This section explains how you switch the scale on and off, set it to zero and tare it. You will also become familiar with and learn how to use the numeric keypad, how to print out the weighing result and transfer data.

3.1 Switching the scale on and off

After the scale has been put into operation for the first time we advise you not to disconnect it from the power supply (except during lengthy breaks in operation) – it is then in thermal equilibrium and ready for operation quicker.



- To **switch the scale on**, press the «**On/Off**» key briefly.
The scale performs a self-test.

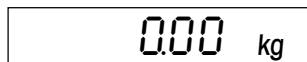

As soon as the weight display appears, your scale is ready for weighing.



- To **switch the scale off**, press the «**On/Off**» key again.

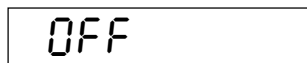

Switching off is confirmed briefly in the display with "OFF" and then the display is cleared.

3.2 Switching the display illumination on and off

For convenient work, the display of your scale is illuminated to allow perfect reading even under adverse lighting conditions.

The display illumination can be switched on and off at a keystroke:



- Press and hold the «**On/Off**» key until the illumination is switched on or off.

3.3 Zeroing the scale

As a result of environmental influences, your scale may not show exactly "0.00" even though the weighing pan is unloaded. However, you can reset the display of your scale to zero at any time to ensure that the weighing really starts at zero. Zeroing with a loaded weight is possible only within a certain range, which depends on the scale model. If the scale can not be reset to zero when a weight is loaded, this range has been exceeded.

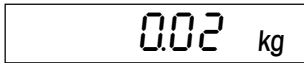

The scale does not show exactly zero even though the weighing pan is unloaded.



- Press the «→0←» key and the scale starts the reset to zero.

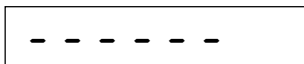

During the resetting, the horizontal segments appear in the display and after a short wait time ...

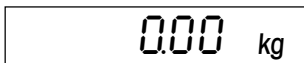

... your scale is reset to zero.

Note: If an error message appears during resetting, please consult the list of error messages in section 8.

3.4 Taring the scale

The weight of any weighing container can be "tared" at a keystroke so that the net weight of the weighing sample is always shown in subsequent weighings. You have a choice between 3 different taring procedures!:

- Taring by loading the weighing container
- Taring by numeric entry of the tare weight
- Taring by recall of a stored tare value

Taring by loading the weighing container

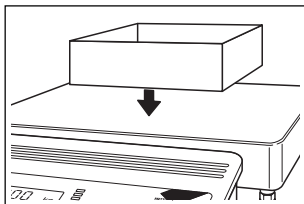

- Place the **empty** weighing container on the weighing pan.

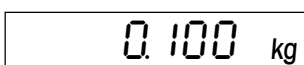

The weight of the loaded container is displayed.

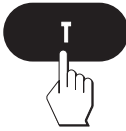

- Press the «T» key to start the taring operation.



Taring runs automatically. If the scale has to wait until the weight value is stable, horizontal segments appear in the display during the wait time.

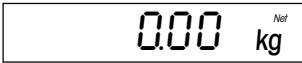

On completion of taring, the zero display and the symbol "Net" (for net weight) symbol appears. Your scale is again ready for weighing.

Note: When the scale is unloaded, the stored tare value is displayed with a negative sign.

Taring by numeric entry of the tare weight



- Enter the known tare weight using the numeric keypad and then press the «T» key.

Note: You can delete wrong entries digit by digit with the «C» key.

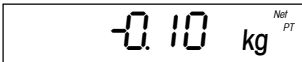

The display shows the inputted tare weight with a negative sign and the symbol "Net" for net weight. The additional symbol "PT" (PreTare) indicates that this is a preset tare value which has not been determined by the scale, but inputted manually by the operator.

Note: The tare weight remains stored until you specify a new tare.

Taring by recall of a stored tare value

Your scale has a memory which can store up to 10 tare values which can be recalled at any time. **The values remain stored in the tare memory even if the scale is switched off.**

Storage of tare values

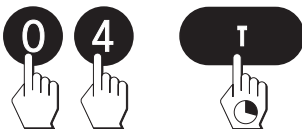

- Determine the tare by loading the weighing container or by numeric entry as described in the two previous sections.

- Enter the number of the memory location (00 – 09) in which you wish to store the current tare and then press and hold the «T» key.

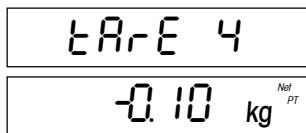

The display briefly shows the confirmation that the tare value has been stored under the desired memory number and the scale then returns to the weighing mode.

Recalling stored tare values

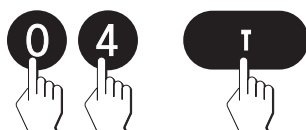

- Enter the number of the memory location (00–09) where the desired tare value is stored and then press the «T» key.

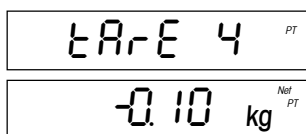

The display briefly shows the confirmation that the tare value has been stored under the desired memory number and the scale then returns to the weighing mode.

Clearing the current tare value

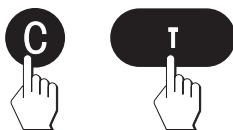

- Press the «C» and «T» keys in succession.

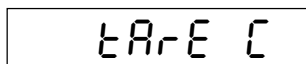

The display briefly shows the confirmation that the current tare value has been cleared, the scale then returns to the weighing mode.

Note: Only the **tare value currently active** is cleared, the stored tare values are retained.

3.5 Printing out the weighing result and transferring data

If your scale is connected to a printer via the RS232C interface, you can print out the current weighing result with a single keystroke. If your scale is connected to a computer, you can transfer data to and from the computer. You will find additional information on the attachment of a printer in the documentation accompanying your printer. Further details on the serial interface and regarding attachment of a computer can be found in the interface description available from your METTLER TOLEDO dealer.



- Press the «G» key. As soon as the weighing result is stable, it will be transferred to the attached device.

4. The master mode

4.1 What is the master mode?

The master mode allows you to match your scale to your specific weighing needs. In the master mode you can change the settings of your scale and activate functions. The master mode contains **14 blocks** (15 blocks if your scale is equipped with the second interface available as an option), each of which offers different selection possibilities.

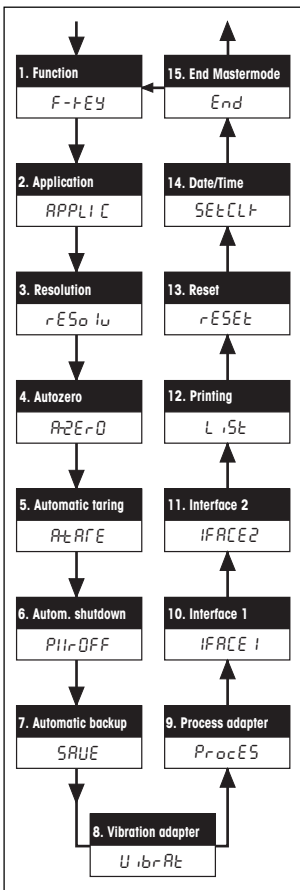

- 1. Function:** Definition of the function you wish to have available under the «F» key (F-Key).
- 2. Application:** Assignment of the application keys.
- 3. Resolution:** Selecting the resolution of the weighing result.
- 4. Autozero:** On/off switching of the automatic zero correction, not available with certified scales.
- 5. Automatic taring:** On/off switching of the automatic taring function.
- 6. Autom. shutdown:** Activation/deactivation of the automatic shutdown function (Power Off).
- 7. Autom. backup:** On/off switching of the automatic backup of the last tare and zero value (on power failure), not available with certified scales.
- 8. Vibration adapter:** Matching the scale to the ambient conditions.
- 9. Process adapter:** Matching the scale to the type of weighing.
- 10. Interface 1:** Settings for the first interface built in as standard (Interface 1).
- 11. Interface 2:** Settings for the optional second interface (Interface 2). This block appears only if a second interface is built in.
- 12. Printing:** Print out (list) of the current master mode settings.
- 13. Reset:** Reset the master mode settings to the factory settings.
- 14. Date/Time:** Setting of date and time.
- 15. End master mode:** Exit the master mode.

You will find a complete overview of the master mode with all setting possibilities in section 8.

4.2 Operation in the master mode

In this section you will learn how to work with the master mode. Information regarding the individual master mode blocks and available settings can be found in the following sections.

These are the keys you need in the master mode

YES:



– The «» key is used for the **acceptance** of a proffered option and has the same meaning as “**YES**”.

Whenever you wish to **accept** a proffered **option**, press the «» key briefly.

NO:



– The «» key is used for the **rejection** of a proffered option and has the same meaning as “**NO**”.

Whenever you wish to **reject** a proffered **option**, press the «» key briefly.

Switching from the weighing mode to the master mode

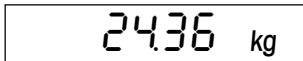

The scale operates in the normal weighing mode.



- Press the «» key and keep it pressed for approx. 5 seconds.

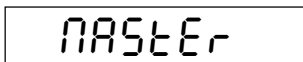

The scale now asks whether you really wish to switch to the master mode:

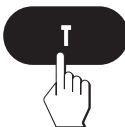

- **If you do not wish to switch to the master mode**, press the «» key (“NO”) and ...

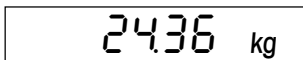

... the scale then returns to the weighing mode.



- **If you wish to switch to the master mode**, press the «» key (“YES”) and...

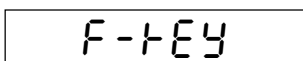

... the scale then shows the first block of the master mode (“F-KEY” = Function) directly.

Selecting the master mode blocks

F-KEY

Following entry into the master mode, the first master mode block ("F-KEY").

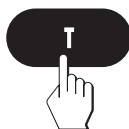

- Press the «T» key ("NO") and ...

APPLIC

... the display shows the next master mode block ("APPLIC" = Application). Each time the «T» key ("NO") is pressed, the scale switches to the next master mode block.

End

In the last master mode block you ("End") you are asked if you wish to quit the master mode.

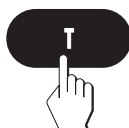

- **If you do not wish to quit the master mode**, press the «T» key ("NO") again and then ...

F-KEY

... the first master mode block ("F-KEY") is again displayed.



- **If you wish to quit the master mode**, press the «E» key ("YES") and ...

2436 kg

... the scale returns to the weighing mode.

Changing the setting in a master mode block:

F-KEY

- Select the master mode block as described above in which you wish to change a setting (in this example the block "F-KEY" = Function).



- Press the «E» key ("YES"). This tells the scale that you wish to make changes in the selected block.

Gross

The display shows the setting currently active (in this example the function "Gross" = gross weight).

- Now press the «T» key ("NO") repeatedly until the desired setting is displayed.

Unit 2

CLOCK

- As soon as the desired setting is displayed (in this example "CLOCK" = function "Date and Time"), press the «E» key ("YES").

End

You are now asked whether you wish to quit the master mode.

- **If you do not wish to quit the master mode**, press the «T» key ("NO") and then ...

APPLIC

... the next master mode block is displayed (in this example "APPLIC").

- **If you wish to quit the master mode**, press the «E» key ("YES") and ...

24.36 kg

... the scale returns to the weighing mode.

In the following sections, you will find information on the various setting possibilities in the individual master mode blocks.

4.3 Selecting a function

F-KEY

In the first master mode block, you specify what **function** you wish to have available in the weighing mode after pressing the «F» key. Use of these functions is explained in section 5.

This master mode block contains 7 main blocks, one of which offers subblocks. The following functions are available:

Gross

– After the «F» key has been pressed, the gross weighing result (net weight plus tare) is shown in the weighing mode. This is the **factory setting**.

Unit 2

– After the «F» key has been pressed, the weighing result is shown in the selected **second weighing unit** ("Unit 2", as an alternative to the first, unchangeable weighing unit "kg"). **This block is not available for certified scales!** The block contains 4 subblocks in which you can select the desired second weighing unit:

kg

– Kilogram "kg" (**factory setting**)

t

– Metric ton "t"

g

– Gram "g"

lb

– Pound "lb"

Ctrl

– After the «F» key has been pressed, the scale switches to the so-called "control mode" for a short time. In the control mode, the weighing result is shown with a ten times higher resolution for test purposes, i.e. displayed with one decimal place more. The number of decimal places actually displayed depends on the scale model and the weighing range.

CLOCK

– After the «F» key has been pressed, the **time and date** are shown in the weighing mode. You will find instructions on how to set the date and time in section 4.16.

b2 IF 1

– Attachment of a **second balance/scale to interface 1** (the second balance/scale is normally used as a reference weighing instrument for piece counting). When the «F» key is pressed, the measured value of the second balance/scale appears in the display of the Spider 3 scale. Certain work steps for the second balance/scale (e.g. zeroing and taring) can also be executed using the keypad of the Spider 3 provided the second balance/scale supports the MT-SICS 0 command set from METTLER TOLEDO. Please contact your local METTLER TOLEDO dealer if you require further information on the attachment of a second balance or scale.



- Attachment of a **second balance/scale to interface 2** (this block appears only if a second interface is installed). See previous section for details.

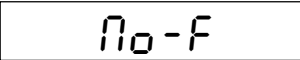

- **No function:** As the «F» key has no assignment, pressing it in the weighing mode has no effect.

4.4 Selecting the assignment of the application keys



You can use the 4 application keys of your scale for the direct recall of certain functions. In this master mode block you specify what applications you wish to use the 4 keys for. Please consult sections 6 and 7 of these instructions for detailed information on the working with the applications.



- Assignment of the application keys to **piece counting** (factory setting). This block contains 4 subblocks in which you can select whether you work with or without the add mode and whether you wish to use the plus/minus display (LED chain) for piece counting:

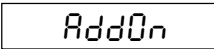

- **Add mode switched on (factory setting):** If the number of pieces loaded for determination of the reference is too low (weight < 10d), you are prompted to load additional pieces. This assures correct determination of the reference.

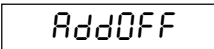

- **Add mode switched off:** There is no prompt to load additional pieces if the minimum weight required for a correct determination of the reference is not reached.



- **Plus/minus display switched off (factory setting):** The 6 LEDs of the plus/minus display are inactive.

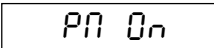

- **Plus/minus display switched on:** The 6 LEDs of the plus/minus display can be used for weighing in to a preselected target piece number. The LEDs show the current status of the weighed-in pieces (piece number less than lower tolerance limit, piece number within the tolerance, piece number greater than upper tolerance limit).

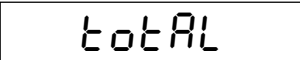

- Assignment of the application keys to **totalization**



- Assignment of the application keys to **formula weighing**

PLUSN1

PNAPPL

WEIGH1

CHECK

CLASS

FILL 1

FILL 2

STARTP

50 %

ZEROL1

* 0.15 kg

SETLED

CONST

STABLE

AUTTRA

OFF

On

– Assignment of the application keys to **plus/minus applications (factory setting)**. This block contains a series of subblocks in which you select the desired plus/minus application and can set parameters specific to your applications:

– In the first subblock you select the **desired plus/minus application**:

Weighing in: Continuous addition of weighing sample until the desired target weight is reached.

Checkweighing: Check on whether the weighing sample is within the specified tolerance limits.

Classifying: Classification of the weighing samples into different weight classes.

Filling (systems with 1 filling head): special instructions are available for this application.

Filling (systems with 2 filling heads): special instructions are available for this application.

– In the second subblock you select the **limits for the response of the LEDs. The appearance of this subblock depends on what plus/minus application you have selected:**

If you have selected **weighing in**, enter the **start point for the LEDs in percent of the lower tolerance limit**. Enter the value using the numeric keypad (use the «C» key for corrections).

If you have selected **checkweighing or classifying**, enter the **minimum weight for the response of the LEDs**. Enter the value using the numeric keypad (use the «C» key for corrections). **Note:** This value also applies as a limit for the automatic data transfer via the interface (unloading check).

– In the third subblock you can select whether the **LEDs should be lit up permanently or only on stability**:

The LEDs are **constantly active**, irrespective of whether the weight is stable or not.

The LEDs are **first activated** when the weight value is stable.

– In the fourth subblock you select the **defaults for the automatic transfer of the weight values** via the interface:

The automatic data transfer is **switched off**.

All **stable** values which lie **within the plus/minus tolerance** are automatically transferred.

dISPLy

- In the fifth subblock you select the **display mode**:

norm

Normal weight display.

dIFF

Calculated **difference** between target weight and current weight value.

PERcent

The current weight value is shown in **percent of the target weight**.

OFF

The display (incl. illumination) is **switched off**, only the symbol of the stability detector and the LEDs are active.

End Pn

- In the sixth and last subblock, you can select whether you wish to quit the block for plus/minus applications.

4.5 Selecting the resolution of the weighing result

rESo lU

In this master mode block you can select the resolution in which the weighing result is displayed. The settings available and the factory setting depend on the scale's **nominal load** and whether it is a certified model or not.

0.00 1kg

The **example** shown here illustrates the maximum and minimum resolution of a 35 kg scale which is not certified. Other settings are available between these two extreme values.

0.200 kg

4.6 Switching the automatic zero correction on or off

A-ZErO

In this master mode block you can switch the automatic zero correction on or off. When switched on (factory setting), the zero point is automatically corrected for temperature fluctuations or contamination of the weighing pan. **This block is not available for certified scales.**

On

- Automatic zero correction **switched on**. This is the **factory setting**.

OFF

- Automatic zero correction **switched off**.

4.7 Switching the automatic taring function on or off

A-TARE

In this master mode block you can switch the **automatic taring function** on or off. If the automatic taring function is switched on, the scale will be automatically tared as soon as the empty weighing container is placed on the pan.

OFF

– Automatic taring function **switched off**. This is the **factory setting**.

On

– Automatic taring function **switched on**.

Note: Working with the automatic taring function is described in section 5.

4.8 Activating or deactivating the automatic shutdown

PII-OFF

When the automatic shutdown function is activated, the scale switches itself off automatically 3 minutes after the last operation presupposing that no weight is loaded. This is particularly useful if you operate your scale with the optional battery since you can then appreciably prolong the line-independent operating time of the scale. To switch the scale on again, press the «On» key.

OFF

– Automatic shutdown **deactivated**. This is the **factory setting**.

On

– Automatic shutdown **activated**.

4.9 Switching the automatic backup on or off

SAVE

When the automatic backup is activated, the current net weight and the current tare weight are automatically written to a nonvolatile memory. As soon as the scale is ready for operation again after disconnection from the power supply or after a power failure, the stored value is available. **This block is not available with certified scales.**

OFF

– Automatic backup **switched off**. This is the **factory setting**.

On

– Automatic backup **switched on**.

4.10 Setting the vibration adapter

UibrAt

The vibration adapter is used to match the scale to the ambient conditions (vibrations, drafts at scale location).

NEd

– Setting for **normal ambient conditions**. This is the **factory setting**. The scale operates at moderate speed.

LOH

– Setting for **virtually disturbance-free, stable surroundings**. The scale operates very quickly, but is more sensitive to external influences.

HIGH

– Setting for **unstable surroundings**. The scale operates more slowly than in the factory setting, but is less sensitive to external influences.

4.11 Setting the process adapter

ProCES

The process adapter can be used to match your scale to the different types of weighing.

UNI VER

– **Universal setting**, suitable for all types of weighings and normal weighing samples. This is the **factory setting**.

ABS

– **Absolute weighing**. This setting is suitable for checkweighings and for the weight determination of weighing samples.

DOSi NG

– **Dosing** of liquid or powdery weighing samples.

4.12 Configuring interface 1

IFACE 1

In this master mode block you can configure all parameters of the RS232C serial interface built in as standard. **You need configure the interface only if you do not obtain the desired result with the factory settings.** This master mode block is very extensive.



You will find a complete description of this master mode block and other useful information regarding the interface in the interface description of the Spider S scales available from your METTLER TOLEDO dealer.

If you have made unintentional changes in this master mode block, you can **reset all settings of the interface to the factory settings:**

IFACE 1

- Select the master mode block "I-FACE 1" and then press the « \rightarrow » key ("YES") to confirm that you wish to make changes in this block.

RESET 1

- You are now asked whether you wish to reset the interface settings to the factory settings. Press the « \rightarrow » key ("YES") to confirm that you wish to reset the settings.

Std ON 1

- To be on the safe side, you are again asked whether you wish to restore the factory settings. Press the « \rightarrow » key ("YES") again to confirm.

End

- The scale asks you whether you now wish to exit the master mode. Press the « \rightarrow » key ("YES") and ...

24.36 kg

... the scale returns to the weighing mode. The first serial interface now operates with the following **factory settings:**

Parameter	Factory setting
Data transmission protocol	XON/XOFF
Parity	Even
Data transmission rate	2400 baud (2400)
Operating mode	Printer (Print)
Data for transmission	Gross weight (Gross), net weight (Net), tare weight (Tare), time and date, all application values
Print format	Multi (new line for every value)

4.13 Configuring interface 2 (optional equipment)

IFACE2

This master mode block is displayed only if the second interface available as an option is installed!

In this master mode block you can configure all parameters of the optional second RS232C interface. **You need configure the interface only if you do not obtain the desired result with the factory settings.**

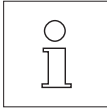

You will find a complete description of this master mode block and other useful information regarding the interface in the interface description of the Spider S scales which you received with the optional second interface.

To reset all parameters of the optional interface to the factory settings, proceed as described in the previous section.

4.14 Printing out the settings

L 1St

In this block you have the possibility to record all settings made in the master mode on the attached printer.

Pr int 1

– If you confirm this block (with the « \rightarrow » key), all master mode settings are printed out. If the printer is attached to the optional second interface, you can select the second interface with the «**T**» key (“Print 2”) to print out the master mode settings.

```
RANGE      : 6.018 kg
RESOL      : 0.002 kg
OS 1.29    AP 3.64

UNIT       : kg
F-KEY     : GROSS
APPLIC    : PLUSMI
A-ZERO    : ON
A-TARE    : OFF
PWROFF    : OFF
SAVE      : OFF
VIBRAT    : MED
PROCES    : UNIVER
RS232

PROTOC 1  : XONOFF
PARITY 1  : EVEN
BAUD 1    : 2400
MODE 1    : PRINT
```

The **extract from a record** shown opposite (without application values of the interface) is a **specimen**; depending on the selected settings and the type of printer the printout may differ from the example shown.

4.15 Resetting the settings to the factory settings

In this master mode block you have the possibility to reset the entire master mode to the factory settings.

If you confirm this option (with the «» key, the master mode will be reset to the following factory settings:

Master mode block	Factory setting
Function (F-KEY)	Gross weight (Gross)
Application keys (APPLIC)	Plus/minus application, weighing in
Resolution (RESOLU)	Depends on model
Autozero (A-ZERO)	Switched on (On)
Automatic taring (A-TARE)	Switched off (Off)
Autom. shutdown (PWR OFF)	Switched off (Off)
Automatic backup (SAVE)	Switched off (Off)
Vibration adapter (VIBRAT)	Setting for normal ambient conditions (Med)
Process adapter (PROCES)	Universal setting (Univer)

Notes:

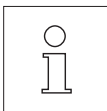

- Resetting to the factory settings affects **all master mode blocks with the exception of the two blocks for configuring the interfaces** (“I-FACE 1” and “I-FACE 2”), which can be reset in the respective block (see sections 4.12 and 4.13).
- **Proceed with caution with this option as you lose all individual settings (with the exception of the interface parameters)!**

4.16 Setting the date and time

SEtCLT

Your Spider S scale has a **built-in clock**. Date and time are recorded on the printouts and can also be requested at a keystroke (see section 5). In this master mode block you can set the date and time or adjust them to your time zone. This block contains two subblocks:

Euro

– European date and time format (factory setting)

U.S.

– American date and time format

After you have selected the appropriate format, you have available the two blocks for entry of the date and time.

Entering the date

DATE

- Select this block if you wish to enter or change the date.

02.08.96

- Enter the date using the numeric keys ("DD.MM.YY" in the European format or "MM.DD.YY" in the American format).

Entering the time

time

- Select this block if you wish to enter or change the time.

15:08

- Enter the time using the numeric keys. **Irrespective of whether you have selected the European or American notation, the time must always be entered in the 24-hour format.** If you have selected the American format, the time will automatically be shown correctly (namely "3.09 P" for "15.09").

EndSC

After entry of the date and time, you are asked whether you wish to quit the master mode block for entry of the date and time. Press the **T** key if you wish to make further settings in this block, if not press «**↵**».

4.17 Exiting the master mode

End

24.36 kg

F-T EY

In the last master mode block you can decide whether you wish to quit the master mode and return to the weighing mode or whether you wish to make further settings:

- To quit the master mode, press the « \rightarrow » key to return the scale to the weighing mode.
- To perform further settings in the master mode, press the «T» key and the first block of the master mode reappears in the display.

5. Special functions

Your Spider S scale offers you several useful functions, which we describe in the following sections.

5.1 Weighing in with automatic taring

Weighing in with automatic taring assumes you have activated the automatic taring function in the master mode (see section 4.7). The automatic taring function saves you manual taring by automatically interpreting the first weight loaded on the weighing pan as a weighing container whose weight should not be taken into consideration.

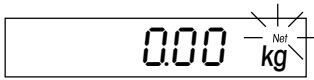

When the automatic taring function is switched on, the net symbol flashes when the scale is unloaded.

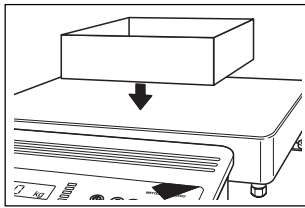

- Place the empty weighing container on the scale.



As soon as the scale has reached stability, the weighing container is tared and the net symbol stops flashing.

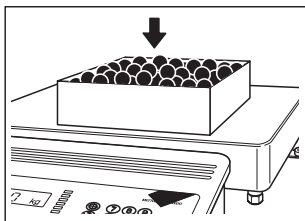

- Add the weighing sample to the container until ...

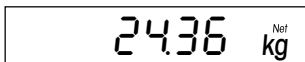

... the desired weight is reached.

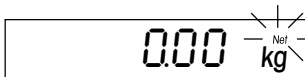

As soon as you unload the scale, the stored weight is cleared. The net symbol starts to flash again and the scale is ready for the next automatic taring and weighing.

If you no longer need the automatic taring function, you must switch it off in the master mode (see section 4.7).

5.2 Displaying gross weight

The display of the gross weight assumes you have preselected the function "Gross" (gross weight) in the master mode (see section 4.3).

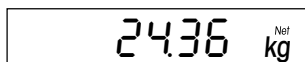

- Place the empty weighing container on the pan, tare it and add the weighing sample to the container. The scale shows the **net weight**.



- Press the «F» key and ...

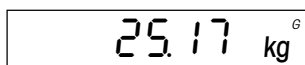

... the scale shows the **gross weight** (weighing sample plus tare), symbolized by the "G" in the top right of the display.

Each time the «F» key is pressed, the scale switches between the display of the net and gross weight.

5.3 Switching weighing unit

Switching the weighing unit assumes you have preselected the function "Unit 2" (kg, t, g or lb) (see section 4.3).

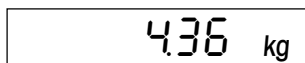

The weighing result is displayed in the first, unalterable weighing unit (kilograms).



- Press the «F» key briefly and ...

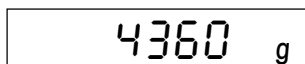

... the weighing result is displayed in the second weighing unit (grams in this example). Each time the «F» key is pressed, the display switches between the first and second weighing unit.

5.4 Switching on control mode

The control mode is available only if you have preselected the function "CTRL" (control mode) (see section 4.3). In the control mode, the weighing result is displayed with a ten times higher resolution for test purposes, i.e. with an additional decimal place. The effective number of decimal places shown depends on the scale model and the weighing range.

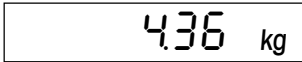

The current weighing result is displayed.



- Press the «F» key briefly and ...

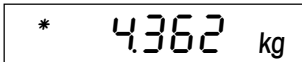

... the scale switches to the control mode. **In the control mode no work steps (such as taring) can be performed**, the scale reacts only to weight changes.

With **noncertified scales** you can switch back and forth between the weighing and the control mode by pressing the «F» key. **Certified scales** remain in the control mode for 5 seconds and then automatically return to the weighing mode.

5.5 Displaying date and time

The display of the date and time assumes you have preselected the function "Clock" (display of the date and time) in the master mode (see section 4.3).

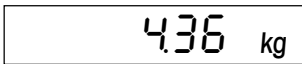

The current weighing result is displayed.



- Press the «F» key briefly and ...

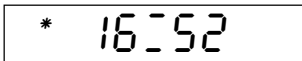

... the display shows the current time.



- Press the «F» key briefly again and ...

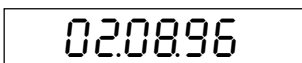

... the display shows the current date.



- Press the «F» key again briefly and ...

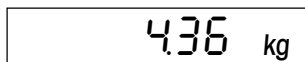

... the scale switches back to the display of the weighing result.

Note: You will find information on setting the time and date in section 4.16.

5.6 Using the ID keys

Your Spider S scale has two **identification keys**, «**A**» and «**B**». You can assign any number to each of the two keys and this will be printed out on every printout. The ID keys are particularly useful in connection with the applications (see sections 6 and 7). For example, you can assign the customer number to key «**A**» and the article number to key «**B**». The printout then shows clearly what article has been weighed for what customers. To assign the keys a number, proceed as follows:



- Key in the desired number (e.g. "123", max. 18 digits).
- Briefly press the ID key you wish to assign the number to ("A" or "B"). The number is stored and the scale then returns to the weighing mode.

Notes

- The stored numbers remain stored until you switch off the scale.
- You can change the stored numbers at any time.
- By briefly pressing the appropriate ID key, you can always request the stored number. The first 6 digits of the number are shown in the display. If you wish to view the remaining digits (if used), press and hold the ID key. The number is slowly moved to the left in the display to allow you to see the remaining digits.
- To delete a number, press the corresponding ID key and then press the «**C**» key.



6. Plus/minus applications

The Spider 3S scale offers you three plus/minus applications: Weighing in, checkweighing and classifying. We describe these applications in the following sections.

6.1 Weighing in



The plus/minus application "Weighing in" allows addition (dosing) until the weighing sample lies within the specified tolerances in regard to the selected target weight. The 6 LEDs support you in the dosing operation.

This application presupposes you have made the following settings in the **master mode** (see section 4.4):

- the **plus/minus application "weighing in"** ("WEIGH IN") must be selected
- the **start point for the response of the LEDs** ("STARTP") must be specified (in percent of the lower tolerance limit)
- the **behavior of the LEDs** ("SETLED") must be defined.
- the **defaults for the automatic transfer of the weight values** via the interface ("AUTTRA") must be defined.
- the **display mode** must be specified (in the factory, the normal weight display is preselected and this display will be assumed in the following description). Alternatively, you can display the difference between the target weight and the actual weight or the actual weight in percent of the target weight. Further, you have the possibility to switch off the display).

Entering default values

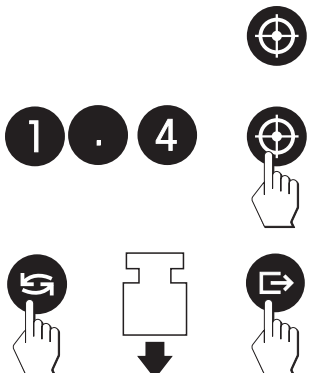
Before you can start the weighing in, you must enter the target weight, the admissible tolerances and the limit value for the response of the LEDs. You can enter the default values numerically or by loading the corresponding quantity of the weighing sample. Both procedures are described for each work step in what follows.

- 
- Press the target value key. The **green LED**, which symbolizes the **target weight**, starts to flash and prompts you to enter the target weight:
 - Enter the target weight using the numeric keypad (e.g. 1.40 kg) and confirm your entry by pressing the target value key again **or** ...
 - ... press the switch key, place the weighing container on the weighing pan (if you are working with a weighing container) and tare the scale. Add the amount of weighing sample corresponding to the target weight (e.g. 1.40 kg) to the container and confirm the displayed value with the «» key. Leave the container and the weighing sample on the scale.

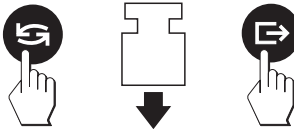

- The **green and the yellow LED** start to flash and prompt you to enter the **upper tolerance**. The scale suggests a value corresponding to 2% of the target weight.

- You can accept the suggested value or enter your own value for the **admissible overfilling** (e.g. 0.2 kg) using the numeric keypad. Confirm the selected value by pressing the target value key. The display briefly shows the admissible maximum weight (target weight plus admissible overfilling, in this example 1.60 kg), **or ...**

- ... press the switch key and add additional weighing sample to the container until the desired **admissible maximum weight** is reached (in this example, 1.60 kg). Confirm the displayed value with the «**↵**» key. Leave the container and the weighing sample on the scale.

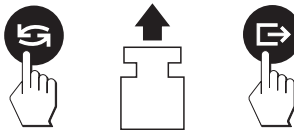

- The **green and the topmost red LED** start to flash and prompt you to enter the **lower tolerance** (the scale suggest the same value as for the upper tolerance).

- You can accept the suggested value or enter your own value for the **admissible underfilling** (e.g. 0.1 kg) using the numeric keypad. Confirm the selected value by pressing the target value key. The display briefly shows the admissible minimum weight (target weight minus admissible underfilling, in this example 1.30 kg), **or ...**

- press the switch key and remove weighing sample from the container until the desired **admissible minimum weight** is reached (in this example, 1.30 kg). Confirm the displayed value with the «**↵**» key. Leave the container and the weighing sample on the scale.

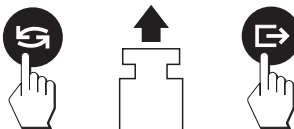
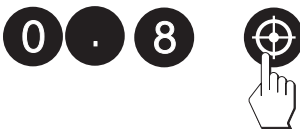

- The **lowest red LED** starts to flash and prompts you to enter the **limit value**, which when attained in weighing in will cause the red LEDs to respond. The scale suggest a value which it has calculated from the master mode setting "StartP" (factory setting = 50%, section 4.4) and the minimum weight.

- Confirm the displayed value or enter the desired value (e.g. 0.8 kg) using the numeric keypad and then press the target value key, **or ...**

- ... press the switch key and remove the weighing sample from the container until the desired value is reached (e.g. 0.8 kg). Confirm the desired value with the «**↵**» key.

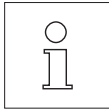

Notes

- If default values are already available from earlier weighings, these values are displayed. If you wish to accept such a value, there is no need to key it in again, you can simply adopt it with the target value key or the « \square » key.
- The scale checks your entries for plausibility and inadmissible entries are rejected with an error message (see section 8).

After entry of the target value, the tolerances and the limit value for the response of the LEDs, the scale returns to the weighing mode.

Storing default values

The default values (target weight, tolerances and limit value for the response of the LEDs) can be permanently stored. The scale makes 3 memory locations available for this purpose (00 – 02). This allows you to store the default values for 3 different weighing-in operations and recall them at any time. To store the inputted values, proceed as follows:

0 1



- Use the numeric keypad to enter the number of the memory in which you wish to store the values (e.g. "01"). Then press the storage key.

Store 1

The storage is briefly confirmed in the display and the scale then returns to the weighing mode.

The stored values are retained until they are overwritten by a new storage operation.

Performing weighing in

The example below illustrates how you work with the weighing-in application in practice. It is assumed that the target weight, the tolerances and the limit value for response of the LEDs are already defined.

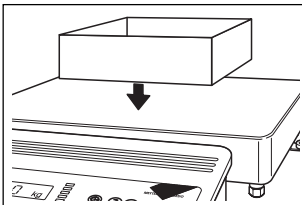

- If you are working with a weighing container, place it on the pan and tare the scale by briefly pressing the «**T**» key (if the automatic taring function is switched on in the master mode, taring is automatic and you do not need to press the «**T**» key).

0 1

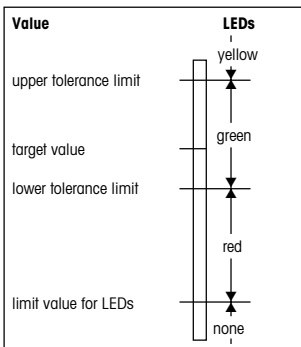
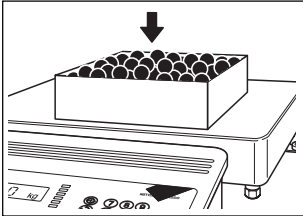

- Load the default values (target weight, tolerances and limit value for the response of the LEDs) from the memory: Enter the number of the desired memory (00 – 02) and then briefly press the storage key to activate the values. **Notes:** If you do not load any default values from the memory, the scale will operate with the values last activated.
- Add the weighing sample and observe the LEDs:

As soon as the limit value for the response of the LEDs is reached, the **lowest red LED** lights up.

On continued weighing in, the **other red LEDs** light up successively.

As long as the weight of the weighing sample lies between the admissible minimum weight (target weight minus lower tolerance) and the admissible maximum weight (target weight plus upper tolerance), the **green LED** lights up.

If the upper tolerance is exceeded, the **yellow LED** lights up.

6.2 Checkweighing

With the plus/minus application "Checkweighing" you can check whether the weighing sample lies within specified tolerances in regard to the selected target weight. The green, yellow and the topmost red LEDs support you in the checking operation.

For checkweighing the following settings must be made in the **master mode** (section 4.4):

- the **plus/minus application "Checkweighing"** ("CHECK") must be selected.
- the **minimum weight for the response of the LEDs** ("ZEROLI") must be specified.
- the **behavior of the LEDs** ("SETLED") must be defined.
- the **defaults for the automatic transfer of the weight values** via the interface ("AUTTRA") must be defined.
- the **display mode** must be specified (in the factory, the normal weight display is preselected and this display will be assumed in the following description). Alternatively, you can display the difference between the target weight and the actual weight or the actual weight in percent of the target weight. Further, you have the possibility to switch off the display).

Entering default values

Before you can start the weighing in, you must enter the target weight and the admissible tolerances. You can enter the default values numerically or by loading the corresponding quantity of the weighing sample. Both procedures are described for each work step in what follows

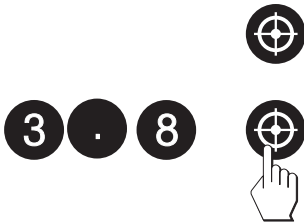

- Press the target value key. The **green LED**, which symbolizes the **target weight**, starts to flash and prompts you to enter the target weight:

- Enter the target weight using the numeric keypad (e.g. 3.80 kg) and confirm your entry by pressing the target value key again **or** ...

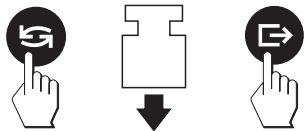

- ... press the switch key, place the weighing container on the weighing pan (if you are working with a weighing container) and tare the scale. Add the amount of weighing sample corresponding to the target weight (e.g. 3.80 kg) to the container and confirm the displayed value with the «**→**» key. Leave the container and the weighing sample on the scale.



- The **green and the yellow LED** start to flash and prompt you to enter the **upper tolerance**. The scale suggests a value corresponding to 2% of the target weight.

- You can accept the suggested value or enter your own value (e.g. 0.1 kg) using the numeric keypad. Confirm the selected value by pressing the target value key. The display briefly shows the admissible maximum weight (target weight plus upper tolerance, in this example 3.90 kg), **or** ...

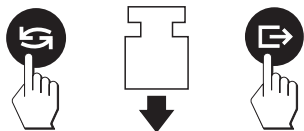



- ... press the switch key and add additional weighing sample to the container until the desired **admissible maximum weight** is reached (in this example, 3.90 kg). Confirm the displayed value with the «**→**» key. Leave the container and the weighing sample on the scale.

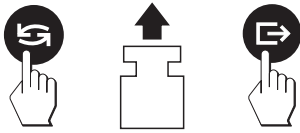

- The **green and the topmost red LED** start to flash and prompt you to enter the **lower tolerance** (the scale suggest the same value as for the upper tolerance).

- You can accept the suggested value or enter your own value (e.g. 0.2 kg) using the numeric keypad. Confirm the selected value by pressing the target value key. The display briefly shows the admissible minimum weight (target weight minus admissible underfilling, in this example 3.60 kg), **or** ...



- press the switch key and add additional weighing sample to the container until the desired **admissible minimum weight** is reached (in this example, 3.60 kg). Confirm the displayed value with the «» key.

Notes

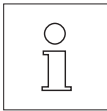

- If default values are already available from earlier weighings, these values are displayed. If you wish to accept such a value, there is no need to key it in again, you can simply adopt it with the target value key or the «» key.
- The scale checks your entries for plausibility and inadmissible entries are rejected with an error message (see section 8).

After entry of the target value and the tolerances, the scale returns to the weighing mode.

Storing default values

The default values (target weight and tolerances) can be permanently stored. The scale makes 3 memory locations available for this purpose (00 – 02). This allows you to store the default values for 3 different checkweighing operations and recall them at any time. To store the inputted values, proceed as follows:



- Use the numeric keypad to enter the number of the memory in which you wish to store the values (e.g. "00"). Then press the storage key.

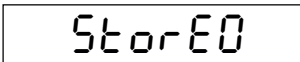

The storage is briefly confirmed in the display and the scale then returns to the weighing mode.

The stored values are retained until they are overwritten by a new storage operation.

Checking weighing samples

The example below illustrates how you work with the checkweighing application in practice. It is assumed that the target weight and the tolerances are already defined.

0 0

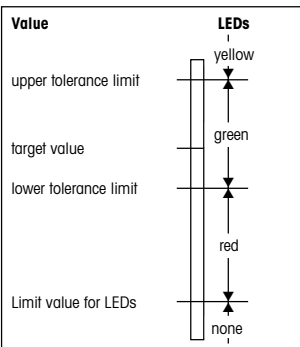
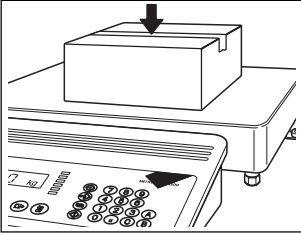

- Load the default values (target weight and tolerances) from the memory: Enter the number of the desired memory (00 – 02) and then briefly press the storage key to activate the values. **Notes:** If you do not load any default values from the memory, the scale will operate with the values last activated.
- Load the weighing sample to be checked and observe the LEDs:

As soon as the minimum weight or the response of the LEDs is reached (limit value in accordance with the default entry in the master mode, see section 4.4), the **topmost red LED** lights up.

As soon as the weight of the weighing sample has reached the admissible minimum weight (target weight minus lower tolerance), the **green LED** lights up. The green LED remains on as long as the weight lies between the upper and lower tolerance.

If the maximum weight (target value plus upper tolerance) is exceeded, the **yellow LED** lights up.

6.3 Classifying











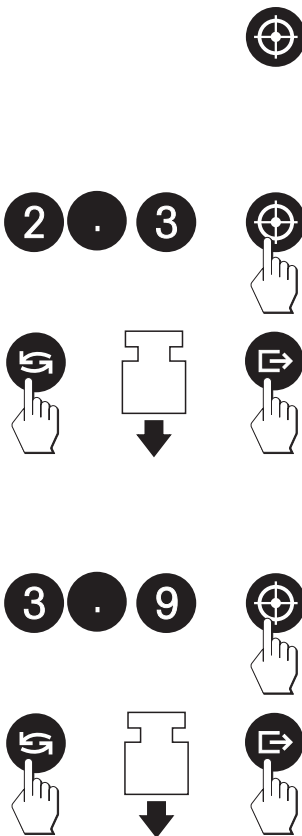

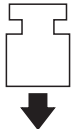

With the plus/minus application “Classifying” you can classify weighing samples into 3 definable weight classes. The green, yellow and topmost red LEDs symbolize the three classes.

For classifying, the following settings must be made in the **master mode** (section 4.4):



- the **plus/minus application “Classifying”** (“CLASS”) must be selected.
- the **minimum weight for the response of the LEDs** (“ZEROLI”) must be specified.
- the **behavior of the LEDs** (“SETLED”) must be specified.
- the **defaults for the automatic transfer of the weight values** via the interface (“AUTTRA”) must be defined.
- the **display mode** must be specified (in the factory, the normal weight display is preselected and this display will be assumed in the following description). Alternatively, you can display the difference between the target weight and the actual weight or the actual weight in percent of the target weight. Further, you have the possibility to switch off the display).

Defining weight classes

Before you can start the classifying operation, you must define the weight classes. You can enter the default values using the numeric keypad or by loading the corresponding weighing sample. Both procedures are described for each work step in what follows.

- 
- 
 • Press the target value key. The **green and the topmost red LED** start to flash and prompt you to enter the **upper weight limit for class 1** (this simultaneously corresponds to the lower limit for class 2). **Note:** The minimum weight specified in the master mode (section 4.4) for the response of the LEDs ("ZEROLI") forms the lower limit for class 1.
 - 

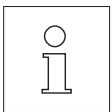
 • Enter the upper weight limit for class 1 using the numeric keypad (e.g. 2.30 kg) and confirm your entry by pressing the target value key again, **or** ...
 - 

 • ... press the switch key, load the weighing sample corresponding to the maximum weight of class 1 (or the minimum weight of class 2) and confirm the displayed value with the «» key.
 - 

 • The **green and the yellow LED** start to flash and prompt you to enter the **upper weight limit for class 2** (this corresponds to the lower weight limit for class 3).
 - 

 • Enter the upper weight limit for class 2 using the numeric keypad (e.g. 3.90 kg) and confirm your entry by pressing the target value key again, **or** ...
 - 

 • ... press the switch key, load the weighing sample corresponding to the maximum weight of class 2 (or the minimum weight of class 3) and confirm the displayed value with the «» key.

Notes

- 
 – If weight limits are already available from earlier weighings, these values are displayed. If you wish to accept such a value, there is no need to key it in again, you can simply adopt it with the target value key or the «» key.
- The scale checks your entries for plausibility and inadmissible entries are rejected with an error message (see section 8).

After entry of the weight limits, the scale returns to the weighing mode.

Storing weight classes

The weight classes (or their weight limits) can be permanently stored. The scale makes 3 memory locations available for this purpose (00 – 02). This allows you to store the weight classes for 3 different classifying operations and recall them at any time. To store the inputted values, proceed as follows:

0 2



- Use the numeric keypad to enter the number of the memory in which you wish to store the values (e.g. "02"). Then press the storage key.

StorE2

The storage is briefly confirmed in the display and the scale then returns to the weighing mode.

The stored values are retained until they are overwritten by a new storage operation.

Classifying weighing samples

The example below illustrates how you work with classifying in practice. It is assumed that the weight limits for the individual classes are already defined.

0 2



- Load the weight limits of the individual classes from the memory. Enter the number of the desired memory (00 – 02) and then briefly press the storage key to activate the values. **Note:** If you do not load any weight limits from the memory, the scale operates with the values last activated.

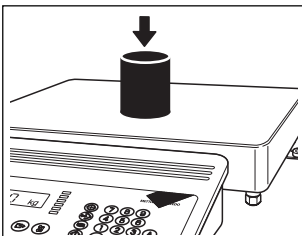

- Load the weighing sample to be classified and observe the LEDs:

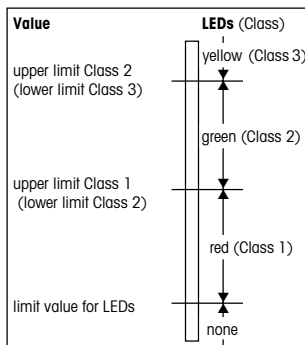

The **topmost red LED** lights up as soon as the weight of the weighing sample has reached the lower weight limit of class 1 (defined by the minimum weight specified in the master mode for the response of the LEDs).

As soon as the weight of the weighing sample has reached the upper weight limit of class 1 (= lower weight limit of class 2), the **green LED** lights up.

As soon as the weight of the weighing sample has reached the upper weight limit of class 2 (= lower weight limit of class 3), the **yellow LED** lights up.

6.4 Filling

Filling systems can be controlled with the plus/minus applications "Filling" ("Fill 1" for systems with 1 filling head, "Fill 2" for systems with 2 filling heads). Separate instructions are available for filling applications ("Filling with Spider 3S scales/Digital outputs", no. 21254202). They can be ordered from your METTLER TOLEDO dealer.

6.5 Notes on recording the applications

If you have selected the automatic transfer of the weight values ("AUTTRA" = "On") in the master mode and a printer is attached to your scale, the applications are recorded as follows:

Weighing in

If you change the target weight and/or the tolerances, the new values are automatically printed out. The actual weighing in is not recorded automatically.

Checkweighing

If you change the target value and/or the tolerances, the new values are automatically printed out. In checkweighing, every individual loaded weight is automatically recorded.

Classifying

If you change the weight limits for the individual classes, the new values are automatically printed out. In classifying, the weight and the class are automatically printed out for every loaded weighing sample.

You will find further directions on printing out application data and specimen records in the interface description of the Spider S scales available from your METTLER TOLEDO dealer.

7. Piece counting, totalization and formula weighing

Your Spider 3S scale offers you not only plus/minus applications, but also the following applications: Piece counting, totalization and formula weighing. You will learn how to use these applications in the following sections.

7.1 Notes on the application keys

Your Spider S scale has four application keys whose function depends on the application selected. In the standard equipment of your scale you will find two keypad stickers intended to facilitate piece counting, totalization and formula weighing. As the symbols are specific to the application in question, you will find it easier to remember the functions of the keys.

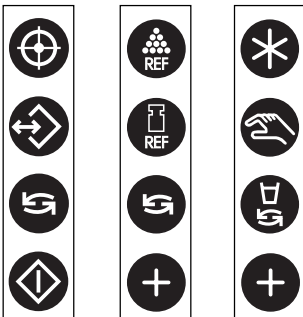

The illustration on the extreme left shows the standard symbols of the application keys of your Spider 3S scale (for plus/minus applications, section 6).

The illustration in the middle shows the **sticker for piece counting**. If you frequently work with this application, we advise you to use this sticker.

The illustration on the extreme right shows the **sticker for totalization and formula weighing**. Use this sticker if one of these applications forms the main basis of your work.

You will learn the respective functions of the four keys in the description of the applications in the following sections.

7.2 Piece counting

Piece counting assumes that you have preselected the "COUNT" application in the master mode (see section 4.4). **Note:** For piece counting with use of a reference balance/scale, a separate set of operating instructions is available from METTLER TOLEDO.



The **application keys** have the following meaning in piece counting:

- Automatic determination of the reference by placing the reference pieces on the pan and entry of the piece number



- Manual determination of the reference by entry of the known piece weight



- Switching between piece number and weight display. If the plus/minus display (LED chain) is switched on, specify the default values with this key.



- Totalization of the determined piece numbers and request of the total piece number and the number of weighings.

Piece counting with automatic determination of the reference

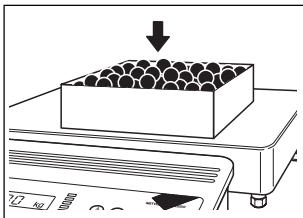

- If you work with a weighing container, place this on the pan and tare the scale with the «T» key.
- Add a known number of pieces.

Note: We advise you to select a reference piece number that is as large as possible as the scale determines the average weight per piece and stores this as the reference weight. Since all pieces seldom have exactly the same weight, the larger the reference piece number selected, the greater the accuracy of the reference weight (and hence also of your weighing).

3 2



- Enter the number of parts you have loaded on the pan (e.g. "32") using the numeric keypad (note: if you load exactly 10 pieces, you do not have to enter the number) and then press the key for automatic determination of the reference and ...

32 ^{Net} Pcs

... the weighed-in reference number appears in the display. The last reference remains stored and can be reactivated at any time with the key for automatic reference determination (provided the memory has not been cleared, the scale has not been switched off and no manual reference has been determined in the meantime).

Add 5

Note: If you have activated the add mode for piece counting in the master mode (see section 4.4) and the loaded piece number is too low for correct determination of the reference, you are prompted to load more pieces (e.g. 5 pieces). Load the requested number of pieces, enter the new total and then press the key for automatic determination of the reference (you can also ignore the prompt by pressing and holding the key for automatic determination of the reference until the scale accepts the reference weight. In such a case, the asterisk in the top left corner of the display indicates that the determined reference weight may possibly not be sufficiently accurate).

200 ^{Net} Pcs

- Now add more parts until the desired number (200 pieces in this case) is reached.

Piece counting with manual determination of the reference

- If you work with a weighing container, place this on the pan and tare the scale with the «T» key.



- Enter the known piece weight of a single part (e.g. "8.7 g") and then press the key for the manual reference determination. Note: If you are working with the weighing unit "kilogram", the scale requires **entry of the piece weight in grams**.

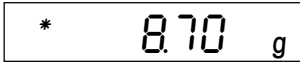

The display briefly shows the inputted reference weight and then ...



... the scale is ready for piece counting.

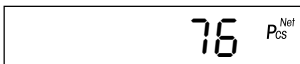

- Now add parts until the desired number (76 pieces in this example) is reached.

Counting parts out of a container

To count parts of equal weight when removing them from a full container, proceed as follows:

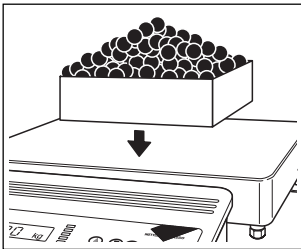

- Place the **full** weighing container on the scale. Then press the «T» key to tare the container.



- You can determine the reference **automatically or manually**:
- For **automatic determination of the reference**, remove parts from the container, key in their piece number and confirm the entry with the key for the automatic reference determination.



- For **manual determination of the reference**, key in the known weight of a single part (enter the reference weight in grams if you are working with the weighing unit "kilogram"). Then confirm the entry with the key for the manual reference determination.

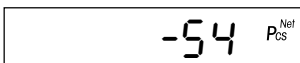









- Now remove parts from the container until the desired number is reached.

Working with the plus/minus display

The plus/minus display facilitates your piece counting work. The LEDs signal you whether the actual piece number corresponds to the preselected target value or whether it lies within the specified tolerances. Use of the LEDs presupposes that you have activated the plus/minus display for piece counting ("PM On") in the master mode (see section 4.4).

Before you can work with the plus/minus display, you must enter the desired default values:

- 
 - Press the switch key and keep it pressed until the **green LED** starts to flash and prompts you to enter the desired **target piece number**.
- 

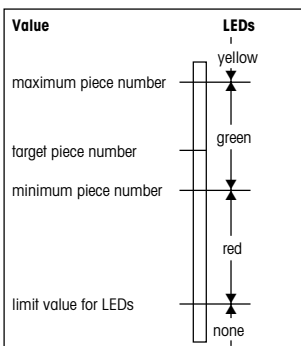
 - Enter the target piece number (e.g. 180 pieces) using the numeric keypad and confirm your entry with the «E» key.
- 

 - The **green and the yellow LED** start to flash and prompt you to enter the **upper tolerance (admissible overfilling)**. Enter the desired value (e.g. 2 pieces) and confirm your entry with the «E» key.
- 

 - The **green and the topmost red LED** start to flash and prompt you to enter the **lower tolerance (admissible underfilling)**. Enter the desired value (e.g. 1 piece) and confirm your entry with the «E» key.
- 

 - The **lowest red LED** starts to flash and prompts you to enter the **limit value for the response of the LEDs**. Enter the desired value (e.g. 170 pieces) and confirm your entry with the «E» key.



After entry of the default values, the scale returns to the weighing mode and is now ready for **piece counting using the plus/minus display**:

- As soon as the limit value for the response of the LEDs is reached in the counting in of parts, the lowest red LED lights up.
- When more parts are counted in, the remaining red LEDs light up in succession.
- As long as the weighed-in piece number lies within the admissible tolerances, the green LED remains lit up.
- After the upper tolerance has been exceeded, the yellow LED lights up.

Switching between piece number and weight display

You can switch between the piece number and weight display at any time.



The scale shows the piece number.



- Press the switch key briefly and ...

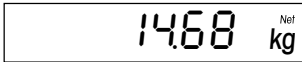

... the scale shows the weight.

Recording the piece counting



- If your scale is attached to a printer, briefly press the «» key and the result of the completed piece counting will be printed out.

Clearing the reference memory

The reference memory is automatically cleared as soon as you switch the scale off or determine a new reference (automatically or manually). However, you can clear the reference memory at any time as follows:



- Briefly press the key for manual determination of the reference and then immediately press the «**C**» key.

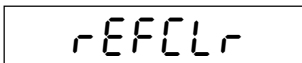

Clearing of the reference memory is briefly confirmed in the display and the scale then returns to the weighing mode.

Totalizing the piece numbers

You can totalize the piece numbers from the individual weighing operations and determine the number of items weighed in:



- Determine the reference, weigh in the first item and then press the totalization key.

- Tare the scale with the «T» key, weigh in the second item and then press the totalization key again.
- Weigh all additional items by the same procedure.

To request the number of weighed-in items and the total number of parts, proceed as follows:

- Press and hold the totalization key until ...

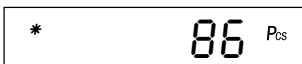

... the **total number of weighed-in parts** is displayed.

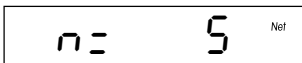

- Press the totalization key again briefly to show the **number of weighed-in items** in the display.

- Press the totalization key again briefly to return the scale to the piece counting mode.

Ending piece number totalization



To end the totalization of piece numbers, unload the scale and then press the «C» key until the scale returns to the weighing mode (if you do not unload the scale, an error message ("CLRSC" = Clear Scale) appears which prompts you to remove the weighing sample). On completion of piece counting, the totalization memory and the reference memory are cleared and the printout concluded (if your scale is connected to a printer).

7.3 Totalization

Totalization assumes you have preselected the application "TOTAL" in the master mode (see section 4.4.). This application allows you to weigh several weighing samples in succession and then determine the total weight and the number of weighed items.

The **application keys** have the following meaning in totalization:



– Shows the determined sum total and the number of totalized weighings.



– Manual entry of known weight values



– Displays the current intermediate total (stored values + current weight on the scale)



– Totalizes the weight values and stores the total.

To totalize the weighing samples, proceed as follows:

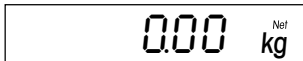

- If you work with a weighing container, place this on the pan and tare the scale with the «T» key.

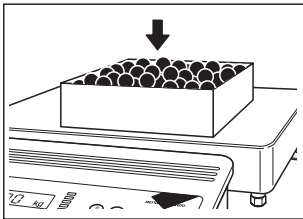

- Enter the desired amount of the **first item** to the weighing container (4.80 kg in this example).

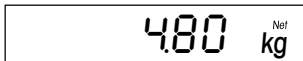

- Press the totalization key briefly to store the weight.

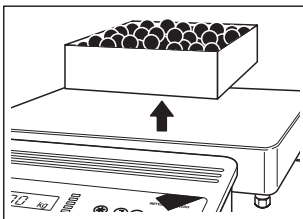

- Unload the scale

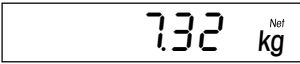
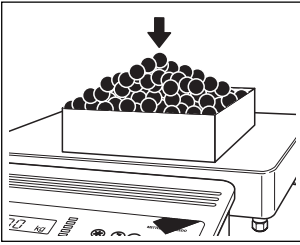

- Add the desired amount of the **second item** to the weighing container (7.32 kg in this example).

Note: If the second weighing container has a different weight than that of the first, you must tare it before the weighing.



- Press the totalization key briefly to store the weight.

- If desired, weigh in additional items as described above. You can weigh in up to 9999 items. Note that the scale must be unloaded between the individual weighings.

Note: Instead of placing a weighing sample on the pan, you can also enter the weight numerically. Key in the weight value and then press the key for manual entry. The weight value will be added to the existing total.

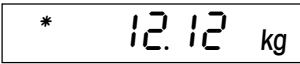

As soon as you have weighed in all items, you can request the total weight and the number of weighed items:

- Press the totalization key and ...

... the **total weight of all weighed-in items** appears in the display.

- Press the totalization key again and the **number of weighed-in items** appears in the display.

- Press the totalization key again briefly to return the scale to the normal display.



To end the totalization, unload the scale and then press the **«C»** key until the scale returns to the weighing mode (if you do not unload the scale, an error message ("CLRSC" = Clear Scale) appears which prompts you to remove the weighing sample). On completion of the totalization, the totalization memory is cleared and the printout concluded (if your scale is connected to a printer).

7.4 Formula weighing

Formula weighing assumes you have preselected the application "FORMU" in the master mode (see section 4.4). This application allows you to weigh in several components in succession and then determine the total weight and the number of components.

The **application keys** have the following meaning in formula weighing:



– Shows the determined sum total and the number of totalized weighings.



– Manual entry of known weight values



– Container change: Allows the determination of container-related totals



– Totalizes the weight values and stores the total.

Proceed as follows in formula weighing:

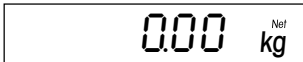

- Place the weighing container on the pan and tare the scale with the «T» key.

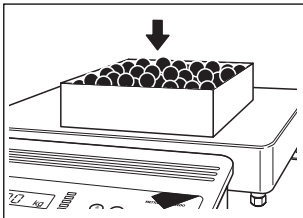

- Add the desired amount of the **first component** to the weighing container (1.12 kg in this example).

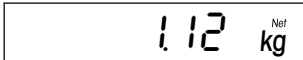

- Press the totalization key briefly to store the weight and reset the display to zero.

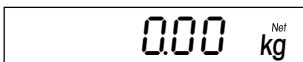

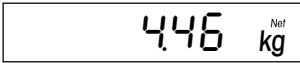
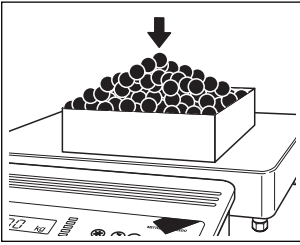

- Add the desired amount of the **second component** to the weighing container (4.46 kg in this example) and then again press the totalization key briefly to store the weight and reset the display to zero.

- If desired, add additional components to the weighing container and press the totalization key briefly to store the weight of the component. You can weigh in up to 9999 components.

Notes



- Instead of weighing in a component, you can also **enter its weight numerically**. Key in the weight value and then press the key for manual entry. The weight value will be added to the existing total.



- If you wish to **change the weighing container** during the formula weighing, unload the scale and press the key for container change. The display is reset to zero. You can now place the new weighing container on the pan, tare with the «T» key and continue your formula weighing.



As soon as you have weighed in all components, you can request the total weight and the number of weighed-in components:

- Press the totalization key and ...

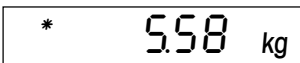

... the **total weight of all weighed-in components** appears in the display.



- Press the totalization key again briefly and the **number of weighed-in components** appears in the display.
- Press the totalization key again briefly to return the scale to the normal display.



To end the formula weighing, unload the scale and then press the «**C**» key until the scale returns to the weighing mode (if you do not unload the scale, an error message (“CLRSCl” = Clear Scale) appears which prompts you to remove the weighing sample). On completion of the formula weighing, the totalization memory is cleared and the printout concluded (if your scale is connected to a printer).

7.5 Notes on recording applications

If you have a printer, you can print out a detailed record of your applications. You will find information on printing out application data and specimen records in the interface description of the Spider S scales available from your METTLER TOLEDO dealer.







8. Further important information regarding your scale

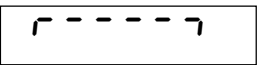
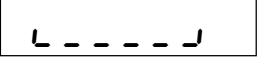
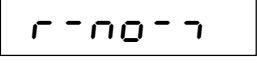
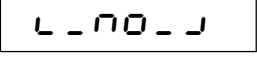
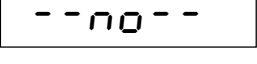

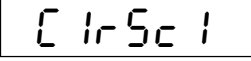
8.1 When faults appear

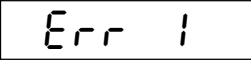
Error messages in the display draw your attention to the existence of an incorrect operation, the failure of the scale to execute a procedure properly or the appearance of a fault in the hardware or software of the scale.

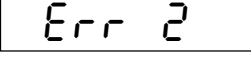
The following table provides you with information for interpretation of the error messages and symptoms, as well as details regarding the cause and rectification.

Error message/symptom	Cause	Rectification
	Overload: – Weighing range exceeded	<ul style="list-style-type: none"> • Unload scale or reduce preload
	Underload: – Weighing pan not in place – Weighing range exceeded – Contact between weighing pan and surroundings	<ul style="list-style-type: none"> • Ensure that weighing pan is correctly installed and surrounding parts are not touched • Set scale to zero • Apply preload
 	Zeroing not possible: – Zeroing outside the zero setting range (overload) – Zeroing outside the zero setting range (underload)	<ul style="list-style-type: none"> • Ensure that zeroing is performed only in the admissible range (on switching on: -2% to +18% of factory zero setting, on zeroing in operation: ±2% of the full load) and not on underload or overload
	Function not executable: – Error in application: Individual components/items have the value zero or the scale has not been unloaded	<ul style="list-style-type: none"> • Ensure that components/items do not have value zero and make sure procedure is correct (unloading)

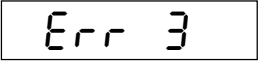
Error message/symptom	Cause	Rectification
	No stability of the display: <ul style="list-style-type: none"> – Unstable location – Unstable weighing sample – Contact between weighing pan or weighing sample and surroundings 	<ul style="list-style-type: none"> • Ensure more stable ambient conditions/weighing sample • Change setting of the vibration adapter in the master mode • Ensure that weighing pan and weighing sample do not touch surrounding parts
	Scale unloaded ("Clear Scale"): <ul style="list-style-type: none"> – Scale has not been unloaded 	<ul style="list-style-type: none"> • Unload scale and repeat process
	Wrong weighing result: <ul style="list-style-type: none"> – Wrong zeroing of scale – Wrong tare weight – Contact between weighing pan or weighing sample and surroundings – Scale not horizontal 	<ul style="list-style-type: none"> • Unload scale and repeat weighing • Clear tare weight or tare with correct tare weight • Ensure that weighing pan and weighing sample do not touch surrounding parts • Level scale (see section 2)
	Display remains "dark": <ul style="list-style-type: none"> – No line voltage – Scale switched off – Power cable not plugged in – Batteries discharged (in operation with the optional pack) 	<ul style="list-style-type: none"> • Check power supply • Switch on scale • Plug in power cable • Change batteries of battery pack or charge (see instructions for battery pack)
	Invalid time entry: <ul style="list-style-type: none"> – You have entered an invalid time in the master mode 	<ul style="list-style-type: none"> • Clear error message with the «» key and repeat entry
	Invalid date entry: <ul style="list-style-type: none"> – You have entered an invalid date in the master mode 	<ul style="list-style-type: none"> • Clear error message with the «» key and repeat entry

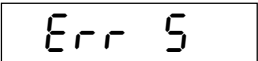
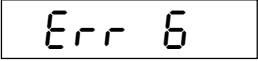
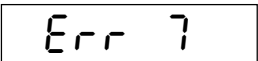
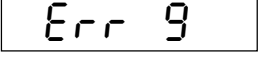
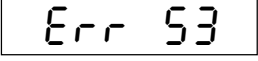
Error message/symptom	Cause	Rectification
	Invalid manual entry: – You have entered an invalid value manually in an application	<ul style="list-style-type: none"> • Repeat entry
	Reference weight too small: – The reference weight is too small	<ul style="list-style-type: none"> • Use a larger reference weight
	No valid weight value from reference scale: – The reference scale (second scale) has not supplied a valid weight value	<ul style="list-style-type: none"> • Check cabling and communication parameters and perform reference determination again
	No calibration: – The scale is not calibrated	<ul style="list-style-type: none"> • Contact your METTLER TOLEDO dealer
	Reference weight too small: – The weight of one single piece is below the permissible limit.	<ul style="list-style-type: none"> • Piece counting is not possible for the parts in question
	Unstable weight value: – The weight value did not achieve stability	<ul style="list-style-type: none"> • Repeat operation
	EAROM error: – Checksum error in EAROM	<ul style="list-style-type: none"> • Contact your METTLER TOLEDO dealer

8.2 Notes on caring for your scale

Your scale requires no maintenance work whatsoever and is extremely easy to clean. Regular cleaning assures the hygiene and also helps preserve the value of your scale.

Important notes



- Disconnect the scale from the power supply before you start the cleaning work!



- Please consult the in-plant and branch-specific regulations governing cleaning intervals and admissible cleaning agents. Never use acids, bases or powerful solvents for cleaning.

Terminal

- Clean the terminal with a suitable agent approved for your branch and with **water at a temperature of maximum 60 °C. Never use high-pressure cleaning equipment!**
- Dry the terminal immediately following cleaning with a soft, lint-free cloth.

Weighing platform

- Remove the weighing pan.
- Clean the weighing pan and the understructure of the weighing platform with a suitable agent approved for your branch and with **water at a temperature of maximum 60 °C. Never use high-pressure cleaning equipment!**



The rubber cover of the weighing cell must on no account be cleaned with sharp objects! This can cause leaks and lead to a situation where the IP protection is no longer assured!

- Dry the weighing platform immediately following cleaning with a soft, lint-free cloth.

8.3 Notes on the interface

Your scale is fitted with an RS232C serial interface and can also accommodate a second interface of the same type (as well with hardware handshake) or a RS422/485 interface available as an option. You will find information regarding the pin assignment, the commands, the configuration, attachment of peripherals (printer, computer) and on working with the interface in the separate interface description of the Spider S scales available from your METTLER TOLEDO dealer. If you purchase the second interface, the interface description is supplied.

8.4 Overview of the master mode

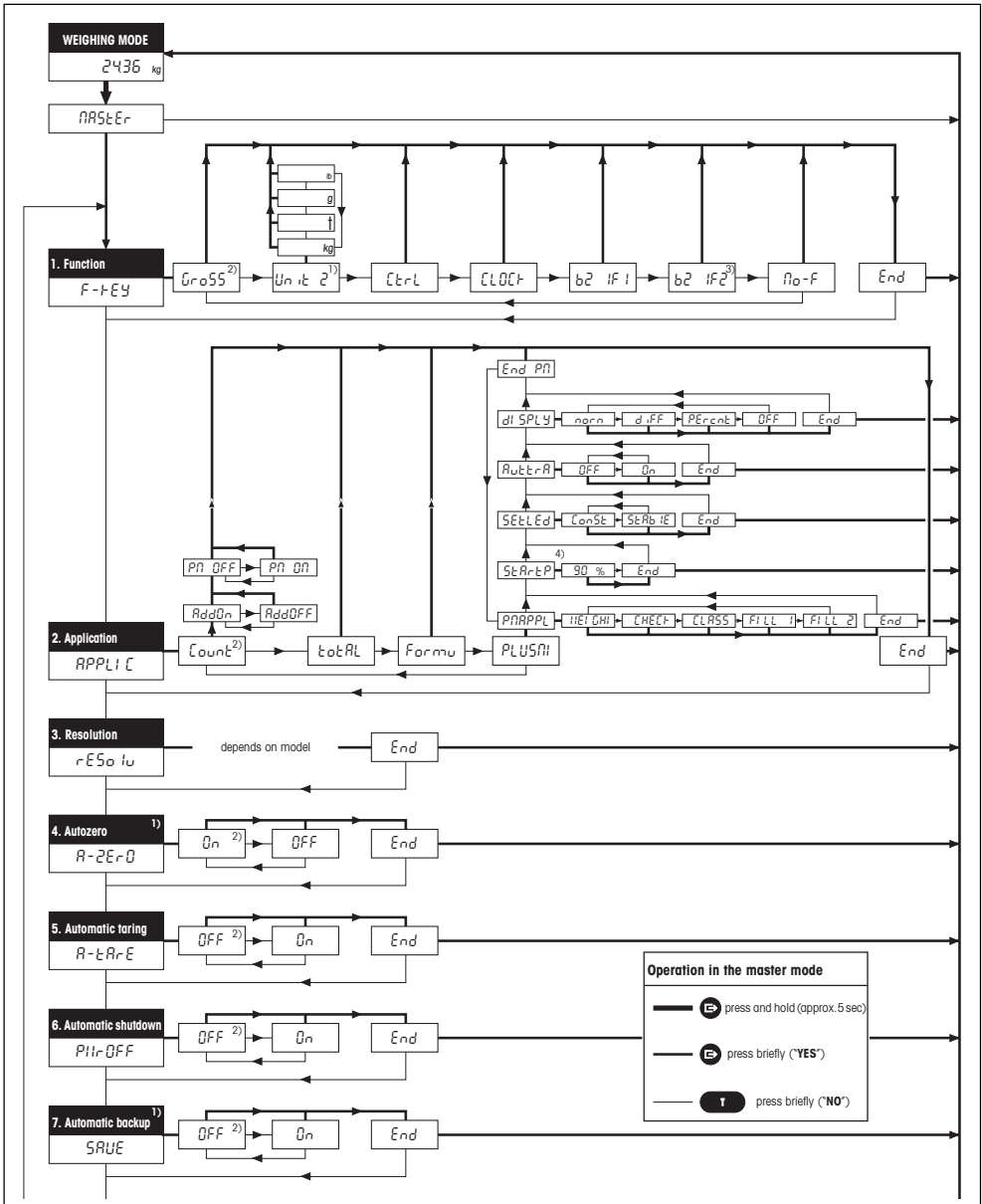

Overview of the master mode (continued)

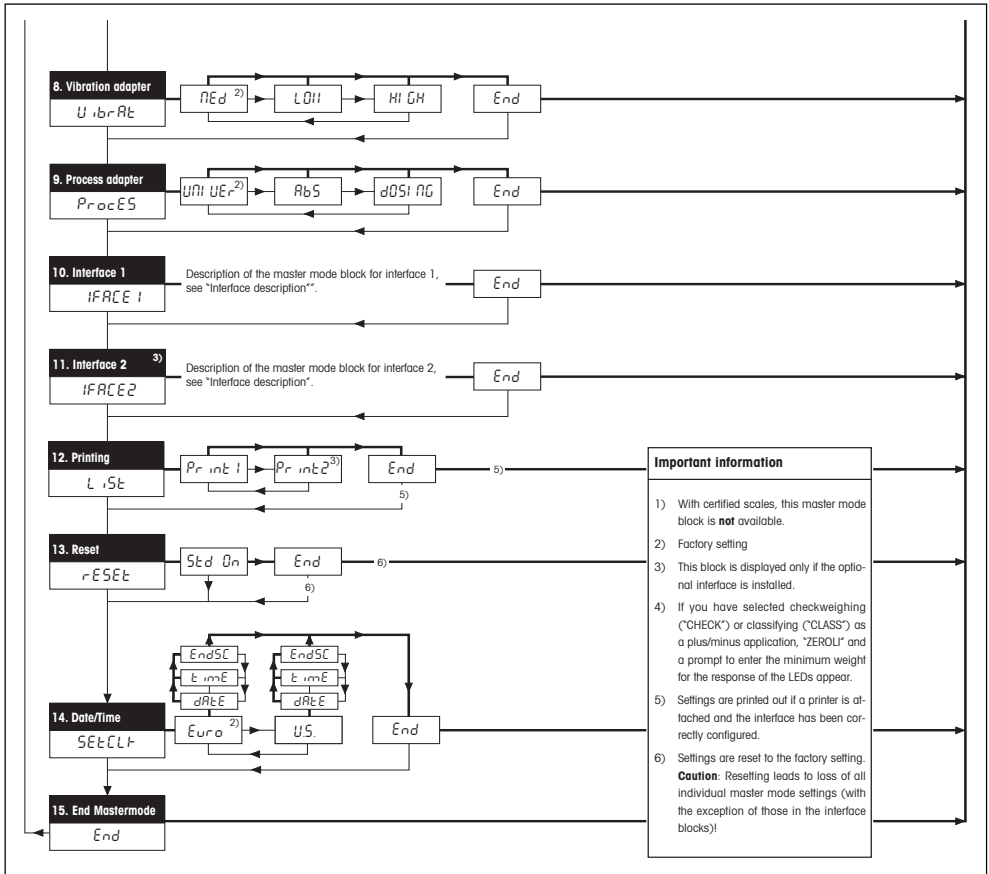

9. Technical data

9.1 General data and standard equipment of the Spider 3S scales

The following data apply to all Spider 3S models

Vibration adapter	3 settings
Weighing process adapter	3 settings
Weighing units	kg, t, g, lb (kilogram, metric ton, gram, pound), switchable in weighing operation
Resolution	Selectable (settings depend on model)
Applications	Plus/minus applications (weighing in, checkweighing, classifying, filling), piece counting, totalization, formula weighing
Functions	Automatic taring, automatic zeroing, shutdown function, automatic backup
Displays	LCD (liquid crystal display), height 20 mm , backlit LED chain (6 LEDs) for support of the plus/minus applications
Platform supply	5 V= (admissible platform impedance: 80 ohm ... 1000 ohm)
Interface	RS232C, serial, bidirectional (2nd interface optional) Signal level: -25 V= ... +25 V= (with $R_L \geq 3 \text{ k ohm}$)
IP degree of protection	Terminal and weighing platform to IP67
Ambient conditions	Admissible temperature range: -10 ... +40 °C Admissible relative atmospheric humidity: 85 % rh Overvoltage category: II Pollution degree: 2 Application height: up to 4000 above sea level
Power supply	Direct connection to power supply via national cable/connector 230 ..240 V (-15% / +10%), 50/60 Hz, power consumption: 80 mA 120 V (-15% / +10%), 50/60 Hz, power consumption: 160 mA
Standard equipment	Scale complete, operating instructions, 2 sets keypad stickers, open-end wrench

9.2 Data for individual models

Specifications

Model	Max. capacity	Readability	Net weight
Spider 3S-3S	3 kg	1 g	7.0 kg
Spider 3S-6S	6 kg	2 g	7.0 kg
Spider 3S-15S	15 kg	5 g	7.0 kg
Spider 3S-35S	35 kg	10 g	9.6 kg
Spider 3S-60S	60 kg	20 g	9.6 kg
Spider 3S-60LS	60 kg	20 g	14.8 kg
Spider 3S-60XLS	60 kg	20 g	24.7 kg
Spider 3S-60XXLS	60 kg	20 g	34.2 kg
Spider 3S-150S	150 kg	50 g	14.8 kg
Spider 3S-150LS	150 kg	50 g	24.7 kg
Spider 3S-150XLS	150 kg	50 g	34.2 kg
Spider 3S-300S	300 kg	100 g	24.7 kg
Spider 3S-300LS	300 kg	100 g	34.2 kg
Spider 3S-600S	600 kg	200 g	34.2 kg

Dimension drawings

Terminal

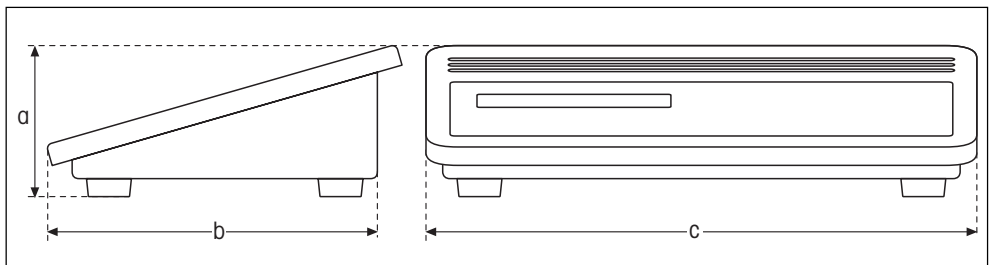

Weighing platform

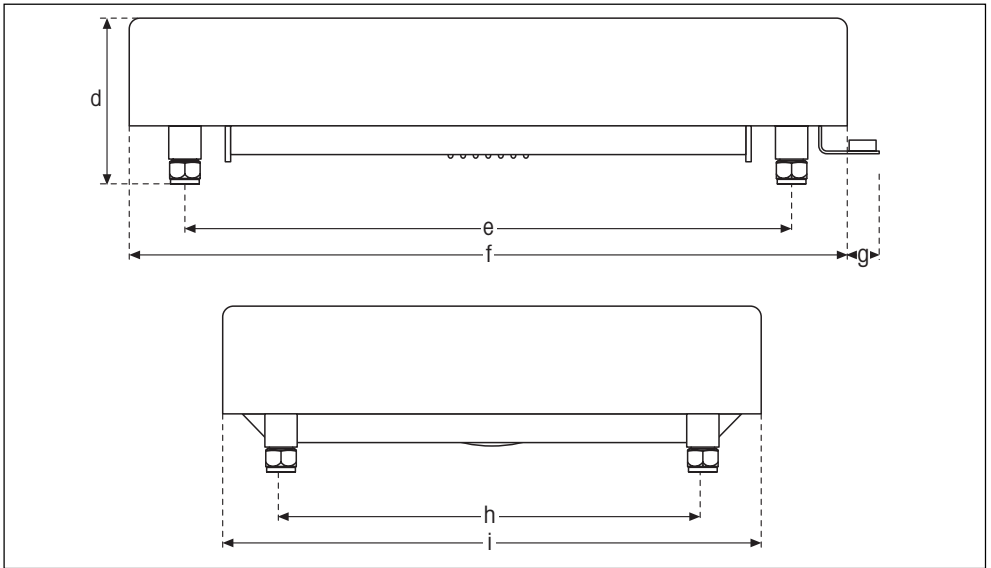

Dimensions (in millimeters)

Model	a	b	c	d ¹⁾	e	f	g	h	i
Spider 3S-3S	84	199	307	91	235	300	15	175	240
Spider 3S-6S	84	199	307	91	235	300	15	175	240
Spider 3S-15S	84	199	307	91	235	300	15	175	240
Spider 3S-35S	84	199	307	96	335	400	15	235	300
Spider 3S-60S	84	199	307	96	335	400	15	235	300
Spider 3S-60LS	84	199	307	99	435	500	15	335	400
Spider 3S-60XLS	84	199	307	104	585	650	20	435	500
Spider 3S-60XXLS	84	199	307	125	724	800	21	503	600
Spider 3S-150S	84	199	307	99	435	500	15	335	400
Spider 3S-150LS	84	199	307	104	585	650	20	435	500
Spider 3S-150XLS	84	199	307	125	724	800	21	503	600
Spider 3S-300S	84	199	307	104	585	650	20	435	500
Spider 3S-300LS	84	199	307	125	724	800	21	503	600
Spider 3S-600S	84	199	307	125	724	800	21	503	600

¹⁾ when leveling feet fully screwed in

**To protect your METTLER TOLEDO product's future:
METTLER TOLEDO service assures you of quality, measuring
accuracy and preservation of value of the METTLER TOLEDO
products for years to come.
Please send for full details of our attractive terms of service.
Many thanks.**



P21253251

Subject to technical changes and to the availability
of the accessories supplied with the instruments.

Printed on recycled paper.
Because we care.

© Mettler-Toledo GmbH 1999 21253251A Printed in Switzerland 9907/2.12

Mettler-Toledo GmbH, CH-8606 Greifensee, Switzerland, Tel. (01) 944 22 11, Fax (01) 944 30 60, Internet: <http://www.mt.com>

AT Mettler-Toledo Ges.m.b.H., A-1100 Wien, Tel. (01) 604 19 80, Fax (01) 604 28 80
AU Mettler-Toledo Ltd., Port Melbourne, Victoria 3207, Tel. (03) 9646 4551, Fax (03) 9645 3935
BE n.v. Mettler-Toledo s.a., B-1651 Lot, Tél. (02) 334 02 11, Fax (02) 378 16 65
BR Mettler-Toledo Indústria e Comércio Ltda., São Paulo, CEP 06465-130, Tel. (11) 421 5737, Fax (11) 725 1962
CA Mettler-Toledo Inc., Ontario L7R3Y8, Tel. (905) 681 7011, Fax (905) 681 1481
CH Mettler-Toledo (Schweiz) AG, CH-8606 Greifensee, Tel. (01) 944 45 45, Fax (01) 944 45 10
CN Mettler-Toledo Instr. (Shanghai) Ltd., Shanghai 200233, Tel. (21) 6485 0435, Fax (21) 6485 3351
CZ Mettler-Toledo, spol. s.r.o., CZ-12000 Praha 2, Tel. (2) 251 555, Fax (2) 242 47 583
DE Mettler-Toledo GmbH, D-35353 Giessen, Tel. (0641) 50 70, Fax (0641) 52 951
DK Mettler-Toledo A/S, DK-2600 Glostrup, Tel. (43) 27 08 00, Fax (43) 27 08 28
ES Mettler-Toledo S.A.E., E-08038 Barcelona, Tel. (03) 223 22 22, Fax (03) 223 02 71
FR Mettler-Toledo s.a., F-78222 Viroflay, Tél. (01) 309 717 17, Fax (01) 309 716 16
HK Mettler-Toledo (HK) Ltd., Kowloon HK, Tel. (852) 2744 1221, Fax (852) 2744 6878
HR Mettler-Toledo, d.o.o., CR-10010 Zagreb, Tel. (1) 660 2189, Fax (1) 660 3009
HU Mettler-Toledo Kft, H-1173 Budapest, Tel. (1) 257 9889, Fax (1) 257 7030
IT Mettler-Toledo S.p.A., I-20026 Novate Milanese, Tel. (02) 333 321, Fax (02) 356 29 73
JP Mettler-Toledo K.K., Shiroimi, J-Osaka 540, Tel. (6) 949 5901, Fax (6) 949 5945
KR Mettler-Toledo (Korea) Ltd., Seoul (135-090), Tel. (02) 518 20 04, Fax (02) 518 08 13
MY Mettler-Toledo (M) Sdn.Bhd., 47301 Petaling Jaya, Tel. (03) 703 2773, Fax (03) 803 8773
MX Mettler-Toledo S.A. de C.V., Mexico CP 06430, Tel. (5) 547 5700, Fax (5) 541 2228
NL Mettler-Toledo B.V., NL-4000 HA Tiel, Tel. (0344) 638 363, Fax (0344) 638 390
NO Mettler-Toledo A/S, N-1008 Oslo, Tel. (22) 30 44 90, Fax (22) 32 70 02
PL Mettler-Toledo, Sp. z o.o., PL-02-929 Warszawa, Tel. (22) 651 92 32, Fax (22) 42 20 01
RU Mettler-Toledo AG, 10 1000 Moskau, Tel. (095) 921 68 12, Fax (095) 921 63 53
SE Mettler-Toledo AB, S-12008 Stockholm, Tel. (08) 702 50 00, Fax (08) 642 45 62
SG Mettler-Toledo (S) Pte. Ltd., Singapore 139944, Tel. (65) 778 6779, Fax (65) 778 6639
SK Mettler-Toledo service, s.r.o., SK-83103 Bratislava, Tel. (7) 525 2170, Fax (7) 525 2173
SL Mettler-Toledo, d.o.o., SL-61111 Ljubljana, Tel. (6) 112 35 764, Fax (6) 127 4575
TH Mettler-Toledo (Thailand), Bangkok 10310, Tel. (02) 719 64 80, Fax (02) 719 64 79
TW Mettler-Toledo Pac Rim AG, Taipei, Tel. (62) 579 59 55, Fax (62) 579 59 77
UK Mettler-Toledo Ltd., Leicester, LE4 1AW, Tel. (0116) 235 0888, Fax (0116) 236 5500
US Mettler-Toledo, Inc., Worthington, Ohio 43085, Tel. (614) 438 4511, Fax (614) 438 4755
US Mettler-Toledo, Inc., Hightstown, NJ 08520-0071, Tel. (609) 448 3000, Fax (609) 586 5451

For all other countries: Mettler-Toledo GmbH, PO Box VI-400, CH-8606 Greifensee, Tel. (01) 944 22 11, Fax (01) 944 31 70