

Operating instructions

METTLER TOLEDO B-S/FACT line of balances

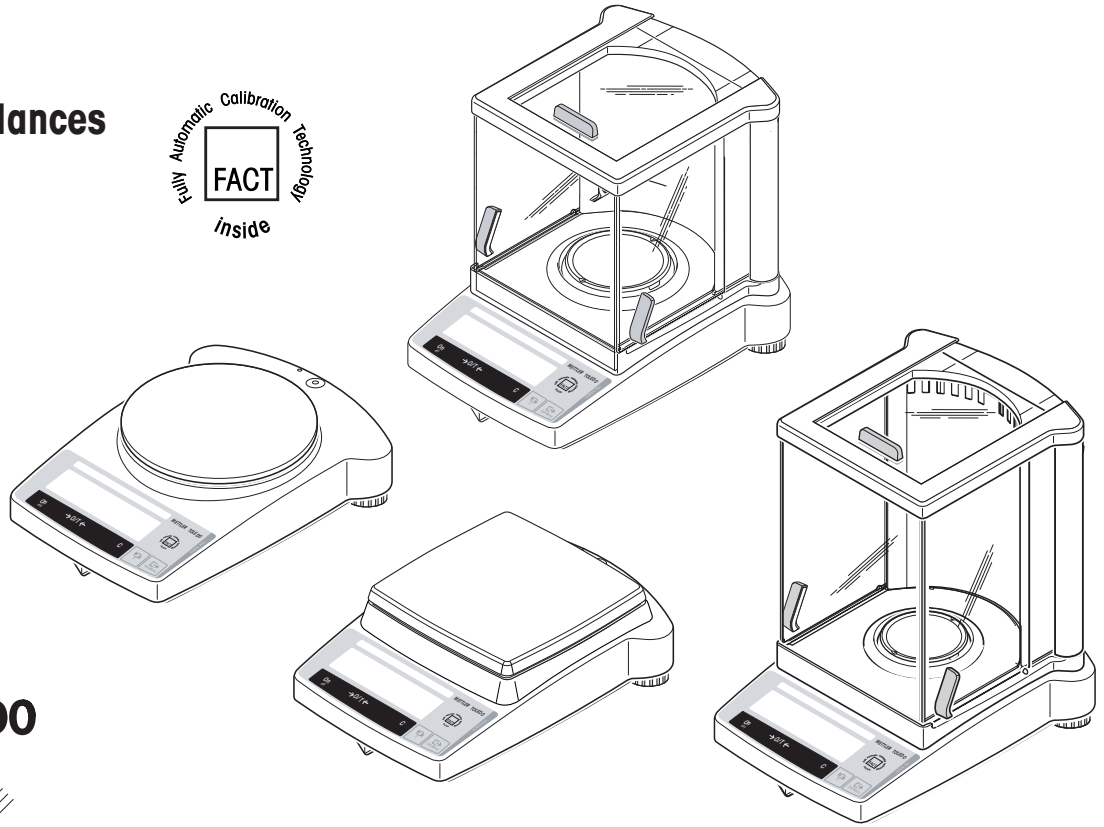

- AB-S/FACT
- PB-S/FACT



METTLER TOLEDO

www.mt.com/classic

Operating instructions in a nutshell

 Press key **briefly**
 Press and **hold key down** until the desired display appears
 automatic sequence

Switching on

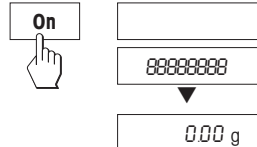

Switching off

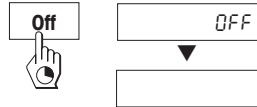

Simple weighing

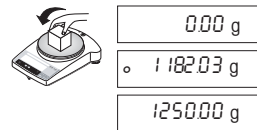

Adjustment options

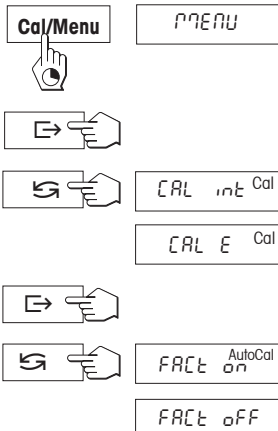

Taring

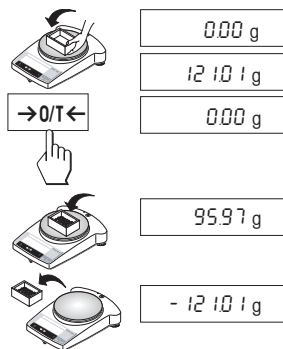

Piece counting*

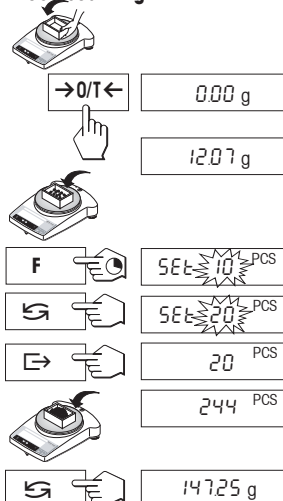

Percent weighing*

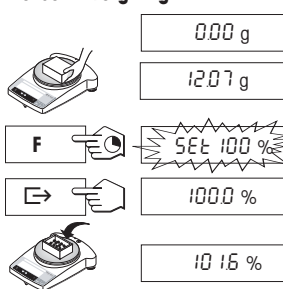

Dynamic weighing*

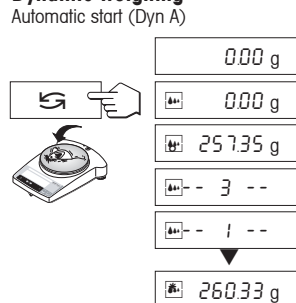

Manual start (Dyn M)

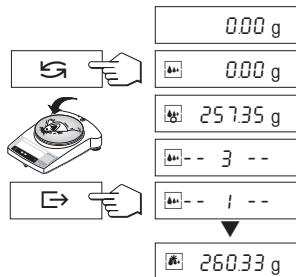

Unit switching*

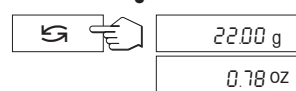

Free factor / selectable display increment*

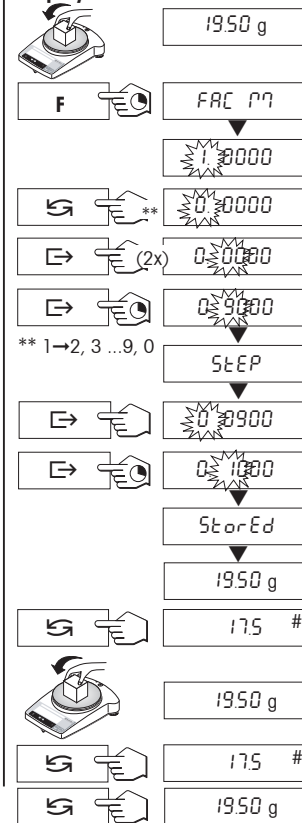

*These functions must be activated in the menu (section 4.3.4)

Contents

1	Getting to know B-S/FACT balances	4
1.1	Introducing the B-S/FACT line of balances	4
1.2	Layout of B-S/FACT balances	5
1.3	Overview of key functions	6
2	Startup	7
2.1	Unpacking / standard equipment	7
2.2	Cautionary notes	7
2.3	Installing the draft shield	8
2.4	Setting up, leveling, preparations for weighing below the balance, connecting to power supply	9
2.5	Adjusting (calibration)	11
3	Weighing	13
3.1	On/off switching	13
3.2	Simple weighing	13
3.3	Taring	14
3.4	METTLER TOLEDO DeltaRange balances	15
4	Menu	16
4.1	Overview	16
4.2	Menu operation	17
4.3	Description of menu options	18
5	Functions	25
5.1	Piece counting	25
5.2	Percent weighing	26
5.3	Dynamic weighing	27
5.4	Weighing with free factor and/or selectable display increments	29
5.5	Switching weight units	31
6	Technical data, optional equipment	32
6.1	Technical data	32
6.2	Interface	34
6.3	MT-SICS Interface commands and functions	35
6.4	Optional equipment	37
6.5	Dimensional drawings	38
7	Appendix	40
7.1	Typical printouts from METTLER TOLEDO RS-P26 and LC-P45 printers	40
7.2	What if ...?	41
7.3	Maintenance and cleaning	42

1 Getting to know B-S/FACT balances

1.1 Introducing the B-S/FACT line of balances

AB-S/FACT (0.1 mg / 0.01 mg)

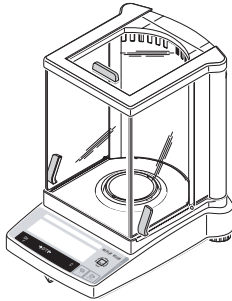

PB-S/FACT

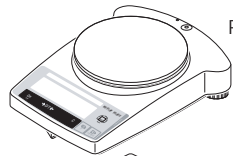

PB-S/FACT (0.01 g)

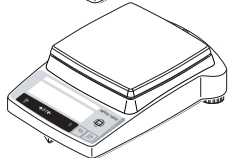

PB-S/FACT (0.1/1 g)

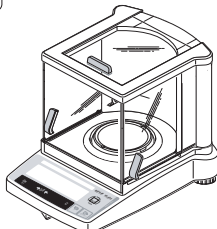

PB-S/FACT (0.001 g)

Balance features

- The B-S/FACT balance line ranges from high-resolution analytical balances (AB-S/FACT) with a readability of 0.1 mg / 0.01 mg through to precision balances (PB-S/FACT) with a readability of 0.001g to 1g. The weighing ranges extend from 51g to 8.1kg.
- **FACT** (Fully Automatic Calibration Technology), fully automatic, motorized adjustment (calibration) with internal weight.
- In addition to basic weighing operations such as **weighing**, **taring** and **adjusting** (calibration) the functions **"Piece counting"**, **"Percent weighing"**, **"Free Factor"** or **"Dynamic weighing"** (automatic or manual start) can be activated.
- METTLER TOLEDO **DualRange** balances have two ranges. These models also have a fine (semimicro) range from 0 to 31 g respectively 61 g. In this fine range the balance shows the result with a higher resolution, i.e. with one decimal place more.
- METTLER TOLEDO **DeltaRange** balances also have a movable fine range, with 10 times smaller display increments, over the the entire weighing range.
- Several B-S/FACT balances are fitted with a glass draft shield in the factory; with other models a **draft shield** is available as an **optional extra**.
- All balances are fitted with an **RS232C interface** as standard.
- All models have an **internal adjustment weight**.

Note

All B-S/FACT balances are available as certified versions. Please ask your METTLER TOLEDO dealer for details.

1.2 Layout of B-S/FACT balances

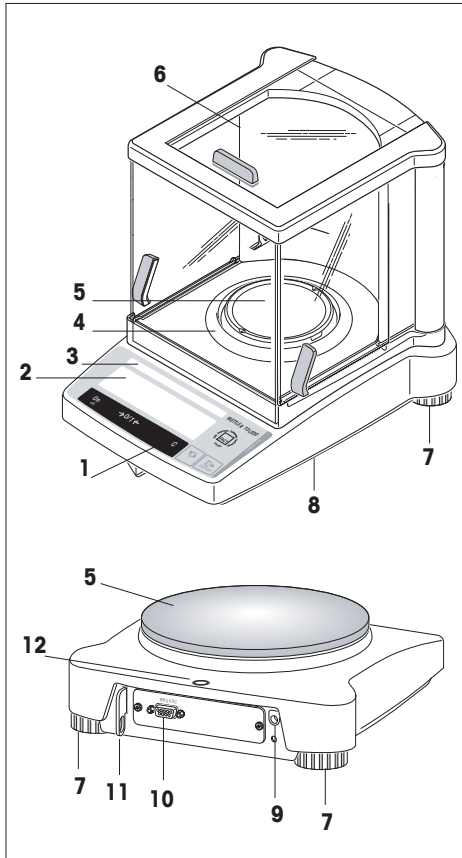





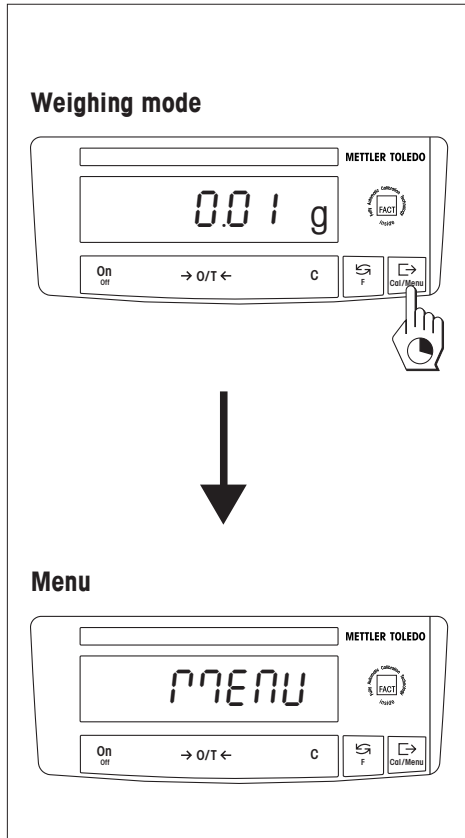



- 1 Keys
- 2 Display with backlight (except ABxx5-S/FACT)
- 3 Model plate with the following data:
 - “Max”: maximum capacity
 - “d”: readability
 - “Min”: minimum capacity (recommended minimum load; **only relevant for certified balances**)
 - “e”: verification scale interval (smallest display increment tested during certification; **only relevant for certified balances**)
- 4 Draft shield element
- 5 Weighing pan
- 6 Draft shield (standard supply with models AB-S/FACT and PBxx3-S/FACT)
- 7 Leveling feet
- 8 Hanger opening for weighing below the balance (underside of balance)
- 9 AC adapter socket
- 10 RS232C interface
- 11 Lug for optional anti-theft device
- 12 Leveling control

1.3 Overview of key functions



The balances have two operator control levels: the **weighing mode** and the **menu**. The function of each individual key depends on the operator control level and how long the key is pressed.

Key functions in weighing mode	
Press briefly 	Press and hold down 
On <ul style="list-style-type: none"> • Switch on →0/T← <ul style="list-style-type: none"> • Zero/tare C <ul style="list-style-type: none"> • Cancel function 	Off <ul style="list-style-type: none"> • Switch off balance (standby mode)
 <ul style="list-style-type: none"> • Switch • Change settings 	F <ul style="list-style-type: none"> • Call function A function must be activated in the menu, otherwise "F nonE" appears in the display
 <ul style="list-style-type: none"> • Transfer weighing data via interface • Confirm settings 	Cal/Menu <ul style="list-style-type: none"> • Adjust (calibrate) • Show menu (hold key down until MENU appears)

Key functions in menu mode	
Press briefly 	Press and hold down 
C <ul style="list-style-type: none"> • Close menu (without saving changes) 	-----
 <ul style="list-style-type: none"> • Change settings 	-----
 <ul style="list-style-type: none"> • Select menu options 	Cal/Menu <ul style="list-style-type: none"> • Save changes and close menu

2 Startup

2.1 Unpacking / standard equipment

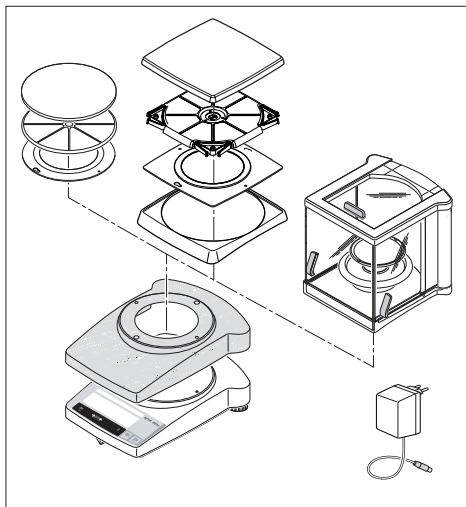

2.2 Cautionary notes



All B-S/FACT balances are supplied in environmentally compatible packaging.

The standard equipment for every balance comprises:

- **AC adapter**, to national codes
- **AC adapter with country-specific power cable** (Models AB135-S/FACT / AB265-S/FACT)
- **Transparent plastic protective cover**, fitted, to keep your balance clean at all times
- **Operating instructions**, to ensure optimum utilization of your balance's capabilities
- **CE declaration of conformity** (in separate brochure 11780294)

AB-S/FACT with readability of 0.01/ 0.1 mg:

- **Weighing pan \varnothing 80 mm with draft shield element**
- **Draft shield "0.1 mg" (237 mm)**

PB-S/FACT with readability of 0.001 g:

- **Weighing pan \varnothing 100 mm with draft shield element**
- **Draft shield "mg" (165 mm)**

PB-S/FACT with readability of 0.01 g:

- **Weighing pan \varnothing 180 mm with pan support**
- **Retaining ring for protective cover, fitted**

PB-S/FACT with readability of 0.1/1 g:

- **Weighing pan 180 x 180 mm with pan support**
- **Base plate and intermediate plate for protective cover, fitted**

- B-S/FACT balances must **not** be operated in **hazardous areas** with the standard-supply AC adapter.
- Before connecting the AC adapter, verify that the voltage printed on it corresponds to the local mains voltage. If this is not the case, please contact your local METTLER TOLEDO dealer.
- B-S/FACT balances may only be used indoors in a dry environment.
- For use with an certified (CSA or equivalent) power supply, which must have a limited and SELV circuit output.

2.3 Installing the draft shield



Draft shield "0.1 mg" (237 mm):

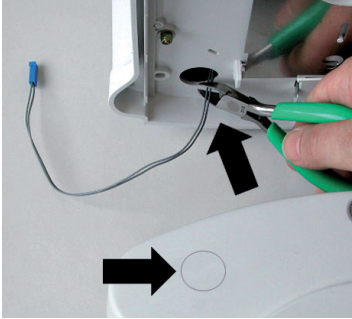

ABxx5-S/FACT

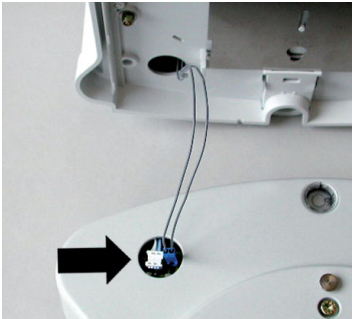

1

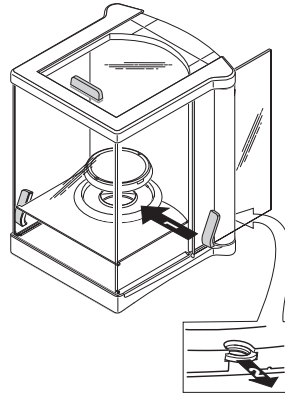

2

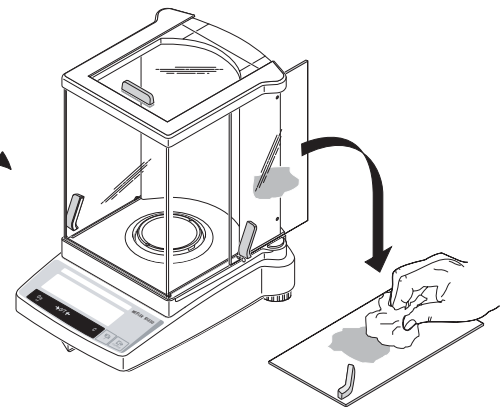
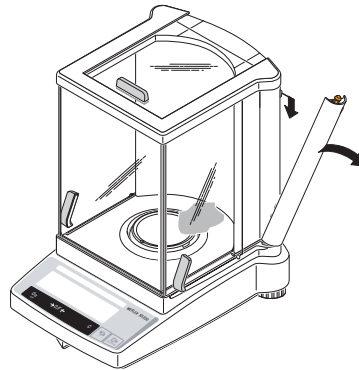
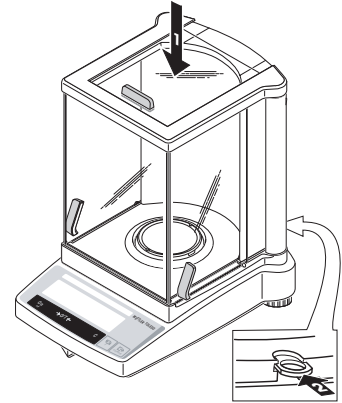

2.4 Setting up, leveling, preparations for weighing below the balance, connecting to power supply

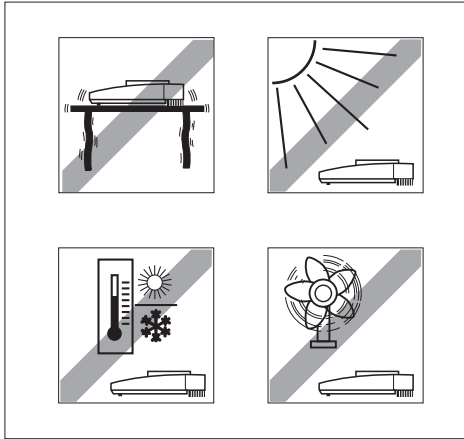

The optimum location

The correct location makes an important contribution to the accuracy of the weighing results of high-resolution analytical and precision balances.

Hence, ensure a

- stable, vibration-free position as horizontal as possible

Avoid

- direct sunlight
- excessive temperature fluctuations
- drafts

The best location is on a stable bench in a corner protected against drafts, as far away as possible from doors, windows, radiators or the louvers of air conditioners.

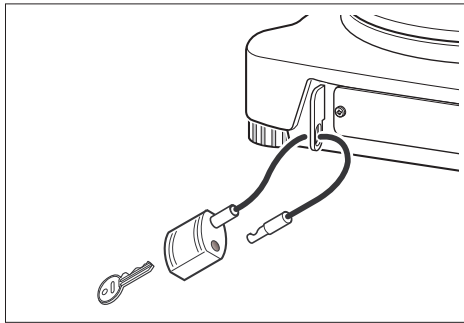

Anti-theft device

B-S/FACT balances are equipped with a lug for the optional anti-theft device.

The anti-theft device (cable with lock) is suitable for all models. It is available from METTLER TOLEDO under the order number 590101.

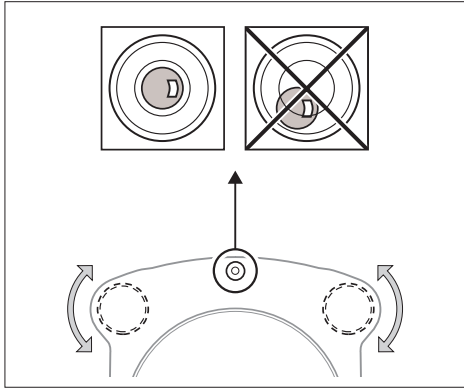

Leveling

B-S/FACT balances have a spirit level and two adjustable leveling feet to compensate for slight irregularities in the surface of the weighing bench. The balance is exactly horizontal when the air bubble is in the middle of the level glass.

Procedure

Adjust the two leveling feet appropriately until the air bubble comes to rest exactly in the middle of the glass:

Air bubble at "12 o'clock"	turn both feet counterclockwise
Air bubble at "3 o'clock"	turn left foot clockwise, right foot counterclockwise
Air bubble at "6 o'clock"	turn both feet clockwise
Air bubble at "9 o'clock"	turn left foot counterclockwise, right foot clockwise

Note

The balance should be leveled and adjusted (Section 2.5) each time it is moved to a new location.

Preparations for weighing below the balance

To carry out weighing operations below the balance, the special cover on the underside of the balance must be slackened (care: when doing this the balance may only be laid on its side, not turned upside down!), turned through 180° and retightened. This exposes the opening for the hanger, making weighing below the balance possible.

Connecting the power supply

- Before connecting the AC adapter, check that the voltage printed on it corresponds to the local mains voltage. If this is not the case, please contact your local METTLER TOLEDO dealer.
- Plug the AC adapter into the AC adapter socket on the balance, and connect to the power supply.
- The balance performs a self-test. This test is finished when "OFF" appears.
- Press the «On» key briefly: the balance is in operational readiness. Before any work is performed with the balance, it must be adjusted (Section 2.5).

Notes

To achieve accurate results with analytical balances (AB-S/FACT), these must be connected to the power supply for at least 60 minutes to warm up to operating temperature before the first weighing operation is carried out.

An optional AccuPac B-S (rechargeable external battery) can be used to operate all B-S/FACT balances independently of the mains power supply

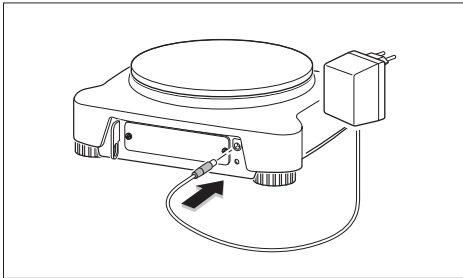

2.5 Adjusting (calibration)



To obtain accurate weighing results, the balance must be adjusted to match the gravitational acceleration at its location. Adjusting is necessary:

- before the balance is used for the first time
- at regular intervals during weighing service
- after a change of location

2.5.1 Fully automatic adjustment (calibration) FACT

The **factory setting** is **fully automatic adjustment FACT** (Fully Automatic Calibration Technology) with the internal weight (see also Section 4.3.3). In this setting, you have no need worry about adjusting your balance. The balance adjusts itself automatically

- after the warm-up phase on connection to the power supply,
- when a change in the ambient conditions, e.g. the temperature could lead to a noticeable deviation in the measurement.

2.5.2 Manual adjustment (calibration)

To obtain accurate results, the balance must be connected to the power supply for 30 minutes (AB-S/FACT analytical balances 60 minutes) in order to reach operating temperature before adjusting.

Adjusting with internal weight

- To carry out this operation, in the second menu option (Adjustment) select "CAL int" (=factory setting) (Section 4.1).
- Unload weighing pan
- Press and hold the «Cal/Menu» key down until "CAL" appears in the display, then release key.
- The balance adjusts itself automatically.

The adjusting is finished when the message "CAL done" appears briefly in the display, followed by "0.0000 g". The balance is again in weighing mode and ready for operation.

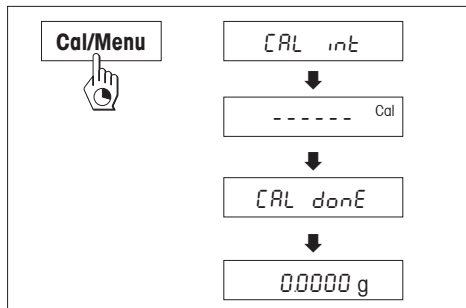

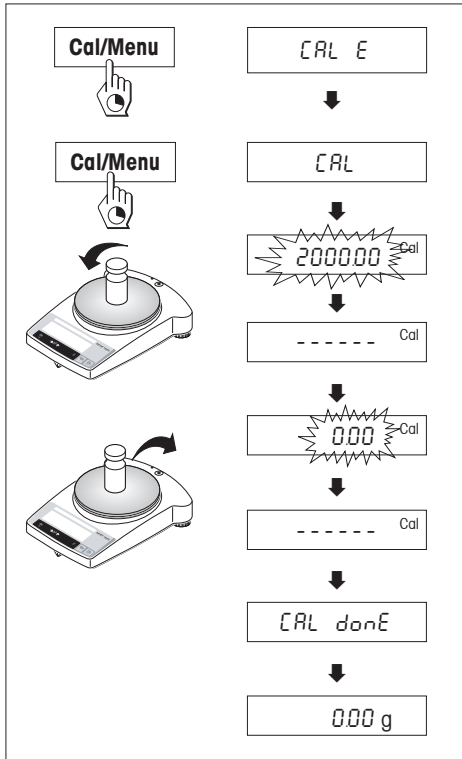

Adjusting with external weight

- To carry out this operation, in the second menu option (Adjustment) select "CAL E"
- Have required adjustment weight ready
- Unload weighing pan
- Press and hold the «**Cal/Menu**» key down until "CAL" appears in the display, then release key. The required adjustment weight value flashes in the display.
- Place adjustment weight in center of pan. The balance adjusts itself automatically.
- When "0.00 g" flashes, remove adjustment weight. The adjusting is finished when the message "CAL done" appears briefly in the display, followed by "0.00 g". The balance is again in weighing mode and ready for operation.

Notes

- Because of certification legislation, the **certified models** cannot be adjusted with an external weight.
- The adjustment procedure can be terminated at any time with the «**C**» key. The message "Abort" appears briefly to confirm that adjustment has been canceled, and the balance reverts to weighing mode.

3 Weighing

3.1 On/off switching

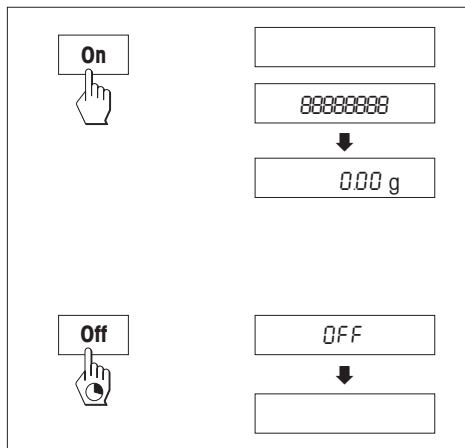

Switching on

- Remove any load from weighing pan and press «**On**» key briefly.
The balance performs a display test (all segments in the display light up briefly).
When zero is displayed, the balance is ready for operation.

Switching off

- Press and hold the «**Off**» key down until "OFF" appears in the display. Release the key.

3.2 Simple weighing

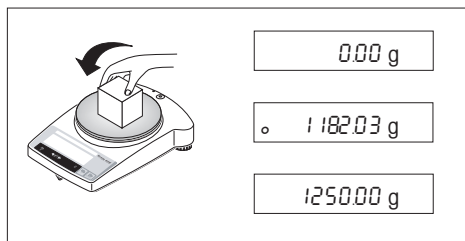

- Place weighing sample on the weighing pan.
- Wait until the stability detector "o" disappears.
- Read the result.

3.3 Taring

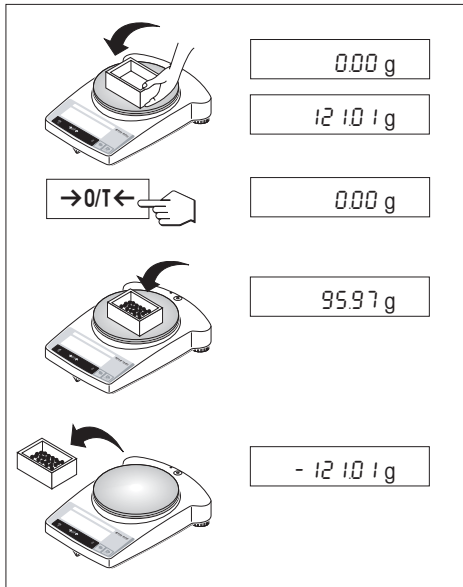

- Place empty container on the balance.
- The weight is displayed.
- Tare: press the « $\rightarrow 0/T \leftarrow$ » key briefly.
- Add weighing sample to container. The net weight is now displayed.

If the container is removed from the balance, the tare weight will be shown as a negative value. The tare weight remains stored until the « $\rightarrow 0/T \leftarrow$ » key is pressed again or the balance is switched off.

Note

With METTLER TOLEDO DeltaRange balances (next Section), the fine range with its 10 times smaller display increments is available again after every taring operation.

3.4 METTLER TOLEDO DeltaRange balances

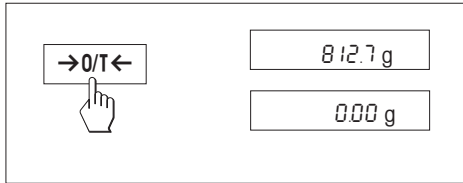

METTLER TOLEDO **DeltaRange balances** have a movable fine range with 10 times smaller display increments over their entire weighing range. In this fine range an additional decimal place always appears in the display.

The balance operates in the fine range

- after switching on
- after every taring operation

If the fine range is exceeded, the balance display automatically switches to coarser display increments.

4 Menu

4.1 Overview

In the menu you can change the weighing unit (for certified balances, only if the national certification law allows), select additional functions and carry out various settings. A description of the individual menu options is given in Section 4.3.

Notes

- 1) This menu option is only available on AB135-S/FACT and AB265-S/FACT models.
- 2) With certified balances, this menu option has a fixed setting and cannot be changed.
- 3) These menu option is only shown if "FACT on" (Factory setting) has been selected in menu option 3 (FACT).
- 4) With certified balances, only those weighing units allowed by the appropriate national weights and measures legislation may be selected.
- 5) This menu option is only shown if "Host" has been selected in menu option 12 (Peripheral unit).
- 6) These menu options are only shown if "Host" or "Printer" has been selected in menu option 12 (Peripheral unit).

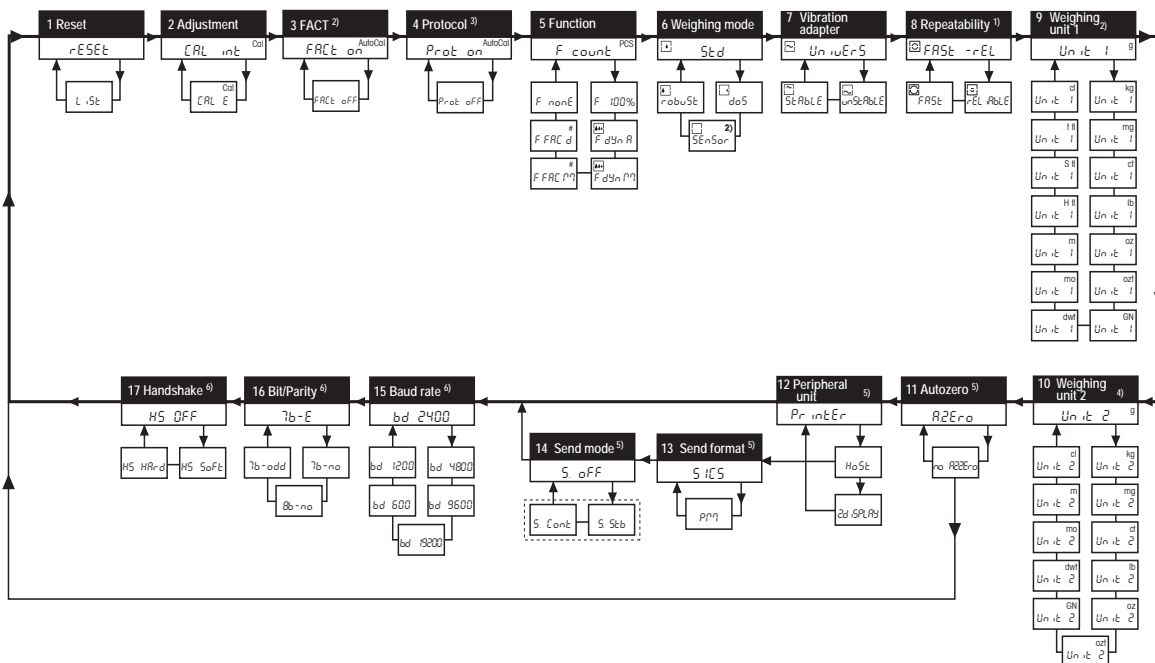

Menu option

Factory setting

4.2 Menu operation

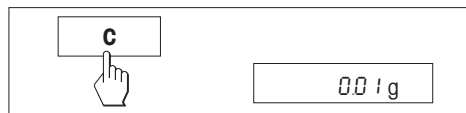
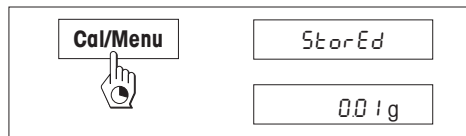
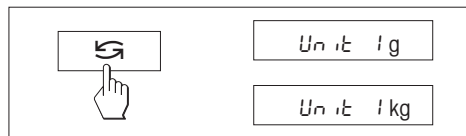
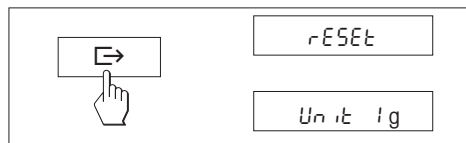
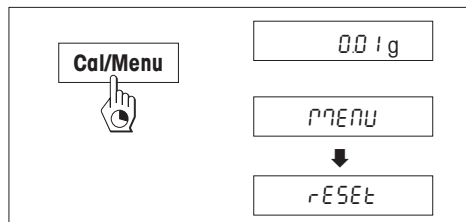

Opening the menu

In weighing mode, press and hold down the «**Cal/Menu**» key until "MENU" appears in the display. Release the key: the 1st menu option is displayed.

Select menu options

The «**→**» key is used to select individual menu options with their current settings one after the other.

Change settings

The «**↻**» key is used to change the setting at the selected menu option. Every time the key is pressed, the next setting is displayed. Once the desired setting appears in the display, the next menu option can be selected (see above) or you can close the menu (see following sections).

Saving settings and closing the menu

Hold the «**Cal/Menu**» key down until "StorEd" appears in the display. Release the key and the balance reverts to weighing mode. All changes are saved.

Abort

Press the «**C**» key briefly. The balance reverts to weighing mode. Changes are not saved.

Note

If no entry is made within 45 seconds, the balance reverts to weighing mode. Changes are not saved.

4.3 Description of menu options

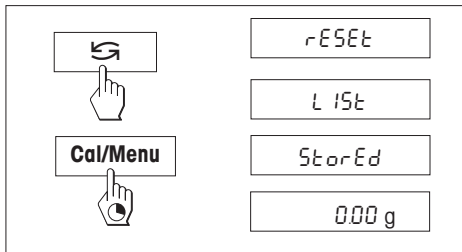
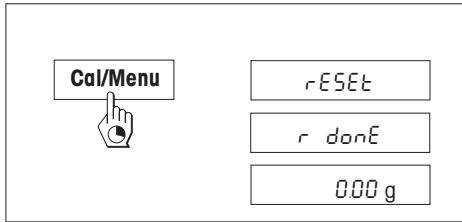

4.3.1 Reset or recording of balance settings (1st menu option "RESET")

Reset balance settings

- Select "Reset", press and hold down the **«Cal/Menu»** key until the message "r donE" confirms that all menu settings have been reset. The balance then reverts to weighing mode and works with the **factory settings** (Section 4.1).

Recording balance settings

- Select "List" and hold down the **«Cal/Menu»** key until the message "StorEd" is displayed.

The current balance settings are transmitted to the peripheral device connected to the interface. To do this the setting "Printer" must always be selected at the 11th menu option (Peripheral unit). The current balance settings are saved at the same time.

4.3.2 Adjustment (2nd menu option)

In this menu option you can select whether you wish to adjust the balance using the internal or the external adjustment weight. Because of certification legislation, the **certified models** cannot be adjusted with an external weight.

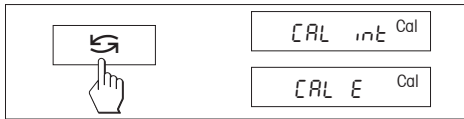

Adjusting with internal adjustment weight

Adjusting with external adjustment weight

4.3.3 FACT (3rd menu option)

In this menu option you can switch the fully automatic internal adjustment (calibration) FACT on or off.

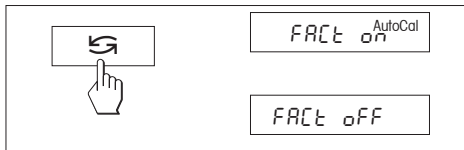

FACT switched on

This is the **factory setting**. The balance adjusts (calibrates) itself fully automatically.

FACT switched off

Note: With the certified versions of balances, this option can not be selected, i.e. FACT is always active

4.3.4 Protocol (4th menu option)

This menu item can be used to switch the printing of the FACT fully automatic adjustment (calibration) on or off.

Note: This menu item can only be selected if FACT is switched on and does not affect the printing of adjustments with an internal or external adjustment weight (Section 4.3.3).

Protocol switched on

A record is printed out after every automatic adjustment of the balance (FACT).

Note: The protocol is printed out without a line for signatures.

Protocol switched off

This is the factory setting. If the balance adjusts automatically (FACT), a protocol is not printed out.

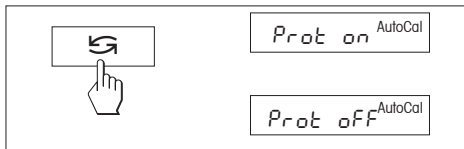

4.3.5 Functions (5th menu option / Operating Section 5)

In addition to simple weighing, the following functions can be selected:

F count	Piece counting
F 100 %	Percent weighing
F dYn A	Dynamic weighing with automatic start
F dYn M	Dynamic weighing with manual start
F FAC M	Multiply free factor value by weight, change size of display increment
F FAC d	Divide free factor value by weight, change size of display increment
F nonE	No function, simple weighing (factory setting)

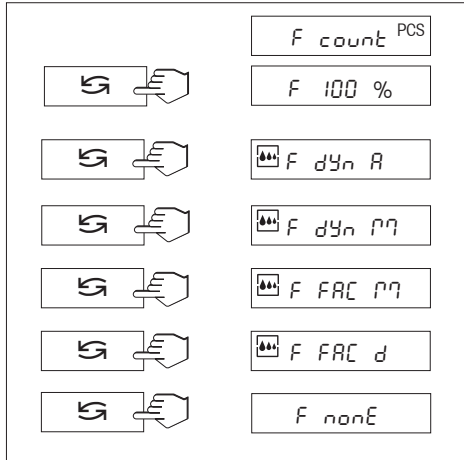

4.3.6 Weighing mode (6th menu option)

This setting allows you to adapt the balance to the weighing mode. Select "Std" (standard) for all normal weighing processes or "doS" (dispensing) for dispensing liquid or powdery weighing samples. In this setting, the balance responds very quickly to smallest weight changes.

When set to "robuSt" (absolute weighing), the balance responds only to greater weight changes, and the weighing result is very stable.

When set to "SEnSor", the balance delivers a raw, unfiltered weighing signal, and is only suitable for special applications. (Only available on AB135-S/FACT / AB265-S/FACT models).

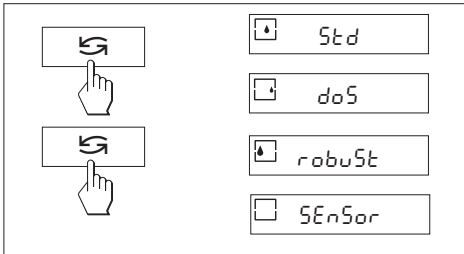

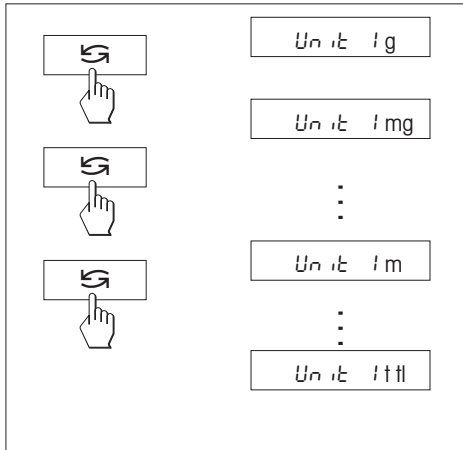
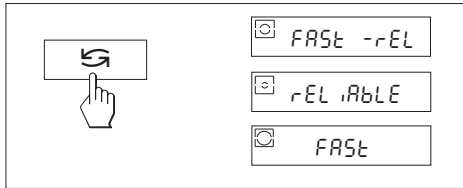
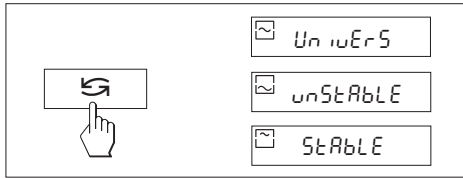

4.3.7 Vibration adapter (7th menu option)

The vibration adapter can be used to match your balance to the ambient conditions (vibrations, drafts at location). If you work in surroundings which are practically free from temperature fluctuations, drafts, and vibrations, select "Stable". On the other hand, if you work in surroundings where the conditions are constantly changing, select "unStAbLE". For normal ambient conditions, select "UnivErS" (Standard). This is the factory setting.

4.3.8 Measurement release (Repeatability) (8th menu option) (Only on AB135-S/FACT / AB265-S/FACTmodels)

You can use this setting to specify how rapidly the balance considers the measurement value to be stable and releases it. The "FAST" setting is recommended if you require rapid results and their repeatability is of secondary importance. The "rELiAbLE" setting gives very good repeatability of the measurement results, but lengthens the stabilization time. When the balance is set to "FAST -rELiAbLE" (fast and reliable), the weight display is quickly released as stable, and gives good repeatability. This is the factory setting.

4.3.9 Weighing unit 1 (9th menu option "UNIT 1")

Depending on requirements, the balance can operate with the following units (possible with certified balances only if permitted by national weights and measures legislation):

Unit	Conversion factor	Comments
g	gram	factory setting, 0.1 mg
kg	kilogram	not with 0.01 mg and 1 mg balances
mg	milligram	with 0.01 mg, 0.1 mg and 1 mg balances
ct	carat	
lb	Pfund	
oz	Unze	
ozt	Troy Unze	
GN	Grain	
dwt	Pennyweight	
mo	Momme	
m	Mesghal	
H tl	Hong Kong Taels	
S tl	Singapur Taels	the Malaysian tael has the same value
t tl	Taiwan Taels	
cl	Tical	

4.3.10 Weighing unit 2 (10th menu option "UNIT 2")

If it is required to show the weighing results in weighing mode in an additional unit by pressing the «» key, the desired second weighing unit can be selected in this menu option. The same weighing units are available as under "UNIT 1", with the exception of the tael units ("H tl", "S tl" and "t tl").

4.3.11 Autozero (11th menu option)

This menu option allows you to switch the automatic zero correction on or off. When it is switched on, the zero point is automatically corrected for drift or contamination of the weighing pan.

The following settings are available:

Autozero switched on

The zero point is automatically corrected.

Autozero switched off

The zero point is not automatically corrected. This setting is advantageous for special applications (e.g. evaporation measurements).

Note

With certified balances, this setting is possible only with a resolution of $e = 10d$.

4.3.12 Peripheral unit (12th menu option)

At this menu option you can select the peripheral device connected to the optional RS232C interface. The balance automatically saves the appropriate settings (Section 4.3.13 – 4.3.17) for every peripheral device.

Printer Connected to a printer.

Host Connection to any desired peripheral device.

Aux. display Connection of an optional auxiliary display unit (communications parameters cannot be selected).

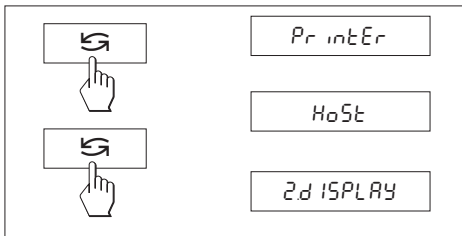
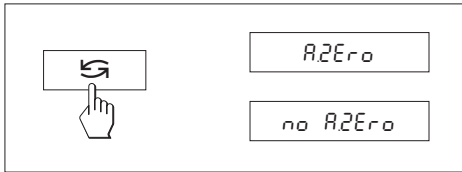

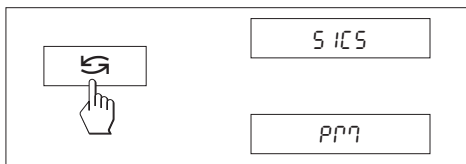

4.3.13 Send format (13th menu option)

Note: This menu option is only available if you have selected the setting "Host" in the 12th menu option (Peripheral unit)!

At this menu option you specify the data transfer format.

"SICS": The MT-SICS data transfer formats are used. Please refer to the "MT-SICS Reference Manual Basic-S balances 11780447" available from your METTLER TOLEDO dealer or download from the Internet (www.mt.com/sics-classic). More Information please find in the Section 6.3.

"PM"*: The following PM balance data transfer formats are used:

S. Stb: `LLLLL1.67890Lg` S. Cont: `LLLLL1.67890Lg`
`SDLLLL1.39110Lg`

Additional information can be found on the Internet at www.mt.com/classic.

* unidirectional, no MT-SICS commands are accepted.

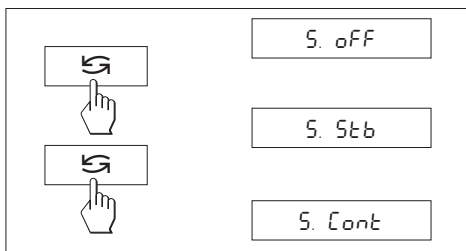

4.3.14 Send mode (14th menu option)

Note: This menu option is only available if you have selected the setting "Host" in the 12th menu option (Peripheral unit)!

At this menu option you specify how data is transmitted to a peripheral device.

S. oFF Send mode switched off

S. Stb The next possible stable value will be transferred after the « \square » key has been triggered.

S. Cont All values are transferred automatically.

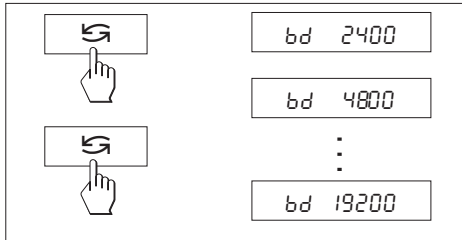

4.3.15 Baud rate (15th menu option)

Note: This menu option is only available if you have selected the setting “Host” in the 12th menu option (Peripheral unit)!

The baud rate (data transfer rate) determines the speed of transmission via the serial interface. The unit is the baud (bd) = 1 bit/second.

The following settings are available: 600 bd, 1200 bd, 2400 bd, 4800 bd, 9600 bd and 19200 bd.

For problem-free data transmission the sending and receiving devices must be set at the same value.

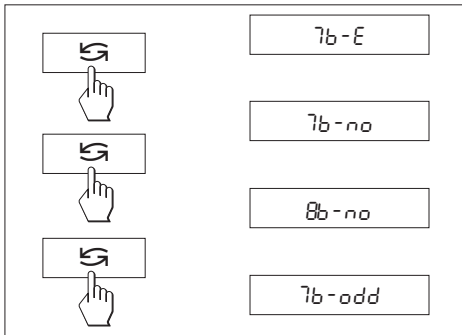

4.3.16 Bit/Parity (16th menu option)

Note: This menu option is only available if you have selected the setting “Host” in the 12th menu option (Peripheral unit)!

At this menu option you can set the character format for the attached peripheral device.

7b-E 7 data bits/even parity

7b-no 7 data bits/no parity

8b-no 8 data bits/no parity

7b-odd 7 data bits/odd parity

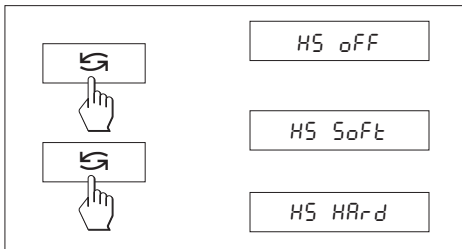

4.3.17 Handshake (17th menu option)

Note: This menu option is only available if you have selected the setting “Host” in the 12th menu option (Peripheral unit)!

This menu option allows you to match the data transmission to different serial receivers.

HS oFF No handshake

HS SoFt Software handshake (XON/XOFF)

HS HAr-d Hardware handshake (RTS/CTS)

5 Functions

5.1 Piece counting

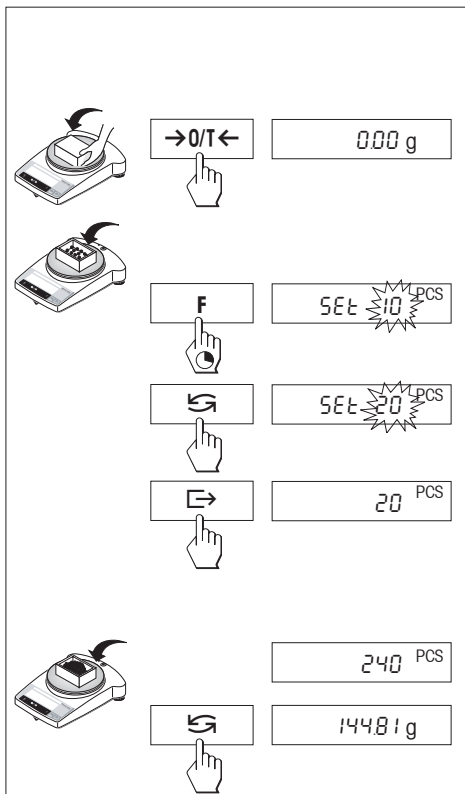

Requirement

The function "F count" must be activated in the menu (Section 4).

→ Place empty container on the balance and tare by briefly pressing the «**→0/T←**» key.

Setting the reference: a reference weight must first be entered for piece counting:

→ Add a number of reference pieces to container. Possible numbers* are 5, 10, 20, 50, 100 and "no" (this setting deactivates the piece counting function). ***approved balances** min 10

Caution: Take into account minimum values: min. reference weight = 10d (10 digits), min. piece weight* = 1d (1 digit)! ***approved balances** min 3e

Note: 1 digit corresponds to 1 display increment.

→ Hold the «**F**» key down until "SET ... PCS" is displayed.

→ Repeatedly press the «**↺**» key until the display equals the number of reference pieces entered.

→ Confirm the number of reference pieces with the «**→**» key (or wait 7 seconds, in which case the number is adopted automatically). The current number of pieces (PCS = pieces) is displayed.

Note: The current reference weight remains stored until the reference setting is changed or the power supply is interrupted.

Switching between piece count and weight display

→ Add weighing sample to the container and read off number of pieces.

→ Press the «**↺**» key. The weight is displayed.

→ Return to the piece count display by pressing the «**↺**» key again.

5.2 Percent weighing

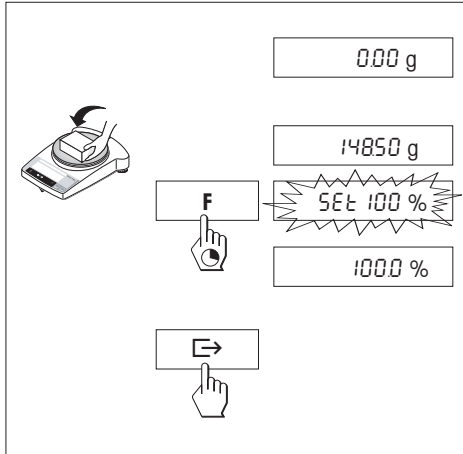

Requirement

The function "F 100 %" must be activated in the menu (Section 4).

Set target weight

- Target weight (Reference weight, which corresponds to 100 %) in center of pan.
- Hold the «F» key down until "SEt 100 %" is displayed.
- Press the «E» key to select "SEt 100 %" or "SEt no %" (Percent weighing deactivated).
- The «E» key can be used briefly to confirm or automatic acceptance after 7 seconds. The target weight is specified.

Note: The current target weight remains stored until a new target weight is set or the power supply is interrupted.

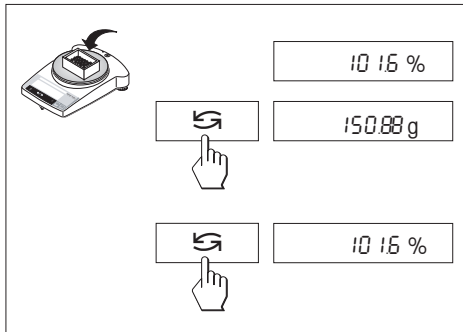

Percent weighing / switching

- Place weighing sample in center of pan.
The weight of the sample is displayed as a percentage of the target weight.
- Press the «E» key, The weight is displayed. (Unit 1 and and Unit 2, if activated).
- Return to display in percent: pressing the «E» key again.

5.3 Dynamic weighing

Dynamic weighing is suitable for the weighing of unstable weighing samples. The mean value of the weighing results is determined over a specified time period (weighing time). The more unstable the weighing sample, the longer the selected weighing time.

Requirement

"F dYn A" for automatic start or "F dYn M" for manual start must be activated in the menu (Section 4).
Factory setting is a weighing time of 3 seconds ($t = 3''$).

Tare container

→ Tare: Press the «→0/T←» key.

Dynamic weighing with automatic start (F dYn A)

→ The «↺» key can be used select the dynamic weighing. The display shows the symbol .

→ Load weighing sample. As soon as the balance is relatively stable, weighing starts automatically. During the weighing time, a "count down" runs in the display.

→ Read off result.

The result of the dynamic weighing is displayed with * (= calculated value) and remains in the display until the weighing sample is removed from the weighing pan or the container.

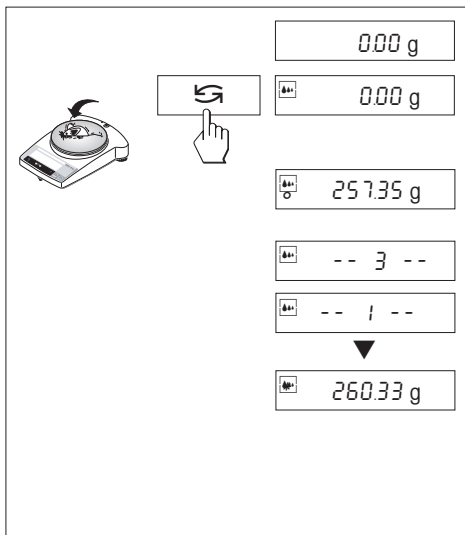

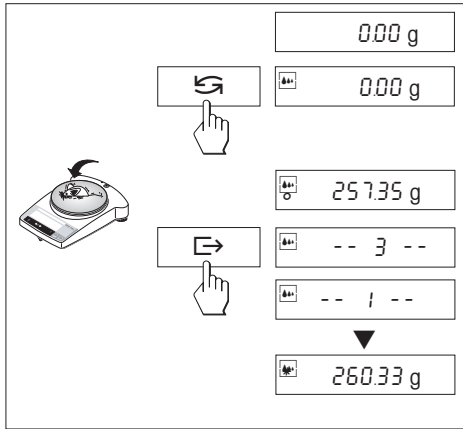

Dynamic weighing with manual start (F dYn M)

→ The «F» key can be used to select the dynamic weighing. The display shows the symbol .

→ Load weighing sample.

→ Start weighing with the «F» key.
During the weighing time, a "count down" runs in the display.

→ Read off result.

The result of the dynamic weighing is displayed with * (= calculated value) and remains in the display until the weighing sample is removed from the weighing pan or the container.

Notes

- The weighing cycle with the same weighing sample can be restarted with the «F» key.
- The «F» key can be used to switch between dynamic weighing and normal weighing.
- For weighing goods below 5 g the weighing must be started **manually** with the «F» key, even for dynamic weighing with automatic start.

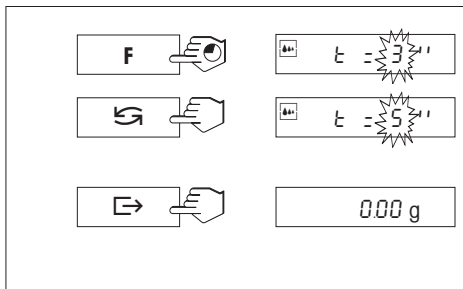

Changing the weighing time

→ Press and hold the «F» key, until "t = 3" appears in the display.

→ Repeatedly press the «F» key, until the desired weighing time appears.
Possible values are 3", 5", 10", 20", 1", 2".

→ Selection with the «F» key briefly to confirm or by automatic acceptance after 3 seconds.

Note

The set weighing time remains stored until it is reset or the power supply fails.

5.4 Weighing with free factor and/or selectable display increments

In this menu option a custom "free factor" can be defined at will.

This value is then either multiplied ("F FAC M") by the weighing result (in grams), i.e. $\text{reading} = \text{factor} \times \text{weight}$, or it is divided ("F FAC d") by the weight, i.e. $\text{reading} = \text{factor} / \text{weight}$. The range of possible factors depends on the resolution of the balance. Common values are:

F FAC d 1 to 10'000

F FAC M < 1 to 10'000

The "free factor" (FAC M) function can, for example, be used to calculate the price of the material weighed directly or to calculate the weight per defined unit of surface area. It can also be used to convert the weight into any desired alternative unit. This facility for dividing the factor by the weight (FAC d) is required for instance in the textile industry to determine yarn count.

The ability to select the display increments makes it possible to specify how the weighing result is to be presented, the choice of display increments being limited by the set factor and the resolution of the balance model itself.

Requirement

The function "F FAC M" or "F FAC d" must be activated in the menu (Section 4).

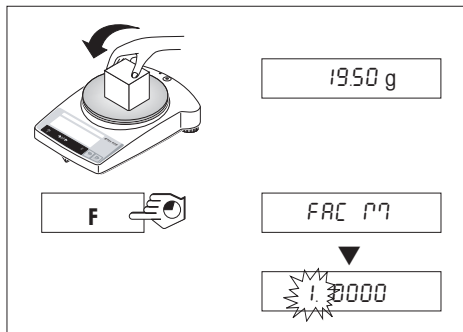

Entering the free factor and/or the display increments

- Hold the «F» key down until "FAC M" or "FAC d" appears in the display.
- The «↶» key can be used to switch between "FAC M" and "FAC d," and "noFAC M" and "noFAC d" (function deactivated).
- Release the key. Either the factor 1 appears as default value or the factor that was saved most recently.

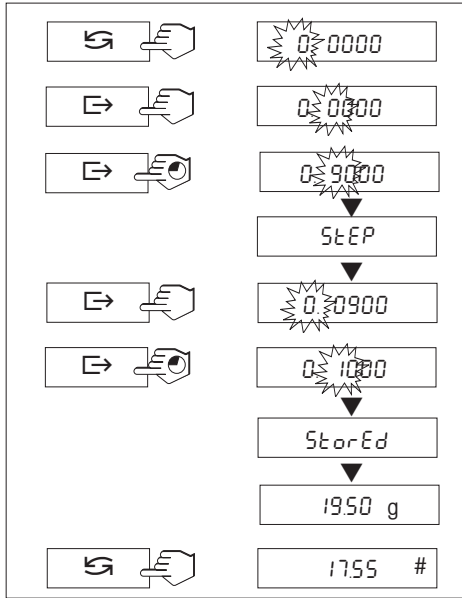



This value can now be changed:

→ Pressing the «» key increases the value of the blinking numeral. The point appears after the numeral 9, and then the numeral 0 reappears.

Note: The point appears in the selection only if a point was not used in the preceding places.

Pressing the key once changes the value by one increment.

→ Pressing the «» key moves the position of the numeral to be changed to the right. After the last place, the position shifts back to the first place.

→ Hold the «» key down until the selected factor is confirmed (no automatic acceptance). "StEP" appears in the display. The program automatically changes to the entry of the display increments. As standard, the **smallest possible display increment** or the value last saved, if this is still valid, appears.

Note: "Error" is displayed instead of "StEP": The factor entered lies outside the valid range. The program then defaults to the value Factor Min. or Factor Max., which can be changed or accepted.

This value can be changed in the same way as for the free factor (see above).

→ Hold the «» key down until the selected display increment is confirmed (no automatic acceptance). "StorEd" appears in the display. The program automatically changes to the weight display.

Note: Displays "Error" instead of "StorEd". The display increment entered lies outside the valid range. The program then defaults to the value Step Min. or Step Max., which can be changed or accepted.

→ Press the «» key. The weight of the object in the pan is calculated with the selected factor and displayed in the selected increment size. The symbol "#" appears instead of a weight unit. The weight is calculated in grams.

Note

If you only want to change the display increments, set the free factor at exactly 1.

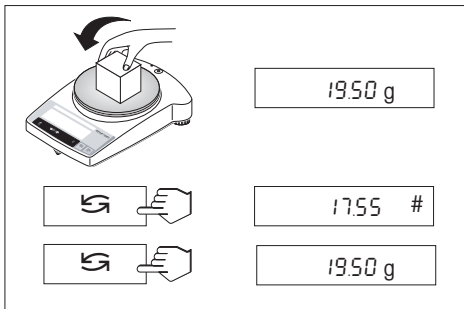

Toggling between displaying the calculated value and the measured weight

The «↔» key can be used to switch between Unit 1, Unit 2 (immediately activated) and the calculated value (#), provided that the "F FAC M" or "F FAC d" function is activated.

5.5 Switching weight units

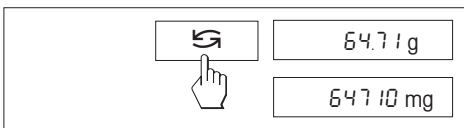

Requirement

Different weight units must be activated in the menu for unit 1 and unit 2 (Section 4).

→ The «↔» key can be used at any time to toggle between the two weighing units selected in the menu ("UNIT 1" and "UNIT 2").

Notes:

- Switching between weight units may be blocked with **certified balances**, depending on national weights and measures legislation.
- This function is not available with dynamic weighing.

6 Technical data, optional equipment

6.1 Technical data

Standard equipment of B-S/FACT balances

- Protective cover, transparent, made from Borex
- AC adapter to national codes according list on section 6.4
Balance power input: 8–14.5 VAC, 50/60Hz, 6 VA or 9.5–20 VDC, 6 W
- FACT, fully automatic adjustment with internal weight
- Built-in RS232C interface
- Draft shield with AB-S/FACT and PBxx3-S/FACT models
- All models can weigh below balance.
- Display with backlight (except ABxx5-S/FACT).

Materials

- Housing: die-cast aluminum, painted
- Weighing pan:
Chromium-nickel steel, X2CrNiMo 17 13 2 (1.4404)

Protection

- Protected against dust and water
- Pollution degree: 2
- Overvoltage category: class II
- EMC: see declaration of conformity (separate brochure 11780294)

Ambient conditions

The technical data are valid under the following ambient conditions:

- Ambient temperature 10 °C ... 30 °C
- Relative humidity 15 % ... 80 % at 31 °C, linear decreasing to 50% at 40 °C noncondensing

Operability is assured at ambient temperatures between 5 and 40 °C.

Technical data	AB54-S/FACT	AB104-S/FACT	AB204-S/FACT	AB304-S/FACT	AB135-S/FACT DualRange	AB265-S/FACT DualRange
Readability	0.1 mg	0.1 mg	0.1 mg	0.1 mg	0.01 mg**/0.1 mg	0.01 mg**/0.1 mg
Max. capacity	51 g	110 g	220 g	320 g	31 g**/120 g	61 g**/220 g
Repeatability (sd)	0.1 mg	0.1 mg	0.1 mg	0.1 mg	0.03 mg ⁰ /0.1 mg	0.03 mg ⁰ /0.1 mg
Linearity	0.2 mg	0.2 mg	0.2 mg	0.4 mg	0.2 mg	0.2 mg
Sensitivity temperature drift (10 °C ... 30 °C)	2.5 ppm/ °C	2.5 ppm/ °C	2.5 ppm/ °C	2.5 ppm/ °C	2.5 ppm/ °C	2.5 ppm/ °C
Settling time, typical	3.5 s	3.5 s	4 s	5 s	4 s / 15 s**	4 s / 15 s**
Adjustment weight	built-in	built-in	built-in	built-in	built-in	built-in
Backlight	yes	yes	yes	yes	no	no
External dimensions of balance (W/D/H)	245x321x344 mm	245x321x344 mm	245x321x344 mm	245x321x344 mm	245x321x344 mm	245x321x344 mm
External dimensions of packaging (W/D/H)	381x436x495 mm (0.082 m ³)	381x436x495 mm (0.082 m ³)	419x494x521 mm (0.108 m ³)	381x436x495 mm (0.082 m ³)	419x494x521 mm (0.108 m ³)	419x494x521 mm (0.108 m ³)
Weighing pan	ø 80 mm	ø 80 mm	ø 80 mm	ø 80 mm	ø 80 mm	ø 80 mm
Usable height of draft shield	237 mm	237 mm	237 mm	237 mm	237 mm	237 mm
Net weight (with packaging)	5.8 kg (7.8 kg)	5.8 kg (7.8 kg)	6.4 kg (9.1 kg)	5.8 kg (7.8 kg)	6.4 kg (9.1 kg)	6.4 kg (9.1 kg)

** Fine range(DualRange)

⁰ Fine range up to 10 g (Dual Range)

Technical data	PB153-S/FACT	PB303-S/FACT	PB303-SDR/FACT DeltaRange	PB403-S/FACT	PB503-S/FACT	PB602-S/FACT	PB1502-S/FACT	PB3002-S/FACT
Readability	0.001 g	0.001 g	0.001 g*/0.01 g	0.001 g	0.001 g	0.01 g	0.01 g	0.01 g
Max. capacity	151 g	310 g	60 g*/310 g	410 g	510 g	610 g	1510 g	3100 g
Repeatability (sd)	0.001 g	0.001 g	0.001 g*/0.008 g	0.001 g	0.001 g	0.01 g	0.01 g	0.01 g
Linearity	0.002 g	0.002 g	0.01 g	0.002 g	0.002 g	0.02 g	0.02 g	0.02 g
Sensitivity temperature drift (10 °C ... 30 °C)	6 ppm/ °C	6 ppm/ °C	6 ppm/ °C	6 ppm/°C	6 ppm/°C	6 ppm/ °C	6 ppm/ °C	6 ppm/ °C
Settling time, typical	2 s	2 s	2 s	2 s	3 s	2 s	2 s	2 s
Adjustment weight	built-in	built-in	built-in	built-in	built-in	built-in	built-in	built-in
Backlight	yes	yes	yes	yes	yes	yes	yes	yes
External dimensions of balance (W/D/H)	245x321x280 mm					245x321x89	245x321x89	245x321x89
External dimensions of packaging (W/D/H)	381x436x495 mm (0.082 m ³)					381x436x273 mm (0.045 m ³)		
Weighing pan	∅ 100 mm					∅ 180 mm		
Usable height of draft shield	165 mm					—		
Net weight (with packaging)	4.9 kg (6.5 kg)					3.6 kg (4.7 kg)		

* Fine range (DeltaRange)

Technical data	PB3002-SDR/FACT DeltaRange	PB4002-S/FACT	PB1501-S/FACT	PB3001-S/FACT	PB5001-S/FACT	PB8001-S/FACT	PB8000-S/FACT
Readability	0.01 g*/0.1 g	0.01 g	0.1 g	0.1 g	0.1 g	0.1 g	1 g
Max. capacity	600 g*/3100 g	4100 g	1510 g	3100 g	5100 g	8100 g	8100 g
Repeatability (sd)	0.01 g*/0.08 g	0.01 g	0.08 g	0.08 g	0.08 g	0.08 g	0.8 g
Linearity	0.1 g	0.02 g	0.1 g	0.1 g	0.1 g	0.1 g	1 g
Sensitivity temperature drift (10 °C ... 30 °C)	6 ppm/ °C	6 ppm/ °C	10 ppm/ °C	10 ppm/ °C	10 ppm/ °C	10 ppm/ °C	10 ppm/ °C
Settling time, typical	2 s	2 s	1.5 s	1.5 s	1.5 s	2 s	1 s
Adjustment weight	built-in	built-in	built-in	built-in	built-in	built-in	built-in
Backlight	yes	yes	yes	yes	yes	yes	yes
External dimensions of balance (W/D/H)	245x321x89 mm		245x321x89 mm				
External dimensions of packaging (W/D/H)	381x436x273 mm (0.045 m ³)		381x436x273 mm (0.045 m ³)				
Weighing pan	∅ 180 mm		180 x 180 mm				
Net weight (with packaging)	3.6 kg (4.7 kg)		3.6 kg (4.7 kg)				

* Fine range (DeltaRange)

6.2 Interface

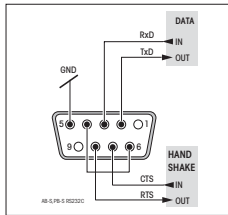

RS232C interface and interface accessories

Every B-S/FACT balance is fitted with an RS232C interface for attachment to a peripheral device (e.g. printer or PC with a 9-pin male connector). Matching to a different device can be carried out in the menu (Sections 4.3.12 – 4.3.17).

You will find a detailed description of the available interface commands in the brochure "Reference Manual MT-SICS Basic-S balances 11780447" available from your METTLER TOLEDO dealer or download from the Internet (www.mt.com/sics-classic).

The wide range of features of the B-S/FACT balances regarding documentation of the results can not be exploited to the full until a printer, e.g. the RS-P26 or LC-P45 from METTLER TOLEDO is attached. The printed results make a decisive contribution to a simple way of working in compliance with GLP/GMP.

The MT-SICS commands listed below is a selected list of available commands. For additional commands and further information please refer to the Reference Manual "MT-SICS Basic-S balances 11780447" downloadable from the Internet under www.mt.com/sics-classic.

S – Send stable weight value

Command **s** Send the current stable net weight value.

SI – Send value immediately

Command **SI** Send the current net weight value, irrespective of balance stability.

SIR – Send weight value immediately and repeat

Command **SIR** Send the net weight values repeatedly, irrespective of balance stability.

Z – Zero

Command **z** Zero the balance.

@ – Reset

Command **@** Resets the balance to the condition found after switching on, but without a zero setting being performed.

SR – Send weight value on weight change (Send and Repeat)

Command **SR** Send the current stable weight value and then send continuously the stable weight value after every weight change.
The weight change must be at least 12.5 % of the last stable weight value, minimum = 30d.

ST – Send stable weight after pressing ⇌ (transfer) key

Command **ST** Inquiry of actual status of the ST function.

SU – Send stable weight value with currently displayed unit

Command **SU** As the "s" command, but with the currently displayed unit.

6.4 Optional equipment

AC adapters

For all models
except AB135-S/FACT / AB265-S/FACT:

- AC adapter universal (EU, USA, AU, UK) 11120270
100–240 VAC/50–60 Hz, 0.3 A
12 VDC, 0.84 A

For AB135-S/FACT / AB265-S/FACT
(as well as for all B-S/FACT models):

- AC adapter universal (bench version)* 11107909
100–240 VAC/50–60 Hz, 12 V, 2.0 A
*(appropriate cable for country also required)

AccuPac B-S

Rechargeable external power source for 18 hours
weighing operation with no mains
connection 21254691

Adjustment weights

Available as OIML weights (E1, E2, F1,
with calibration certificate) For further
details see METTLER TOLEDO Weights
brochure 11795461
or see www.mt.com/weights

Antitheft device

Cable with lock (for all models) 00590101

Auxiliary display (RS/LC-BLD)

Auxiliary display including RS cable
for connection to the RS232C
interface and separate AC adapter 00224200

Auxiliary display (RS232)

Auxiliary display for connection
to the RS232C interface 12120057

Density kits (for AB-S/FACT only)

- For determination of solids 00033360
- For determination of liquids
with displacement body 00033360 + 00210260

Draft shields

- Glass cylinder draft shield
(for 0.1/1 mg balances) 11137305
- Draft shield with sliding doors
"mg" (165 mm) * 11137468
- Draft shield with sliding doors
"0.1 mg" (237 mm) * 11103682
- Draft shield "mg" (141 mm) * 11103683

* Balances with a weighing
pan Ø 180 mm require the weighing
pan Ø 175 mm 11103680

Interface cable

- RS9–RS25: (m/f), length 2 m 11101052
- RS9–RS9: (m/f), length 1 m 11101051
- RS9–RS9: (m/m), length 1 m 21250066
- USB-RS232 converter cable 11103691

Printer, Application printer (LC-P45)

Plain-paper printer, 24 characters, with
additional functions (time, date, statistic,
multiplier etc.) 00229119

Printer, Report printer (RS-P26)

Plain-paper printer, 24 characters, with
additional functions (time, date) 12120788

Protective cover

- For PB-S/FACT models (1 piece) 11103681
- For AB-S/FACT models (1 piece) 11135408

Transport case

- For all PB-S/FACT models, with room for
balance, draft shield 11101050
165 mm / 141 mm and weight
- For all AB-S/FACT models, has space for
balance and draft shield 237 mm 11103834

6.5 Dimensional drawings

All dimensions in millimeters (mm)

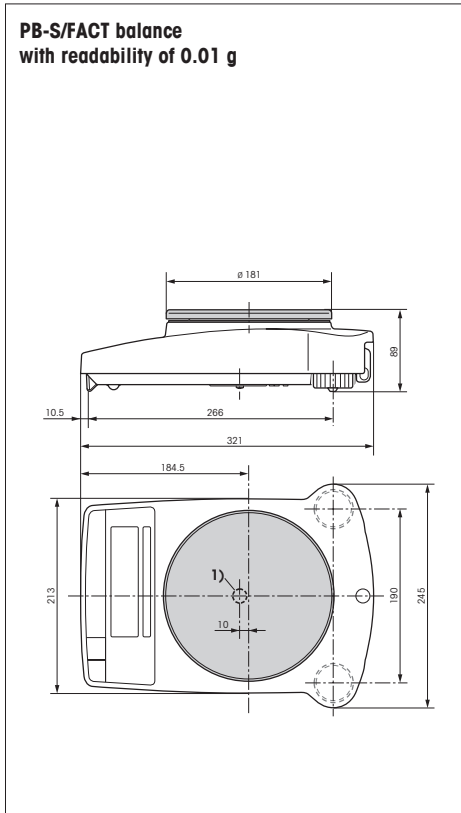

1) Opening for hanger

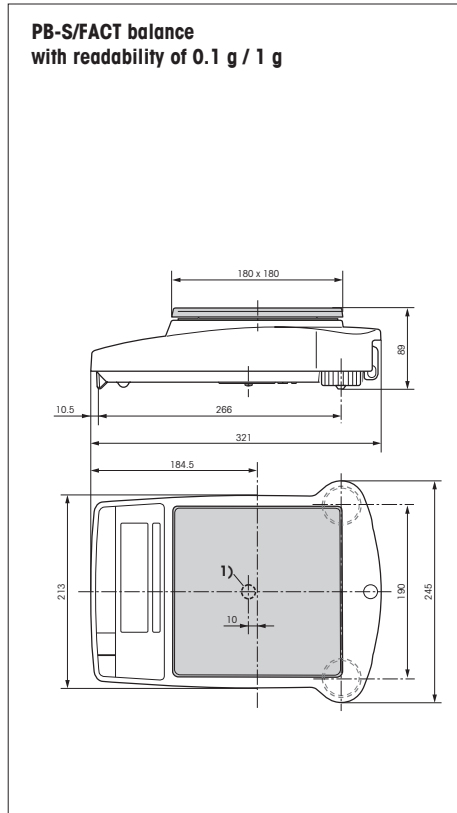

All dimensions in millimeters (mm)

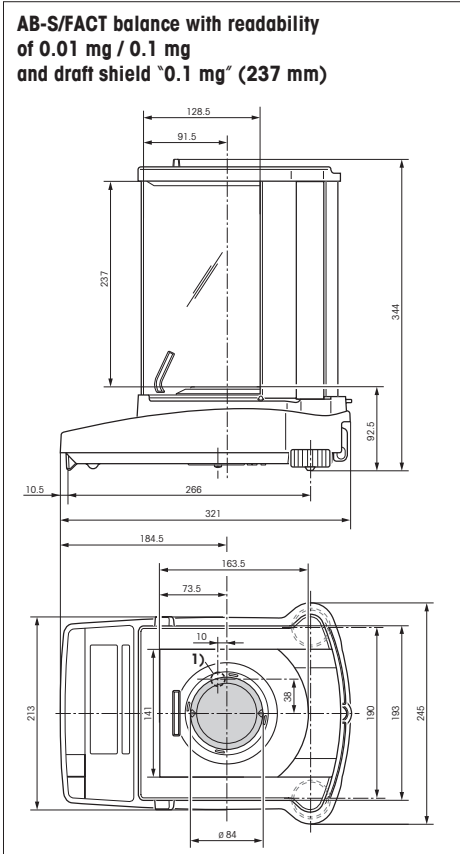

1) Opening for hanger

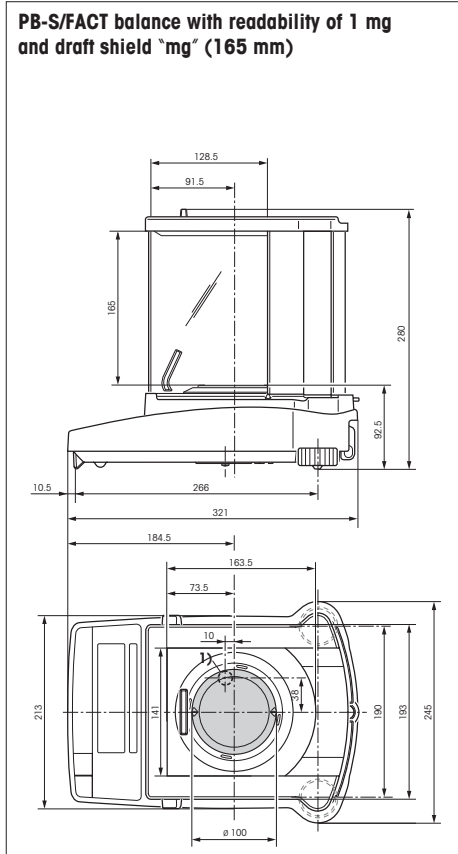

7 Appendix

7.1 Typical printouts from METTLER TOLEDO RS-P26 and LC-P45 printers

Function: **Adjusting (FACT)**

```

- BALANCE CALIBRATION -
12.02.2007      09:42:15

METTLER TOLEDO
Type:    PB3002-S/FACT
SNR:    1118015657
SW:    1.20

Internal Cal. done

----- END -----

```

Function: **Adjusting (external)**

```

- BALANCE CALIBRATION -
12.02.2007      09:45:10

METTLER TOLEDO
Type:    PB3002-S/FACT
SNR:    1118015657
SW:    1.20

Weight ID: .....
Weight:    2000.00 g

External Cal. done

Signature:

.....
----- END -----

```

Function: **Percent weighing**

```

----- % - WEIGHING -----
Ref.    10.008 g
100.00      %

60.01      g
599.59     %

```

Function: **List**

Printout of the current balance settings

```

--- LIST OF SETTINGS ---
12.02.2007      09:48:16

METTLER TOLEDO
Type:    PB3002-S/FACT
SNR:    1118015657
SW:    1.20
-----
Application:
Dynamic A
-----
Weighing Parameters:
Weighing Mode Standard
Unit 1      g
Unit 2      g
A.Zero      On
-----
Peripheral Devices:
P.Device    Printer
Baud        2400
Bit/Parity  7b-even
Handshake   Off
-----
P.Device    Host
Sendmode    Off
Baud        9600
Bit/Parity  8b-no
Handshake   Soft
-----
--- END ---

```

Function: **Piece counting** Printout with reference weight

```

----- PIECE COUNTING -----
APW:    0.99460 g
Out of:    10 PCS

27.000 g
27 PCS

```

Function: **Verification of the calibration (adjustment) with external weight.**

Function is triggered via the printer. ¹⁾

```

----- BALANCE TEST -----
12.02.2007      09:52:12

METTLER TOLEDO
Type:    PB3002-S/FACT
SNR:    1118015657
SW:    1.20

Weight ID: .....

Target : .....
Actual : .....199.98 g
Diff   : .....

External test done

Signature:

.....
----- END -----

```

Function: **Dynamic weighing**

```

--- DYNAMIC WEIGHING ---
Weigh Time:    2 s

DW 49.999      g

```

Function: **Statistics**

Function is triggered via the printer. ¹⁾

```

12.02.2007      10:44:07
ID              666
SNR:            1118015657
1              1100.15 g
2              1600.10 g
3              1699.95 g
n              3
x              1466.733 g
s              321.372 g
srel           21.91 %
min.           1100.15 g
max.           1699.95 g
dif.           599.80 g
-----
----- END -----

```

Function: **Multiplier**

Function is triggered via the printer. ¹⁾

```

12.02.2007      08:23:22
ID              242
SNR:            1118015657

Factor          1.65
                588.43 g
*              970.9095

```







Notes

The operating instructions for the LC-P45 include a description of the functions that are triggered via that printer.

The **RS-P26** prints all reports in **English**. This applies also to the **LC-P45** reports that originate in the balance. In the case of reports triggered by the **LC-P45**, the following languages may be selected: **German, English, French, Spanish** or **Italian**.

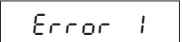
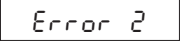
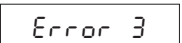
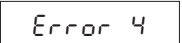
¹⁾ Only possible with LC-P45.

7.2 What if ...?

Error/Error message	Cause	Rectification
	Overload	→ Remove sample from weighing pan, zero again (tare).
	Underload	→ Check whether weighing pan is positioned properly.
	No stability <ul style="list-style-type: none"> • in taring or adjusting (calibration) • when reference weight for piece counting is placed on pan 	→ Wait for stability before pressing key. → Ensure more stable ambient conditions. → Remove weighing pan and clean if necessary
	Wrong adjustment weight on pan or none at all	→ Place required adjustment weight in center of pan.
	Reference number for piece counting too small	→ Increase number of reference pieces.
	Internal fault	→ Contact METTLER TOLEDO customer service.
	No standard calibration	→ Contact METTLER TOLEDO customer service.
	Wrong weighing pan or pan missing	→ Mount correct weighing pan.
	Adjustment aborted with the «C» key	

7.3 Maintenance and cleaning

Service

Regular servicing of your balance by a service technician prolongs its working life. Ask your METTLER TOLEDO dealer for details of servicing options.

Cleaning

Every now and then, clean the weighing pan, draftshield element, draftshield (depending on the model) and housing of your balance using a damp cloth. Your balance is made of high-quality, durable materials and can therefore be cleaned with a standard, mild cleaning agent.



Please observe the following notes

- On no account use cleaning agents, which contain solvents or abrasive ingredients, as this can result in damage to the terminal overlay.
- After working with chemicals, it is advisable to wash or clean the weighing pan and the bottom plate (if draft shield fitted).
- Although all materials are of high quality, corrosion may occur if corrosive substances are deposited on chrome steel for an extended period of time (and if air is excluded, for example by a coating of grease).
- Ensure that no liquid comes into contact with the balance or the AC adapter!
- Never open the balance or AC adapter – they contain no components, which can be cleaned, repaired or replaced by the user.
- Soiled protective covers can be replaced on all balance types (see Optional equipment).

Disposal



In conformance with the European Directive 2002/96/EC on Waste Electrical and Electronic Equipment (WEEE) this device may not be disposed of in domestic waste.

This also applies to countries outside the EU, per their specific requirements.

Please dispose of this product in accordance with local regulations at the collecting point specified for electrical and electronic equipment.

If you have any questions, please contact the responsible authority or the distributor from which you purchased this device.

Should this device be passed on to other parties (for private or professional use), the content of this regulation must also be related.

Thank you for your contribution to environmental protection.

**To protect your METTLER TOLEDO product's future:
METTLER TOLEDO Service assures the quality, measuring accuracy and preservation
of value of all METTLER TOLEDO products for years to come.
Please send for full details about our attractive terms of service.
Thank you.**



Subject to technical changes and to the availability
of the accessories supplied with the instruments.

© Mettler-Toledo AG 2007 11780762C Printed in Switzerland 0710/2.12

Mettler-Toledo AG, Laboratory & Weighing Technologies, CH-8606 Greifensee, Switzerland
Phone +41-44-944 22 11, Fax +41-44-944 30 60, Internet: <http://www.mt.com>