

# **Instruction Manual**

**Portable Oxygen Analyzer InTap 4004 with Zwickel adaptor**

Order number: 52 200 994

The logo graphic consists of a series of parallel, slightly curved lines that create a diamond-shaped or arrow-like shape pointing downwards. The lines are more densely packed in the center and become sparser towards the edges.

**METTLER TOLEDO**

**Mettler-Toledo GmbH**

Process Analytics

P.O. Box

8902 Urdorf

Switzerland

Tel.: +41 1 736 22 11

Fax: +41 1 736 26 36

**Warranty**

Defective instruments returned to us within 1 year of original date of delivery (carriage and insurance prepaid by sender) will be repaired free of charge in our factory.

# **Instruction Manual**

## **Portable Oxygen Analyzer InTap 4004 with Zwickel adaptor**

# Contents

	Page
<b>1 Introduction</b> .....	<b>6</b>
1.1 At the very beginning .....	6
1.2 Important notes .....	6
<b>2 Overview of the InTap 4004</b> .....	<b>8</b>
2.1 Instrument guide .....	8
2.2 Features and functions .....	9
<b>3 Unpacking and inspection</b> .....	<b>10</b>
<b>4 Start-up</b> .....	<b>11</b>
<b>5 The Sensor</b> .....	<b>19</b>
5.1 General notes .....	19
5.2 Preparation for use .....	20
5.3 Preconditioning of the sensor .....	20
5.4 Calibration .....	20
5.5 Maintenance .....	21
5.6 Inspection .....	21
5.7 Storage .....	21
5.8 Exchange of electrolyte and membrane body .....	22

	Page
<b>6 Operation</b> .....	<b>24</b>
6.1 Display .....	24
6.2 Keypad .....	24
6.3 Monitoring and test functions .....	26
6.4 Configuration .....	27
6.5 Calibration .....	29
6.6 Measurement .....	35
6.7 Data logger .....	37
6.8 Clock mode .....	41
6.9 Serial Interface .....	42
6.10 Printing of measured values and protocols/transfer to a PC .....	44
<b>7 Diagnostics, maintenance and cleaning</b> .....	<b>46</b>
7.1 Sensoface®, Sensoscheck® functions .....	46
7.2 Battery replacement .....	47
7.3 Error messages .....	49
7.4 Maintenance and cleaning .....	51
<b>8 Spare parts</b> .....	<b>54</b>
<b>9 Technical data</b> .....	<b>55</b>
<b>10 EU Declaration of Conformity</b> .....	<b>58</b>

## 1 Introduction

### 1.1 At the very beginning

Thank you for your decision to purchase our **O<sub>2</sub> Meter InTap 4004**. This portable instrument is intended for the measurement of dissolved oxygen in liquid media in food and beverage processing.

Please read through this manual before operation of the InTap 4004 and carefully follow the instructions given. This will ensure that you obtain correct measurement results and gain overall benefit from the complete range of features of the instrument.

If you have any questions concerning the use of this O<sub>2</sub> analyzer, please do not hesitate to contact your nearest METTLER TOLEDO Authorized Distributor, who will be pleased to be of assistance.

### 1.2 Important notes

#### Proper use

The portable oxygen analyzer InTap 4004 is intended **solely for the measurement of dissolved oxygen in liquid media in the field of food and beverage processing**. The InTap 4004 **may only be operated in conjunction with original accessories from METTLER TOLEDO**.

All other uses are considered outside the intention of the manufacturer and can lead to erroneous measurements and/or damage to the instrument.

Proper use is understood to include **compliance with the requirements laid down in this instruction manual, in particular, compliance with the safety instructions**.

### General safety instructions

The InTap 4004 may be operated and serviced **only by personnel familiar** with the unit, and who have **read and understood this instruction manual**.

The InTap 4004 **may only be fitted with alkaline AA round cells**. **The use of rechargeable or other types of batteries with a different specification is not permissible** and can lead to instrument damage.

The InTap 4004 may **not be operated in a hazardous area**.

There may be **no interference** with the unit outside the scope of the work described in this manual relative to service/maintenance of the InTap 4004 and its accessories. **The InTap 4004 may only be repaired by an authorized METTLER TOLEDO representative**.

**Without the written consent** of METTLER TOLEDO Process Analytics **no alterations may be made** to the InTap 4004.

**Use only original accessories/spare parts** for the InTap 4004 as recommended/supplied by METTLER TOLEDO. The use of components of other origin can lead to erroneous measurements or to instrument damage.

### Legend for the symbols used in this manual



This symbol denotes a **safety or danger warning** which, if disregarded, can lead to endangerment of the user of the instrument, damage to the analyzer generally or to erroneous measurements.



This symbol draws **attention to additional information and important advice** for correct and economic use of the instrument.

## 2 Overview of the InTap 4004

### 2.1 Instrument guide





## Legend

1	Casing	9	Oxygen sensor
2	Transmitter	10	Measuring chamber
3	Key pad (key functions see Section 6.2)	11	Fixation set
4	Display (description see Section 6.1)	12	Fluidics enclosure
5	Sensor connection	13	Zwickel adaptor
6	Connections not used (not visible in figure)	14	Discharge tube
7	Serial interface connection (not visible in figure)	15	Sampling valve
8	Black top cover		

## 2.2 Features and functions

The InTap 4004 includes the following features and functions:

- Ergonomically optimized enclosure with hose-proof protection IP66
- Amperometric measuring principle
- Large, well-arranged display
- Choice of reading (ppm, ppb, mg/l or %)
- Simultaneous readings of oxygen value and temperature
- Automatic shut-off
- Temperature reading switchable from °C to °F
- Programmable clock and calendar format
- Data logger for the automatic recording of measurement values
- Bidirectional serial interface with universal interface cable for printer and PC
- Automatic calibration in air
- Low battery indicator
- Sensor status indicator "Sensoface®"
- Unit settings and calibration function protected with access code
- Enhanced Paraly SW109

### 3 Unpacking and inspection

Upon receipt, inspect the carton for damage; if any is found, notify carrier immediately. Ensure that all items noted on packing list are present and in good condition. If there is any problem contact your METTLER TOLEDO Distributor.

#### Scope of delivery

- 1 Case
- 1 Transmitter (measuring instrument)
- 1 Oxygen sensor fitted in fluidics enclosure and connected to transmitter
- 1 Casing blue (with top cover, black)
- 1 Fluidics enclosure
- 1 Carrying strap
- 1 CD-ROM containing transfer software "Paraly SW109"
- 1 Interface cable with adapter
- 1 Cleaning and conditioning set consisting of:
  - 20 Cleaning and conditioning tablets
  - 1 Plastic syringe with tube connection
  - 1 Plastic measuring beaker
- 1 Membrane kit consisting of:
  - 4 Membrane bodies (S-96)
  - 1 O-ring set
  - 1 Bottle containing 25 ml electrolyte
  - 1 Fitting instructions
- 1 Instruction manual (E)
- 1 Tubing adaptor kit for conditioning

## 4 Start-up



**Note:** The sensor is delivered ex factory already connected to the transmitter, and is screw-fitted to the measuring chamber in the fluidics enclosure. Leave the sensor permanently connected to the transmitter. This ensures that the sensor is continuously supplied with a polarization voltage (even when the unit is switched off), thus avoiding a polarization time of about 6 h before being ready to take a measurement. In addition, this protects the sensor from contamination.



Below is the sequence for correct start-up and measurement application. Comply with the described procedure in order to ensure optimal response time, a correct measurement result and maximum hygiene.

**1. Perform configuration of the measuring unit according to Section 6.4**

This step is only necessary during initial installation/start-up or in the event of an alteration to the configuration of the unit.

**2. Perform calibration according to Section 6.5**

Calibration is essential during initial start-up of the instrument. In most instances, **automatic calibration in air** is sufficient.



**Note:** We recommend periodic re-calibration. Frequency of re-calibration and the method used (see Section 6.5), depend upon extent of use of the instrument, the required measurement accuracy and your own experience.

**3. Insert the sensor into the measuring chamber**

After calibration, re-insert the sensor into the measuring chamber and tighten the sleeve nut.



#### 4. Prepare the cleaning and conditioning solution

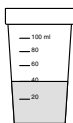

Fill the measuring beaker with **40 ml** of water.

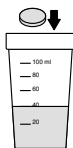

Add one conditioning tablet. Let stand for **5 minutes** (do not stir or shake) until the tablet has completely dissolved.

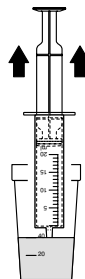

Draw off **25 ml** of cleaning and conditioning solution using the syringe (pull plunger up to the stop). Make sure to remove any air bubbles.

#### 5. Fill the measuring chamber with conditioning solution



Connect the syringe to the sample inlet of the Zwickel adaptor using the tubing adaptor kit. Turn the sampling valve to the **"BYPASS"** position, then inject **approx. 15 ml** (or until solution begins to drain) of cleaning and conditioning solution into measuring chamber.



Switch the sampling valve to **"SAMPLE"** position, and inject the remaining solution.



Turn the sampling valve to the **"BYPASS" position**, then remove syringe and tubing adapter.

Let cleaning and conditioning solution act:

**Minimum time of exposure** to the cleaning and conditioning solution: **15 minutes**

**Maximum time of exposure** to the cleaning and conditioning solution: **3 days**



**Note:** If no measurements are carried out with the InTap within three days, the cleaning and conditioning solution should be removed from the measuring chamber, and both the sensor and the measuring chamber thoroughly dried.

## 6. Process connection



Squeeze the pistol grip and position the U-shaped yoke over the Zwickel. Release the grip and allow the sample inlet to enter the nozzle of the Zwickel.

## 7. Flushing the bypass



Turn the sampling valve to the **"BYPASS" position**, then open the Zwickel.



**Warning!** Always let several ml of process liquid (e.g. beer) flow through the bypass first to ensure that all air is displaced from the feed tube.



## 8. Measuring



Let the Zwickel in the open position and turn the sampling valve to the **"SAMPLE"** position.

As soon as the measured dissolved oxygen value on the display has stabilized, the reading can be taken, (see Section 6.6).



**Warning!** Before first-time measurement application, **the sensor must have been immersed in the cleaning and conditioning solution for at least 15 min.**

## 9. Close measurement



After measurement turn the sampling valve to the **"BYPASS"** position. Close the Zwickel and remove the instrument.

In order to carry out a new measurement at a different location, **connect the analyzer to the process according to steps 6 and 7 above**, and **carry out the measurement in line with step 8**. It is not necessary to condition the sensor.



**Note:** Between individual measurements within one day, the sensor should remain continuously in contact with the medium.

If no measurements are to be taken during a longer period (e.g. overnight or during a weekend), the sensor should remain in the measuring chamber filled with antibacterial cleaning and conditioning solution. This ensures a rapid response time when measurement is again resumed.

For hygienic reasons we recommend that within a period of 24 h, the sensor be at least once re-conditioned in the cleaning and conditioning solution (see steps 4 and 5).

## 5 The Sensor

### 5.1 General notes

Oxygen sensors from METTLER TOLEDO are supplied already fully assembled and have been factory-tested prior to despatch. The oxygen sensor is fitted with a S-96 membrane body, identifiable by the letter S marked on the membrane body.

**Warning!** The sensor should not be equipped with any other type of membrane body, e.g. T-96 intended for an on-line sensor, as this would result in a longer response time.



**Warning!** The sensors **may not be autoclaved**. Cleaning only with an anti-bacterial solution from METTLER TOLEDO.

**Warning!** The sensor is **intended for use exclusively with the oxygen analyzer InTap 4004**.

This document will not dwell on the theories of polarographic oxygen measurements (Clark) on which oxygen sensors are based. However, the four most important fundamental points can be summarized as follows:

- a) The Clark polarographic sensor basically consists of a working electrode (cathode), a counter/reference electrode (anode), as well as an oxygen-permeable membrane which separates the electrodes from the sample medium.
- b) The transmitter supplies a constant polarization voltage which is applied to the cathode.
- c) The oxygen molecules which migrate through the permeable membrane are reduced at the cathode. At the same time, oxidation takes place at the anode, where oxidized anode metal (silver) forms a precipitate. The electrolyte completes the electric circuit between the anode and the cathode (ion conduction).
- d) The electric current produced by the reactions described in c) is interpreted by the transmitter. This current is proportional to the partial pressure of the oxygen in the medium.

## 5.2 Preparation for use

When the system is operated for the first time, or when the sensor has been disconnected from the voltage source (transmitter or polarization module) for longer than 5 minutes, the sensor must be polarized by connecting to the operating oxygen transmitter or to a polarization module prior to calibration. **The sensor is polarized and ready for operation after six hours of polarization time.**

However, if the sensor has been disconnected for only a few minutes, a shorter polarization time of about 30 minutes will be sufficient.



**Note:** The InTap 4004 automatically continues to supply a polarization voltage to the connected sensor even when the instrument is switched off.



**Warning!** The sensor can remain connected to a polarization source (instrument or polarization module) for **up to six months**. For storage periods longer than six months, the sensor must be kept dry, i.e. without electrolyte in the membrane body, (see details in Section 5.7).

## 5.3 Preconditioning of the sensor

The response time of the sensor can be substantially improved through preconditioning (injection of cleaning and conditioning solution into the measuring chamber as described in Section 4, points 4 and 5), particularly after exposure of the sensor to air for several minutes.

In addition, if the sensor is not being used for a longer period (e.g. overnight or during a weekend), it should be stored in the measuring chamber containing the special, anti-bacterial, cleaning and conditioning solution. This ensures rapid response time when operation is resumed. Between measurements within the span of a day, the sensor should always be in contact with the sample medium. For hygienic reasons, we strongly recommend that the sensor be conditioned in the anti-bacterial cleaning and conditioning solution for a period of about 5 minutes at least once per day.

## 5.4 Calibration

Each oxygen sensor has its own individual slope and zero point. Both values are affected by electrolyte consumption or after exchanging the electrolyte or the membrane body. For a highly accurate oxygen measurement, the oxygen measuring system should therefore be calibrated after each change of electrolyte or membrane body. More details on calibration are given in Section 6.5.

## 5.5 Maintenance

Visually inspect the membrane periodically for damage or contamination, but in any case always prior to calibration. If the membrane is dirty, carefully clean it with a moist, soft cloth.

The membrane body itself must be replaced (see Section 5.8) when it begins to show signs of longer response time, drifting or noisy readings, inability to calibrate, or mechanical damage to the membrane.

The electrolyte should be changed periodically; it should **not be used longer than six months**.

## 5.6 Inspection

A periodic zero-current measurement (**not a zero calibration**) is recommended for verification of proper function of a fully polarized sensor.

This can be done by using either nitrogen (N<sub>2</sub>) or carbon dioxide (CO<sub>2</sub>) calibration gas (purity at least 99.995%), or in a sample medium saturated with one of these gases. (N.B. The sensor must already be polarized for this zero-current measurement).

Within two minutes exposure in an oxygen-free sample medium, the reading on the transmitter should drop to below 10 % of the reading in ambient air. Within 10 minutes, the value should have dropped to below 1%.

Higher readings suggest a depleted electrolyte or a non-functioning membrane. Replace the electrolyte or the membrane module accordingly. If the above mentioned values are not reached after electrolyte and membrane body exchange, the sensor should be returned to your local METTLER TOLEDO representative for inspection.

## 5.7 Storage

The sensor can be stored for several months (max. 6 months), provided it is filled with oxygen electrolyte (Art. 34 100 2016) and inside the measuring chamber. The sensor should always remain connected to the instrument to maintain polarization.



**Warning!** During storage in excess of six months, the sensor must be kept dry, i.e. without electrolyte in the membrane body. It is important to note that **a dry stored sensor (without electrolyte in the membrane body) may not be connected to the instrument or to a polarization module**.

## 5.8 Exchange of electrolyte and membrane body



**Warning!** Oxygen electrolyte has a high alkaline value of pH 13. Contact of electrolyte with the skin, especially mucous membrane or eyes, should be strictly avoided. During exchange of electrolyte or membrane body, **protective gloves and glasses must be worn**. If such contact occurs, the affected area should be rinsed well with water. Get medical attention if any adverse signs appear.

METTLER TOLEDO oxygen sensors are supplied with a mounted membrane body and have been fully tested prior to leaving the works. However, if the sensor has been stored several months after delivery, the electrolyte should be renewed before use. If the membrane shows deficiencies (extended response time, increased current in oxygen-free medium, drift, mechanical damage, etc.), it has to be replaced.

### Sensor assembly

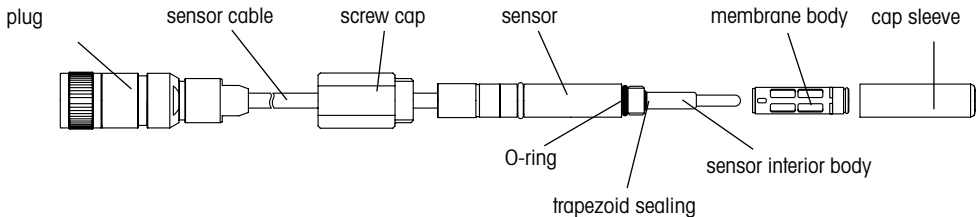

When exchanging electrolyte or membrane body, the following instructions should be observed:

- Unscrew the cap sleeve from the shaft and carefully pull it off the sensor.
- Pull off the membrane body from the interior body. If the membrane body has been pulled off still inside the cap sleeve, eject carefully by pushing it with the flat finger tip (not with the nail).

**Note:** Before electrolyte is refilled, the membrane body be removed from the cap sleeve.



- Clean the interior body with distilled water and carefully dab dry with paper tissue.  
**Attention! The interior body of the sensor (glass membrane body) is very delicate.** Knocks or strong vibrations can cause microcracks which can affect correct functioning of the sensor.
- Check all O-rings and the trapezoid silicone seal for mechanical defects, and replace if necessary.
- Half fill the new membrane body with oxygen electrolyte and make sure that all bubbles are removed. Air bubbles can be removed by carefully tapping on the membrane body.
- Slip the membrane body over the interior body while holding the sensor in a vertical position. The excess electrolyte will be displaced and can be removed with a paper tissue.
- Carefully slip the cap sleeve over the fitted membrane body and tighten. The cap sleeve must be clean and dry. Remove excess electrolyte with a paper tissue.
- After each exchange of electrolyte or membrane body, the sensor must be repolarized and recalibrated.

## 6 Operation

### 6.1 Display

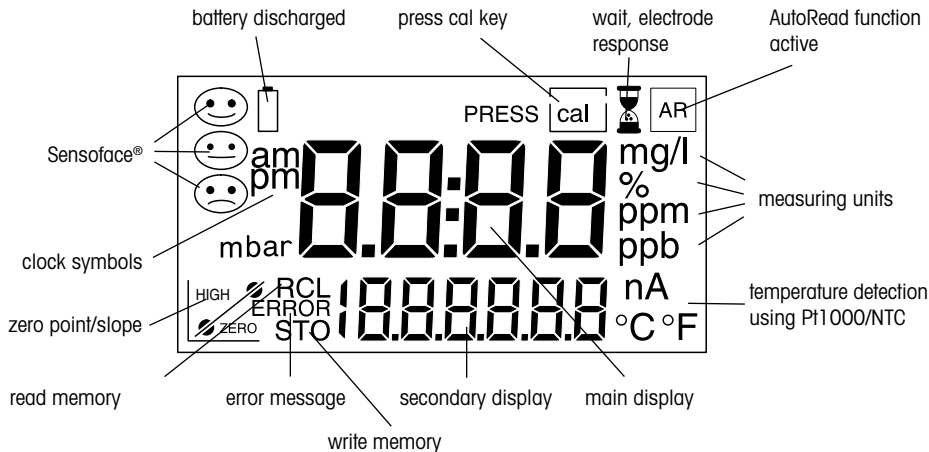

### 6.2 Keypad



Pressing **«on/off»** key switches the instrument on or off. After power-on, the instrument automatically performs a self-test and checks which type of temperature probe is connected. After power-on, the instrument is in the **measuring mode**.



**Note:** You can also switch on the instrument using the **«meas»** key. However, in this case only a short test is conducted and there is no determination of the temperature probe. The instrument assumes that the temperature probe last determined is still in place.



The button is a square with a light gray top half and a white bottom half. The word "meas" is printed in bold black text in the white section.

Pressing **«meas»** at any function returns the instrument automatically to measuring mode (meas = measurement).

The button is a square with a light gray top half and a white bottom half. The word "cal" is printed in bold black text in the white section.

Pressing **«cal»** starts calibration (cal = calibration).  
Through a calibration, the instrument is adjusted to the sensor. You can choose between one or two-point calibration (for details see Section 6.5).

The button is a square with a light gray top half and a white bottom half. A black upward-pointing triangle is centered in the white section.

Pressing cursor **«▲»** and **«▼»** serves to set the clock and the date, to select the memory locations and to determine or alter specific parameters.

The button is a square with a light gray top half and a white bottom half. A black downward-pointing triangle is centered in the white section.The button is a square with a light gray top half and a white bottom half. The word "clock" is printed in bold black text in the white section.

Pressing **«clock»** switches the instrument to **clock mode**. All measuring procedures are discontinued and battery consumption is reduced to a minimum.

The button is a square with a light gray top half and a white bottom half. The word "sto" is printed in bold black text in the white section.

Pressing **«sto»** activates the memory of the data logger to save the measured values through manual input (sto = storage).

The button is a square with a light gray top half and a white bottom half. The word "rcl" is printed in bold black text in the white section.

Pressing **«rcl»** activates the memory to recall and read the measured values (rcl = recall).

The button is a square with a light gray top half and a white bottom half. The word "print" is printed in bold black text in the white section.

Pressing **«print»** the actual measured value is transferred to a printer for a print-out or to a PC.

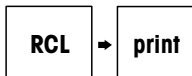

Pressing **«RCL»** and **«print»**: **initiates a print-out of the stored measured values or transfer of the values to a PC.** First press **«RCL»**, release and then press **«print»** (see details in Section 6.10).



Pressing **«cal»** and **«print»**: **initiates a print-out of the instrument protocol or transfer of the protocol to a PC.** First press **«cal»**, release and then press **«print»** (see details in Section 6.10).



**Opens the configuration menu:** with the instrument **switched off**, the configuration menu is activated through pressing **«cal»+«on/off»**, first press **«cal»**, hold depressed and then press **«on/off»**.

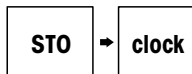

**Data logger mode:** with the instrument **switched on**, the logger is activated by pressing **«STO»+«clock»**. First press **«STO»**, release and then press **«clock»** (for details see Section 6.17).



**Note:** When two keys are to be depressed, make sure that in each case the key shown on the left is pressed first.

## 6.3 Monitoring and test functions

### Monitoring of the sensor by Sensoface® and Sensoscheck®

**Sensoface®** provides information on the electrode state. In addition, slope and response time during calibration are evaluated. For further details see Section 7.1

**Sensoscheck®** continuously monitors the sensor for short-circuiting and cable breaks. For further details see Section 7.1.

### Automatic instrument self-test

By pressing **«on/off»** key the **automatic instrument self-test checks the memory and the measured value transmission.**

## 6.4 Configuration

The configuration menu is protected with an access code to prevent unauthorized access. This **access code** is set to "1200" at the factory and cannot be changed by the user.

### To activate the configuration menu, proceed as follows:

Press «**cal**» while the instrument is still switched off. Hold «**cal**» depressed and then press «**on/off**».



The display prompts you to enter the access code. Use cursor «**▲**» or «**▼**» to adjust access code to "1200", then confirm with «**cal**».

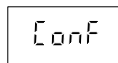

The status indicator shown on the left appears briefly on the display to confirm that the configuration menu is active. The first menu point is displayed. Using the cursors «**▲**» or «**▼**» go through the configuration menu point by point. Save each parameter before proceeding to the next point by pressing «**cal**» or «**STO**».



**Note:** With «**meas**», the configuration menu can be exited at any time. The values already set and stored will be saved.



Selection of **manual or automatic calibration**. Select "on" if you decide for automatic calibration, or "off", if you want to carry out a manual calibration by setting to a known concentration value or zero point.

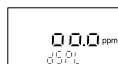

Selection of required **unit** and **resolution**.

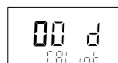

Selection of **calibration interval** (calibration timer). With this setting, the period of time can be specified within which calibration should take place. The interval may lie between 1 and 99 days. With a setting of "00 d" (**factory setting**), the timer is deactivated.

When approx. 80% of the preset interval has expired, the calibration timer switches the Sensoface® status indicator from 😊 to 😊. When the interval has fully expired, the status indicator switches to 😊.

Following calibration, the timer is automatically reset.



**Automatic instrument switch-off:** To conserve the batteries, the instrument switches off automatically if not actively in operation for a longer period. You can choose whether switch-off is effected after either **1 h (factory setting)** or 12 h.

The instrument does not switch off if in operation via an interface or if the data logger is active.



Selection of **print function:** Select **"On" (factory setting)** in order to activate the print function, select "Off" to deactivate.



Selection of **transmission rate at the interface:** You can adjust the transmission rate at the interface to 600, 1200, 2400, **4800 (factory setting)** or 9600 baud. The transfer rate must correspond to the set value of the printer or PC. The data format and the protocol are fixed at 7 bit, one-stop bit, even parity and XON/XOFF protocol (NMUR NE28).



Selection of **temperature unit:** This setting allows you choose between readings in **°C (factory setting)** and °F on the display.



Setting of **time/date format:** With this setting, you can select the time/date on your display to be shown either in the format **"24 hours and day.month.year" (factory setting)** or "12 hours am/pm and month.day.year".

## 6.5 Calibration

Through calibration, the instrument is standardized to the sensor. For continuous applications, we recommend **regular recalibration**. Frequency will be determined by the required accuracy, the type of process, and your experience.



**Note:** The calibration menu is protected with an access code to prevent unauthorized access. This **access code** is set to "1100" at the factory and cannot be changed by the user.

The InTap 4004 offers two basic calibration modes:

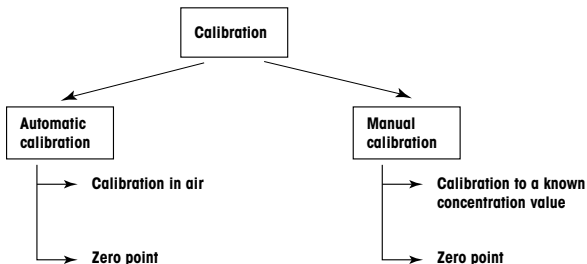

### – Automatic calibration

With the help of automatic calibration, the sensor can easily be calibrated in air. An automatic zero point calibration is also possible through the use of an oxygen-free medium.

### – Manual calibration

Using manual calibration, the sensor can be calibrated to a given, defined concentration value. A manual zero point calibration is also possible by direct entry of the current value.



**Note:** If **no** zero point calibration is carried out during automatic or manual calibration, this is referred to as **single point calibration**. In this case, the InTap 4004 automatically sets the zero point to 0 nA and uses this value to determine the slope of the connected sensor.

If the zero point is determined automatically or manually, this is referred to as **two-point calibration**. In this latter case, **zero point calibration must always be carried out first** (first point) before the second point (eg. in air) is determined.



**Warning!** Zero point calibrations are frequently a source of error. Due to the very low zero current of METTLER TOLEDO sensors, zero point calibration is unnecessary even at low oxygen concentrations.

Depending on configuration (see Section 6.4), calibration can be made to saturation index (%) or to concentration (ppm or mg/l).



**Note:** Before calibration, the sensor has to be connected to the instrument for **at least 6 hours** (polarization time).



**Note:** Before calibration, the membrane must be examined for damage or contamination. If the membrane is dirty, clean carefully with a soft, moist cloth.

### Automatic calibration in air

Pay attention to the following points when carrying out automatic calibration in air.

- For calibration in air, the sensor membrane must be dry, since adhering water drops can falsify the measured oxygen value.
- For the most accurate measurements, always enter the **absolute ambient atmospheric pressure**. Pressures given in weather forecasts (TV, radio, press) are usually related to values at sea level and do not therefore represent absolute values. If you do not know the absolute ambient atmospheric pressure, enter the standard value 1013mbar. As a rule, deviations from the actual absolute pressure value have very little influence on the accuracy of measurements at low oxygen concentrations.
- The oxygen concentration depends, among other things, on the relative humidity. The values determined by the instrument are based on a relative humidity of 50%. In this case however, any deviation from the effective relative humidity has a negligible influence on the measured values (<1%).

For automatic calibration in air, proceed as follows:



Remove the sensor from the fluidics enclosure and insert it into the specially intended holder pocket on the instrument casing.



In the configuration menu set "AirCal" to "On", then revert to the measuring mode by pressing «meas».

Press «cal» to activate calibration mode.



The display prompts you to enter the access code. Use cursor «▲» or «▼» to adjust access code to "1100", then confirm with «cal».



Using the cursors «▲» or «▼», select "AirCal" for the calibration in air and confirm with «cal».



Using the cursors «▲» or «▼», set the actual ambient air pressure.



Press «cal» to start calibration procedure. For checking purposes, the actual sensor current and the timer (hourglass) are continuously displayed.



As soon as calibration has been successfully completed, the display shows the sensor current, the concentration or saturation, and the Sensoface® symbol. Then press «cal» to end calibration. The new slope value is automatically accepted.



**Note:** By pressing «meas», calibration can be aborted at any time and the existing previous calibration values remain active

### Possible fault indications



Maximum calibration time expired



Invalid spectrum of slope

### Automatic zero point calibration

Basically, zero point calibration of METTLER TOLEDO oxygen sensors is unnecessary. If such calibration is nevertheless desired, the following points should be observed:

- **Warning!** Use only oxygen-free medium with a purity of at least 99.995 % (e.g. nitrogen gas).
- **Warning!** If a **two-point calibration** is carried out, **always start with a zero point calibration**.

For automatic zero point calibration, proceed as follows:



Place sensor in an oxygen-free medium (see note above).

**Warning! Wait at least 20 minutes before starting the calibration procedure.**



In the configuration menu set "AirCal" to "On", then revert to the measuring mode by pressing «meas».

Press «cal» to activate calibration mode.



The display prompts you to enter the access code. Use cursor «▲» or «▼» to adjust access code to "1100", then confirm with «cal».



Using the cursors «▲» or «▼», select the «Opoint» for the zero point calibration.



Press «cal» key to start calibration procedure. For checking purposes, the actual sensor current and the timer (hourglass) are continuously displayed.



As soon as calibration has been successfully completed, the display shows the sensor current, the concentration or saturation, and the Sensoface® symbol. Then press «cal» to end calibration. The new zero point is automatically accepted.



**Note:** By pressing «meas», calibration can be aborted at any time and the existing previous zero point remains active.



### Possible **fault indications**



Maximum calibration time expired



Zero point outside permissible range

### Manual calibration by setting a known concentration value (HIGH)

Pay attention to the following points when carrying out manual calibration to a known concentration value.

- Ensure that the oxygen saturation index of the calibration medium is correct and remains constant during calibration.
- For calibration in water or sample medium, the calibration medium must be in equilibrium with the air. Oxygen exchange between water and air is only very slow. Therefore, it takes quite a long time until water is saturated with atmospheric oxygen. For correct calibration, a minimum flow rate of the calibration medium is necessary.
- For the most accurate measurements, always enter the **absolute ambient atmospheric pressure**. Pressures given in weather forecasts (TV, radio, press) are usually related to values at sea level and do not therefore represent absolute values. If you do not know the absolute ambient atmospheric pressure, enter the standard value 1013mbar. As a rule, deviations from the actual absolute pressure value have very little influence on the accuracy of measurements at low oxygen concentrations.
- Make sure that all parameters, such as oxygen saturation index, temperature and pressure, remain constant.

For manual calibration to a known concentration value, proceed as follows:



In the configuration menu set **"AirCal"** to **"OFF"**, then revert to the measuring mode by pressing **«meas»**.

Place sensor in a solution of known oxygen content. Then, press **«cal»** to activate calibration mode.



The display prompts you to enter the access code. Use cursor «▲» or «▼» to adjust access code to "1100", then confirm with «cal».



Using the cursors «▲» or «▼», select "SEt HIGH" for calibration to a known concentration value, and confirm with «cal».



Using the cursors «▲» or «▼», enter the actual ambient air pressure.

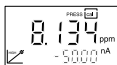

Press «cal» to start calibration procedure. For checking purposes, the actual sensor current and the actual temperature are displayed alternately. Using the cursors «▲» or «▼» enter the known concentration value.

Press «cal» to end calibration. The known concentration value is accepted.



**Note:** By pressing «meas», calibration can be aborted at any time and the existing previous calibration values remain active.

### Manual zero point calibration

Basically, zero point calibration of the METTLER TOLEDO oxygen sensor is unnecessary. If such calibration is nevertheless desired, the following points should be observed:

- **Warning!** Use only oxygen-free medium with a purity of at least 99.995 % (e.g. nitrogen gas).
- **Warning!** If a **two-point calibration** is carried out, **always start with a zero point calibration**.

For manual zero point calibration proceed as follows:



Place sensor in an oxygen-free medium or in a medium which is used as a zero point standard (see note above).

**Warning! Wait at least 20 minutes before starting the calibration procedure**



In the configuration menu set "AirCal" to "OFF", then revert to the measuring mode by pressing «meas».

Press **«cal»** to activate calibration mode.



The display prompts you to enter the access code. Use cursor **«▲»** or **«▼»** to adjust access code to "1100", then confirm with **«cal»**.



Using the cursors **«▲»** or **«▼»**, select **"SEt OpoinT"** for zero point calibration, and confirm with **«cal»**.



Using the cursors **«▲»** or **«▼»**, determine the zero point current.

Press **«cal»** to end calibration. The new zero point is accepted.



**Note:** By pressing **«meas»**, calibration can be aborted at any time and the existing previous calibration values remain active.

## 6.6 Measurement

### Continuous measurement

After switching on or following brief actuation of **«meas»**, the instrument is active in the normal measuring mode. In the normal measuring mode, both the measured value and the temperature reading are continuously actualized. Independent of configuration (see Section 6.4) and the parameter, the measured value will be displayed in one of the following formats:

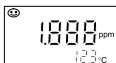

Format x.xxx ppm (only for values <2 ppm)

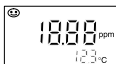

Format xx.xx ppm



Format xx.x ppm

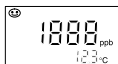

Format xxxx ppb (only for values <1999 ppb)



Format xxx.x %

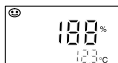

Format xxx %

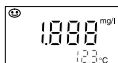

Format x.xxx mg/l (only for values <2 mg/l)



Format xx.xx mg/l

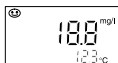

Format xx.x mg/l

### Measurement with AutoRead

With the function **AutoRead**, a measured value and the corresponding temperature can be frozen on the display.

**Activation** of the AutoRead function: **Press «meas» for at least 3 seconds.**



Measurement value and temperature are determined, display runs, hour glass and AR flash until the measurement value is stable.

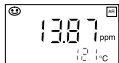

Measured value and temperature are frozen (hour glass off, AR in display).

In order to determine a new measured value and to "freeze" it, briefly push **«meas»**. The hour glass and AR in display flash until the measurement value is stable. Then again, measured value and temperature are frozen (hour glass off, AR in display).

To end the function AutoRead: **Press «meas» again for at least 3 seconds.**

## 6.7 Data logger

The data logger records up to 200 measured values together with temperature, time and date in the data memory of the InTap 4004.

The data memory of the InTap 4004 is a loop memory, i.e. as soon as the last memory location (199) has been reached, recording automatically continues at location 00. The old value at this location is overwritten with the new value.



**Note:** If more than 200 values must be recorded, connect the InTap 4004 to a PC via the corresponding interface cable and use the transfer software package "Paraly SW109" (both included in the delivery). See sections 6.9 and 6.10 for detailed information.

Recording takes place depending on the configuration of the data logger: either manually by pressing a key, or interval or event-controlled. The data logger always records the current measured variable in the specific unit/resolution set during configuration.

### Activation and configuration of the data logger mode and starting of recording of measured values.

First briefly press «STO» and then «clock» to activate the **data logger mode**. The menu of the data logger mode is arranged as follows:

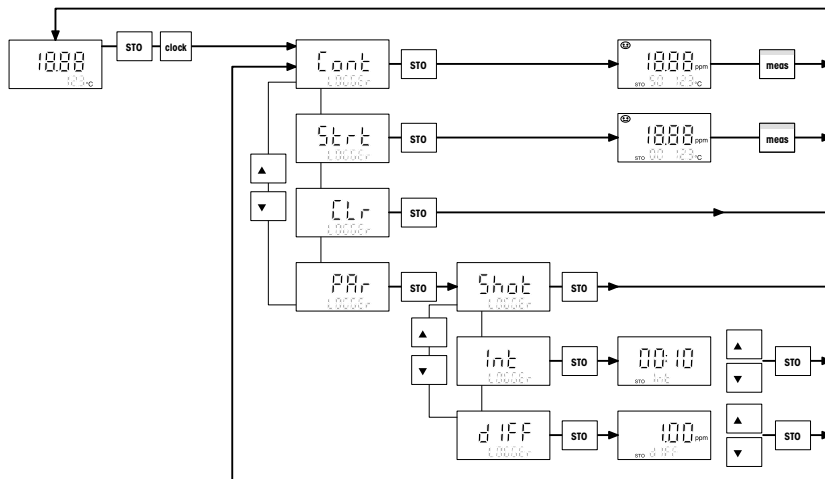



Menu point "Cont" (= Continue): By pushing «**STO**» at this menu point, the instrument switches to the **logging mode**.

Logging (manual, event or interval-controlled) is then recommenced **at the memory location directly following the location at which the last measured value was stored**.



Menu point "Strt" (= Start): By pushing «**STO**» at this menu point, the instrument switches to the **logging mode**.

The data **memory area is completely cleared** and logging (manual, event or interval-controlled) **commences at the first memory location 00**.



Menu point "Clr" (= Clear): By pushing «**STO**» at this menu point, the **data memory is completely cleared** and the instrument returns to the measuring mode.



Menu point "Par": Pushing «**STO**» at this menu point activates the parameter menu (choice of recording methods). Using the cursors «**▼**» or «**▲**» then select whether the logging method is to be manual, event or interval-controlled:



If you wish to use **manual logging** (Shot), push «**STO**» at this selection point. In this logging mode press «**STO**» at each measured value you wish to record.



If you wish to use **interval-controlled logging** (Int), push «**STO**» at this selection point.



Then, using the cursors «**▼**» or «**▲**», set the required interval time (range: 5 sec. to 60 min.) for recording. Press «**STO**» to confirm the set value. In this logging mode a measured value will be automatically recorded at the set interval.



If you wish to use **event-controlled logging** (diff), push **«STO»** at this selection point.



Then, using the cursors **«▼»** or **«▲»**, set the value of the differential at which a measurement should be recorded. Press **«STO»** in order to confirm the set value. In this logging mode a measured value will be automatically recorded as soon as it deviates from the last measured value by the set differential. Simultaneous time recording allows you to establish when the value changed.



**Note:** The differential value always refers to the current configured unit of measurement (% , ppm or mg/l).



**Note:** By pushing **«meas»**, the data logger can be aborted at any time and the instrument automatically returns to the measuring mode.



## 6.8 Clock mode

### Activating the clock mode

In the clock mode, battery consumption by the instrument is reduced to a minimum. Activate the clock mode if you do not intend to carry out measurements over a certain period of time. This will prolong the life of you batteries.



If you press **«clock»** when in the measuring mode, time and date will be displayed.



**Note:** To leave clock mode, press **«meas»**. The instrument automatically returns to the measuring mode.

### Setting of time and date



**Note:** To set the clock or the date, the clock mode must first be activated.

When in clock mode, first press **«STO»**, **hold the key depressed**, then press **«clock»**.

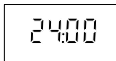

The time display flashes. Using the cursors **«▼»** or **«▲»**, set the time. Store the data by pushing **«STO»**.



The date display flashes. Using the cursors **«▼»** or **«▲»**, set the date. Store by pushing **«STO»**.



The year display flashes. Using the cursors **«▼»** or **«▲»**, set the year. Store by pushing **«STO»**. The instrument then returns to the clock mode.



**Note:** Time and date can be switched to US format (see Section 6.4).

## 6.9 Serial Interface

The InTap 4004 is equipped with an RS232 interface and can be connected to a printer with serial port, or directly to a PC.

Using the various key functions of the InTap 4004, the actual measured value, memory or instrument protocol can each be directly printed out by a printer or transferred to a PC (see Section 6.10).

Data transfer to a PC requires the use of the transfer software package "Paraly SW109" which is included in the delivery. This software also enables the InTap 4004 to be completely remote controlled. **Instructions on use of the software "Paraly SW109" are given in the on-line help of the software.**

### Interface cable

To connect the InTap 4004 to the serial port of a printer or PC, use the interface cable included in the delivery. Depending upon the position in which the three-pin plug is plugged into the socket of the InTap 4004, the interface cable can be used either for a printer or a PC (see illustration).

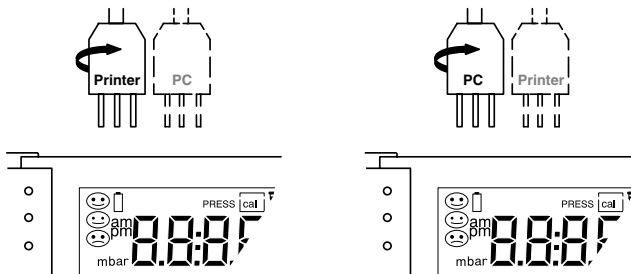

### Plug pin assignment of the interface cable

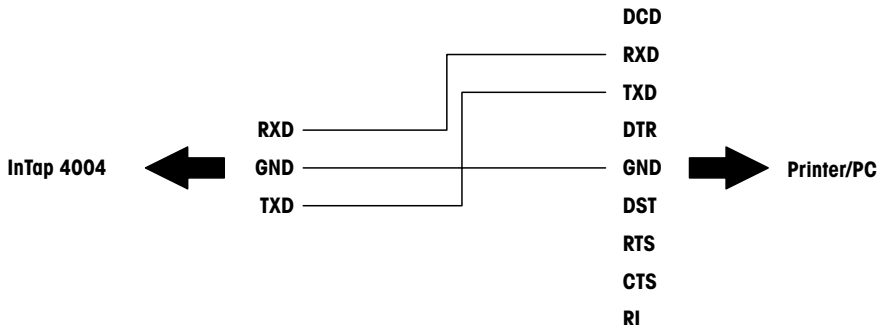

### Interface parameters

The RS 232 interface allows parameterization of all common baud rates. Setting is carried out in the configuration menu (see section 6.4):

Baud rates:

- 600 Bd
- 1 200 Bd
- 2 400 Bd
- 4 800 Bd (factory setting)**
- 9 600 Bd

Data format and protocol are permanently set to:

- 7 data bit**
- even parity**
- one stop bit**
- XON/XOFF protocol**



**Note:** For the command set of the InTap 4004, refer to the on-line help of "Paraly SW 109" transfer software.

## 6.10 Printing of measured values and protocols/transfer to a PC



**Note:** In order to be able to print out measured values and protocols or to transfer this data to a PC, the **print function** in the configuration menu (see Section 6.4) has to be **activated (Print on)**. In addition, the **baud rate** of the instrument must **correspond** to the baud rate of the printer/PC, and the instrument already **connected to a printer/PC by means of the appropriate interface cable**. For data transfer to a PC, the transfer software "Paraly SW109" must also be already installed, and running on the PC. Instructions on use of the software "Paraly SW109" are given in the on-line help of the software.

### Current measured values: printing/transfer to a PC

Each time the **«print»** key is pressed a data record with the following format will be printed out or transferred to the PC accordingly:

Measurement counter	Measuring value	Temperature	Date	Time
023	8.500ppm	23.6°C	19.02.00	22:32
024	8.500ppm	23.6°C	19.02.00	22:32



**Note:** The measurement counter is incremented automatically. Each time the transmitter is switched off the counter is reset to "000".



**Note:** The "\*" symbol at the beginning of a data record indicates that the Sensoface® symbol showed ☹ (incorrect measuring value) when recording a value. The "#" symbol at the beginning of a data record indicates that the permissible measurement range (ppm, mg/l, %, nA, °C/°F) was exceeded or the clock not set when recording a value.

### Data memory: printing/transfer to a PC

While in measuring mode, first press **«RCL»** and then **«print»**. All records in the data memory will be printed out or transferred to the PC accordingly.

Memory location	Measuring value	Temperature	Date	Time
S000	8.500ppm	23.6°C	19.02.00	22:32
S000	8.500ppm	23.6°C	19.02.00	22:32
S002	8.500ppm	23.6°C	19.02.00	22:32
S003	8.500ppm	23.6°C	19.02.00	22:32



**Note:** The "\*" symbol at the beginning of a data record indicates that the Sensoface® symbol showed ☹️ (incorrect measuring value) when recording a value. The "#" symbol at the beginning of a data record indicates that the permissible measurement range (ppm, mg/l, %, nA, °C/°F) was exceeded or the clock not set when recording a value.



**Note:** If you only want to print the data of a specific memory location or have this data transferred to a PC, first press **«RCL»** while in the measuring mode. Then, using the cursors **«▼»** or **«▲»**, select the desired memory location and confirm by pressing **«print»**.

### Instrument protocol: printing/transfer to a PC

While in measuring mode, first press **«cal»** and then **«print»**. The protocol will be printed out or the date transferred to the PC accordingly. The protocol contains the following data:





METTLER TOLEDO InTap 4004 19.01.01		
Serial Number:	01393936	Serial number of the instrument and Software version
Software Version:	2.0	
Calibration Record		Calibration record with the exact data of the last calibration
Last Calibration:	19.01.01 22:29	
Sensor System Data		
O-Point uncompensated:	0.00nA	
O-Point Temperature:	23.00C	
High uncompensated:	-53.41nA	
High Temperature:	23.70C	
High Pressure:	1013mbar	Settings of the configuration menu
Slope compensated:	-.2670nA/mbar	
Next Calibration in:	99d	
Configuration Setting		
Cal Timer:	99d	
Autocal:	On	
Oxygen concentration:	oo.appm	
AutoOff Timer:	12h	
Printer:	On	
Baud Rate:	9600	
Temperature Unit:	oC	
Date Format:	24.00	Record of the last instrument self-test
Time:	22:33	
Date:	19.01.01	
Datalogger Mode:	Single Shot	
Diagnostics		List of the current Sensoface® criteria
Device Check:	-ok-	
Battery Check:	-ok-	
Clock setting:	-ok-	
Sensoface(++/oo/—)		
Cal Timer:	++	
Sensor O-Point:	++	
Sensor High:	++	

## 7 Diagnostics, maintenance and cleaning

### 7.1 Sensoface®, Sensocheck® functions

The Sensoface® function evaluates information about the slope and response time during calibration. The results of the Sensocheck® function which continuously monitors the sensor state (impedance check) during measurement procedure are also incorporated in the evaluation.

The three Smileys provide the instrument user with status information on the quality of the last calibration or the condition of the sensor. They indicate when a new calibration or maintenance work is necessary.

Sensoface	Information	Significance
		Calibration timer expired. Carry out calibration
		Sensor guarantees correct measurement
		Sensor still serviceable, but replacement of the membrane module and electrolyte due
		Sensor no longer guarantees correct measurements Membrane module and electrolyte to be replaced



**Note:** The worsening of a Sensoface® criterion leads to a negative progression in the Sensoface® indicator from 😊 to 😞.



**Note:** A reversal of the progression of the Sensoface® indicators to 😊 can only be achieved through calibration or, if relevant, through correction of a sensor defect.

## 7.2 Battery replacement

If the battery symbol  appears in the display, the batteries need replacement. However, you can still use the instrument for a few days. When the battery voltage decreases further, the instrument switches off.



**Note:** Since battery consumption is higher when the remote interface is used, the battery symbol will be displayed sooner in that case.



**Warning!** Never change the batteries within a hazardous area.

For battery replacement you need **three alkaline AA round cells** and a screwdriver (either flat or Phillips). Proceed as follows:

1. Switch off the instrument.
2. Release the sensor cable from the instrument.
3. Pull the fluidics enclosure toward the front, then shift it to the left to remove the enclosure from the hinge (see figures below).



4. Push inwards the tongue of the black top cover at the back of the instrument, pull up the top cover, and withdraw the instrument from the casing.
5. Fold upward the instrument protection flap with rating plate at the back of the instrument and then the integrated hanger. Unscrew the four screws at the back of the instrument and remove the cover.
6. Remove the old batteries from the battery holder and insert the three new round cells (AA alkali) in the specified direction.



**Warning!** The use of rechargeable or other types of batteries with a different specification **is not permissible**.



**Warning!** Before reassembly, make sure that the rubber seal and the blind plug are not damaged and are correctly seated in the groove.

7. Correctly fit the instrument protection flap in the notches of the instrument cover. Remount the cover and secure it with the screws.
8. Replace the black top cover and insert the instrument into the casing (the tongue of the black top cover must snap in).
9. Remount the fluidics enclosure, and reconnect the sensor cable.



**Note:** During battery change, all calibration and configuration data as well as the complete memory are retained. The calibration timer runs out. And the current memory location number of the data logger is set to 00. Time and date must be reset.



**Warning!** If you want to store the instrument for a longer time, the batteries must always be removed beforehand. Leaky batteries may damage the instrument.



### 7.3 Error messages

No. (Err)	Display/pictograph blinking	Error message	Possible causes	Procedure
01	Measured value and <b>ERROR</b>	Measurement range exceeded	Overflow Faulty sensor	Check process medium Check sensor consider recalibration
03	Measured value, Temperature and <b>ERROR</b>	Temperature measuring range exceeded	Faulty temperature probe or short circuit	Replace sensor
04		Zero point cannot be calibrated	Elektrolyte depleted, faulty sensor	Check sensor Replace elektrolyte, consider recalibration
05		HIGH value cannot be calibrated	Elektrolyte depleted, faulty sensor	Clean sensor Consider membrane replacement
11	<b>1.out</b> and <b>ERROR</b>	Unstable sensor signal	Elektrolyte depleted, faulty sensor	Clean sensor Consider membrane replacement
14	<b>Error 14</b>	Clock breakdown	Battery replacement	Set clock
15	<b>Error 15</b>	Interface transmission error	Incorrect plug connection Baud rates of measuring instrument and printer/PC do not match	Check plug connection Set baud rates
18	<b>Error 18</b>	Configuration and calibration data corrupt		Contact METTLER TOLEDO Service

No. (Err)	Display/pictograph blinking	Error message	Possible causes	Procedure
19	<b>Error 19</b>	Compensation data calibration data corrupt		Contact METTLER TOLEDO Service
–	<b>t. out</b> and <b>ERROR</b>	<b>t. out</b>	Maximum calibration time exceeded	Abort calibration with « <b>meas</b> » key, clean sensor, Consider membrane replacement. Check whether membrane con- tains electrolyte.
–	<b>ERROR</b> and <b>SLOPE</b>	<b>SLOPE</b>	Non-permissible range	Abort calibration with « <b>meas</b> » key, clean sensor, Consider membrane replacement. Check whether membrane con- tains electrolyte
–	<b>ERROR</b> and <b>0-Point</b>	<b>0-Point</b>	Non-permissible range	Abort calibration with « <b>meas</b> » key, clean sensor, Consider membrane replacement. Check whether membrane con- tains electrolyte. Check oxygen-free medium.

## 7.4 Maintenance and cleaning

### 7.4.1 Fluidics

1. Switch off the instrument.
2. Release the sensor cable from the instrument.
3. Pull the fluidics enclosure toward the front, then shift it to the left to remove the enclosure from the hinge (see figures below).



4. Remove the sensor from the fluidics enclosure.

- Remove the four screws and open the front panel (see figure below).



- Clean the inside of the fluidics enclosure with a moist (not wet) cloth.
- Check the tubings and replace if necessary (InTap 4004 tubing kit – 52 200 998). See figures below for the correct connection of the tubes.

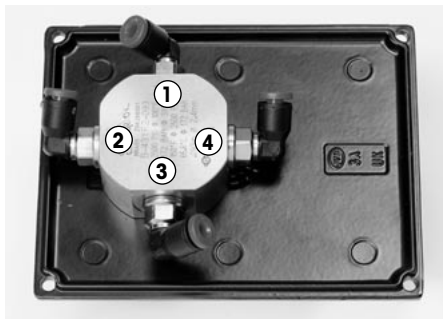

8. Check the measuring chamber. Replace if necessary (measuring chamber – 52 200 999).
9. Remount front panel and reassemble it with the four screws.
10. Remount the fluidics enclosure, then reinsert the sensor and connect sensor cable.

#### 7.4.2 Measuring instrument

To remove dust and dirt, the external surfaces of the instrument may be cleaned with a moist (not wet) cloth. If necessary, a mild household cleaner may be used.



**Warning! Never use organic solvents** such as acetone to clean the instrument.

#### 7.4.3 Sensor

see Section 5 “The Sensor”.

## 8 Spare parts

<b>Designation</b>	<b>Order no.</b>
Cleaning and conditioning set (20 tablets, 1 beaker, 1 syringe)	52 200 255
InTap 4000 membrane kit (4 membrane bodies S-96, spare O-rings, 25 ml electrolyte)	52 200 773
O <sub>2</sub> Electrolyte (25 ml)	34 100 2016
InTap 4000 O-ring set	52 200 774
InTap 4000 sensor	52 200 766
InTap 4004 measuring chamber	52 200 999
InTap 4000 casing (blue), with top cover (black)	52 200 259
InTap 4004 instruction manual (E)	52 120 994
InTap 4004 fluidics enclosure and fixation set (upgrade kit)	52 201 011
InTap 4000 Transmitter	52 201 009
InTap 4004 tubing kit (discharge tube, 4 tubing for fluidics enclosure)	52 200 998
Tubing adaptor kit for conditioning	52 201 000

## 9 Technical data

### O<sub>2</sub> input

Measurement range <sup>1)</sup>	saturation	0 ... 199% 0,0 ... 199,9%
	dissolved O <sub>2</sub> concentration	0,000 ... 1,999 ppm, mg/l or ppm, 0.00 ... 19,99 ppm <sup>2)</sup> or mg/l
Measurement error	saturation	<0,5% v.M. ±0,1% ±1 digit (within the range 0°C to 35°C / 5 °F to 195 °F)
	dissolved O <sub>2</sub> concentration:	<0,5% v.M. ± 0,01 ppm ±1 digit
Sensor monitoring	Sensoface®	monitoring of membrane in liquid media
Measuring current		0 ... 300 nA, resolution 5 pA
Polarization current		-550 mV ±10 mV Connected sensor will automatically be polarized

### Temperature input

Temperature probe	NTC	30 kΩ
Measurement range	temperature	-5° to 50 °C / 23 to 122 °F
Measurement error	temperature	<0,2 K ±1 digit

### Sensor standardization <sup>1)</sup>

- Automatic calibration in air
- Automatic zero point calibration
- Manual calibration through entry of a predetermined concentration value
- Manual calibration of the zero point

<b>Display</b>	LC display
<b>Calibration timer</b>	0...99 days (0 = off)
<b>Calibration result</b>	indicated in the display through Sensoface® After each calibration, the timer resets to 0
<b>AutoRead</b>	function for stable and reproducible measuring
<b>Measuring cycle</b>	< 1,5 s
<b>Instrument self-test</b>	test of RAM, PROM, EEPROM and display, protocol for QM documentation according to DIN ISO 9000. Data retrievable via interface
<b>Data retention</b>	parameter and calibration data > 5 years (EEPROM), clock approx. 1 year (life of battery)
<b>Measured value memory</b>	200 memory locations
<b>Data logger</b>	manual, interval- or event controlled
<b>Automatic switch-off</b>	after either 1 or 12 hours (configurable), disabled during operation via interface or when using data logger
<b>Interface</b>	RS232 Baud Rate: configurable to 600/1 200/2 400/4 800/9 600 7 data bit, even parity, one stop bit, XON/XOFF protocol
<b>Power supply</b>	3 Alkaline AA round cells. Operation with accumulator is not permitted
<b>RFI suppresion</b>	according to EN 50081-1
<b>Immunity to interface</b>	according EN 50082-2
<b>Material</b>	transmitter housing: polymer: Ultramid casing: polymer
<b>Protection class</b>	IP 66



---

<b>Ambient temperature</b>	operation temperature <sup>3)</sup> : -10 to. +55 °C / 14 to 131 °F storage temperature: -20 to +70 °C / -4 to 158 °F
<b>Connections</b>	plug connection for sensor 3 jacks 2.5 mm for serial interface 2 jacks 4 mm (not connected)
<b>Dimensions</b>	without casing: 130 x 160 x 35 mm (B x H x D) casing only: 195 x 186 x 75 mm (B x H x D)
<b>Weight</b>	instrument incl. sensor: 790 g (without casing and liquid handling set) casing: 590 g

---

- 1) configurable
- 2) at range overshoot (for instance during calibration in air), automatic skip to next higher range
- 3) at ambient temperatures below 0 °C / 32 °F display may be temporarily reduced

## 10 EU Declaration of Conformity



**We**

---

**Mettler-Toledo GmbH, Process Analytics**

Im Hackacker 15  
8902 Urdorf  
Switzerland

declare under our sole responsibility that the product,

**Description**

---

**InTap 4004**

to which this declaration relates is in conformity with the following standard(s) or other normative document(s).

**Explosion Protection**

---

**94/9/EEC**

**El. Safety**

---

**EN 50014: 1997, EN 50020: 1994**

**EMV Directive**

---

**89/336/EEC**

**Emissions**

---

**EN 50081-1, EN 61326, EN 61326/A1**

**Immunity**

---

**EN 50082-2, EN 61326, EN 61326/A1**

**Date of issue**

---

**December 12, 2000**



- BR** **Mettler-Toledo Ind. e Com. Ltda.**, Alameda Araguaia, 451-Alphaville, BR-06455-000 Barueri-SP, Brazil  
Tel. +55 11 4166-74 00, Fax +55 11 4166-74 01
- CH** **Mettler-Toledo (Schweiz) AG**, Im Langacher, CH-8606 Greifensee, Switzerland  
Tel. +41 1 944 45 45, Fax +41 1 944 45 10
- D** **Mettler-Toledo GmbH**, Prozeßanalytik, Ockerweg 3, D-35396 Gießen, Germany  
Tel. +49 641 507-333, Fax +49 641 507-397
- F** **Mettler-Toledo Analyse Industrielle Sàrl**, 30 Bld. de Douaumont, BP 949, F-75829 Paris, France  
Tel. +33 1 47 37 06 00, Fax +33 1 47 37 46 26
- USA** **Mettler-Toledo Ingold, Inc.**, 36 Middlesex Turnpike, Bedford, MA 01730, USA  
Tel. +1 781 301-8800, Fax +1 781 271-0681