

# **Instruction Manual**

**Portable Oxygen Analyzer InTap 4000 e**  
**Portable Oxygen Analyzer InTap 4004 e**

Order number: 52 201 080

**METTLER TOLEDO**

The logo graphic consists of a series of parallel, slightly curved lines that form a diamond-like shape, positioned behind the company name.

**Mettler-Toledo GmbH**

Process Analytics

P.O. Box

8902 Urdorf

Switzerland

Tel.: +41 44 729 62 11

Fax: +41 44 729 66 36

**Warranty**

METTLER TOLEDO warrants this product to be free from significant deviations in material and workmanship for a period of one year from the date of purchase. If repair is necessary and not the result of abuse or misuse within the warranty period, please return by freight pre-paid and amendment will be made without any charge. METTLER TOLEDO's Customer Service Dept. will determine if the product problem is due to deviations or customer abuse. Out-of-warranty products will be repaired on an exchange basis at cost.



# **Instruction Manual**

**Portable Oxygen Analyzer InTap 4000 e**  
**Portable Oxygen Analyzer InTap 4004 e**

# Contents

	Page
<b>1 Introduction</b> .....	<b>6</b>
1.1 At the very beginning .....	6
1.2 Important notes .....	6
<b>2 Overview of the InTap 4000 e / InTap 4004 e</b> .....	<b>8</b>
2.1 Instrument guide InTap 4000 e .....	8
2.2 Instrument guide InTap 4004 e .....	10
2.3 Features and functions .....	12
<b>3 Unpacking and inspection</b> .....	<b>12</b>
<b>4 Start-up</b> .....	<b>14</b>
4.1 InTap 4000 e .....	14
4.2 InTap 4004 e .....	24
<b>5 The Sensor</b> .....	<b>33</b>
5.1 General notes .....	33
5.2 Preparation for use .....	34
5.3 Preconditioning of the sensor .....	34
5.4 Calibration .....	34
5.5 Maintenance .....	35
5.6 Inspection .....	35
5.7 Storage .....	35
5.8 Exchange of electrolyte and membrane body .....	36

	Page
<b>6      Operation</b> .....	<b>.38</b>
6.1    Display .....	.38
6.2    Keypad .....	.38
6.3    Monitoring and test functions .....	.40
6.4    Configuration .....	.41
6.5    Calibration .....	.43
6.6    Measurement .....	.52
6.7    Data logger .....	.54
6.8    Clock mode .....	.57
6.9    Serial Interface .....	.58
6.10   Printing of measured values and protocols/transfer to a PC .....	.60
<b>7      Diagnostics, maintenance and cleaning</b> .....	<b>.62</b>
7.1    Sensoface®, Sensocheck® functions .....	.62
7.2    Battery replacement .....	.63
7.3    Error messages .....	.67
7.4    Maintenance and cleaning .....	.69
<b>8      Spare parts</b> .....	<b>.73</b>
<b>9      Technical data</b> .....	<b>.74</b>
<b>10     EU Declaration of conformity</b> .....	<b>.77</b>

## 1 Introduction

### 1.1 At the very beginning

Thank you for your decision to purchase our **O<sub>2</sub> Analyzer InTap 4000 e/InTap 4004 e**. This portable instrument is intended for the measurement of dissolved oxygen (DO) in liquid media in food and beverage processing.

Please read through this manual before operation of the InTap 4000 e/InTap 4004 e and carefully follow the instructions given. This will ensure that you obtain correct measurement results and gain overall benefit from the complete range of features of the instrument.

If you have any questions concerning the use of this O<sub>2</sub> analyzer, please do not hesitate to contact your METTLER TOLEDO Authorized Distributor, who will be pleased to be of assistance.

### 1.2 Important notes

#### Proper use

The portable oxygen analyzer InTap 4000 e/InTap 4004 e is intended **solely for the measurement of dissolved oxygen in liquid media in the field of food and beverage processing**. The InTap 4000 e/InTap 4004 e **may only be operated in conjunction with original accessories from METTLER TOLEDO**.

All other uses are considered outside the intention of the manufacturer and can lead to erroneous measurements and/or damage to the instrument.

Proper use is understood to include **compliance with the requirements laid down in this instruction manual, in particular, compliance with the safety instructions**.

### General safety instructions

The InTap 4000e/InTap 4004e may be operated and serviced **only by personnel familiar** with the unit, and who have **read and understood this instruction manual**.

The InTap 4000e/InTap 4004e **may only be fitted with alkaline AAA 1.5V batteries (LR03)**. The use of **rechargeable or other types of batteries with a different specification is not permissible** and can lead to instrument damage.

The InTap 4000e/InTap 4004e may **not be operated in a hazardous area**.

There may be **no interference** with the unit outside the scope of the work described in this manual relative to service/maintenance of the InTap 4000e/InTap 4004e and its accessories. **The InTap 4000e/InTap 4004e may only be repaired by an authorized METTLER TOLEDO representative**.

**Without the written consent** of METTLER TOLEDO Process Analytics **no changes may be made** to the InTap 4000e/InTap 4004e.

**Use only original accessories/spare parts** for the InTap 4000e/InTap 4004e as recommended/supplied by METTLER TOLEDO. The use of components of other origin can lead to erroneous measurements or to instrument damage.

### Legend for the symbols used in this manual



This symbol denotes a **safety or danger warning** which, if disregarded, can lead to endangerment of the user of the instrument, damage to the analyzer generally or to erroneous measurements.



This symbol draws **attention to additional information and important advice** for correct and economic use of the instrument.

## 2 Overview of the InTap 4000 e/InTap 4004 e

### 2.1 Instrument guide InTap4000 e

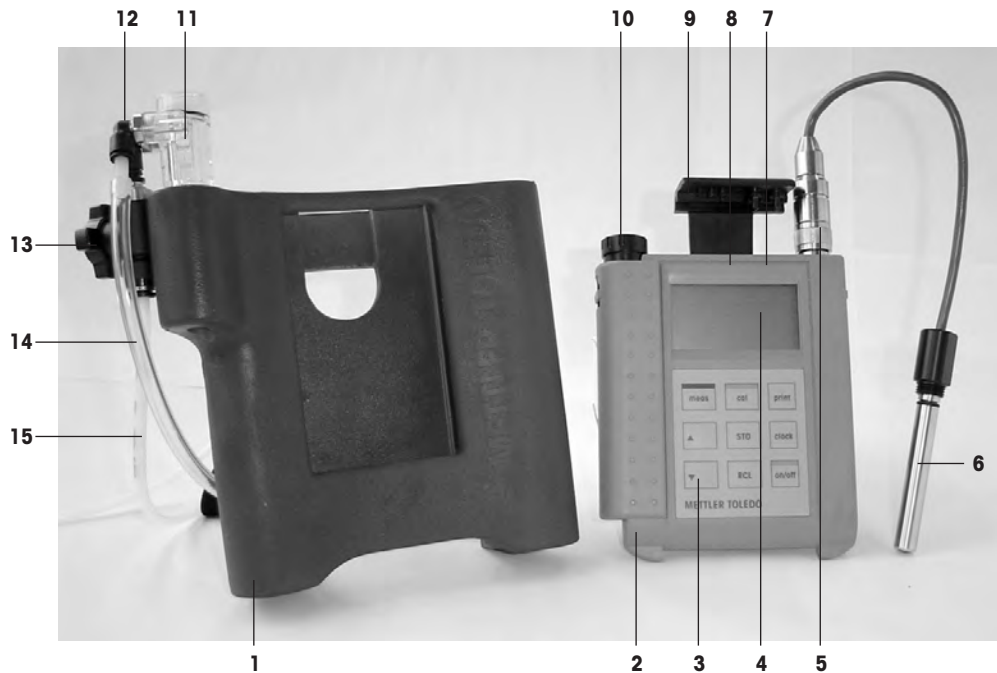



**Legend**

- |          |   |           |  |
|----------|---|-----------|--|
| <b>1</b> | Casing  | <b>9</b>  | Black top cover  |
| <b>2</b> | Transmitter   | <b>10</b> | Battery case   |
| <b>3</b> | Key pad (key functions see «Section 6.2»)           | <b>11</b> | Measuring chamber  |
| <b>4</b> | Display (description see «Section 6.1»)             | <b>12</b> | Feed tube (1.5 m)  |
| <b>5</b> | Sensor VP connector                                 | <b>13</b> | Three-way valve  |
| <b>6</b> | Oxygen sensor                                       | <b>14</b> | Discharge tube (0.3 m) with integrated<br>reduction nipple |
| <b>7</b> | Connections not used (not visible in figure)        | <b>15</b> | Bypass tube (0.3 m)  |
| <b>8</b> | Serial interface connection (not visible in figure) |           |  |

## 2.2 Instrument guide InTap 4004 e

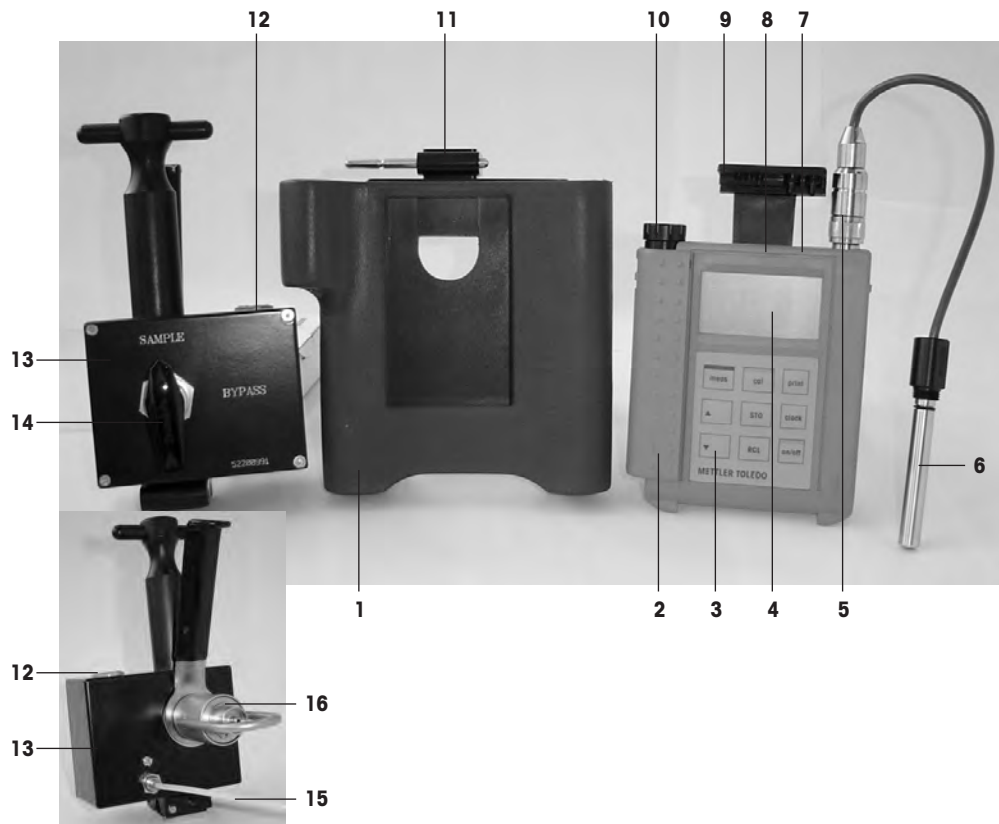

**Legend**

- |          |   |           |                    |
|----------|---|-----------|--------------------|
| <b>1</b> | Casing  | <b>9</b>  | Black top cover    |
| <b>2</b> | Transmitter   | <b>10</b> | Battery case       |
| <b>3</b> | Key pad (key functions see «Section 6.2»)           | <b>11</b> | Fixation set       |
| <b>4</b> | Display (description see «Section 6.1»)             | <b>12</b> | Measuring chamber  |
| <b>5</b> | Sensor VP connector                                 | <b>13</b> | Fluidics enclosure |
| <b>6</b> | Oxygen sensor                                       | <b>14</b> | Sampling valve     |
| <b>7</b> | Connections not used (not visible in figure)        | <b>15</b> | Discharge tube     |
| <b>8</b> | Serial interface connection (not visible in figure) | <b>16</b> | Zwickel adapter    |

## 2.3 Features and functions

The InTap 4000 e/InTap 4004 e include the following features and functions:

- Ergonomically optimized enclosure with hose-proof protection IP66
- Amperometric measuring principle
- Large, well-arranged display
- Choice of reading (ppm, ppb, mg/l or %)
- Simultaneous readings of oxygen value and temperature
- Automatic shut-off
- Temperature reading switchable from °C to °F
- Programmable clock and calendar format
- Data logger for the automatic recording of measurement values
- Bidirectional serial RS 232 interface with universal interface cable for printer and PC
- Automatic calibration in air
- Low battery indicator
- Sensor status indicator «Sensoface®» and «Sensocheck®»
- Unit settings and calibration function protected with access code
- Enhanced Paraly SW109
- Zwickel adapter unit (only InTap 4004 e)

## 3 Unpacking and inspection

Upon receipt, inspect the carton for damage; if any is found, notify carrier immediately. Ensure that all items noted on packing list are present and in good condition. If there is any problem contact your METTLER TOLEDO Distributor.

**Scope of delivery****InTap 4000 e**

<b>N°</b>	<b>Item</b>
1 x	Carrying case
1 x	Transmitter (measuring instrument)
1 x	Oxygen sensor fitted in measuring chamber
1 x	Casing blue (with top cover, black)
	–
1 x	Carrying strap
1 x	CD-ROM containing transfer software «Paraly SW109»
1 x	RS 232 interface cable with adapter
1 x	Cleaning and conditioning set consisting of: 20 x Cleaning and conditioning tablets 1 x Plastic syringe with tube connection 1 x Plastic measuring beaker
1 x	Membrane kit consisting of: 4 x Membrane bodies (InTap 4000e/4004e) 1 x O-ring set 1 x Bottle containing 25 ml electrolyte 1 x Fitting instructions
1 x	Liquid handling set consisting of: 1 x supply tube 1 x bypass tube 1 x discharge tube with reduction nipple 1 x 3-way valve (already mounted) 2 x screws for valve (already mounted)
1 x	Instruction manual (en)
	–

**InTap 4004 e**

<b>N°</b>	<b>Item</b>
	–
1 x	Transmitter (measuring instrument)
1 x	Oxygen sensor fitted in fluidics enclosure
	–
1 x	Casing blue (with top cover, black)
1 x	Fluidics enclosure
1 x	Carrying strap
1 x	CD-ROM containing transfer software «Paraly SW109»
1 x	RS 232 interface cable with adapter
1 x	Cleaning and conditioning set consisting of: 20 x Cleaning and conditioning tablets 1 x Plastic syringe with tube connection 1 x Plastic measuring beaker
1 x	Membrane kit consisting of: 4 x Membrane bodies (InTap 4000e/4004e) 1 x O-ring set 1 x Bottle containing 25 ml electrolyte 1 x Fitting instructions
	–
1 x	Instruction manual (en)
1 x	Tubing adapter kit for conditioning

## 4 Start-up

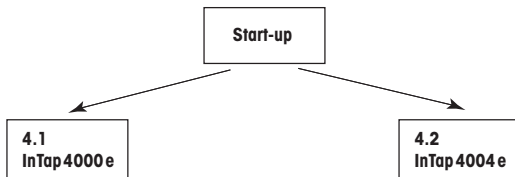

### 4.1 InTap 4000 e



**Important!** Before using the sensors for the first time, the electrolyte should be replaced (see «Section 5.8»). Due to possible adverse conditions during transport and storage (e.g. airfreight, pressure and temperature variations), the quality of the electrolyte may become impaired. Poor electrolyte quality can lead to erroneous measurement values.



**Note:** Insert included batteries before start-up (refer to «Section 7.2» for detailed information).



**Note:** The sensor is delivered ex factory **not** connected to the transmitter. Therefore, it has to be polarized before first time operation.

Connect the InTap sensor to the analyzer. After 6 hours, the sensor is fully polarized and ready for operation. Leave the sensor permanently connected to the transmitter after first time polarization. This ensures that the sensor is continuously supplied with a polarization voltage (even when the unit is switched off), thus avoiding a polarization time of about 6 h before being ready to take a measurement. In addition, this protects the sensor from contamination.

On the following page is the sequence for correct start-up and measurement application. Comply with the described procedure in order to ensure optimal response time, a correct measurement result and maximum hygiene.

1. **Connect discharge tube (0.3 m) and bypass tube (0.3 m) to three-way valve (see picture below).**



**Warning!** Push the tubes into the quick couplers to the stop.

**Warning!** The discharge tube may not be fitted with any form of extension, as this could allow air (avoid measurement errors) to penetrate into the measuring chamber between measuring cycles.



### Legend

- 1 Measuring chamber
- 2 Reduction nipple (diaphragm)
- 3 Discharge tube (0.3 m)
- 4 Three-way valve
- 5 Bypass tube (0.3 m)

**2. Perform configuration of the measuring unit according to «Section 6.4»**

This step is necessary during initial installation/start-up or if new requirements for configuration rise have arisen.

**3. Perform calibration according to «Section 6.5»**

Calibration is essential during initial start-up of the instrument. In most instances, **automatic calibration in air** is sufficient.



**Note:** We recommend periodic re-calibration. Frequency of re-calibration and the method used (see «Section 6.5»), depend upon extent of use of the instrument, the required measurement accuracy and you own experience.

**4. Insert the sensor into the measuring chamber**

After calibration, re-insert the sensor into the measuring chamber and tighten the sleeve nut.

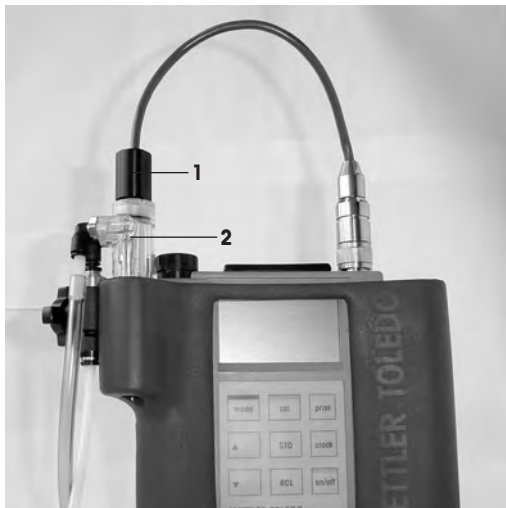
**Legend**

- 1 Sensor in measuring chamber
- 2 Sleeve nut



## 5. Prepare the cleaning and conditioning solution

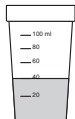

Fill the measuring beaker with **40 ml** of water.

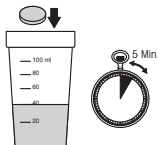

Add one conditioning tablet. Let stand for **5 minutes** (do not stir or shake) until the tablet has completely dissolved.

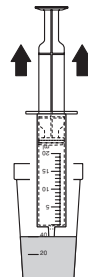

Draw off **25 ml** of cleaning and conditioning solution using the syringe (pull plunger up to the stop). Make sure to remove any air bubbles.

## 6. Fill the measuring chamber with cleaning and conditioning solution



Connect the syringe with tube connection (diam. 6 mm) to the measuring chamber. Turn the three-way valve to **«Measuring position»**, then inject **approx. 15 ml** of cleaning and conditioning solution into measuring chamber.



Turn the sampling valve to the «**BYPASS**» position, then remove syringe with tubing connection.

Let cleaning and conditioning solution act:

**Minimum time of exposure** to the cleaning and conditioning solution: **15 minutes**

**Maximum time of exposure** to the cleaning and conditioning solution: **1 week**



**Note:** If no measurements are carried out with the InTap within three days, the cleaning and conditioning solution should be removed from the measuring chamber, and both the sensor and the measuring chamber thoroughly dried.

## 7. Connecting the feed tube



### Warning!

Push feed tube into the quick coupler to the stop.



- 1 Feed tube (1.5 m)
- 2 Three-way valve in «BYPASS» position

## 8. Process connection

As the beverage industry does not have any valid worldwide standard for connections to storage tanks or pipes, no special tube adapter for connection to processes is included in the scope of our supply. Connection of the feed tube to the process is the responsibility of the customer.

For the Perlick-type connections used on storage tanks in the USA, METTLER TOLEDO offers either the InTap 4004e or an appropriate tank sample adapter port (order no. 52 200 261) as an optional accessory.



**Warning!** Leaky tube couplings between process and measuring chamber (sensor) are the most frequent cause of erroneous measurements. **All tube couplings and tube extensions between the process connection and the measuring chamber must therefore be absolutely leakproof.**

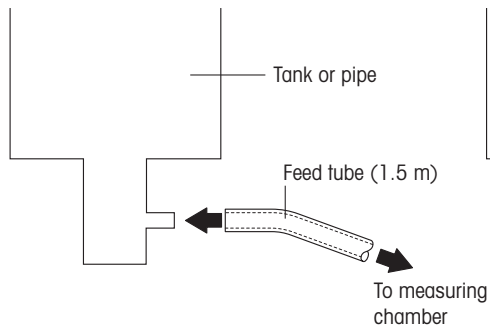
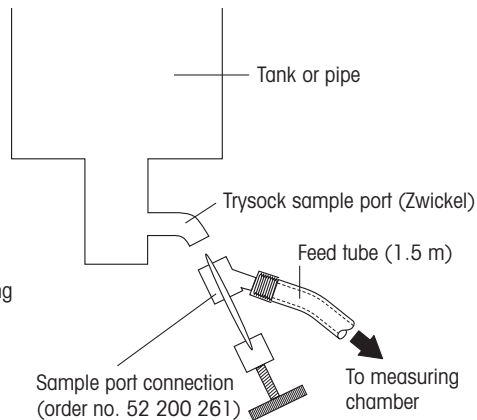

**Warning!** Special care has been taken in the selection of a material with low oxygen permeability for the feed tube connected to the process. Therefore, **only use the feed tube supplied** by us.

**Connection to tank/pipe****Connection to tank/pipe  
with Perlick-type connection  
(USA-Standard)**

Feed tube (1.5 m, diam. 6/4 mm) to be fitted directly to tank or pipe connection, or by means of special adapter (responsibility of customer).

## 9. Flushing the bypass

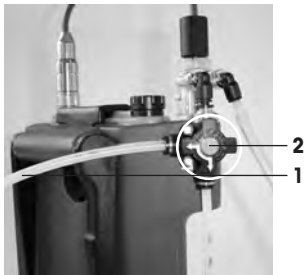

- 1 Feed tube (1.5 m)
- 2 Three-way valve in «BYPASS» position



**Warning!** Always let several ml of process liquid (e.g. beer) flow through the bypass first to ensure that all air is displaced from the feed tube.

## 10. Measuring

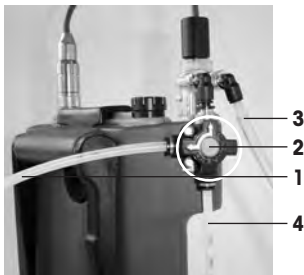

- 1 Feed tube (1.5 m)
- 2 Three-way valve in «Measuring» position
- 3 Discharge tube (0.3 m)
- 4 Bypass tube (0.3 m)



**Warning!** Before first-time measurement application, **the sensor must have been immersed in the cleaning and conditioning solution for at least 15 min.**

Turn three-way valve to «**Measuring**» position. As soon as the measured value on the display has stabilized, **the reading can be taken**, (see «Section 6.6»).

## 11. Close measurement



- 1 Feed tube (1.5 m)
- 2 Three-way valve in «BYPASS» position

After measurement turn the three-way valve to the «Bypass» position and cut-off feed tube from the process. In order to carry out a new measurement at a different location, **connect the analyzer to the process according to steps 8 and 9 above, and carry out the measurement in line with step 10.** It is not necessary to condition the sensor.



**Note:** Between individual measurements within one day, the sensor should remain continuously in contact with the medium.

If no measurements are to be taken during a longer period (e.g. overnight or during a weekend), the sensor should remain in the measuring chamber filled with antibacterial cleaning and conditioning solution. This ensures a rapid response time when measurement is again resumed. For hygienic reasons we recommend that within a period of 24 h, the sensor should be at least once re-conditioned in the cleaning and conditioning solution for **about 15 minutes (see steps 5 and 6).**

## 12. Connection for bottles and cans

To take measurements in bottles or cans, INGOLD recommends the use of the **sampling device «INPACK SAMPLER» from Haffmans**. For other types of sampling devices, no guarantee for faultless function can be given.



**Warning!** In order to obtain a stable measurement value (reading) for bottles and cans with a low volume content, it is necessary to precondition the sensor using the supplied cleaning and conditioning solution (see «Section 4, steps 5 and 6»). The **minimum exposure time of 15 min is to be observed** without exception. In addition, the bottle or can content must be at room temperature. Temperature variations between sample medium and sensor lead to longer response times.

Bottle or can measurements are carried out in the following sequence:

1. Adjust the sampling device to suit the size of the bottle or can.
2. Connect the sampling device to a carrier gas ( $N_2$  or  $CO_2$ ) and set the manometer of the gas cylinder to 1.5 bar.
3. Inject cleaning and conditioning solution into the measuring chamber and allow it to act for at least 15 min. (see «Section 4, step 6»).
4. Connect the feed tube to the three-way valve and to the metal pipe of the piercer using an appropriate adapter (not included in the delivery).
5. Pierce the bottle or can.
6. Turn the three-way valve to the «Bypass» position and flush the feed tube for several seconds with carrier gas in order to displace oxygen in the tube.
7. Turn the three-way valve to the «Measuring» position.
8. Insert the metal pipe right to the bottom of the bottle or can. Due to the gas pressure, liquid will automatically be pressed into the measuring chamber.
9. As soon as the value shown on the display has become stable, the reading can be taken.

Details on operation of the sampling device can be seen in the relative instruction manual.



**Attention!** Leaky tube connections between the process and the measuring chamber (sensor) are the most frequent cause of erroneous readings. **All tube connections and tube extensions between the process connection and the measuring chamber must be fully leakproof.**

## 4.2 InTap 4004 e



**Important:** The sensor is delivered ex factory not connected to the transmitter. Therefore, it has to be polarized before first time operation. Connect the InTap sensor to the analyzer. After 6 hours, the sensor is fully polarized and ready for operation.

Leave the sensor permanently connected to the transmitter after first time polarization. This ensures that the sensor is continuously supplied with a polarization voltage (even when the unit is switched off), thus avoiding a polarization time of about 6 h before being ready to take a measurement. In addition, this protects the sensor from contamination.



Following hereafter is the sequence for correct start-up and measurement application. Comply with the described procedure in order to ensure optimal response time, a correct measurement result and maximum hygiene.



**1. Perform configuration of the measuring unit according to «Section 6.4»**

This step is only necessary during initial installation/start-up or in the event of an alteration to the configuration of the unit.

**2. Perform calibration according to «Section 6.5»**

Calibration is essential during initial start-up of the instrument. In most instances, **automatic calibration in air** is sufficient.



**Note:** We recommend periodic re-calibration. Frequency of re-calibration and the method used (see «Section 6.5»), depend upon extent of use of the instrument, the required measurement accuracy and you own experience.

**3. Insert the sensor into the measuring chamber**

After calibration, re-insert the sensor into the measuring chamber and tighten the sleeve nut.



#### 4. Prepare the cleaning and conditioning solution

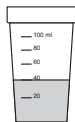

Fill the measuring beaker with **40 ml** of water.

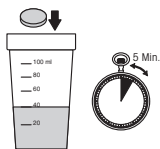

Add one conditioning tablet.  
Let stand for **5 minutes** (do not stir or shake) until the tablet has completely dissolved.

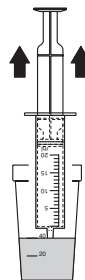

Draw off **25 ml** of cleaning and conditioning solution using the syringe (pull plunger up to the stop). Make sure to remove any air bubbles.

## 5. Fill the measuring chamber with conditioning solution

Connect the syringe to the sample inlet of the Zwickel adapter using the tubing adapter kit. Turn the sampling valve to the «**BYPASS**» position, then inject **approx. 15 ml** (or until solution begins to drain) of cleaning and conditioning solution into measuring chamber.



Switch the sampling valve to «**SAMPLE**» position, and inject the remaining solution.

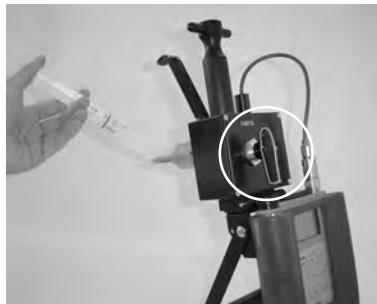

Turn the sampling valve to the **«BYPASS» position**, then remove syringe and tubing adapter (see pull direction on the photo).



Let cleaning and conditioning solution act:

**Minimum time of exposure** to the cleaning and conditioning solution: **15 minutes**

**Maximum time of exposure** to the cleaning and conditioning solution: **1 week**



**Note:** If no measurements are carried out with the InTap within three days, the cleaning and conditioning solution should be removed from the measuring chamber, and both the sensor and the measuring chamber thoroughly dried.

## 6. Process connection



Squeeze the pistol grip and position the U-shaped yoke over the Zwickel.  
Release the grip and allow the sample inlet to enter the nozzle of the Zwickel.

## 7. Flushing the bypass



Turn the sampling valve to the **«BYPASS» position**, then open the Zwickel.



**Warning!** Always let several ml of process liquid (e.g. beer) flow through the bypass first to ensure that all air is displaced from the feed tube.

## 8. Measuring



Let the Zwickel in the open position and turn the sampling valve to the **«SAMPLE»** position.



**Warning!** Before first-time measurement application, **the sensor must have been immersed in the cleaning and conditioning solution for at least 15 min.**

As soon as the measured dissolved oxygen value on the display has stabilized, the reading can be taken, (see «Section 6.6»).

## 9. Close measurement

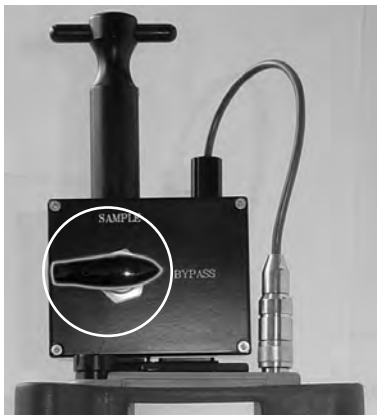

After measurement turn the sampling valve to the **«BYPASS» position**. Close the Zwickel and remove the instrument.

In order to carry out a new measurement at a different location, **connect the analyzer to the process according to steps 6 and 7 above, and carry out the measurement in line with step 8**. It is not necessary to condition the sensor.



**Note:** Between individual measurements within one day, the sensor should remain continuously in contact with the medium. If no measurements are to be taken during a longer period (e.g. overnight or during a weekend), the sensor should remain in the measuring chamber filled with antibacterial cleaning and conditioning solution. This ensures a rapid response time when measurement is again resumed. For hygienic reasons we recommend that within a period of 24 h, the sensor be at least once re-conditioned in the cleaning and conditioning solution for **about 15 minutes (see steps 4 and 5)**.



## 5 The Sensor

### 5.1 General notes

Oxygen sensors from METTLER TOLEDO are supplied already fully assembled and have been factory-tested prior to despatch. The oxygen sensor is fitted with a membrane body, identifiable by «InTap 4000e» marked on the membrane body.



**Warning!** The sensor should not be equipped with any other type of membrane body, e.g. T-96 or S-96 intended for an on-line sensor, as this would result in a longer response time.



**Warning!** The sensors **may not be autoclaved**. Cleaning only with an anti-bacterial solution from METTLER TOLEDO.



**Warning!** The sensor is **intended for use exclusively with the oxygen analyzer InTap 4000e/InTap 4004 e**.

This document will not dwell on the theories of polarographic oxygen measurements (Clark) on which oxygen sensors are based. However, the four most important fundamental points can be summarized as follows:

- a) The Clark polarographic sensor basically consists of a working electrode (cathode), a counter/reference electrode (anode), as well as an oxygen-permeable membrane which separates the electrodes from the sample medium.
- b) The transmitter supplies a constant polarization voltage which is applied to the cathode.
- c) The oxygen molecules which migrate through the permeable membrane are reduced at the cathode. At the same time, oxidation takes place at the anode, where oxidized anode metal (silver) forms a precipitate. The electrolyte completes the electric circuit between the anode and the cathode (ion conduction).
- d) The electric current produced by the reactions described in c) is interpreted by the transmitter. This current is proportional to the partial pressure of the oxygen in the medium.

## 5.2 Preparation for use

When the system is operated for the first time, or when the sensor has been disconnected from the voltage source (transmitter or polarization module) for longer than 5 minutes, the sensor must be polarized by connecting to the operating oxygen transmitter or to a polarization module prior to calibration. **The sensor is polarized and ready for operation after six hours of polarization time.**

However, if the sensor has been disconnected for only a few minutes, a shorter polarization time of about 30 minutes will be sufficient.



**Note:** The InTap 4000 e/InTap 4004 e automatically continues to supply a polarization voltage to the connected sensor even when the instrument is switched off.



**Warning!** The sensor can remain connected to a polarization source (instrument or polarization module) for **up to six months. For storage periods longer than six months, the sensor must be kept dry, i.e. without electrolyte in the membrane body, (see details in «Section 5.7»).**

## 5.3 Preconditioning of the sensor

The response time of the sensor can be substantially improved through preconditioning (injection of cleaning and conditioning solution into the measuring chamber as described in «Section 4.1, points 5 and 6», or in «Section 4.2, points 4 and 5»), particularly after exposure of the sensor to air for several minutes.

In addition, if the sensor is not being used for a longer period (e.g. overnight or during a weekend), it should be stored in the measuring chamber containing the special, anti-bacterial, cleaning and conditioning solution.

This ensures rapid response time when operation is resumed. Between measurements within the span of a day, the sensor should always be in contact with the sample medium. For hygienic reasons, we strongly recommend that the sensor be conditioned in the anti-bacterial cleaning and conditioning solution for a period of about 15 minutes at least once per day.

## 5.4 Calibration

Each oxygen sensor has its own individual slope and zero point. Both values are affected by electrolyte consumption or after exchanging the electrolyte or the membrane body. For a highly accurate oxygen measurement, the oxygen measuring system should therefore be calibrated after each change of electrolyte or membrane body. More details on calibration are given in «Section 6.5».

## 5.5 Maintenance

Visually inspect the membrane periodically for damage or contamination, but in any case always prior to calibration. If the membrane is dirty, carefully clean it with a moist, soft cloth.

The membrane body itself must be replaced (see «Section 5.8») when it begins to show signs of longer response time, drifting or noisy readings, inability to calibrate, or mechanical damage to the membrane.

The electrolyte should be changed periodically; it should **not be used longer than six months**.

## 5.6 Inspection

A periodic zero-current measurement (**not a zero calibration**) is recommended for verification of proper function of a fully polarized sensor.

This can be done by using nitrogen (N<sub>2</sub>) gas (purity at least 99.995 %), or in a sample medium saturated with nitrogen gas. (N.B. The sensor must already be polarized for this zero-current measurement).

Within two minutes exposure in an oxygen-free sample medium, the reading on the transmitter should drop to below 10 % of the reading in ambient air. Within 10 minutes, the value should have dropped to below 1 %.

Higher readings suggest a depleted electrolyte or a non-functioning membrane. Replace the electrolyte or the membrane module accordingly. If the above mentioned values are not reached after electrolyte and membrane body exchange, the sensor should be returned to your local METTLER TOLEDO representative for inspection.

## 5.7 Storage

The sensor can be stored for several months (max. 6 months), provided it is filled with oxygen electrolyte (order no. 34 100 2016) and inside the measuring chamber. The sensor should always remain connected to the instrument to maintain polarization.



**Warning!** During storage in excess of six months, the sensor must be kept dry, i.e. without electrolyte in the membrane body. It is important to note that **a dry stored sensor (without electrolyte in the membrane body) may not be connected to the instrument or to a polarization module.**

## 5.8 Exchange of electrolyte and membrane body



**Warning!** Oxygen electrolyte has a high alkaline value of pH 13. Contact of electrolyte with the skin, especially mucous membrane or eyes, should be strictly avoided. During exchange of electrolyte or membrane body, **protective gloves and glasses must be worn**. If such contact occurs, the affected area should be rinsed well with water. Get medical attention if any adverse signs appear.

METTLER TOLEDO oxygen sensors are supplied with a mounted membrane body and have been fully tested prior to leaving the works. However, if the sensor has been stored several months after delivery, the electrolyte should be renewed before use. If the membrane shows deficiencies (extended response time, increased current in oxygen-free medium, drift, mechanical damage, etc.), it has to be replaced.

### Sensor assembly

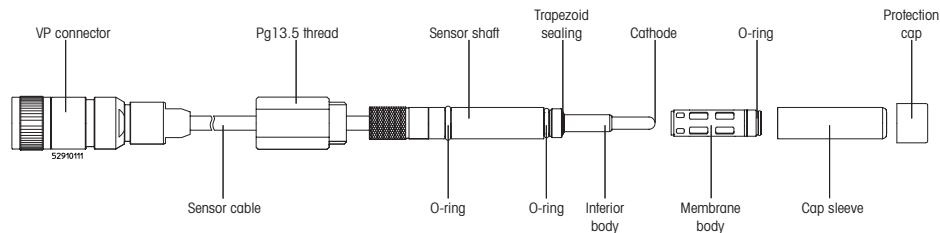

When exchanging electrolyte or membrane body, the following instructions should be observed:

- Unscrew the cap sleeve from the shaft and carefully pull it off the sensor.
- Pull off the membrane body from the interior body. If the membrane body has been pulled off still inside the cap sleeve, eject carefully by pushing it with the flat finger tip (not with the nail).



**Note:** Before electrolyte is refilled, the membrane body be removed from the cap sleeve.



- Clean the interior body with demineralized water and carefully dab dry with paper tissue.
- **Attention! The interior body of the sensor (glass body) is very delicate.** Knocks or strong vibrations can cause microcracks which can affect correct functioning of the sensor.
- Check all O-rings and the trapezoid silicone seal for mechanical defects, and replace if necessary.
- Half fill the new membrane body with oxygen electrolyte and make sure that all bubbles are removed. Air bubbles can be removed by carefully tapping on the membrane body.



**Important!** No electrolyte, sample media or contamination may be present between the membrane body and the cap sleeve. Please check carefully.

- Slip the membrane body over the interior body while holding the sensor in a vertical position. The excess electrolyte will be displaced and can be removed with a paper tissue.
- Carefully slip the cap sleeve over the fitted membrane body and tighten. The cap sleeve must be clean and dry. Remove excess electrolyte with a paper tissue.
- After each exchange of electrolyte or membrane body, the sensor must be repolarized and recalibrated.

## 6 Operation

### 6.1 Display

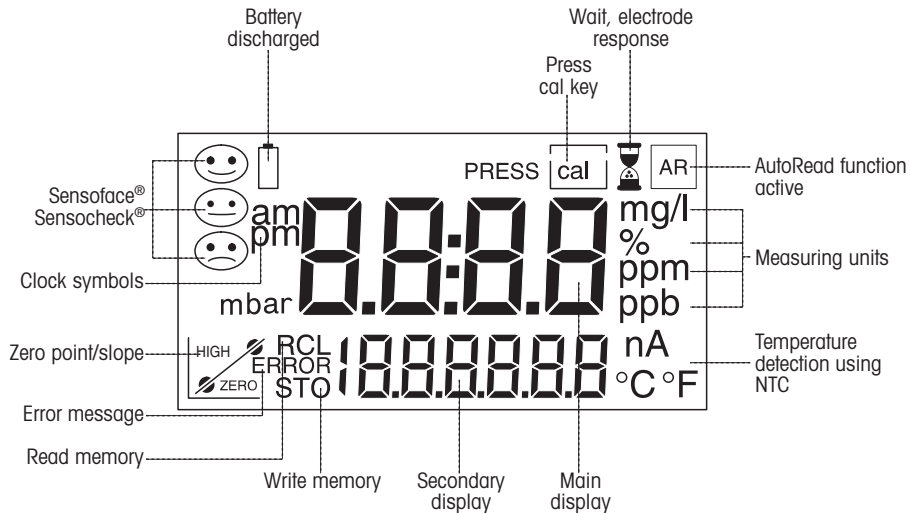

### 6.2 Keypad



Pressing «**on/off**» key switches the instrument on or off. After power-on, the instrument automatically performs a self-test and checks which type of temperature probe is connected. After power-on, the instrument is in the **measuring mode**.



**Note:** You can also switch on the instrument using the «meas» key. However, in this case only a short test is conducted and there is no determination of the temperature probe. The instrument assumes that the temperature probe last determined is still in place.



Pressing **«meas»** at any function returns the instrument automatically to measuring mode (meas = measurement).



Pressing **«cal»** starts calibration (cal = calibration).  
Through a calibration, the instrument is adjusted to the sensor. You can choose between one or two-point calibration (for details see «Section 6.5»).



Pressing cursor **«▲»** and **«▼»** serves to set the clock and the date, to select the memory locations and to determine or alter specific parameters.



Pressing **«clock»** switches the instrument to **clock mode**. All measuring procedures are discontinued and battery consumption is reduced to a minimum.





Pressing **«STO»** activates the memory of the data logger to save the measured values through manual input (STO = storage).



Pressing **«RCL»** activates the memory to recall and read the measured values (RCL = recall).

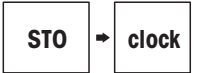

Pressing **«print»** the actual measured value is transferred to a printer for a print-out or to a PC.

-  Pressing **«RCL»** and **«print»**: **initiates a print-out of the stored measured values or transfer of the values to a PC.** First press **«RCL»**, release and then press **«print»** (see details in «Section 6.10»).
-  Pressing **«cal»** and **«print»**: **initiates a print-out of the instrument protocol or transfer of the protocol to a PC.** First press **«cal»**, release and then press **«print»** (see details in «Section 6.10»).
-  **Opens the configuration menu:** with the instrument **switched off**, the configuration menu is activated through pressing **«cal»+«on/off»**, first press **«cal»**, hold depressed and then press **«on/off»**.
-  **Data logger mode:** with the instrument **switched on**, the logger is activated by pressing **«STO»+«clock»**. First press **«STO»**, release and then press **«clock»** (for details see «Section 6.7»).



**Note:** When two keys are to be depressed, make sure that in each case the key shown on the left is pressed first.

## 6.3 Monitoring and test functions

### Monitoring of the sensor by Sensoface® and Sensocheck®

**Sensoface®** provides information on the electrode state. In addition, slope and response time during calibration are evaluated. For further details see «Section 7.1».

**Sensocheck®** continuously monitors the sensor for short-circuiting and cable breaks. For further details see «Section 7.1».

### Automatic instrument self-test

By pressing **«on/off»** key the **automatic instrument self-test checks the memory (RAM, PROM, EEPROM), display and the measured value transmission.** The analyzer generates a protocol for quality management documentation according to ISO 9000. The protocol can be printed or downloaded to a PC.



## 6.4 Configuration

The configuration menu is protected with an access code to prevent unauthorized access. This **access code** is set to «1200» at the factory and cannot be changed by the user.

### To activate the configuration menu, proceed as follows:

Press «**cal**» while the instrument is still switched off. Hold «**cal**» depressed and then press «**on/off**».



The display prompts you to enter the access code. Use cursor «▲» or «▼» to adjust access code to «1200», then confirm with «**cal**».

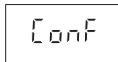

The status indicator shown on the left appears briefly on the display to confirm that the configuration menu is active. The first menu point is displayed. Using the cursors «▲» or «▼» go through the configuration menu point by point. Save each parameter before proceeding to the next point by pressing «**cal**» or «**STO**».



**Note:** With «**meas**», the configuration menu can be exited at any time. The values already set and stored will be saved.



Selection of **manual or automatic calibration**. Select «**on**» if you decide for automatic calibration, or «**off**», if you want to carry out a manual calibration by setting to a known concentration value or zero point.



Selection of required **unit** and **resolution**.



Selection of **calibration interval** (calibration timer). With this setting, the period of time can be specified within which calibration should take place. The interval may lie between 1 and 99 days. With a setting of «**00 d**» (**factory setting**), the timer is deactivated.

When approx. 80 % of the preset interval has expired, the calibration timer switches the Senseface® status indicator from ☺ to ☹. When the interval has fully expired, the status indicator switches to 😊.

Following calibration, the timer is automatically reset.



**Automatic instrument switch-off:** To conserve the batteries, the instrument switches off automatically if not actively in operation for a longer period. You can choose whether switch-off is effected after either **1 h (factory setting)** or 12 h.

The instrument does not switch off if in operation via an interface or if the data logger is active.



Selection of **print function:** Select **«On» (factory setting)** in order to activate the print function, select «Off» to deactivate.



Selection of **transmission rate at the interface:** You can adjust the transmission rate at the interface to 600, 1200, 2400, **4800 (factory setting)** or 9600 baud. The transfer rate must correspond to the set value of the printer or PC. The data format and the protocol are fixed at 7 bit, one-stop bit, even parity and XON/XOFF protocol (NMUR NE28).



Selection of **temperature unit:** This setting allows you choose between readings in **°C (factory setting)** and °F on the display.



Setting of **time/date format:** With this setting, you can select the time/date on your display to be shown either in the format **«24 hours and day.month.year» (factory setting)** or **«12 hours am/pm and month.day.year»**.

## 6.5 Calibration

Through calibration, the instrument is standardized to the sensor. For continuous operation, we recommend **regular recalibration**. Frequency will be determined by the required accuracy, the type of process, and your experience.



**Note:** The calibration menu is protected with an access code to prevent unauthorized access. This **access code** is set to «1100» at the factory and cannot be changed by the user.

The InTap 4000e/InTap 4004e offers three basic calibration modes:

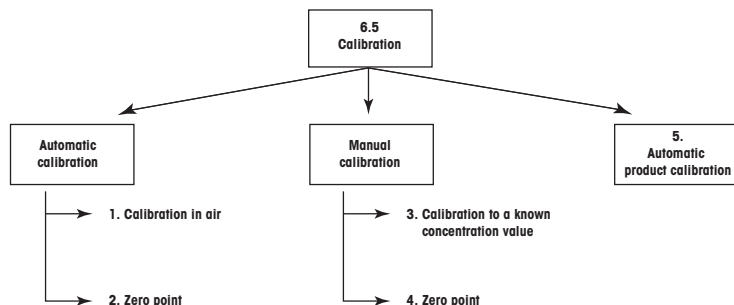

- **Automatic calibration**  
With the help of automatic calibration, the sensor can easily be calibrated in air. An automatic zero point calibration is also possible through the use of an oxygen-free nitrogen.
- **Manual calibration**  
Using manual calibration, the sensor can be calibrated to a given, defined concentration value. A manual zero point calibration is also possible by direct entry of the current value.
- **Automatic product calibration**  
By using automatic product calibration, the sensor can be adjusted to known dissolved oxygen values.



**Note:** If **no** zero point calibration is carried out during automatic or manual calibration, this is referred to as **single point calibration**. In this case, the InTap 4000 e/InTap 4004 e automatically sets the zero point to 0 nA and uses this value to determine the slope of the connected sensor.

If the zero point is determined automatically or manually, this is referred to as **two-point calibration**. In this latter case, **zero point calibration must always be carried out first** (first point) before the second point (e.g. in air) is determined.



**Warning!** Zero point calibrations are frequently a source of error. Due to the very low zero current of METTLER TOLEDO sensors, zero point calibration is unnecessary even at low oxygen concentrations.

Depending on configuration (see «Section 6.4»), calibration can be made to saturation index (%) or to concentration (ppm or mg/l).



**Note:** Before calibration, the sensor has to be connected to the instrument for **at least 6 hours** (polarization time).



**Note:** Before calibration, the membrane must be examined for damage or contamination. If the membrane is dirty, clean carefully with a soft, moist cloth.

## 1. Automatic calibration in air

Pay attention to the following points when carrying out automatic calibration in air.

- For calibration in air, the sensor membrane must be dry, since adhering water drops can falsify the measured oxygen value.
- For the most accurate measurements, always enter the **absolute ambient atmospheric pressure**. Pressures given in weather forecasts (TV, radio, press) are usually related to values at sea level and do not therefore represent absolute values. If you do not know the absolute ambient atmospheric pressure, enter the standard value 1013 mbar. As a rule, deviations from the actual absolute pressure value have very little influence on the accuracy of measurements at low oxygen concentrations.
- The oxygen concentration depends, among other things, on the relative humidity. The values determined by the instrument are based on a relative humidity of 50%. In this case however, any deviation from the effective relative humidity has a negligible influence on the measured values (< 1 %).

For automatic calibration in air, proceed as follows:



Remove the sensor from the fluidics enclosure.



In the configuration menu set **«AirCal»** to **«On»**, then revert to the measuring mode by pressing **«meas»**.

Press **«cal»** to activate calibration mode.



The display prompts you to enter the access code. Use cursor **«▲»** or **«▼»** to adjust access code to **«1100»**, then confirm with **«cal»**.



Using the cursors **«▲»** or **«▼»**, select **«AirCal»** for the calibration in air and confirm with **«cal»**.



Using the cursors **«▲»** or **«▼»**, set the actual ambient air pressure.



Press **«cal»** to start calibration procedure. For checking purposes, the actual sensor current and the timer (hourglass) are continuously displayed.



As soon as calibration has been successfully completed, the display shows the sensor current, the concentration or saturation, and the Sensoface® symbol. Then press **«cal»** to end calibration. The new slope value is automatically accepted.



**Note:** By pressing **«meas»**, calibration can be aborted at any time and the existing previous calibration values remain active

### Possible **fault indications**



Maximum calibration time expired



Invalid spectrum of slope

## 2. Automatic zero point calibration

Basically, zero point calibration of METTLER TOLEDO oxygen sensors is unnecessary. If such calibration is nevertheless desired, the following points should be observed:



**Warning!** Use only oxygen-free medium with a purity of at least 99.995 % (e.g. nitrogen gas).

**Warning!** If a **two-point calibration** is carried out, **always start with a zero point calibration**.

For automatic zero point calibration, proceed as follows:



Place sensor in an oxygen-free medium (see note above).

**Warning!** **Wait at least 20 minutes before starting the calibration procedure.**



In the configuration menu set **«AirCal»** to **«On»**, then revert to the measuring mode by pressing **«meas»**.

Press **«cal»** to activate calibration mode.



The display prompts you to enter the access code. Use cursor «▲» or «▼» to adjust access code to «1100», then confirm with «**cal**».



Using the cursors «▲» or «▼», select the «**OPoint**» for the zero point calibration.



Press «**cal**» key to start calibration procedure. For checking purposes, the actual sensor current and the timer (hourglass) are continuously displayed.



As soon as calibration has been successfully completed, the display shows the sensor current, the concentration or saturation, and the Sensoface® symbol. Then press «**cal**» to end calibration. The new zero point is automatically accepted.



**Note:** By pressing «**meas**», calibration can be aborted at any time and the existing previous zero point remains active.

### Possible **fault indications**



Maximum calibration time expired



Zero point outside permissible range

### 3. Manual calibration by setting a known concentration value (HIGH)

Pay attention to the following points when carrying out manual calibration to a known concentration value:

- Ensure that the oxygen saturation index of the calibration medium is correct and remains constant during calibration.
- For calibration in water or sample medium, the calibration medium must be in equilibrium with the air. Oxygen exchange between water and air is only very slow. Therefore, it takes quite a long time until water is saturated with atmospheric oxygen. For correct calibration, a minimum flow rate of the calibration medium is necessary.
- For the most accurate measurements, always enter the **absolute ambient atmospheric pressure**. Pressures given in weather forecasts (TV, radio, press) are usually related to values at sea level and do not therefore represent absolute values. If you do not know the absolute ambient atmospheric pressure, enter the standard value 1013 mbar. As a rule, deviations from the actual absolute pressure value have very little influence on the accuracy of measurements at low oxygen concentrations.
- Make sure that all parameters, such as oxygen saturation index, temperature and pressure, remain constant.

For manual calibration to a known concentration value, proceed as follows:



In the configuration menu set «**AirCal**» to «**OFF**», then revert to the measuring mode by pressing «**meas**».

Place sensor in a solution of known oxygen content. Then, press «**cal**» to activate calibration mode.



The display prompts you to enter the access code. Use cursor «**▲**» or «**▼**» to adjust access code to «1100», then confirm with «**cal**».



Using the cursors «**▲**» or «**▼**», select «**SET HIGH**» for calibration to a known concentration value, and confirm with «**cal**».



Using the cursors «**▲**» or «**▼**», enter the actual ambient air pressure.





Press **«cal»** to start calibration procedure. For checking purposes, the actual sensor current and the actual temperature are displayed alternately. Using the cursors **«▲»** or **«▼»** enter the known concentration value.

Press **«cal»** to end calibration. The known concentration value is accepted.



**Note:** By pressing **«meas»**, calibration can be aborted at any time and the existing previous calibration values remain active.

#### 4. Manual zero point calibration

Basically, zero point calibration of the METTLER TOLEDO oxygen sensor is unnecessary. If such calibration is nevertheless desired, the following points should be observed:



- **Warning!** Use only oxygen-free medium with a purity of at least 99.995 % (e.g. nitrogen gas).
- **Warning!** If a **two-point calibration** is carried out, **always start with a zero point calibration**.

For manual zero point calibration proceed as follows:



Place sensor in an oxygen-free medium or in a medium which is used as a zero point standard (see note above).

**Warning! Wait at least 20 minutes before starting the calibration procedure.**



In the configuration menu set **«AirCal»** to **«OFF»**, then revert to the measuring mode by pressing **«meas»**.

Press **«cal»** to activate calibration mode.



The display prompts you to enter the access code. Use cursor **«▲»** or **«▼»** to adjust access code to **«1100»**, then confirm with **«cal»**.



Using the cursors **«▲»** or **«▼»**, select **«Set Op point»** for zero point calibration, and confirm with **«cal»**.



Using the cursors «▲» or «▼», determine the zero point current.

Press «**cal**» to end calibration. The new zero point is accepted.



**Note:** By pressing «**meas**», calibration can be aborted at any time and the existing previous calibration values remain active.

## 5. Automatic product calibration

By using automatic product calibration, the sensor can be calibrated to known dissolved oxygen values.



**Note:** The product calibration is limited to dissolved oxygen values between 0 and 0.5 mg/l (0 and 500 ppb). The maximum adjustment in defined area is  $\pm 0.05$  mg/l (maximum  $\pm 50$  ppb).

- The InTap 4000 e/InTap 4004 e have to be connected to the process and the sensor have to be in contact with the measurement fluid.
- The dissolved oxygen concentration has to be constant during the time of process calibration. The product calibration will be automatically stopped if no constant DO concentration will be reached after one minute. Error message «**ERROR t.out**» will appear.

For automatic product calibration proceed as follows:



**Note:** First connect sensor to your process fluid.



In the configuration menu set «**AirCal**» to «**On**», then revert to the measuring mode by pressing «**meas**».

Press «**cal**» to activate calibration mode.



The display prompts you to enter the access code. Use cursor «▲» or «▼» to adjust access code to «1105», then confirm with «cal».



Press «cal» to start calibration procedure. For checking purposes, the actual sensor current and the timer (hourglass) are continuously displayed.



**Note:** By pressing «meas», calibration can be aborted at any time and the existing previous calibration values remain active.



As soon as calibration has been successfully completed, the display shows the sensor current and the concentration or saturation. The maximum calibration area is 0.5mg/l (500ppb). Then press «cal».

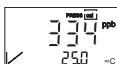

Use the cursor «▲» or «▼» to adjust the required oxygen concentration. The maximum adjustment is  $\pm 0.05$  mg/l (maximum  $\pm 50$  ppb). Press «cal» to end calibration.

#### Possible **fault indications:**



Maximum calibration time expired



Maximum calibration area of 0.5 mg/l (500ppb) exceeded.

## 6.6 Measurement

### Continuous measurement

After switching on or following brief actuation of «meas», the instrument is active in the normal measuring mode. In the normal measuring mode, both the measured value and the temperature reading are continuously actualized. Independent of configuration (see «Section 6.4») and the parameter, the measured value will be displayed in one of the following formats:



Format x.xxx ppm (only for values <2 ppm)



Format xx.xx ppm

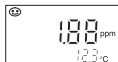

Format xx.x ppm



Format xxxx ppb (only for values <1999 ppb)



Format xxx.x %



Format xxx %



Format x.xxx mg/l (only for values <2 mg/l)



Format xx.xx mg/l



Format xx.x mg/l

### Measurement with AutoRead

With the function **AutoRead**, a measured value and the corresponding temperature can be frozen on the display.

**Activation** of the AutoRead function: **Press «meas» for at least 3 seconds.**

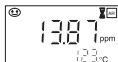

Measurement value and temperature are determined, display runs, hour glass and AR flash until the measurement value is stable.



Measured value and temperature are frozen (hour glass off, AR in display).

In order to determine a new measured value and to «freeze» it, briefly push **«meas»**. The hour glass and AR in display flash until the measurement value is stable. Then again, measured value and temperature are frozen (hour glass off, AR in display).

To end the function AutoRead: **Press «meas» again for at least 3 seconds.**

## 6.7 Data logger

The data logger records up to 200 measured values together with temperature, time and date in the data memory of the InTap 4000 e/InTap 4004 e.

The data memory of the InTap 4000 e/InTap 4004 e is a loop memory, i.e. as soon as the last memory location (199) has been reached, recording automatically continues at location 00. The old value at this location is overwritten with the new value.



**Note:** If more than 200 values must be recorded, connect the InTap 4000 e/InTap 4004 e to a PC via the corresponding RS 232 interface cable and use the transfer software package «Paraly SW109» (both included in the delivery). See «Sections 6.9 and 6.10» for detailed information.

Recording takes place depending on the configuration of the data logger: either manually by pressing a key, or interval or event-controlled. The data logger always records the current measured variable in the specific unit/resolution set during configuration.

### Activation and configuration of the data logger mode and starting of recording of measured values.

First briefly press «STO» and then «clock» to activate the **data logger mode**. The menu of the data logger mode is arranged as follows:

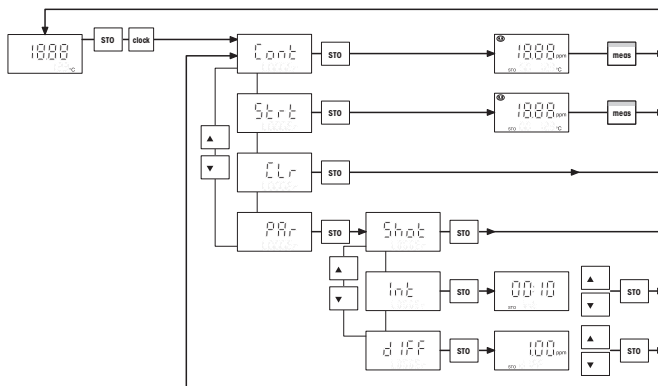



Menu point «**Cont**» (= Continue): By pushing «**STO**» at this menu point, the instrument switches to the **logging mode**.

Logging (manual, event or interval-controlled) is then recommenced **at the memory location directly following the location at which the last measured value was stored**.



Menu point «**Start**» (= Start): By pushing «**STO**» at this menu point, the instrument switches to the **logging mode**.

The data **memory area is completely cleared** and logging (manual, event or interval-controlled) **commences at the first memory location 00**.



Menu point «**Clr**» (= Clear): By pushing «**STO**» at this menu point, the **data memory is completely cleared** and the instrument returns to the measuring mode.



Menu point «**Par**»: Pushing «**STO**» at this menu point activates the parameter menu (choice of recording methods). Using the cursors «**▼**» or «**▲**» then select whether the logging method is to be manual, event or interval-controlled:



If you wish to use **manual logging** (Shot), push «**STO**» at this selection point. In this logging mode press «**STO**» at each measured value you wish to record.



If you wish to use **interval-controlled logging** (Int), push «**STO**» at this selection point.



Then, using the cursors «**▼**» or «**▲**», set the required interval time (range: 5 sec. to 60 min.) for recording. Press «**STO**» to confirm the set value. In this logging mode a measured value will be automatically recorded at the set interval.



If you wish to use **event-controlled logging** (dIFF), push **«STO»** at this selection point.



Then, using the cursors **«▼»** or **«▲»**, set the value of the differential at which a measurement should be recorded. Press **«STO»** in order to confirm the set value. In this logging mode a measured value will be automatically recorded as soon as it deviates from the last measured value by the set differential. Simultaneous time recording allows you to establish when the value changed.



**Note:** The differential value always refers to the current configured unit of measurement (% , ppm or mg/l).



**Note:** By pushing **«meas»**, the data logger can be aborted at any time and the instrument automatically returns to the measuring mode.



## 6.8 Clock mode

### Activating the clock mode

In the clock mode, battery consumption by the instrument is reduced to a minimum. Activate the clock mode if you do not intend to carry out measurements over a certain period of time. This will prolong the life of your batteries.



If you press **«clock»** when in the measuring mode, time and date will be displayed.



**Note:** To leave clock mode, press **«meas»**. The instrument automatically returns to the measuring mode.

### Setting of time and date



**Note:** To set the clock or the date, the clock mode must first be activated.

When in clock mode, first press **«STO»**, **hold the key depressed**, then press **«clock»**.

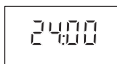

The time display flashes. Using the cursors **«▼»** or **«▲»**, set the time. Store the data by pushing **«STO»**.



The date display flashes. Using the cursors **«▼»** or **«▲»**, set the date. Store by pushing **«STO»**.



The year display flashes. Using the cursors **«▼»** or **«▲»**, set the year. Store by pushing **«STO»**. The instrument then returns to the clock mode.



**Note:** Time and date can be switched to US format (see «Section 6.4»).

## 6.9 Serial Interface

The InTap 4000 e/InTap 4004 e is equipped with an RS232 interface and can be connected to a printer with serial port, or directly to a PC.

Using the various key functions of the InTap 4000 e/InTap 4004 e, the actual measured value, memory or instrument protocol can each be directly printed out by a printer or transferred to a PC (see «Section 6.10»).

Data transfer to a PC requires the use of the transfer software package «Paraly SW109» which is included in the delivery. This software also enables the InTap 4000 e/InTap 4004 e to be completely remote controlled.

**Instructions on use of the software «Paraly SW109» are given in the on-line help of the software.**

### Interface cable

To connect the InTap 4000 e/InTap 4004 e to the serial port of a printer or PC, use the interface cable included in the delivery. Depending upon the position in which the three-pin plug is plugged into the socket of the InTap 4000 e/InTap 4004 e, the interface cable can be used either for a printer or a PC (see below illustration).

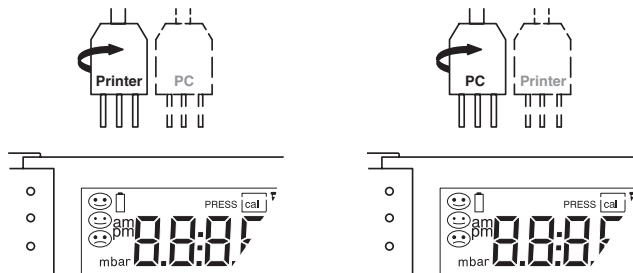

### Plug pin assignment of the interface cable

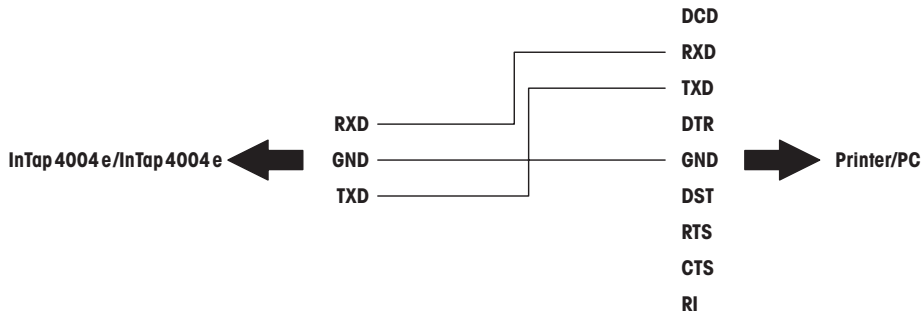

### Interface parameters

The RS232 interface allows parameterization of all common baud rates. Setting is carried out in the configuration menu (see «Section 6.4»):

Baud rates:

- 600 Bd
- 1 200 Bd
- 2 400 Bd
- 4 800 Bd (factory setting)**
- 9 600 Bd

Data format and protocol are permanently set to:

**7 data bit**  
**even parity**  
**one stop bit**  
**XON/XOFF protocol**



**Note:** For the command set-up of the InTap 4000e/InTap 4004 e, refer to the on-line help of «Paraly SW 109» transfer software.

## 6.10 Printing of measured values and protocols/transfer to a PC



**Note:** In order to be able to print out measured values and protocols or to transfer this data to a PC, the **print function** in the configuration menu (see «Section 6.4») has to be **activated (Print on)**. In addition, the **baud rate** of the instrument must **correspond** to the baud rate of the printer/PC, and the instrument already **connected to a printer/PC by means of the appropriate interface cable**. For data transfer to a PC, the transfer software «Paraly SW109» must also be already installed, and running on the PC. Instructions on use of the software «Paraly SW109» are given in the on-line help of the software.

### Current measured values: printing/transfer to a PC

Each time the **«print»** key is pressed a data record with the following format will be printed out or transferred to the PC accordingly:

Measurement counter	Measuring value	Temperature	Date	Time
023	8.500ppm	23.6°C	08.08.03	11:11
024	8.500ppm	23.6°C	08.08.03	11:11



**Note:** The measurement counter is incremented automatically. Each time the transmitter is switched off the counter is reset to «000».



**Note:** The «\*» symbol at the beginning of a data record indicates that the Sensiface® symbol showed ☹ (incorrect measuring value) when recording a value. The «#» symbol at the beginning of a data record indicates that the permissible measurement range (ppm, mg/l, %, nA, °C/°F) was exceeded or the clock not set when recording a value.

### Data memory: printing/transfer to a PC

While in measuring mode, first press **«RCL»** and then **«print»**. All records in the data memory will be printed out or transferred to the PC accordingly.

Memory location	Measuring value	Temperature	Date	Time
S000	8.500ppm	23.6°C	08.08.03	11:11
S000	8.500ppm	23.6°C	08.08.03	11:11
S002	8.500ppm	23.6°C	08.08.03	11:11
S003	8.500ppm	23.6°C	08.08.03	11:11



**Note:** The «\*» symbol at the beginning of a data record indicates that the Sensoface® symbol showed ☹️ (incorrect measuring value) when recording a value. The «#» symbol at the beginning of a data record indicates that the permissible measurement range (ppm, mg/l, %, nA, °C/°F) was exceeded or the clock not set when recording a value.



**Note:** If you only want to print the data of a specific memory location or have this data transferred to a PC, first press «**RCL**» while in the measuring mode. Then, using the cursors «**▼**» or «**▲**», select the desired memory location and confirm by pressing «**print**».

### Instrument protocol: printing/transfer to a PC

While in measuring mode, first press «**cal**» and then «**print**». The protocol will be printed out or the date transferred to the PC accordingly. The protocol contains the following data:







METTLER TOLEDO InTap 4000e 08.08.03		
Serial Number:	01393936	Serial number of the instrument and software version
Software Version:	2.0	
Calibration Record		
Last Calibration:	08.08.03 10.10	Calibration record with the exact data of the last calibration
Sensor System Data	On	
Q-Point uncompensated:	0.00nA	
Q-Point Temperature:	25.0oC	
High uncompensated:	-53.41 nA	
High Temperature:	23.7oC	
High Pressure:	1013mbar	
Slope compensated:	~.2670nA/mbar	
Next Calibration in	99d	
Configuration Setting		
Cal Timer:	99d	Settings of the configuration menu
Autocal:	On	
Oxygen concentration:	oo.oppm	
AutoOff Timer:	12h	
Printer:	On	
Baud Rate:	9600	
Temperature Unit:	oC	
Date Format:	24.00	
Time:	10.30	
Date:	08.08.03	
Datalogger Mode:	Single Shot	
Diagnostics		
Device Check	-ok-	Record of the last instrument self-test
Battery Check	-ok-	
Clock setting	-ok-	
Sensoface(++/oo/--)		List of the current Sensoface® criteria
Cal Timer:	++	
Sensor Q-Point:	++	
Sensor High:	++	

## 7 Diagnostics, maintenance and cleaning

### 7.1 Sensoface®, Sensocheck® functions

The Sensoface® function evaluates information about the slope and response time during calibration. The results of the Sensocheck® function which continuously monitors the sensor state (impedance check) during measurement procedure are also incorporated in the evaluation.

The three Smileys provide the instrument user with status information on the quality of the last calibration or the condition of the sensor. They indicate when a new calibration or maintenance work is necessary.

Sensoface	Information	Significance
	 	Calibration timer expired. Carry out calibration
		Sensor guarantees correct measurement
		Sensor still serviceable, but replacement of the membrane module and electrolyte due
		Sensor no longer guarantees correct measurements Membrane module and electrolyte to be replaced



**Note:** The worsening of a Sensoface® criterion leads to a negative progression in the Sensoface® indicator from 😊 to 😞.



**Note:** A reversal of the progression of the Sensoface® indicators to 😊 can only be achieved through calibration or, if relevant, through correction of a sensor defect.

## 7.2 Battery replacement

If the battery symbol  appears in the display, the batteries need replacement. However, you can still use the instrument for a few days. When the battery voltage decreases further, the instrument switches off.



**Note:** Since battery consumption is higher when the remote interface is used, the battery symbol will be displayed sooner in that case.



**Warning!** Never change the batteries within a hazardous area.

For battery replacement you need **three standard alkaline AAA batteries 1.5V (LR03)**. Proceed as follows:

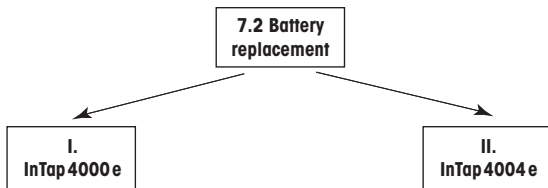

### I. Battery replacement for InTap 4000 e

1. Switch off the instrument.
2. Release the sensor cable from the instrument (recommendation).
3. Unscrew the plug from battery case. Take out discharged batteries and dispose properly.
4. Insert three new standard alkaline AAA batteries 1.5V (LR03) according to drawing.



**Warning!** The use of rechargeable or other types of batteries with a different specification is not permissible.

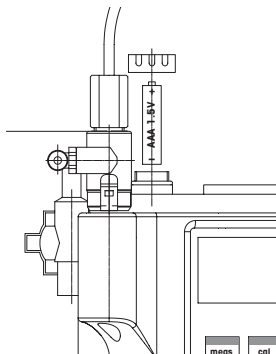

5. Screw-up the plug to battery case.

**Warning!** Before screwing-up the battery case, make sure that the o-ring and the plug are not damaged and are correctly seated.

6. Reconnect the sensor cable.
7. The sensor has to be re-polarized!

If the sensor has been disconnected for only a few minutes, a polarization time of about 60 minutes will be sufficient. Otherwise it has to be polarized for six hours.



**Note:** Refer to «Section 5.2» (preparation for use).



**Note:** During battery change, all calibration and configuration data as well as the complete memory are retained.

The calibration timer runs out. And the current memory location number of the data logger is set to «00». **Time and date must be reset.**



**Warning!** If you want to store the instrument for a longer time, the batteries must always be removed beforehand. **Leaky batteries may damage the instrument!**



## II. Battery replacement for InTap 4004 e

1. Switch off the instrument.
2. Release the sensor cable from the instrument.
3. Pull the fluidics enclosure toward the front, then shift it to the left to remove the enclosure from the hinge (see figures below).



4. Unscrew the plug from battery case. Take out discharged batteries and dispose properly.
5. Insert three new standard alkaline AAA batteries 1.5V (LR03) according to drawing.  
**Warning!** The use of rechargeable or other types of batteries with a different specification is not permissible.
6. Screw-up the plug to battery case.  
**Warning!** Before screwing-up the battery case, make sure that the o-ring and the plug are not damaged and are correctly seated.
7. Remount the fluidics enclosure, and reconnect the sensor cable.
8. The sensor has to be re-polarized!  
If the sensor has been disconnected for only a few minutes, a polarization time of about 60 minutes will be sufficient. Otherwise it has to be polarized for six hours.



**Note:** Refer to «Section 5.2» (preparation for use).



**Note:** During battery change, all calibration and configuration data as well as the complete memory are retained. The calibration timer runs out. And the current memory location number of the data logger is set to «00». **Time and date must be reset.**



**Warning!** If you want to store the instrument for a longer time, the batteries must always be removed beforehand. **Leaky batteries may damage the instrument!**

### 7.3 Error messages

No. (Err)	Display/pictograph blinking	Error message	Possible causes	Procedure
01	Measured value and <b>ERROR</b>	Measurement range exceeded	Overflow Faulty sensor	Check process medium Check sensor consider recalibration
03	Measured value, Temperature and <b>ERROR</b>	Temperature measuring range exceeded	Faulty temperature probe or short circuit	Replace sensor
04	<b>0 Point</b> and <b>ERROR</b>	Zero point cannot be calibrated	Electrolyte depleted, faulty sensor	Check sensor Replace electrolyte, consider recalibration
05	<b>SLOPE</b> and <b>ERROR</b>	HIGH value cannot be calibrated	Electrolyte depleted, faulty sensor	Clean sensor Consider membrane replacement
11	<b>t.out</b> and <b>ERROR</b>	Unstable sensor signal	Electrolyte depleted, faulty sensor	Clean sensor Consider membrane replacement
14	<b>Error 14</b>	Clock breakdown	Battery replacement	Set clock and date
15	<b>Error 15</b>	Interface transmission error	Incorrect plug connection Baud rates of measuring instrument and printer/PC do not match	Check plug connection Set baud rates
18	<b>Error 18</b>	Configuration and calibration data corrupt		Contact METTLER TOLEDO Service
19	<b>Error 19</b>	Compensation data calibration data corrupt		Contact METTLER TOLEDO Service

No. (Err)	Display/pictograph blinking	Error message	Possible causes	Procedure
–	<b>t. out</b> and <b>ERROR</b>	<b>t. out</b>	Maximum calibration time exceeded	Abort calibration with « <b>meas</b> » key, clean sensor, Consider membrane replacement. Check whether membrane contains electrolyte.
–	<b>ERROR</b> and <b>SLOPE</b>	<b>SLOPE</b>	Non-permissible range	Abort calibration with « <b>meas</b> » key, clean sensor, Consider membrane replacement. Check whether membrane contains electrolyte.
–	<b>ERROR</b> and <b>0-Point</b>	<b>0-Point</b>	Non-permissible range	Abort calibration with « <b>meas</b> » key, clean sensor, Consider membrane replacement. Check whether membrane contains electrolyte. Check oxygen-free medium.
–	<b>ERROR</b> and <b>PrdCAL</b>	<b>PrdCAL</b>	Calibration range exceeded	Abort calibration with « <b>meas</b> » key, clean sensor, consider membrane replacement. Check whether membrane contains electrolyte. If check o.k., process medium contains more than 0.5 mg/l (500 ppb) DO.

## 7.4 Maintenance and cleaning

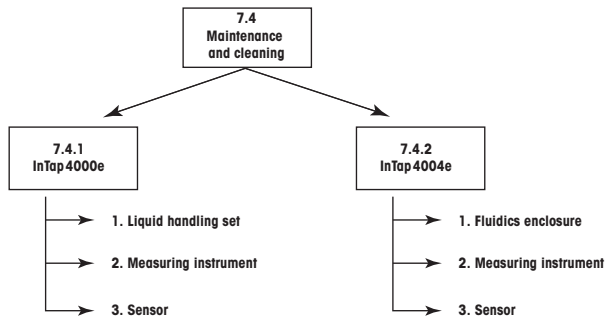

### 7.4.1 InTap 4000 e

1. Liquid handling set
  - Rinse tubing, three-way valve and measuring chamber periodically with cleaning and conditioning solution.
  - Seals of the liquid handling sets to be exchanged if necessary.
2. Measuring instrument
  - To remove dust and dirt, the external surfaces of the instrument may be cleaned with a moist tissue. If necessary, a mild household cleaner may be used.



**Warning! Never use organic solvents** such as acetone to clean the instrument.

3. Sensor
  - see «**Section 5, The Sensor**».

### 7.4.2 InTap 4004 e

1. Fluidics enclosure
  - Switch off the instrument.
  - Release the sensor cable from the instrument.
  - Pull the fluidics enclosure toward the front, and then shift it to the left to remove the enclosure from the hinge (see figures below).



- Remove the sensor from the fluidics enclosure.

- Remove the four screws and open the front panel (see figure below).



- Clean the inside of the fluidics enclosure with a moist tissue.
- Check the tubings and replace if necessary (InTap 4004e tubing kit – order no. 52 200 998). See figures below for the correct connection of the tubes.

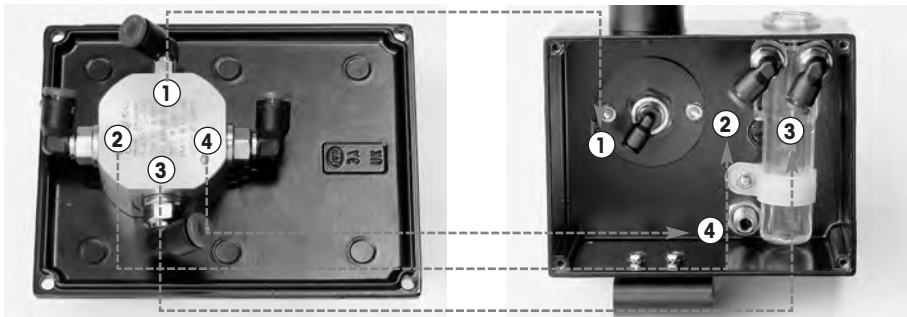

## 2. Measuring instrument

- To remove dust and dirt, the external surfaces of the instrument may be cleaned with a moist tissue. If necessary, a mild household cleaner may be used.



**Warning! Never use organic solvents** such as acetone to clean the instrument.

## 3. Sensor

- see «**Section 5, The Sensor**».



## 8 Spare parts

<b>Designation</b>	<b>Order no.</b>
InTap 4000e/4004e sensor	52 200 766
InTap 4000e/4004e transmitter	52 201 009
InTap 4000e/4004e O-ring set	52 200 774
InTap 4000e/4004e measuring cell	52 200 258
InTap 4000e/4004e casing, blue with black top cover	52 200 259
InTap 4000e/4004e membrane kit consisting of: – 4 membrane bodies InTap 40040e/4004e, replacement O-rings, 25 ml electrolyte	52 200 773
InTap 4000e carrying case	52 200 818
InTap 4004e fluidics enclosure and fixation set	52 200 995
InTap 4004e tubing kit consisting of: – discharge tube, 4 tubing for fluidics enclosure	52 200 998
InTap 4004e up-grade kit consisting of: – fluidics enclosure with Zwickel, tubing adapter kit, instruction manual InTap 4004e	52 201 011
InTap 4004e tubing adapter kit for conditioning	52 201 000
Electrolyte (25 ml)	34 100 2016
Cleaning and conditioning set consisting of: – 20 tablets, 1 beaker, 1 syringe	52 200 255
Liquid handling set consisting of: – supply tube, bypass tube, discharge tube, 3-way valve, 2 screws for valve	52 200 770

## 9 Technical data

### Analyzer Description

Display	LC display	
Sensoface®/Sensocheck®	Permanent sensor and analyzer monitoring indicates if calibration diagnostics or maintenance is required	
Automatic analyzer self-test	Analyzer status logging of RAM, PROM, EEPROM and display for QM documentation acc. to ISO 9000. Data recallable via RS 232 interface.	
Automatic calibration timer	0 ... 99 days (0=off)	
Data management	200 measurement values. Stored either manually, time-controlled or event-controlled.	
Power supply	3 x AAA-batteries 1.5 V (LR03)	
Automatic switch-off	Configurable between 1 and 12 hours. Disabled during operation via interface or using data logger.	
Data retention	Parameter and calibration data > 5 years (EEPROM)	
Interface	RS 232 Baud rate: configurable to 600/1200/2400/4800 and 9600 7 data bits, even parity, one stop bit, XON/XOFF protocol	
Protection system	IP 66	
Dimension	195 x 230 x 75 mm / 7.7 x 9.1 x 3.0" (W x H x D)	
Process connection	InTap 4000 e:	Tubing set (Ø 4 mm / 0.16")
	InTap 4004 e:	Zwickel adapter unit
Material	Transmitter housing:	PA
	Interface clip:	ABS

Protective housing:	PU	
Weight	InTap4000e:	1.56 kg (3.44 lbs)
	InTap4004e:	2.95 kg (6.50 lbs)
Certification	El. safety:	EN 50014, EN 50020
	EMV:	89/336/EEC
	Emissions:	EN 50081-1, EN 61326, EN 61326/A
	Immunity:	EN 500082-2, EN 61326, EN 61326/A1

### Sensor description

Measurement principle	Amperometric/polarographic	
Dimension	Diameter:	12 mm (0.47")
	Length:	86 mm (3.39")
Connection	VarioPin (IP68)	
Polarization	Connected sensor is automatically polarized, even when analyzer is switched-off.	
Temperature sensor	NTC 30k $\Omega$ (for temperature compensation)	
Accuracy of temperature probe	< 0.2 °C $\pm$ 1 digit	

### Ambient conditions

Storage temperature	-20 ... +70 °C (-4 ... 158 °F)	
Operating temperature	-10 ... +55 °C (14 ... 131 °F)	
Atmospheric humidity	0 ... 100 %	

**Display units**

Air saturation	0 ... 199 % 0.0 ... 199.9 %
Dissolved O <sub>2</sub> concentration	0.000 ... 1.999 ppm or mg/l 0.00 ... 19.99 ppm or mg/l
Temperature	-10 ... 70 °C (14 ... 158 °F)

**Performances**

Detection limit	0.006 mg/l (6 ppb)
System accuracy	O <sub>2</sub> saturation:     ≥ ±[0.5 % of reading +0.1 %] O <sub>2</sub> concentration:     ≥ ±[0.5 % of reading +0.01 mg/l] ≥ ±[0.5 % of reading +10 ppb] (within temperature range from 0 ... 35 °C / 32 ... 95 °F)
Response time (t <sub>98</sub> ) (air → nitrogen [N <sub>2</sub> ])	< 60 seconds
Calibration	Automatic calibration in air Automatic zero point calibration Manual calibration to defined DO concentration Manual zero point calibration Automatic product calibration

## 10 EU Declaration of conformity



**We**

---

**Mettler-Toledo GmbH, Process Analytics**

Im Hackacker 15  
8902 Urdorf  
Switzerland

declare under our sole responsibility that the product,

**Description**

---

**InTap 4000 e/InTap 4004 e**

to which this declaration relates is in conformity with the following standard(s) or other normative document(s).

**EI. Safety**

---

**EN 50014: 1997, EN 50020: 1994**

**EMV Directive**

---

**89/336/EEC**

**Emissions**

---

**EN 50081-1, EN 61326, EN 61326/A1**

**Immunity**

---

**EN 50082-2, EN 61326, EN 61326/A1**

**Date of issue**

---

**August, 2003**





- BR** **Mettler-Toledo Ind. e Com. Ltda.**, Alameda Araguaia, 451-Alphaville, BR-06455-000 Barueri-SP, Brazil  
Tel. +55 11 4166 74 00, Fax +55 11 4166 74 01
- CH** **Mettler-Toledo (Schweiz) AG**, Im Langacher, CH-8606 Greifensee, Switzerland  
Tel. +41 44 944 45 45, Fax +41 44 944 45 10
- D** **Mettler-Toledo GmbH**, Prozeßanalytik, Ockenweg 3, D-35396 Gießen, Germany  
Tel. +49 641 507-333, Fax +49 641 507-397
- F** **Mettler-Toledo Analyse Industrielle Sàrl**, 30 Bld. de Douaumont, BP 949, F-75829 Paris Cedex 17, France  
Tel. +33 1 47 37 06 00, Fax +33 1 47 37 46 26
- USA** **Mettler-Toledo Ingold, Inc.**, 36 Middlesex Turnpike, Bedford, MA 01730, USA  
Tel. +1 781 301-8800, Toll free +1 800 352-8763, Fax + 1 781 271-0681