

# M 700(X)

---

Additional functions



---

Latest product information: [www.mtpro.com](http://www.mtpro.com)

Order number: 52 121 241

**METTLER TOLEDO**



70501

## Warranty

Defects occurring within 1 year from delivery date shall be remedied free of charge at our plant (carriage and insurance paid by sender).

©2005 Subject to change without notice

---

## Return of products under warranty

Please contact your local Mettler-Toledo representative before returning a defective device. Ship the cleaned device to the address you have been given. If the device has been in contact with process fluids, it must be decontaminated/disinfected before shipment. In that case, please attach a corresponding certificate, for the health and safety of our service personnel.

## Disposal

Please observe the applicable local or national regulations concerning the disposal of "waste electrical and electronic equipment".

---

## Registered trademarks

The following registered trademarks are used in this instruction manual without further marking

CalCheck  
Calimatic  
Sensocheck  
Sensoface  
ServiceScope  
VariPower

SMARTMEDIA®  
is a registered trademark of Toshiba Corp., Japan

InPro®  
is a registered trademark of Mettler Toledo GmbH, Switzerland

---

Mettler-Toledo GmbH, Process Analytics, Industrie Nord,  
CH-8902 Urdorf, Tel. +41 (44) 736 22 11 Fax +41 (44) 736 26 36  
Subject to technical changes. Mettler-Toledo GmbH, 11/05.  
Printed in Germany.



# Additional functions

---

for the M 700(X) modular measuring system

## Additional functions

Latest product information .....	4
How to order an additional function .....	5

## Information on TAN release and SmartMedia cards

Activating an additional function (Option release) .....	6
SmartMedia card .....	30

## Provided by: TAN

52121198	SW 700-001	KI recorder .....	7
52121199	SW 700-002	Buffer sets to be entered (pH) .....	13
52121201	SW 700-004	ServiceScope (pH) .....	14
52121202	SW 700-005	Tolerance band recorder (pH) .....	15
52121203	SW 700-006	Current characteristic definable .....	17
52121204	SW 700-008	TC ultrapure water (Cond) .....	19
52121205	SW 700-009	Concentration determination (Cond) .....	20
52121250	SW 700-011	High CO <sub>2</sub> compensation (O <sub>2</sub> ) .....	26
52121274	SW 700-012	ISFET for ISM module pH 2700i(X) .....	28

## Provided by: TAN. SmartMedia card required.

52121192	SW 700-102	5 loadable parameter sets .....	35
52121193	SW 700-103	Measurement recorder .....	37
52121194	SW 700-104	Extended logbook .....	40
52121195	SW 700-106	Software update .....	41
52121196	SW 700-107	AuditTrail and Signature .....	45

# Latest product information

---

Additional functions

The M 700 is an expandable modular process analysis system.  
For latest product information, please refer to:

**[www.mtpro.com](http://www.mtpro.com)**

## **Additional functions**

A current version of the respective function description is available as pdf for download.

# How to order an additional function

Device-specific TAN (transaction number)

Additional functions expand the device capabilities.

The additional functions are device-specific. When ordering an additional function, you therefore have to specify the serial number and hardware version of your M 700 FRONT in addition to the respective order number. The manufacturer then supplies a TAN (transaction number) to release the additional function.

## Serial number of M 700 FRONT

Menu	Display	Serial number FRONT M 700
		<p><b>Menu selection</b></p> <p>Call up diagnostics. From the measuring mode: Press <b>menu</b> key to select menu. Select diagnostics using arrow keys, confirm with <b>enter</b>.</p>
		<p><b>Diagnostics</b></p> <p>Select Device description using arrow keys, confirm with <b>enter</b>.</p>
		<p><b>Device description</b></p> <p>Please specify the <u>serial number/hardware version</u> when ordering an additional function.</p>

# Activate additional function

Select menu: Parameter setting/System control/Release of options

**Note:** The TAN for releasing an additional function is only valid for the device with the corresponding serial number (see previous page).

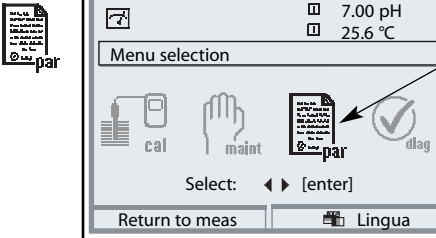
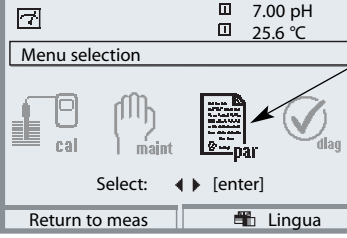
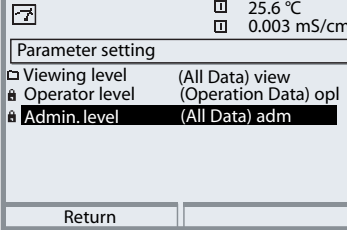
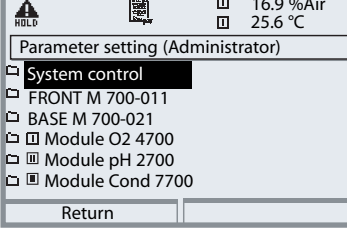
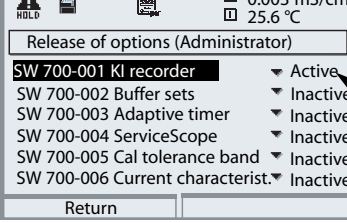
Menu	Display	Activate additional function
		<p><b>Menu selection</b></p> <p>Call up parameter setting. From the measuring mode: Press <b>menu</b> key to select menu. Select parameter setting using arrow keys, confirm with <b>enter</b>.</p> <p><b>Parameter setting</b></p> <p>Select Administrator level using arrow keys, confirm with <b>enter</b>. Enter passcode and confirm (Passcode as delivered: 1989).</p> <p>Select System control using arrow keys, confirm with <b>enter</b>. Then select Release of options using arrow keys, confirm with <b>enter</b>.</p> <p><b>Release of options</b></p> <p>Select the additional function to be released. Set option to "active". Enter the TAN at the prompt. (Note: The TAN only applies for the device with the corresponding serial number, see previous page.) The option is available after the TAN has been entered.</p>
		
		
		

# SW 700-001: KI recorder

Select menu: Parameter setting/FRONT M 700/KI recorder  
Additional function SW 700-101

The KI recorder follows the course of the process and releases a messages in the event of a deviation. It is called up from the measurement recorder: **meas**.

## Continuous processes

The measured signal is surrounded by a dynamically tracked, process-controlled tolerance band. Slight fluctuations are tolerated. If the measured value leaves the tolerance range, a message is released (Fig.).

The recording interval can be set from 10 s to 60 h.

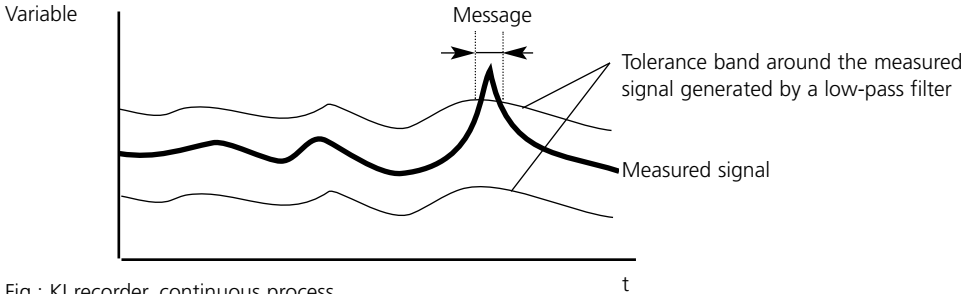

Fig.: KI recorder, continuous process

## Batch processes

The KI recorder provides an automatic self-learning function. This allows checking whether regularly recurring processes keep the preset tolerances. Deviations from the normal course of process (plus preset tolerances) generate a message (Fig.). Maximum process duration can be set from 1 to 60 h.

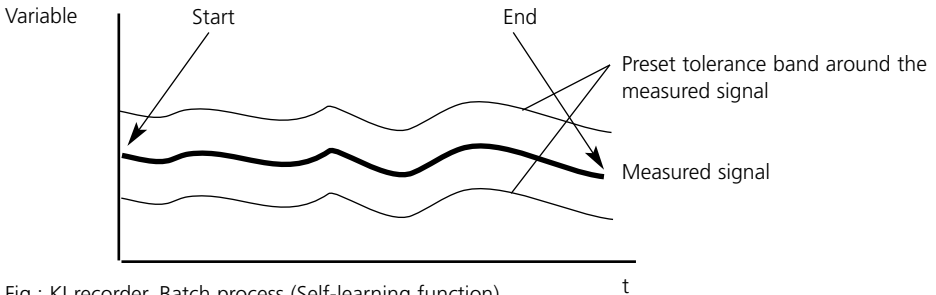
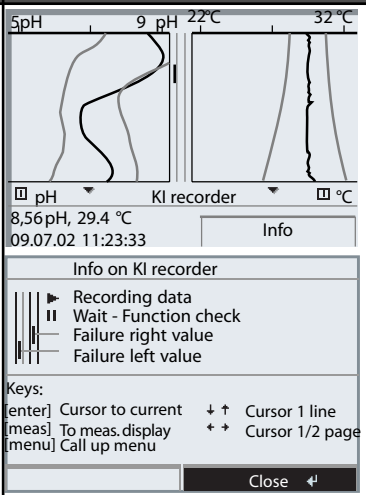
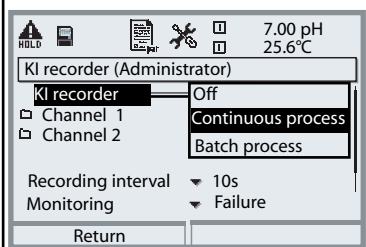
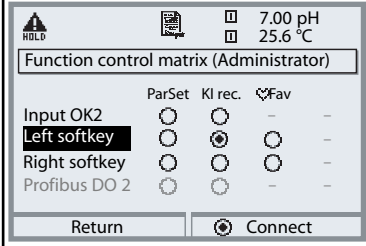

Fig.: KI recorder, Batch process (Self-learning function)

# SW 700-001: KI recorder

**Note:** Function check is active during parameter setting.

Menu	Display	Configure KI recorder
	  	<p><b>KI recorder</b> Called up directly from the measuring mode: Press <b>meas</b> key. For function description, press “Info” softkey</p> <p><b>“Info” softkey</b> Explains icons and capabilities of the KI recorder</p> <p><b>Configure KI recorder</b></p> <ul style="list-style-type: none"> <li>• Parameter setting FRONT M 700</li> <li>• Select KI recorder</li> <li>• Select the variables to be displayed as well as the start and end values</li> <li>• Set recording interval (10 s to 60 h) (per pixel)</li> <li>• Monitoring (Off/Failure/Maintenance request)</li> </ul> <p><b>Control KI recorder</b> Example: Configure softkey for KI recorder start/stop:</p> <ul style="list-style-type: none"> <li>• Select parameter setting, then:</li> <li>• System control</li> <li>• Function control matrix</li> <li>• Softkey: “KI rec. Start/Stop”</li> </ul>

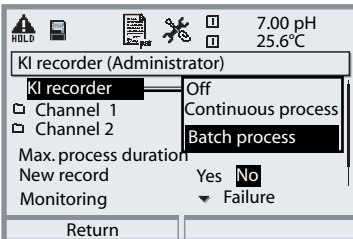

# SW 700-001: KI recorder

Menu	Display	KI recorder: Batch process
		<p><b>Configure KI recorder</b></p> <ul style="list-style-type: none"> <li>• Parameter setting: "Module FRONT"</li> <li>• Select KI recorder</li> <li>• Select the variables to be displayed as well as the start, end values, and deviation (%)</li> <li>• Set process duration (200 samples are recorded)</li> <li>• Select "New record Yes"</li> <li>• Monitoring (Off/Failure/Maintenance request)</li> </ul> <p><b>Call up KI recorder</b> From the measuring mode: Press <b>meas.</b></p>

## Parameters adjustable for batch operation

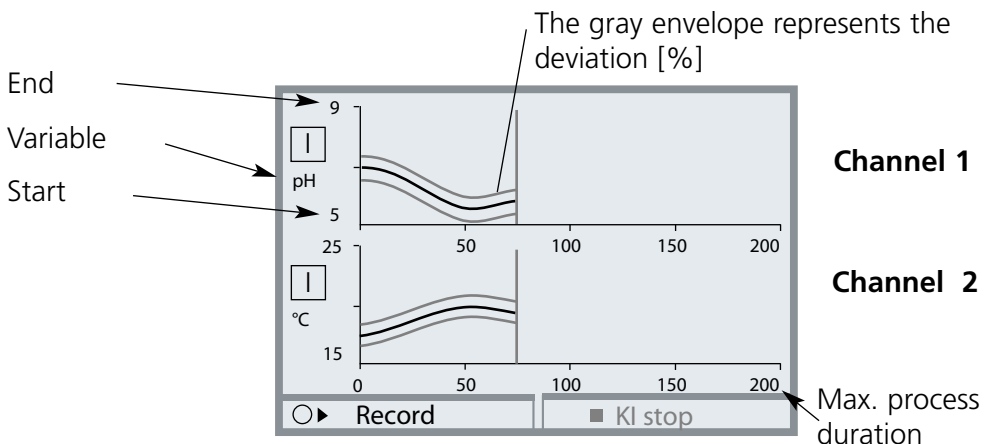

When the parameters are edited once more, the reference curve is automatically re-adjusted to start, end, and deviation.

When variable or process duration are changed, the curve will be deleted!

# SW 700-001: KI recorder

## Display

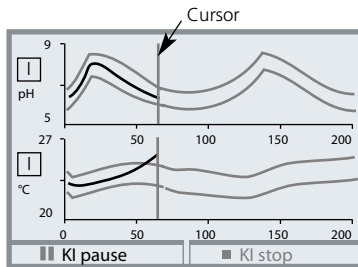
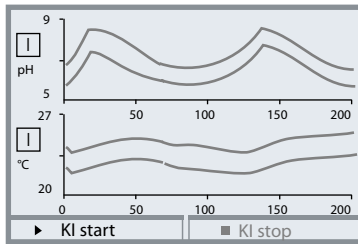
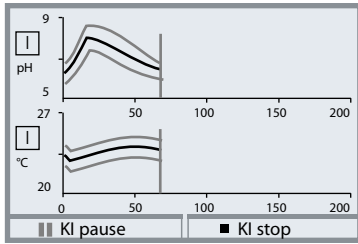

## KI recorder: Batch process

### Record reference curve

Start "Record" with left softkey. Reference value and envelope are displayed during the recording process. At the end of recording or after "KI stop" the KI recorder switches to control mode.

In control mode only the envelope is visible.

### Batch control

After a synchronous start the recorder monitors whether the currently measured values remain within the envelope. Every deviation can trigger a message.

KI pause: Stops the recorder.

KI stop: Terminates control.

Pressing "Continue" restarts a stopped recorder.

**Note:** During "function check" (e.g. during calibration) neither recording nor checking of a batch are interrupted. The last measured value continues to be used.

# SW 700-001: KI recorder

## Display

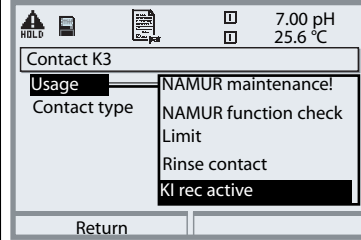
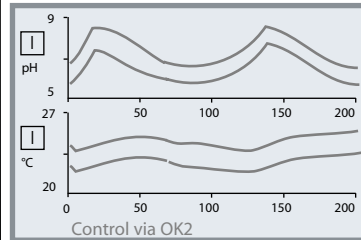
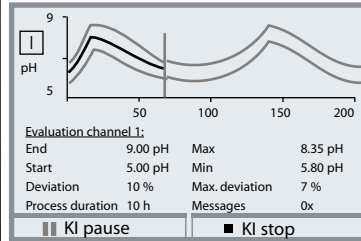

## KI recorder: Batch process

### Evaluation

Within the KI recorder function you can evaluate a reference curve directly on the device. To do so, use the arrow keys (Up/Down). The reference curves and the most important parameters are displayed one after the other.

### External control

The Start/Stop function can be remote-controlled via the OK2 input (BASE module) or via the PA 700 (X) PROFIBUS module. (To set the control element, call up: Parameter setting / System control / Function control matrix).

The softkeys will then be deactivated.

The K1, K2, and K3 contacts of the BASE module can be assigned to the "KI rec active" signal.



### • Save / load reference curves

Up to 5 batch reference curves can be stored on and retrieved from a SmartMedia card:

Parameter setting / System control / KI batch recording.

The reference curve, envelope, time response, and KI settings are stored.

### • Archiving of completed batch processes

Complete batch results can be archived on the SmartMedia card. All reference values and current batch data are stored in the archive.



# SW 700-002: Buffer set to be entered (pH)

Select menu: Parameter setting/System control/Buffer table  
 Individual buffer set (with 3 buffer solutions) for pH measurement

## Buffer table

You can enter an individual buffer set (with 3 buffer solutions).  
 To do so, you enter the nominal buffer values for the correct temperature (range 0 ... 95 °C, 5°C steps). Then this buffer set is available in addition to the permanently set standard buffer solutions in the "Calimatic buffer" menu (select "Table").

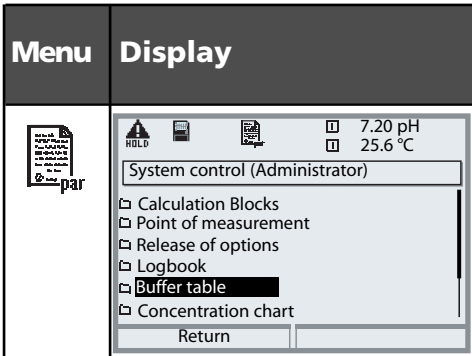
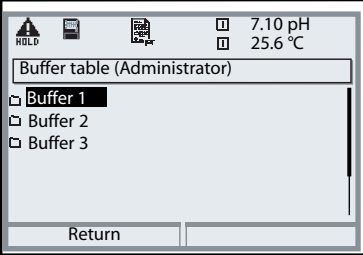
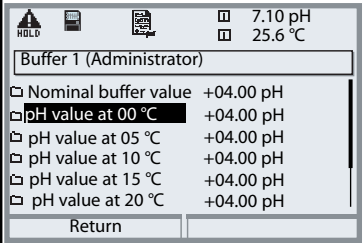
Menu	Display	Buffer table: Enter values
		<p><b>Enter buffer set</b></p> <ul style="list-style-type: none"> <li>• Call up parameter setting</li> <li>• System control</li> <li>• Select "Buffer table"</li> </ul>
		<ul style="list-style-type: none"> <li>• Select buffer to be entered</li> </ul>
		<ul style="list-style-type: none"> <li>• Enter nominal buffer value and all other values for the correct temperature (right/left arrow keys to select position, up/down arrow keys to edit number, confirm with <b>enter</b>.)</li> </ul>

**The special buffer set** is selected as follows:

Parameter setting/Module pH/Cal preset values/Calimatic buffer/Table.

# SW 700-004: ServiceScope (pH)

Select menu: Diagnostics/Module pH 2700/ServiceScope

## ServiceScope

ServiceScope monitors the pH input signal and checks whether it remains in the control range. An error message is generated if the input signal exceeds the failure limit.

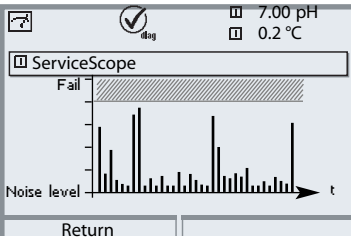
Menu	Display	ServiceScope
		<p><b>ServiceScope</b> (Diagnostics/Module pH 2700) Displays the noise levels over the time. Allows distinction of individual disturbances, periodic and broadband disturbances, which is helpful for troubleshooting. An error message is generated if the noise level exceeds the failure limit.</p>

# SW 700-005: Tolerance band recorder (pH)

Select menu: Diagnostics/Module pH/Tolerance band recorder

## Tolerance band recorder

### (Adjustment of tolerance band: see following page)

Tolerance band calibration prevents that slight calibration scatter of zero and slope immediately leads to a readjustment of the calibration data and thus to a shifting of the measured value. If the zero and slope values determined during calibration remain within their tolerance bands, the new data are not stored. If one of the calibration values lies outside the tolerance band, the new data are taken over.

Drift due to aging or calibration scatter can be identified at a glance, thus allowing to draw conclusions as to electrode life and the required calibration interval.

In the **Calibration record** you see whether the data have been stored or whether the old data can still be tolerated.

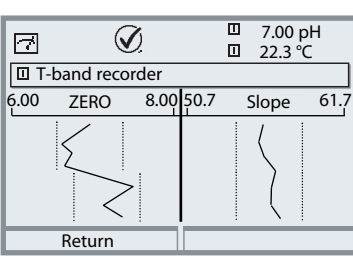
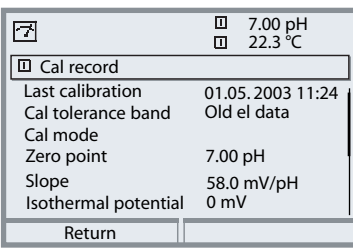
Menu	Display	Tolerance band recorder Cal record
 diag	 	<p><b>Tolerance band recorder</b> (Diagnostics/Module pH 2700)</p> <p>Records the tolerance ranges for zero and slope over the time. New calibration values are only accepted if the tolerance limits have been exceeded. Display can be graphical or as a listing.</p> <p><b>Cal record</b> (Diagnostics/Module pH 2700)</p> <p>In the Cal record you can see whether the data have been stored (New el data) or whether the old calibration data can still be tolerated (Old el data).</p>

# SW 700-005: Tolerance band recorder (pH)

Adjustment of tolerance band. Select menu:

Parameter setting/Module pH 2700/Cal preset values/Cal tolerance band

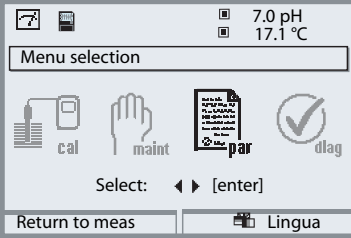
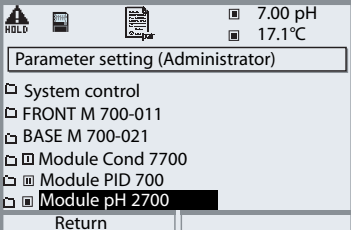
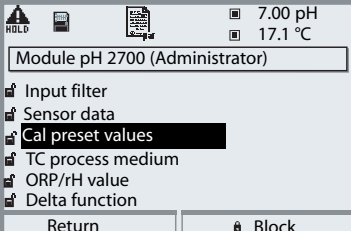
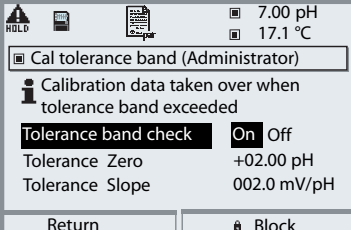
Menu	Display	Parameter setting
		<p><b>Menu selection</b></p> <p>From the measuring mode: Press <b>menu</b> key to select menu. Select parameter setting using arrow keys, confirm with <b>enter</b>. Passcode as delivered: 1989</p>
		<p><b>Parameter setting</b></p> <p>Select "Module pH 2700", confirm with <b>enter</b>.</p>
		<p><b>pH module</b></p> <p>Select "Cal preset values" using arrow keys. Confirm with <b>enter</b>. Then select "Cal tolerance band".</p>
		<p><b>Cal tolerance band</b></p> <p>Enter tolerance ranges for zero and slope (enter numbers using arrow keys, confirm with <b>enter</b>.)</p>



# SW 700-006: Current characteristic definable

Select menu: Parameter setting/BASE M 700 (Out)/Output current/Curve

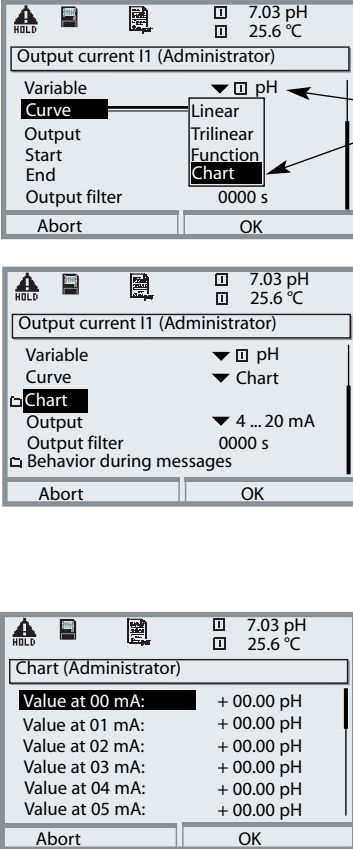
Menu	Display	Specify current characteristic
		<p><b>Chart characteristic</b></p> <p>Assign output current to measured value in 1 mA steps.</p> <p>Select menu: Parameter setting/ BASE M 700 (Out)/Output current</p> <p>First select process variable! Then curve: Chart</p> <p>The "Chart" menu is displayed.</p> <p>The entered values must be continuously rising or falling.</p> <p>On the following page, you find a listing to write down your adjustments.</p>

# Current curve values - Original for copy

Parameter setting/BASE M 700 (Out)/Output current/  
Curve: Chart, individual settings

Value at measured variable

- 00 mA ..... \_\_\_\_\_
- 01 mA ..... \_\_\_\_\_
- 02 mA ..... \_\_\_\_\_
- 03 mA ..... \_\_\_\_\_
- 04 mA ..... \_\_\_\_\_
- 05 mA ..... \_\_\_\_\_
- 06 mA ..... \_\_\_\_\_
- 07 mA ..... \_\_\_\_\_
- 08 mA ..... \_\_\_\_\_
- 09 mA ..... \_\_\_\_\_
- 10 mA ..... \_\_\_\_\_
- 11 mA ..... \_\_\_\_\_
- 12 mA ..... \_\_\_\_\_
- 13 mA ..... \_\_\_\_\_
- 14 mA ..... \_\_\_\_\_
- 15 mA ..... \_\_\_\_\_
- 16 mA ..... \_\_\_\_\_
- 17 mA ..... \_\_\_\_\_
- 18 mA ..... \_\_\_\_\_
- 19 mA ..... \_\_\_\_\_
- 20 mA ..... \_\_\_\_\_

# SW 700-008: TC ultrapure water (Cond)

Select menu:

Parameter setting/Module Cond 7700/TC process medium/Ultrapure water

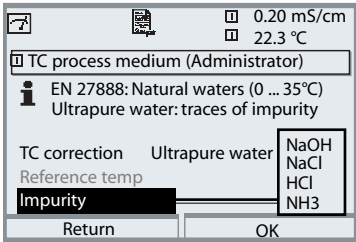
Menu	Display	TC process medium
		<p><b>Ultrapure water with traces of impurity</b></p> <ul style="list-style-type: none"> <li>• Parameter setting</li> <li>• Module Cond 7700</li> <li>• TC process medium</li> <li>• TC correction: Ultrapure water</li> </ul> <p>Select type of impurity:</p> <ul style="list-style-type: none"> <li>• <b>NaOH</b> Alkaline ultrapure water</li> <li>• <b>NaCl</b> Neutral ultrapure water, for conductivity measurement in water processing behind gravel bed filter</li> <li>• <b>HCl</b> Acidic ultrapure water, for conductivity measurement behind cation filter</li> <li>• <b>NH<sub>3</sub></b> Ammoniacal ultrapure water</li> </ul>

# SW 700-009: Concentration determination

---

Select menu: Parameter setting/System control/Module Cond/Concentration  
Default settings and selection range

## Concentration determination

The substance concentration in percent by weight (% by wt) is determined for  $\text{H}_2\text{SO}_4$ ,  $\text{HNO}_3$ ,  $\text{HCl}$ ,  $\text{NaOH}$ ,  $\text{NaCl}$  from the measured conductivity and temperature values.

## Conditions for concentration determination

Below you find tables with the concentration ranges of the preset substances. These tables show the conductivity of the substances versus substance concentration and process temperature:

- For calculation of concentration, the medium to be measured must be a purely binary mixture (e.g. water-hydrochloric acid). Presence of other dissolved substances (e.g. salts) leads to incorrect concentration values.
- In the region of small slopes (e.g. at the range limits) small conductivity changes can correspond to great concentration changes. This may lead to an unsteady display of the concentration value.
- As the concentration value is calculated from the measured conductivity and temperature values, accurate temperature measurement is very important. Therefore, you should make sure that sensor and process medium are in thermal equilibrium.

## Messages

You can define limits for warning and failure messages for the concentration value:

Select menu: Parameter setting/System control/Module Cond/Messages

# Parameter setting: Concentration curves

(Additional function SW 700-009) Default settings and selection range

**Note:** Function check active

Parameter	Default	Selection / Range
Concentration • Medium ("Yes" selected)	No H <sub>2</sub> SO <sub>4</sub> (0-30%)	Yes, No H <sub>2</sub> SO <sub>4</sub> (0-30 %), H <sub>2</sub> SO <sub>4</sub> (32-84 %), H <sub>2</sub> SO <sub>4</sub> (92-99 %), HNO <sub>3</sub> (0-30 %), HNO <sub>3</sub> (35-96 %), HCl (0-18 %), HCl (22-39 %) NaOH (0-14 %), NaOH (18-50 %), NaCl (0-26 %), Chart (additional function SW 700-009)
USP function • Reduced limit • Monitoring	Off 100 % Off	Off, On 10 % ... 100% Off, failure, maintenance request

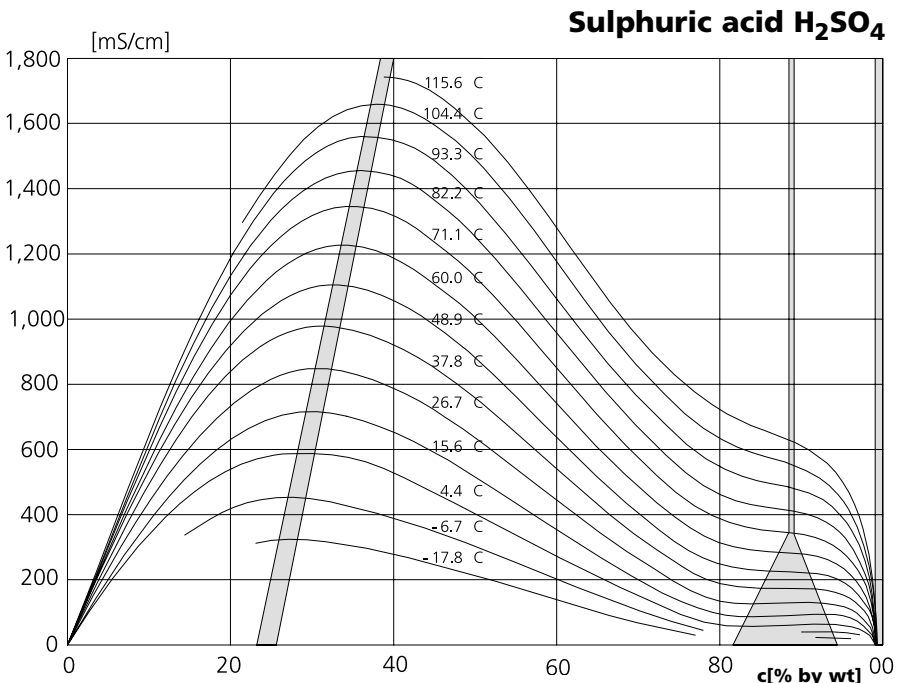

# Nitric acid HNO<sub>3</sub>

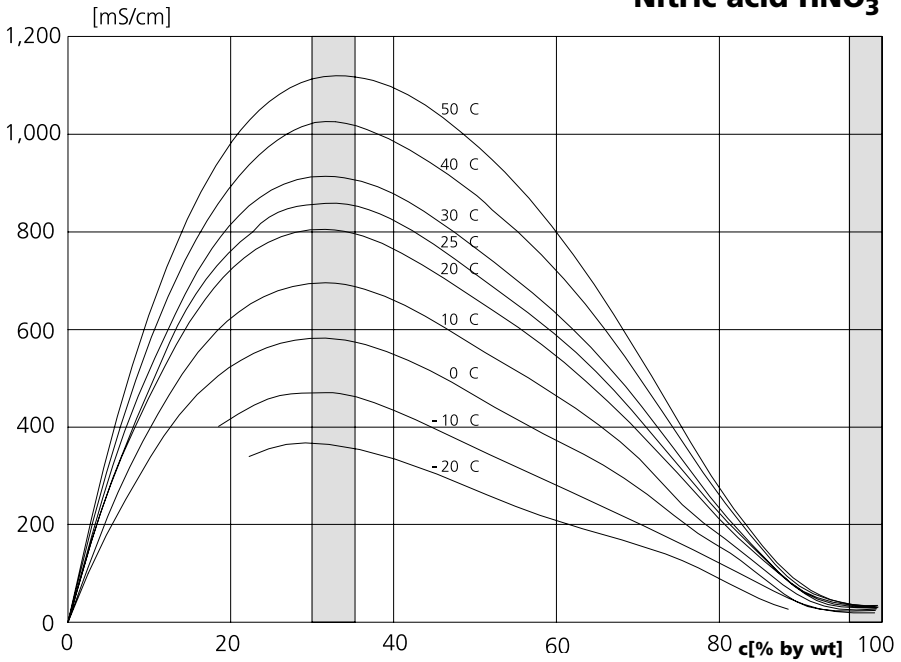

# Hydrochloric acid HCl

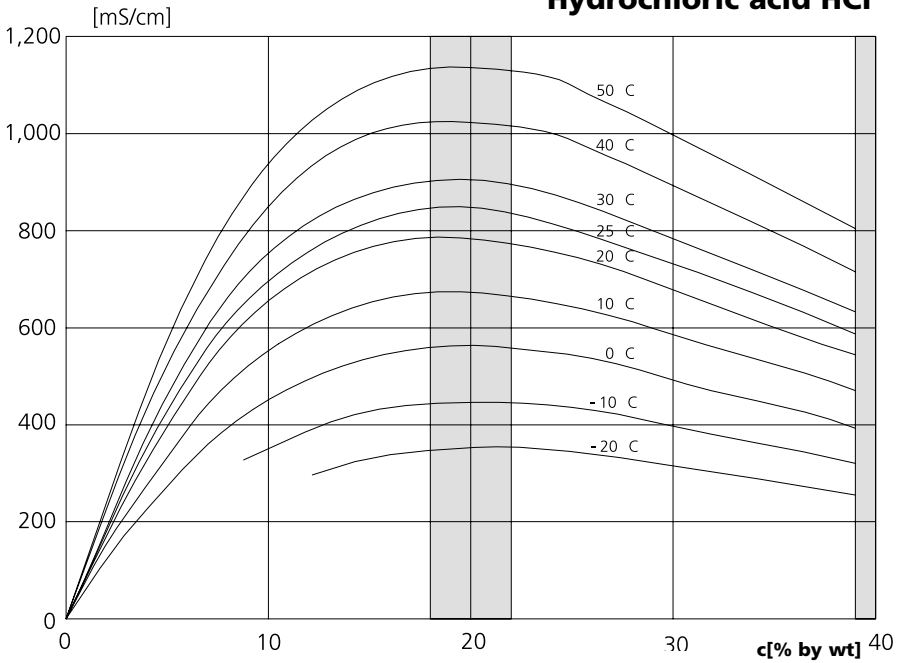

## Sodium hydroxide solution NaOH

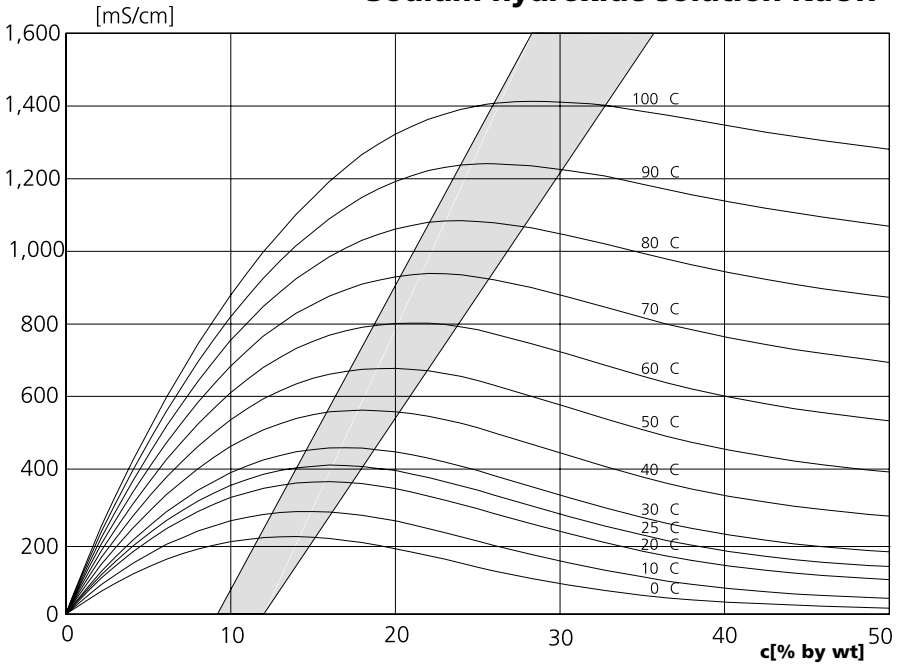

## Table salt solution NaCl

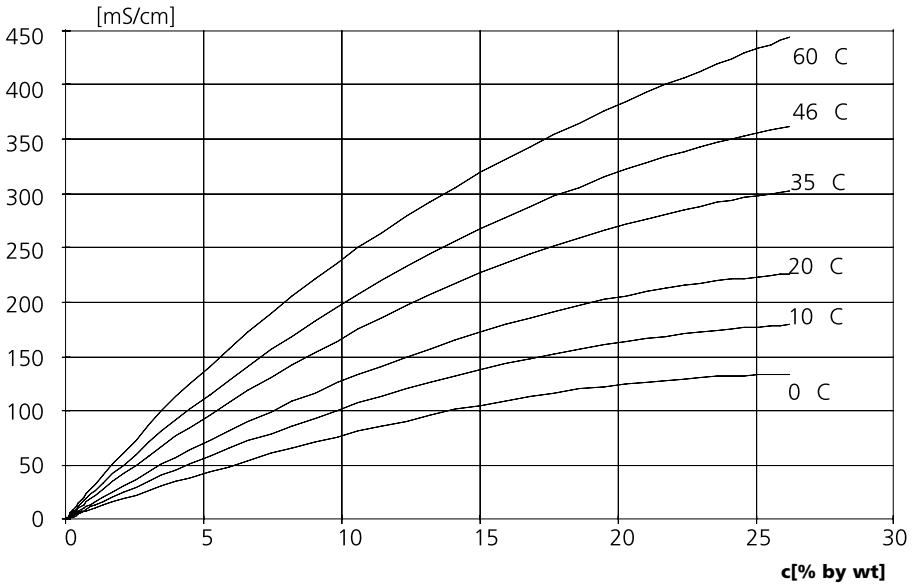

# SW 700-009: Concentration chart (Cond)

Select menu: Parameter setting/System control/Concentration chart  
 Specifying a concentration solution for conductivity measurement

## Concentration chart

To specify the customer-specific solution, 5 concentration values A-E are entered in a matrix together with 5 temperature values 1-5. To do so, first enter the 5 temperature values, then enter the respective conductivity values for each concentration A-E.

These solutions will then be available in addition to the permanently stored standard solutions (select "Chart").

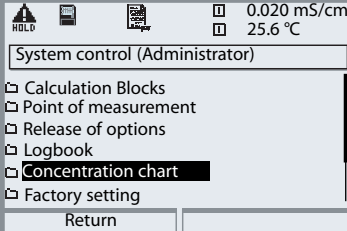
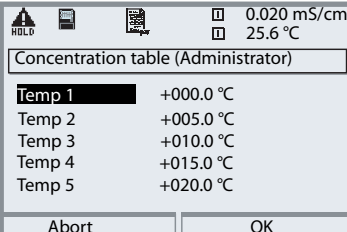
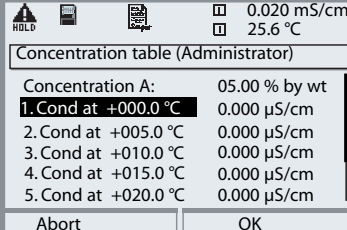
Menu	Display	Enter concentration chart
		<p><b>Enter values</b></p> <ul style="list-style-type: none"> <li>• Call up parameter setting</li> <li>• System control</li> <li>• Select "Concentration chart"</li> </ul>
		<p>Enter 5 temperature values (right/left arrow keys to select position, up/down arrow keys to edit number, confirm with <b>enter</b>.)</p>
		<p>Enter values for concentrations A-E for the respective temperatures. The table values must be continuous. Maxima/minima are not permitted. Incorrect entries are marked with x.</p>

**The concentration chart** is selected as follows:

Parameter setting/Module Cond/Cal preset values/Automatic/Chart.



The chart is built up as 5 x 5 matrix:

	<b>Conc. A</b>	<b>Conc. B</b>	<b>Conc. C</b>	<b>Conc. D</b>	<b>Conc. E</b>
<b>Temp 1</b>	A1	B1	C1	D1	E1
<b>Temp 2</b>	A2	B2	C2	D2	E2
<b>Temp 3</b>	A3	B3	C3	D3	E3
<b>Temp 4</b>	A4	B4	C4	D4	E4
<b>Temp 5</b>	A5	B5	C5	D5	E5

Conditions for the chart:

- The temperature values must be rising (Temp 1 is the lowest, Temp 5 the highest temperature).
- The concentration values must be rising (Conc. A is the lowest, Conc. E the highest concentration).
- The chart values A1 ... E1, A2 ... E2 etc. must all be rising within the chart or all falling. Points of inflection are not allowed!

The M 700 automatically checks the chart values. Incorrect entries are marked.

# SW 700-011: High CO<sub>2</sub> compensation

---

Application-specific additional function for breweries

This additional function simplifies parameter setting since all steps not required for measurement of beer are omitted. It simultaneously acts on all installed O<sub>2</sub> module (module software version 2.2 and higher).

## **Function principle:**

During the filling process it must be ensured that as little oxygen as possible is dissolved in the beer to extend its shelf life.

During oxygen trace measurement the sensor is operated with a very low polarization voltage (-500 mV). This results in low cross-sensitivity to CO<sub>2</sub>.

For a calibration in air, this polarization voltage is too low.

It must be set to -675 mV and afterwards be reduced again to -500 mV for measuring in the trace range.

A sufficiently long waiting time must be observed until the sensor has stabilized.

Opening and closing of valves causes pressure variations in the beer pipes which momentarily falsify the O<sub>2</sub> signal. Therefore the input signal must be attenuated correspondingly to suppress transient interferences.

These processes are automated by the additional function, i.e. all parameters required for the respective program step are set automatically. When the additional function has been activated, the parameter setting steps are displayed as follows:

Parameter	Default	Selection / Range
<b>Input filter</b> <ul style="list-style-type: none"> <li>Pulse suppression</li> </ul>	Weak	Off, Weak, Moderate, Strong, On (000 s ... 999 s)
<b>Sensor data</b> <ul style="list-style-type: none"> <li>Measure in</li> <li>Sensor type</li> <li>Temperature probe **</li> <li>Sensor **</li> <li>Reference electrode **</li> <li>Membrane correction</li> <li>Polarization voltage</li> <li>Sensocheck</li> </ul>	Liquids A Standard  NTC 22 k $\Omega$ Without guard Off 1.00 0500 / 0675 mV Off	A Standard, B Trace sensor (with guard) *, C Trace sensor (without guard), Others NTC 30 kOhm, NTC 22 kOhm With guard, Without guard Off, On 0.50 ... 2.00 For sensor type A, B, C: fixed Off, Failure, Maintenance request
<b>Cal preset values</b> <ul style="list-style-type: none"> <li>Cal saturation</li> <li>Cal concentration</li> <li>Calibration timer</li> </ul>	%AIR mg/l 0000 h	%Air $\mu$ g/l, mg/l, ppb, ppm xxxx h (entry)
<b>Pressure correction</b> <ul style="list-style-type: none"> <li>Pressure during meas</li> <li>Pressure during cal</li> </ul>	Auto Auto	Auto, Manual (default value 1013 mbars) Auto, Manual (default value 1013 mbars)
<b>Salt correction</b> <ul style="list-style-type: none"> <li>Input</li> </ul>	Salinity	Salinity, Chlorinity, Conductivity (00.00 g/kg or 0.000 $\mu$ S/cm, depending on selection)

\* Sensocheck not possible for trace sensor with guard, therefore disabled

\*\* Can only be set with "Sensor type Others" selected

# SW 700-012: ISFET for ISM module pH 2700i(X)



pH measurement with InPro 3300 ISFET sensor

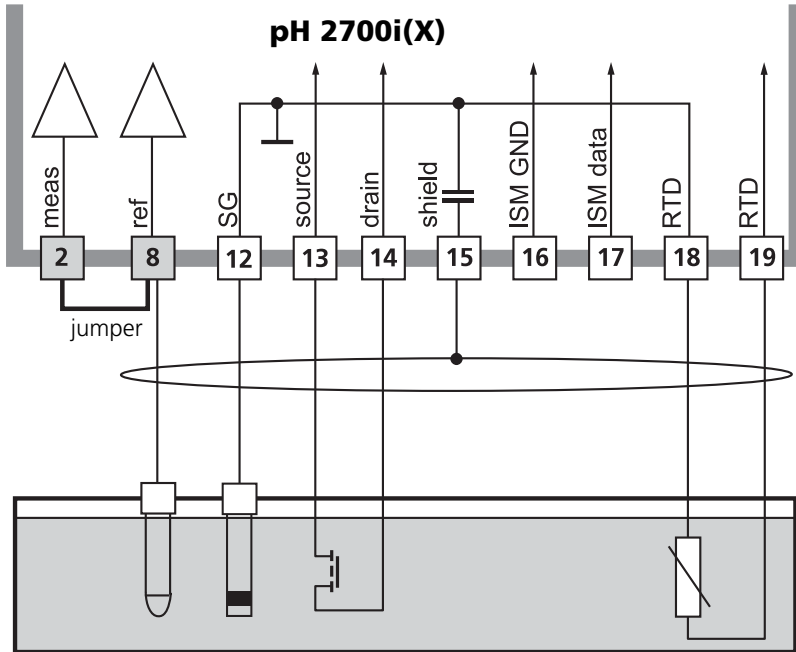

## Note:

Each time a new sensor is connected, an ISFET zero point adjustment must be performed.

After that, you should perform one of the following calibration methods:

- Calimatic: automatic calibration
- Manual: entry of buffer values
- Data entry: premeasured electrodes

**Menu Display Parameter settings: New**



**Modul pH 2700i (Administrator)**

7.00 pH  
20.1 °C

- Input filter
- Sensor data**
- Cal preset values
- TC process medium
- ORP/rH value
- Delta function

Return      Block

---

**Sensor data (Administrator)**

7.00 pH  
20.1 °C

**Sensor type** ISFET

Temperature detection (Pt100)

**Sensoface** On    Off

Sensor monitoring details

Abort      OK

---

**Sensor monitoring details (Administrator)**

7.00 pH  
20.1 °C

- Slope (Auto)
- Zero (Auto)
- Sensocheck ref el (Auto)
- Sensocheck glass el (Auto)
- Response time (Auto)
- ISFET leak current (Auto)**

Return

**Parameter setting/ module pH 2700i / Sensor data**  
 Sensor data are preset depending on the sensor type.  
 Gray display lines cannot be edited.

**Sensor data**  
 Option SW 700-012 allows the setting of "ISFET" as Sensor type.

**Sensor monitoring details**  
 Monitoring of ISFET leak current is available.



**Sensor monitor**

7.00 pH  
22.3 °C

- pH input 43 mV
- ORP input -109 mV
- RTD 1.100 kΩ
- Temperature 25.6 °C
- Impedance ref (25°C) 322.8 kΩ
- ISFET characteristic 0,81 mA/V

Return

---

**Sensor network diagramm PH**

7.00pH  
24.1°C

- 1 - Slope
- 2 - Zero point
- 3 - Ref mpedance
- 4 - ISFET Leak current**
- 5 - Response time
- 6 - Calibration timer
- 7 - Sensor wear

Return

**Diagnostics: New**

**Sensor monitor**  
 ISFET characteristic.

**Sensor network diagramm pH**  
 New: ISFET leak current.

# Inserting the SmartMedia card

To release an additional function via TAN, see Pg 6, Release of options

## Inserting and replacing the SmartMedia card

The SmartMedia card may be inserted or replaced with the power supply switched on. Protect against electrostatic discharge! When closing the device, make sure that the sealing is properly seated and clean.

### Warning!

**Do not touch the terminal compartment, there may be dangerous contact voltages!**



### 1. To open the analyzer

- Loosen the 4 front screws
- Open the M 700 FRONT at its right side (pivot hinge inside at the left)
- The slit for inserting the SmartMedia card is located at the inner side of the M 700 FRONT module

### 2. To insert the SmartMedia card

- Remove SmartMedia card from its package without touching the contact surface
- Insert card in the slit at the inner side of the M 700 FRONT module



**Inserting the SmartMedia card:**  
*The label must be facing you.*

### 3. To remove the SmartMedia card

- Please call up the Maintenance menu to avoid data loss.
- "Close memory card" to terminate software access to the SmartMedia card. Now the card can be taken out.

# SmartMedia card: Usage

Use as memory card in combination with additional functions.  
 Additional functions must be ordered separately (release via TAN).

## A SmartMedia card is provided with the following additional functions:

- Software update (SW 700-106, see Pg 43)
- Additional function SW 700-1xx (description Pg 34 et seq.)

## Using commercially available SmartMedia cards

Commercially available SmartMedia cards can be used as additional memory card.

The following types of cards are supported: 8 MB, 16 MB, 32 MB, 64 MB, 128 MB. Externally produced files, such as from a digital camera, are tolerated. Long file names can be read. The M 700 generates file names in the 8.3 format (8 characters file name, 3 characters program-specific file name extension).

## Formatting a commercial SmartMedia card

Some devices (e.g. digital cameras, scanners) cause a formatting of the SmartMedia card which does not correspond to the SSFDC specification or the SmartMedia Interface Library (SMIL). The manufacturer therefore recommends to format a commercial SmartMedia card as M 700 memory card prior to first use.

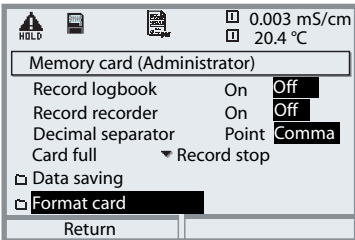
Menu	Display	Format SmartMedia card
		<p><b>Formatting</b></p> <ul style="list-style-type: none"> <li>• Insert SmartMedia card</li> <li>• Open menu selection</li> <li>• Parameter setting, Admin. level</li> <li>• Enter passcode</li> <li>• System control: Memory card (The "Memory card" function is only available with the SmartMedia Card inserted!)</li> <li>• Format card</li> </ul>

# Loading /saving configuration

---

System control/Memory card/Copy configuration.

Additional functions must be ordered separately (release via TAN).

## Saving / loading the complete device configuration

System control/Memory card/Copy configuration.

“Save” configuration means that the complete device configuration (except the passcodes) is written on the memory card.

“Load” configuration means that the complete device configuration is read from the memory card and programmed in the M 700.

BACKUP file generated on SmartMedia card: \BACKUP\BACKUP01.PAR

## Copy configuration from one M 700 to further M 700 units (Copying parameter sets for similarly equipped M 700)

Prerequisite:

The devices must have the same hardware. The module equipment must be absolutely identical – the same modules in the same slots!

Options:

All required options must be enabled on the “master device”, this is not required for the “slave devices”.

It is the parameters of the options that are transferred, not the option itself. When an option will be enabled on a “slave device” at a later point in time, the parameters of this option will be preset corresponding to the “master device”.

- 1 Write device configuration of configured device on SmartMedia card:  
Parameter setting/System control/Copy configuration/Save.
- 2 Call up Maintenance menu. Select “Close memory card”.
- 3 Remove SmartMedia card.

Now you can transfer the device configuration to further identically equipped devices.

- 4 To do so, insert the SmartMedia card containing the configuration in the next device to be configured. Select  
Parameter setting/System control/Copy configuration/Load.
- 5 Call up Maintenance menu. Select “Close memory card”.
- 6 Remove SmartMedia card.



# SmartMedia card: Format card

Parameter setting/System control/Format card

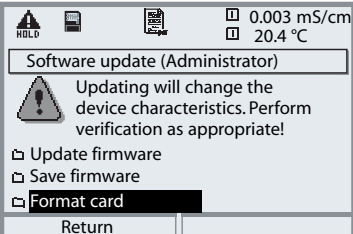
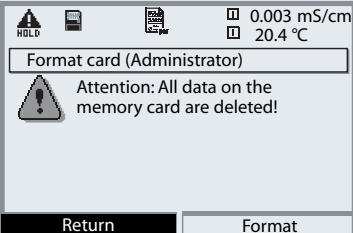
Menu	Display	Format card (Generate memory card)
	 <p>0.003 mS/cm 20.4 °C</p> <p>Software update (Administrator)</p> <p>Updating will change the device characteristics. Perform verification as appropriate!</p> <ul style="list-style-type: none"> <li>Update firmware</li> <li>Save firmware</li> <li>Format card</li> </ul> <p>Return</p>	<p><b>Format card</b></p> <ul style="list-style-type: none"> <li>• Insert SmartMedia card (Pg 30)</li> <li>• Open menu selection</li> <li>• Parameter setting, Admin. level</li> <li>• Enter passcode</li> <li>• System control: Format card</li> </ul>
	 <p>0.003 mS/cm 20.4 °C</p> <p>Format card (Administrator)</p> <p>Attention: All data on the memory card are deleted!</p> <p>Return      Format</p>	<p><b>Caution!</b></p> <p>Formatting an update card generates a memory card. Refer to “SmartMedia card”, Pg 34. This process is irreversible! Double warning messages protect against faulty operation.</p>

**Note:**

The SmartMedia card must always be formatted in the M 700. Correct functioning of a SmartMedia card with different formatting cannot be guaranteed.

**File structure of a memory card (example):**

Folder	Typ. file name	Remark
BACKUP LOGBOOK	BACKUP01.PAR L_YYMM00.TXT	Parameter set (Backup) Logbook file, YY=year, MM=month
PARASET RECORDER	SET 1 R_YYMMDD.TXT	Parameter set Recorder entry, YY=year, MM=month, DD=day

# SmartMedia card: Memory card

Parameter setting/System control/Memory card

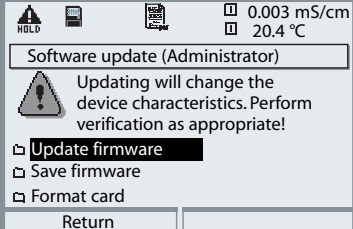
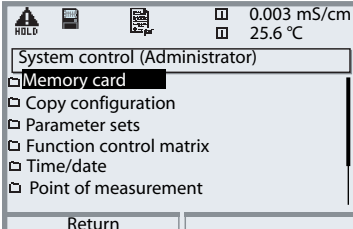
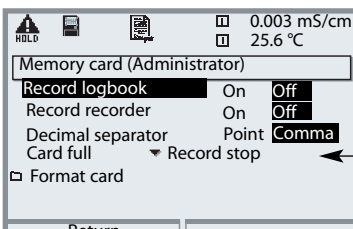
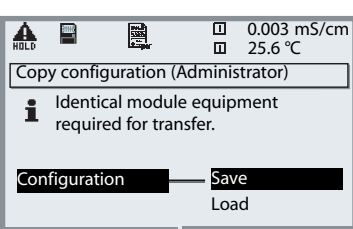
Menu	Display	Using the memory card
	 <p>Software update (Administrator)</p> <p>Updating will change the device characteristics. Perform verification as appropriate!</p> <ul style="list-style-type: none"> <li>Update firmware</li> <li>Save firmware</li> <li>Format card</li> </ul> <p>Return</p>	<h3>Using the memory card</h3> <ul style="list-style-type: none"> <li>Insert SmartMedia card (Pg 30)</li> <li>Open menu selection</li> <li>Parameter setting, Admin. level</li> <li>Enter passcode.</li> <li>System control: Memory card</li> </ul>
	 <p>System control (Administrator)</p> <ul style="list-style-type: none"> <li>Memory card</li> <li>Copy configuration</li> <li>Parameter sets</li> <li>Function control matrix</li> <li>Time/date</li> <li>Point of measurement</li> </ul> <p>Return</p>	<p>With SmartMedia card inserted, the display shown on the left appears (The “Memory card” line is displayed only if there really is a memory card in the slot).</p> <ul style="list-style-type: none"> <li>Select “Memory card”, confirm with <b>enter</b>.</li> </ul> <p>The menu is self-explanatory.</p>
	 <p>Memory card (Administrator)</p> <ul style="list-style-type: none"> <li>Record logbook On Off</li> <li>Record recorder On Off</li> <li>Decimal separator Point Comma</li> <li>Card full Record stop</li> <li>Format card</li> </ul> <p>Return</p>	<h3>Behavior when the memory card is full:</h3> <p>Continuous recording (as with a flight recorder) or Stop (card replacement).</p>
	 <p>Copy configuration (Administrator)</p> <p>Identical module equipment required for transfer.</p> <ul style="list-style-type: none"> <li>Configuration Save Load</li> </ul> <p>Return Save</p>	<h3>Copy configuration</h3> <ul style="list-style-type: none"> <li>Save: saves all data on the memory card</li> <li>Load: Overwrites all device data with the data from the memory card</li> </ul> <p><b>Caution! “Close” memory card before removing it (Maintenance menu)</b></p>

# SW 700-102: Loadable parameter sets

Parameter setting/System control/Parameter sets

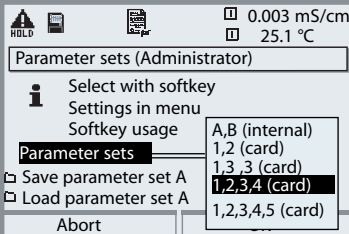
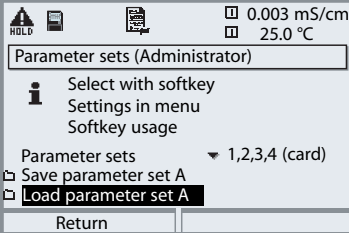
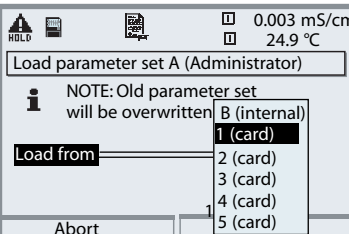
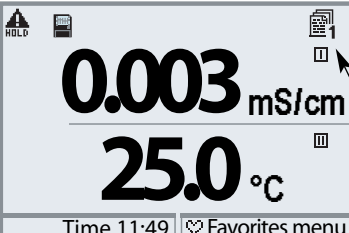
Menu	Display	Load parameter set from SmartMedia card
	   	<h3>Loading a parameter set from SmartMedia card</h3> <ul style="list-style-type: none"> <li>• Call up parameter setting</li> <li>• System control</li> <li>• Call up "Parameter sets" (Fig)</li> </ul> <p>The M 700 provides 2 complete parameter sets (A, B). 5 parameter sets can be stored on the SmartMedia card. One of those can be saved as parameter set A to the M 700:</p> <div data-bbox="560 885 1041 1212" data-label="Diagram"> </div> <ul style="list-style-type: none"> <li>• Select parameter set to be loaded</li> <li>Activated parameter set is displayed in measuring mode.</li> </ul> <p>Note: Remote switching between A and B is possible via the OK2 input.</p>

# SW 700-102: Loadable parameter sets

Parameter setting/System control/Parameter sets

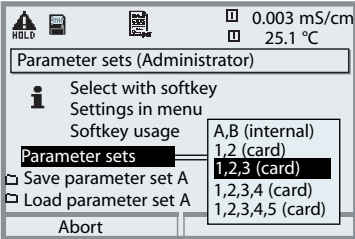
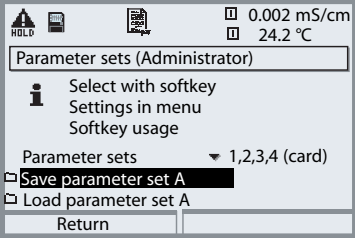
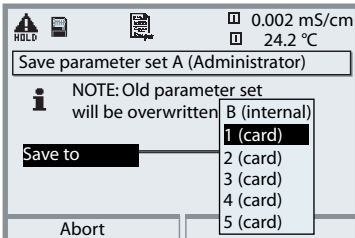
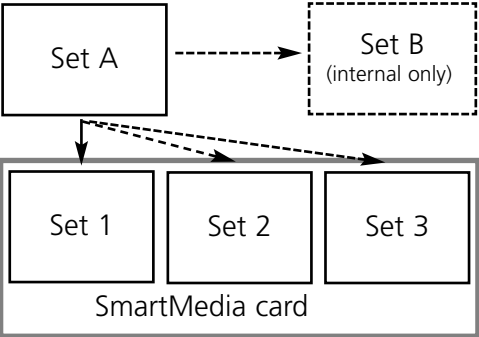
Menu	Display	Save parameter set on SmartMedia card
	  	<h3>To save a parameter set on SmartMedia card</h3> <ul style="list-style-type: none"> <li>• Call up parameter setting</li> <li>• System control</li> <li>• Call up "Parameter sets" (Fig)</li> </ul> <p>The M 700 provides 2 complete parameter sets (A, B). Up to 5 parameter sets can be loaded to the SmartMedia card. To do so, a parameter set (1, 2, 3, 4, or 5) of the SmartMedia card is overwritten by parameter set A of the M 700.</p> <ul style="list-style-type: none"> <li>• Select parameter set on SmartMedia card</li> </ul> 

# SW 700-103: Measurement recorder

Select menu: Parameter setting/FRONT M 700/Measurement display

The last 200 data records are stored in the M 700 and are represented graphically – like on a recorder. All further data can be stored on the SmartMedia card and be evaluated by a computer.

2 process variables are represented. You can configure:

- The process variable to be displayed
- Start and end value for the variable to be recorded
- Time base (recording interval, selectable from 10 s to 10 h)

In addition, the time axis can be stretched by factor 10 using the “Zoom function”. In the event of quick changes, the zoom function is automatically activated. It always starts several pixels before the event. This allows detailed investigation of signal instabilities.

With “Min/Max displays” activated, the respectively measured peak values (gray) are shown in addition to the measured value (average).

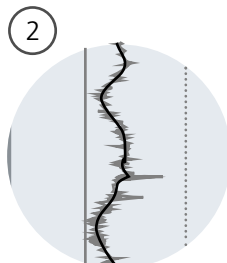
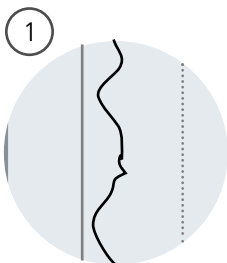
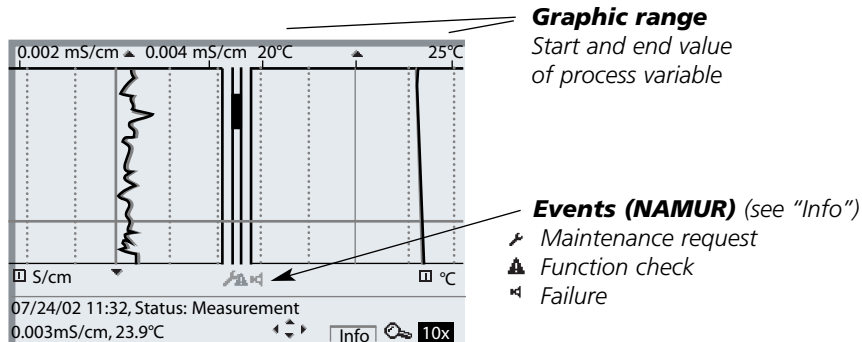

## Min/Max display

The minimum and maximum values within the recording interval are shown as a gray line next to the (averaged) measured value.

Fig. 1: Min/Max off

Fig. 2: Min/Max display

# SW 700-103: Measurement recorder

Select menu: Parameter setting/FRONT M 700/Measurement display

## Additional function SW 700-103: Measurement recorder

The measurement recorder saves all entries in a file. The last 200 entries can be displayed on the M 700. A new file is generated for each day. The date is encoded in the file name.

Example for a file generated on SmartMedia card:

**\REORDERIR\_YYMMDD.TXT** Recorder data of YYMMDD  
(YY = year, MM = month, DD = day)

The data is recorded as ASCII file with the extension .TXT.

The individual columns are separated by tabs. This makes the file readable with word processing or spreadsheet programs (e.g. Microsoft Excel). Each time the memory card is inserted in the slot, a "Device Info" consisting of Model number, BASE serial number, and tag number. Thus, a memory card can also be used to collect the measurement recorder data of several devices.

Example:

M 700 - Measurement recorder									
Time stamp	CH Left		CH Right		M-req	Fct.	Fail	Slow	
<< M 700 - Serial 002004 [DSE KL_007] >>									
21.10.02 00:09:15	1015	mbar	2.8	°C	0	0	0	0	
21.10.02 00:19:15	1015	mbar	2.9	°C	0	0	0	0	
21.10.02 00:29:15	1015	mbar	2.8	°C	0	0	H	0	
21.10.02 00:39:15	1015	mbar	2.9	°C	0	0	0	0	
21.10.02 00:49:15	1015	mbar	2.9	°C	0	H	0	0	
21.10.02 00:59:15	1015	mbar	3.0	°C	0	0	0	0	

# **SW 700-103: Measurement recorder**

---

Select menu: Parameter setting/FRONT M 700/Measurement display

Meaning of the entries in the recorder file:

Time stamp	Time stamp of recorder entry
CH Left	Left channel of recorder with measured value and unit
CH Right	Right channel of recorder with measured value and unit
M-req.	NAMUR signal* "Maintenance request"
Fct.	NAMUR signal* "Function check"
Fail	NAMUR signal* "Failure"
Slow	Zoom function active (Slow motion)

\* Definition:

NAMUR = German committee for measurement and control standards in the chemical industry

# SW 700-104: Extended logbook

---

Parameter setting/System control/Logbook

## Additional function SW 700-104: Extended logbook

The extended logbook saves all entries in a file. The last 50 entries can be displayed on the M 700. A new file is generated for each month. The date is encoded in the file name.

Example for a file generated on SmartMedia card:

**LOGBOOKL\_YYMM00.TXT** Recorder data of YYMM  
(YY = year, MM = month)

The data is recorded as ASCII file with the extension .TXT.

The individual columns are separated by tabs. This makes the file readable with word processing or spreadsheet programs (e.g. Microsoft Excel). Each time the memory card is inserted in the slot, a "Device Info" consisting of Model number, BASE serial number, and tag number is written. Thus, a memory card can also be used to collect the logbook data of several devices.

Example:

```
M 700 - Logbook
Time Stamp          Status Message

<< M 700 - Serial 0002004 [DSE KL_001] >>
21.11.02  19:08:43      Power supply Off
22.11.02  06:02:01      Power supply On
22.11.02  06:09:27      Diagnostics active
22.11.02  06:09:36      Measurement active
23.11.02  16:45:07 (x)   Fail current I2 > 20 mA
23.11.02  18:43:11      Parameter setting active
23.11.02  18:47:38      Measurement active
23.11.02  18:47:38 ( )   Fail current I2 > 20 mA
:
:
```

*Time stamp:* Time stamp of logbook entry  
*Status* (x) - Message activated  
( ) - Message deactivated  
*Message* Message text (in selected operator language)



# SW 700-106: Software update

---

For a software update (additional function SW700-106), the manufacturer supplies a specially formatted SmartMedia card. The M 700 replaces its own firmware (operating program) by the new version (“Update”).

## Caution!

During a software update the M 700 is not operable!  
After a software update you should check the configuration.



This icon indicates that a SmartMedia card is inserted in the slot. The card allows storing of current device software on the card as well as loading of new software into the M 700.



1. Save the firmware currently installed in your M 700 (Pg 42).
2. Load the software update as described on Pg 43.

## Note:

A memory card can be generated by formatting an update card (irreversible!).  
See Page 31.

# SmartMedia card: Save firmware

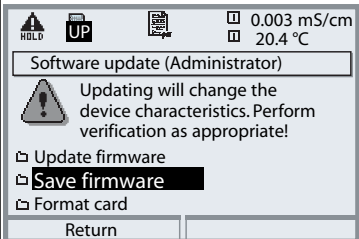
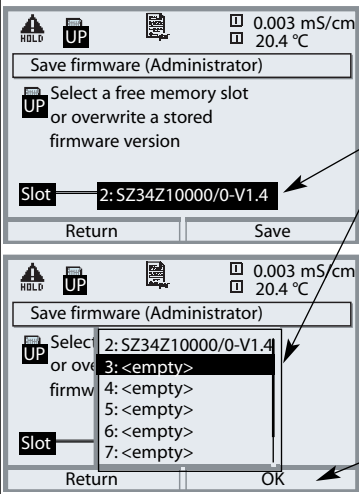
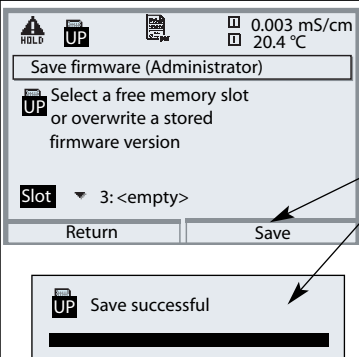
Parameter setting/System control/Software update/Save firmware

Menu	Display	Save firmware on software update card
	 <p>Software update (Administrator)</p> <p>Updating will change the device characteristics. Perform verification as appropriate!</p> <ul style="list-style-type: none"> <li>Update firmware</li> <li><b>Save firmware</b></li> <li>Format card</li> </ul> <p>Return</p>	<h3>Save firmware</h3> <ul style="list-style-type: none"> <li>• Insert SmartMedia card</li> <li>• Open menu selection</li> <li>• Parameter setting, Admin. level</li> <li>• Enter passcode</li> <li>• System control: Software update</li> </ul>
	 <p>Save firmware (Administrator)</p> <p>Select a free memory slot or overwrite a stored firmware version</p> <p>Slot 2: SZ34Z10000/0-V1.4</p> <p>Return Save</p>	<p>Select a free memory slot on the card:</p> <ul style="list-style-type: none"> <li>• Select slot with key <b>▶</b></li> <li>• Select free slot with arrow key.</li> </ul>
	 <p>Save firmware (Administrator)</p> <p>Select or overwrite firmware</p> <p>Slot 2: SZ34Z10000/0-V1.4</p> <ul style="list-style-type: none"> <li>3: &lt;empty&gt;</li> <li>4: &lt;empty&gt;</li> <li>5: &lt;empty&gt;</li> <li>6: &lt;empty&gt;</li> <li>7: &lt;empty&gt;</li> </ul> <p>Return OK</p>	<ul style="list-style-type: none"> <li>• Confirm slot with "OK".</li> </ul>
	 <p>Save successful</p>	<p>Start with "Save" softkey.          Confirm finish message (with "OK" or <b>enter</b>).          Remove the SmartMedia card.          Close the front door.</p>

# SW 700-106: Software update

Parameter setting/System control/Software update/Load firmware

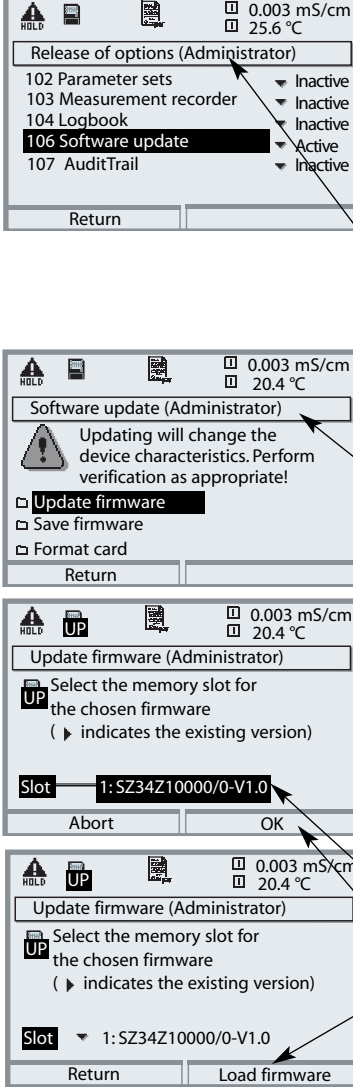
Menu	Display	Software update ("Load firmware")
		<p><b>Software update</b></p> <ul style="list-style-type: none"> <li>• Insert SmartMedia card (Pg 30)</li> <li>• Open menu selection</li> <li>• Parameter setting, Admin. level</li> <li>• Enter passcode</li> <li>• Select System control</li> </ul> <p><b>1: Select Release of options</b> (Software update SW 700-106) Set option to "active". Enter the TAN at the prompt. The option is available after the TAN has been entered.</p> <p><b>2: Select Software update</b> Check whether your unit really requires a software update! To read the current software version, select:</p> <ul style="list-style-type: none"> <li>• Diagnostics</li> <li>• Device description</li> <li>• FRONT M 700</li> </ul> <p><b>Perform update:</b></p> <ul style="list-style-type: none"> <li>• Parameter setting</li> <li>• System control</li> <li>• Software update</li> <li>• Select slot</li> <li>• Confirm slot with "OK".</li> <li>• Press "Load firmware" softkey to start software update.</li> </ul>



# AuditTrail and signature

---

Electronic data recording and protection according to FDA 21 CFR Part 11  
Additional function SW 700-107

**Provided by: TAN and AuditTrail card**

## Contents

AuditTrail.....	46
Signature.....	47
Activating the AuditTrail .....	48
Signature entry.....	49
AuditTrail: Parameter setting.....	50
AuditTrail: User management .....	51
AuditTrail: Recording .....	52
AuditTrail log.....	53

# AuditTrail

---

Function description

## **Electronic data recording and protection according to FDA 21 CFR Part 11**

Pharmaceutical applications not only require a hygienic design, but also the protection and complete recording of data (FDA regulation: 21 CFR Part 11). The M 700 with stainless steel enclosure and SmartMedia card meets these demands. The FDA regulation basically consists of two parts: "Audit Trail" and "Electronic Signature". Both parts interact directly: For every change of parameters, the device records what has been changed and who has changed it.

Functions like calibration (adjustment) often may only be performed after written approval! This approval is given by an electronic signature.

### **AuditTrail card**

The AuditTrail card is a specially prepared SmartMedia card. The M 700 records the AuditTrail log on an "AuditTrail card" only. Readability from PC is not affected.

#### **Note:**

Only specially coded SmartMedia cards supplied from Mettler Toledo can be used as AuditTrail cards.

As delivered, the AuditTrail card includes a PC program which makes the recorded AuditTrail data readable. When log coding has been activated, it also allows decoding of the data. The program supports the data export to other programs, e.g. Microsoft Excel.

# Signature

---

Function description

## Signature

A signature consists of two entries, the user name and the corresponding passcode. For each change at the device (calibration/adjustment, parameter setting, maintenance, if required also diagnostics), the M 700 records in the "AuditTrail Log" and in addition in the logbook who has performed the change. For that purpose, access authorizations are introduced.

## Access authorization

Every access authorization consists of a signature:

- User name and
- Passcode.

The administrator and the user enter the access data in the user management menu. The administrator enters the user name (short name) and the user adds his/her personal passcode.

Each time he/she calls up a protected menu, the user must enter his/her name and passcode. The M 700 only gives access to the function if the access codes are valid. The recordings (AuditTrail log, logbook) on the AuditTrail card include the user names so that all actions can be clearly traced back.

## Coded storage

The entries in the AuditTrail log can be coded using an algorithm and protected with checksums so that a special evaluation program can prove the authenticity of the data records on a PC.

# Activating the AuditTrail

Select menu: Parameter setting/System control/Release of options

**Note:** The TAN for releasing an additional function is only valid for the device with the corresponding serial number

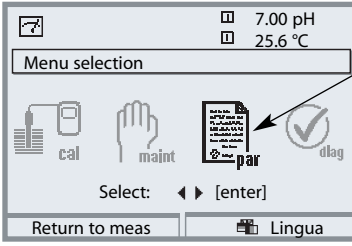
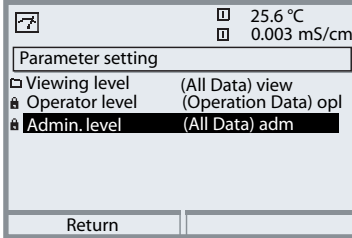
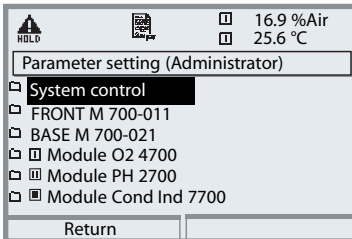
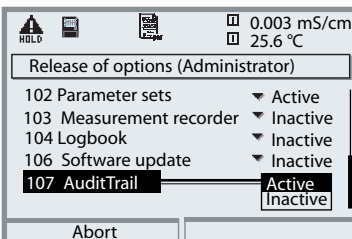
Menu	Display	Activate additional function
	   	<p><b>Menu selection</b></p> <p>Call up parameter setting. From the measuring mode: Press <b>menu</b> key to select menu. Select parameter setting using arrow keys, confirm with <b>enter</b>.</p> <p><b>Parameter setting</b></p> <p>Select Administrator level using arrow keys, confirm with <b>enter</b>. Enter passcode and confirm (Passcode as delivered: 1989).</p> <p>Select System control using arrow keys, confirm with <b>enter</b>. Then select Release of options using arrow keys, confirm with <b>enter</b>.</p> <p><b>Release of options</b></p> <p>Select the additional function to be released. Set option to "active". Enter the TAN at the prompt. (Note: The TAN is only valid for the device with the corresponding serial number, see previous page.) The option is available after the TAN has been entered.</p>



# Signature entry

---

(User name, passcode)

## Signature entry (user name, passcode) to open a menu

To protect the data against unauthorized query or modification, access data must be entered before a main menu from the menu selection is opened. Two-stage security is provided by input of user name and passcode.

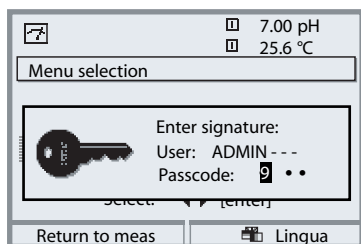

The passcode is not visible. It is only displayed as 4 dots. The administrator can delete each user's passcode (with entry in AuditTrail log). The user is identified by his/her access data.

After entry of the valid signature all menus are available with the defined user rights. Only in measuring mode, the rights will be erased again. This allows accessing several menus without having to enter the access data each time.

When an invalid combination of user name and passcode is entered, access is denied with the text "Wrong passcode". The entry "Wrong passcode" with the entered (wrong) user ID is recorded in the AuditTrail log.

## Default setting for signature

Signature

User: ADMIN

Passcode: 1989

# AuditTrail: Parameter setting

---

Adapt function: Parameter setting/System control/AuditTrail

## Parameter setting

In the System Control menu the Administrator can adjust the AuditTrail system to the requirements of his company. For example, he/she can select the protection against unauthorized query and the coding of the data in the AuditTrail log.

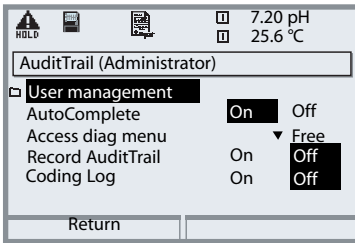

- “AutoComplete” is an input assistance for the user name as known from some Windows programs.
- Access to the Diagnostics menu can be “free” or require input of a “Signature” according to the access authorization granted the User Management menu.
- For the recording on SmartMedia card, a coding can be activated so that the data cannot be read or queried without corresponding programs.

## User management

An administrator and up to 5 users can be entered in the M 700. Each user has a user name (max. 8 characters) and a passcode (4 characters). Each user can be granted access and usage rights for each main menu level. The combination of user name and passcode is the user’s “Electronic Signature”. Every logged modification is signed and can be clearly traced back. Different access rights for each menu can be defined for each user.

# AuditTrail: User management

Create, edit, erase user data

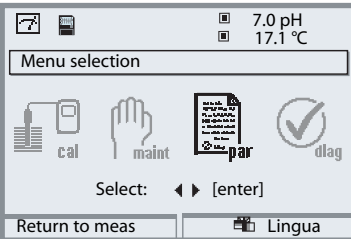
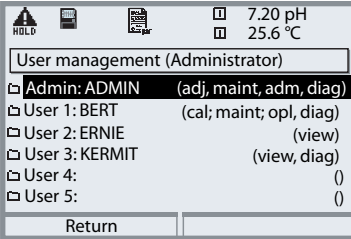
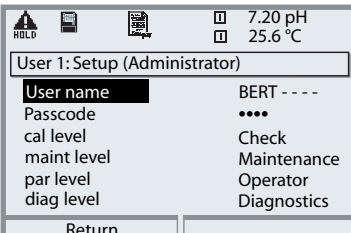
Menu	Display	AuditTrail: User management
	 <p>Menu selection</p> <p>Select: ◀ ▶ [enter]</p> <p>Return to meas    Lingua</p>  <p>User management (Administrator)</p> <ul style="list-style-type: none"> <li>Admin: ADMIN (adj, maint, adm, diag)</li> <li>User 1: BERT (cal; maint; opl, diag)</li> <li>User 2: ERNIE (view)</li> <li>User 3: KERMIT (view, diag)</li> <li>User 4: 0</li> <li>User 5: 0</li> </ul> <p>Return</p>  <p>User 1: Setup (Administrator)</p> <p>User name      BERT - - - -</p> <p>Passcode        ••••</p> <p>cal level        Check</p> <p>maint level     Maintenance</p> <p>par level        Operator</p> <p>diag level      Diagnostics</p> <p>Return</p>	<h2>Menu selection</h2> <p>From the measuring mode:          Press <b>menu</b> key to select menu.          Select parameter setting using arrow keys, confirm with <b>enter</b>.          Signature for first access:          User: ADMIN          Passcode as delivered: 1989</p> <p>Select:          Parameter setting/System control/          AuditTrail/User management.          Access data and rights can be created for the administrator and up to 5 users.          The administrator has always administrator rights for parameter setting.          The user enters his/her passcode after being asked to do so by the administrator. The passcode is only displayed as a series of 4 dots.</p>

## Access rights for the main menu levels:

- Calibration: [ No access | Check | Adjustment ]
- Maintenance: [ No access | Maintenance ]
- Parameter setting: [ No access | Viewing | Operator | Administrator ]
- Diagnostics: [ No access | Diagnostics ]

# Record AuditTrail

---

## Functions

### **AutoComplete**

The "AutoComplete" function facilitates the input of the user name. You only have to enter as many letters as the M 700 requires to identify the name.

This function can be switched off in the AuditTrail menu because the automatic display of the user name reduces system security, which then might not be sufficient for FDA documentation.

### **Access to diag menu**

To protect all data against unauthorized query, it is also possible to protect the diagnostics level with a passcode (this will also affect the Favorites menu). As delivered, access to the diagnostics level is free.

### **Record AuditTrail**

The AuditTrail log is an additional - protected if required - recording of all data on the AuditTrail card (SmartMedia card). The log is recorded in the currently selected language.

The data can be coded (to protect against unauthorized query) and secured with a checksum (to prove the authenticity of the data). The coding can be switched on or off in the AuditTrail menu of the Administrator level.

A four-digit line numbering (0000 ... 9999 P 0000 ..., cyclic) ensures uninterrupted recording. The AuditTrail log cannot be deleted by the M 700. A buffer storage is provided to store the recorded data while the AuditTrail card is being replaced, for example. An error message "Fail AuditTrail card" is generated when the buffer is full. The oldest entries in the buffer will be recorded. They are then missing in the log (the corresponding line numbers will be missing).

When an empty AuditTrail card is inserted, the buffer storage and the current entries are transferred to the empty card.

# Record AuditTrail

---

## Parameters

The AuditTrail log cannot be queried by the M 700. It can only be evaluated using the suitable PC program. According to FDA 21 CFR Part 11 the user must ensure the transport of the data from the M 700 to evaluation and further processing or archiving. Furthermore, the user must ensure that the log data cannot be deleted from the memory card. The PC evaluation program is able to decode the data and verify the security parameters and thus to prove the authenticity of the data on the card. It allows printing the encoded data and exporting them to other PC applications.

## Logbook

The logbook is provided in addition. In AuditTrail systems it runs simultaneously with the audit trail log in contrast to which it can be queried provided that the diagnostics menu is accessible. The administrator is permitted to delete the logbook data since all security-relevant data are stored in the AuditTrail log.

## Recordings in the AuditTrail log

### Caution!

**Data loss (even total destruction) if the card is not closed before it is pulled out. (Maintenance menu, "Close card")**

The following entries and messages are recorded:

- Measuring point, device description, module equipment and serial numbers
- Menu system log-ins
- Movements within menus (menu headlines)
- Modified parameters at the press of **enter**
- Calibration record at the end of a calibration or adjustment  
incl. user name, sensor type and serial number
- Messages such as failure and maintenance request

## AuditTrail log

**METTLER TOLEDO**

Measurement point	BIGBLUE vessel
FRONT M 700-011	0006123
BASE M 700-021	0006458
pH 2700	0007221
O2 4700	0006045

6653	07/01/04	10:43:02	Login: Admin (ADMIN)	OK
6654	07.01.04	10:43:02	Login: > Parameter setting (Administrator)	OK
6655	07.01.04	10:43:02	Login: > [1] Module pH 2700 (Administrator)	OK
6656	07.01.04	10:43:02	Login: < Parameter setting (Administrator)	OK
6657	07.01.04	10:43:02	Login: < Menu selection	OK
6658	07.01.04	10:43:02	Login: Admin (ADMIN)	OK
6659	07.01.04	10:43:02	Login: > Calibration	OK
6660	07.01.04	10:43:02	Login: > [1] Module pH 2700	OK
6661	07.01.04	10:43:02	Login: > [1] Calimatic	OK
6662	07.01.04	10:43:02	Login: Warn Identical Buf	OK
6663	07.01.04	10:43:02	Login: > [1] Calimatic	OK
6664	07.01.04	10:43:02	Login: [1] Cal record	OK
6665			Last calibration: 20.11.03 10:44	OK
6666			User: ADMIN	OK
6667			Sensor type: El 204	OK
6668			Serial number: 0815	OK
6669			Cal mode: Calimatic	OK
6670			Zero: 7.02 pH	OK
6671			Slope: 58.0 mV/pH	OK
6672			Impedance glass (25°C): 825.9 MOhm	OK
6673			Impedance ref (25°C): 119.4 kOhm	OK
6674	0		1st nominal buffer value: 7.00 pH	OK
6675			Desired value: 6.97 pH	OK
6676			Actual value: 7.10 pH	OK
6677			Delta value: 0.13 pH	OK
6678	0		Electrode potential: 1 mV	OK
6679	0		Cal temperature: 25.0 °C	OK
6680	0		Response time: 19 s	OK
6681	07.01.04	10:43:02	Login: < [1] Module pH 2700	OK
6682	07.01.04	10:43:02	Login: < Calibration	OK

Typical AuditTrail log  
(gray: logged measurement deviations)



# Additional functions

---

## Provided by: device-specific TAN

To release: Parameter setting / System control / Release of options

Passcode Administrator level 1989 (new: .....)

---

	52121198	KI recorder .....	7
	52121199	Buffer sets to be entered (pH) .....	13
	52121200	Adaptive cal timer (pH).....	13
	52121201	ServiceScope (pH).....	14
	52121202	Tolerance band recorder (pH).....	15
	52121203	Current characteristic definable .....	17
	52121204	TC ultrapure water (Cond) .....	19
	52121205	Concentration determination (Cond).....	20
	52121250	High CO <sub>2</sub> compensation (O <sub>2</sub> ) .....	26
	52121274	ISFET for ISM module pH 2700i(X).....	28

# Additional functions

---

## Provided by: device-specific TAN

	Inserting the SmartMedia card .....	30	
	Removing the SmartMedia card.....	30	
	Usage .....	31	
	52121192	5 loadable parameter sets .....	35
	52121193	Measurement recorder .....	37
	52121194	Extended logbook .....	40
	52121195	Software update .....	43
	52121241	AuditTrail (FDA 21 CFR Part 11).....	45