

**METTLER TOLEDO
Terminal IND465**

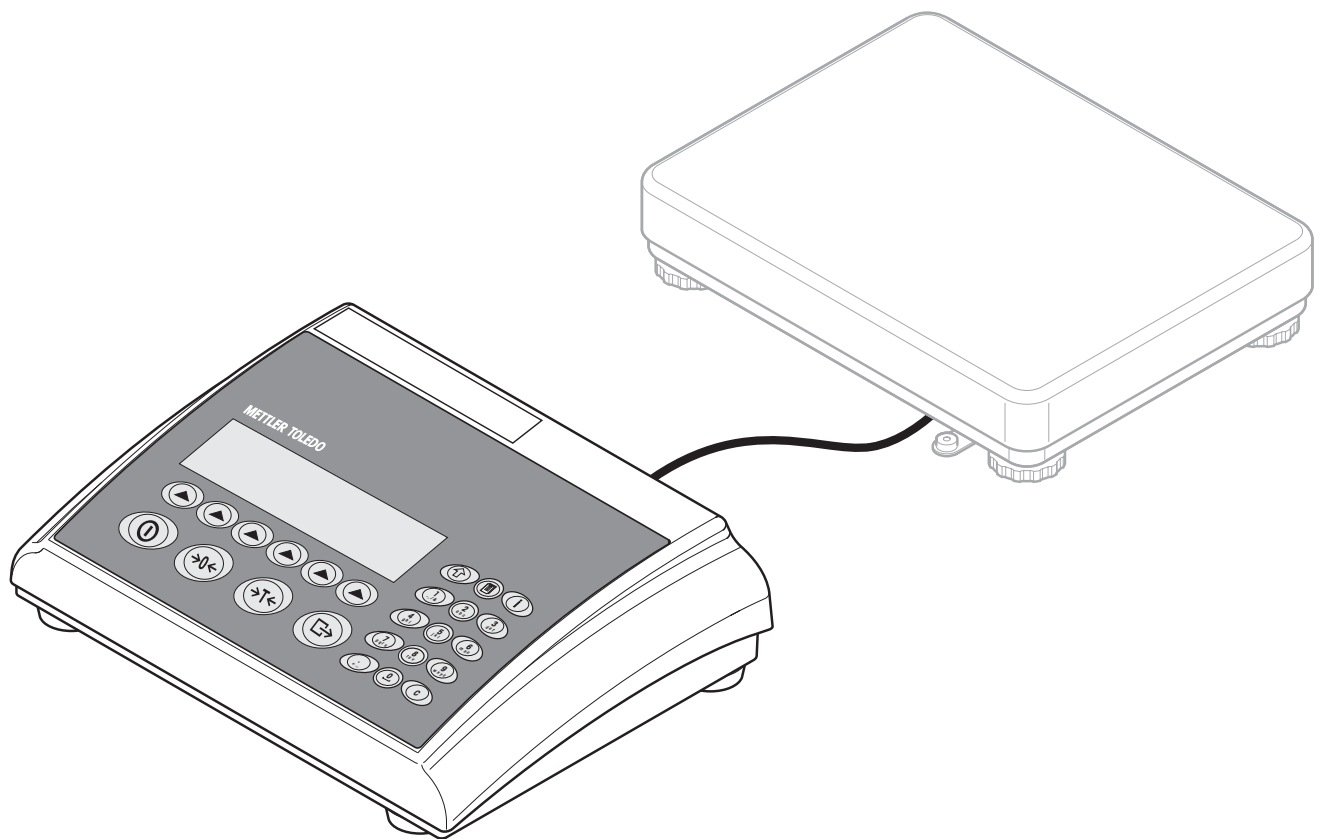



Congratulations on choosing the quality and precision of METTLER TOLEDO. Proper use according to this Operating Manual and regular calibration and maintenance by our factory-trained service team ensures dependable and accurate operation, protecting your investment. Contact us about a ServiceXXL agreement tailored to your needs and budget.

We invite you to register your product at www.mt.com/productregistration so we can contact you about enhancements, updates and important notifications concerning your product.

Overview

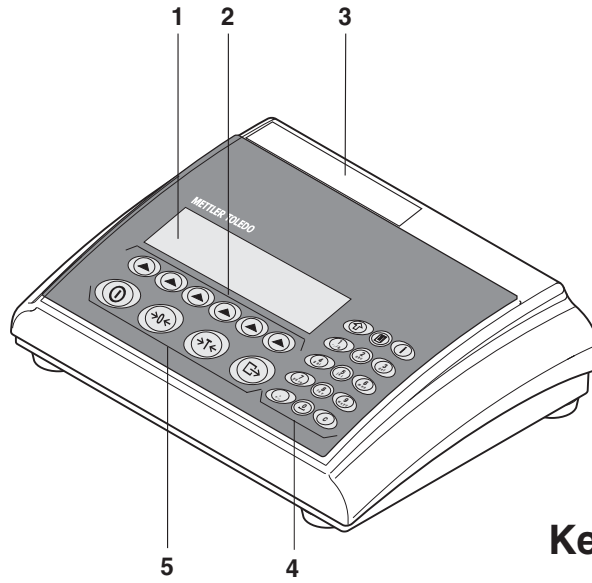

Rear view

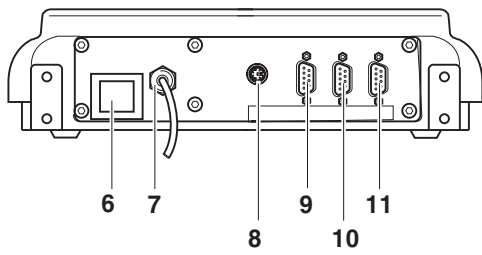

Keypad

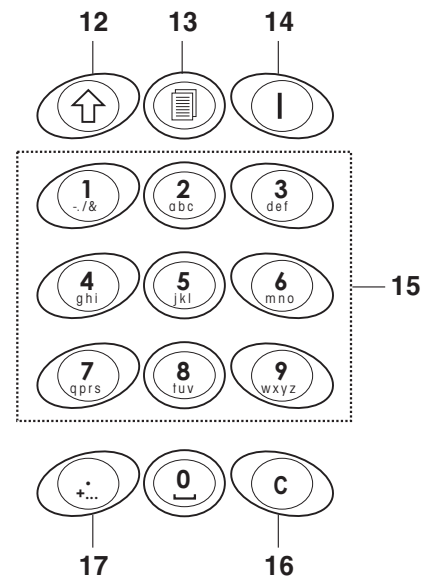

Display

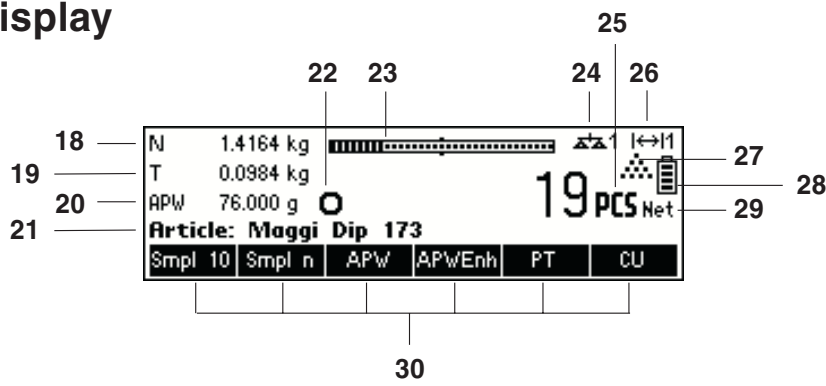

Overview

- 1** Display
- 2** Command softkeys
- 3** Type plate
- 4** Numeric/alphanumeric keys
- 5** Function keys

Rear view

- 6** Power supply cable
- 7** Connector for weighing platform

Standard Interfaces:

- 8** PS2 connector for keyboard and/or BCR (Barcode reader)
- 9** COM3 (RS232C interface)
- 10** COM2 (RS232C interface)
- 11** COM1 (RS232C interface)

Optional interfaces:

- 9** Depending on configuration: RS232C interface or Analog Base
- 10** Depending on configuration: Ethernet, USB, Digital I/O or RS232 interface
- 11** Depending on configuration: RS232C or RS422/485 interface

Keypad

- 12** Shift key
- 13** Database key
- 14** Info key
- 15** Numeric/alphanumeric keys
- 16** Clear key
- 17** Special characters key

Display

- 18** Info line 1
- 19** Info line 2
- 20** Info line 3
- 21** Info line 4
- 22** Stability detector
- 23** Weighing range bar graph
- 24** Active scale (in 2-scale systems)
- 25** Unit
- 26** Weighing range display (no function)
- 27** Piece counting symbol
- 28** Battery discharge status
- 29** Net weight indicator
- 30** Softkeys 1...6

1	Setting up the terminal	9
1.1	Safety and environment	9
1.2	Selecting a location and leveling the weighing platform	11
1.3	Connecting to power supply	11
1.4	Battery operation	12
2	Basic functions.....	13
2.1	Switching on and off and zeroing	13
2.2	Setting date and time	13
2.3	Language settings	14
2.4	Simple weighing.....	15
2.5	Weighing with tare.....	16
	<i>2.5.1 Taring by placing the weighing container on the platter</i>	<i>16</i>
	<i>2.5.2 Entering the tare weight numerically (pre-tare).....</i>	<i>17</i>
	<i>2.5.3 Determining the gross and net weights</i>	<i>17</i>
2.6	Recording weighing results	18
3	Enhanced functions.....	19
3.1	General Info	19
3.2	Database.....	20
	<i>3.2.1 Database editing functions</i>	<i>20</i>
	<i>3.2.2 Defining an article</i>	<i>21</i>
	<i>3.2.3 Erasing of individual article attributes</i>	<i>24</i>
	<i>3.2.4 Save As Article function</i>	<i>24</i>
3.3	Gross Weight Alarm	25
3.4	SmartManager.....	25
3.5	FlashLoader	25
4	Application.....	26
4.1	Counting pieces into a container	26
	<i>4.1.1 Determining the reference by placing pieces on the scale.....</i>	<i>26</i>
	<i>4.1.2 Entering the reference when the piece weight is known</i>	<i>27</i>
4.2	Counting out pieces out of a container	28
	<i>4.2.1 Determine reference by removing pieces</i>	<i>28</i>
4.3	Reference optimization	29
4.4	Minimum sample weight	29
4.5	Using the info key	30

6

4.6	Piece counting with 2-scale systems	31
4.7	Accumulation	32
4.8	Accumulation to target.....	34
4.9	Filling	35
4.10	Checkweighing (+/-).....	35
4.11	Custom Unit	36
4.12	High resolution / Average weighing.....	37
4.13	Alibi memory.....	38

5 Vision setup 39

5.1	Overview and operation.....	39
5.2	Calling up the menu and entering the password.....	40
5.3	Menu overview	41
5.3.1	<i>Scale</i>	41
5.3.2	<i>Application</i>	42
5.3.3	<i>Terminal</i>	44
5.3.4	<i>Communications</i>	45
5.3.5	<i>Diagnostics</i>	48
5.4	Scale settings (SCALE)	48
5.4.1	<i>Adjust/calibrate (SCALE → Calibration)</i>	49
5.4.2	<i>Display resolution and weighing unit (SCALE → Display)</i>	49
5.4.3	<i>Tare settings (SCALE → Tare)</i>	50
5.4.4	<i>Automatic zero point correction (SCALE → Zero)</i>	50
5.4.5	<i>Automatic save of tare and zero values (SCALE → Restart)</i>	50
5.4.6	<i>Adaptation to environmental conditions and weighing mode (SCALE → Filter)</i>	51
5.4.7	<i>Minimum weight (SCALE → Min Weigh)</i>	51
5.4.8	<i>Resetting scale to factory default settings (SCALE → Reset)</i>	52
5.5	Application settings (APPLICATION)	52
5.5.1	<i>Settings for piece counting (APPLICATION → Counting)</i>	52
5.5.2	<i>Settings for database (APPLICATION → Database)</i>	55
5.5.3	<i>Identification (APPLICATION → Identification)</i>	57
5.5.4	<i>Settings for accumulation (APPLICATION → Accumulation)</i>	57
5.5.5	<i>Settings for filling/checkweighing (APPLICATION → Filling/Checkweighing)</i>	58
5.5.6	<i>Settings for the (optional) alibi memory -> APPLICATION-> alibi memory</i>	59
5.5.7	<i>Settings for softkey configuration (APPLICATION → Softkey Configuration)</i>	59
5.5.8	<i>Settings for Info/Help (APPLICATION → Info/Help)</i>	61
5.5.9	<i>Settings for reset (APPLICATION → Reset)</i>	63
5.6	Terminal settings for device (TERMINAL → Device)	63
5.6.1	<i>Language settings (TERMINAL → Device → Language)</i>	63

5.6.2	<i>Sleep function (TERMINAL → Device → Sleep)</i>	64
5.6.3	<i>Adjusting the contrast of the display (TERMINAL → Device → Contrast)</i>	64
5.6.4	<i>Invert (TERMINAL → Device → Invert)</i>	64
5.6.5	<i>Changing the size of weight display (TERMINAL → Device → Weight display)</i>	65
5.6.6	<i>Adjusting the date and time (TERMINAL → Device → Date Time)</i>	65
5.6.7	<i>Activating the beep (TERMINAL → Device → Beep)</i>	65
5.7	Define supervisor password (TERMINAL → Access).....	66
5.8	Reset terminal settings to factory settings (TERMINAL → Reset).....	66
5.9	Communication settings (COMMUNICATIONS).....	66
5.9.1	<i>Mode (COMMUNICATIONS → Mode)</i>	67
5.9.2	<i>Printer (COMMUNICATIONS → Printer) only in Printer Mode or Auto Print</i>	68
5.9.3	<i>Parameters (COMMUNICATIONS → Parameters)</i>	69
5.9.4	<i>Define I/O (COMMUNICATIONS → Def. I/O – only if Mode is Digital I/O)</i>	70
5.9.5	<i>Reset communications (COMMUNICATIONS → Comx → Reset Com)</i>	70
5.9.6	<i>Option Settings (COMMUNICATIONS → Option)</i>	71
5.9.7	<i>PS2 Settings (COMMUNICATIONS → PS2)</i>	73
5.9.8	<i>User-defined printer (COMMUNICATIONS → User-defined printer)</i>	74
	<i>Example: Configuration of a printer</i>	75
5.10	Diagnostic settings (DIAGNOSTICS).....	76
5.10.1	<i>Scale (DIAGNOSTICS → Test Scale)</i>	77
5.10.2	<i>Keyboard (DIAGNOSTICS → Keyboard Test)</i>	77
5.10.3	<i>Display (DIAGNOSTICS → Display Test)</i>	78
5.10.4	<i>Serial Number 1 (DIAGNOSTICS → SNR1)</i>	78
5.10.5	<i>Serial Number 2 (DIAGNOSTICS → SNR2)</i>	78
5.10.6	<i>List 1 (DIAGNOSTICS → List 1)</i>	78
5.10.7	<i>List 2 (DIAGNOSTICS → List 2)</i>	79
5.10.8	<i>List memory (DIAGNOSTICS → List Memory)</i>	79
5.10.9	<i>Working time (DIAGNOSTICS → Working time)</i>	79
5.10.10	<i>Reset All (DIAGNOSTICS → Reset All)</i>	79
6	Other important information	80
6.1	Error messages.....	80
6.2	Sample reports.....	82
6.3	Variable and control sequences in entering a "Free Text".....	83
6.4	Cleaning instructions.....	85
7	Technical data, interfaces and accessories	86
7.1	General data and delivered items.....	86
7.2	Dimensions and weight.....	87

8

7.3	Interface technical data	88
7.4	Accessories	89
7.5	Interface commands	90
7.5.1	<i>Preconditions</i>	90
7.5.2	<i>SICS Command set</i>	90
7.6	TOLEDO Continuous Mode	91
7.6.1	TOLEDO Continuous commands	91
7.6.2	<i>Output format in TOLEDO Continuous Mode</i>	91

8 Appendix 93

8.1	Safety checks	93
8.2	Table of Geo Values	93
8.2.1	<i>GEO VALUES 3000e, OIML Class III (European Countries)</i>	93
8.2.2	<i>GEO VALUES 6000e/7500e OIML Class III (Height ≤ 1000 m)</i>	94

1 Setting up the terminal

Please read through these operating instructions carefully and adhere to them at all times. If you discover that materials are missing or that the wrong ones have been supplied, or if you have any other problems with your terminal, please refer to the dealer and salesperson concerned, or if necessary to the METTLER TOLEDO representative responsible.

1.1 Safety and environment



Do not use IND465 in hazardous areas! Our product range includes special devices for hazardous areas.

Terminals with protection level IP65 are dust-tight and hose-proof to EN 60529. They are suitable for use in dusty environment and brief contact with liquids. Ensure that the terminal is dried off again after coming into contact with liquid.

Even with degree of protection IP65 the terminal should not be used in environments in which there is a risk of corrosion.

▲ Do not flood the terminal or submerge it in liquid



If the **power cord** is damaged, the scale must no longer be operated. Therefore check the cable regularly and ensure that a free space of about 3 cm is left at the rear of the scale, so that the cable is not kinked too severely.

**DANGER!**

Electric shock hazard!

- Always pull out the mains plug before any work on the device.

DANGER!

Electric shock hazard if the mains cable is damaged!

- Check the mains cable for damage regularly and replace it immediately if it is damaged.
- On the rear side of the device, maintain a clearance of at least 3 cm in order to prevent the mains cable bending too much.

CAUTION!

On no account open the device!

The warranty is void if this stipulation is ignored. The device may only be opened by authorized persons.

- Call METTLER TOLEDO Service.

CAUTION!

Handle the compact scale with care.

The scale is a precision instrument.

- When the weighing pan has been removed, never clean the area under the load plate holder with a solid object!
- Do not put excessive loads on the scale.
- Avoid banging the weighing pan.

Parts of the scale coming into contact with foodstuffs have smooth surfaces and are easy to clean. The materials used do not splinter and are free of harmful substances.

With foodstuffs, it is recommended to use the supplied protective cover.

- Clean the protective cover regularly and carefully.
- Replace damaged or very dirty protective cover immediately.

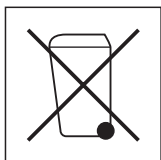

In conformance with the European Directive 2002/96 EC on Waste Electrical and Electronic Equipment (WEEE) this device may not be disposed of with domestic waste. This also applies to countries outside the EU, per their specific requirements.

→ Please dispose of this product in accordance with local regulations at the collecting point specified for electrical and electronic equipment.

If you have any questions, please contact the responsible authority or the distributor from which you purchased this device.

Should this device be passed on to other parties (for private or professional use), the content of this regulation must also be related.

Thank you for your contribution to environmental protection.

If the device is equipped with a storage battery: The nickel metal hydride (NiMH) storage battery does not contain any heavy metals. However, it may not be disposed of with the normal refuse.

→ Observe the local regulations on the disposal of materials that are hazardous to the environment.

1.2 Selecting a location and leveling the weighing platform

The correct location is a decisive factor in ensuring accurate weighing results.

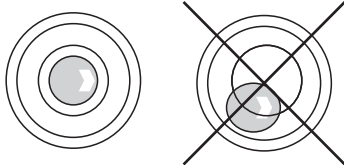
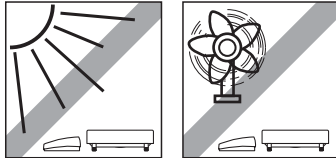
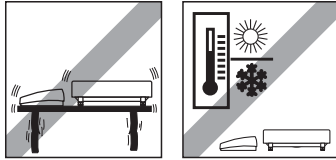

- Choose a stable, vibration-free, flat surface. This surface must be able to safely bear the weight of the terminal and the fully loaded platform.
- Check the ambient conditions.
- Avoid:
 - direct sunlight
 - strong drafts (e.g. from fans or air conditioning systems)
 - excessive temperature fluctuations.

Adjust the weighing platform horizontally. If there is a level indicator, the air bubble must lie inside the inner circle.

Note: The IND465 terminal has a special filter that accelerates certain procedures (zeroing, taring and determining the reference weight for piece counting) in a non-tranquil environment. This inevitably means that there is a slight loss of accuracy with the results. For high-precision results, care must be taken to ensure as tranquil and stable an environment as possible, so that the filter is not activated.

Major changes in geographical location:

Every scale is set by the manufacturer to suit the local gravitational conditions (geographical adjustment value) in the geographical zone to which the instrument is supplied. If a major change of geographical location takes place, this setting must be adjusted by a service technician or a new setting made. Certified scales must, in addition, be recalibrated in accordance with national certification regulations.

1.3 Connecting to power supply

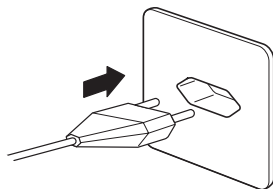

Before connecting the power supply, check that the voltage printed on the back of the terminal is the same as the local power supply. If it is not, do not connect the terminal, and contact your authorized METTLER TOLEDO representative.

If the voltage is correct, connect the plug on the power cable to the power supply.

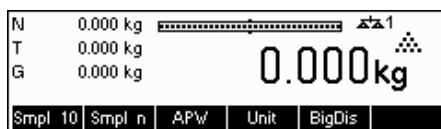

Powering up the terminal initiates a display test in which all the segments and then the software version are briefly displayed. Once the decimal zero appears in the display, the terminal is ready to operate.

For maximum possible precision, adjust/calibrate the weighing system after installing it (Chapter 5.4.1). **Note:** Certified weighing systems must be adjusted by an authorized organization. Please consult your dealer.

1.4 Battery operation

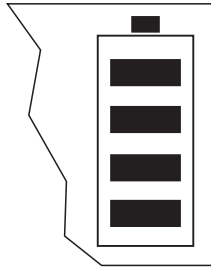

Scales with a built-in battery can work independently from the mains for approximately 30 hours in normal operation. A prerequisite for this is that the background lighting is switched off and that no peripheral devices are connected. The device automatically switches to battery operation as soon as the mains supply is interrupted. When the mains supply is restored, the device automatically switches back to mains operation.

The battery symbol indicates the present charging level of the battery. 1 segment corresponds to approx. 25 % capacity. When the symbol flashes the battery must be charged (min. 4 hours). The charging period is extended if work is continued during charging. The battery is protected against overcharging.

The charging time of the storage battery amounts to approx. 6 hours. If the device continues to be operated during the charging process, the charging time is extended. The storage battery has a service life of approx. 1,000 charging/discharging cycles.

The storage battery is also suitable for permanent mains operation.

→ In order to obtain the full nominal capacity we recommend that you discharge the storage battery at regular intervals (approx. every 4 weeks) through normal operation.

2 Basic functions

This Chapter describes how to switch the terminal on and off, zero and tare it, weigh materials and record the results. All displays are based on default settings "US English".

2.1 Switching on and off and zeroing



Briefly pressing «**On/Off**» key switches the terminal on or off.

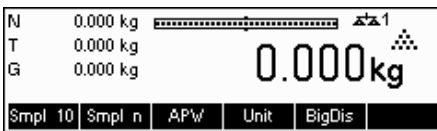

The terminal carries out a display test (Chapter 1.3). Once the weight display appears, the terminal is ready to operate and automatically zeroed.

Note: The screen display shown here may not necessarily be the same as the display appearing on your terminal. Please refer to Chapter 5 on how to navigate within the 'Vision Setup'-menu and how to define softkeys for each function.

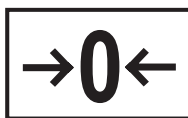

Note: If necessary, the weighing system can be zeroed at any time with the line «→0←» key.

2.2 Setting date and time

Time can be set in 24 hours or 12 hours format, and the date in European or US format.



Press the «» key continuously for about 2 seconds.

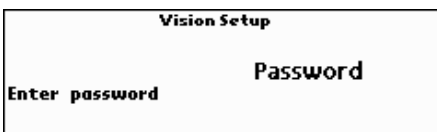

Briefly press the «» key again.

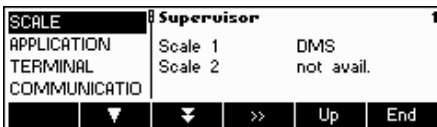

Select **TERMINAL** by pressing the «» key and press the «» key.



Select **Device** and press the «» key.



14



Select **Date Time** by pressing the «▲» key and press the «>>» key.



Select **Date** by pressing the «▲» key and press the «Edit» key.



Use the numeric keypad to enter the date and confirm with the «OK» key. Incorrect inputs can be deleted with the «Erase» key. The «←» and «→» keys can be used to scroll the characters that are entered.

To set the correct time, do the same procedure but select **Time** instead of **Date**.

To leave Vision Setup, press the «End» key. Save changes and confirm by pressing the «Yes» key

2.3 Language settings

Language can be set into US English, English, German, French, Spanish or Italian.



Press the «» key continuously for about 2 seconds.



Briefly press the «» key again.

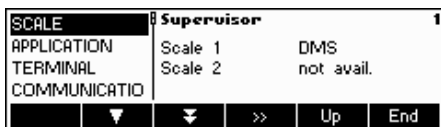

...appears on the screen.



Select **TERMINAL** by pressing the «▲» key and press the «>>» key.



Select **Device** and press the «>>» key.



Select **Language** by pressing the «▲» key and then press the «Edit» key.



Choose the desired language and then press the «OK» key.

2.4 Simple weighing

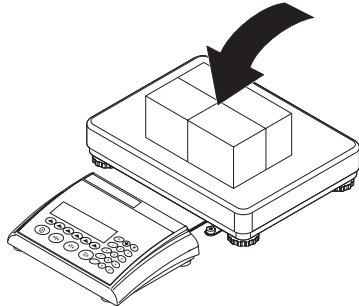

Place the object to be weighed on the platter.

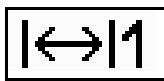
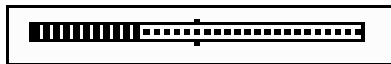

The bar graph at the top of the display shows how much of the weighing range is being used and how much is still available (as % of total scale capacity). The range symbol at the upper right corner of the display shows the first or second half of the range of the maximum load. **Note:** The number changes from 1 to 2 when set for 2 weighing ranges:

Example: 6 kg scale:

1. Range 0 – 3 kg Resolution 1 g
2. Range 0 – 6 kg Resolution 2 g



In order to switch from the 2nd range back to the 1st range, the load must first be removed from the scale or it must be zeroed. MonoBloc scales will automatically switch back to fine range upon load removal.

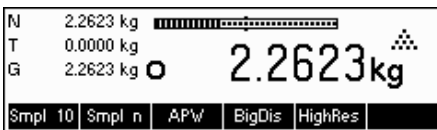

Wait until the stability detector (a small ring at the left edge of the display) disappears, then...

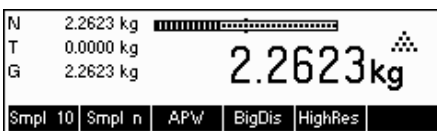

... read the indicated net weight and press the «HighRes» key.

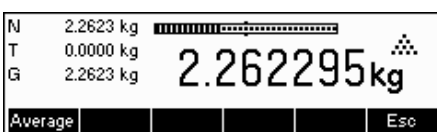

The «HighRes» key enables the weighing result to be displayed in control mode, i.e. with a higher resolution.

Note: Control mode is not available if the maximum resolution has already been selected in Vision setup (Chapter 5).

Press «Average» key to perform average weighing or press «Cancel» key to go back to the normal weighing mode. The averaged value corresponds with the average weight and the procedure takes about 20 seconds.

2.5.2 Entering the tare weight numerically (pre-tare)

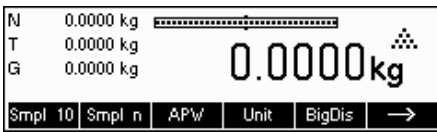

Note: The «PT» softkey is not given as a standard softkey, because pre-tare can also be inputted using the Short Input Mode (see Chapter 3.1). This function key must thus be defined separately in Vision Setup. To define function keys, see Chapter 5.5.7. You will find an overview of all function keys that can be defined in Chapter 5.3.2. Press «→» to show other available function keys and press «←» to go back to the first page of the function keys.

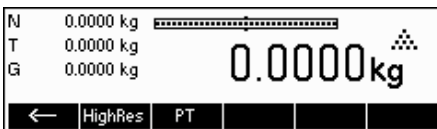

Press the «PT» softkey.



... appears on the screen.

Press the «New» softkey to enter the tare weight. If you want to work further with other tare weights, you can set and define the «Add. Tare» key. The additional tare weights will be added to the actual tare weights. The «Undo» softkey deletes the last defined "Add. Tare Weight". The «Delete» softkey deletes the whole tare weight.



Press the «New» softkey now and using the numeric keypad, enter the **known tare weight** in the current weighing unit and confirm with «OK».

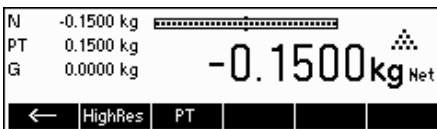

The tare values entered appear in the display with a negative sign and the symbol "Net" (net weight). As soon as the weighing container with the corresponding weight is placed on the platter, the zero display appears.

2.5.3 Determining the gross and net weights

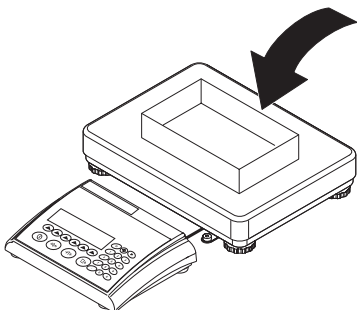

Place the **empty** weighing container or packaging on the platter and then press the «→T←» key briefly, or press the «PT» softkey if a **known tare weight** has already been established.

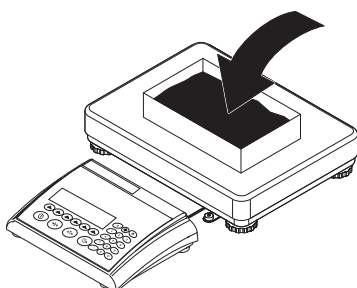

Place the material to be weighed in the container, then...

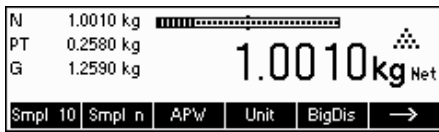

... read the indicated net weight. Scroll on the «» key.

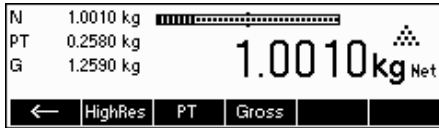

Press the «**Gross**» softkey. This function causes the gross weight to be displayed (the "G" symbol appears and replaces the "Net" symbol).

Note: «**Gross**» is not given as a standard softkey and must be defined separately in Vision Setup. In order to define the «**Gross**» softkey, see Chapter 5.5.7.

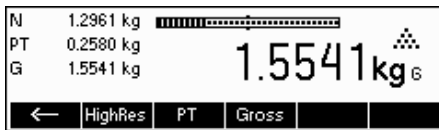

After a few seconds, the terminal goes back automatically to net weight display.

2.6 Recording weighing results



Press the «» key to send the current weighing result to the peripheral device (printer, computer) via the interface.

Note: A multiple print out can be generated by entering a number with the numeric keypad followed by pressing the «» key. (only TLP/LP2844, TLP/LP2824, MT8863).

Please refer to Chapter 5.3.4 for instructions on configuring the interface(s).

3 Enhanced functions

This Chapter describes the IND465 features that simplify working with the application.

3.1 General Info

The IND465 terminal provides several features which make working with the application easier.

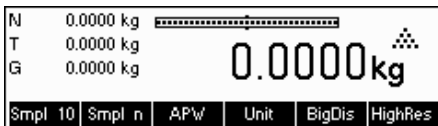

Short Input Mode

For some IND465 functions, it is possible to use a short-cut method of user input.

As in the example for entering the pre-tare weight in Chapter 2.5.2, the normal procedure for initiating user input is to press the function softkey first before entering the data. However, it is also possible to key in the data first prior to selecting the function the data is intended for.



This example shows how to enter the pre-tare weight using short-input mode.



While in standby mode, use the numeric keypad to enter the **known tare weight** in the current weighing unit.

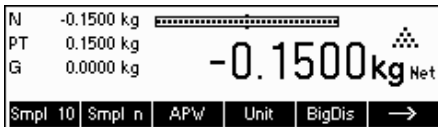

Then press the «PT» softkey or the «→T←» key to set this value as the pre-tare weight.

The result is the same as in Chapter 2.5.2.

Short-input mode works with the following function softkeys:

- «**Smpl X**» The value keyed in replaces the value of X (Chapter 5.5.1) and perform a reference weight determination using the value as reference number of pieces (Chapter 4.1.1). Default value for X is 10.
- «**Smpl n**» The value keyed in will be used as the reference number of pieces for the reference weight determination.
- «**APW**» The value keyed in will be used as the average piece weight.
- «**→T←**» The value keyed in will be used as the pre-tare weight.
- «**PT**» The value keyed in will be used as the pre-tare weight.
- «» The value keyed in defines the number of printouts (only for label printer).
- «**→0←**» The value keyed in defines the threshold for the Gross Weight Alarm.



The IND465 terminal recognizes if the function softkey pressed is not compatible with short-input mode and will display a warning indicating so.

3.2 Database

The following describes the operations for working with the article database.

N	0.0000 kg	0.0000 kg						
T	0.0000 kg	0.0000 kg						
G	0.0000 kg	0.0000 kg						
<table border="1"> <tr> <td>Smpl 10</td> <td>Smpl n</td> <td>APW</td> <td>Unit</td> <td>BigDis</td> <td>HighRes</td> </tr> </table>			Smpl 10	Smpl n	APW	Unit	BigDis	HighRes
Smpl 10	Smpl n	APW	Unit	BigDis	HighRes			

Briefly press the «» key.

Article	[No active article]					
<table border="1"> <tr> <td>Datab.</td> <td></td> <td></td> <td>OK</td> <td>Cancel</td> </tr> </table>		Datab.			OK	Cancel
Datab.			OK	Cancel		

If in the "Vision Setup → APPLICATION → Database" the ID overview is set "On", you will enter a submenu into the database in which you can define additional information/identification. (Please view chapter 5.5.2 for the use of the IDs).

To enter the article database menu, press the «**Datab.**» softkey.

Note: If 'Vision Setup → APPLICATION → Database → ID Overview' is not active, this screen will be skipped and you will be brought directly to the article database menu.

Database is empty.				
Create a new Article?				
		Yes	No	Cancel

The first time the article database is accessed, the database will be empty and the IND465 terminal will prompt you to create a new article.

Maggi Dip 173	IName1	1/6
Maggi Dip 272	Numb	272
Maggi Dip 74	ID1	F3
Maggi Sauce ChinaPf. 17	APW	0.076000 kg
	▼	Search
		Options
		OK
		Cancel

If articles have been previously defined, you will be presented with several options for working with the article database:

Press the «» key to select the previous article in the list.

Press the «» key to select the next article in the list.

Press the «**Search**» key to find an article in the list.

Press the «**Options**» key to perform other operations on the currently selected article (Chapter 3.2.1).

Press the «**OK**» key to make the currently selected article the active one for use with the various IND465 applications and leave the article database menu.

Press the «**Cancel**» key to leave the article database menu. The article that was active before entering the article database menu will be retained except if that article was deleted. Other changes made to the database with the «**Options**» key will not be undone.

3.2.1 Database editing functions

The following describes various operations that could be performed on articles.

Maggi Dip 173	IName1	1/6
Maggi Dip 272	Numb	173
Maggi Dip 74	ID1	F3
Maggi Sauce ChinaPf. 17	APW	0.076000 kg
Delete	Copy	New
Define	Print	Close

With the desired article selected in the article list, press the «**Options**» key. You can then choose an operation to be done on the article.

Note: If a password was defined in 'Vision Setup → APPLICATION → Database → Article → Password' (Chapter 5.5.2) then you will be asked to enter the password before you can modify the selected article.

Maggi Dip 173	[Name]	1/6
Maggi Dip 272	Delete	
Maggi Dip 74	Maggi Dip 173?	
Maggi Sauce ChinaPf. 17		
		Yes No Cancel

Press «Delete» to remove the current article from the database. You will be asked to confirm deletion of an article.

Name		ABC
Number	Name	
Identification▶		
Tare▶		
		Erase ← → OK Cancel

Press «Copy» to create a duplicate of the selected article. All the parameters of the current article, except the name and number, will be copied into the newly created article.

Press «New» to create a blank article.

Name	Maggi Dip 173	1
Number	Name	
Identification▶	Maggi Dip 173	
Tare▶		
		▼ Edit OK Cancel

Press «Define» to modify the selected article. Select the desired parameter by using the «▲», «▶», or «▼» softkeys, then press «Edit» to modify the selected parameter.

Number	Maggi Dip 173	5
Identification▶	APW	0.076000 kg
Tare▶		
APW▶		
		▲ ▼ ▶ >> OK Cancel

A «>>» softkey in place of the «Edit» softkey indicates that there is a submenu for the selected item.

Press «Print» to print out the parameters of the selected article.

Maggi Dip 173	[Name]	1/6
Maggi Dip 272	Numb	173
Maggi Dip 74	ID1	F3
Maggi Sauce ChinaPf. 17	APW	0.076000 kg
Delete	Copy	New
Define	Print	Close

Press «Close» to leave the article editing menu and return to the article selection menu.

3.2.2 Defining an article

The following describes the parameters of an IND465 article.

Name	Maggi Dip 173	ABC
Number	Name	
Identification▶	Maggi Dip 173	
Tare▶		
		Erase ← → OK Cancel

Name

The name of the article can contain up to a maximum of 24 alphanumeric characters. If 'Vision Setup → APPLICATION → Database → Article → Search criterion' is set to "By name", this parameter is used for searching in the article database.

Name	Maggi Dip 173	123
Number	Number	
Identification▶	173	
Tare▶		
		Erase ← → OK Cancel

Number

The number of the article can contain up to a maximum of 24 alphanumeric characters. If 'Vision Setup → APPLICATION → Database → Article → Search criterion' is set to "By number", this parameter is used for searching in the article database.

ID1	Maggi Dip 173	123
ID2	ID1	
	A01-555	
		Erase ← → OK Cancel

Identification / ID1 and ID2

Additional identification parameters for the article that can contain up to a maximum of 24 alphanumeric characters. These parameters could be used to provide additional information about the article in the report printouts.

Number	Maggi Dip 173		
Identification▶	actual weight :		
Tare▶	0.0984 kg		
APW▶			
Weigh in	Edit	OK	Cancel

Tare

Pre-defined tare weight for the article. The pre-defined tare weight can both be weighed-in or entered manually. Enter the weight value manually, in case the tare weight is already known.

Number	Maggi Dip 173		
Identification▶	actual weight :		
Tare▶	0.0984 kg		
APW▶			
Smpl 10	Smpl n	APW	OK
			Cancel

APW

Define the average piece weight of the article. It is possible to set the average piece weight for the article by performing a reference weight determination (Chapter 4.1.1) or by manually entering a known piece weight (Chapter 4.1.2).

Identification▶	Maggi Dip 173	123
Tare▶	Sample Size	
APW▶	10	
Sample Size		
Erase	←	→
	OK	Cancel

Sample size

Define the reference number of pieces. This value will override the one set in 'Vision Setup → APPLICATION → Counting → Sample_X' (Chapter 5.5.1) while the article is active.

Tare▶	Maggi Dip 173	123
APW▶	PW Optimization	
Sample Size	80 %	
PW Optimization		
Erase	←	→
	OK	Cancel

PW optimization

The correction factor for optimizing the piece weight. The new value of the APW will be adjusted by this factor in relation to the previous APW. **Note:** This works only if PW Tol+ and PW Tol- are set and the APW is within the tolerances, and also if a reference quantity (reference number of pieces) is defined.

See also below Example.

Absolute	Maggi Dip 173	123
Relative	PW Tol+	
Percent	5 %	
Erase	←	→
	OK	Cancel

PW Tol+

The upper limit for a new average piece weight. If the new piece weight is above this value, a warning will be displayed prompting the operator whether or not he wants to accept the new piece weight. **Note:** APW must already be defined before setting the PW Tol+, otherwise the PW Tol+ entry will be cleared.

Absolute	Maggi Dip 173	123
Relative	PW Tol-	
Percent	5 %	
Erase	←	→
	OK	Cancel

PW Tol-

The lower limit for a new average piece weight. If the new piece weight is below this value, a warning will be displayed prompting the operator whether or not he wants to accept the new piece weight. **Note:** APW must already be defined before setting the PW Tol+, otherwise the PW Tol+ entry will be cleared.

Example: In order to have the wearing down of the filling machine reflected, the already existing value should be rated higher with 20% whereas the new piece weight is rated with 80%.

To ensure that only 'good' pieces are used to build a new reference, they are only allowed to derive max. 5% from the currently saved average piece weight.

Currently saved average piece weight = 0,1000kg

PW Optimization = 80%

PW Tol + = 5%

PW Tol - = 5%

New piece weight = 0,0970kg (= within the tolerance +/- 5% of 0,1000kg)

=> **new piece weight in the database = 0,0976kg** (0,1000kg x 20% + 0,0970kg x 80%)

PW Optimization	Maggi Dip 173	10
PW Tol▶	Weight	0.000000 kg
PW Tol▶	- Tol	0.000000 kg
Filling/Checkw.▶	+ Tol	0.000000 kg
▲	▼	»
	OK	Cancel

Target▶	Maggi Dip 173	10-1
- Tol▶	Weight	
+ Tol▶	0.000000 kg	
▼	»	OK
	Cancel	

Weight▶	Maggi Dip 173	
Pieces	actual weight :	
	0.0984 kg	
Weigh in	Edit	OK
		Cancel

Absolute	Maggi Dip 173	123
Relative	+ Tol	
Percent	50 %	
Erase	←	→
	OK	Cancel

Absolute	Maggi Dip 173	123
Relative	- Tol	
Percent	.15 kg	
Erase	←	→
	OK	Cancel

PW Tol▶	Maggi Dip 173	11
PW Tol▶	Total Net	0.0000 kg
Filling/Checkw.▶	Total Gross	0.0000 kg
Accumulation▶	Total Pieces	0 PCS
▲	▼	»
	OK	Cancel

Total Net	Maggi Dip 173	123
Total Gross	Total Net	
Total Pieces	0.0000 kg	
Total Lot		
Erase	←	→
	OK	Cancel

Total Net	Maggi Dip 173	123
Total Gross	Total Gross	
Total Pieces	0.000 kg	
Total Lot		
Erase	←	→
	OK	Cancel

Total Net	Maggi Dip 173	123
Total Gross	Total Pieces	
Total Pieces	0 PCS	
Total Lot		
Erase	←	→
	OK	Cancel

Total Net	Maggi Dip	123
Total Gross	Total Lot	
Total Pcs.	0	
Total Lot		
Erase	←	→
	OK	Cancel

PW Tol▶	Maggi Dip 173	12
Filling/Checkw.▶	Custom Unit	
Accumulation▶		
Custom Unit▶		
▲	▼	»
	OK	Cancel

Filling/checkweighing nominal

The nominal value is used for the filling (chapter 4.9) and checkweighing (Chapter 4.10) applications. It can be determined both by direct entry and by weighing in. It is possible to define the nominal value in pieces or as weight value. This parameter must be filled in first before defining Tol+ and Tol-. Note: If a target weight is defined this value will be used for the "accumulation to target" function (see chapter 4.8).

Filling/checkweighing Tol+

The upper limit for filling (chapter 4.9) and checkweighing (Chapter 4.10) applications. It is possible to define this parameter as an absolute value, relative to the Nominal, or as a percentage of Filling / Nominal.

Filling/checkweighing Tol-

The lower limit for the filling (chapter 4.9) and checkweighing (Chapter 4.10) applications. It is possible to define this parameter as an absolute value, relative to the nominal, or as a percentage of nominal.

Accumulation

- Accumulation total net

The total net weight for the Accumulation application (Chapter 4.7).

- Accumulation total gross

The total gross weight for the Accumulation application (Chapter 4.7).

- Accumulation total pcs.

The total number of pieces for the Accumulation application (Chapter 4.7).

- Accumulation total lot

The total number of lots for the Accumulation application (Chapter 4.7).

Custom Unit

This application enables the user to define any unit (mass) for each article. (See also Chapter 4.11).

Number	Apple	5
Identification▶	APW	1.000000 kg
Tare▶		
APW▶		
▲	▼	▼
>>	OK	Cancel

Note however, that the parameter APW is already defined and its value is set to the APW that was active before «**SaveAs**» was pressed.

Aside from the APW, the article parameters that will also be saved are Tare, Sample Size, the Filling/Checkweighing parameters, and the Accumulation parameters.

3.3 Gross Weight Alarm

Using the Short-input mode (see chapter 3.1) it is possible to define a Gross Weight Alarm. In case it is defined, there will be an uninterrupted alarm beep as soon as the gross weight reaches the defined threshold. The beep sound will stop as soon as the weight is either below the threshold or any key is pressed.

Note: After switching off the alarm using a key press, it will only become active again if the gross weight fell under the threshold for a while before reaching it again. The Gross Weight Alarm can be deactivated by the 'C' key or by setting the threshold parameter to 0.

3.4 SmartManager

To make working with the article database even easier, as well as to save the settings of the terminal and its configuration, the IND465 comes with its own (optional) computer program (SmartManager). SmartManager requires MS Windows XP or 2000. This program offers you the possibility to administer and manage your article data and also gives you the ability to import and export files using MS Excel. For configuration and operation please read the operator manual of the SmartManager software.

IND465 is able to get direct and immediate access to archived database using SmartManager. The IND465 terminal functions in this case, as "Client". Hence it directly gets hold of data on an external database. In this mode, its own internal database will not be used and will stay unchanged. Please make the necessary settings of "Access" on "External" in Vision Setup → APPLICATION → Database.

This functionality is also possible to connect a terminal that has access to its own database, with several scales. If the internal database of IND465 is being used, SmartManager can create a backup copy of the database and this will be played back again on the scale.

3.5 FlashLoader

The IND465 software is stored in flash memory and the FlashLoader program enables you to upgrade the software of your terminal when updates are available.

Note: This should only be operated by authorized personnel. You should always make a back-up copy of your data prior to performing this procedure.

To be able to update your software using the FlashLoader, you will need the following:

- PC with Microsoft Windows ® operating system (version 2000, or XP)
- Computer-to-terminal connection cable (RS232 cable, 9-pin sub-D plug m/f, order number 00410024)
- FlashLoader program

The FlashLoader program will guide you through the updating process.

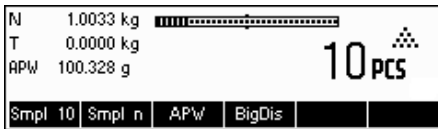

A **reference weight** has been established.

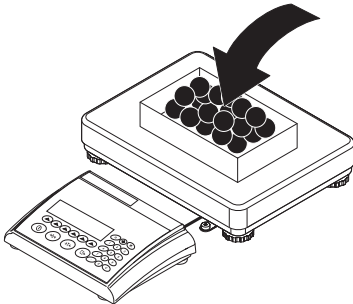

If a **different number of pieces** has been placed on the scale, press the «**Smpl n**» key and choose from among the choices of **5, 20, 30, 40 or 50 pieces**. If the number of pieces is different, choose the «**Var**» key and enter the desired number of pieces.

Note: The Short Input Mode is also available for the functions «**Smpl X**» and «**Smpl n**» (see Chapter 3.1).



Once a reference has been determined, you can use the «**Weigh**» key to switch back to the weight display at any time.

Note: This function is not given as a standard function key, because Gross, Tare and Net will be continuously shown on the upper left of the display. To activate it, proceed similar like activating «**Smpl X**» or «**Smpl n**» (see Chapter 5.5.7).



Press «**Count**» key to switch back again to counting mode.



You can use the «» key to transmit the piece counting result via the interface to a peripheral device (printer, computer) (for sample report see Chapter 6.2).

4.1.2 Entering the reference when the piece weight is known

The softkey "APW" is already given as a standard function key. In case it is not visible on the display, define a softkey for "APW" in the softkey configuration (See Chapter 5.5.7). After the APW softkey has been defined, do the following steps:

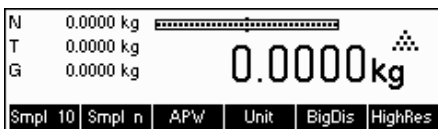

In standby mode, press the «**APW**» key.

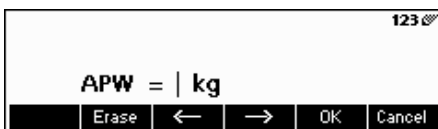

Enter piece weight, example: 0.02931 kg

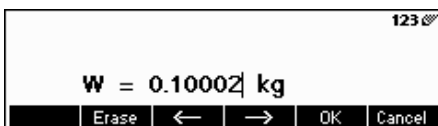

Press the «**OK**» key.



The scale has established a known reference weight and is now ready for piece counting.

4.3 Reference optimization

Reference optimization serves to enhance the accuracy of the average piece weight by re-calculating it using a greater number of reference pieces. Reference optimization can be performed either manually or automatically.

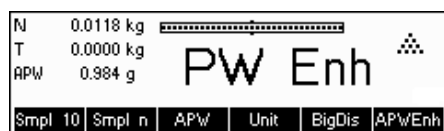

Manual Reference Optimization

Define a softkey for Reference Optimization in the softkey configuration (See Chapter 5.5.7). The Reference Optimization softkey is displayed as «**PW Enh**» and it will only be active while in piece counting mode. If the scale is in weighing mode, this softkey will not appear even if it is part of the softkey configuration.

To perform a reference optimization at any time, press the «**PW Enh**» softkey. The average piece weight will be re-calculated using the current weight and the current number of pieces on the scale. At each optimization, the message «**PW Enh**» appears briefly and the new total number of pieces is then displayed.



Automatic Reference Optimization

No action is required during operation for automatic reference optimization and it functions both in "Counting in" (Chapter 4.1) and "Counting out" (Chapter 4.2). The "Auto OPT" symbol (located near the lower right corner of the screen) appears in the display indicates that automatic reference optimization is switched on.

Each time you place additional parts on the scale, it optimizes automatically. You do not have to press a key to perform optimization. At each optimization, the message «**APW Enh**» appears briefly and the new total number of pieces is then displayed.

Note: Automatic optimization only functions if the number of additional pieces placed on the scale is not greater than the number already on the weighing pan. If the differences between the parts are too big, the reference optimization will not be executed.

4.4 Minimum sample weight

To ensure that a more accurate average piece weight is attained during reference weight determination, it is possible to set desired minimum percentage accuracy as determined by the reference weight placed on the scale. To enable minimum sample weight checking, set 'Vision Setup → APPLICATION → Counting → Min. Sample WT' (See Chapter 5.5.1) to the desired percentage accuracy.

To be able to view the percentage accuracy for a reference weight determination, set 'Vision Setup → APPLICATION → Counting → Accuracy Disp.' (See Chapter 5.5.1) to 'On'.

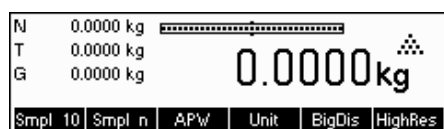

In this example, the minimum reference weight was set to 99.5% and accuracy display is active.

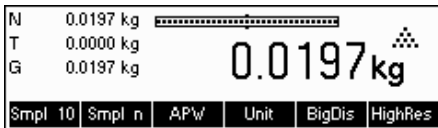

10 samples were placed on the scale and «**Smpl 10**» was pressed.

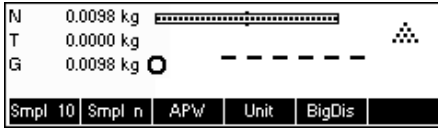

IND465 calculates the average piece weight as discussed in Chapter 4.1.1 but it has determined that the percentage accuracy for the reference weight is below the value set as Minimum Sample Weight.

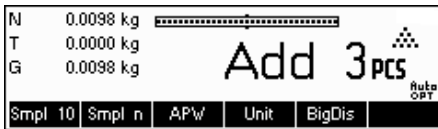

It will calculate the number of pieces that you have to place on the pan to reach the desired percentage accuracy.

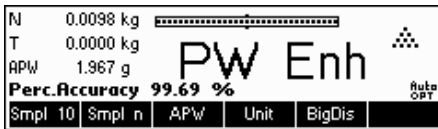

After placing the specified number of pieces on the scale, the average piece weight will be optimized (Chapter 4.3) and, since accuracy display is active, the percentage accuracy will be displayed for approximately 4 seconds. Note that in this example, the percentage accuracy is at 99.54% which is above the desired minimum sample weight of 99.5%.

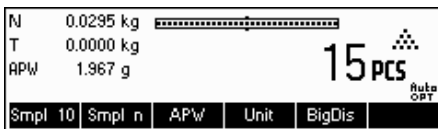

IND465 is now ready to perform piece counting using the optimized average piece weight.

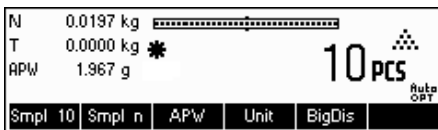

It is possible to override the minimum sample weight checking by pressing the «**C**» key when you are prompted to add pieces on the scale. This will enable you to use the calculated piece weight, but note that a "*" appears on the display to indicate that the sample weight is below the desired percentage accuracy.

Adding mode works both with "Counting in" (Chapter 4.1) and with "Counting out" (Chapter 4.2).

4.5 Using the info key

Use the «**i**» key to call up additional information as defined in the **Info/Help** menu under **Application** (Chapter 5.5.8).

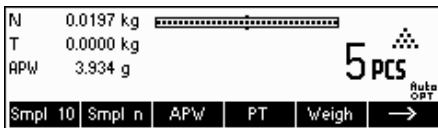

In this example, Info lines 1 to 4 were configured to show the gross weight, date, time, and percentage accuracy respectively.



Pressing the «**i**» key will toggle between a screen that shows the default content of the Info lines and another window that shows the additional information configured such as the Gross Weight, Date, Time and Percentage Accuracy.

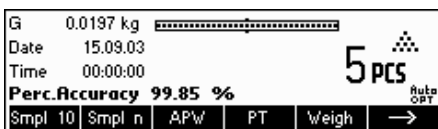



For a list of the additional information that can be displayed on the Info lines, please refer to Chapter 5.5.8.

Note: You can specify in Vision Setup "APPLICATION → Counting → Total Pieces", whether...

- only the counting result of the bulk scale
- or the counting result of the bulk scale and that of the reference scale (both scales together) will be displayed.

When an interface is set to one of the three modes above, the scale switch key will be added to the softkeys. In case it is not visible on the display, define this softkey in the softkey configuration (See Chapter 5.5.7). You can toggle between the two scales with the «» softkey.

To determine reference weight while in Reference or Bulk modes, the scale will automatically switch from reference scale to bulk scale. You can override this automatic switching by keeping the «» softkey pressed for 1 second. Info line 4 will indicate which scale will be used for reference weight determination.

The scale symbol on the top right in the display indicates the active scale: " 1" = IND465 system, " 2" = second scale.

When the second scale is active, you can zero and tare it with the IND465 «→0←» and «→T←» keys, respectively.

4.7 Accumulation

If the scale is in piece counting mode, you can do several piece counts and then determine the total number of pieces weighed and their total weight. If the scale is in weighing mode, several weighings can also be accumulated to determine their total.

There are several report printouts that are available in the Accumulation application. To select the desired settings and to connect and configure a printer, see Chapter 5.9.2 and Chapter 5.9.3 respectively.

Define a softkey for Accumulation in the softkey configuration (See Chapter 5.5.7). After an Accumulation softkey has been defined, do the following steps:

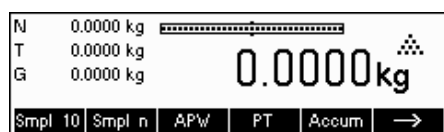

If a weighing container is used, it must be tared.

Determine the reference (see Chapter 4.1)



Press the «» softkey to go to the next menu.



Press the «**Accum**» softkey to start the accumulation function.

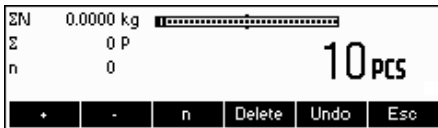

Press the «+» softkey to add the current number of pieces to the total, or the «-» softkey to deduct the current number of pieces from the total.



The quantity of the first lot has been saved in the memory. If Lot printing is active (Chapter 5.5.4) the lot number, net weight and number of pieces will be printed out automatically.

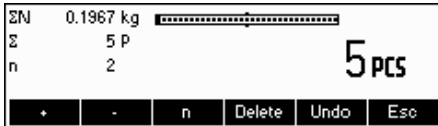

Place the desired quantity of the second lot and press the «+» softkey to add again or the «-» softkey to deduct.

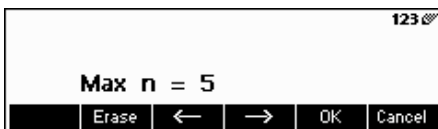

Press the «n» softkey to limit the number of lots to accumulate.



If **Max n** is defined, it will only be possible to accumulate as many lots as the value set. Once the number of lots accumulated reaches the value of Max n, a warning will be displayed indicating that maximum items have been reached.

Press the «Delete» softkey to clear all the lots from the memory. A summary report with the total number of lots, total weight, and total number of pieces will be printed out.

Press the «Undo» key to discard the last lot added.

To close the Accumulation application at any time, press the «Cancel» key. This will return the scale to standby mode but the lots accumulated will be retained in memory.

To close the Accumulation application and clear all the lots from memory, press the «C» key. This will also generate a summary report.

Note: If an article was active when the Accumulation application was started, the Accumulation parameters (Chapter 3.2.2) of the article will be updated by the transactions done with the application. That means the total net or gross weight, the total pieces, and the number of lots will be added to the values already stored in the database for the active article.

4.8 Accumulation to target

The „accumulation to target“ function allows accumulation up to a predefined weight value. To enable this function, a target value for an article has to be defined in the article database (comp. chapter 3.2.2). If the scale is setup to “accumulate to target,” this value will be used as the target value.

Example: A truck has a max. loading capacity of 1000 kg. This maximum loading capacity must not be exceeded while loading the truck.

Proceed as follows:

1. Define an article with a corresponding target weight

PW Optimization	Truck 0012	10
PW Tol▶	Weight	1000.000 kg
PW Tol▶	- Tol	0.000 kg
Filling/Checkw▶	+ Tol	0.000 kg
<div style="display: flex; justify-content: space-between; align-items: center;"> ▲ ▼ »» OK Cancel </div>		

2. In the vision menu under Application -> Totalisation -> set Target Wt. to „On“ (comp. chapter 5.5.4)
3. Define the softkey „Totalising“ in the softkey-configuration (see chapter 5.5.7). In the scale display the key «**Total**» is now shown.

N	0.000 kg	↔11
T	0.000 kg		
B	0.000 kg		
0.000 kg			
<div style="display: flex; justify-content: space-between; align-items: center;"> Ref 10 Ref n Ref G T Eing. Total → </div>			

If a container is used it has to be tared.

4. Load the desired article (in this case “the truck”) out of the article database and press the key «**Total**»

ΣN	0 kg	
ΣG	0 kg		
↔	1000 kg		
0 kg			
Article: Truck 0012			
<div style="display: flex; justify-content: space-between; align-items: center;"> + - n Delete Undo Esc </div>			

Now, the loading procedure can start.

ΣN	50 kg	
ΣG	50 kg		
↔	950 kg		
50 kg			
Article: Truck 0012			
<div style="display: flex; justify-content: space-between; align-items: center;"> + - n Delete Undo Esc </div>			

The current weight and the available remaining capacity until reaching the target weight are now displayed.

Totalisation			
Article:			
n	1	Truck 0012	
Target Wt.: 1000.000 kg			
<div style="display: flex; justify-content: space-between; align-items: center;"> + - n Delete Undo Esc </div>			

Pressing the Info key gives further information. In this case: article name: “Truck 0012”, Number of accumulated lots „1“ and target weight „1000.00 kg“

ΣN	595 kg	Warning!	
ΣG	595 kg	Value out of range	
↔	405 kg		
<div style="display: flex; justify-content: space-between; align-items: center;"> + - n Delete Undo Esc </div>			

If the target weight is exceeded while accumulating an additional lot, a warning message will be displayed. Additional accumulations will no longer be possible.

4.9 Filling

The filling application simplifies weighing of small parts (e.g. liquid or powder) until a target amount or weight is reached. It provides the user a visual indication of the amount currently on the scale in relation to the target amount. If activated in the Vision Setup, the scale will also beep if the amount is already within the tolerance limits defined.

Define a softkey for Filling in the softkey configuration (See Chapter 5.5.7). After a Filling softkey has been defined, do the following steps:

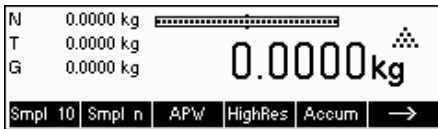

In standby mode, press the «» softkey to scroll to the next menu.



Press the «**Filling**» softkey.

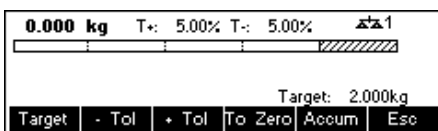

In this example, **Target** (target weight), **+ Tol** (positive tolerance) and **- Tol** (negative tolerance) have been defined. The first bar graph that appears is the coarse range indicator. The fine range, as shown by the gray area in the bar graph, depends on the tolerance limits set. As the tolerance limits are increased or decreased, the size of the fine range will also be adjusted accordingly.

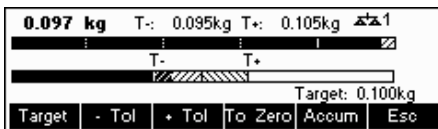

Place sample to be weighed on the scale.

As soon as the weighed amount reaches the start of the fine range, a second bar graph appears that shows the fine range. For very small tolerance limits, there will be a third-stage indicator that will appear to show the fine range.

In addition, it is possible to directly switch from Filling to Accumulation. Therefore, simply press «**Accum**» and continue as described in Chapter 4.7 Accumulation.

Please refer to the Notes in Chapter 4.10 for additional information.

4.10 Checkweighing (+/-)

The checkweighing application simplifies verification of sample weights or amounts. It provides the user with visual indicators to show whether or not weight of the sample is within tolerance limits of a specified target weight or amount.

Define a softkey for Checkweighing in the softkey configuration (See Chapter 5.5.7). After a checkweighing (+/-) softkey has been defined, do the following steps:

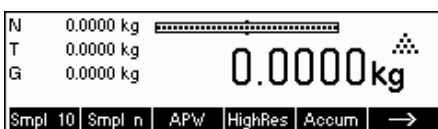

In standby mode, press the «» softkey to scroll to the next menu.

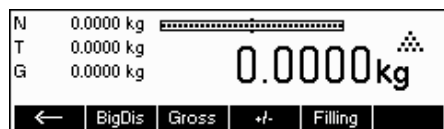

Press the «+/-» softkey.

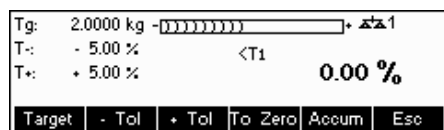

In this example, **Target** (target weight), **+ Tol** (positive tolerance) and **- Tol** (negative tolerance) have been defined.

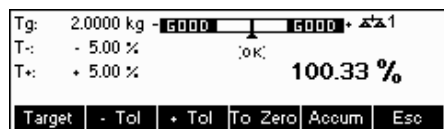

Place sample to be weighed on the scale.

The indicators help the user easily verify the weight if the sample is within the targets defined.

In addition, it is possible to directly switch from Checkweighing to Accumulation. Therefore, simply press «**Accum**» and continue as described in Chapter 4.7 Accumulation.

Notes:

The Filling and CheckWeighing applications use the filling parameters stored in the article database (Chapter 3.2.2) if they are defined and if they are in the same mode (weighing or piece counting). For example, if Filling/Checkweighing Nominal is defined as weight and the scale is currently in weighing mode, it will not be possible to define Target, Tol+, and Tol- while the Filling or Checkweighing applications are active. The values for these parameters will be taken from those defined in the current article. If however, Filling/Nominal is defined as weight and the scale is in counting mode, the Filling parameters of the article will not be used and the Target, Tol+ and Tol- parameters of the Filling or Checkweighing applications will have to be defined inside the application.

Clearing the currently selected article by pressing the «**C**» softkey while in standby mode will not clear the values defined for Target, Tol+, and Tol-. To clear these parameters, the «**C**» has to be pressed while inside the Filling or Checkweighing applications.

4.11 Custom Unit

The Custom Unit weighing function allows weighing using a unit that can be customized (a unit specified by the customer). You may choose to use this function through a function key or Database menu.

Define a softkey for Custom Unit in the softkey configuration (See Chapter 5.5.7). After a Custom Unit softkey has been defined, do the following steps:

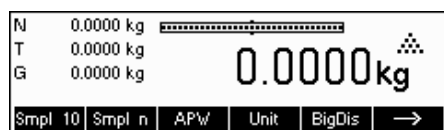

In standby mode, press the «**→**» softkey to scroll to the next menu.

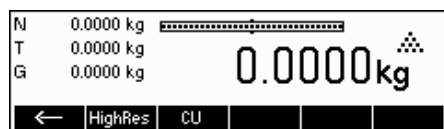

To start the application press the «**CU**» softkey.

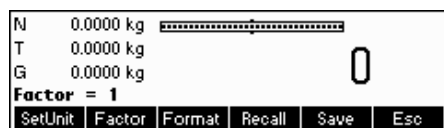

From the main Custom Unit screen you can define the text for the custom unit, set the factor to use for weighing, recall previous definitions, or save the current definition.

Note: The «**Esc**» softkey is available only if a "Custom Unit" is defined in the database.



Press the «**SetUnit**» softkey and enter the abbreviation of the custom unit. Confirm by pressing «**OK**».

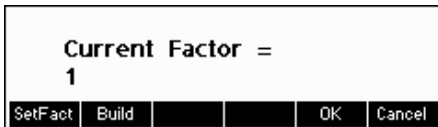

The factor can either be entered manually or can be calculated from the weight of samples placed on the scale.

Press the «**Factor**» softkey. To manually enter the factor, press the «**SetFact**» softkey. To calculate the factor using the weight of samples placed on the scale, press the «**Build**» softkey.

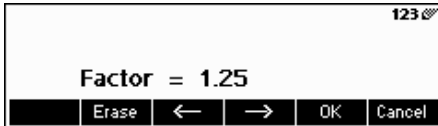

Define the factor manually, by pressing the «**SetFact**» softkey.

Note: If a piece weight was entered for an article, the number of pieces is used for recalling and defining the free unit.

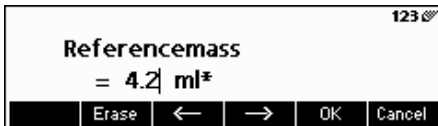

To use the automatically calculated factor, place the sample on the scale, press the «**Build**» softkey and enter the reference mass.

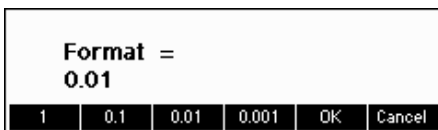

To change the resolution of the display, press the «**Format**» softkey and select the desired format.



You can save the factor and unit you have just defined by pressing the «**Save**» softkey. While in this screen, you can delete other Factor/Unit definitions you have already saved or save your current definition.

To save the current definition, press «**Save**» and enter the name you wish to give this definition. You can save up to 25 Factor/Unit definitions.



To recall previous Factor/Unit definitions, press the «**Recall**» softkey and select the name of the Factor/Unit definition you wish to use.

Note: the customer unit can also be determined individually in the database for each single article.

4.12 High resolution / Average weighing

The "High resolution" function displays the net weight at a higher resolution.

This function allows weighing of unstable goods (e.g. animals) with a higher precision. It takes around 20 seconds to calculate the average weight of the load. This function also works in piece counting mode.

Define a softkey for "High resolution" in the softkey configuration (See Chapter 5.5.7). This softkey is already defined as a standard softkey. After this softkey has been defined, do the following steps:

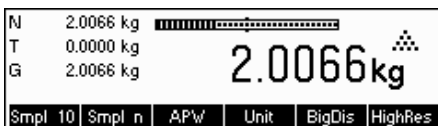

Press the «**HighRes**» softkey in order to display the net weight at a higher resolution.

Note: When using strain gauge scales, the highest possible resolution will be shown. For MonoBloc scales the resolution will become 10 times higher.



Place the load on the scale and press the «**Average**» softkey. IND465 will then take weight readings for 10 seconds and average these weight values.

The "Average" function can also be placed as a function key outside the "High resolution".

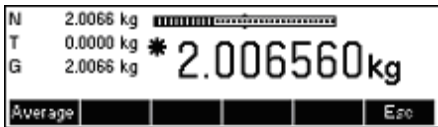

After some more seconds, IND465 will display the average weight of the load.

While in this mode, the weight displayed is frozen and small variations in the actual weight due to the unstable load will not be reflected on the display.

If the load changes more than 10% then the weight display will be released and Average weighing is no longer active.

You can leave this function by pressing the «Esc» softkey.

Note: Certified scales will automatically leave the "High resolution" function after 3 seconds.

4.13 Alibi memory

The alibi memory is an optional fitting, depending on the individual specification of the IND465.

The alibi memory serves to store weighing data of the past, in order to have them accessible at a later time in case of necessity. As soon as a 'stable value' is generated by the scale, it will be stored in the alibi memory. Such stable values can be generated by either pressing the key, after responding to certain SICS commands (S, SU, SR, SRU, P101, P102, PRN etc.), the 'Toledo Continuous' command P or the Auto Print mode.

Define the "Alibi memory" softkey in "Vision Setup → APPLICATION → Function keys", as discussed in Chapter 5.5.7. This softkey is already defined as a standard softkey.

To be able to save in the alibi memory, "Vision Setup → APPLICATION → Alibi memory → On/Off" should be turned "On".



In standby mode, press the softkey to scroll to the next menu.

In order to go to the Alibi memory application, press the «Alibi» softkey.



The entries that have been previously saved will be shown. Press the «*» softkey to directly go to the last (newest) entry. This is marked by an asterisk as well.



Press the «Search» softkey in order to reach the search mask of the alibi memory. With this function, you can define search criteria that will serve as a basis for searching entries. Press the «Change» softkey and select the desired search criteria. There are two steps to follow when entering search criteria: First the "From Border" should be entered and then afterwards the "To Border". The search criteria "Scale" and "Auxiliary Field" does not give out any information regarding "From/To".

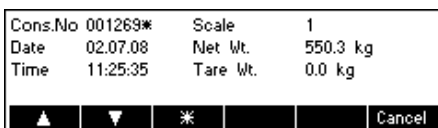

Press the «Details» softkey in order to reach the detail mask. It represents the alibi data of the chosen entries located on the side of the screen. This can be printed out.

5 Vision setup

Vision Setup can be used to change the settings of the terminal and to activate functions, thereby allowing the terminal to be adapted to individual weighing needs.

Important: To avoid incorrect operation of the weighing system in normal use, Vision Setup can be protected with a password. The terminal differentiates between a user and a supervisor. When the terminal leaves the factory, the entire menu can be accessed by both user and supervisor. **We therefore recommend you to define your own supervisor password as soon as you set up the terminal (5.3.3).** This limits access by the user to a smaller number of menu items (calibration, and settings for energy-saving mode, as well as date and time).

5.1 Overview and operation

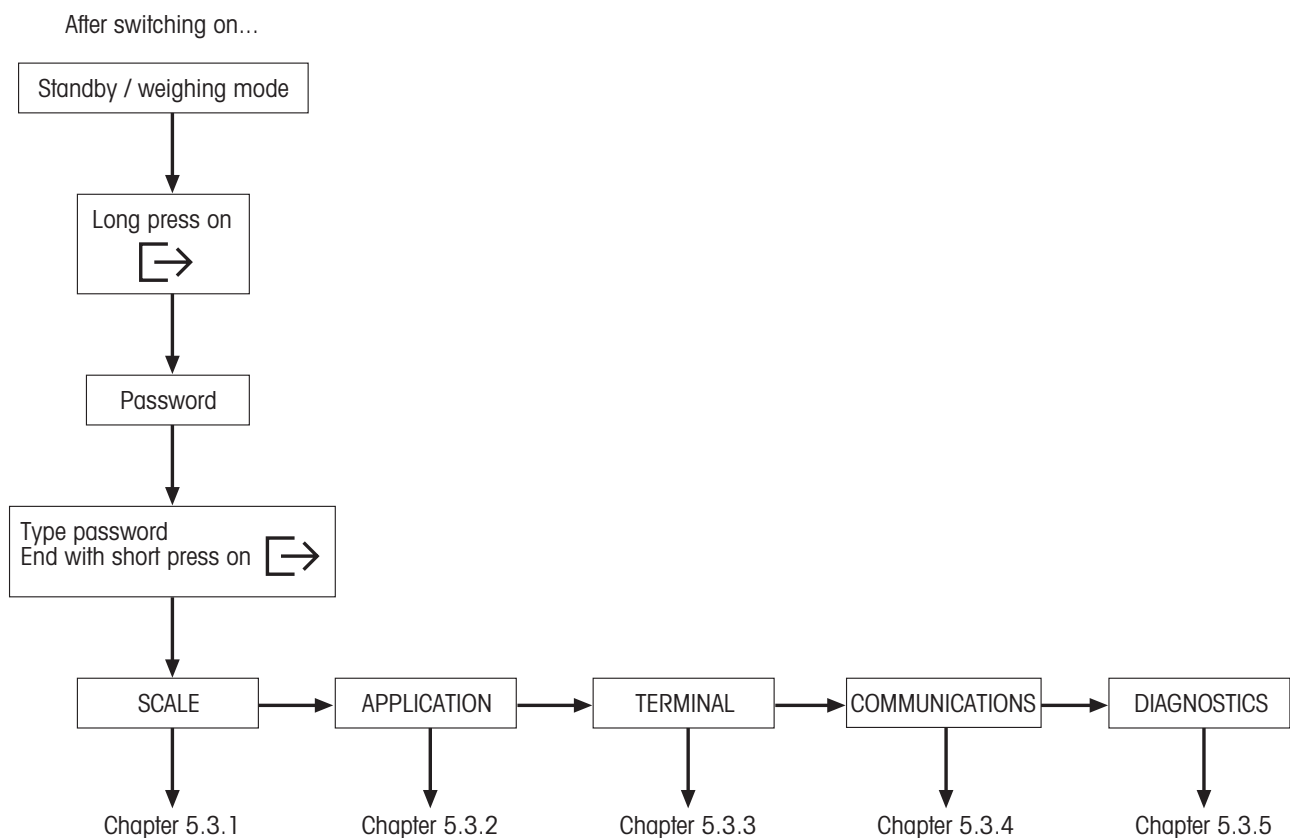

Navigating through the Vision Menu is done through the six softkeys found at the bottom of the display. The softkeys change depending on the currently selected menu item to allow the user to perform the appropriate action for the selected item.



This key selects the previous item listed on the current menu.



This key selects the next item listed on the current menu.



This key selects the first item on the next "page" of the menu. If all the items for the current menu are visible (i.e. there are four or less items for the current menu), this key is not visible.

>>

This key enters the submenu of the currently selected item. If the currently selected item does not have a submenu, this key is not visible.

Up

This key leaves the current submenu and goes one level up. If the Vision Menu is already at the top level, pressing this key is similar to pressing «**End**» (see below).

Edit

This key allows the user to edit the value or setting of the currently selected item. If the currently selected item contains a submenu, this key is not visible.

Yes

Some menu items perform specific actions rather than editing. Pressing this key directs the Vision Menu to perform the action specified by the currently selected menu item.

End

This key can be pressed at any time to leave the Vision Menu. The Vision Menu will then prompt the user to save or discard the changes the user has made. The user may also press «**Cancel**» at this time to go back to the Vision Menu.

i

This key allows the user to get an overview of the current location within the Vision Menu structure.

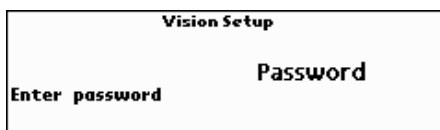

5.2 Calling up the menu and entering the password



Press the «» key and hold it down until the prompt to enter the password appears.



User: No password required, just press the «» key.

Supervisor: Enter password (sequence of keystrokes, 5.7) **immediately** and confirm with the «» key. Otherwise after a few seconds the terminal returns to weighing mode. If an incorrect password is entered, the menu cannot be called up. **Note:** When the terminal leaves the factory, no supervisor password is defined, so when the password is requested, just press the «» key.

5.3 Menu overview

5.3.1 Scale

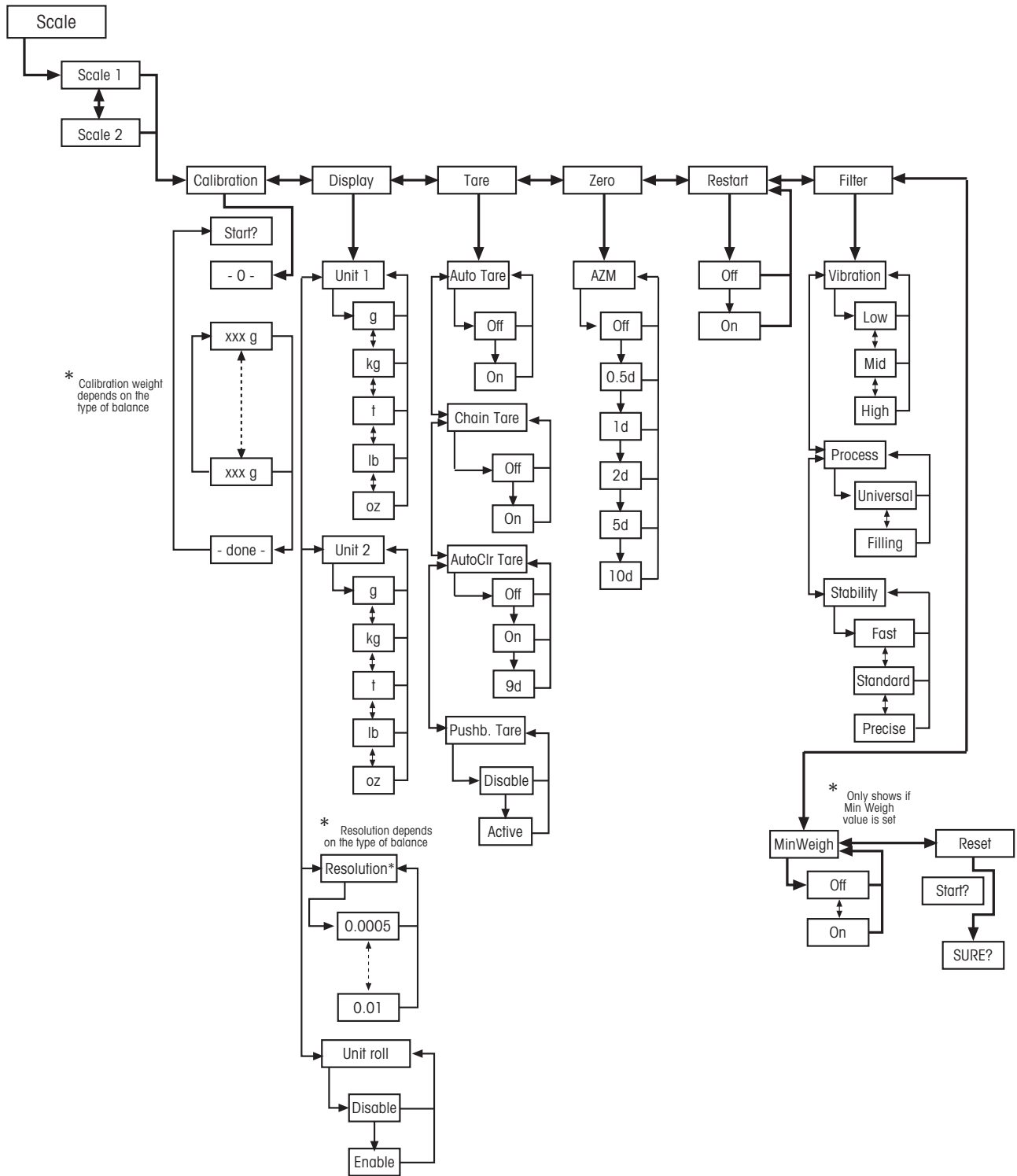

5.3.2 Application

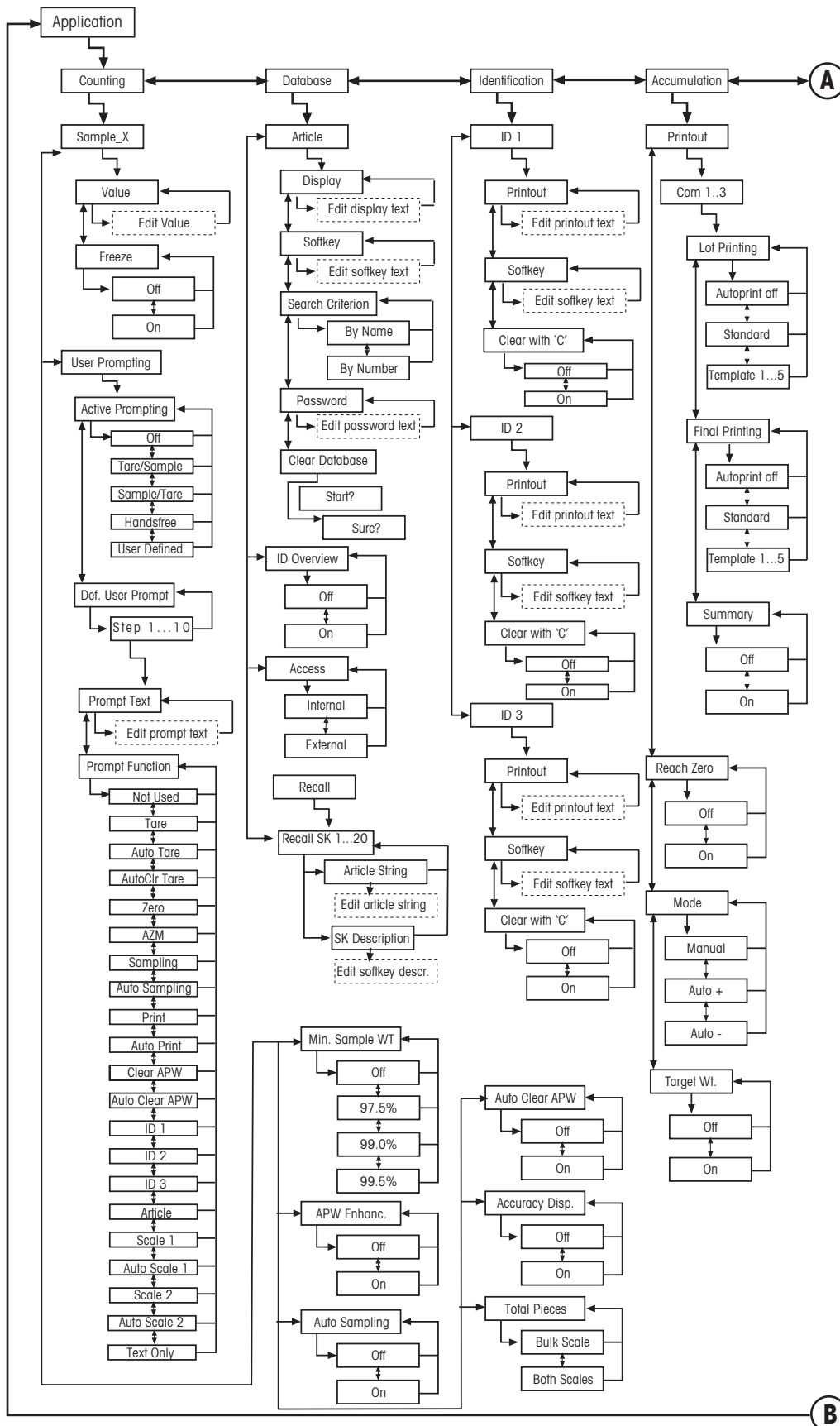

Applications continued....

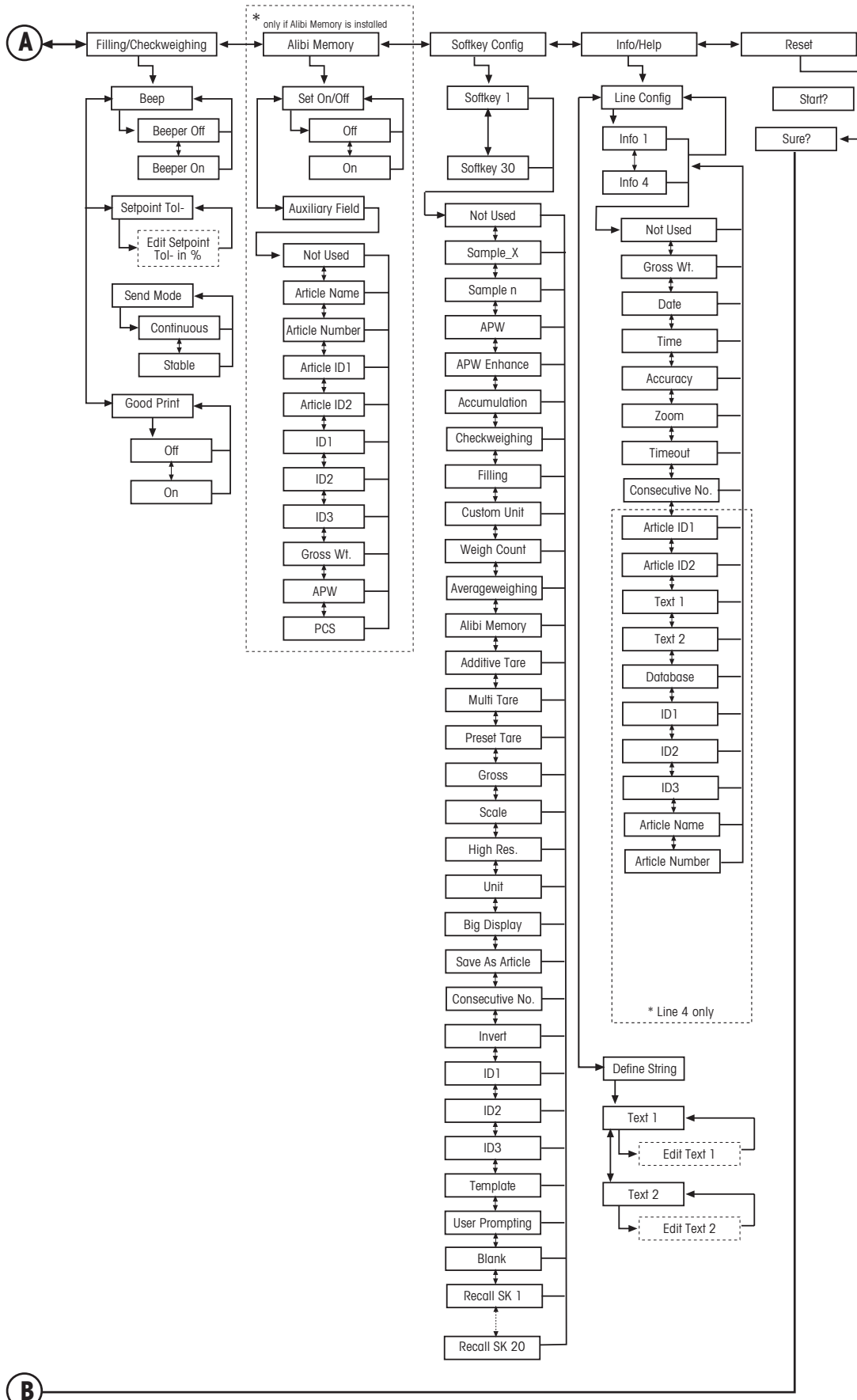

5.3.3 Terminal

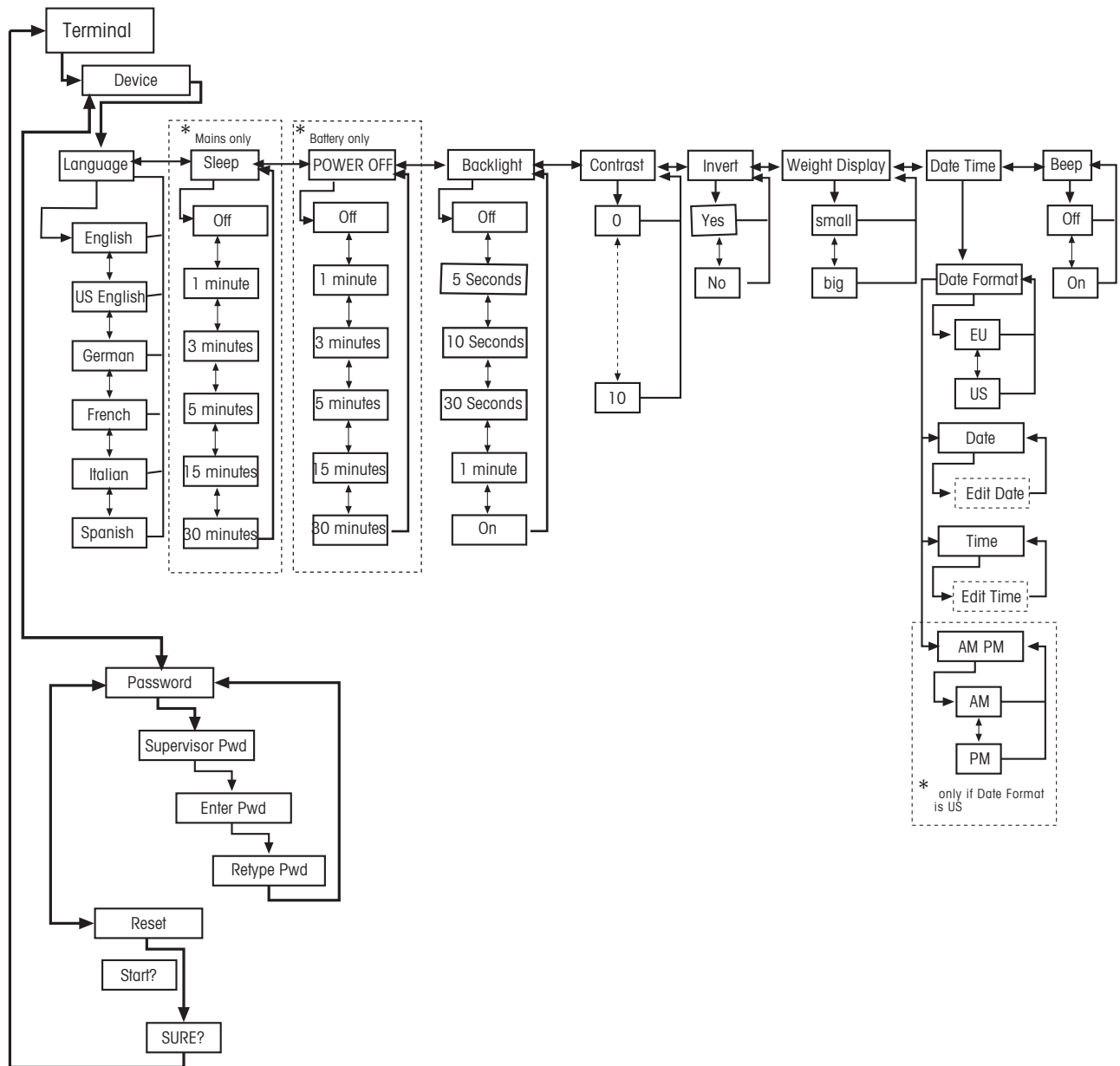

5.3.4 Communications

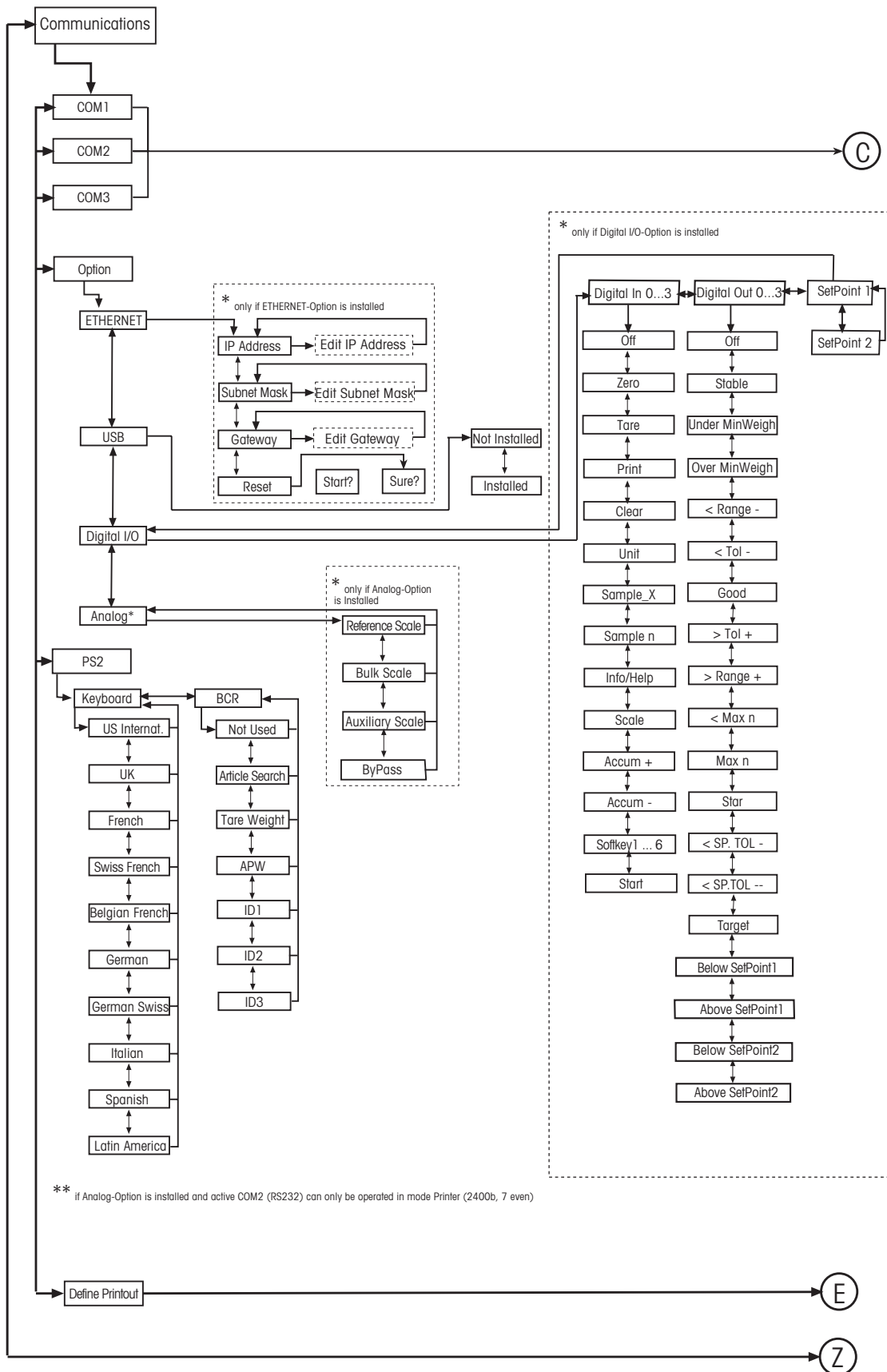

Communications continued...

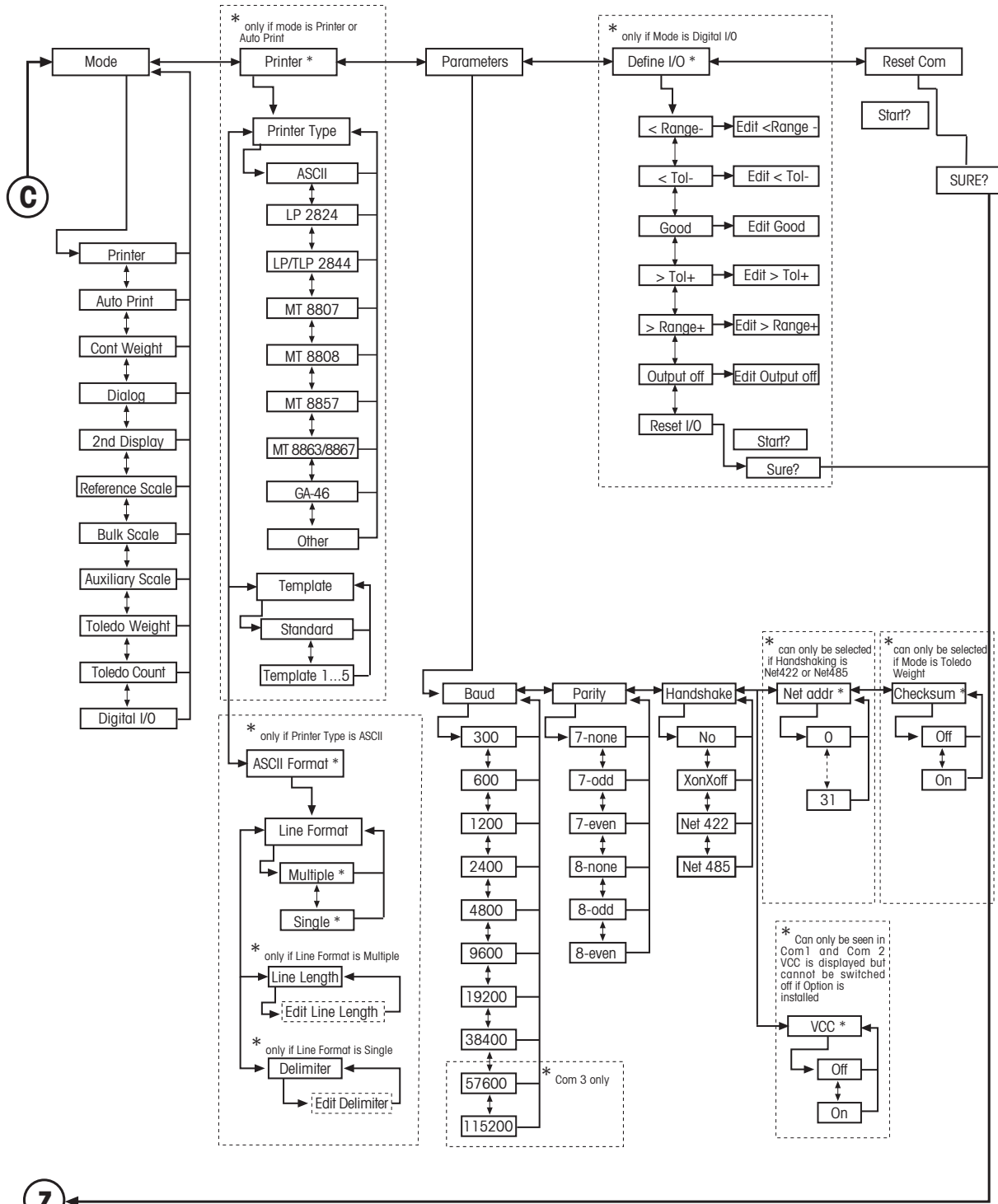

Communications continued...

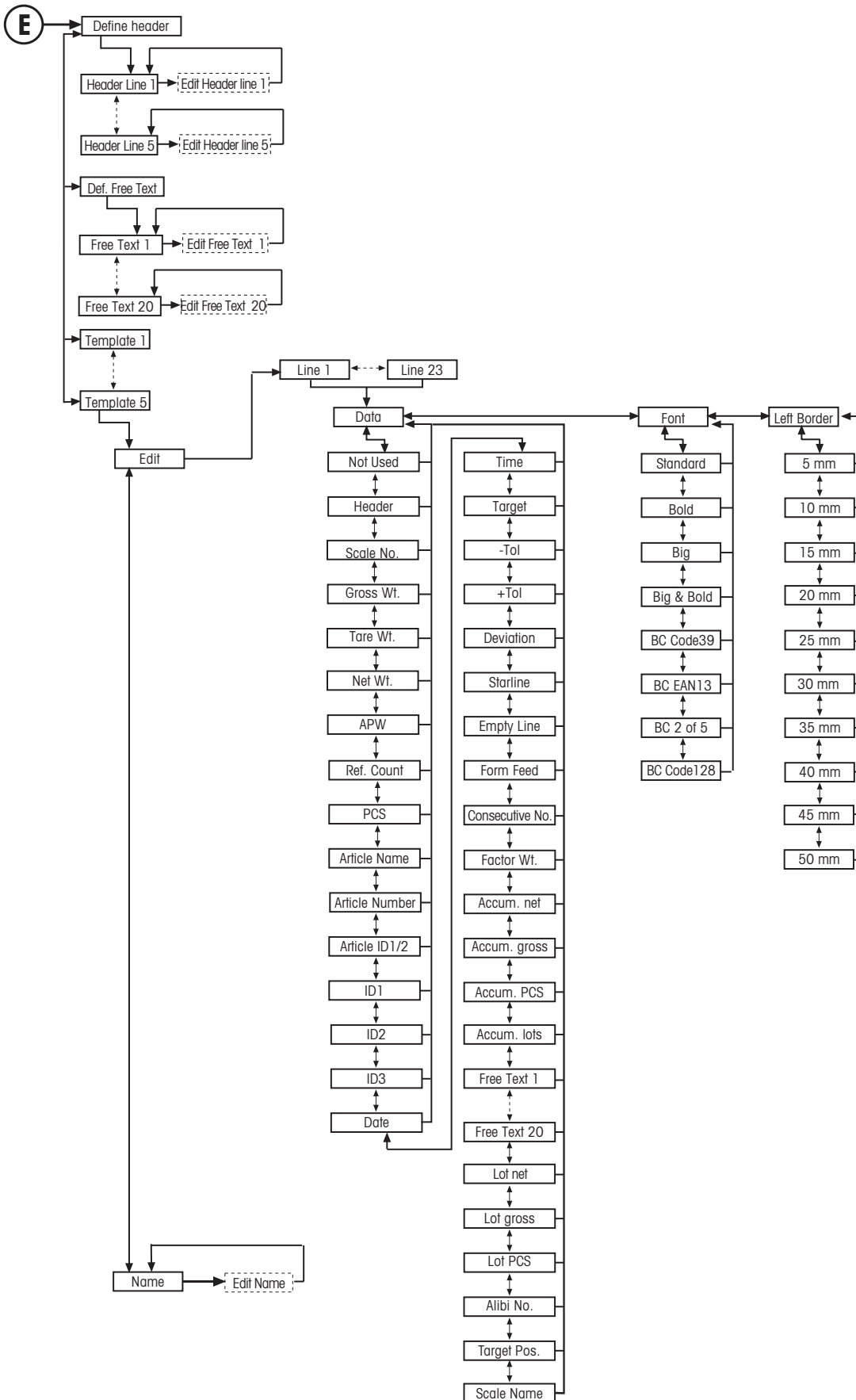

5.4.1 Adjust/calibrate (SCALE → Calibration)

This function enables the scale to be adjusted/calibrated (weighing pan must be empty). **Not available on certified scales!**

Please refer to Chapter 5.3.1 on how to reach the menu position 'Vision Setup → SCALE → Calibration' and how to navigate within the 'Vision Setup'-menu.



Press «Yes» and follow the instructions given on the screen.

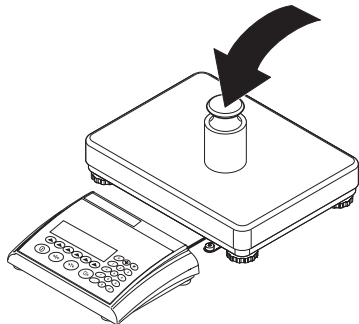

After choosing the calibration weight, place the weight on the weighing pan and then press the «OK» soffkey.

It is recommended to use the maximum calibration weight from the list. If it is not possible to use the maximum weight, at least do not use less than one-third of the maximum load to ensure reliable weighing values.



Calibration is done. Continue with other functions or press «End» and confirm with the «Yes» soffkey to save the changes.

Note: Abort calibration at any given time by pressing the «Cancel» soffkey.

Note: Scales with an internal calibration weight are automatically calibrated.

5.4.2 Display resolution and weighing unit (SCALE → Display)

This function allows the user to change the weighing unit, to add a second unit (to switch between Unit 1 and Unit 2, a soffkey 'Unit' has to be configured in 'Vision Setup → APPLICATION → Soffkey Config.')

and to set the resolution of the weight (always Unit 1). Please refer to Chapter 5.3.1 on how to reach the menu position 'Vision Setup → SCALE → Display' and how to navigate within the 'Vision Setup'-menu.

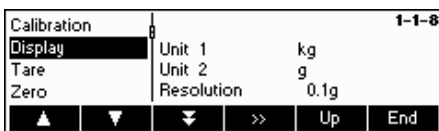

Press «>>» and select e.g. "Unit 1", then «Edit» to change the unit.

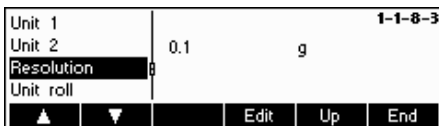

In order to change the settings of the resolution of the scale, select "Resolution" (this function is not available on all models).



Use the «▲» and «▼» soffkeys to select the desired resolution and press the «OK» soffkey.

5.4.3 Tare settings (SCALE → Tare)

This function allows the user to configure all the available tare function of the scale.

Please refer to Chapter 5.3.1 on how to reach the menu position 'Vision Setup → SCALE → Tare' and how to navigate within the 'Vision Setup'-menu.



Switch the available functions **Auto Tare**, **Chain Tare**, **AutoClr Tare** or **Pushb. Tare** either On or Off.

Automatic tare automatically tares the scale once a load ($\geq 9d$) is placed on the weighing pan. If this is active, the icon AT flashes on the lower right side of the display.

Chain tare allows several tare actions without clearing the tare memory. If this is not active, the tare memory has to be cleared by pressing the «C» softkey. The tare memory has to be cleared before a new tare can be performed.

Automatic clear tare automatically clears the tare memory once the load is removed from the weighing pan. Possible Settings: On, Off and 9d

Push button tare enables/disables the use of the «→T←» key to perform manual taring.

5.4.4 Automatic zero point correction (SCALE → Zero)

With Auto Zero, small deviations in the weight (in the range of 50% of 1d) are automatically zeroed. On certified scales this menu item does not appear.

Please refer to Chapter 5.3.1 on how to reach the menu position 'Vision Setup → SCALE → Zero' and how to navigate within the 'Vision Setup'-menu.



Press «>>>» to go to the Auto Zero settings.

Press «Edit» to assign the zero setting range or to switch the function off.



You can select the following ranges: 0.5 d, 1 d, 2 d, 5 d, 10 d.

5.4.5 Automatic save of tare and zero values (SCALE → Restart)

This function allows the user to set the scale so that it is able to automatically save the tare and zero values after switching off or when a power outage occurs. **Not available on certified scales. Automatic save switched off is the factory setting.**

Block can only be accessed by a supervisor.

Please refer to Chapter 5.2 on how to reach the menu position 'Vision Setup → SCALE → Restart' and how to navigate within the 'Vision Setup'-menu.



Press «Edit» to switch the automatic save switch function on or off.

5.4.6 Adaptation to environmental conditions and weighing mode (SCALE → Filter)

Vibration function allows the user to set the scale so that it is able to adapt itself to the existing environmental conditions.

Process function allows the user to set the weighing mode of the scale (weighing process adapter).

Stability function allows the user to adjust the weighing speed.

Please refer to Chapter 5.3.1 on how to reach the menu position 'Vision Setup → SCALE → Filter' and how to navigate within the 'Vision Setup'-menu.



Press «>>» to go to the vibration and process settings menu.

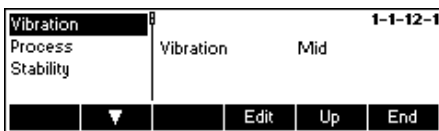

Vibration:

Low: For very stable and stable environment. Scale operates very quickly but is more sensitive to external influences.

Mild: For normal environment conditions. Scale operates at medium speed (**factory setting**).

High: For unstable environment. Scale operates more slowly but is less sensitive to external influences.

Process:

Universal: Setting for all weighing types and normal weighing goods (**factory setting**).

Filling: Setting for dispensing liquids or powdery substances.

Stability:

Fast: The scale operates very fast.

Standard: The scale operates at medium speed.

Precise: The scale operates with the greatest possible reproducibility.

The slower the scale works, the greater the reproducibility.

5.4.7 Minimum weight (SCALE → Min Weigh)

Min Weigh function allows the user to switch the minimum weight on and off. If the weight on the scale falls below the stored minimum value, an * appears on the display in front of the weight indicator. This menu item only appears if the service technician has saved a minimum weight.

Please refer to Chapter 5.3.1 on how to reach the menu position 'Vision Setup → SCALE → Min Weigh' and how to navigate within the 'Vision Setup'-menu.



- Press «>>» to go to the Min Weigh settings.

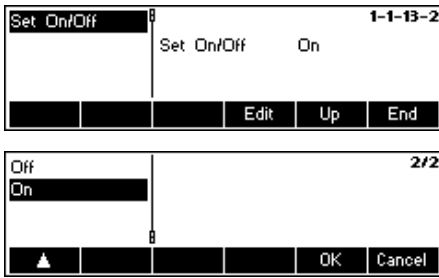

- Press «**Edit**» to switch the minimum weight monitoring on/off.

5.4.8 Resetting scale to factory default settings (SCALE → Reset)

This function resets the 'SCALE' block to its original factory settings.

Please refer to Chapter 5.3.1 on how to reach the menu position 'Vision Setup → SCALE → Reset' and how to navigate within the 'Vision Setup'-menu.



Press «**Yes**» to reset the scale settings. 'SURE?' will appear, press «**Yes**» to confirm. The scale settings are now reset to its original factory settings.

5.5 Application settings (APPLICATION)

This function block allows the user to change the count application specific settings of the scale.

Please refer to Chapter 5.3.2 on how to reach the menu position 'Vision Setup → APPLICATION' and how to navigate within the 'Vision Setup'-menu.

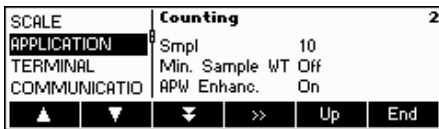

Enter the APPLICATION menu («**>>>**») and choose one of the functions listed below.

Available functions and settings:

- Settings for piece counting → Chapter 5.5.1
- Database → Chapter 5.5.2
- Identification → Chapter 5.5.3
- Settings for accumulation → Chapter 5.5.4
- Settings for filling/checkweighing → Chapter 5.5.5
- Settings for the (optional) alibi memory → Chapter 5.5.6
- Settings for softkey configuration → Chapter 5.5.7
- Info/Help → Chapter 5.5.8
- Reset 'APPLICATION' settings to factory settings → Chapter 5.5.9

The screen shows the most important application settings as a preview.



The screen shows a preview of the most important settings of the active item, e.g. those of counting if 'Counting' is active (i.e. highlighted).

5.5.1 Settings for piece counting (APPLICATION → Counting)

The Sample_X parameter determines the amount of pieces used to get the average piece weight.

Please refer to Chapter 5.3.2 on how to reach the menu position 'Vision Setup → APPLICATION → Counting' and how to navigate within the 'Vision Setup'-menu.



Press «>>» to change the settings into the desired number of pieces or to freeze the actual setting of the Smpl X value.



Choose "Value" and press «Edit» to change the settings of the actual value of Smpl X. After the Smpl X has been changed, the number of references in the main menu changes accordingly (e.g. 'Smpl 10').



Choose "Freeze" and press «Edit». If this function is set to "On", it is no longer possible to change the value of Smpl X in Short Input Mode.



User Prompting

This function defines whether a user will be guided actively and step-by-step through his operating procedure or not. The choice is either to use one of the predefined user prompting procedures or to define an own one. During predefined procedures, the bar graph toggles with the user prompts.



By default, 'Active Prompting' is switched off, thus the operator is free to define his own tasks.

The choice of predefined user prompting procedures:

- Tare/Sample With this setting, IND465 will guide the user through the counting procedure using the Tare -> Sample method.
- Sample/Tare With this setting, IND465 will guide the user through the counting procedure using the Sample -> Tare method.
- Handsfree With this setting, IND465 will guide the user through the counting procedure and will automatically tare the scale so that the user does not have to press the «→T←» key.
- User defined This function allows the user to choose his own defined user prompting. The prompts need to be defined with 'Def. User Prompt'.

Note: User prompting should **not** be used in 2-scale counting.



User-defined User Prompting: (Def. User Prompt)

The defined user prompting allows the supervisor to define a specific flow process. The user, with the aid of the defined working steps, can work through a complete flow process.

"Def. User Prompt" function allows the user to define a step-by-step flow process. Afterwards, choose "Step 1". A text can now be entered for the user (working instructions) and the corresponding function can be defined.

Example:

- Step 1:
 - User Text → Place the container on the scale
 - User Function → Auto Tare (scale will automatically be tared)
- Step 2:
 - User Text → Place the container on the scale
 - User Function → Auto Print (Protocol will automatically be printed)



Functions:

Not used	→ no function
Tare	→ Scale is waiting for the entry of a tare value
Auto Tare	→ tares the scale automatically once a load is placed on the weighing pan
AutoClr. Tare	→ clears the tare memory automatically once the weight goes back to Zero +/-9d
Zero	→ Scale is waiting for zero setting
Auto Zero	→ small deviations in the weight are automatically zeroed
Reference	→ Scale is waiting for the entry of a tare value
Auto Reference	→ reference determination is automatically performed
Print	→ Scale is waiting for pressing the "Print-key"
Auto Print	→ Automatic printing of stable weights
Clear APW	→ average piece weight is cleared once the weight is back to Zero +/-9d
Auto Clear APW	→ average piece weight is automatically cleared once the weight is back to Zero +/-9d
ID1...3	→ Scale expects entry of a tare value
Article	→ Scale is waiting for the entry of an article of the database
Scale X	→ Scale is waiting for switching to scale X (X=1 or 2)
Auto Scale X	→ Scale is switching automatically to scale X (X=1 or 2)
Text only	→ Shows only an entered text. Continuing with „↑“ – Key

Note: In 2-scale operation, the user prompting function is only available if it is set to "Auxiliary Scale"

Prompt Text	
Prompt Function	
	▼ Edit Up End

Sample_X		2-1-3
User Prompting	Min. Sample WT Off	
Min. Sample WT		
APW Enhanc.		
	▼ Edit Up End	

Minimum Sample Weight

This setting controls the limits for reference weight determination. If this function is active, the relative accuracy of the APW (see accuracy display) must be greater than the value selected. Otherwise, the user will be prompted to add more pieces to increase the value of the accuracy of the APW.



APW Enhancement. See also Chapter 4.3 "Reference Optimization".

Activate automatic reference optimization by choosing "On" or deactivate by choosing "Off".



Auto Sampling

With this set to on, reference determination is automatically performed once load is placed on the scale without the user having to press the Sample_X softkey.

Activate auto sampling by choosing "On" or deactivate by choosing "Off".

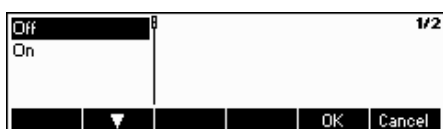

Automatic Clear Average Piece Weight

With this set to on, the average piece weight is automatically cleared once the load is removed from the scale without the user having to press the «C» softkey.

Activate automatic clear average piece weight by choosing "On" or deactivate by choosing "Off".

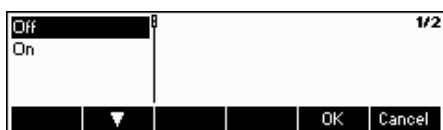

Accuracy Display

This function enables the display of the percentage accuracy. With this function set to "On", the percentage accuracy will be displayed for approximately 4 seconds on the 4th Info line after a sample weight determination.

Activate accuracy display by choosing "On" or deactivate by choosing "Off".



Total Pieces

This function allows the user to have the pieces loaded on the reference scale automatically added to those loaded on the bulk scale: Select 'Both scales' and the pieces that were used to determine the reference will be added.

If 'Bulk scale' is selected (default) then only the pieces situated on the bulk scale will be shown.



5.5.2 Settings for database (APPLICATION → Database)

The following illustrates the possible settings for the database.

Please refer to Chapter 5.3.2 on how to reach the menu position 'Vision Setup → APPLICATION → Database' and how to navigate within the 'Vision Setup'-menu.



Press «**→**» to go to database settings menu. Select the item that you wish to modify by using the «**▲**» and «**▼**» softkeys. When the desired item is highlighted, press «**→**» to modify the item.



Article - This submenu allows you to define and change different article strings in the Database settings.



The following settings can be configured:

Display - Define the text that appears as a heading on the display.

Function keys - Define the text of the function key in the menu list, in which the article database can be opened or the selected ID can be edited.

Search criterion - Set the field that will be used for searching, scrolling, and sorting of the list of articles in the database. It could either be by name or by number.

Password - Password-protect the article database from being modified.



Note: Press the «**Erase**» softkey to clear the existing text and type the desired text using the keypad. Press the «**→**» and «**←**» keys to move cursor from left to right and vice-versa. Press «**OK**» when input is done. To deactivate the ID's, make their "Softkey" text blank (i.e. Press «**Erase**» then accept the empty text by pressing «**OK**»).



ID overview - If this function is turned "On", you can directly call up the IDs using the Database key.
- If this function is turned "Off", you are directly led to the Database menu once the Database key is pressed.



Access - If this function is set to "Intern", BBA462 / BBK462 considers only its own Database.
- If this function is set to "Extern", an external Database will be asked. In this case, BBA462 / BBK462's own internal Database will not be considered. This is the case if the BBA462 / BBK462 is in "Host-Mode" and functions as a satellite.



Recall - This function allows recalling of an article directly from the database via a softkey. This means a previously defined article can be loaded by pushing one key

In total there are up to 20 softkeys available to which articles can be assigned.



The article number or name of the corresponding database article has to be entered under "Article String"



How the softkey is named in the display is defined under the position "SK Description"

5.5.3 Identification (APPLICATION → Identification)

For article-independent identification purposes. If a text for the ID's is entered, the entered text will be displayed printed out.

Please refer to Chapter 5.3.2 on how to reach the menu position 'Vision Setup → APPLICATION → Identification' and how to navigate within the 'Vision Setup'-menu.



Press «>>>» to go to Identification settings menu.

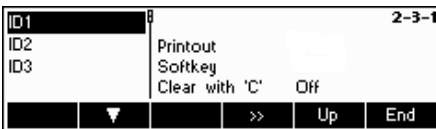

Choose the ID to be edited and press «>>>».



Choose "Print" and press the «Edit» softkey. Then, enter the intended text to be printed out.

Choose the "Function key" and press the «Edit» softkey in order to generate the text for the function key (See Chapter 5.5.7).

Please adjust "Clear with C" to "Off" if you do **not** want to clear automatically the contents of the ID by the C-key, respectively adjust it to "ON" if you also want to clear automatically the ID-contents when pressing the C-key .

5.5.4 Settings for accumulation (APPLICATION → Accumulation)

These settings define the configuration/print-out of the accumulation function.

Please refer to Chapter 5.3.2 on how to reach the menu position 'Vision Setup → APPLICATION → Accumulation' and how to navigate within the 'Vision Setup'-menu.

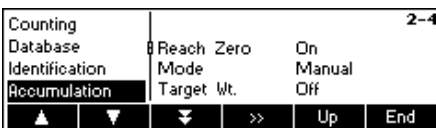

Press «>>>» to go to Accumulation settings menu.



- Printout - This function allows you to specify whether or not an automatic printout in the "Accumulation" application will be generated.
- Zero stable - This function allows you to specify whether or not the scale should first find a stable zero-point when a load is removed from the scale, before continuing with the Accumulation application.
- Mode - This function allows you to define, whether to accept the registration of the weight manually or automatically. Confirm manually by using the «+» or «-» keys.
- Target Wt - Here is defined if you just accumulate or to a certain target weight which has to be defined for each article separately in the database (see Chapter 3.2.2)



If you choose the position "Printout", you can also specify an interface for your printout in this function.



Lot Printing - This function allows you to define whether an automatic printout should follow after every registration of value and to specify also the type of format for the printout, or whether or not every single batch should be printed out.

Final Printing - This function allows you to define whether an automatic printout should follow at the end of the Accumulation application and to specify also the type of format for the printout, or if no automatic printout should follow at all.

Summary - If this function is active, all single batches will additionally be printed out after the Total print.



This function allows you to use a specific format for each of your printouts.

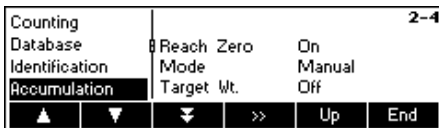

Choose "Mode" in order to define the mode of the Accumulation application.



Manual - Perform the accumulation manually by confirming with the «+» or «-» key.

Auto + - The scale adds automatically without confirming with the «+» key.

Auto - - The scale subtracts automatically without confirming with the «-» key.



If "Target Wt." is switched on while accumulating an article, the target weight defined in the database is used as the target value for the accumulation function. If "Target Wt." is switched off the target weight defined in the database will only be used for checkweighing purposes. Used in combination with the accumulation application, good parts (parts within tolerances) can be accumulated. This means that, within the accumulation, all articles first will be checked according to their target values.

5.5.5 Settings for filling/checkweighing (APPLICATION → Filling/Checkweighing)

This setting controls the use of the built-in beeper, setpoint tolerance and sender mode during the Checkweighing (+/-) and Filling functions.

Please refer to Chapter 5.3.2 on how to reach the menu position 'Vision Setup → APPLICATION → Filling/Checkweighing' and how to navigate within the 'Vision Setup'-menu.



Choose "Filling/Checkw." and press «>>» to go to the Filling/Checkweighing menu.

Beeper - If the Beeper is set to "On", there will be a short beep when the current load is within the target range.

Setpoint Tol- - Defines the value where the I/O Relay-Interface should become activated. The percentage value to be entered is meant to be relative to the value Tol-.

Example: Target: 2000g
 Tol+: 2010g
 Tol-: 1990g
 Setpoint Tol-: 10%

⇒ The I/O-relay box will only be activated when the value reaches 199g (19% of 1990 g)

Send Mode Specify the form of data that the connected I/O-relay box receives from the scale. If it is set to "Continuous", the data will be sent constantly. If it is set to "Stable", the data will only be sent if the weight value is stable.

Note: Checking the SP.Tol-- is carried out with the gross weight, for SP.Tol- with the net weight. SP.Tol- is dependent on SP.Tol--; in other words, if SP.Tol-- has not yet been reached, the SP.Tol- output will not go active. If both setpoints are used, the SP.Tol-- must be less than SP.Tol-.

5.5.6 Settings for the (optional) alibi memory -> APPLICATION-> alibi memory

In this menu block you can define the settings for the optional alibi memory. Please refer to Chapter 5.3.2 on how to reach the menu position "Vision Setup->Application->Alibi memory" and how to navigate within the "Vision Setup"-menu.



Select "on" or "off" for activating/deactivating the alibi memory. Apart from the mandatory fields one additional field for additional data can be defined. 150.000 weighings can be memorized in total.

5.5.7 Settings for softkey configuration (APPLICATION → Softkey Configuration)

This function configures the task of each softkey in the main display. There are a maximum of 30 definable softkeys, each of which can be configured to perform various applications and shortcuts to some scale operations.

Please refer to Chapter 5.3.2 on how to reach the menu position 'Vision Setup → APPLICATION → Softkey Configuration' and how to navigate within the 'Vision Setup'-menu.



Press «>>>» to go to Softkey Configuration settings menu.



Select the desired softkey that is to be defined and press «Edit» to designate its function. It is possible to define up to 30 softkeys.

Note: It is possible to insert a Softkey with the ↑ - key



Use the «▲» and «▲» softkeys to select the desired function of the softkey, then press «OK».

Each softkey can be configured to any of the following functions:

Not Used Select "Not Used" to indicate the last visible softkey. Softkeys with designated functions but are past the softkey set to "Not Used" will not be visible in the main display.

60

Sample_X	Show the « Smpl X » softkey where X is the reference number of pieces to use for average piece weight determination. The value for X can be defined in 'Vision Setup → APPLICATION → Counting → Ref X' (Chapter 5.5.1) or in Short Input Mode (Chapter 3.1)
Sample n	Show the « Smpl n » softkey. With this softkey it is possible to select the reference number of pieces to use for average piece weight determination.
APW	Show the « APW » softkey which is used to enter a pre-defined Average Piece Weight.
APW Enhance	Show the « APWEnh » softkey which is used to perform a manual reference optimization (Chapter 4.3).
Accumulation	Show the « Accum » softkey which is be used to start the Accumulation application (Chapter 4.7).
Checkweighing	Show the « +/- » softkey which is used to start the Checkweighing application (Chapter 4.10).
Filling	Show the « Filling » softkey which is used to start the Filling application (4.9).
Custom Unit	Show the « CU » softkey which is used to start the Custom Unit application (Chapter 4.11).
Weigh Count	Show the « Weigh » (if scale is in piece counting mode) or « Count » (if scale is in weighing mode) softkey which is used to toggle the scale to weighing mode and piece counting mode respectively. Note: If there is no average piece weight active, it will not be possible to switch modes so this softkey will not be visible even if it is configured.
Averageweighing	Show the « Average » softkey which is used to start the Average Weighing application (Chapter 4.12).
Alibi Memory	Show the « Alibi » softkey which is used to start the Alibi memory application (Chapter 4.13).
Additive Tare	Show the « AddTare » softkey which is used to add the current weight on the scale to the tare weight memory.
Multi Tare	Show the « MulTare » softkey. With this softkey, it is possible to enter the number of containers and the pre-determined tare weight of 1 container. IND465 will automatically calculate the cumulative tare weight of the multiple containers.
Preset Tare	Show the « PT » softkey which is used to enter a pre-defined tare weight.
Gross	Show the « Gross » softkey which is used to show the gross weight on the main weight display.
Scale	Show the « ↕ » softkey which is used to toggle the weight source during 2-scale operations (Chapter 4.6). Note: This softkey will only be visible if 2-scale operations are possible. That means one of the interfaces must be set to a mode of "Reference Scale", "Bulk Scale", or "Auxiliary Scale" (Chapter 5.9.1).
High Res.	Show the « HighRes » softkey which is used to display the net weight at a higher resolution.
Unit	Show the « Unit » softkey which is used to toggle the weight display between Unit1 and Unit2. Note: This softkey will only be visible if Unit1 and Unit2 (Chapter 5.4.2) are not the same.
Big Display	Show the « BigDis » softkey which is used to toggle the display between a large-font weight display and the normal weight display.
Save As Article	Show the « SaveAs » softkey. With this softkey, it is possible to save the current state of the applications into a new article.
Consecutive No	Show the « CNo » softkey. With this softkey, it is possible to edit the Consecutive Number which is incremented after every printout.

Invert	Show the « Invert » softkey which is used to invert the LCD display (Chapter 5.6.3).
ID 1	Show the « ID 1 » softkey. You can rename this softkey under "Function key" in "Vision Setup → Application → Identification → ID 1". You can directly enter data by confirming with this key.
ID 2	Show the « ID 2 » softkey. You can rename this softkey under "Function key" in "Vision Setup → Application → Identification → ID 2". You can directly enter data by confirming with this key.
ID 3	Show the « ID 3 » softkey. You can rename this softkey under "Function key" in "Vision Setup → Application → Identification → ID 3". You can directly enter data by confirming with this key.
Template	Show the « Template » softkey, which is used to directly access your defined template, and to assign the necessary data interface.
User Prompting	Show the « Prompt. » softkey to be able to reach the user-defined User Prompting menu.
Recall SK 1...20	Allows a direct access to an article without entering the database
Blank	Show a blank softkey.

5.5.8 Settings for Info/Help (APPLICATION → Info/Help)

This function configures the contents of the four Info lines located at the left side of the main display. The info lines can be accessed by pressing the «**i**» key while in the main display.

Please refer to Chapter 5.3.2 on how to reach the menu position 'Vision Setup → APPLICATION → Info/Help' and how to navigate within the 'Vision Setup'-menu.



Press the «**i**» softkey to go to the "Info/Help" application.

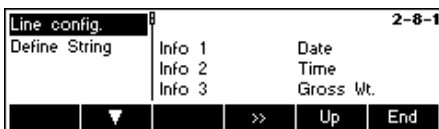

Choose "Line Config." and then press the «**i**» softkey to enter the list of available Info that can be designated for each Info line.



Configuration of the four Info lines:

Each of the first three Info lines can be configured to display any of the following information:

62



Each Info line can be configured to display any of the following information:

Not Used	Display a blank Info line.
Gross Wt.	Display the gross weight.
Date	Display the date.
Time	Display the time.
Accuracy	Display the percentage accuracy. This line will only be displayed if a reference weight determination has been performed.
Zoom	Display the net weight at a higher resolution.
Timeout	Display the timeout status.
Consecutive No.	Display the current value of the Consecutive Number.



Choose "Define String" and press the «>>» softkey to enter a text that you can define freely in "Text 1" and "Text 2", which can then be displayed on the fourth Info Line.

Aside from the above information that is already given, a **fourth line** that contains further information can be added and displayed.

Article ID 1	For article-dependent identification purposes that refers only to this article.
Article ID 2	For article-dependent identification purposes that refers only to this article.
Text 1	Text 1 that will be entered in "Define String → Text 1"
Text 2	Text 2 that will be entered in "Define String → Text 2"
Database	Capacity of the Database memory. <u>Example:</u> 4/1613 – 0.25% - There are 4 defined articles out of the 1613 articles. - The memory is using 25% of its capacity.
ID 1	For article-independent identification purposes.
ID 2	For article-independent identification purposes.
ID 3	For article-independent identification purposes.
Article Name	Name of selected article
Article Number	Number of selected article

5.5.9 Settings for reset (APPLICATION → Reset)

This function resets the 'APPLICATION' block to its original factory settings.

Please refer to Chapter 5.3.2 on how to reach the menu position 'Vision Setup → APPLICATION → Reset' and how to navigate within the 'Vision Setup'-menu.



Press «**Yes**» to reset the application settings. 'SURE?' will appear, press «**Yes**» to confirm. The application settings are now reset to its original factory settings.

5.6 Terminal settings for device (TERMINAL → Device)

This function block allows the user to change display and peripheral oriented settings of the scale. If access is blocked by a Supervisor Password (as discussed in 5.2), the user will be able to access only the menu "Device".

Please refer to Chapter 5.3.3 on how to reach the menu position 'Vision Setup → TERMINAL → Device' and how to navigate within the 'Vision Setup'-menu.



Enter the TERMINAL menu («**»**») and choose one of the functions listed below.

Available functions and settings:

The screen shows the most important terminal settings as a preview.

- Language settings → Chapter 5.6.1
- Sleep function → Chapter 5.6.2
- Contrast → Chapter 5.6.3
- Invert → Chapter 5.6.4
- Weight display → Chapter 5.6.5
- Date and time → Chapter 5.6.6
- Beep → Chapter 5.6.7



The screen shows a preview of the most important settings of the active item, e.g. those of device if 'Device' is active (i.e. highlighted).

5.6.1 Language settings (TERMINAL → Device → Language)

This function allows the user to change the language settings of the scale.

Please refer to Chapter 5.3.3 on how to reach the menu position 'Vision Setup → TERMINAL → Device → Language' and how to navigate within the 'Vision Setup'-menu.



Press the «**Edit**» softkey to go to the Language settings menu.



Use the «**▲**» and «**▼**» softkeys to select the desired language setting and press «**OK**».

5.6.2 Sleep function (TERMINAL → Device → Sleep)

When the scale is deriving its power only from a battery and is not plugged in an electrical outlet, this function is especially useful in order to conserve power.

Please refer to Chapter 5.3.3 on how to reach the menu position 'Vision Setup → TERMINAL → Device → Sleep' and how to navigate within the 'Vision Setup'-menu.



Press the «**Edit**» softkey to go to the Sleep settings menu.



The scale will turn itself off automatically when the selected time elapses.

5.6.3 Adjusting the contrast of the display (TERMINAL → Device → Contrast)

This function allows the user to adjust the contrast of the screen display.

Please refer to Chapter 5.3.3 on how to reach the menu position 'Vision Setup → TERMINAL → Device → Contrast' and how to navigate within the 'Vision Setup'-menu.



Press the «**Edit**» softkey to go to the Contrast settings menu.



Select the degree of contrast by scrolling the «**▲**» or «**▼**» softkey. Press «**OK**» to confirm selection.

5.6.4 Invert (TERMINAL → Device → Invert)

This function allows the user to select either a white or a black background of the screen display.

Please refer to Chapter 5.3.3 on how to reach the menu position 'Vision Setup → TERMINAL → Device → Invert' and how to navigate within the 'Vision Setup'-menu.



Press the «**Edit**» softkey to go to the Invert settings menu.

Choose the desired setting (Yes or No) and then press «**OK**» to confirm selection.

5.6.5 Changing the size of weight display (TERMINAL → Device → Weight display)

This function allows the user to select either a small or a big weight display on the screen.

Please refer to Chapter 5.3.3 on how to reach the menu position 'Vision Setup → TERMINAL → Device → Weight display' and how to navigate within the 'Vision Setup'-menu.



Press the «**Edit**» softkey to go to the Weight Display settings menu. Default setting is big.



Choose the desired size and then press «**OK**» to confirm selection.

Note: Changing the mode of the weight display with the «**BigDis**» softkey (Chapter 5.5.7) will not affect this setting. If the mode was changed with the «**BigDis**» softkey, the display will revert to this setting after switching the scale on or after leaving the Vision Setup.

5.6.6 Adjusting the date and time (TERMINAL → Device → Date Time)

This function allows the user to set date and time of the scale.

Please refer to Chapter 5.3.3 on how to reach the menu position 'Vision Setup → TERMINAL → Device → Date Time' and how to navigate within the 'Vision Setup'-menu.



Press the «**»** softkey to go to the Date and Time settings menu.

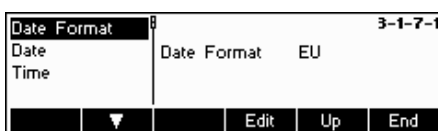

Press the «**Edit**» softkey to change format either from US or EU format. Select Date to change the date and Time to change the clock of the scale. Press «**OK**» to confirm selection.

5.6.7 Activating the beep (TERMINAL → Device → Beep)

This function allows the user to switch the beep on or off, that is appearing on each key press.

Please refer to Chapter 5.3.3 on how to reach the menu position 'Vision Setup → TERMINAL → Device → Beep' and how to navigate within the 'Vision Setup'-menu.



Press the «**Edit**» key to go to the Beep settings menu.

Choose the desired setting (On or Off) and then press «**OK**» to confirm selection.

5.7 Define supervisor password (TERMINAL → Access)

This function allows the user to change the supervisor password of the scale. Can only be accessed by a supervisor.

Please refer to Chapter 5.3.3 on how to reach the menu position 'Vision Setup → TERMINAL → Access' and how to navigate within the 'Vision Setup'-menu.



Press the «>>» softkey ...



... and then press the «Edit» softkey to enter a new password.



Enter the password using the keypad, press «Ok» to confirm. 'Retype Pwd' appears. Retype the new password and press «Ok» again.

If the password was forgotten, you may press «→0←», «→0←», «→0←», «» keys in sequence to access the Vision Setup.

Note: There is no defined Supervisor Password in the factory setting. In this case, the Supervisor Password and the User Password are the same.

If a Supervisor Password has been set, the User Password will only be able to access the menu "Terminal → Device". All other menu settings can only be accessed by the Supervisor.

5.8 Reset terminal settings to factory settings (TERMINAL → Reset)

This function resets the 'TERMINAL' block to its original factory settings. The supervisor password ('TERMINAL → Access') will not be reset, only "Device" block.

Please refer to Chapter 5.3.3 on how to reach the menu position 'Vision Setup → TERMINAL → Reset' and how to navigate within the 'Vision Setup'-menu.

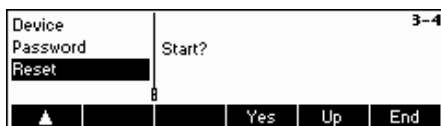

Press «Yes» to reset the terminal settings. 'SURE?' will appear, press «Yes» to confirm. The terminal settings are now reset to its original factory settings.

5.9 Communication settings (COMMUNICATIONS)

This function block allows the user to change the peripheral settings of the scale. Differences will appear depending on the pack (Options Analog/Ethernet/USB/Digital I/O) installed.

Please refer to Chapter 5.3.4 on how to reach the menu position 'Vision Setup → COMMUNICATIONS' and how to navigate within the 'Vision Setup'-menu.



The screen shows the most important communication settings as a preview.



The screen shows a preview of the most important settings of the active item, e.g. those of COM1 if 'Com1' is active (i.e. highlighted).

Enter the COMMUNICATION menu by pressing («>>>»), select a COM port and choose one of the functions listed below.

Available functions and settings:

- Mode → Chapter 5.9.1
- Printer – if mode is Printer or Auto print → Chapter 5.9.2
- Parameters → Chapter 5.9.3
- Define I/O – if mode is Digital I/O → Chapter 5.9.4
- Reset 'COMMUNICATION' settings to factory settings → Chapter 5.9.5
- Option Settings (Analog/Ethernet/USB/Digital I/O) → Chapter 5.9.6
- PS2 settings → Chapter 5.9.7
- User-defined printout → Chapter 5.9.8

5.9.1 Mode (COMMUNICATIONS → Mode)

This function enables the user to set the input/output mode of a COM port.

Please refer to Chapter 5.3.4 on how to reach the menu position 'Vision Setup → COMMUNICATIONS → Mode' and how to navigate within the 'Vision Setup'-menu.



Press the «Edit» softkey to go to the Mode settings menu.



The mode setting can be changed with the following settings:

- **Printer**, (Manual data transmission to the printer)
- **Auto Print**, (Automatic printing of stable weights)
- **Continuous Weight**, (Continuous transmission of all weight values via the interface)
- **Dialog**, (Bi-directional communication via MT-SICS commands with the control of the scale through a PC)
- **2nd Display**, (connection of a second display)
- **Reference Scale**, (Second scale serves as a reference scale. Automatic switching from reference scale to bulk scale)
- **Bulk scale**, (Second scale serves as a bulk scale. Automatic switching from reference scale to bulk scale)
- **Auxiliary scale**, (both scales can be used as a reference as well as a bulk scale, but it does not switch automatically from reference scale to bulk scale)
- **Toledo Weight**, (Continuous transmission of all weight values in TOLEDO CONTINUOUS Format via the interface)
- **Toledo Count**, (Continuous transmission of the piece counts in TOLEDO CONTINUOUS Format via the interface)
- **Digital I/O**, (Transmission to a digital I/O relay box)

In this example, COM1 is set to Dialog (also known as "Host Mode" for MT-SICS commands). Confirm your choice of settings with «OK».

Press the «End» softkey and confirm with «Yes» to save changes.

5.9.2 Printer (COMMUNICATIONS → Printer) only in Printer Mode or Auto Print

This function allows the user to define the settings of a printer to a COM Port. Please note that this function is only available in "Printer Mode" and "Auto Print".

Please refer to Chapter 5.3.4 on how to reach the menu position 'Vision Setup → COMMUNICATIONS → COM X → Printer' and how to navigate within the 'Vision Setup'-menu.

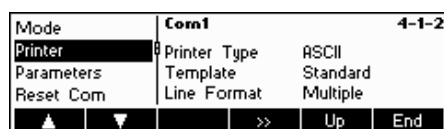

The current printer settings are displayed on the right side of the screen. Press «>>» to go to the printer settings menu.

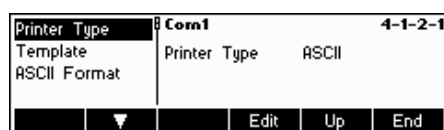

Choose "Printer Type" and press the «Edit» softkey to define the printer.

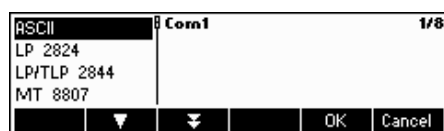

You can choose from any of the following printer types: ASCII

- GA 46
- LP 2824
- LP/TLP 2844
- MT 8807
- MT 8808
- MT 8857
- MT 8863/8867
- Others*

*The term "Others" mean that you can freely choose any programmable (label) printer. Please refer also to Chapter 5.9.6 "User-defined printer".

Confirm your choice with «Edit» and then press «Yes» to save your settings.

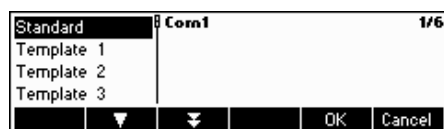

IND465 gives you the possibility to generate up to five different user-defined templates for your individual printouts. However, this must be set in "Vision Setup → COMMUNICATION → Define Printer" as described in Chapter 5.9.6.

After you have defined a template, you can assign this directly to a data interface found in "Printer Mode" ("Vision Setup → COMMUNICATION → Printer → Template").

The template can also be accessed directly from Weigh Mode. Define a «Template» softkey as described in Chapter 5.5.7. This softkey will enable you to directly allocate a defined template of a data interface, without going inside the scale menu.

If printer type chosen is "ASCII", a new menu "Format ASCII" will appear. The settings for line format and length of line of ASCII printers can be defined inside this menu. The settings in this menu are as follows:

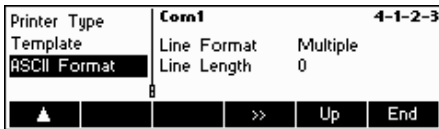

Line Format: Multiple

A line number will be automatically sent after each line. The line has a defined number of characters in the menu "Line Available". The format of the characters will be left justified and the weight will be right justified.

Note: If the Line Available is defined as «0», there will be no alignment.

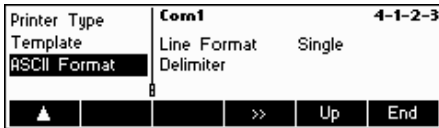

Line Format: Single

Data will be sent without line change in a line. A separator will be inserted between a character and a value, as defined in the menu "Delimiter"

Note: Adding a semi-colon is recommended when reading in Excel.

5.9.3 Parameters (COMMUNICATIONS → Parameters)

This function allows the user to choose the settings of the parameter for the COM Port.

Please refer to Chapter 5.3.4 on how to reach the menu position 'Vision Setup → COMMUNICATIONS → Parameters' and how to navigate within the 'Vision Setup'-menu. (COM X corresponds to the COM Port in which the scale is connected).



The current Baud Rate, Parity and Handshake settings are displayed on the screen.

- Press «>>»
- Press «Edit» to change settings of Baud, Parity or Handshake.



Baud:	Parity:	Handshake:
300	7-none	No
600	7-odd	XonXoff
1200	7-even	Net 422
2400	8-none	Net 485
4800	8-odd	
9600	8-even	
19200		
38400		
57600 (only for COM3)		
115200 (only for COM3)		

Note: If Handshake "Net 422" or "Net 485", a Net Address menu will appear from which you can select from 0...31.

If Mode is "Toledo Weight" or "Toledo Count", a Checksum menu will appear which you can turn either "Off" or "On". If checksum is turned "On", the values transmitted through the interface can be verified by means of a checksum.

- Select VCC to switch on/off the 5 V voltage, e. g. for a bar code reader.

5.9.4 Define I/O (COMMUNICATIONS → Def. I/O – only if Mode is Digital I/O)

This function defines commands sent by IND465 to the LC-I/O during Checkweighing and Filling functions. The commands for the MT-I/O relay box (Order No. 21 202 217) are already set in the factory settings. However, they can be replaced any time with other commands. Note that this function may only be activated if Mode is Digital I/O.

The I/O relay box must be defined in such a way that it is suitable to the corresponding COM Port of the scale to which it is connected. Go to "Vision Setup → COMMUNICATION → COM X → Mode and then choose "Digital I/O" and confirm with «OK». (COM X corresponds to the COM Port in which the scale is connected). Save your settings by pressing «End» and confirm by pressing «Yes».

Mode	Com2	4-2-4
Parameters	< Tol- W1 02 0	
Define I/O	Good W1 04 0	
Reset Com	> Tol+ W1 08 0	
▲	▼	>> Up End

Go to "Vision Setup → COMMUNICATION → COM X → Define I/O and then press «>>» to change settings for the I/O relay box.

< Range-	Com2	4-2-4-1
< Tol-	W1 01 0	
Good		
> Tol+		
▼	▼	Edit Up End

Choose < Range-, < Tol-, Good, > Tol+, >Range+, Output off or Reset I/O and then press the «Edit» softkey to define the commands.

- < Range-** The command to send if the weight is below plausible limits.
- < Tol-** The command to send if the weight is below the Tol-defined.
- Good** The command to send if the weight is within the tolerances defined.
- > Tol+** The command to send if the weight is above the Tol+ defined.
- > Range+** The command to send if the weight is above plausible limits.
- Output off** The command to send if all outputs are to be turned off.

5.9.5 Reset communications (COMMUNICATIONS → Comx → Reset Com)

This function resets the 'COMMUNICATIONS' block to its original factory settings.

Please refer to Chapter 5.3.4 on how to reach the menu position 'Vision Setup → COMMUNICATIONS → Comx → Reset Com' and how to navigate within the 'Vision Setup'-menu.

Mode	Com1	4-1-5
Printer	Start?	
Parameters		
Reset Com	0	
▲		Yes Up End

Press «Yes» to reset the settings of the current Com port. 'SURE?' will appear, press «Yes» to confirm. The chosen Com port is now reset to its original factory settings.

5.9.6 Option Settings (COMMUNICATIONS → Option)

This function allows setting up the attached ETHERNET, USB, Analog and Digital I/O options.

Please refer to Chapter 5.3.4 on how to reach the menu position 'Vision Setup → COMMUNICATIONS → Option' and how to navigate within the 'Vision Setup'-menu.

ETHERNET OPTION

This function allows setting up the ETHERNET option.

Available only if ETHERNET option is installed.

Com1				4-4
Com2	ETHERNET	192.168.1.1		
Com3	USB	installed		
Option	Analog	Reference Scal		
▲ ▼ ▾ >> Up End				

The current settings are displayed on the screen.

Press «>>».

ETHERNET				4-4-1
USB	IP Address	192.168.1.1		
Analog	Subnet Mask	255.255.255.0		
	Gateway	0.0.0.0		
▼ >> Up End				

Choose ETHERNET and press «>>» to enter the ETHERNET option settings.

IP Address				4-4-1-1
Subnet Mask	IP Address	192.168.1.1		
Gateway				
Reset				
▼ Edit Up End				

Choose "IP Address", "Subnet Mask", or "Gateway" and press «Edit» to choose the desired setting.

Choose "Reset" to reset to its original factory settings.

USB OPTION

This function shows the current state of the USB option.

Available only if USB option is installed.

Com1				4-4
Com2	ETHERNET	192.168.1.1		
Com3	USB	installed		
Option	Analog	Reference Scal		
▲ ▼ ▾ >> Up End				

Choose USB and press «>>» to enter the USB option settings.

ETHERNET				4-4-2
USB	USB	installed		
Analog				
▲ ▼ Up End				

The current state of USB option will be shown. A further configuration of the USB interface within Vision Setup is not available.

Analog option

This function allows setting of the Analog option, wherein an analog weighing platform is connected to the IND465.

Available only if Analog option is installed.

ETHERNET				4-4-3
USB	Analog	Reference Scal		
Analog				
▲ Edit Up End				

Choose **Reference Scale, Bulk Scale, Auxiliary Scale or Bypass** and then press «OK» to select the desired mode.

- Reference Scale** The weight coming from the analog option is to be used for reference weight determination only. The analog weighing platform uses the reference weight determination. IND465 switches automatically to Bulk Scale after reference determination.
- Bulk Scale** The weight coming from the analog option is to be used as bulk weight only. The reference determination is performed on IND465. IND465 switches automatically to Bulk Scale after reference determination.
- Auxiliary Scale** The weight coming from the analog option can be used as either reference or bulk. No automatic switching from reference scale to bulk scale will take place.
- Bypass** The weight coming from the analog option will be ignored.

Digital I/O option

The Digital I/O option allows to control the scale via peripheral devices or to activate peripheral devices via the scale. 4 potential-free inputs and outputs are available.

Available only if Digital I/O option is installed.

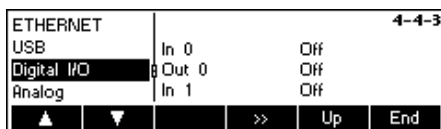

The current settings are displayed on the screen.

Choose Digital I/O and press «**▶▶**» to enter the Digital I/O settings.



Use the key «**▲**» to select the desired input or output and press «**Edit.**».



Choose the desired setting for the input selected and press «**OK**».

The following settings can be assigned to inputs and outputs:

Inputs

- Off
- Zero
- Tare
- Print
- Clear
- Unit
- Ref X
- Ref n
- Info
- Scale
- Total+ (Totalising)
- Total- (Subtracting)
- Soffkey 1...6
- Start

Outputs

- Off
- Stable
- < MinWeigh
- > Minweigh
- < Range-
- < Tol-
- Good
- > Tol+
- > Range+
- < Max. n
- Max. n
- * (show asterisk)
- SP.TOL-
- SP.TOL- -
- Target
- Below SetPoint 1
- Above SetPoint 1
- Below SetPoint 2
- Above SetPoint 2



Independently from other functions, two Setpoints for digital outputs can also be defined.
Enter value for Setpoint 1 (2)...

5.9.7 PS2 Settings (COMMUNICATIONS → PS2)

This function allows setting up of the peripherals that are attached via the PS2 Interface.

Please refer to Chapter 5.3.4 on how to reach the menu position 'Vision Setup → COMMUNICATIONS → PS2' and how to navigate within the 'Vision Setup'-menu.



Select the item you wish to configure.



Keyboard

It is possible to attach a PS2 keyboard to the scale via the PS2 Interface. This function enables you to specify the layout of the keyboard that you are using.

Note: When a PS2 keyboard is attached, it is possible to work with IND465 using only this keyboard. The keys F1-F6 simulate the soffkeys, F9-F11 simulate the top 3 function keys of the IND465 scale. You can press the «Enter» and «Esc» keys to simulate the «OK» and «Cancel» soffkeys respectively. The «Backspace» key simulates the «C» soffkey.

**BCR**

Aside from a keyboard, it is also possible to attach a barcode reader via the PS2 Interface. This function enables you to specify the designation of the data coming from the barcode reader used for Direct Input (i.e. when the scale is in weighing or piece counting mode).

Not Used	Ignore data coming from the barcode reader.
Article Search	Use the data for searching through the article database.
Tare Wt.	Assign the data read to Tare weight.
APW	Assign the data read to Average Piece Weight.
ID1	Assign the data read to ID1.
ID2	Assign the data read to ID2.
ID3	Assign the data read to ID3.

Note: The BCR setting is only used for Direct Input. Whenever the scale is asking for user input, the barcode reader can also be used to scan in data and the data will be used in the context of the user input.

5.9.8 User-defined printer (COMMUNICATIONS → User-defined printer)

This function allows you to customize your printing tasks according to your needs.

Please refer to Chapter 5.3.4 on how to reach the menu position 'Vision Setup → COMMUNICATIONS → User-defined printer' and how to navigate within the 'Vision Setup'-menu.



Choose "Def. Printer" and press the «>>» to go to the settings of user-defined printer menu.



IND465 enables you to specify the heading lines of your printout according to your needs. Moreover, you can generate a "Free Text". Furthermore, there are available templates that you can define.

Press "Def. Heading Line" and confirm with «>>».



Choose the heading line to be edited and press «Edit». Using the keypad or a connected keyboard, enter the texts for the heading line.



Free text enables you to control the output of different printers and generate user-defined printouts. It can contain variables that can be defined, which will be replaced by their corresponding values when printing. Control codes can also be entered, in order to control the connected printer. Any printer can be controlled using this operation.

Note: A list of variables can be found in Chapter --- Inputting variables and control codes in "Free Texts")

Example:

Free Text 1: "Today is \$DAT\OD\OATime is \$TIM"

This free text contains the variable \$DAT (Date) and \$TIM (Time), as well as the code controls \OD (Carriage Return) and \OA (Line Feed). The following printout will be generated on an ASCII printer.

Today is 30.10.2008
Time is 11:09:14

In order to be able to create a free text, choose the corresponding text and press «**Edit**». Using the keypad or a connected keyboard, enter the texts for the free text.



It is also possible to generate a "Template". Choose the template that you wish to edit and press «>>». Choose «**Edit**» and then press «>>» to change the settings of this template. Choose "Name" and press «**Edit**» to give a name to the chosen template.

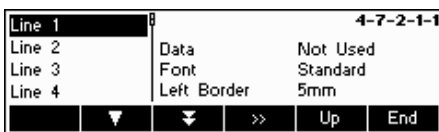

Choose the line to be edited and press «>>».

Note: It is possible to insert a line with the ↑ - key



Choose "Date" to define the desired information for the line that was chosen. A detailed list of all functions can be found on the menu diagram (see Chapter 5.3.4 "COMMUNICATION → Def. Heading Line → Template 1-5 → Edit → Line 1-23 → Data").



Choose "Font" to change the layout of the printout. (This menu is not available in printer type "ASCII" and "Others")



Choose "Left Margin" to specify the distance of the left margin. (This menu is not available in printer type "ASCII" and "Others")

Example: Configuration of a printer

The configuration of a printer is illustrated with the help of this example. A label printer (Zebra LP 2824) is used as a printer.

Connect the printer and IND465 in accordance with the user's manual of your printer.



Select the COM port where you have connected your printer in "Vision Setup" menu under "COMMUNICATION". In our example, COM Port 1 (COM1) is used. Press «>>».

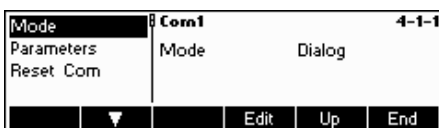

Choose "Mode" and press the «**Edit**» softkey.

Printer	Com1	1/11
Auto Print		
Cont Weight		
Dialog		
		OK Cancel

Choose "Printer" and confirm with «**OK**».

Mode	Com1	4-1-2
Printer	Printer Type	ASCII
Parameters	Template	Standard
Reset Com	Line Format	Multiple
		>> Up End

The menu "Printer" now appears in the list of choices. Choose this parameter and press then press «**>>**».

Printer Type	Com1	4-1-2-1
Template	Printer Type	ASCII
ASCII Format		
		Edit Up End

Choose "Printer Type" and then press «**Edit**».

ASCII	Com1	2/8
LP 2824		
LP/TLP 2844		
MT 8807		
		OK Cancel

You may now choose a printer. In our example, the printer "LP 2824" is selected. Confirm selection with «**OK**».

Printer Type	Com1	4-1-2-2
Template	Template	Standard
ASCII Format		
		Edit Up End

In case you want to use "Template" in your printouts, you may also assign this to the corresponding data interface. Choose "Template" and press «**Edit**». (Templates can be created in "Vision Setup" menu under "COMMUNICATION → Def. Printout)

Standard	Com1	1/6
Template 1		
Template 2		
Template 3		
		OK Cancel

The desired template can now be selected. "Standard" as active is the factory settings for the template. A saved template can be deleted by pressing the key «**C**».

Mode	Com1	4-1-3
Printer	Baud	2400
Parameters	Parity	7-even
Reset Com	Handshake	XonXoff
		>> Up End

Go back one step back to the menu by pressing «**Back**» and then choose "Parameter". You may now change the settings for baud rate ("Baud"), parity and handshake. See the user's manual of your printer and verify the correct data. In our example, the value of the left picture to be made visible is turned on.

Note: If a printer driver of your printer is available, as in the case of our example, its corresponding parameters will automatically be set.

If you are done making the necessary settings of your printer configuration, press the «**Back**» softkey and confirm with «**YES**» to save your settings.

You can now generate your printouts using the «» key.

5.10 Diagnostic settings (DIAGNOSTICS)

This function block allows the user to verify if all keys are functioning properly.

Please refer to Chapter 5.3.5 on how to reach the menu position 'Vision Setup → DIAGNOSTICS' and how to navigate within the 'Vision Setup'-menu.



Enter the DIAGNOSTICS menu («**>>**») and choose one of the functions listed below.

Available functions and settings:

Test Scale	→	Chapter 5.10.1
Keyboard Test	→	Chapter 5.10.2
Display Test	→	Chapter 5.10.3
Serial Number 1	→	Chapter 5.10.4
Serial Number 2	→	Chapter 5.10.5
List1	→	Chapter 5.10.6
List2	→	Chapter 5.10.7
List Memory	→	Chapter 5.10.8
Working Time	→	Chapter 5.10.9
Reset All	→	Chapter 5.10.10

5.10.1 Scale (DIAGNOSTICS → Test Scale)

Please refer to Chapter 5.3.5 on how to reach the menu position 'Vision Setup → DIAGNOSTICS → Test Scale' and how to navigate within the 'Vision Setup'-menu.



Press «**>>**» to enter the settings for the scale test.

- Press «Yes» to start the scale test.

The scale checks the zero point.

-0- appears in the display. The test weight flashes in the display.

- If necessary, change the displayed calibration weight.
- Put the calibration weight on the scale and confirm with «**↵**».

The scale checks the calibration weight put on.

After the test is completed, the deviation from the last calibration briefly appears in the display, ideally *d=0.0 g, after which the scale changes to the next menu item Keyboard Test.

5.10.2 Keyboard (DIAGNOSTICS → Keyboard Test)

Please refer to Chapter 5.3.5 on how to reach the menu position 'Vision Setup → DIAGNOSTICS → Keyboard Test' and how to navigate within the 'Vision Setup'-menu.



In order to check if all the keys are functioning properly, press «**Yes**» to start the keyboard test.

Note: The test can be aborted at any time by pressing the «**C**» key (25).



Press all 25 keys in sequence. If a key is functioning, the scale jumps to the next key. The keys are numbered as follows:

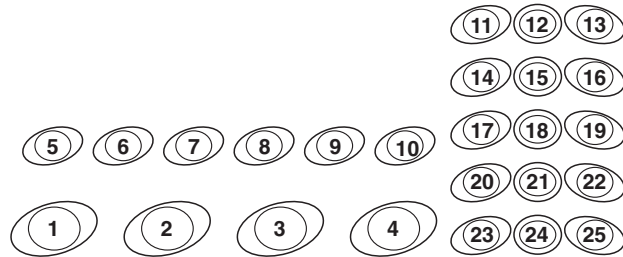

5.10.3 Display (DIAGNOSTICS → Display Test)

Please refer to Chapter 5.3.5 on how to reach the menu position 'Vision Setup → DIAGNOSTICS → Display Test' and how to navigate within the 'Vision Setup'-menu.



In order to check if the screen is functioning properly, press «Yes» and...



The display on the left will appear. An inverted display of the same screen will appear if any key is pressed. Pressing further any key will end the test display.

5.10.4 Serial Number 1 (DIAGNOSTICS → SNR1)

Please refer to Chapter 5.3.5 on how to reach the menu position 'Vision Setup → DIAGNOSTICS → SNR1' and how to navigate within the 'Vision Setup'-menu.

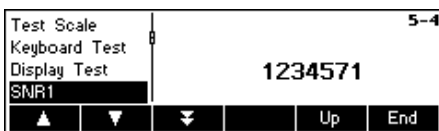

The serial number of the scale is displayed.

5.10.5 Serial Number 2 (DIAGNOSTICS → SNR2)

Please refer to Chapter 5.3.5 on how to reach the menu position 'Vision Setup → DIAGNOSTICS → SNR2' and how to navigate within the 'Vision Setup'-menu.



The **serial number** of the analog second scale, if installed, is displayed.

5.10.6 List 1 (DIAGNOSTICS → List 1)

Please refer to Chapter 5.3.5 on how to reach the menu position 'Vision Setup → DIAGNOSTICS → List 1' and how to navigate within the 'Vision Setup'-menu.



Press «**Yes**» to print out the current settings of the entire Vision Setup menu.

5.10.7 List 2 (DIAGNOSTICS → List 2)

Please refer to Chapter 5.3.5 on how to reach the menu position 'Vision Setup → DIAGNOSTICS → List 2' and how to navigate within the 'Vision Setup'-menu.



Press «**Yes**» to print out the current settings of analog option, if installed.

5.10.8 List memory (DIAGNOSTICS → List Memory)

This function prints out listing of all the articles stored in the database including a summary of the important parameters for each article.

Please refer to Chapter 5.3.5 on how to reach the menu position 'Vision Setup → DIAGNOSTICS → List Memory' and how to navigate within the 'Vision Setup'-menu.



Press «**Yes**» to start printing.

5.10.9 Working time (DIAGNOSTICS → Working time)

This function displays the working time of the scale, as well as the number of weighings that are carried out by the scale.

Please refer to Chapter 5.3.5 on how to reach the menu position 'Vision Setup → DIAGNOSTICS → Reset All' and how to navigate within the 'Vision Setup'-menu.



Press "Working Time". The working time, as well as the number of weighings will immediately be displayed on the right side of the screen.

5.10.10 Reset All (DIAGNOSTICS → Reset All)

This function resets the all blocks of the whole Vision Setup Menu to its original factory settings. The supervisor password ('TERMINAL → Access') will not be reset.

Please refer to Chapter 5.3.5 on how to reach the menu position 'Vision Setup → DIAGNOSTICS → Reset All' and how to navigate within the 'Vision Setup'-menu.



Press the «**»»**»key to go to the List Memory settings menu and press the «**Yes**» key to reset all.

6 Other important information

This Chapter gives information on error messages and instructions for cleaning your scale. It also includes the declaration of conformity and technical data.

6.1 Error messages

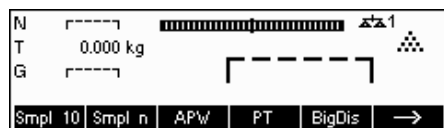

Overload

Reduce the load on the scale or the preload.



Underload

Place weighing pan on the scale and ensure that it can move freely.

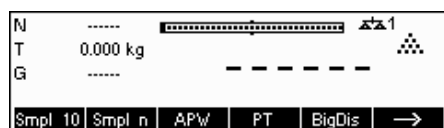

Weight reading does not stabilize

- Ensure a tranquil environment.
- Ensure that the weighing pan is free to move.
- Change the setting of the vibration adapter (Chapter 5.4.6)



Not possible to zero scale

Ensure that the zeroing is only carried out in the permissible range and not under overload or underload conditions.

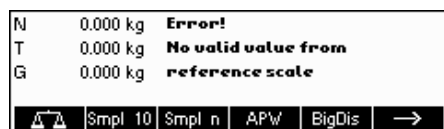

No valid value from reference scale

This message is only given when piece counting with a 2-scale system. Check the connecting cable between the scales and the interface settings.

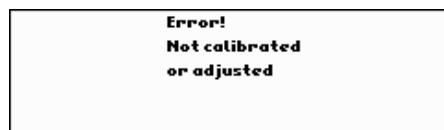

No calibration/adjustment

Disconnect the power cord plug and then plug it in again. (If operating on the battery, switch the scale off and then on again.) If the error message reappears, calibrate/adjust the scale (Chapter 5.4.1). If this does not help, contact your dealer or local representative.



Value out of range

This message is shown when a tare value is entered, exceeding the max. capacity of the scale.

N	0.000 kg	Error!						
T	0.000 kg	Reference piece						
G	0.000 kg	weight too low						
<table border="1"> <tr> <td>Smpl 10</td> <td>Smpl n</td> <td>APW</td> <td>BigDis</td> <td>HighRes</td> <td>Alibi</td> </tr> </table>			Smpl 10	Smpl n	APW	BigDis	HighRes	Alibi
Smpl 10	Smpl n	APW	BigDis	HighRes	Alibi			

Reference piece weight too small

When defining the reference weight, the scale has found that the resultant weight of one single piece is below the permissible limit. Piece counting is not possible for articles as small as this.

N	2.753 kg	Error!						
T	0.000 kg	Unstable weight when						
APW	550.816 g	determining reference						
<table border="1"> <tr> <td>Smpl 10</td> <td>Smpl n</td> <td>APW</td> <td>BigDis</td> <td>Alibi</td> <td>Auto OUT</td> </tr> </table>			Smpl 10	Smpl n	APW	BigDis	Alibi	Auto OUT
Smpl 10	Smpl n	APW	BigDis	Alibi	Auto OUT			

Unstable weight when determining the reference weight

When determining the reference weight, the reading did not stabilize, and the scale therefore cannot determine the reference weight of a single piece.

1. Ensure a tranquil environment.
2. Ensure that the weighing pan is free to move.
3. Change the setting of the vibration adapter (Chapter 5.4.6).

Error!	
EAROM checksum error	

EAROM checksum error

Disconnect the power cord plug and then plug it in again. (If operating on the battery, switch the scale off and then on again.) If the error message reappears, contact your dealer or local representative.

N	0.098 kg	Warning!							
T	0.098 kg	Chain Tare not allowed,							
G	0.196 kg	clear active tare first!							
<table border="1"> <tr> <td>Smpl 10</td> <td>Smpl n</td> <td>APW</td> <td>Unit</td> <td>BigDis</td> <td>HighRes</td> <td>Net</td> </tr> </table>			Smpl 10	Smpl n	APW	Unit	BigDis	HighRes	Net
Smpl 10	Smpl n	APW	Unit	BigDis	HighRes	Net			

Chain Tare not allowed

Chain Tare is deactivated in the Vision Menu ('Vision Setup → SCALE → Tare → Chain Tare'). This means it is not possible to tare the scale once there is already a value in the tare memory.

N	0.207 kg	Warning!						
T	0.000 kg	Pushbutton Tare						
G	0.207 kg	not allowed!						
<table border="1"> <tr> <td>Smpl 10</td> <td>Smpl n</td> <td>APW</td> <td>Unit</td> <td>BigDis</td> <td>HighRes</td> </tr> </table>			Smpl 10	Smpl n	APW	Unit	BigDis	HighRes
Smpl 10	Smpl n	APW	Unit	BigDis	HighRes			

Pushbutton Tare not allowed

The scale cannot be tared using the «→T←» key because this feature was deactivated in the Vision Setup ('Vision Setup → SCALE → Tare → Pushb. Tare').

N	0.207 kg	Warning!						
T	0.000 kg	Key not allowed in						
G	0.207 kg	short input mode!						
<table border="1"> <tr> <td>Smpl 10</td> <td>Smpl n</td> <td>APW</td> <td>Unit</td> <td>BigDis</td> <td>HighRes</td> </tr> </table>			Smpl 10	Smpl n	APW	Unit	BigDis	HighRes
Smpl 10	Smpl n	APW	Unit	BigDis	HighRes			

Key not allowed in short input mode

The function softkey that was pressed while in Short Input Mode (Chapter 3.1) is not compatible with Short Input Mode.

Warning!	
No valid input of	
reference pieces!	

No valid input of reference pieces

The reference number of pieces that was entered via «Smpl n» → «Var» or Short Input Mode → «Smpl n» was invalid. The reference weight determination will not be performed.

Warning!	
The search string could	
not be found!	

Search string not found

This warning appears if the bar code reader was configured for article searching ('Vision Setup → COMMUNICATIONS → PS2 → BCR') and the text read in by the bar code reader was not found in the article database.

6.2 Sample reports

Weigh mode

(c) Mettler-Toledo GmbH
<http://www.mt.com>

Date 17.07.2008
 Time 15:28:12

G 0.0370 kg
 T 0.2843 kg
 N 0.3213 kg

Count mode

(c) Mettler-Toledo GmbH
<http://www.mt.com>

Date 17.07.2008
 Time 15:13:51

G 0.4122 kg
 T 0.0630 kg
 N 0.3492 kg

Piece Wt 14.11524 g
 Out of 10 PCS
 QUANTITY 25 PCS

Weigh mode with article

(c) Mettler-Toledo GmbH
<http://www.mt.com>

Caramel 1365
 Toffee Factory
 000124245672

Date 17.07.2008
 Time 15:32:32

G 0.6549 kg
 PT 0.0630 kg
 N 0.5919 kg

Count mode with article

(c) Mettler-Toledo GmbH
<http://www.mt.com>

English Toffees 1060
 Toffee Factory
 000124254467

Date 17.07.2008
 Time 13:46:50

G 0.3980 kg
 PT 0.0630 kg
 N 0.3350 kg

Piece Wt 3.450000 g
 QUANTITY 97 PCS

6.3 Variable and control sequences in entering a "Free Text"

Description	Variable	Explanation	Example
Scale No.	\$SCL	Number of the scale	1
Gross weight.	\$GRS	Gross weight	3.5
Tare weight.	\$STAR	Tare weight	1.5
Actual Display Unit	\$UNT	Actual display unit	g
Net weight	\$NET	Net weight	2.0
Average Piece weight	\$APW	Average piece weight	0.35
Unit of Average Piece Weight	\$APU	Unit of average piece weight	g
Ref Count	\$REF	Reference	10
PCS(Quantity)	\$PCS	Number of pieces placed	15
Article Name	\$ANA	Name of article	U-Stahl 10X15
Article Number	\$ANU	Number of article	221365/7
Article ID1	\$AI1	Article ID1	12345
Article ID2	\$AI2	Article ID2	67890
ID1	\$ID1	ID1 (Customer)	AlMa Systems
ID2	\$ID2	ID2 (Order)	220703
ID3	\$ID3	ID3 (Lot)	17
Date	\$DAT	Date	21.05.03
Time	\$TIM	Time	11:52:17
Target	\$TGT	Target weight	2123.5
Tol -	\$TOM	Negative tolerance	10
Unit of Tol-	\$TMU	Unit of negative tolerance	%
Tol +	\$TOP	Positive tolerance	123.4
Unit of Tol+	\$TPU	Unit of positive tolerance	%
Deviation	\$DEV	Difference in regards to target as a weight or as a number of piece	- 1.5 - 4
Consecutive No.	\$CNO	Consecutive number	23
Factor weight	\$CUW	Factor weight	13
Factor Unit	\$CUU	Unit of factor	BRT

84

Accumulation Total Net	\$ACN	Accumulation total net	7500.4
Accumulation Total Gross	\$ACG	Accumulation total gross	7825.2
Accumulation Total Pieces	\$ACP	Accumulation total pieces	2345
Accumulation Total Lots	\$ACL	Accumulation total lots	214
Accumulation Total Net active article	\$ATN	Accumulation total net active article	23.4
Accumulation Total Gross active article	\$ATG	Accumulation total gross active article	35.7
Accumulation Total Pieces active article	\$ATP	Accumulation total pieces active article	1250
Accumulation Total Lots active article	\$ATL	Accumulation total lots active article	25
Accumulation max n	\$ACM	Returns value „max n“ from the Accumulation function	20
Accumulation target gross weight	\$ACT	Target weight from the database	150.00
Accumulation Deviation tot. Gross to target	\$ACD	Deviation between current weight and target weight while accumulation to target	112.10
Accumulation Lot Gross	\$ALG	Total gross of the current accumulation (not article based)	35.15
Accumulation Lot Net	\$ALN	Total net of the current accumulation (not article based)	25.15
Accumulation Lot Pieces	\$ALP	Total pieces of the current accumulation (not article based)	3507
Alibi Memory Number	\$AMN	number of alibi memory entry	001237

Note:

An empty space is always inserted between the value and the unit.

If a variable is not available (Example: \$APW in Weigh Mode), the text "n/a" will be inserted.

Entry of control codes in free texts:

Control codes are generally entered as Hex-Code. The format is always \xx, where xx stands for hexadecimal value.

Hex-Value	Meaning	Input
01	SOH (start command for specific printers)	\01
02	STX (start command for specific printers)	\02
03	ETX (send command for specific printers)	\03
04	EOT (send command for specific printers)	\04
0A	Line Feed	\0A
0C	Form Feed	\0C
0D	Carriage return	\0D
1B	ESC	\1B

Note:

This is only a list of the most commonly used sequences. All available sequences can be derived from any ASCII-Table.

6.4 Cleaning instructions



Disconnect the scale from the power supply before cleaning it!

Use a damp cloth (do not use acids, alkalis or strong solvents).

Wet cleaning is only allowable on scales with IP65 ingress protection.

If heavily contaminated, the weighing pan, protective cover (if fitted) and adjustable feet must be removed and cleaned separately.

With the weighing pan removed, never use a solid object to clean underneath the load plate support!

Observe your organization's internal rules and industry-specific regulations for cleaning intervals and permissible cleaning agents.

7 Technical data, interfaces and accessories

In this chapter you will find technical specifications for your terminal, information about standards and directives, and a list of currently available accessories.

7.1 General data and delivered items

Resolution	300.000 points in noncertified configuration 1 x 7500 or 2 x 5000 digits (multi range / multi interval) in approved configuration Input signal (approvable): 0.5 $\mu\text{V/e}$ (EN 61000-6-1) / 1.3 $\mu\text{V/e}$ (EN 61000-6-2)
Calibration	Basic calibration and calibration during linearization
Linearization	3-point/5-point selectable
Zero setting range («→0←» key.)	Selectable in the menu (in percent of defined max. capacity): $\pm 2\%$ or $-2\%/+18\%$ (same setting as "switch-on zero setting range")
Autozero range	0% (off) or 2% of defined max. capacity (fixed value)
Switch-on zero setting range	Selectable in the menu (in percent of defined max. capacity): $\pm 2\%$ or $-2\%/+18\%$ (same setting as zero setting range for «→0←» key)
Linearity	0.01% of defined max. capacity
Units	g, kg, t, lb, oz
Display steps	1, 2, 5 x 10 ⁿ
Cell power supply	8.2V
Applications	Weighing Piece counting / Piece counting with second scale Totaling weighings and piece countings (also with 2nd scale) Weighing and piece counting to a target value (also with 2nd scale) (Filling) Checkweighing and counting (with Accumulation) (also with 2nd scale) Accumulation to target weight Custom Unit Average Weighing Database
Settings	5 units of weight (g, kg, t, oz, lb) Adding mode for reference definition (piece counting) Automatic reference optimization (piece counting) Vibration adapter Weighing process adapter Automatic tare function Automatic zero correction Power-saving shutoff Display backlighting Automatic saving of tare and zero

Display	Active point-matrix display, 35 mm high, with CFL backlit (235 x 64 pixel)
Interface	3 built-in RS232C interfaces (for data, see Chapter 7.3) PS2 interface for keyboard and barcode reader Optional interfaces available (Ethernet, USB and Analog 2-scale connection)
Ambient conditions	<ul style="list-style-type: none"> ▪ Use Indoor use only ▪ Altitude up to 2000 m ▪ Temperature range IND465 -10 .. +40 °C / 14 .. 104 °F ▪ Overvoltage category II ▪ Contamination level 2 ▪ Relative humidity Maximum relative humidity 80 % for temperatures up to 31 °C / 88 °F, decreasing linearly to 50 % relative humidity at 40 °C / 104 °
Mains connection	<p>Direct connection to the mains (MAINS supply voltage fluctuations up to ±10% of the nominal voltage):</p> <ul style="list-style-type: none"> ▪ 230 V, 50 Hz, 70 mA ▪ 240 V, 50 Hz, 70 mA ▪ 120 V, 60 Hz, 90 mA ▪ 100 V, 50/60 Hz, 90 mA <p>For battery operation:</p> <ul style="list-style-type: none"> ▪ Connection via mains adapter: 90 – 264 V, 47 – 63 Hz, 300 mA ▪ Infeed on the unit: 24 V, 1.3 A
Battery operation	If the voltage supply is interrupted, the unit automatically switches over to battery operation.
Degree of protection (IEC 529, DIN 40050, EN 60529)	IP65 (not with Ethernet interface)
Total weight	see chapter 7.2

7.2 Dimensions and weight

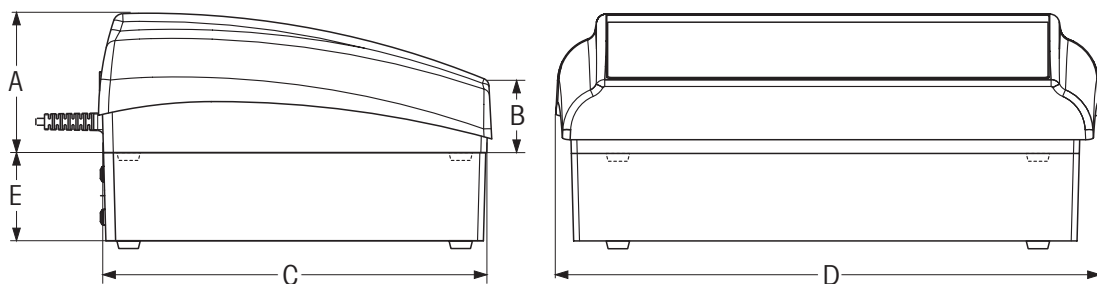

	A ¹⁾	B	C	D	E (OptionPac) ¹⁾
Dimensions	71mm	36mm	200mm	277mm	49mm
Net weight	2,4kg (without OptionPac)				2.0kg

¹⁾ without fixed feet (with fixed feet: + 0.18in / 4.5mm)

7.3 Interface technical data

The terminal is provided with three EIA RS-232C (CCITT V24/V.28) voltage-controlled interfaces as standard. Maximum cable length is 15 m. All interfaces are in the form of a 9-pin D-sub female connector. Instructions for configuring the interfaces are given in Chapter 5.9.

PIN	RS232	RS422	RS485	Digital I/O	Analog Interface
1		–	–	GND	+ Excitation (+8.2VDC)
2	TxD1/2	TxD1–	TxD1–/RxD1–	OUT0	+ Sense
3	RxD1/2	RxD1–	–	OUT1	Shield
4	–	–	–	OUT2	- Sense
5	GND	GND	GND	OUT3	- Excitation (GND)
6	–	–	–	IN0	-
7	–	TxD1+	TxD1+/RxD1+	IN1	+ Signal
8	–	RxD1+	–	IN2	- Signal
9	VCC	VCC	VCC	IN3	-

TxD: Transmit data

RxD: Receive data

GND: Signal ground

VCC: Power supply +5V

Technical data for "Analog" interface (option):

A/D-Converter ("analog" IF option)	Load cell (weighing platform to be connected to analog option)
Resolution (approved): 7'500 e OIML or 2x5000 e (multi range / multi interval) 10'000 d NTEP	Power supply: 8.2 V
Resolution (not approved): 300'000 d	Impedance: > 80 R
Input signal (approved): 0.5 µV/e (EN 61000-6-1) 1.3 µV/e (EN 61000-6-2)	Output signal: 2 mV/V

7.4 Accessories

Accessories	Article No.
Protective cover for terminal	21255045
Strip printer "Sprinter 1" Euro	21253399
Strip printer „Sprinter 1“ UK	21253745
Label printer "Zebra LP 2844"	22009327
Label printer „Zebra LP2824“	22009328
RS232 cable for Zebra LP 2824/2844" (1.8m)	21252588
Labels for „Zebra LP 2844" (102x102mm, 1 roll, 380 labels)	22009329
Labels for „Zebra LP 2824" (57x102mm, 1 roll, 380 labels)	22009330
Second display ADI412	22013978
Second display ADI412-B (with backlit)	22013977
PS/2 barcode reader MT Heron-G D130	21901297
Y-cable for PS/2 barcode reader to connect a PS/2 keyboard	21901308
Mini keyboard PS/2 (USA)	21900944
Protective cover for mini keyboard	21900945
Relay box 4	22011967
Relay box LC-I/O	21202217
RS232 cable for relay box 4 with open ends	21254225
RS232 cable for strip printer „Sprinter 1" (1.8m)	21253677
RS232 cable for 2nd scale or ADI412 (1.8m)	21252588
RS232 cable for connection to PC (1.8m)	00410024
SICS Manual 4 Series (English)	22011459
SmartManager software (full version)	22009973
Stand IND4.. 330mm (compl. incl. wall mount for PBA330)	22011469
Stand IND4.. 660mm (compl. incl. wall mount for PBA330)	22011470
Wall-, stand mount	22011471
Connection plate for PBA330, size A, BB, B, BC	21255259

Interface cables for peripheral devices (computer, printer, etc.) see current price-list.

7.5 Interface commands

Your terminal can be configured and operated, and can communicate from a PC via RS232C interface (as well as Ethernet and/or USB interface), i.e. data transmitted to a PC.

7.5.1 Preconditions

The following preconditions must be fulfilled to achieve communication between the scale and a PC:

- The IND465 terminal must be connected to the RS232C interface of the PC using the necessary cable.
- The IND465 terminal interface must be set in "Dialog" mode (see Chapter 5.9.1).
- A terminal program must be available on the PC (e.g. "Hyper Terminal").
- The communications parameters (protocol, bits and parity, data transfer rate) must be set using the same values in the terminal program and in the IND465 terminal (see Chapter 5.9.3).

7.5.2 SICS Command set

The IND465 terminal supports the command set MT-SICS (METTLER TOLEDO Standard Interface Command Set). With SICS commands, it is possible to configure, query and operate the scales from a PC. SICS commands are divided up into various levels.

Level 0

Command	Meaning
@	Reset the scale
I0	Inquiry of all available SICS commands
I1	Inquiry of SICS level and SICS versions
I2	Inquiry of scale data
I3	Inquiry of scale software version
I4	Inquiry of serial number
I6	Inquiry of weighing parameters
S	Send stable weight value
SI	Send weight value immediately
SIR	Send weight value repeatedly
Z	Zero the scale
ZI	Zero immediately

Level 1

Command	Meaning
D	Write text into display
DW	Weight display
K	Keyboard check
SR	Send and repeat stable weight value
T	Tare
TA	Tare value
TAC	Clear tare
TI	Tare immediately

In the case of Levels 0 and 1, these are commands which, if implemented, will function identically with all METTLER TOLEDO scales or weighing terminals. In addition there are also further interface commands which apply either to the entire product series or to the particular application level. This and further information on the MT-SICS command set may be found in the MT-SICS Manual (Order Number 22 011 459 or at www.mt.com) or be obtained by request from your METTLER TOLEDO customer service representative.

7.6 TOLEDO Continuous Mode

7.6.1 TOLEDO Continuous commands

The scale supports the following input commands in TOLEDO Continuous mode:

Command	Meaning
P <CR><LF>	Print the current result
T <CR><LF>	Tare the scale
Z <CR><LF>	Zero the display
C <CR><LF>	Clear the current value
S <CR><LF>	Determining the reference

7.6.2 Output format in TOLEDO Continuous Mode

Weight values are always sent in the following format in TOLEDO-Continuous-Mode:

1	Status			Field 1						Field 2						17	18
	2	3	4	5	6	7	8	9	10	11	12	13	14	15	16		
STX	SWA	SWB	SWC	MSD	-	-	-	-	LSD	MSD	-	-	-	-	LSD	CR	CHK
Field 1	6 digits for the weight value that is sent without a decimal point and unit																
Field 2	6 digits for the tare weight that is sent without a decimal point and unit																
STX	ASCII characters 02 hex, characters for "start of text"																
SWA, SWB, SWC	Status words A, B, C, see below																
MSD	Most significant digit																
LSD	Least significant digit																
CR	Carriage Return, ASCII characters 0D hex																
CHK	Checksum (2-part complement of the binary sum of the 7 lower bits of all previously sent characters, incl. STX and CR)																

Status word A								
Function	Selection	Status Bit						
		6	5	4	3	2	1	0
Decimal position	X00	0	1			0	0	0
	X0					0	0	1
	X					0	1	0
	0.X					0	1	1
	0.0X					1	0	0
	0.00X					1	0	1
	0.000X					1	1	0
	0.0000X					1	1	1

92

Numerical increment	X1			0	1			
	X2			1	0			
	X5			1	1			

Status word B	
Function/value	Bit
Gross/net: Net = 1	0
Sign: Negative = 1	1
Overload = 1	2
Movement = 1	3
lb/kg: kg = 1	4
1	5
Powerup = 1	6

Status word C	
Function/value	Bit
0	0
0	1
0	2
Print request = 1	3
Extended = 1	4
1	5
Manual taring, only kg = 1	6

8 Appendix

8.1 Safety checks

The IND465 terminals have been checked by accredited testing institutions. They have passed the safety checks listed below and carry the relevant test symbols. Production is subject to production monitoring by the inspection offices.

Country	Test symbol	Standard
Canada USA		CAN/CSA-C22.2 No. 1010.1-92 UL Std. No. 61010A-1
Other countries	CB Scheme (no identification)	IEC/EN61010-1 :2001

8.2 Table of Geo Values

For weighing instruments verified at the manufacturer's, the geo value indicates the country or geographical zone for which the instrument is verified. The geo value set in the instrument (e.g. "Geo 18") appears briefly after switch-on or is specified on a label.

Table **GEO VALUES 3000e** shows the geo values for European countries.

Table **GEO VALUES 6000e/7500e** shows the geo values for different gravitation zones.

8.2.1 GEO VALUES 3000e, OIML Class III (European Countries)

Geographical latitude	Geo Value	Country
46°22' - 49°01'	18	Austria
49°30' - 51°30'	21	Belgium
41°41' - 44°13'	16	Bulgaria
42°24' - 46°32'	18	Croatia
48°34' - 51°03'	20	Czech Republic
54°34' - 57°45'	23	Denmark
57°30' - 59°40'	24	Estonia
59°48' - 64°00'	25*	Finland
64°00' - 70°05'	26	
41°20' - 45°00'	17	France
45°00' - 51°00'	19*	
47°00' - 55°00'	20	Germany
34°48' - 41°45'	15	Greece
45°45' - 48°35'	19	Hungary
51°05' - 55°05'	22	Ireland
63°17' - 67°09'	26	Iceland
35°47' - 47°05'	17	Italy
55°30' - 58°04'	23	Latonia
49°27' - 50°11'	20	Luxembourg
47°03' - 47°14'	18	Liechtenstein

53°54' - 56°24'	22	Lithuania
50°46' - 53°32'	21	The Netherlands
57°57' - 64°00'	24*	Norway
64°00' - 71°11'	26	
49°00' - 54°30'	21	Poland
36°58' - 42°10'	15	Portugal
43°37' - 48°15'	18	Romania
55°20' - 62°00'	24*	Sweden
62°00' - 69°04'	26	
45°49' - 47°49'	18	Switzerland
47°44' - 49°46'	19	Slovak Republic
45°26' - 46°35'	18	Slovenia
36°00' - 43°47'	15	Spain
35°51' - 42°06'	16	Turkey
49°00' - 55°00'	21 *	Great-Britain
55°00' - 62°00'	23	

* factory setting

8.2.2 GEO VALUES 6000e/7500e OIML Class III (Height ≤ 1000 m)

Geographical latitude	Geo Value
00°00' - 12°44'	5
05°46' - 17°10'	6
12°44' - 20°45'	7
17°10' - 23°54'	8
20°45' - 26°45'	9
23°54' - 29°25'	10
26°45' - 31°56'	11
29°25' - 34°21'	12
31°56' - 36°41'	13
34°21' - 38°58'	14
36°41' - 41°12'	15
38°58' - 43°26'	16
41°12' - 45°38'	17
43°26' - 47°51'	18
45°38' - 50°06'	19
47°51' - 52°22'	20
50°06' - 54°41'	21
52°22' - 57°04'	22
54°41' - 59°32'	23
57°04' - 62°09'	24
59°32' - 64°55'	25
62°09' - 67°57'	26
64°55' - 71°21'	27
67°57' - 75°24'	28
71°21' - 80°56'	29
75°24' - 90°00'	30

INDEX

2

2nd display	67
2-scale	31, 48

A

Accessories	89
accumulation	32
accumulation settings	57
accumulation total gross weight	23
accumulation total net weight	23
accumulation total number of lots	23
accumulation total number of pieces	23
accuracy display	55
additive tare	60
article database	20
article identification	21
article name	21
article number	21
article sample size	22
article tare weight	22
auto sampling	55
auto zero	50
automatic clear average piece weight	55
automatic clear tare	50, 54
automatic reference optimization	29
automatic tare	50, 54
automatic taring	26
auxiliary scale	31, 60, 72
average piece weight .. 19, 22, 26, 29, 30, 54, 55, 60	
average weighing	37, 60
average weight	38

B

bar graph	35
barcode reader connection	74
baud rate	69
beep	65
beeper	58
big display	60
blank info line	62
blank softkey	61
bulk scale	31, 60, 67, 72
bypass	72

C

calibration	49
chain tare	50
checksum	69
checkweighing	35, 58, 60
communication	66, 68, 69, 70
consecutive number	60
consecutive number info line	62
continuous weight	67
contrast	64
Count key	27

D

database	56
date	30
date and time	13, 65
date info line	62
dialog	67
Digital I/O	72
display	13, 32, 37
display test	78
ditigal I/O	70

E

erasing of individual article attributes	24
error messages	80
ETHERNET- Option	71

F

factor	37
factor/unit weighing	36, 60
filling	35, 60
filling/checkweighing lower limit	23
filling/checkweighing nominal value	23
filling/checkweighing upper limit	23
fine range	35

G

gross weight	18, 30, 60
gross weight alarm	25
gross weight info line	62

H

Handsfree	53
handshake	69
high resolution info line	62
HighRes - softkey	60

I

identification	57, 61
Info line	61, 63, 64, 65
Info/Help key	30, 61
interface	18, 27, 31, 32
interface commands	90
invert	61, 64

K

keyboard connection	73
keyboard test	77

L

language	14, 63
----------------	--------

M

manual reference optimization	29, 60
Min Weigh	51
minimum reference weight	29, 54
mode settings	67
multi tare	60

96

N	
negative tolerance	35, 36
P	
parity	69
password	39, 40, 56, 66
percentage accuracy	29, 30
percentage accuracy info line	62
piece counting mode	60
piece weight lower limit.....	22
piece weight optimization.....	22
piece weight upper limit	22
positive tolerance	35, 36
preset tare	60
pre-tare	17
pre-tare weight	19
printer	18, 27, 74
printout	79
push button tare.....	50
R	
range symbol.....	15
reference	26
reference number.....	60
reference optimization	29
reference scale	31, 60, 67, 72
reference weight	26
reference weight determination.....	19, 29
reset	52, 63, 66, 70, 79
resolution	37, 49
S	
Sample reports	82
Sample/Tare	53
save as article.....	60
Save As Article function	24
Scale test.....	77
search criterion	56
Sendemodus.....	58
serial number.....	78
setpoint tol-	58
short-input mode.....	19
SICS command set	90
sleep function	64
softkey	59
softkey configuration.....	59
stability detector	15
Stability settings	51
summary report.....	33
T	
tare.....	16
tare memory	50
tare weight.....	16
tare weight memory	60
Tare/Sample-	53
target weight	35, 36
time	30
time info line	62
timeout status	62
TOLEDO Continuous	91
tolerance limits	35
U	
unit - toggle Unit1 / Unit2.....	60
user prompting	53
user specified user prompting.....	53
V	
vibration settings.....	51
W	
Weigh key	27
weighing mode.....	60
weighing range.....	15
weight display size.....	65
Z	
zeroing	13



Subject to technical changes.
Printed on 100% chlorine-free paper.
For the sake of our environment.