

Čeština	Návod k použití Tiskárna P25, P26, P28
Dansk	Brugervejledning Printer P25, P26, P28
Hrvatski	Korisnički priručnik Pisač P25, P26, P28
Magyar	Felhasználói útmutató Nyomtató P25, P26, P28
Italiano	Manuale per l'utente Stampante P25, P26, P28
Nederlands	Handleiding Printer P25, P26, P28
Polski	Podręcznik użytkownika Drukarka P25, P26, P28
Português	Manual do usuário Impressora P25, P26, P28
Român	Manual de operare Imprimantă P25, P26, P28
Slovenská	Používateľská príručka Tlačiareň P25, P26, P28
Svenska	Användarmanual Skrivare P25, P26, P28
Türkçe	Kullanım kılavuzu Yazıcı P25, P26, P28
한국어	사용자 매뉴얼 프린터 P25, P26, P28
العرب	دليل المستخدم الطابعة P25, P26, P28



METTLER TOLEDO



Tento návod k použití obsahuje stručné pokyny a informace o tom, jak uvést přístroj do provozu bezpečným a efektivním způsobem. Před prováděním jakýchkoli úkonů je obsluha povinná se nejprve důkladně seznámit s tímto návodem a porozumět jeho obsahu.

Podrobné informace naleznete vždy v referenční příručce (RM).

► www.mt.com/printer-p-20-RM

Popis tiskárny

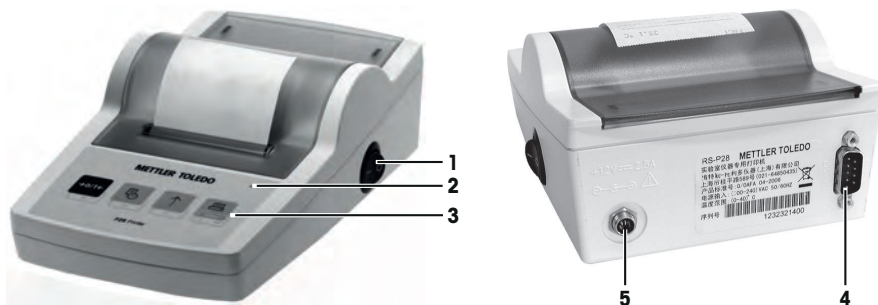

1	Hlavní vypínač	2	Světelná kontrolka – indikátor stavu
3	Ovládací panel	4	Zásuvka rozhraní
5	Napájení		
1	Tænd/sluk-knap	2	Indikatorlampe – statusindikator
3	Kontrolpanel	4	Grænsefladestik
5	Strømtilslutning		
1	Prekidač za uključivanje/isključivanje	2	Kontrolna lampica – indikator statusa
3	Upravljačka ploča	4	Priključnica sučelja
5	Priključak napajanja		
1	Be/kikapcsoló gomb	2	Jelzőlámpa – állapotjelző
3	Vezérlőpanel	4	Interfészcsatlakozó
5	Hálózati áramellátás csatlakoztatása		
1	Interruttore di accensione/spengimento	2	Lampada spia - indicatore di stato
3	Pannello di controllo	4	Connettore interfaccia
5	Collegamento alimentazione		
1	Aan/uit-schakelaar	2	Signaallamp – statusindicator
3	Bedieningspaneel	4	Interfaceconnector
5	Voedingsaansluiting		
1	Wyłącznik On/Off	2	Dioda kontrolna — wskaźnik stanu
3	Panel sterowania	4	Złącze interfejsu
5	Podłączenie zasilania		
1	Interruptor ligar/desligar	2	Lâmpada piloto – indicador de status
3	Painel de controle	4	Conector de interface
5	Conexão de energia		
1	Comutator PORNIT/OPRIT	2	Bec de semnalizare – indicator de stare
3	Panou de comandă	4	Conector interfață
5	Priză de alimentare		

1	Vypínač	2	Kontrolka – indikátor stavu
3	Ovládací panel	4	Konektor rozhrania
5	Pripojka sieťového napájania		







1	På-/avbrytare	2	Kontrollampa – statusindikator
3	Kontrollpanel	4	Gränssnittskontakt
5	Strömanslutning		

1	Açma/Kapatma Anahtarı	2	Pilot lamba – durum göstergesi
3	Kontrol paneli	4	Arabirim konektörü
5	Güç bağlantısı		







1	On/Off 스위치	2	파일럿 램프 - 상태 표시기
3	제어 패널	4	인터페이스 커넥터
5	전원 연결		

	المصباح الإرشادي - مؤشر الحالة	2	مفتاح التشغيل/الإيقاف	1
	موصل الواجهة	4	لوحة التحكم	3
			توصيل الطاقة	5







Přehled funkcí

Tlačítko	P25	P26	P28
	<ul style="list-style-type: none"> • Posun papíru • Položky menu (+ tlačítko pro zapnutí) 	<ul style="list-style-type: none"> • Posun papíru • Procházení položkami menu nahoru 	<ul style="list-style-type: none"> • Posun papíru • Procházení položkami menu nahoru
	–	<ul style="list-style-type: none"> • Vynulování/tárování váhy • Zrušit – odejít 	<ul style="list-style-type: none"> • Vynulování/tárování váhy • Zrušit – odejít
	–	<ul style="list-style-type: none"> • Tisk data a času • Procházení položkami menu dolů 	<ul style="list-style-type: none"> • Tisk data a času • Procházení položkami menu dolů
	–	<ul style="list-style-type: none"> • Tisk hodnoty hmotnosti • Otevření menu – výběr následující položky menu • Uložení nastavení 	<ul style="list-style-type: none"> • Tisk hodnoty hmotnosti • Otevření menu – výběr následující položky menu • Uložení nastavení
	–	–	<ul style="list-style-type: none"> • Aplikace sčítání
	–	–	<ul style="list-style-type: none"> • Aplikace statistiky







Oversigt over funktioner

Tast	P25	P26	P28
	<ul style="list-style-type: none"> Papirindføring Menupunkt (+ Tænd-knap) 	<ul style="list-style-type: none"> Papirindføring Rul op-menuvalg 	<ul style="list-style-type: none"> Papirindføring Rul op-menuvalg
	–	<ul style="list-style-type: none"> Nulstilling/tarering af vægten Annulér – afslut 	<ul style="list-style-type: none"> Nulstilling/tarering af vægten Annulér – afslut
	–	<ul style="list-style-type: none"> Udskrift af dato og klokkeslæt Rul ned-menuvalg 	<ul style="list-style-type: none"> Udskrift af dato og klokkeslæt Rul ned-menuvalg
	–	<ul style="list-style-type: none"> Udskrivning af stabile vægtværdier Åbning af menuen – vælg næste menupunkt Gem indstillinger 	<ul style="list-style-type: none"> Udskrivning af stabile vægtværdier Åbning af menuen – vælg næste menupunkt Gem indstillinger
	–	–	<ul style="list-style-type: none"> Sammentællingsapplikation
	–	–	<ul style="list-style-type: none"> Statistikapplikation







Pregled funkcija

Tipka	P25	P26	P28
	<ul style="list-style-type: none"> • Umetanje papira • Opcija izbornika (+ prekidač za uključivanje) 	<ul style="list-style-type: none"> • Umetanje papira • Opcija pomicanja prema gore u izborniku 	<ul style="list-style-type: none"> • Umetanje papira • Opcija pomicanja prema gore u izborniku
	–	<ul style="list-style-type: none"> • Nuliranje/tariranje vage • Prekid – izlaz 	<ul style="list-style-type: none"> • Nuliranje/tariranje vage • Prekid – izlaz
	–	<ul style="list-style-type: none"> • Ispis datuma i vremena • Opcija pomicanja prema dolje u izborniku 	<ul style="list-style-type: none"> • Ispis datuma i vremena • Opcija pomicanja prema dolje u izborniku
	–	<ul style="list-style-type: none"> • Ispis stabilnih vrijednosti vaganja • Otvaranje izbornika – odabir sljedeće opcije u izborniku • Postavke spremanja 	<ul style="list-style-type: none"> • Ispis stabilnih vrijednosti vaganja • Otvaranje izbornika – odabir sljedeće opcije u izborniku • Postavke spremanja
	–	–	<ul style="list-style-type: none"> • Aplikacija zbrajanja
	–	–	<ul style="list-style-type: none"> • Aplikacija statistike







A funkciók áttekintése

Gomb	P25	P26	P28
	<ul style="list-style-type: none"> Papíradagolás Menüopció (+ bekapcsológomb) 	<ul style="list-style-type: none"> Papíradagolás Menüopció felfelé görgetése 	<ul style="list-style-type: none"> Papíradagolás Menüopció felfelé görgetése
	–	<ul style="list-style-type: none"> Mérleg lenullázása/tárázása Megszakítás – kilépés 	<ul style="list-style-type: none"> Mérleg lenullázása/tárázása Megszakítás – kilépés
	–	<ul style="list-style-type: none"> Printout dátummal és idővel ellátva Menüopció lefelé görgetése 	<ul style="list-style-type: none"> Printout dátummal és idővel ellátva Menüopció lefelé görgetése
	–	<ul style="list-style-type: none"> Stabil tömegértékek nyomtatása A menü megnyitása – a következő menüelem kiválasztása Beállítások mentése 	<ul style="list-style-type: none"> Stabil tömegértékek nyomtatása A menü megnyitása – a következő menüelem kiválasztása Beállítások mentése
	–	–	<ul style="list-style-type: none"> Összesítő alkalmazás
	–	–	<ul style="list-style-type: none"> Statisztikai alkalmazás







Panoramica delle funzioni

Tasto	P25	P26	P28
	<ul style="list-style-type: none"> Alimentazione carta Opzione menu (+ interruttore accensione) 	<ul style="list-style-type: none"> Alimentazione carta Opzione menu a scorrimento verso l'alto 	<ul style="list-style-type: none"> Alimentazione carta Opzione menu a scorrimento verso l'alto
	–	<ul style="list-style-type: none"> Azzeramento/tara della bilancia Annulla – esci 	<ul style="list-style-type: none"> Azzeramento/tara della bilancia Annulla – esci
	–	<ul style="list-style-type: none"> Stampa data/ora Opzione menu a scorrimento verso il basso 	<ul style="list-style-type: none"> Stampa data/ora Opzione menu a scorrimento verso il basso
	–	<ul style="list-style-type: none"> Stampa di valori di peso stabili Aprire il menu – selezionare l'opzione menu successiva Salvare le impostazioni 	<ul style="list-style-type: none"> Stampa di valori di peso stabili Aprire il menu – selezionare l'opzione menu successiva Salvare le impostazioni
	–	–	<ul style="list-style-type: none"> Applicazione Totale
	–	–	<ul style="list-style-type: none"> Applicazione Statistiche







Overzicht van functies

Toets	P25	P26	P28
	<ul style="list-style-type: none"> Papiertoevoer Menuoptie (+ aanschakelaar) 	<ul style="list-style-type: none"> Papiertoevoer Menuoptie omhoog schuiven 	<ul style="list-style-type: none"> Papiertoevoer Menuoptie omhoog schuiven
	–	<ul style="list-style-type: none"> De balans op nul stellen/tarreren Afbreken – afsluiten 	<ul style="list-style-type: none"> De balans op nul stellen/tarreren Afbreken – afsluiten
	–	<ul style="list-style-type: none"> Datum en tijd afdrukken Menuoptie omlaag schuiven 	<ul style="list-style-type: none"> Datum en tijd afdrukken Menuoptie omlaag schuiven
	–	<ul style="list-style-type: none"> Stabiele weegwaarden afdrukken Het menu openen – selecteer de volgende menuoptie Instellingen opslaan 	<ul style="list-style-type: none"> Stabiele weegwaarden afdrukken Het menu openen – selecteer de volgende menuoptie Instellingen opslaan
	–	–	<ul style="list-style-type: none"> Toepassing Totaliseren
	–	–	<ul style="list-style-type: none"> Toepassing Statistieken







Przegląd funkcji

Przy-cisk	P25	P26	P28
	<ul style="list-style-type: none"> Podawanie papieru Opcja menu (+ włącznik) 	<ul style="list-style-type: none"> Podawanie papieru Przewijanie opcji menu w górę 	<ul style="list-style-type: none"> Podawanie papieru Przewijanie opcji menu w górę
	–	<ul style="list-style-type: none"> Zerowanie / Tarowanie wagi Przerwij — wyjście 	<ul style="list-style-type: none"> Zerowanie / Tarowanie wagi Przerwij — wyjście
	–	<ul style="list-style-type: none"> Wydruk daty i godziny Przewijanie opcji menu w dół 	<ul style="list-style-type: none"> Wydruk daty i godziny Przewijanie opcji menu w dół
	–	<ul style="list-style-type: none"> Drukowanie stabilnej wartości masy Otwieranie menu — wybór następnej opcji menu Zapisywanie ustawień 	<ul style="list-style-type: none"> Drukowanie stabilnej wartości masy Otwieranie menu — wybór następnej opcji menu Zapisywanie ustawień
	–	–	<ul style="list-style-type: none"> Program sumowania
	–	–	<ul style="list-style-type: none"> Program Statystyki







Visão geral das funções

Tecla	P25	P26	P28
	<ul style="list-style-type: none"> Alimentação de papel Opção do menu (Ligar +) 	<ul style="list-style-type: none"> Alimentação de papel Menu de opção de rolar para cima 	<ul style="list-style-type: none"> Alimentação de papel Menu de opção de rolar para cima
	–	<ul style="list-style-type: none"> Zerar / tarar a balança Cancelar – sair 	<ul style="list-style-type: none"> Zerar / tarar a balança Cancelar – sair
	–	<ul style="list-style-type: none"> Impressão de data e hora Menu de opção de rolar para baixo 	<ul style="list-style-type: none"> Impressão de data e hora Menu de opção de rolar para baixo
	–	<ul style="list-style-type: none"> Impressão de valores de peso estáveis Abrir o menu – selecione a opção de menu seguinte Salvar as configurações 	<ul style="list-style-type: none"> Impressão de valores de peso estáveis Abrir o menu – selecione a opção de menu seguinte Salvar as configurações
	–	–	<ul style="list-style-type: none"> Aplicação de totalização
	–	–	<ul style="list-style-type: none"> Aplicação estatística







Prezentare de ansamblu a funcțiilor

Tastă	P25	P26	P28
	<ul style="list-style-type: none"> Alimentare cu hârtie Opțiune de meniu (+ comutator PORNIT) 	<ul style="list-style-type: none"> Alimentare cu hârtie Derulare în sus în opțiunea de meniu 	<ul style="list-style-type: none"> Alimentare cu hârtie Derulare în sus în opțiunea de meniu
	–	<ul style="list-style-type: none"> Resetare la zero/tararea balanței Abandonare – ieșire 	<ul style="list-style-type: none"> Resetare la zero/tararea balanței Abandonare – ieșire
	–	<ul style="list-style-type: none"> Imprimarea datei și orei Derulare în jos în opțiunea de meniu 	<ul style="list-style-type: none"> Imprimarea datei și orei Derulare în jos în opțiunea de meniu
	–	<ul style="list-style-type: none"> Imprimarea valorilor de cântărire stabile Deschiderea meniului – selectarea următoarei opțiuni de meniu Salvarea setărilor 	<ul style="list-style-type: none"> Imprimarea valorilor de cântărire stabile Deschiderea meniului – selectarea următoarei opțiuni de meniu Salvarea setărilor
	–	–	<ul style="list-style-type: none"> Aplicația Adunare
	–	–	<ul style="list-style-type: none"> Aplicația Statistici







Prehľad funkcií

Tlačidlo	P25	P26	P28
	<ul style="list-style-type: none"> Podávanie papiera Položka ponuky (+ zapnutie) 	<ul style="list-style-type: none"> Podávanie papiera Prechádzanie položkami ponuky smerom nahor 	<ul style="list-style-type: none"> Podávanie papiera Prechádzanie položkami ponuky smerom nahor
	–	<ul style="list-style-type: none"> Vynulovanie/tarovanie váh Zrušenie – ukončenie 	<ul style="list-style-type: none"> Vynulovanie/tarovanie váh Zrušenie – ukončenie
	–	<ul style="list-style-type: none"> Tlač dátumu a času Prechádzanie položkami ponuky smerom nadol 	<ul style="list-style-type: none"> Tlač dátumu a času Prechádzanie položkami ponuky smerom nadol
	–	<ul style="list-style-type: none"> Tlač stabilných hodnôt hmotnosti Otvorenie ponuky – výber nasledujúcej položky ponuky Uloženie nastavení 	<ul style="list-style-type: none"> Tlač stabilných hodnôt hmotnosti Otvorenie ponuky – výber nasledujúcej položky ponuky Uloženie nastavení
	–	–	<ul style="list-style-type: none"> Aplikácia Súčet
	–	–	<ul style="list-style-type: none"> Aplikácia Štatistika







Översikt över funktioner

Knapp	P25	P26	P28
	<ul style="list-style-type: none"> Pappersmatning Menyalternativ (+ påbrytare) 	<ul style="list-style-type: none"> Pappersmatning Menyalternativ för att bläddra uppåt 	<ul style="list-style-type: none"> Pappersmatning Menyalternativ för att bläddra uppåt
	–	<ul style="list-style-type: none"> Nollning/tarering av vågen Avbryt – avsluta 	<ul style="list-style-type: none"> Nollning/tarering av vågen Avbryt – avsluta
	–	<ul style="list-style-type: none"> Utskrift av datum och tid Menyalternativ för att bläddra nedåt 	<ul style="list-style-type: none"> Utskrift av datum och tid Menyalternativ för att bläddra nedåt
	–	<ul style="list-style-type: none"> Utskrift av stabila viktvärden Öppna menyn – välja nästa menyalternativ Spara inställningar 	<ul style="list-style-type: none"> Utskrift av stabila viktvärden Öppna menyn – välja nästa menyalternativ Spara inställningar
	–	–	<ul style="list-style-type: none"> Tillämpning för summering
	–	–	<ul style="list-style-type: none"> Tillämpning för statistik

İşlevlere genel bakış

Tuş	P25	P26	P28
	<ul style="list-style-type: none">• Kağıt besleme• Menü seçeneği (+ Açma anahtarı)	<ul style="list-style-type: none">• Kağıt besleme• Yukarı kaydırma menü seçeneği	<ul style="list-style-type: none">• Kağıt besleme• Yukarı kaydırma menü seçeneği
	–	<ul style="list-style-type: none">• Terazinin sıfırlanması/darasının alınması• İptal – çıkış	<ul style="list-style-type: none">• Terazinin sıfırlanması/darasının alınması• İptal – çıkış
	–	<ul style="list-style-type: none">• Tarih ve saat çıktısı• Aşağı kaydırma menü seçeneği	<ul style="list-style-type: none">• Tarih ve saat çıktısı• Aşağı kaydırma menü seçeneği
	–	<ul style="list-style-type: none">• Stabil tartım değerlerini yazdırma• Menüyu açma – sonraki menü seçeneğini seçme• Ayarları kaydetme	<ul style="list-style-type: none">• Stabil tartım değerlerini yazdırma• Menüyu açma – sonraki menü seçeneğini seçme• Ayarları kaydetme
	–	–	<ul style="list-style-type: none">• Toplama uygulaması
	–	–	<ul style="list-style-type: none">• İstatistik uygulaması

기능 개요

키	P25	P26	P28
	<ul style="list-style-type: none"> • 용지 급지 • 메뉴 옵션(+ On 스위치) 	<ul style="list-style-type: none"> • 용지 급지 • 스크롤 업 메뉴 옵션 	<ul style="list-style-type: none"> • 용지 급지 • 스크롤 업 메뉴 옵션
	-	<ul style="list-style-type: none"> • 저울 영점 설정/용기 중량 측정 • 중단 - 종료 	<ul style="list-style-type: none"> • 저울 영점 설정/용기 중량 측정 • 중단 - 종료
	-	<ul style="list-style-type: none"> • 날짜 및 시간 인쇄 • 스크롤 다운 메뉴 옵션 	<ul style="list-style-type: none"> • 날짜 및 시간 인쇄 • 스크롤 다운 메뉴 옵션
	-	<ul style="list-style-type: none"> • 안정적인 중량값 인쇄 • 메뉴 열기 - 다음 메뉴 옵션 선택 • 설정 저장 	<ul style="list-style-type: none"> • 안정적인 중량값 인쇄 • 메뉴 열기 - 다음 메뉴 옵션 선택 • 설정 저장
	-	-	<ul style="list-style-type: none"> • 통계 애플리케이션
	-	-	<ul style="list-style-type: none"> • 통계 애플리케이션

نظرة عامة على الوظائف

المف تاح	P25	P26	P28
	<ul style="list-style-type: none"> • تغذية الورق • خيار القائمة (+) مفتاح التشغيل) 	<ul style="list-style-type: none"> • تغذية الورق • التمرير لأعلى في خيارات القائمة 	<ul style="list-style-type: none"> • تغذية الورق • التمرير لأعلى في خيارات القائمة
		<ul style="list-style-type: none"> • تصغير/تفريغ الميزان • إلغاء - خروج 	<ul style="list-style-type: none"> • تصغير/تفريغ الميزان • إلغاء - خروج
		<ul style="list-style-type: none"> • طباعة التاريخ والوقت • التمرير لأسفل في خيارات القائمة 	<ul style="list-style-type: none"> • طباعة التاريخ والوقت • التمرير لأسفل في خيارات القائمة
		<ul style="list-style-type: none"> • طباعة قيم الوزن الثابتة • فتح القائمة - تحديد خيار القائمة التالي • حفظ الإعدادات 	<ul style="list-style-type: none"> • طباعة قيم الوزن الثابتة • فتح القائمة - تحديد خيار القائمة التالي • حفظ الإعدادات
			<ul style="list-style-type: none"> • تطبيق الجمع
			<ul style="list-style-type: none"> • تطبيق الإحصائيات

Návod k použití Tiskárna	Čeština
Brugervejledning Printer	Dansk
Korisnički priručnik Pisač	Hrvatski
Felhasználói útmutató Nyomtató	Magyar
Manuale per l'utente Stampante	Italiano
Handleiding Printer	Nederlands
Podręcznik użytkownika Drukarka	Polski
Manual do usuário Impressora	Português
Manual de operare Imprimantă	Român
Používateľská príručka Tlačiareň	Slovenská
Användarmanual Skrivare	Svenska
Kullanım kılavuzu Yazıcı	Türkçe
사용자 매뉴얼 프린터	한국어

1 Bezpečnostní informace

Pro tento přístroj jsou k dispozici dva dokumenty s názvem "Návod k použití" a "Návod k obsluze".

- Návod k použití popisuje, jak správně začít přístroj používat.
- Návod k obsluze obsahuje podrobný popis přístroje a jeho funkcí.
- Oba dokumenty si uschovejte pro pozdější použití.
- Oba návody předejte dalším uživatelům spolu s přístrojem.

Přístroj používejte pouze v souladu s návodem k použití a návodem k obsluze. Pokud přístroj nebudete používat podle obou návodů anebo jej jakkoli upravíte, může tím dojít k narušení jeho bezpečnosti a Mettler-Toledo GmbH společnost nenese žádnou odpovědnost za možné následky.

1.1 Další související dokumenty



Tento návod k použití obsahuje stručné pokyny a informace o tom, jak uvést přístroj do provozu bezpečným a efektivním způsobem. Před prováděním jakýchkoli úkonů je obsluha povinná se nejprve důkladně seznámit s tímto návodem a porozumět jeho obsahu.

Podrobné informace naleznete vždy v referenční příručce (RM).

► www.mt.com/printer-p-20-RM

1.2 Definice signálních slov a výstražných symbolů

Bezpečnostní pokyny obsahují důležité informace týkající se bezpečnosti. Nerespektování bezpečnostních pokynů může vést ke zranění osob, poškození přístroje, nesprávné funkci a chybným výsledkům. Bezpečnostní pokyny jsou označeny následujícími signálními slovy a výstražnými symboly:

Signální slova

VAROVÁNÍ Označuje nebezpečnou situaci se střední mírou rizika, která může způsobit smrt nebo vážné zranění.

UPOZORNĚNÍ Označuje nebezpečnou situaci s nízkou mírou rizika, která může způsobit lehké nebo středně vážné zranění.

OZNÁMENÍ Označuje nebezpečnou situaci s nízkou mírou rizika, která může způsobit poškození přístroje, jiné hmotné škody, závady, chybné výsledky či ztrátu dat.

Výstražné symboly



Úraz elektrickým proudem



Obecné nebezpečí: přečtěte si návod k obsluze, kde naleznete informace o nebezpečích a bezpečnostních opatřeních.



Upozornění

1.3 Bezpečnostní pokyny týkající se konkrétního produktu

Určené použití

Tento přístroj je určen k použití kvalifikovaným personálem v laboratořích. Je určen k tisku protokolů.

Jakýkoli jiný druh použití nebo provozu, který nespadá do vymezení dle technických specifikací, je bez písemného souhlasu společnosti Mettler-Toledo GmbH považován za odporující zamýšlenému účelu přístroje.

Odpovědnost vlastníka přístroje

Vlastníkem přístroje se rozumí osoba, která je držitelem právního nároku k přístroji a používá jej nebo pověří jinou osobu jeho používáním, případně osoba, která je ze zákona považována za provozovatele přístroje. Vlastník přístroje odpovídá za bezpečnost všech uživatelů přístroje a třetích osob.

METTLER TOLEDO předpokládá, že vlastník přístroje proškolí uživatele, jak přístroj bezpečně na pracovišti používat a jak se vypořádat s možnými nebezpečími. METTLER TOLEDO předpokládá, že vlastník přístroje poskytne nezbytné ochranné pracovní prostředky.

Bezpečnostní pokyny



VAROVÁNÍ

Smrt nebo vážné zranění v důsledku úrazu elektrickým proudem

Kontakt se součástmi pod elektrickým proudem může způsobit smrt nebo zranění.

- 1 Používejte pouze síťový adaptér schválený METTLER TOLEDO s proudově omezeným výstupem SELV.
- 2 Napájecí kabel zapojte do uzemněné zásuvky a zkontrolujte správnou polaritu.
- 3 Nevystavujte elektrické kabely ani přípojky působení kapalin a vlhkosti.
- 4 Zkontrolujte, zda kabely a zástrčka nejsou poškozené, a v případě potřeby je vyměňte.



OZNÁMENÍ

Poškození přístroje v důsledku použití nesprávných dílů

Použití nevhodných dílů může způsobit poškození nebo závadu přístroje.

- Používejte pouze díly od METTLER TOLEDO, které jsou určeny pro použití s vaším přístrojem.

2 Instalace a uvedení do provozu

2.1 Rozsah dodávky

- Síťový adaptér
- Napájecí kabel (podle země určení)
- Návod k použití
- Prohlášení o shodě

2.2 Připojení tiskárny k napájení



! VAROVÁNÍ

Smrt nebo vážné zranění v důsledku úrazu elektrickým proudem

Kontakt se součástmi pod elektrickým proudem může způsobit smrt nebo zranění.

- 1 Používejte pouze síťový adaptér schválený METTLER TOLEDO s proudově omezeným výstupem SELV.
- 2 Napájecí kabel zapojte do uzemněné zásuvky a zkontrolujte správnou polaritu.
- 3 Nevystavujte elektrické kabely ani přípojky působení kapalin a vlhkosti.
- 4 Zkontrolujte, zda kabely a zástrčka nejsou poškozené, a v případě potřeby je vyměňte.



OZNÁMENÍ

Poškození síťového adaptéru v důsledku přehřátí!

V případě zakrytí nebo umístění síťového adaptéru do uzavřené nádoby/obalu nebude tento dostatečně ochlazován a přehřeje se.

- 1 Síťový adaptér nezakrývejte.
- 2 Nevkládejte síťový adaptér do uzavřené nádoby/obalu.

Tiskárna je dodávána s univerzálním síťovým adaptérem nebo se síťovým adaptérem s napájecím kabelem podle země určení.

- Kabely instalujte tak, aby nemohlo dojít k jejich poškození a aby nemohly rušit provoz přístroje.
- Konektor napájecího kabelu zapojte do snadno přístupné uzemněné zásuvky.

- 1 Síťový adaptér zasuňte do zásuvky na zadní straně tiskárny.
- 2 Konektor zajistěte pojistnou maticí.
- 3 Do zásuvky síťového adaptéru zapojte 3žilový uzemněný napájecí kabel.
- 4 Tiskárnu připojte k váze pomocí propojovacího kabelu.
- 5 Zapněte váhu.
- 6 Připojte tiskárnu k napájení.
- 7 Tiskárnu zapněte **I/O**.

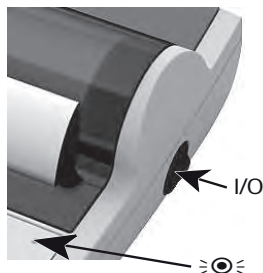

Poznámka

Pouze rozhraní RS232: světelná kontrolka bliká, dokud není připojen přístroj. Pokud kontrolka stále bliká, přečtěte si kapitolu "Odstraňování problémů" v referenční příručce.

2.3 Vložení papíru





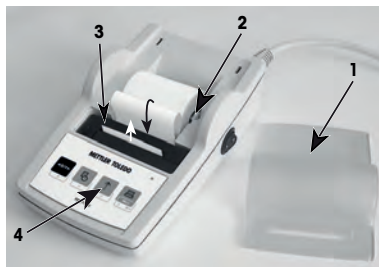



- 1 Odstraňte kryt papíru (zatáhněte za zadní část) (1).
- 2 Vřeteno zasuňte do otvoru v papírovém kotoučku (2).
- 3 Papír protáhněte ve směru šipky štěrbinou tiskové jednotky (3).
- 4 Stiskněte a přidržte, dokud se papír nezasune do tiskárny (4).
- 5 Papír protáhněte štěrbinou v krytu papíru.
- 6 Nasadte zpět kryt papíru (1).

Pokud se po prvních tiscích změní nastavení připojení váhy (přenosová rychlost, bity, handshake), je nutné tiskárnu restartovat. Vypněte a zapněte tiskárnu, abyste znovu spustili automatickou detekci přenosové rychlosti. Automatickou přenosovou rychlost je možné vypnout.















3 Funkce tlačítek

















Tiskárna P25

Úroveň obsluhy	 Krátce stiskněte	 Stiskněte a přidržte
	jednořádkový posun	kontinuální posun (až do uvolnění)
 	Test tiskárny s vytištěním nastavení	otevřít menu
Úroveň menu	 Krátce stiskněte	 Stiskněte a přidržte
	další položka menu	uložit

Tiskárna P26

Úroveň obsluhy	 Krátce stiskněte	 Stiskněte a přidržte
	vynulování/tárování váhy	–
	tisk data a času	–
	jednořádkový posun	kontinuální posun (až do uvolnění)
	tisk	otevřít menu
Úroveň menu	 Krátce stiskněte	 Stiskněte a přidržte
 odejít	 dolů	 nahoru
	 další	 uložit

Tiskárna P28

Úroveň obsluhy	 Krátce stiskněte	 Stiskněte a přidržte
	vynulování/tárování váhy	–
	tisk data a času	–
	jednořádkový posun	kontinuální posun (až do uvolnění)
	tisk	otevřít menu
Úroveň menu	 Krátce stiskněte	 Stiskněte a přidržte
 odejít	 dolů	 nahoru
	 další	 uložit
Úroveň funkcí	 Krátce stiskněte	 Stiskněte a přidržte
 M+	Spustit aplikaci sčítání	Ukončit aplikaci sčítání
 M+	Spustit aplikaci statistiky	Ukončit aplikaci statistiky

4 Menu

4.1 Tiskárna P25

☞ Krátce stiskněte	☞ Stiskněte a přidržte	Tisk
<div style="border: 1px solid black; padding: 2px; text-align: center;">Settings</div> <div style="border: 1px solid black; padding: 2px; text-align: center;">Reset</div>		Settings Reset
<div style="border: 1px solid black; padding: 2px; text-align: center;">Pouze rozhraní RS232</div> <div style="border: 1px solid black; padding: 2px; text-align: center;">Auto Baudrate</div> <div style="border: 1px solid black; padding: 2px; text-align: center;">On</div>	Resetujte váhu	----- Reset done ----- Current settings: Baudrate: 9600 Bit/Parity: 8 Bit Non Handshake: Off Char Set: IBM/DOS
<div style="border: 1px solid black; padding: 2px; text-align: center;">Auto Baudrate</div> <div style="border: 1px solid black; padding: 2px; text-align: center;">Off</div>	Uložit	Auto Baudrate: On -----STORED----- ... <i>"current settings"</i>
<div style="border: 1px solid black; padding: 2px; text-align: center;">Char Set</div> <div style="border: 1px solid black; padding: 2px; text-align: center;">IBM / DOS</div>	Uložit	Auto Baudrate: Off -----STORED----- ... <i>"current settings"</i>
<div style="border: 1px solid black; padding: 2px; text-align: center;">IBM / DOS Cyrillic</div>	Uložit	IBM/DOS -----STORED----- ... <i>"current settings"</i>
<div style="border: 1px solid black; padding: 2px; text-align: center;">IBM / DOS Japanese</div>	Uložit	IBM/DOS Cyrillic -----STORED----- ... <i>"current settings"</i>
<div style="border: 1px solid black; padding: 2px; text-align: center;">ANSI / WIN Latin 1</div>	Uložit	IBM/DOS Japanese -----STORED----- ... <i>"current settings"</i>
<div style="border: 1px solid black; padding: 2px; text-align: center;">ANSI / WIN Cyrillic</div>	Uložit	ANSI/WIN Latin 1 -----STORED----- ... <i>"current settings"</i>
<div style="border: 1px solid black; padding: 2px; text-align: center;">ANSI / WIN Japanese</div>	Uložit	ANSI/WIN Cyrillic -----STORED----- ... <i>"current settings"</i>
<div style="border: 1px solid black; padding: 2px; text-align: center;">Balance Feature</div> <div style="border: 1px solid black; padding: 2px; text-align: center;">Enable</div>	Uložit	ANSI/WIN Japanese -----STORED----- ... <i>"current settings"</i>
<div style="border: 1px solid black; padding: 2px; text-align: center;">Balance Feature</div> <div style="border: 1px solid black; padding: 2px; text-align: center;">Disable</div>	Uložit	Balance Feature: Enable -----STORED----- ... <i>"current settings"</i>

Možnosti menu
Tovární nastavení

4.2 Tiskárna P26 / P28

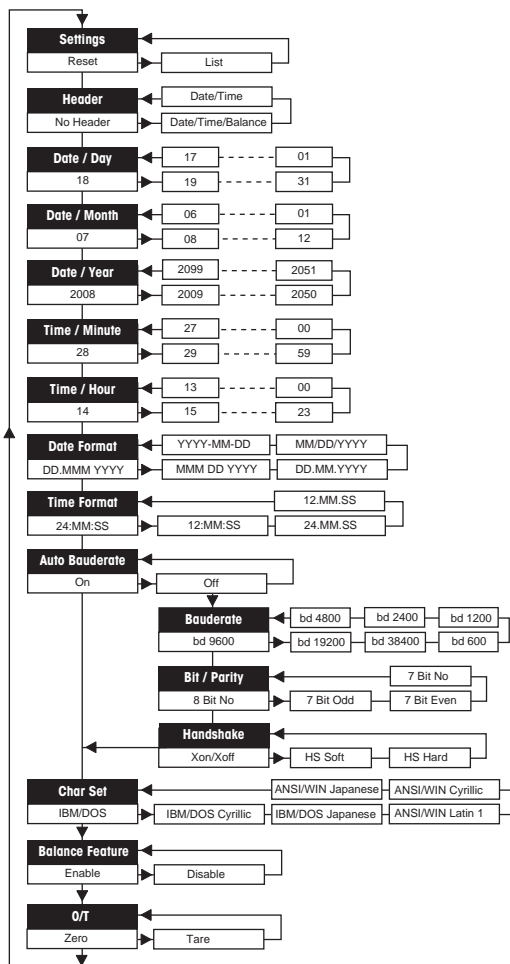

Příklady při použití displeje váhy:



Nastavení	
Reset	rESEt
List	L ISt
Záhlaví	
*No Header	no Hdr
Date/Time	d t Hdr
Date/Time/Balance	dtb Hdr
Datum den**	
18	dRY 18
Datum měsíc**	
07	Month 07
Datum rok**	
2008	YEAR-2008
Čas minuta**	
28	Min. 28
Čas hodina**	
14	Hour 14
Formát data***	
DD.MMM.YYYY	ddMMN Y
MMM DD YYYY	MMN dd Y
DD.MM.YYYY	ddMM.Y
MM/DD/YYYY	MM dd Y
YYYY-MM-DD	Y-MM-dd
Formát času***	
24:MM:SS	24-MM-SS
12:MM:SS	12-MM-SS
24.MM.SS	24MMSS
12.MM.SS	12MMSS
Prenosová rychlost	
*9600	bd9600
19200	bd.19200
38400	bd38400
600	bd600
1200	bd.1200
2400	bd2400
4800	bd4800
Bit/Parita	
*8 Bit No	8b-no
7 Bit Odd	7b-odd
7 Bit Even	7b-E
7 Bit No	7b-no
Handshake	
*Xon/Xoff	HS oFF
HS Soft	HS SoFFt
HS Hard	HS HARd
Znaková sada	
*IBM/DOS	d05
IBM/DOS Cyrillic	d05 C Yr
IBM/DOS Japanese	d05 JAP
Ansi/Win Latin 1	11 in LAt
Ansi/Win Cyrillic	11 in C Yr
Ansi/Win Japanese	11 in JAP
Tárování/nulování	
*Zero	ZErO
Tare	tARt

Možnosti menu
Tovární nastavení

- * tovární nastavení
- ** přístroje s vestavěnými hodinami: nelze použít, vestavěné hodiny mají přednost
- *** přístroje s vestavěnými hodinami: formát tisku má přednost

Příklad nastavení dne (pouze P26/P28)

Otevřete menu

- Přidržte tlačítko , dokud se neobjeví **Reset (Resetovat)**.
- Pomocí tlačítka  vyberte položku menu **Day (Den)**.
- Vyberte příslušný den, např. 21.
K posunu nahoru použijte klávesu ↑.
K posunu dolů použijte klávesu ↓.



Uložte nastavení.

- Přidržte tlačítko , dokud se neobjeví **Stored (Uloženo)**.

Aplikace statistiky (pouze P28)



Hmotnost vzorku musí být v rozmezí 70 až 130 % aktuální průměrné hodnoty.
Minimální změna dynamické hmotnosti musí činit 100 d.

- 1 Pro spuštění aplikace statistiky stiskněte tlačítko  (LED kontrolka svítí).
- 2 Vložte nový vzorek a stiskněte **M+**.
- 3 Chcete-li vytisknout mezisoučet, stiskněte .
- 4 Pro tisk a ukončení aplikace statistiky stiskněte a přidržte tlačítko  (LED kontrolka nesvítí).





Poznámka

- Změna jednotky hmotnosti není během spuštěné aplikace možná.
- Maximum je 999 vzorků.

Aplikace sčítání (pouze P28)



Minimální hmotnosti + 1 d.

- 1 Pro spuštění aplikace sčítání stiskněte tlačítko  (LED kontrolka svítí).
- 2 Vložte nový vzorek a stiskněte **M+**.
- 3 Chcete-li vytisknout mezisoučet, stiskněte .
- 4 Pro tisk a ukončení aplikace sčítání stiskněte a přidržte tlačítko  (LED kontrolka nesvítí).



Poznámka

- Změna jednotky hmotnosti není během spuštěné aplikace možná.
- Maximum je 999 vzorků.

5 Údržba



VAROVÁNÍ

Smrt nebo vážné zranění v důsledku úrazu elektrickým proudem

Kontakt se součástmi pod elektrickým proudem může způsobit těžké zranění nebo smrt.

- 1 Před čištěním a údržbou odpojte tiskárnu od napájení.
- 2 Zabraňte styku tiskárny nebo síťového adaptéru s kapalínami.

5.1 Výměna papírového kotoučku

Vložení nového papírového kotoučku je popsáno v části [Vložení papíru ▶ strana 8]. Objednáací číslo papírových kotoučků naleznete v kapitole [Spotřební materiál ▶ strana 16].



Poznámka

Vřeteno vždy vyjměte z původního kotoučku a zasuňte do nového.

5.2 Výměna pásky

Objednací číslo kazety s páskou naleznete v kapitole [Spotřební materiál ▶ strana 16].

- 1 Odstraňte kryt papíru (1).
- 2 Vytáhněte papír z tiskové jednotky (2).



- 3 Vyměňte kazetu s páskou zatlačením ve směru šipky (3).
- 4 Vložte novou kazetu s páskou. Podle potřeby volnou pásku utáhněte kolečkem (4).

Vložení nového papírového kotoučku je popsáno v části [Vložení papíru ▶ strana 8].



5.3 Čištění krytu

Jelikož je kryt tiskárny vyroben ze špičkových a vysoce odolných materiálů, můžete použít všechny jemné čisticí prostředky, které jsou běžně dostupné na trhu.



OZNÁMENÍ

Nebezpečí poškození tiskárny při použití nevhodných postupů čištění

Kryt tiskárny je vyroben z vysoce kvalitních odolných materiálů a může být poškozen použitím některých čisticích prostředků, rozpouštědel nebo abrazivních látek. Poškození tiskárny hrozí také v případě průniku kapalin do krytu.

- 1 K čištění tiskárny používejte vodu a jemný čisticí prostředek.
- 2 Případné rozlité kapaliny ihned otřete.
- 3 Zabraňte proniknutí kapalin do vnitřních částí tiskárny.

Kontaktujte METTLER TOLEDO zástupce společnosti METTLER TOLEDO pro informace o dostupných možnostech servisu. Pravidelná údržba autorizovaným servisním technikem zajistí dlouhodobou konzistentní přesnost vážení a prodlouží životnost tiskárny.

6 Technické údaje

6.1 Obecné technické údaje

Napájení

Síťový adaptér:	Primární: 100–240 V, 50/60 Hz Sekundární: 12 V DC, 2,5 A (s elektronickou ochranou proti přetížení)
Kabel pro síťový adaptér:	3žilový, se zástrčkou podle země určení
Polarita:	 s výstupem SELV (Safety Extra Low Voltage)
Napájecí napětí:	12 V DC
Spotřeba energie:	Max. 2,5 A

Ochrana a normy

Kategorie přepětí:	II
Stupeň znečištění:	2
Normy týkající se bezpečnosti a EMC (elektromagnetické kompatibility):	Viz Prohlášení o shodě.
Rozsah použití:	Používejte pouze ve vnitřních prostorech.

Podmínky prostředí

Nadmořská výška:	až 4 000 m
Okolní teplota:	0 až 40 °C
Skladovací podmínky:	-25 až 60 °C
Relativní vlhkost vzduchu:	Max. 80 % při 31 °C, lineárně klesající na 50 % při 40 °C, nekondenzující

Vlastnosti tiskárny

Techologie tisku:	Jehličková tiskárna 5 x 7, délka řádku 24 znaků
Rychlost tisku:	2,3 řádku za sekundu
Kazeta s páskou:	Vyměnitelná, černá
Papírový kotouček:	Standardní papír 57,5 mm x ø 50 až 60 mm, vsazený do krytu, běžný rozměr
Kvalita tisku:	Tepelně stabilní tisk odolný vůči světlu (GLP, GMP, ISO 9001)
Rozhraní:	RS-P25, RS-P26, RS-P28 USB-P25
RS232C	
USB	
Omezení kompatibility:	<ul style="list-style-type: none"> Funkce datum/čas: nelze použít u vah s vestavěnými hodinami (vestavěné hodiny mají přednost) Funkce vynulování/tárování: nelze použít u všech modelů vah

Rozměry/hmotnost

Rozměry tiskárny (š x h x v):	120 x 203 x 73 mm
Rozměry obalu (š x h x v):	255 x 205 x 150 mm
Čistá hmotnost:	740 g (vč. papírového kotoučku)

7 Spotřební materiál

Popis

Č. dílu

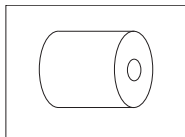

Role papíru (délka: 20 m), sada 5 ks.

00072456

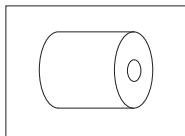

Role papíru (délka: 13 m), samolepicí, sada 3 ks.

11600388

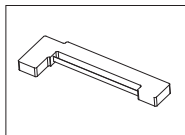

Kazeta s páskou, černá, sada 2 ks

00065975

1 Sikkerhedsoplysninger

Der findes to dokumenter, "Brugervejledning" og "Betjeningsvejledning", til dette instrument.

- Brugervejledningen viser, hvordan du kommer i gang med at bruge instrumentet.
- Betjeningsvejledningen indeholder en samlet beskrivelse af instrumentet og brugen af det.
- Gem begge dokumenter til fremtidig brug.
- Overdrag begge dokumenter, hvis du giver instrumentet videre til andre.

Brug kun instrumentet i overensstemmelse med brugervejledningen og betjeningsvejledningen. Hvis du ikke bruger instrumentet i overensstemmelse med disse dokumenter, eller hvis instrumentet ændres, kan instrumentets sikkerhed forringes, og Mettler-Toledo GmbH påtager sig intet ansvar.

1.1 Yderligere relevante dokumenter



Denne brugervejledning er en kort instruktion, der giver oplysninger om, hvordan de første trin med apparatet håndteres på en sikker og effektiv måde. Medarbejderne skal have læst og forstået denne manual, før der udføres nogen form for opgaver.

Ved behov for yderligere oplysninger: Læs referencemanualen (RM).

► www.mt.com/printer-p-20-RM

1.2 Definitioner af signalord og advarselssymboler

Sikkerhedsbemærkninger indeholder vigtige oplysninger om sikkerhedsproblemer. Der kan opstå personskade, beskadigelse på instrumentet, driftsforstyrrelser og forkerte resultater, hvis sikkerhedsbemærkningerne ignoreres. Sikkerhedsbemærkninger er markeret med følgende symbolbeskrivelser og advarselssymboler:

Signalord

ADVARSEL

En farlig situation med risiko på mellemniveau, der sandsynligvis vil resultere i dødsfald eller alvorlige skader, hvis den ikke undgås.

FORSIGTIG

En farlig situation med lav risiko, der kan resultere i små eller moderate skader, hvis den ikke undgås.

BEMÆRK

En farlig situation med lav risiko, der kan resultere i beskadigelse af instrumentet, andre skader på udstyr eller ejendom, fejlfunktion og forkerte resultater eller tab af data.

Advarselssymboler



Elektrisk stød



Generelle farer: Læs betjeningsvejledningen for at få oplysninger om farer og de heraf følgende foranstaltninger.



Bemærk

1.3 Produktspecifikke sikkerhedsbemærkninger

Tilsigtet brug

Dette instrument er beregnet til at blive brugt af uddannet personale i et laboratorium. Instrumentet er beregnet til udskrivning af protokoller.

Enhver anden anvendelse og funktion ud over begrænsningerne i de tekniske specifikationer, der foretages uden skriftlig tilladelse fra Mettler-Toledo GmbH betragtes som utilsigtet anvendelse.

Instrumentejerens ansvarsområder

Instrumentejereren er den person, der har den juridiske ret til instrumentet, og som bruger instrumentet eller giver en anden person tilladelse til at bruge det, eller den person, der i henhold til lovgivningen anses for at være instrumentets operatør. Instrumentejereren er ansvarlig for sikkerheden for alle brugere af instrumentet og tredjeparter.

METTLER TOLEDO antager, at instrumentejereren uddanner brugere i sikker brug af instrumentet på deres arbejdsplads og håndtering af potentielle farer. METTLER TOLEDO antager, at instrumentejereren stiller det nødvendige beskyttelsesudstyr til rådighed.

Sikkerhedsbemærkninger



ADVARSEL

Dødsfald eller alvorlig tilskadekomst på grund af elektrisk stød

Kontakt med strømførende dele kan resultere i dødsfald eller personskade.

- 1 Anvend kun godkendt METTLER TOLEDO-strømkabel og AC/DC-adapter med spændingsbegrænset SELV-effekt.
- 2 Tilslut strømkablet til en stikkontakt med jordforbindelse. Sørg for, at polerne vender rigtigt.
- 3 Hold alle elektriske ledninger og tilslutninger på afstand af væske og fugt.
- 4 Kontrollér kablerne og strømstikket for skader, og udskift beskadigede kabler og strømstik.



BEMÆRK

Beskadigelse af instrumentet på grund af anvendelse af uegnede dele

Hvis der anvendes uegnede dele sammen med instrumentet, kan det beskadige instrumentet eller bevirke, at det ikke fungerer korrekt.

- Anvend kun dele fra METTLER TOLEDO, som er beregnet til at blive anvendt sammen med dit instrument.

2 Installation og klargøring

2.1 Indhold i leverancen

- AC/DC-adapter
- Strømkabel (landespecifikt)
- Brugervejledning
- Overensstemmelseserklæring

2.2 Tilslutning af printeren til strømforsyningen



⚠ ADVARSEL

Dødsfald eller alvorlig tilskadekomst på grund af elektrisk stød

Kontakt med strømførende dele kan resultere i dødsfald eller personskade.

- 1 Anvend kun godkendt METTLER TOLEDO-strømkabel og AC/DC-adapter med spændingsbegrænset SELV-effekt.
- 2 Tilslut strømkablet til en stikkontakt med jordforbindelse. Sørg for, at polerne vender rigtigt.
- 3 Hold alle elektriske ledninger og tilslutninger på afstand af væske og fugt.
- 4 Kontrollér kablerne og strømslippet for skader, og udskift beskadigede kabler og strømsluk.



BEMÆRK

Beskadigelse af AC/DC-adapteren på grund af overophedning

Hvis AC/DC-adapteren er tildækket eller befinder sig i en beholder, bliver den ikke tilstrækkeligt afkølet og overopheder.

- 1 Undlad at tildække AC/DC-adapteren.
- 2 Læg ikke AC/DC-adapteren i en beholder.

Printeren leveres med en AC/DC-universaladapter eller en AC/DC-adapter med et landespecifikt strømkabel.

- Installer kablerne, så de ikke kan beskadiges eller forstyrre driften.
- Sæt strømkablet i en jordforbundet stikkontakt, der er let tilgængelig.

- 1 Tilslut AC/DC-adapteren i strømfatningen bag på printeren.
- 2 Lås stikket med skruemøtrikken.
- 3 Sæt det 3-benede strømkabel med jordforbindelse i stikket til AC/DC-adapteren.
- 4 Tilslut printeren og vægten med grænsefladekablet.
- 5 Tænd for vægten.
- 6 Slut printeren til strømforsyningen.
- 7 Tænd printeren med I/O-knappen.

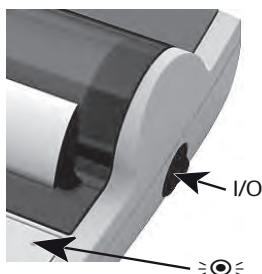

Bemærk

Kun RS232-grænseflade: Indikatorlampen blinker, indtil et instrument tilslufes. Hvis lampen stadig blinker, skal du læse kapitlet "Fejlfinding" i referencemanualen.

2.3 Isætning af papir





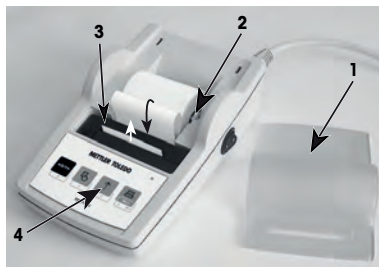



- 1 Fjern papirdækslet (træk i den bagerste del) (1).
- 2 Før papirrotationsvalse gennem papirullens midte (2).
- 3 Indfør papiret gennem åbningen i printerenheden i pilens retning (3).
- 4 Tryk på og hold tasten inde, indtil der er indført nok papir (4).
- 5 Før papiret gennem papirdækslets åbning.
- 6 Sæt papirdækslet (1) på.

Printeren skal genstartes, hvis vægtens tilslutningsindstillinger (baudhastighed, bit, handshake) ændres efter de første udskrivelser. Sluk/tænd for at starte den automatiske registrering af baudhastigheden igen. Automatisk baudhastighed kan være slukket.















3 Tastefunktioner

















Printer P25

Driftsni- veau	 Tryk kortvarigt	 Tryk og hold nede
	indføring af én linje	kontinuerlig indføring (indtil knappen slippes)
 +  On	Printerfæst med udskrivning af indstillinger	åbn menu
Menuni- veau	 Tryk kortvarigt	 Tryk og hold nede
	næste menupunkt	gem

Printer P26

Driftsni- veau	 Tryk kortvarigt	 Tryk og hold nede		
	nulstil/farer vægten	–		
	udskriv dato og klokkeslæt	–		
	indføring af én linje	kontinuerlig indføring (indtil knappen slippes)		
	udskriv	åbn menu		
Menuni- veau	 Tryk kortvarigt	 Tryk og hold nede		
 afslut	 ned	 op	 næste	 gem

Printer P28

Driftsni- veau	 Tryk kortvarigt	 Tryk og hold nede
	nulstil/farer vægten	–
	udskriv dato og klokkeslæt	–
	indføring af én linje	kontinuerlig indføring (indtil knappen slippes)
	udskriv	åbn menu
Menuni- veau	 Tryk kortvarigt	 Tryk og hold nede
 afslut  ned  op  næste	 gem	
Funktions- niveau	 Tryk kortvarigt	 Tryk og hold nede
	Start sammentællingsapplikation	Afslut sammentællingsapplikation
	Start statistikapplikation	Afslut statistikapplikation

4 Menu

4.1 Printer P25

Tryk kortvarigt	Tryk og hold nede	Udskrift
<div style="border: 1px solid black; padding: 2px; text-align: center;">Settings</div> <div style="border: 1px solid black; padding: 2px; text-align: center;">Reset</div>		Settings Reset
	Nulstil printeren	<pre> ----- Reset done ----- Current settings: Baudrate: 9600 Bit/Parity: 8 Bit Non Handshake: Off Char Set: IBM/DOS </pre>
<div style="border: 1px dashed gray; padding: 2px;"> <div style="border: 1px solid black; padding: 2px; text-align: center;">Kun RS232-grænsefla</div> <div style="border: 1px solid black; padding: 2px; text-align: center;">Auto Baudrate</div> <div style="border: 1px solid black; padding: 2px; text-align: center;">On</div> </div>	Gem	<pre> Auto Baudrate: On -----STORED----- ... "current settings" </pre>
<div style="border: 1px solid black; padding: 2px; text-align: center;">Auto Baudrate</div> <div style="border: 1px solid black; padding: 2px; text-align: center;">Off</div>	Gem	<pre> Auto Baudrate: Off -----STORED----- ... "current settings" </pre>
<div style="border: 1px solid black; padding: 2px; text-align: center;">Char Set</div> <div style="border: 1px solid black; padding: 2px; text-align: center;">IBM / DOS</div>	Gem	<pre> IBM/DOS -----STORED----- ... "current settings" </pre>
<div style="border: 1px solid black; padding: 2px; text-align: center;">IBM / DOS</div> <div style="border: 1px solid black; padding: 2px; text-align: center;">Cyrillic</div>	Gem	<pre> IBM/DOS Cyrillic -----STORED----- ... "current settings" </pre>
<div style="border: 1px solid black; padding: 2px; text-align: center;">IBM / DOS</div> <div style="border: 1px solid black; padding: 2px; text-align: center;">Japanese</div>	Gem	<pre> IBM/DOS Japanese -----STORED----- ... "current settings" </pre>
<div style="border: 1px solid black; padding: 2px; text-align: center;">ANSI / WIN</div> <div style="border: 1px solid black; padding: 2px; text-align: center;">Latin 1</div>	Gem	<pre> ANSI/WIN Latin 1 -----STORED----- ... "current settings" </pre>
<div style="border: 1px solid black; padding: 2px; text-align: center;">ANSI / WIN</div> <div style="border: 1px solid black; padding: 2px; text-align: center;">Cyrillic</div>	Gem	<pre> ANSI/WIN Cyrillic -----STORED----- ... "current settings" </pre>
<div style="border: 1px solid black; padding: 2px; text-align: center;">ANSI / WIN</div> <div style="border: 1px solid black; padding: 2px; text-align: center;">Japanese</div>	Gem	<pre> ANSI/WIN Japanese -----STORED----- ... "current settings" </pre>
<div style="border: 1px solid black; padding: 2px; text-align: center;">Balance Feature</div> <div style="border: 1px solid black; padding: 2px; text-align: center;">Enable</div>	Gem	<pre> Balance Feature: Enable -----STORED----- ... "current settings" </pre>
<div style="border: 1px solid black; padding: 2px; text-align: center;">Balance Feature</div> <div style="border: 1px solid black; padding: 2px; text-align: center;">Disable</div>	Gem	<pre> Balance Feature: Disable -----STORED----- ... "current settings" </pre>
<div style="border: 1px solid black; padding: 2px; text-align: center;">Menupunkt</div> <div style="border: 1px solid black; padding: 2px; text-align: center;">Fabriksindstilling</div>		

4.2 Printer P26/P28

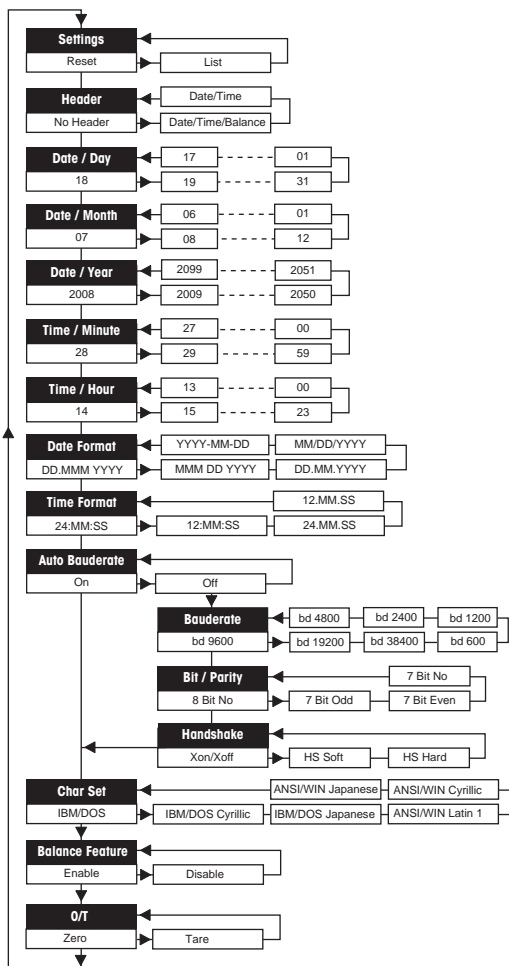

Displayeksempler, hvis vægten
display anvendes:





Indstillinger	Reset	rESEt
	List	L l5t
Overskrift	*No Header	no Hdr
	Date/Time	d t Hdr
	Date/Time/Balance	dtb Hdr
Dato Dag**	18	dAY 18
Dato Måned**	07	Month 07
Dato År**	2008	YEAR 2008
Klokkeslæt Minut**	28	in. 28
Klokkeslæt Time**	14	Hour 14
Datoformat***	DD.MMM.YYYY	ddmmY
	MMM DD.YYYY	mm dd Y
	DD.MM.YYYY	ddmmY
	MM/DD/YYYY	mm dd Y
	YYYY-MM-DD	Y-mm-dd
Klokkeslæt Format**	24.MM.SS	24:mm:ss
	12.MM.SS	12:mm:ss
	24.MM.SS	24mm:ss
	12.MM.SS	12mm:ss
Baudhastighed	*9600	bd9600
	19200	bd 19200
	38400	bd38400
	600	bd600
	1200	bd 1200
	2400	bd2400
	4800	bd4800
Bit/paritet	*8 Bit No	8b-no
	7 Bit Odd	7b-odd
	7 Bit Even	7b-E
	7 Bit No	7b-no
Handshake	*Xon/Xoff	HS oFF
	HS Soft	HS 5oFt
	HS Hard	HS HRRd
Tegnsæt	*IBM/DOS	d05
	IBM/DOS Cyrillic	d05 C4r
	IBM/DOS Japanese	d05 JRP
	Ansi/Win Latin 1	11 in LARt
	Ansi/Win Cyrillic	11 in C4r
	Ansi/Win Japanese	11 in JRP
Tara/nul	*Zero	ZEr-o
	Tare	tAR-E

Menupunkt
Fabriksindstilling

- * fabriksindstillinger
- ** instrumenter med indbygget ur: kan ikke anvendes, indbygget ur prioriteres
- *** instrumenter med indbygget ur: printerens format prioriteres

Eksempel på indstilling af dag (kun P26/P28)

Åbn menuen

- Hold tasten  nede, indtil **Reset** vises.
- Vælg menupunktet **Day** med tasten .
- Vælg dagen, f.eks. dag 21.
Rul op med tasten .
- Rul ned med tasten .



Gem indstillingerne

- Hold tasten  nede, indtil **Stored** vises.

Statistikapplikation (kun P28)



Prøvevægten skal ligge inden for intervallet 70-130 % for den aktuelle gennemsnitsværdi.
Minimum dynamisk vægt, der er ændret, skal være 100 d.

- 1 Tryk på  for at starte Statistikapplikation (LED tændt).
- 2 Tilføj en ny prøve, og tryk på **M+**.
- 3 Tryk på  for at udskrive subtotal, hvis det er nødvendigt.
- 4 Tryk og hold  inde for at udskrive og afslutte Statistikapplikation (LED slukket).





Bemærk

- Ændring af enhed under applikationen er ikke tilladt.
- Maks. 999 prøver.

Sammentællingsapplikation (kun P28)



Minimumsvægte + 1 d.

- 1 Tryk på  for at starte Sammentællingsapplikationen (LED tændt).
- 2 Tilføj en ny prøve, og tryk på **M+**.
- 3 Tryk på  for at udskrive subtotal, hvis det er nødvendigt.
- 4 Tryk og hold  inde for at udskrive og afslutte Sammentællingsapplikationen (LED slukket).



Bemærk

- Ændring af enhed under applikationen er ikke tilladt.
- Maks. 999 prøver.

5 Vedligeholdelse

ADVARSEL



Dødsfald eller alvorlig tilskadekomst på grund af elektrisk stød

Kontakt med strømførende dele kan resultere i personskade og dødsfald.

- 1 Afbryd forbindelsen mellem printeren og strømforsyningen inden rengøring og vedligeholdelse.
- 2 Sørg for, at der ikke trænger væske ind i AC/DC-adapteren.

5.1 Udskiftning af papirrullen

Isætning af den nye papirrulle er beskrevet i kapitlet [Isætning af papir ▶ side 20]. Ordrenummeret for papirrullen er angivet i kapitlet [Forbrugsvarer ▶ side 28].



Bemærk

Papirrotationsvulsen skal altid overføres fra den gamle papirrulle til den nye.

5.2 Udskiftning af båndet

Ordrenummeret for båndpatronen er angivet i kapitlet [Forbrugsvarer ▶ side 28].

- 1 Fjern papirdækslet (1).
- 2 Træk papiret ud af printerenheden (2).



- 3 Fjern båndpatronen ved at trykke i pilens retning (3).
- 4 Sæt den nye båndpatron i. Båndpatronen kan om nødvendigt strammes med strammehjulet (4).

Isætning af en ny papirrulle er beskrevet i kapitlet [Isætning af papir ▶ side 20].



5.3 Rengøring af kabinettet

Da printerens kabinet er fremstillet af modstandsdygtige materialer af højeste kvalitet, kan alle former for almindelige rengøringsmidler anvendes.



BEMÆRK

Beskadigelse af printeren på grund af brug af forkerte rengøringsmetoder

Printerens kabinet er fremstillet af modstandsdygtige materialer af høj kvalitet, men kan blive beskadiget af visse rengøringsmidler, opløsningsmidler eller slibemidler. Væske, der kommer ind i kabinettet, kan beskadige printeren.

- 1 Brug vand og et mildt rengøringsmiddel til at rengøre printeren.
- 2 Tør op med det samme, hvis der spildes.
- 3 Sørg for, at der ikke trænger væske ind i printeren.

Kontakt en METTLER TOLEDO repræsentant for at få flere informationer om servicemuligheder – regelmæssig vedligeholdelse af en autoriseret servicetekniker vil sikre vejenøjagtigheden på lang sigt og forlænge instrumentets levetid.

6 Tekniske data

6.1 Generelle tekniske data

Strømforsyning

AC/DC-adapter:	Primær: 100-240 V, 50/60 Hz Sekundær: 12 V DC, 2,5 A (med elektronisk overbelastningsbeskyttelse)
Kabel til AC/DC-adapter:	3-benet, med landespecifikt stik
Polaritet:	 med spændingsbegrænset SELV-effekt (Safety Extra Low Voltage)
Netspænding:	12 V DC
Strømförbrug:	Maks. 2,5 A

Beskyttelse og standarder

Overspændingskategori:	II
Forureningsgrad:	2
Sikkerhedsstandarder og EMC:	Se overensstemmelseserklæringen
Anvendelsesområde:	Kun til anvendelse indendørs i lukkede rum

Miljømæssige forhold

Højde over havets overflade:	Op til 4.000 m
Omgivelsestemperatur:	0 til 40 °C
Opbevaringsforhold:	-25 til 60 °C
Relativ luftfugtighed:	Maks. 80 % op til 31 °C, lineært faldende til 50 % ved 40 °C, ikke-kondenserende

Printerfunktioner

Udskriftsteknologi:	Matrixprinter 5 x 7, 24 tegn/linje
Udskrivningshastighed:	2,3 linjer pr. sekund
Båndpatron:	Udskiftelig, sort
Papirrulle:	Standardpapir 57,5 mm x Ø 50-60 mm, integreret i kabinettet, kommerciel størrelse
Udskriftskvalitet:	Lysbestandig og termisk stabil udskrivning (GLP, GMP, ISO 9001)
Grænseflader:	RS-P25, RS-P26, RS-P28 USB-P25
Kompatibilitetsgrænser:	USB <ul style="list-style-type: none">• Funktionen Dato/klokkeslæt: kan ikke anvendes på vægte med indbygget ur (det indbyggede ur prioriteres)• Funktionen Nulstilling/tarering: kan ikke anvendes på alle vægtmodeller

Størrelse/vægt

Printerens mål (B x D x H):	120 x 203 x 73 mm
Emballagens mål (B x D x H):	255 x 205 x 150 mm
Nettovægt:	740 g (inkl. papirrulle)

7 Forbrugsvarer

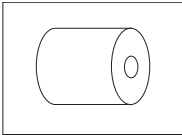
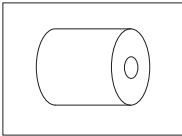
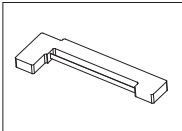
	Beskrivelse	Varenr.
	Papirrulle (længde: 20 m), sæt med 5 stk.	00072456
	Papirrulle (længde: 13 m), selvklebende, sæt med 3 stk.	11600388
	Båndpatron, sort, sæt med 2 stk.	00065975

1 Sigurnosne informacije

Dva dokumenta pod nazivom "Korisnički priručnik" i "Upute za rad" dostupni su na ovom uređaju.

- U korisničkom je priručniku prikazano kako započeti s upotrebom uređaja.
- Upute za rad sadrže kompletan opis uređaja i njegove upotrebe.
- Oba dokumenta sačuvajte za buduću upotrebu.
- Prilikom predaje uređaja drugima priložite oba dokumenta.

Uređaj upotrebljavajte isključivo sukladno uputama za rad iz korisničkog priručnika. Ako se uređaj ne upotrebljava sukladno uputama iz tih dokumenata ili se na njemu vrše izmjene, to može ugroziti sigurnost uređaja i tvrtka Mettler-Toledo GmbH ne snosi nikakvu odgovornost.

1.1 Ostali primjenjivi dokumenti



Ovaj korisnički priručnik sadrži informacije o prvim koracima za postupanje s proizvodom na siguran i učinkovit način. Osoblje mora pažljivo pročitati i razumjeti ovaj priručnik prije izvođenja bilo kakvih zadataka.

Detaljne informacije uvijek možete pronaći u referentnom priručniku.

► www.mt.com/printer-p-20-RM

1.2 Definicije signalnih riječi i simbola upozorenja

Sigurnosne napomene sadrže važne informacije o sigurnosnim problemima. Nepridržavanje sigurnosnih napomena može dovesti do tjelesnih ozljeda, oštećenja uređaja, kvarova i pogrešnih rezultata. Sigurnosne napomene označene su sljedećim signalnim riječima i simbolima upozorenja:

Signalne riječi

UPOZORENJE	Opasna situacija srednjeg rizika koja može rezultirati smrću ili teškim ozljedama ako se ne izbjegne.
OPREZ	Opasna situacija niskog rizika koja može rezultirati manjim ili umjerenim ozljedama ako se ne izbjegne.
OBAVIJEST	Opasna situacija niskog rizika koja rezultira oštećenjem uređaja, drugim materijalnim štetama, neispravnosću, pogrešnim rezultatima ili pak gubitkom podataka.

Simboli upozorenja



Strujni udar



Opasnosti: informacije o opasnostima i odgovarajućim protumjerama pročitajte u uputama za rad.



Obavijest

1.3 Sigurnosne napomene o proizvodu

Namjena

Uređaj smije upotrebljavati isključivo stručno obučeno osoblje u laboratorijima. Uređaj je namijenjen za ispisivanje protokola.

Sve ostale vrste upotrebe i rada koje nisu u skladu s tehničkim specifikacijama bez pisanog dopuštenja tvrtke Mettler-Toledo GmbH smatraju se nenamjenskom upotrebom.

Odgovornosti vlasnika uređaja

Vlasnik uređaja osoba je koja ima zakonsko pravo za upotrebu uređaja i koja uređaj upotrebljava ili drugima daje dopuštenje za njegovu upotrebu, kao i osoba kojoj je zakonom dopušteno da bude rukovatelj uređajem. Vlasnik uređaja odgovoran je za sigurnost svih korisnika uređaja i trećih strana.

METTLER TOLEDO Pretpostavljaju da vlasnik uređaja obučava korisnike za sigurnu upotrebu uređaja na radnom mjestu i brine se za potencijalne opasnosti. METTLER TOLEDO Pretpostavljaju da se vlasnik uređaja pobrine za svu potrebnu zaštitnu opremu.

Sigurnosne napomene



UPOZORENJE

Smrtonosne ili ozbiljne ozljede od strujnog udara

Doticaj s dijelovima pod naponom može dovesti do ozljeda ili smrti.

- 1 Upotrebljavajte isključivo odobreni METTLER TOLEDO kabel za napajanje i AC/DC adapter sa SELV izlazom.
- 2 Priključite kabel za napajanje u uzemljenu strujnu utičnicu pazeći na polove.
- 3 Sve električne kabele i priključke držite podalje od tekućina i vlage.
- 4 Provjerite ima li oštećenja na kabelima i utikaču za napajanje i zamijenite ih ako su oštećeni.



OBAVIJEST

Oštećenje instrumenta uslijed upotrebe neodgovarajućih dijelova

Upotreba neodgovarajućih dijelova s uređajem može dovesti do oštećenja instrumenta ili prouzročiti kvar.

- Upotrebljavajte isključivo dijelove tvrtke METTLER TOLEDO koji su namijenjeni za upotrebu s vašim instrumentom.

2 Instalacija i pokretanje uređaja

2.1 Sadržaj isporuke

- AC/DC adapter
- kabel za napajanje (prilagođen za pojedinu zemlju)
- Korisnički priručnik
- Izjava o sukladnosti

2.2 Povezivanje pisača na izvor napajanja



! UPOZORENJE

Smrtonosne ili ozbiljne ozljede od strujnog udara

Doticaj s dijelovima pod naponom može dovesti do ozljeda ili smrti.

- 1 Upotrebijavajte isključivo odobreni METTLER TOLEDO kabel za napajanje i AC/DC adapter sa SELV izlazom.
- 2 Priključite kabel za napajanje u uzemljenu strujnu utičnicu pazeći na polove.
- 3 Sve električne kabele i priključke držite podalje od tekućina i vlage.
- 4 Provjerite ima li oštećenja na kablama i utikaču za napajanje i zamijenite ih ako su oštećeni.



OBAVIJEST

Oštećenje AC/DC adaptera zbog pregrijavanja

Ako je AC/DC adapter prekriven ili je u spremniku, ne hladi se dovoljno i pregrijat će se.

- 1 Ne prekrivajte AC/DC adapter.
- 2 Ne stavljajte AC/DC adapter u spremnik.

Pisač se isporučuje s univerzalnim AC/DC adapterom ili AC/DC adapterom s kablom za napajanje prilagođenim za pojedinu zemlju.

- Kabele postavite tako da se ne mogu oštetiti ili ometati rad.
- Umetnite kabel za napajanje u uzemljenu strujnu utičnicu koja je lako dostupna.

- 1 Priključite AC/DC adapter u utičnicu za priključak na poleđini pisača.
- 2 Zaboravite utikač pomoću matice.
- 3 Priključite 3-pinski uzemljeni kabel za napajanje u utičnicu za AC adapter.
- 4 Priključite pisač i vagu pomoću kabela sučelja.
- 5 Uključite vagu.
- 6 Priključite pisač na izvor napajanja.
- 7 Uključite pisač pomoću prekidača **I/O**.

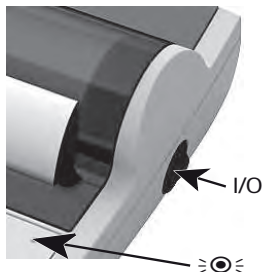

Napomena

Samo za sučelje RS232: kontrolna lampica treperi kad je instrument priključen. Ako lampica još uvijek treperi, u Referentnom priručniku pročitajte poglavlje "Rješavanje poteškoća".

2.3 Umetanje papira





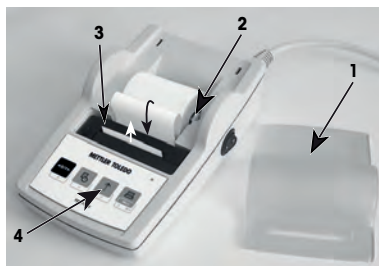



- 1 Skinite poklopac za papir (povucite na stražnjem dijelu) (1).
- 2 Umetnite okretnu os za papir kroz sredinu role papira (2).
- 3 Umetnite papir kroz utor na pisaču u smjeru strelice (3).
- 4 Pritisnite i držite dok se ne umetne dovoljno papira (4).
- 5 Papir umećite kroz utor poklopca za papir.
- 6 Vratite poklopac (1) na mjesto.

Ako se nakon prvih ispisa i promjene postavki priključivanja (brzina prijenosa podataka, bit, kontrola protoka), pisač je potrebno ponovno pokrenuti. Isključite/uključite kako biste ponovno pokrenuli automatsko otkrivanje brzine prijenosa podataka. Automatska brzina prijenosa podataka može se isključiti.















3 Funkcije pritiskanjem tipki

Pisač P25

Operativna razina	 Kratki pritisak	 Pritisak i držanje
	jednolinijsko umetanje	neprekidno umetanje (do otpuštanja)
 +  On	Ispitivanje pisača s postavkom ispisa	otvaranje izbornika
Razina izbornika	 Kratki pritisak	 Pritisak i držanje
	sljedeća stavka izbornika	pohrana

Pisač P26

Operativna razina	 Kratki pritisak	 Pritisak i držanje		
	nuliranje/tariranje vage	–		
	ispis datuma i vremena	–		
	jednolinijsko umetanje	neprekidno umetanje (do otpuštanja)		
	ispis	otvaranje izbornika		
Razina izbornika	 Kratki pritisak	 Pritisak i držanje		
 izlaz	 dolje	 gore	 sljedeće	 pohrana

Pisač P28

Operativna razina	 Kratki pritisak	 Pritisak i držanje
	nuliranje/tariranje vage	–
	ispis datuma i vremena	–
	jednolinijsko umetanje	neprekidno umetanje (do otpuštanja)
	ispis	otvaranje izbornika
Razina izbornika	 Kratki pritisak	 Pritisak i držanje
 izlaz  dolje  gore  sljedeće		 pohrana
Funkcijska razina	 Kratki pritisak	 Pritisak i držanje
	Pokretanje aplikacije zbrajanja	Zaključivanje primjene zbrajanja
	Pokretanje aplikacije statistike	Zaključivanje primjene statistike

4 Izbornik

4.1 Pisač P25

🖱️ Kratki pritisak	🖱️ Pritisak i držanje	Ispis
<div style="border: 1px solid black; padding: 2px; text-align: center;">Settings</div> <div style="border: 1px solid black; padding: 2px; text-align: center;">Reset</div>		Settings Reset
<div style="border: 1px solid black; padding: 2px; text-align: center;">Resetiranje pisača</div>		<pre> ----- Reset done ----- Current settings: Baudrate: 9600 Bit/Parity: 8 Bit Non Handshake: Off Char Set: IBM/DOS </pre>
<div style="border: 1px dashed gray; padding: 2px; text-align: center;">Samo sučelje RS232</div> <div style="border: 1px solid black; padding: 2px; text-align: center;">Auto Bauderate</div> <div style="border: 1px solid black; padding: 2px; text-align: center;">On</div>	Pohrana	<pre> Auto Bauderate: On -----STORED----- ... "current settings" </pre>
<div style="border: 1px solid black; padding: 2px; text-align: center;">Auto Bauderate</div> <div style="border: 1px solid black; padding: 2px; text-align: center;">Off</div>	Pohrana	<pre> Auto Bauderate: Off -----STORED----- ... "current settings" </pre>
<div style="border: 1px solid black; padding: 2px; text-align: center;">Char Set</div> <div style="border: 1px solid black; padding: 2px; text-align: center;">IBM / DOS</div>	Pohrana	<pre> IBM/DOS -----STORED----- ... "current settings" </pre>
<div style="border: 1px solid black; padding: 2px; text-align: center;">IBM / DOS Cyrillic</div>	Pohrana	<pre> IBM/DOS Cyrillic -----STORED----- ... "current settings" </pre>
<div style="border: 1px solid black; padding: 2px; text-align: center;">IBM / DOS Japanese</div>	Pohrana	<pre> IBM/DOS Japanese -----STORED----- ... "current settings" </pre>
<div style="border: 1px solid black; padding: 2px; text-align: center;">ANSI / WIN Latin 1</div>	Pohrana	<pre> ANSI/WIN Latin 1 -----STORED----- ... "current settings" </pre>
<div style="border: 1px solid black; padding: 2px; text-align: center;">ANSI / WIN Cyrillic</div>	Pohrana	<pre> ANSI/WIN Cyrillic -----STORED----- ... "current settings" </pre>
<div style="border: 1px solid black; padding: 2px; text-align: center;">ANSI / WIN Japanese</div>	Pohrana	<pre> ANSI/WIN Japanese -----STORED----- ... "current settings" </pre>
<div style="border: 1px solid black; padding: 2px; text-align: center;">Balance Feature</div> <div style="border: 1px solid black; padding: 2px; text-align: center;">Enable</div>	Pohrana	<pre> Balance Feature: Enable -----STORED----- ... "current settings" </pre>
<div style="border: 1px solid black; padding: 2px; text-align: center;">Balance Feature</div> <div style="border: 1px solid black; padding: 2px; text-align: center;">Disable</div>	Pohrana	<pre> Balance Feature: Disable -----STORED----- ... "current settings" </pre>

Opcija izbornika
Tvornička postavka

4.2 Pisač P26/P28

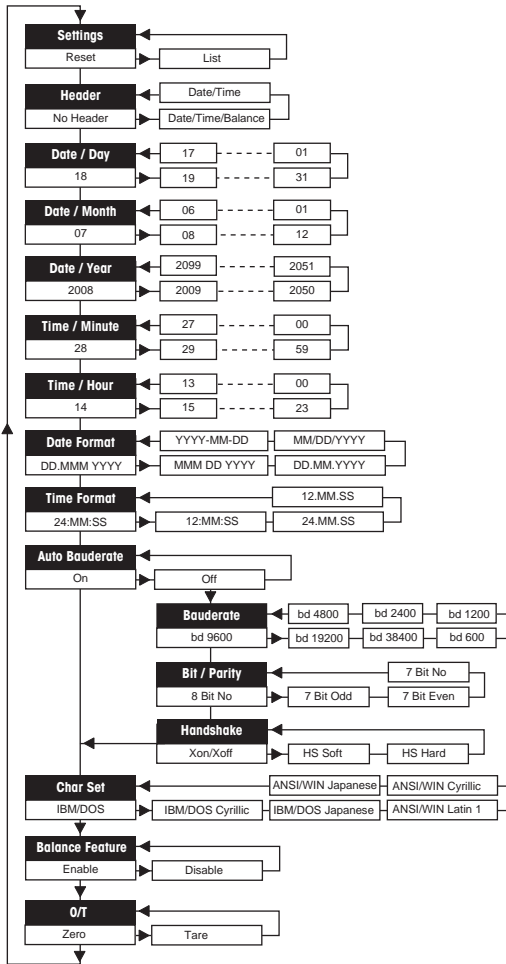

Primjeri ako se upotrebljava zaslon vage:





Postavke	Reset	rESEt
	List	Ll5t
Zaglavlje	*No Header	no Hdr
	Date/Time	d t Hdr
	Date/Time/Balance	dtb Hdr
Datum Dan**	18	dRY 18
Datum Mjesec**	07	Month 07
Datum Godina**	2008	YEAR=2008
Vrijeme Minute**	28	n in 28
Vrijeme Sati**	14	Hour 14
Format datuma***	DD.MMM YYYY	ddmmY
	MMM DD YYYY	mm dd Y
	DD.MM.YYYY	ddmmY
	MM/DD/YYYY	mm dd Y
	YYYY-MM-DD	Y-mm-dd
Format vremena***	24:MM:SS	24:mm:ss
	12:MM:SS	12:mm:ss
	24.MM.SS	24mmSS
	12.MM.SS	12mmSS
Brzina prijenosa	*9600	bd9600
	19200	bd 19200
	38400	bd38400
	600	bd600
	1200	bd 1200
	2400	bd2400
	4800	bd4800
Bitovi/paritet	*8 Bit No	8b-no
	7 Bit Odd	7b-odd
	7 Bit Even	7b-E
	7 Bit No	7b-no
Kontrola protoka	*Xon/Xoff	HS oFF
	HS Soft	HS SoFt
	HS Hard	HS HARd
Postavljanje znakova	*IBM/DOS	d05
	IBM/DOS Cyrillic	d05 C4r
	IBM/DOS Japanese	d05 JRP
	Ansi/Win Latin 1	11 in LRt
	Ansi/Win Cyrillic	11 in C4r
	Ansi/Win Japanese	11 in JRP
Tara/nula	*Zero	ZEr-o
	Tare	tAR-E

Opcija izbornika
Izvorna postavka

- * tvorničke postavke
- ** uređaji s ugrađenim satom: nije primjenjivo, ugrađen sat ima prioritet
- *** uređaji s ugrađenim satom: format pisača ima prioritet

Primjer postavljanja datuma (samo za modele P26/P28)

Otvorite izbornik

- Držite pritisnutom tipku  sve dok se ne prikaže **Vrati izvorno**.
- S pomoću tipke  odaberite izborničku opciju **Datum**.
- Odaberite dan, primjerice 21.
Pomak nagore učinite s pomoću tipke .
Pomak nadolje učinite s pomoću tipke .



Spremanje postavki

- Držite pritisnutom tipku  sve dok se ne prikaže **Spremljeno**.

Aplikacija statistike (samo P28)



Težina uzorka treba biti u rasponu od 70 do 130 % od trenutne prosječne vrijednosti.
Minimalna dinamična promjena težine mora biti 100 d.

- 1 Pritisnite  za pokretanje aplikacije Statistika (uključeno LED svjetlo).
- 2 Dodajte novi uzorak i pritisnite **M+**.
- 3 Pritisnite  za ispis podbroja ako je potrebno.
- 4 Pritisnite i držite  za ispis i isključenje aplikacije Statistika (isključeno LED svjetlo).





Napomena

- Promjena mjerne jedinice tijekom primjene nije dopuštena.
- Maksimalno 999 uzoraka.

Aplikacija zbrajanja (samo P28)



Minimalne težine + 1 d.

- 1 Pritisnite  za pokretanje aplikacije Zbrajanje (uključeno LED svjetlo).
- 2 Dodajte novi uzorak i pritisnite **M+**.
- 3 Pritisnite  za ispis podbroja ako je potrebno.
- 4 Pritisnite i držite  za ispis i isključenje aplikacije Zbrajanje (isključeno LED svjetlo).



Napomena

- Promjena mjerne jedinice tijekom primjene nije dopuštena.
- Maksimalno 999 uzoraka.

5 Održavanje



UPOZORENJE

Smrtonosne ili ozbiljne ozljede od strujnog udara

Kontakt s dijelovima koji provode struju može dovesti do ozljeda ili smrti.

- 1 Prije čišćenja ili održavanja isključite pisač iz napajanja.
- 2 Spriječite ulazak tekućine u pisač ili strujni prilagodnik.

5.1 Zamjena role papira

Umetanje nove role papira opisano je u poglavlju [Umetanje papira ▶ stranica 32]. Broj za narudžbu role papira nalazi se u poglavlju [Potrošni materijali ▶ stranica 40].



Napomena

Valjak nosača papira uvijek se mora iz stare role premjestiti u novu.

5.2 Zamjena vrpce

Broj za narudžbu uloška s vrpcom nalazi se u poglavlju [Potrošni materijali ▶ stranica 40].

- 1 Skinite poklopac za papir (1).
- 2 Izvucite papir iz jedinice za ispis (2).



- 3 Izvadite patronu s trakom pritiskanjem u smjeru strelice (3).
- 4 Umetnite novu patronu s trakom. Ako je potrebno, olabavite s pomoću kotačića napinjača (4).

Umetanje nove role papira opisano je u poglavlju [Umetanje papira ▶ stranica 32].



5.3 Čišćenje kućišta

Budući da je kućište pisača izrađeno od otpornih materijala vrhunske kvalitete, dopuštena je upotreba svih komercijalno dostupnih blagih sredstava za čišćenje.



OBAVIJEST

Oštećenja pisača zbog neprimjerenih načina čišćenja.

Kućište pisača izrađeno je od visokokvalitetnih i otpornih materijala visoke kvalitete no može se oštetiti nekim sredstvima za čišćenje, otapalima i abrazivnim sredstvima. Ako bilo kakva tekućina uđe u kućište, pisač se može oštetiti.

- 1 Za čišćenje pisača upotrebljavajte vodu i blagi deterdžent.
- 2 Odmah obrišite prolivenu tekućinu.
- 3 Spriječite ulazak tekućine u unutrašnjost pisača.

Obratite se METTLER TOLEDO predstavniku da biste saznali za dostupne mogućnosti servisiranja – redovito održavanje koje obavlja ovlašteni serviser dugotrajno će osigurati dosljednu točnost vaganja i produžiti vijek trajanja uređaja.

6 Tehnički podaci

6.1 Opći tehnički podaci

Napajanje

Strujni prilagodnik:	Primarni: 100 – 240 V ~, 50/60 Hz Sekundarni: 12V DC, 2,5A (s elektroničkom zaštitom od preopterećenja)
Kabel za AC/DC adapter:	trožilni, s utikačem prilagođenim za pojedinu zemlju
Polaritet:	 s ograničenom strujom SELV (sigurnosni iznimno niski napon)
Napon u vodu napajanja:	12V DC
Energetska potrošnja:	najviše 2,5A

Zaštita i standardi

Kategorija prenapona:	II
Stupanj zagađenja:	2
Standardi za sigurnost i EMC:	Pogledajte Izjavu o sukladnosti
Raspon aplikacija:	Za upotrebu samo u zatvorenim prostorijama

Uvjeti okoline

Visina iznad prosječne razine mora:	Do 4000 m
Temperatura okoline:	0 do 40°C
Uvjeti skladištenja:	-25 do 60°C
Relativna vlažnost zraka:	Maks. 80 % do 31 °C, linearno smanjivanje do 50 % pri 40 °C, bez kondenzacije

Značajke pisača

Tehnologija ispisa:	Matrični pisač 5x7, 24 znaka u retku
Brzina ispisa:	2,3 retka u sekundi
Uložak s vrpcom:	Zamjenjiv, crna boja
Rola papira:	Standardni papir 57,5mm x ø 50 do 60mm, ugrađen u kućište, komercijalna dimenzija
Kvaliteta ispisa:	Ispis otporan na svjetlost i termički stabilan (GLP, GMP, ISO 9001)
Sučelja:	RS-P25, RS-P26, RS-P28 USB-P25
Ograničenja kompatibilnosti:	RS232C USB <ul style="list-style-type: none">Funkcija datuma/vremena: nije primjenjiva na vage s ugrađenim satom (ugrađeni sat ima prioritet)Funkcija nuliranja/tariranja: nije primjenjiva na sve modele vaga

Dimenzije/težina

Dimenzije pisača (Š x D x V):	120 x 203 x 73 mm
Dimenzije pakiranja (Š x D x V):	255 x 205 x 150 mm
Neto težina:	740 g (uklj. rolu papira)

7 Potrošni materijali

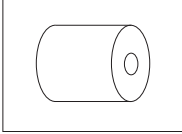
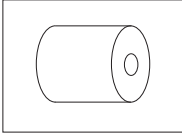
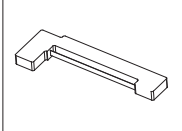
	Opis	Br. artikla
	Rola papira (duljina: 20m), 5 kom. u pakiranju	00072456
	Rola papira (duljina: 13m), samoljepljiv, 3 kom. u pakiranju	11600388
	Uložak s vrpcom, crna boja, 2 kom. u pakiranju	00065975

1 Biztonsági információk

Ehhez a műszerhez két dokumentum áll rendelkezésre: "Felhasználói útmutató" és "Használati utasítás".

- A felhasználói útmutató a műszer használatának megkezdéséhez nyújt segítséget.
- A használati utasításban a műszer részletes leírása és használatának módja szerepel.
- Későbbi használatához őrizze meg mindkét dokumentumot.
- Amennyiben egy harmadik félnek adja át a műszert, a dokumentumokat is mellékelje hozzá.

Kizárólag a Felhasználói útmutatóban és a Használati utasításban leírtak szerint használja a műszert. Ha nem ezen útmutatók szerint kezeli, illetve ha módosítást hajt végre a műszeren, a készülék károsodhat, amelyért a gyártó Mettler-Toledo GmbH nem vállal felelősséget.

1.1 További kapcsolódó dokumentumok



Ez egy rövid használati útmutató, amely információkat szolgáltat az eszköz biztonságos és hatékony kezelésére. Olvassa át gondosan a jelen kézikönyvet, mielőtt bármilyen műveletbe kezdene a készüléken.

A részletes információkért mindig tekintse meg a Referencia-kézikönyvet (RM).

► www.mt.com/printer-p-20-RM

1.2 Figyelmeztető szavak és szimbólumok definíciói

A biztonsági megjegyzések a biztonsági problémákkal kapcsolatban szolgálnak fontos információkkal. A biztonsági megjegyzések figyelmen kívül hagyása személyi sérülést, a műszer sérülését, meghibásodását, és hibás eredményeket okozhat. A biztonsági megjegyzéseket a következő figyelmeztető szavakkal és szimbólumokkal jelöljük:

Figyelemfelhívó szavak

FIGYELMEZTETÉS Közepes kockázatú robbanásveszélyes helyzet, mely komoly sérülésekhez vagy halálhoz vezethet, ha nem elővigyázatos.

VIGYÁZAT Alacsony kockázatú robbanásveszélyes helyzet, mely kis vagy közepes sérülésekhez vezethet, ha nem elővigyázatos.

ÉRTESÍTÉS Alacsony kockázatú robbanásveszélyes helyzet, mely a műszer károsodását, egyéb anyagi károkat, meghibásodásokat, hibás eredményeket vagy adatvesztést okozhat.

Figyelmeztető szimbólumok



Áramütés



Általános veszély: A veszélyeket és a mérési eredményeket illetően tekintse meg a használati utasítást.



Megjegyzés

1.3 Termék-specifikus biztonsági megjegyzések

A műszer rendeltetése

A berendezést szakképzett laboratóriumi dolgozók részére tervezték. A műszer jegyzőkönyvek nyomtatására szolgál.

Bármilyen más jellegű használat, illetve a műszaki specifikációkon kívüli használat a Mettler-Toledo GmbH írásos hozzájárulásának hiányában nem rendeltetésszerű használatnak minősül.

A műszer tulajdonosának kötelezettségei

A műszer tulajdonosa az a személy, aki jogosan birtokolja a műszert, egyúttal használja, illetve a használatára más személyt felhatalmaz; vagy az a személy, aki a törvény értelmében a műszer kezelőjének minősül. A műszer tulajdonosa felelős a műszert használó összes személy, valamint a harmadik felek biztonságáért.

METTLER TOLEDO feltételezi, hogy a műszer tulajdonosa betanítja a felhasználókat a műszernek a munkahelyen való biztonságos kezelésére, valamint az esetleges veszélyforrásokkal való bánásmódra. METTLER TOLEDO feltételezi, hogy a műszer tulajdonosa rendelkezésre bocsátja a szükséges védőfelszerelést.

Biztonsági megjegyzések



FIGYELMEZTETÉS

Halált vagy súlyos sérülést okozó áramütés veszélye

Az áram alatt lévő alkatrészek érintése sérülést, vagy akár halált is okozhat.

- 1 Kizárólag jóváhagyott METTLER TOLEDO tápkábelt és hálózati adaptert használjon áramkorlátozott SELV-kimenettel.
- 2 Földelt konnektorba csatlakoztassa a tápkábelt, és ügyeljen a polaritásra.
- 3 Ügyeljen arra, hogy az elektromos kábeleket és csatlakozókat ne érje folyadék vagy nedveség.
- 4 Ellenőrizze a kábelek és a csatlakozó épségét; a sérült kábeleket és csatlakozót cserélje ki.



ÉRTESÍTÉS

A műszer károsodása nem megfelelő alkatrészek használata miatt

Nem megfelelő alkatrészek használata a műszer károsodását vagy meghibásodását okozhatja.

- Csak a METTLER TOLEDO által szállított olyan alkatrészeket használjon, amelyek a készülékkel való használatra szolgálnak.

2 Telepítés és beüzemelés

2.1 A csomag tartalma

- Váltóáramú/egyenáramú adapter
- Tápkábel (országspecifikus)
- Felhasználói útmutató
- Megfelelőségi nyilatkozat

2.2 A nyomtató csatlakoztatása az áramforráshoz



FIGYELMEZTETÉS

Halált vagy súlyos sérülést okozó áramütés veszélye

Az áram alatt lévő alkatrészek érintése sérülést, vagy akár halált is okozhat.

- 1 Kizárólag jóváhagyott METTLER TOLEDO tápkábelt és hálózati adaptert használjon áramkorlátozott SELV-kimenettel.
- 2 Földelt konnektorba csatlakoztassa a tápkábelt, és ügyeljen a polarításra.
- 3 Ügyeljen arra, hogy az elektromos kábeleket és csatlakozókat ne érje folyadék vagy nedveség.
- 4 Ellenőrizze a kábelek és a csatlakozó épségét; a sérült kábeleket és csatlakozót cserélje ki.



ÉRTESETÉS

A túlhevülés a hálózati adapter károsodását okozhatja

Ha a hálózati adaptert letakarják vagy zárt helyre teszik, akkor az nem szellőzik megfelelően és túlhevül.

- 1 Ne takarja le a hálózati adaptert.
- 2 Ne tegye zárt helyre a hálózati adaptert.

A nyomtatóhoz univerzális hálózati adapter vagy hálózati adapter és országspecifikus tápkábel van mellékelve.

- A kábeleket úgy rendezze el, hogy ne sérüljenek és ne zavarják a készülék működtetését.
- Csatlakoztassa a tápkábelt egy könnyen hozzáférhető földelt konnektorba.

- 1 Csatlakoztassa a hálózati adaptert a nyomtató hátoldalán levő csatlakozóaljzatához.
- 2 A rögzítőcsavarral rögzítse a csatlakozót.
- 3 Csatlakoztassa a 3 tűs, földelt tápkábelt a hálózati adapter aljzatához.
- 4 Csatlakozókábel segítségével csatlakoztassa a nyomtatót a mérleghez.
- 5 Kapcsolja be a mérleget.
- 6 Csatlakoztassa a nyomtatót az áramforráshoz.
- 7 Kapcsolja be a nyomtatót a bekapcsológombbal (I/O).

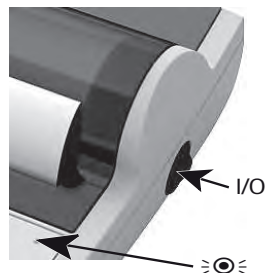

Jegyezd

Csak RS232-csatlakozó esetén: a jelzőlámpa addig villog, amíg nem csatlakoztatnak egy műszert. Ha a lámpa ezt követően is villog, nézze meg a Referencia-kézikönyv "Hibaelhárítás" című fejezetét.

2.3 Papír behelyezése



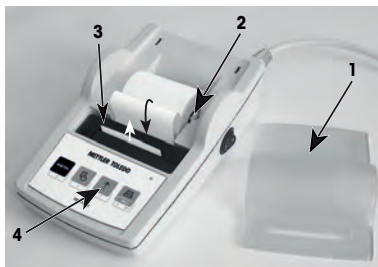



- 1 Távolítsa el a papírtartó fedelét (húzza meg hátul) (1).
- 2 A papírtekercs forgó tengelyét helyezze a papírtekercs közepébe (2).
- 3 A nyíl irányában húzza át a papírt a nyomtatóegység nyílásán (3).
- 4 Tartsa lenyomva a gombot addig, amíg elég papírt be nem húz a nyomtató (4).
- 5 Vezesse át a papírt a papírtartó fedelének nyílásán.
- 6 Helyezze vissza a papírtartó fedelét (1).















Ha az első nyomtatások után módosulnak a mérleg csatlakozási beállításai (baudráta, bit, handshake), a nyomtatót újra kell indítani. Kapcsolja ki, majd kapcsolja be újra a baudráta automatikus észlelésének ismételt indításához. Az automatikus baudráta ki is kapcsolható.

3 Billentyűfunkciók











P25 nyomtató

Működési szint	 Nyomja meg röviden	 Nyomva tartás
	egy sor behúzása	folyamatos behúzás (elengedésig)
 +  On	Nyomtató tesztelése a kimenet beállításával	menü megnyitása
Menüben	 Nyomja meg röviden	 Nyomva tartás
	következő menüelem	tárolás

P26 nyomtató

Működési szint	 Nyomja meg röviden	 Nyomva tartás		
	mérleg nullázása/tárázása	–		
	dátum és idő nyomtatása	–		
	egy sor behúzása	folyamatos behúzás (elengedésig)		
	nyomtatás	menü megnyitása		
Menüben	 Nyomja meg röviden	 Nyomva tartás		
 kilépés	 le	 fel	 következő	 tárolás

P28 nyomtató

Működési szint	Nyomja meg röviden	Nyomva tartás		
	mérleg nullázása/tárázása	–		
	dátum és idő nyomtatása	–		
	egy sor behúzása	folyamatos behúzás (elengedésig)		
	nyomtatás	menü megnyitása		
Menüben	Nyomja meg röviden	Nyomva tartás		
 kilépés	 le	 fel	 következő	 tárolás
Funkció szint	Nyomja meg röviden	Nyomva tartás		
 M+	Összesítő alkalmazás indítása	Összesítő alkalmazás befejezése		
 M+	Statisztikai alkalmazás indítása	Statisztikai alkalmazás befejezése		

4 Menu (Menü)

4.1 P25 nyomtató

Nyomja meg röviden	Nyomva tartás	Printout
<div style="background-color: black; color: white; padding: 2px; text-align: center;">Settings</div> <div style="border: 1px solid black; padding: 2px; text-align: center;">Reset</div>		Settings Reset
<div style="border: 1px dashed gray; padding: 2px; text-align: center;">Csak RS232-csatlakozó</div>	Nyomtató alaphelyzetbe állítása	<pre> ----- Reset done ----- Current settings: Baudrate: 9600 Bit/Parity: 8 Bit Non Handshake: Off Char Set: IBM/DOS </pre>
<div style="background-color: black; color: white; padding: 2px; text-align: center;">Auto Baudrate</div> <div style="border: 1px solid black; padding: 2px; text-align: center;">On</div>	Tárolás	<pre> Auto Baudrate: On -----STORED----- ... "current settings" </pre>
<div style="border: 1px solid black; padding: 2px; text-align: center;">Auto Baudrate Off</div>	Tárolás	<pre> Auto Baudrate: Off -----STORED----- ... "current settings" </pre>
<div style="background-color: black; color: white; padding: 2px; text-align: center;">Char Set</div> <div style="border: 1px solid black; padding: 2px; text-align: center;">IBM / DOS</div>	Tárolás	<pre> IBM/DOS -----STORED----- ... "current settings" </pre>
<div style="border: 1px solid black; padding: 2px; text-align: center;">IBM / DOS Cyrillic</div>	Tárolás	<pre> IBM/DOS Cyrillic -----STORED----- ... "current settings" </pre>
<div style="border: 1px solid black; padding: 2px; text-align: center;">IBM / DOS Japanese</div>	Tárolás	<pre> IBM/DOS Japanese -----STORED----- ... "current settings" </pre>
<div style="border: 1px solid black; padding: 2px; text-align: center;">ANSI / WIN Latin 1</div>	Tárolás	<pre> ANSI/WIN Latin 1 -----STORED----- ... "current settings" </pre>
<div style="border: 1px solid black; padding: 2px; text-align: center;">ANSI / WIN Cyrillic</div>	Tárolás	<pre> ANSI/WIN Cyrillic -----STORED----- ... "current settings" </pre>
<div style="border: 1px solid black; padding: 2px; text-align: center;">ANSI / WIN Japanese</div>	Tárolás	<pre> ANSI/WIN Japanese -----STORED----- ... "current settings" </pre>
<div style="background-color: black; color: white; padding: 2px; text-align: center;">Balance Feature</div> <div style="border: 1px solid black; padding: 2px; text-align: center;">Enable</div>	Tárolás	<pre> Balance Feature: Enable -----STORED----- ... "current settings" </pre>
<div style="border: 1px solid black; padding: 2px; text-align: center;">Balance Feature Disable</div>	Tárolás	<pre> Balance Feature: Disable -----STORED----- ... "current settings" </pre>
<div style="background-color: black; color: white; padding: 2px; text-align: center;">Mentőopció</div> <div style="border: 1px solid black; padding: 2px; text-align: center;">Gyári beállítás</div>		

4.2 P26/P28 nyomtató

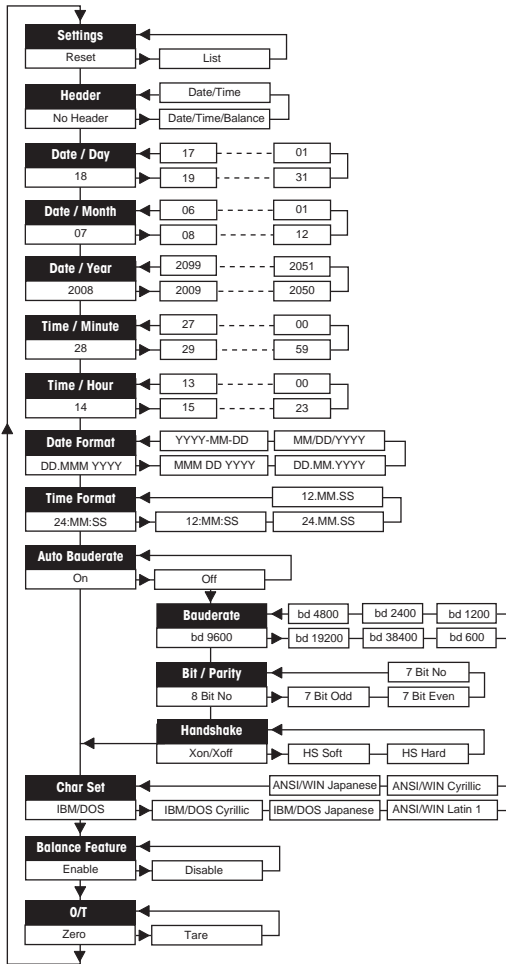

Példák a mérleg kijelzőjének használata esetén:





Beállítások	Reset	rESEt
	List	L 15t
Fejlec	*No Header	no Hdr
	Date/Time	d t Hdr
	Date/Time/Balance	dtb Hdr
Dátum - nap**	18	dAY 18
Dátum - hónap**	07	Month 07
Dátum - év**	2008	YEAR 2008
Idő - perc**	28	n n. 28
Idő - óra**	14	Hour 14
Dátumformátum***	DD.MMM.YYYY	ddMMY
	MMM DD.YYYY	MMY dd Y
	DD.MM.YYYY	ddMMY
	MM/DD/YYYY	MM dd YY
	YYYY-MM-DD	Y-MM-dd
Időformátum***	24:MM:SS	24:MM:SS
	12:MM:SS	12:MM:SS
	24.MM.SS	24MMSS
	12.MM.SS	12MMSS
Baudráta	*9600	bd9600
	19200	bd 19200
	38400	bd38400
	600	bd600
	1200	bd 1200
	2400	bd2400
	4800	bd4800
Bit/Paritás	*8 Bit No	8b-no
	7 Bit Odd	7b-odd
	7 Bit Even	7b-E
	7 Bit No	7b-no
Handshake	*Xon/Xoff	HS oFF
	HS Soft	HS SoFt
	HS Hard	HS HARd
Karakterkészlet	*IBM/DOS	d05
	IBM/DOS Cyrillic	d05 C4r
	IBM/DOS Japanese	d05 JAP
	Ansi/Win Latin 1	11 n LAt
	Ansi/Win Cyrillic	11 n C4r
	Ansi/Win Japanese	11 n JAP
Tárzás/nullázás	*Zero	ZEr-o
	Tare	tAR-E

Menüopció
Gyári beállítás

- * gyári beállítások
- ** **beépített órával rendelkező műszerek:** nem érvényes; a beépített órának prioritása van
- *** **beépített órával rendelkező műszerek:** a nyomtató formátumának prioritása van

Példa a nap beállítására (csak P26 / P28 esetén)

Nyissa meg a menüt

- Tartsa lenyomva a következő gombot , amíg meg nem jelenik a **Reset** (Visszaállítás).
- A  gombbal válassza ki a **Day** (Nap) menüopciót.
- Válassza ki a napot; például 21-e.
A következő gombbal görgethet felfelé: .
A következő gombbal görgethet lefelé: .

Mentse el a beállításokat



- Tartsa lenyomva a következő gombot , amíg meg nem jelenik a **Stored** (Tárolva).

Statistikai alkalmazás (kizárólag P28 esetén)



A mintatömegnek az aktuális átlagos érték 70–130%-ában kell lennie.

A módosított minimális dinamikus tömeg értéke 100 d kell, hogy legyen.

- 1 Nyomja meg a következő gombot a Statistika alkalmazás elindításához:  (a led kigyullad).
- 2 Helyezze be az új mintát, és nyomja meg az **M+** gombot.
- 3 Ha szükséges, a következő gomb megnyomásával nyomtathatja ki a részösszeget: .
- 4 A nyomtatáshoz és a Statistika alkalmazás bezárásához tartsa lenyomva a következő gombot:  (a led kialszik).





Jegyezd

- Az alkalmazás használata közben nem lehet módosítani az egységet.
- Maximum: 999 minta.

Összesítő alkalmazás (kizárólag P28 esetén)



Minimum tömeg + 1 d.

- 1 Nyomja meg a következő gombot az Összesítő alkalmazás elindításához:  (a led kigyullad).
- 2 Helyezze be az új mintát, és nyomja meg az **M+** gombot.
- 3 Ha szükséges, a következő gomb megnyomásával nyomtathatja ki a részösszeget: .
- 4 A nyomtatáshoz és az Összesítő alkalmazás bezárásához tartsa lenyomva a következő gombot:  (a led kialszik).



Jegyezd

- Az alkalmazás használata közben nem lehet módosítani az egységet.
- Maximum: 999 minta.

5 Karbantartás



FIGYELMEZTETÉS

Halált vagy súlyos sérülést okozó áramütés veszélye

Az áram alatt lévő alkatrészek érintése sérülést, vagy akár halált is okozhat.

- 1 Tisztítás és karbantartás előtt válassza le a nyomtatót a tápellátásról.
- 2 Ügyeljen rá, hogy ne kerülhessen folyadék a nyomtatóba vagy a hálózati adapter belsejébe.

5.1 A papírtekercs cseréje

Az új papírtekercs behelyezéséről a [Papír behelyezése ▶ 44. oldal] című részben talál leírást. A papírtekercs rendelési száma a [Fogyóeszközök ▶ 52. oldal] részben található.



Jegyezd

A forgó tengelyt mindig át kell tenni a régi tekercsből az újba.

5.2 A festékszalag cseréje

A szalagkazetta rendelési száma a [Fogyóeszközök ▶ 52. oldal] részben található.

- 1 Távolítsa el a papírtartó fedelét (1).
- 2 Húzza ki a papírt a nyomatóegységből (2).



- 3 A nyíl irányában benyomva távolítsa el a festékszalag kazettáját (3).
- 4 Helyezze be az új festékszalag-kazettát. Ha szükséges, feszítse meg újra a feszítőláncsávval (4).

Új papírtekercs behelyezéséről a [Papír behelyezése ▶ 44. oldal] című részben talál leírást.



5.3 A borítás tisztítása

Mivel a nyomtató borítása kiváló minőségű, ellenálló anyagokból készült, kereskedelmi forgalomban kapható bármilyen enyhe tisztítószerrel tisztítható.



ÉRTESÍTÉS

A nem megfelelő tisztítási módszerek károsíthatják a nyomtatót

A nyomtató borítása kiváló minőségű, ellenálló anyagokból készült, de bizonyos tisztítószer, oldószer és sűrűsítőszer károsíthatják. Ha folyadék kerül a borítás alá, a nyomtató megrongálódhat.

- 1 A nyomtató tisztításához vizes, enyhe tisztítószeres oldatot használjon.
- 2 A ráömlött folyadékot azonnal törölje le.
- 3 Ügyeljen rá, hogy folyadék ne kerülhessen a nyomtató belsejébe.

Az elérhető szervizlehetőségekkel kapcsolatos tudnivalóért forduljon a METTLER TOLEDO képviselőjéhez – az elismert szervizmérnök által végzett rendszeres karbantartás hosszú távon biztosítja a tömegmérés pontosságát és megnöveli a műszer élettartamát.

6 Műszaki adatok

6.1 Általános műszaki adatok

Tápellátás

AC/DC adapter:	Primer kör: 100–240 V~, 50/60 Hz Szekunder kör: 12 V egyenáram, 2,5 A (elektronikus túlférhelés-védelemmel)
AC/DC adapter kábele:	3 eres, országspecifikus csatlakozóval
Polaritás:	 áramkorlátozott SELV (biztonsági extra alacsony feszültség) kimenettel
Hálózati feszültség:	12 V DC
Teljesítményfelvétel:	Max. 2.5 A

Védelem és szabványok

Túlfeszültség kategória:	II
Szennyezettségi szint:	2
Biztonsági és EMC szabványok:	Lásd a Megfelelőségi nyilatkozatot
Alkalmazási terület:	Csak beltérben való használatra

Környezeti feltételek

Tengerszint feletti magasság:	Legfeljebb 4000 m
Környezeti hőmérséklet:	0–+40 °C
Tárolási körülmények:	-25–+60 °C
Relatív páratartalom:	Max. 80% legfeljebb 31 °C-ig, lineárisan csökken 50%-ra 40 °C-on; nem kondenzálódó

Nyomatási tulajdonságok

Nyomatási technológia:	5 × 7-es pontmátrix, 24 karakter/sor
Nyomatás sebessége:	2,3 sor másodpercenként
Szalagkazetta:	Cserélhető, fekete
Papírtekercs:	Szabványos, 57,5 mm-es papír 50–60 mm-es átmérővel, behelyezve a borításba, kereskedelmi méret
Nyomatás minősége:	Fényálló és hőstabil nyomtatás (GLP, GMP, ISO 9001)
Interfészek:	RS-P25, RS-P26, RS-P28 USB-P25
Kompatibilitási korlátozások:	USB <ul style="list-style-type: none">Dátum és idő funkció: nem érvényes beépített órával rendelkező mérlegeken (a beépített órának prioritása van)Nullázás/tárázás funkció: nem érvényes minden mérlegtípuson

Méretek / tömeg

Nyomatató méretei (Szé × Mé × Ma):	120 × 203 × 73 mm
Méreték csomagolva (Szé × Mé × Ma):	255 × 205 × 150 mm
Nettó tömeg:	740 g (papírtekercssel együtt)

7 Fogyóeszközök

Ismertetés

Alkatrészszám

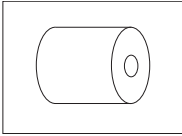

Papírtekercs (hosszúság: 20 m), 5 db-os készlet

00072456

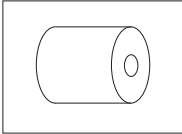

Papírtekercs (hosszúság: 13 m), öntapadó, 3 db-os készlet

11600388

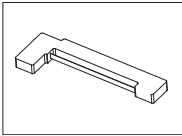

Szalagkazetta, fekete, 2 db-os készlet

00065975

1 Informazioni sulla sicurezza

Per questo strumento sono disponibili due documenti denominati "Manuale per l'utente" e "Istruzioni d'uso".

- Il manuale per l'utente mostra come iniziare a utilizzare lo strumento.
- Le istruzioni d'uso contengono una descrizione completa dello strumento e del suo utilizzo.
- Conservare entrambi i documenti per eventuali consultazioni future.
- In caso di trasferimento dello strumento a terzi, consegnare anche entrambi i documenti.

Utilizzare lo strumento conformemente al manuale per l'utente e alle istruzioni d'uso. Se lo strumento non viene utilizzato conformemente a questi documenti o se viene modificato, la sua sicurezza potrebbe essere compromessa e Mettler-Toledo GmbH non si assumerà alcuna responsabilità.

1.1 Altri documenti applicabili



Il presente Manuale per l'utente è una guida rapida che fornisce informazioni per gestire in modo sicuro ed efficiente i primi passi con lo strumento. Il personale deve aver letto con attenzione e compreso appieno il presente manuale prima di eseguire qualsiasi operazione.

Per maggiori informazioni, consultare sempre il Manuale di riferimento.

► www.mt.com/printer-p-20-RM

1.2 Definizioni delle parole e dei simboli di avvertimento

Le note di sicurezza contengono informazioni importanti sulla sicurezza. Ignorare le note di sicurezza può portare a lesioni personali, danni allo strumento, malfunzionamenti o risultati errati. Le note di sicurezza sono indicate con le seguenti parole o simboli di avvertimento:

Parole di avvertimento

AVVERTENZA Situazione pericolosa a medio rischio che, se non evitata, potrebbe causare lesioni gravi o pericolo di morte.

ATTENZIONE Situazione pericolosa a basso rischio che, se non evitata, potrebbe causare lesioni di lieve o media entità.

AVVISO Situazione pericolosa a basso rischio che, se non evitata, potrebbe arrecare danni allo strumento, altri danni materiali, malfunzionamenti, risultati erronei o perdita di dati.

Simboli di avvertimento



Folgorazione



Pericolo generico: leggere le istruzioni d'uso per informazioni sui rischi e sulle relative misure preventive.



Avviso

1.3 Note sulla sicurezza specifiche del prodotto

Uso previsto

Questo strumento è stato progettato per l'uso nei laboratori da parte di personale esperto. Lo strumento serve per effettuare protocolli di stampa.

Qualsiasi utilizzo o funzionamento diverso da quelli chiaramente indicati nelle specifiche tecniche e non espressamente consentito per iscritto Mettler-Toledo GmbH non è considerato compatibile.

Responsabilità del proprietario dello strumento

Il proprietario dello strumento è la persona che ne detiene la titolarità e che utilizza lo strumento o ne autorizza l'uso da parte di altre persone, oppure la persona considerata dalla legge operatore dello strumento. Il proprietario dello strumento è responsabile per la sicurezza di tutti gli utenti dello stesso e di terzi.

METTLER TOLEDO presuppone che il proprietario dello strumento formi gli utenti all'utilizzo sicuro dello stesso sul proprio luogo di lavoro e a gestire i rischi potenziali. METTLER TOLEDO presuppone che il proprietario dello strumento fornisca i dispositivi di protezione richiesti.

Note sulla sicurezza



AVVERTENZA

Rischio di morte o lesioni gravi a causa di scosse elettriche

Il contatto con elementi in tensione può causare morte o lesioni.

- 1 Utilizzare esclusivamente l'alimentatore METTLER TOLEDO approvato e l'adattatore CA/CC con uscita SELV limitata.
- 2 Collegare il cavo di alimentazione a una presa elettrica dotata di messa a terra, verificando la polarità corretta.
- 3 Tenere tutti i cavi elettrici e i collegamenti lontani da liquidi e umidità.
- 4 Controllare che i cavi e la spina non siano danneggiati; all'occorrenza, sostituirli.



AVVISO

Pericolo di danneggiamento dello strumento dovuto all'uso di componenti non adatti

L'uso di componenti non adatti con lo strumento può danneggiarlo oppure provocarne il malfunzionamento.

- Utilizzare esclusivamente componenti METTLER TOLEDO destinati all'uso con lo strumento.

2 Installazione e messa in funzione

2.1 Contenuto della fornitura

- Adattatore CA/CC
- Cavo di alimentazione (a seconda del paese)
- Manuale per l'utente
- Dichiarazione di conformità

2.2 Collegamento della stampante all'alimentatore



! AVVERTENZA

Rischio di morte o lesioni gravi a causa di scosse elettriche

Il contatto con elementi in tensione può causare morte o lesioni.

- 1 Utilizzare esclusivamente l'alimentatore METTLER TOLEDO approvato e l'adattatore CA/CC con uscita SELV limitata.
- 2 Collegare il cavo di alimentazione a una presa elettrica dotata di messa a terra, verificando la polarità corretta.
- 3 Tenere tutti i cavi elettrici e i collegamenti lontani da liquidi e umidità.
- 4 Controllare che i cavi e la spina non siano danneggiati; all'occorrenza, sostituirli.



AVVISO

Danni all'adattatore CA/CC causati da surriscaldamento

Se l'adattatore CA/CC è coperto oppure si trova all'interno di un contenitore, non è raffreddato a sufficienza e si surriscalda.

- 1 Non coprire l'adattatore CA/CC.
- 2 Non inserire l'adattatore CA/CC in un contenitore.

La stampante è fornita con un alimentatore CA/CC universale o con un adattatore CA/CC e un cavo di alimentazione specifico per Paese.

- Installare i cavi in modo che non possano essere danneggiati e non interferiscano con il funzionamento.
- Collegare il cavo di alimentazione a una presa elettrica dotata di messa a terra facilmente accessibile.

- 1 Collegare l'adattatore CA/CC alla presa di corrente di collegamento sul retro della stampante.
- 2 Bloccare il connettore mediante il dado a vite.
- 3 Collegare il cavo di alimentazione tripolare alla presa di corrente per l'adattatore CA/CC.
- 4 Collegare la stampante e la bilancia mediante il cavo di interfaccia.
- 5 Accendere la bilancia.
- 6 Collegare la stampante all'alimentatore.
- 7 Accendere la stampante tramite l'interruttore I/O.

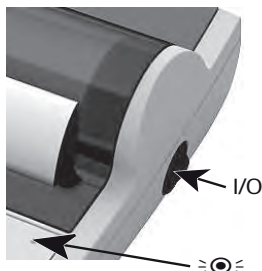

Nota

Solo per interfaccia RS232: la lampada spia lampeggia fino a quando non viene collegato uno strumento. Se la lampada lampeggia ancora, fare riferimento al capitolo "Risoluzione dei problemi" del manuale di riferimento.

2.3 Inserimento carta



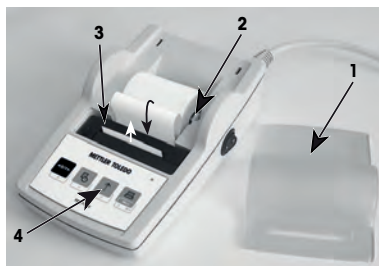





- 1 Rimuovere il coperchio carta (tirare sul retro) (1).
- 2 Inserire l'asse di rotazione della carta all'interno del rotolo di carta (2).
- 3 Far passare la carta attraverso la fessura nell'unità di stampa in direzione della freccia (3).
- 4 Tenere premuto finché non è entrata carta sufficiente nella stampante (4).
- 5 Far passare la carta attraverso la fessura del coperchio carta.
- 6 Posizionare il coperchio carta (1).















Se, dopo le prime stampe le impostazioni di collegamento (velocità di trasmissione, bit, handshake) della bilancia vengono modificate, la stampante deve essere riavviata. Spegnerne/accendere per riavviare il rilevamento automatico della velocità di trasmissione. La velocità di trasmissione automatica può essere disattivata.

3 Funzioni pressione tasti

















Stampante P25

Livello di funzionamento	 Pressione breve	 Premere e tenere premuto
	alimentazione singola	alimentazione continua (fino al rilascio)
  On	Prova della stampante con stampa delle impostazioni	aprire il menu
Livello menu	 Pressione breve	 Premere e tenere premuto
	voce di menu successiva	memorizzare

Stampante P26

Livello di funzionamento	 Pressione breve	 Premere e tenere premuto		
	zero/tarare la bilancia	–		
	stampa data e ora	–		
	alimentazione singola	alimentazione continua (fino al rilascio)		
	stampare	aprire il menu		
Livello menu	 Pressione breve	 Premere e tenere premuto		
 uscire	 giù	 su	 avanti	 memorizzare

Stampante P28

Livello di funzionamento	 Pressione breve	 Premere e tenere premuto
	zero/farare la bilancia	–
	stampa data e ora	–
	alimentazione singola	alimentazione continua (fino al rilascio)
	stampare	aprire il menu
Livello menu	 Pressione breve	 Premere e tenere premuto
 uscire	 giù	 su
 avanti	 memorizzare	
Livello funzione	 Pressione breve	 Premere e tenere premuto
	Avviare applicazione Totale	Terminare applicazione Totale
	Avviare applicazione Statistiche	Terminare applicazione Statistiche

4 Menu

4.1 Stampante P25

Pressione breve	Premere e tenere premuto	Stampa
<div style="border: 1px solid black; padding: 5px; text-align: center;">Settings</div> <div style="border: 1px solid black; padding: 5px; text-align: center;">Reset</div>	<p>Ripristino della stampante</p>	<pre>Settings Reset</pre>
<div style="border: 1px solid black; padding: 5px; text-align: center;">Solo per interfaccia RS232</div>		<pre>----- Reset done ----- Current settings: Baudrate: 9600 Bit/Parity: 8 Bit Non Handshake: Off Char Set: IBM/DOS</pre>
<div style="border: 1px solid black; padding: 5px; text-align: center;">Auto Baudrate</div> <div style="border: 1px solid black; padding: 5px; text-align: center;">On</div>	<p>Memorizzare</p>	<pre>Auto Baudrate: On -----STORED----- ... "current settings"</pre>
<div style="border: 1px solid black; padding: 5px; text-align: center;">Auto Baudrate</div> <div style="border: 1px solid black; padding: 5px; text-align: center;">Off</div>	<p>Memorizzare</p>	<pre>Auto Baudrate: Off -----STORED----- ... "current settings"</pre>
<div style="border: 1px solid black; padding: 5px; text-align: center;">Char Set</div> <div style="border: 1px solid black; padding: 5px; text-align: center;">IBM / DOS</div>	<p>Memorizzare</p>	<pre>IBM/DOS -----STORED----- ... "current settings"</pre>
<div style="border: 1px solid black; padding: 5px; text-align: center;">IBM / DOS</div> <div style="border: 1px solid black; padding: 5px; text-align: center;">Cyrillic</div>	<p>Memorizzare</p>	<pre>IBM/DOS Cyrillic -----STORED----- ... "current settings"</pre>
<div style="border: 1px solid black; padding: 5px; text-align: center;">IBM / DOS</div> <div style="border: 1px solid black; padding: 5px; text-align: center;">Japanese</div>	<p>Memorizzare</p>	<pre>IBM/DOS Japanese -----STORED----- ... "current settings"</pre>
<div style="border: 1px solid black; padding: 5px; text-align: center;">ANSI / WIN</div> <div style="border: 1px solid black; padding: 5px; text-align: center;">Latin 1</div>	<p>Memorizzare</p>	<pre>ANSI/WIN Latin 1 -----STORED----- ... "current settings"</pre>
<div style="border: 1px solid black; padding: 5px; text-align: center;">ANSI / WIN</div> <div style="border: 1px solid black; padding: 5px; text-align: center;">Cyrillic</div>	<p>Memorizzare</p>	<pre>ANSI/WIN Cyrillic -----STORED----- ... "current settings"</pre>
<div style="border: 1px solid black; padding: 5px; text-align: center;">ANSI / WIN</div> <div style="border: 1px solid black; padding: 5px; text-align: center;">Japanese</div>	<p>Memorizzare</p>	<pre>ANSI/WIN Japanese -----STORED----- ... "current settings"</pre>
<div style="border: 1px solid black; padding: 5px; text-align: center;">Balance Feature</div> <div style="border: 1px solid black; padding: 5px; text-align: center;">Enable</div>	<p>Memorizzare</p>	<pre>Balance Feature: Enable -----STORED----- ... "current settings"</pre>
<div style="border: 1px solid black; padding: 5px; text-align: center;">Balance Feature</div> <div style="border: 1px solid black; padding: 5px; text-align: center;">Disable</div>	<p>Memorizzare</p>	<pre>Balance Feature: Disable -----STORED----- ... "current settings"</pre>

Opzione menu
postazione di fabbrica

4.2 Stampante P26/P28

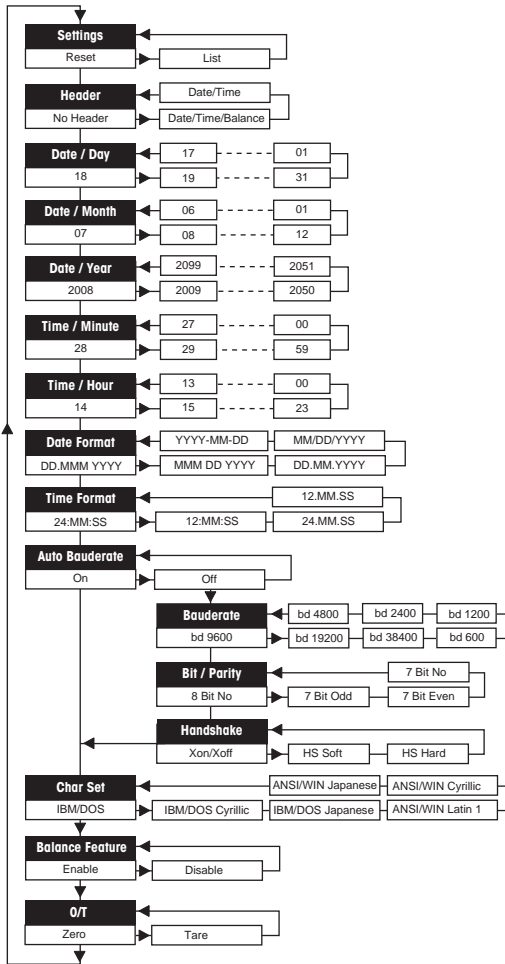

Esempi nel caso in cui venga utilizzato il display della bilancia:

Impostazioni	Reset	rESEt
	List	L 15t
Intestazione	*No Header	no Hdr
	Date/Time	d t Hdr
	Date/Time/Balance	dtb Hdr
Data Giorno**	18	dRY 18
Data Mese**	07	month 07
Data Anno**	2008	YEAR 2008
Orario Minuti**	28	n in 28
Orario Ore**	14	hour 14
Formato Data***	DD.MMM.YYYY	ddmmY
	MMM DD.YYYY	mm dd Y
	DD.MM.YYYY	ddmmY
	MM/DD/YYYY	mm dd Y
	YYYY-MM-DD	Y-mm-dd
Formato Orario***	24:MM:SS	24:mm:ss
	12:MM:SS	12:mm:ss
	24.MM.SS	24mmSS
	12.MM.SS	12mmSS
Velocità di trasmissione (Baud)	*9600	bd9600
	19200	bd 19200
	38400	bd38400
	600	bd600
	1200	bd 1200
	2400	bd2400
	4800	bd4800
Bit/Parità	*8 Bit No	8b-no
	7 Bit Odd	7b-odd
	7 Bit Even	7b-E
	7 Bit No	7b-no
Handshake	*Xon/Xoff	HS oFF
	HS Soft	HS SoFt
	HS Hard	HS HArd
Set di caratteri	*IBM/DOS	d05
	IBM/DOS Cyrillic	d05 C4r
	IBM/DOS Japanese	d05 JRP
	Ansi/Win Latin 1	11 in LAt
	Ansi/Win Cyrillic	11 in C4r
	Ansi/Win Japanese	11 in JRP
Tara/Zero	*Zero	ZErO
	Tare	tArE

Opzione menu
postazione di fabbrica



* impostazioni di fabbrica

** **strumenti con orologio integrato:** non applicabile, l'orologio integrato ha la priorità

*** **strumenti con orologio integrato:** il formato della stampante ha la priorità

Esempio di impostazione del giorno (solo per P26/P28)

Aprire il menu

- Tenere premuto il tasto  fino a quando non compare **Ripristino**.
- Selezionare l'opzione menu **Giorno** con il tasto .
- Selezionare il giorno, per esempio giorno 21.
Scorrere verso l'alto con il tasto \uparrow .
Scorrere verso il basso con il tasto \downarrow .

Salvare le impostazioni



- Tenere premuto il tasto  fino a quando non compare **Memorizzato**.

Applicazione Statistiche (solo P28)



Il peso del campione deve essere compreso nell'intervallo 70-130% del valore medio attuale.

Il peso dinamico minimo modificato deve essere pari a 100 d.

- 1 Premere  per avviare l'applicazione Statistiche (LED acceso).
- 2 Aggiungere un nuovo campione e premere **M+**.
- 3 Se necessario, premere  per stampare il sottotale.
- 4 Premere e tenere premuto  per stampare e terminare l'applicazione Statistiche (LED spento).



Nota

- Il cambio dell'unità durante l'applicazione non è consentito.
- Massimo 999 campioni.

Applicazione Totale (solo P28)



Pesate minime + 1 d.

- 1 Premere  per avviare l'applicazione Totale (LED acceso).
- 2 Aggiungere un nuovo campione e premere **M+**.
- 3 Se necessario, premere  per stampare il sottotale.
- 4 Premere e tenere premuto  per stampare e terminare l'applicazione Totale (LED spento).

Nota

- Il cambio dell'unità durante l'applicazione non è consentito.
- Massimo 999 campioni.

5 Manutenzione



AVVERTENZA

Rischio di morte o lesioni gravi a causa di scosse elettriche

Il contatto con elementi in tensione può causare lesioni e morte.

- 1 Scollegare la stampante dall'alimentatore prima di effettuare interventi di pulizia o manutenzione.
- 2 Evitare l'ingresso di liquidi all'interno della stampante e dell'adattatore CA/CC.

5.1 Sostituzione del rotolo di carta

L'inserimento di un nuovo rotolo di carta è descritto nel capitolo [Inserimento carta ▶ pagina 56]. Il codice per il rotolo di carta si trova nel capitolo [Materiali di consumo ▶ pagina 64].

Nota

L'asse di rotazione della carta deve sempre essere trasferito dal vecchio rotolo di carta a quello nuovo.

5.2 Sostituzione del nastro

Il codice per la cartuccia a nastro si trova nel capitolo [Materiali di consumo ▶ pagina 64].

- 1 Rimuovere il coperchio carta (1).
- 2 Estrarre la carta dall'unità di stampa (2).



- 3 Rimuovere la cartuccia a nastro premendo in direzione della freccia (3).
- 4 Inserire la nuova cartuccia a nastro. In caso di necessità, avvolgere l'allentamento tramite la rotella di tensione (4).

L'inserimento di un nuovo rotolo di carta è descritto nel capitolo [Inserimento carta ▶ pagina 56].



5.3 Pulizia dell'alloggiamento

Lo chassis della stampante è realizzato con materiali resistenti di alta qualità, e può essere dunque pulito con uno degli agenti detergenti non aggressivi disponibili in commercio.



AVVISO

Rischio di danni alla stampante causati da metodi di pulizia inadeguati

La stampante è realizzata con materiali resistenti di alta qualità e può quindi essere pulita con uno degli agenti detergenti non aggressivi in commercio. L'ingresso di liquidi nell'alloggiamento può danneggiare la stampante.

- 1 Per pulire la stampante, utilizzare acqua e un detergente delicato.
- 2 Asciugare immediatamente qualsiasi fuoriuscita.
- 3 Evitare l'ingresso di liquidi all'interno della stampante.

Contattare un METTLER TOLEDO esperto METTLER TOLEDO per conoscere le opzioni di assistenza tecnica disponibili. La manutenzione regolare svolta da un tecnico dell'assistenza autorizzato garantisce una costante accuratezza di pesata a lungo termine e prolunga la vita utile dello strumento.

6 Dati tecnici

6.1 Dati tecnici generali

Alimentatore

Adattatore CA/CC:	Tensione in entrata: da 100 a 240 V, 50/60 Hz Tensione in uscita: 12 V CC, 2,5 A (con protezione elettronica dal sovraccarico)
Cavo per adattatore CA/CC:	a 3 poli, con connettore specifico per Paese
Polarità:	 con un'uscita di corrente SELV (Safety Extra Low Voltage)
Tensione di linea:	12 V CC
Consumo elettrico:	Max. 2,5 A

Protezione e standard

Categoria di sovratensione:	II
Livello di inquinamento:	2
Standard per la sicurezza ed EMC:	Consultare la Dichiarazione di conformità
Campo di applicazione:	Utilizzare esclusivamente in ambienti chiusi e asciutti

Condizioni ambientali

Altezza sopra il livello medio del mare:	Fino a 4.000 m
Temperatura ambiente:	Da 0 a 40 °C
Condizioni di conservazione:	Da -25 a 60 °C
Umidità relativa dell'aria:	Max. 80% fino a 31 °C, decrescente linearmente fino al 50% a 40 °C, senza condensa

Caratteristiche della stampante

Tecnologia di stampa:	Stampante ad aghi 5 x 7, lunghezza riga: 24 caratteri
Velocità di stampa:	2,3 righe al secondo
Cartuccia a nastro:	Sostituibile, nera
Rotolo di carta:	Carta standard: 57,5 mm x ø da 50 a 60 mm, integrata nell'alloggiamento, dimensioni commerciali
Qualità di stampa:	Stampa fotoresistente e termicamente stabile (GLP, GMP, ISO 9001)
Interfacce:	RS-P25, RS-P26, RS-P28, RS232C USB-P25, USB
Limiti di compatibilità:	<ul style="list-style-type: none">• Funzione Data/Ora: non applicabile su bilance con orologio integrato (l'orologio integrato ha la priorità)• Funzione Azzeramento/Tara: non applicabile su tutti i modelli di bilance

Dimensione/Peso

Dimensioni della stampante (L x P x A):	120 x 203 x 73 mm
Dimensioni della confezione (L x P x A):	255 x 205 x 150 mm

Peso netto:

740 g (incl. rotolo di carta)

7 Materiali di consumo

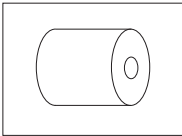
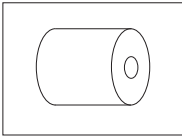
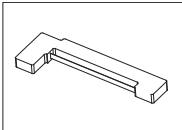
	Descrizione	N° pezzo
	Rotolo di carta (lunghezza: 20 m), set di 5 pezzi	00072456
	Rotolo di carta (lunghezza: 13 m), autoadesivo, set di 3 pezzi	11600388
	Cartuccia a nastro, nera, 2 pezzi	00065975

1 Veiligheidsinformatie

Voor dit apparaat zijn twee documenten beschikbaar, de handleiding en de bedieningsinstructies.

- In de handleiding wordt beschreven hoe u het instrument in gebruik neemt.
- De bedieningsinstructies bevatten een volledige beschrijving van het instrument en het gebruik ervan.
- Bewaar beide documenten voor naslagdoeleinden.
- Vergeet niet deze handleiding bij te voegen als u het instrument aan derden doorgeeft.

Gebruik het instrument uitsluitend volgens de handleiding en de bedieningsinstructies. Als u het instrument niet volgens deze documenten gebruikt of als het instrument wordt aangepast, kan de veiligheid van het instrument niet worden gewaarborgd. Mettler-Toledo GmbH kan hiervoor niet aansprakelijkheid worden gesteld.

1.1 Aanvullende documentatie



Deze beknopte handleiding biedt informatie over een veilige en efficiënte uitvoering van de eerste stappen van het instrument. Gebruikers moeten deze handleiding hebben gelezen en begrepen voordat ze werkzaamheden gaan uitvoeren.

Zorg dat u voor volledige informatie altijd de referentiehandleiding (RM) raadpleegt.

► www.mt.com/printer-p-20-RM

1.2 Definitie van signaalwoorden en waarschuwingssymbolen

De veiligheidsovermerkingen bevatten belangrijke informatie over de veiligheid. Het negeren van de veiligheidsovermerkingen kan leiden tot letsel, schade aan het instrument, storingen en onjuiste resultaten. Veiligheidsovermerkingen worden aangegeven met de volgende signaalwoorden en waarschuwingssymbolen:

Signaalwoorden

WAARSCHUWING Een gevaarlijke situatie met matig risico die, als deze niet wordt vermeden, kan leiden tot ernstig of dodelijk letsel.

VOORZICHTIG Een gevaarlijke situatie met laag risico die, als deze niet wordt vermeden, kan leiden tot licht of matig letsel.

LET OP Een gevaarlijke situatie met laag risico die kan leiden tot schade aan het instrument, andere materiële schade, storingen en onjuiste resultaten, of verlies van gegevens.

Waarschuwingssymbolen



Elektrische schok



Algemeen gevaar: lees de bedieningsinstructies voor informatie over de gevaren en de benodigde voorzorgsmaatregelen.



Let op

1.3 Productspecifieke veiligheidsovermerkingen

Beoogd gebruik

Dit instrument is bedoeld voor gebruik door vakbekwame laboranten. Het instrument is bedoeld voor het afdrucken van protocollen.

Gebruik op enige andere wijze en gebruik buiten de grenswaarden van de technische specificaties zonder schriftelijke toestemming van Mettler-Toledo GmbH wordt beschouwd als niet beoogd gebruik.

Verantwoordelijkheden van de eigenaar van het instrument

Als eigenaar van het instrument wordt degene beschouwt die het wettelijke eigendomsrecht van het instrument bezit en die het instrument gebruikt of een persoon toestemming geeft het instrument te gebruiken, of degene die het instrument wettelijk gezien bedient. De eigenaar van het instrument is verantwoordelijk voor de veiligheid van alle gebruikers van het instrument en van derden.

METTLER TOLEDO gaat ervan uit dat de eigenaar van het instrument gebruikers instrueert hoe het instrument veilig te gebruiken op de werkplek en hoe om te gaan met mogelijke gevaren. METTLER TOLEDO gaat ervan uit dat de eigenaar van het instrument de noodzakelijke beschermingsmiddelen verstrekt.

Veiligheidsinformatie



WAARSCHUWING

Ernstig of dodelijk letsel door elektrische schok

Contact met onderdelen die onder stroom staan, kan ernstig of dodelijk letsel veroorzaken.

- 1 Gebruik uitsluitend de goedgekeurde METTLER TOLEDO-voedingskabel en een netadapter met een stroombegrensd SELV-uitgang.
- 2 Sluit de voedingskabel aan op een geaard stopcontact en let daarbij op de juiste polariteit.
- 3 Houd alle elektrische kabels en aansluitingen uit de buurt van vloeistoffen en vocht.
- 4 Controleer de kabels en de stekker op beschadigingen, en vervang beschadigde kabels en stekkers.



LET OP

Het instrument kan beschadigd raken door het gebruik van ongeschikte onderdelen.

Het instrument kan beschadigd of defect raken wanneer u ongeschikte onderdelen met het instrument gebruikt.

- Gebruik uitsluitend onderdelen van METTLER TOLEDO die zijn bedoeld voor gebruik met uw instrument.

2 Installatie en inbedrijfstelling

2.1 Leveringsomvang

- Netadapter
- Voedingskabel (landspecifiek)
- Handleiding
- Conformiteitsverklaring

2.2 De printer aansluiten op de voeding



WAARSCHUWING

Ernstig of dodelijk letsel door elektrische schok

Contact met onderdelen die onder stroom staan, kan ernstig of dodelijk letsel veroorzaken.

- 1 Gebruik uitsluitend de goedgekeurde METTLER TOLEDO-voedingskabel en een netadapter met een stroombegrensende SELV-uitgang.
- 2 Sluit de voedingskabel aan op een geaard stopcontact en let daarbij op de juiste polariteit.
- 3 Houd alle elektrische kabels en aansluitingen uit de buurt van vloeistoffen en vocht.
- 4 Controleer de kabels en de stekker op beschadigingen, en vervang beschadigde kabels en stekkers.



LET OP

Schade aan de netadapter door oververhitting

Als de netadapter wordt afgedekt of in een container wordt geplaatst, wordt hij onvoldoende gekoeld en raakt hij oververhit.

- 1 Dek de netadapter niet af.
- 2 Plaats de netadapter niet in een container.

De printer wordt geleverd met een universele netadapter of een netadapter met landspecifieke voedingskabel.

- Zorg ervoor dat de aangesloten kabels niet beschadigd kunnen raken en de bediening van de balans niet hinderen.
- Steek de stekker van de voedingskabel in een geaard en goed toegankelijk stopcontact.

- 1 Sluit de netadapter aan op de aansluitbus aan de achterkant van de printer.
- 2 Zet de stekker vast met de schroefmoer.
- 3 Sluit de 3-polige voedingskabel aan op de aansluiting voor de netadapter.
- 4 Sluit de printer en de balans aan met de interfacekabel.
- 5 Schakel de balans in.
- 6 Sluit de printer aan op de voeding.
- 7 Schakel de printer in met de **I/O**-schakelaar.

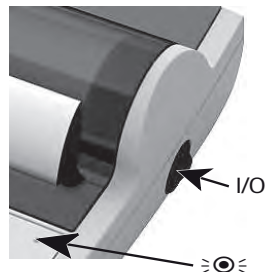

Opmerking

alleen voor RS232-interface: de signaallamp knippert totdat het instrument is aangesloten. Als de lamp blijft knipperen, raadpleegt u het hoofdstuk "Probleemoplossing" in de referentiehandleiding.

2.3 Papier plaatsen



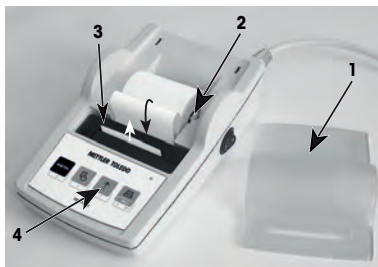





- 1 Verwijder het deksel van het papiervak (trek de achterkant omhoog) (1).
- 2 Steek de draais door de kern van de papierrol (2).
- 3 Voer het papier door de gleuf in de afdrukeenheid in de richting van de pijl (3).
- 4 Houd de invoerknop ingedrukt totdat er voldoende papier is ingevoerd (4).
- 5 Haal het papier door de gleuf in het deksel van het papiervak.
- 6 Plaats het deksel terug op het papiervak (1).















Als de verbindinginstellingen (baudsnelheid, bits, handshaking) van de balans na de eerste afdrukken worden gewijzigd, moet u de printer opnieuw starten. Schakel de printer uit en dan weer in om de automatische baudsnelheidsdetectie opnieuw te starten. De automatische baudsnelheidsdetectie kan worden uitgeschakeld.

3 Toetsfuncties











Printer P25

Bedieningsniveau	 Kort indrukken	 Ingedrukt houden
	Eén regel invoeren	Doorlopende invoer (totdat u de knop loslaat)
 +  On	Printer testen met afdrukinstelling	Menu openen
Menuniveau	 Kort indrukken	 Ingedrukt houden
	Volgende menuoptie	Opslaan

Printer P26

Bedieningsniveau	 Kort indrukken	 Ingedrukt houden		
	De balans op nul stellen/tarreren	–		
	Datum en tijd afdrukken	–		
	Eén regel invoeren	Doorlopende invoer (totdat u de knop loslaat)		
	Afdrukken	Menu openen		
Menuniveau	 Kort indrukken	 Ingedrukt houden		
 Afsluiten	 Omlaag	 Omhoog	 Volgende	 Opslaan

Printer P28

Bedieningsniveau	Kort indrukken	Ingedrukt houden			
	De balans op nul stellen/farreren	–			
	Datum en tijd afdrukken	–			
	Eén regel invoeren	Doorlopende invoer (totdat u de knop loslaat)			
	Afdrukken	Menu openen			
Menu-niveau	Kort indrukken	Ingedrukt houden			
 Afsluiten	 Omlaag	 Omhoog	 Volgende		Opslaan
Functieniveau	Kort indrukken	Ingedrukt houden			
 M+	Toepassing Totaliseren starten	Toepassing Totaliseren voltooien			
 M+	Toepassing Statistieken starten	Toepassing Statistieken voltooien			

4 Menu

4.1 Printer P25

Kort indrukken	Ingedrukt houden	Afdruk
<div style="border: 1px solid black; padding: 5px;"> <p style="text-align: center;">Settings</p> <p style="text-align: center;">Reset</p> <hr/> <div style="border: 1px dashed gray; padding: 5px; margin: 5px 0;"> <p style="text-align: center;">RS232- interface:</p> <p style="text-align: center;">Auto Bauderate</p> <p style="text-align: center;">On</p> <p style="text-align: center;">Auto Bauderate Off</p> </div> <p style="text-align: center;">Char Set</p> <p style="text-align: center;">IBM / DOS</p> <p style="text-align: center;">IBM / DOS Cyrillic</p> <p style="text-align: center;">IBM / DOS Japanese</p> <p style="text-align: center;">ANSI / WIN Latin 1</p> <p style="text-align: center;">ANSI / WIN Cyrillic</p> <p style="text-align: center;">ANSI / WIN Japanese</p> <p style="text-align: center;">Balance Feature</p> <p style="text-align: center;">Enable</p> <p style="text-align: center;">Balance Feature Disable</p> </div>	<p>De printer resetten</p> <p>Opslaan</p> <p>Opslaan</p> <p>Opslaan</p> <p>Opslaan</p> <p>Opslaan</p> <p>Opslaan</p> <p>Opslaan</p> <p>Opslaan</p> <p>Opslaan</p> <p>Opslaan</p>	<pre> Settings Reset ----- Reset done ----- Current settings: Baudrate: 9600 Bit/Parity: 8 Bit Non Handshake: Off Char Set: IBM/DOS Auto Bauderate: On -----STORED----- ... "current settings" Auto Bauderate: Off -----STORED----- ... "current settings" IBM/DOS -----STORED----- ... "current settings" IBM/DOS Cyrillic -----STORED----- ... "current settings" IBM/DOS Japanese -----STORED----- ... "current settings" ANSI/WIN Latin 1 -----STORED----- ... "current settings" ANSI/WIN Cyrillic -----STORED----- ... "current settings" ANSI/WIN Japanese -----STORED----- ... "current settings" Balance Feature: Enable -----STORED----- ... "current settings" Balance Feature: Disable -----STORED----- ... "current settings" </pre>
<div style="border: 1px solid black; padding: 5px;"> <p style="text-align: center;">Menuoptie</p> <p style="text-align: center;">Fabrieksinstelling</p> </div>		

4.2 Printer P26/P28

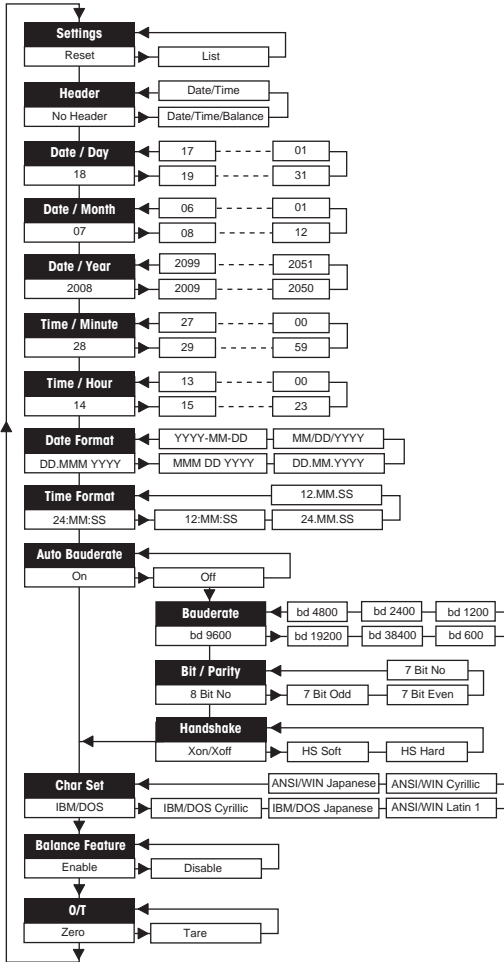

Gebruiksvoorbeelden van het balansdisplay:

Instellingen	
Reset	rESEt
List	L l5t
Koptekst	
*No Header	no Hdr
Date/Time	d t Hdr
Date/Time/Balance	dtb Hdr
Datum Dag**	
18	dAY 18
Datum Maand**	
07	Month 07
Datum Jaar**	
2008	YEAR 2008
Tijd Minuut**	
28	Min. 28
Tijd Uur**	
14	Hour 14
Datumindeling**	
DD.MMM YYYY	ddMMY
MMM DD YYYY	MMY dd
DD.MM.YYYY	ddMMY
MM/DD/YYYY	MM dd YY
YYYY-MM-DD	Y-MM-dd
Tijdsindeling***	
24:MM:SS	24:MM=SS
12:MM:SS	12:MM=SS
24.MM.SS	24MMSS
12.MM.SS	12MMSS
Baudsnelheid	
*9600	bd9600
19200	bd 19200
38400	bd38400
600	bd600
1200	bd 1200
2400	bd2400
4800	bd4800
Bit/pariteit	
*8 Bit No	8b-no
7 Bit Odd	7b-odd
7 Bit Even	7b-E
7 Bit No	7b-no
Handshake	
*Xon/Xoff	HS oFF
HS Soft	HS SoFt
HS Hard	HS HARd
Tekenset	
*IBM/DOS	d05
IBM/DOS Cyrillic	d05 C4r
IBM/DOS Japanese	d05 JAP
Ansi/Win Latin 1	11 in LARt
Ansi/Win Cyrillic	11 in C4r
Ansi/Win Japanese	11 in JAP
Tarreren/nulstelling	
*Zero	ZERo
Tare	tAR-E

Menuoptie
Fabrieksinstelling

- * Fabrieksinstellingen
- ** Instrumenten met ingebouwde klok: niet van toepassing; ingebouwde klok heeft voorrang
- *** Instrumenten met ingebouwde klok: indeling van printer heeft voorrang

De dag instellen, voorbeeld (alleen bij P26 / P28)

Het menu openen

- Houd de toets  ingedrukt totdat **Resetten** verschijnt.
- Selecteer de menuoptie **Dag** met de toets .
- Selecteer het nummer van de dag, bijvoorbeeld 21.
Schuif omhoog met de toets \uparrow .
Schuif omlaag met de toets \downarrow .

De instellingen opslaan



- Houd de toets  ingedrukt totdat **Opgeslagen** verschijnt.

Toepassing Statistieken (alleen bij P28)



Het monstergewicht moet binnen het bereik van 70% tot 130% van de huidige gemiddelde waarde liggen.

De verandering in het dynamische gewicht moet ten minste 100 d bedragen.

- 1 Druk op  om de toepassing Statistieken te starten (led AAN).
- 2 Voeg een nieuw monster toe en druk op **M+**.
- 3 Druk op  om het subtotaal af te drukken, indien nodig.
- 4 Houd  ingedrukt om een afdruk te maken en de toepassing Statistiek te beëindigen (led UIT).



Opmerking

- U mag de eenheid niet wijzigen terwijl u de toepassing gebruikt.
- U kunt ten hoogste 999 monsters wegen.

Toepassing Totaliseren (alleen bij P28)



Minimumgewichten + 1 d.

- 1 Druk op  om de toepassing Totaliseren te starten (led AAN).
- 2 Voeg een nieuw monster toe en druk op **M+**.
- 3 Druk op  om het subtotaal af te drukken, indien nodig.
- 4 Houd  ingedrukt om een afdruk te maken en de toepassing Totaliseren te beëindigen (led UIT).

Opmerking

- U mag de eenheid niet wijzigen terwijl u de toepassing gebruikt.
- U kunt ten hoogste 999 monsters wegen.

5 Onderhoud



WAARSCHUWING

Ernstig of dodelijk letsel door elektrische schok

Contact met onderdelen die onder stroom staan, kan ernstig of dodelijk letsel veroorzaken.

- 1 Koppel de printer los van de voedingsbron voordat u reinigings- en onderhoudswerkzaamheden uitvoert.
- 2 Voorkom dat er vloeistof in de printer of netadapter binnendringt.

5.1 De papierrol vervangen

Het plaatsen van een nieuwe papierrol wordt beschreven in het hoofdstuk [Papier plaatsen ▶ pagina 68]. Het bestelnummer van de papierrol vindt u in het hoofdstuk [Verbruiksartikelen ▶ pagina 76].

Opmerking

Vergeet niet de draaias uit de oude papierrol te verwijderen en deze in de nieuwe papierrol te plaatsen.

5.2 Het lint vervangen

Het bestelnummer van de lintcassette vindt u in het hoofdstuk [Verbruiksartikelen ► pagina 76].

- 1 Verwijder het deksel van het papiervak (1).
- 2 Trek het papier uit afdrukeenheid (2).



- 3 Verwijder de lintcartridge door in de richting van de pijl te drukken (3).
- 4 Plaats de nieuwe lintcartridge. Draai zo nodig aan het spanwiel om het lint te spannen (4).

Het plaatsen van een nieuwe papiertrol wordt beschreven in het hoofdstuk [Papier plaatsen ► pagina 68].



5.3 De behuizing reinigen

Aangezien de printerbehuizing is gemaakt van hoogwaardige, duurzame materialen, mogen alle in de handel verkrijgbare, milde reinigingsmiddelen worden gebruikt.



LET OP

Schade aan de printer door onjuiste reinigingsmethodes

De printerbehuizing is gemaakt van hoogwaardige, duurzame materialen en kan beschadigd raken bij gebruik van bepaalde reinigingsmiddelen, oplosmiddelen of schuurmiddelen. Vloeistof die in de behuizing terechtkomt, kan de printer beschadigen.

- 1 Gebruik water en een mild reinigingsmiddel om de printer te reinigen.
- 2 Veeg gemorste vloeistof onmiddellijk weg.
- 3 Voorkom dat er vloeistof in het binnenwerk van de printer terechtkomt.

Neem contact op met een METTLER TOLEDO vertegenwoordiger voor informatie over de beschikbare onderhoudsmogelijkheden. Met regelmatig onderhoud door een erkende onderhoudstechnicus bent u verzekerd van een consistente weegnauwkeurigheid op de lange termijn en een langere levensduur van het instrument.

6 Technische gegevens

6.1 Algemene technische gegevens

Voeding

Netadapter:	Primair: 100 – 240 V, 50/60 Hz Secundair: 12 V DC, 2,5 A (met elektronische overbelastingsbeveiliging)
Kabel voor netadapter:	3-draads, met landspecifieke stekker
Polariteit:	 met stroombegrensd SELV-uitgang (Safety Extra Low Voltage)
Voedingsspanning:	12 V DC
Stroomverbruik:	Max. 2,5 A

Bescherming en normen

Overspanningscategorie:	II
Verontreinigingsgraad:	2
Normen voor veiligheid en EMC:	Zie Conformiteitsverklaring
Toepassingsbereik:	Uitsluitend voor gebruik in gesloten binnenruimtes

Omgevingscondities

Hoogte boven gemiddeld zeeniveau:	Tot 4.000 m
Omgevingstemperatuur:	0 tot 40 °C
Opslagconditie:	-25 tot 60 °C
Relatieve luchtvochtigheid:	Max. 80% bij max. 31 °C, lineair afnemend tot 50% bij 40 °C, niet-condenserend

Printerkenmerken

Afdruktechnologie:	Dotmatrixprinter 5 x 7, 24 tekens per regel
Afdruksnelheid:	2,3 regels per seconde
Lintcartridge:	Verwisselbaar, zwart
Papierrol:	Standaardpapier 57,5 mm x ø 50 tot 60 mm, in behuizing geïntegreerd, commercieel formaat
Afdrukkwaliteit:	Lichtresistent en thermisch stabiel afdrukken (GLP, GMP, ISO 9001)
Interfaces:	RS-P25, RS-P26, RS-P28 USB-P25
Compatibiliteitslimieten:	RS232C USB <ul style="list-style-type: none">• Functie Datum/tijd: geldt niet voor balansen met ingebouwde klok (ingebouwde klok heeft voorrang)• Functie Nulstelling/tarreren: geldt niet voor alle balansmodellen

Afmetingen/gewicht

Printerafmetingen (B x D x H):	120 x 203 x 73 mm
Verpakkingsafmetingen (B x D x H):	255 x 205 x 150 mm
Nettogewicht:	740 g (papierrol inbegrepen)

7 Verbruiksartikelen

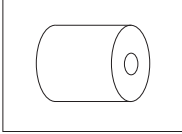
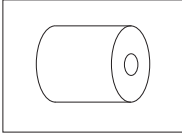
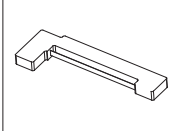
	Beschrijving	Onderdeelnr.
	Papierrol (lengte: 20 m), set van 5 stuks	00072456
	Papierrol (lengte: 13 m), zelfklevend, set van 3 stuks	11600388
	Lintcartridge, zwart, set van 2 stuks	00065975

1 Informacje dotyczące bezpieczeństwa

Dla tego urządzenia są dostępne dwa dokumenty: "Podręcznik użytkownika" i "Instrukcja obsługi".

- W podręczniku użytkownika przedstawiono sposób uruchomienia urządzenia.
- Instrukcja obsługi zawiera pełny opis urządzenia i jego użytkowania.
- Zachowaj oba dokumenty do wykorzystania w przyszłości.
- W przypadku przekazania urządzenia osobom trzecim należy dołączyć oba te dokumenty.

Drukarki należy używać zgodnie z Podręcznikiem użytkownika i Instrukcją obsługi. Użycie drukarki w sposób niezgodny z tymi dokumentami lub jego modyfikacje mogą spowodować obniżenie poziomu bezpieczeństwa urządzenia, za co firma Mettler-Toledo GmbH nie ponosi żadnej odpowiedzialności.

1.1 Inne ważne dokumenty



Niniejszy Podręcznik użytkownika jest krótką instrukcją, która dostarcza informacji niezbędnych do bezpiecznego i sprawnego wykonania pierwszych kroków w pracy z urządzeniem. Przed przystąpieniem do jakichkolwiek czynności należy uważnie zapoznać się z treścią podręcznika.

W celu uzyskania pełnych informacji należy zapoznać się z Podręcznikiem uzupełniającym.

► www.mt.com/printer-p-20-RM

1.2 Definicje słów ostrzegawczych i symboli ostrzegawczych

Uwagi dotyczące bezpieczeństwa zawierają ważne zagadnienia bezpieczeństwa. Ignorowanie uwag dotyczących bezpieczeństwa może być przyczyną obrażeń, uszkodzenia urządzenia, jego nieprawidłowego funkcjonowania i nieprawidłowych wyników. Uwagi dotyczące bezpieczeństwa są oznaczone specjalnymi wyrazami i symbolami ostrzegawczymi:

Wyrazy ostrzegawcze

- | | |
|--------------------|---|
| OSTRZEŻENIE | Sytuacje niebezpieczne o średnim poziomie zagrożenia, które mogą spowodować śmierć lub poważne uszkodzenia ciała, jeśli się im nie zapobiegnie. |
| PRZESTROGA | Sytuacje niebezpieczne o niskim poziomie zagrożenia powodujących niewielkie lub umiarkowane urazy, jeśli się im nie zapobiegnie. |
| NOTYFIKACJA | Sytuacje niebezpieczne o niskim poziomie zagrożenia powodujących uszkodzenie urządzenia, inne szkody majątkowe, nieprawidłowe działanie, zafalszowanie wyników lub utratę danych. |

Symbol ostrzegawczy



Porażenie prądem



Ogólne niebezpieczeństwo: aby uzyskać informacje na temat zagrożeń i związanych z nimi środków zapobiegawczych, należy się zapoznać z Instrukcją obsługi.



Uwaga

1.3 Uwagi dotyczące bezpieczeństwa szczególne dla danego produktu

Przeznaczenie

To urządzenie jest przeznaczone do użytku w laboratoriach przez wyszkolonych pracowników. Urządzenie to jest przeznaczone do wydruku protokołów.

Każde inne zastosowanie, jak również przekroczenie limitów określonych w charakterystyce technicznej bez pisemnej zgody firmy Mettler-Toledo GmbH zostanie uznane za niezgodne z przeznaczeniem.

Obowiązki właściciela urządzenia

Właściciel urządzenia jest osobą posiadającą tytuł prawny. Używa urządzenia lub upoważnia inne osoby do jego użycia. Jest to także osoba, która wg. prawa jest uważana za operatora tego urządzenia. Właściciel urządzenia jest odpowiedzialny za bezpieczeństwo wszystkich użytkowników urządzenia i osób trzecich.

METTLER TOLEDO Właściciel urządzenia wyszkolił użytkowników w taki sposób, aby bezpiecznie użytkowali urządzenie w ich miejscu pracy i potrafili sobie radzić z potencjalnymi zagrożeniami. METTLER TOLEDO Właściciel urządzenia zapewni niezbędne środki ochronne.

Uwagi dotyczące bezpieczeństwa



OSTRZEŻENIE

Ryzyko śmierci lub poważnych urazów w wyniku porażenia prądem

Kontakt z częściami pod napięciem może doprowadzić do urazów lub śmierci.

- 1 Używaj tylko zatwierdzonego kabla zasilającego METTLER TOLEDO oraz zasilacza AC/DC z wyjściem prądowym typu SELV.
- 2 Podłącz kabel zasilający do uziemionego gniazda elektrycznego, odpowiednio ustawiając bieguny.
- 3 Wszystkie przewody elektryczne i połączenia utrzymywać z dala od cieczy i wilgoci.
- 4 Sprawdzić przewody i wtyczkę zasilania pod kątem uszkodzeń; wymienić uszkodzone kable i wtyczki zasilania.



NOTYFIKACJA

Ryzyko uszkodzenia urządzenia z powodu użycia nieprawidłowych części

Użycie nieodpowiednich części może spowodować uszkodzenie lub nieprawidłowe działanie urządzenia.

- Używaj wyłącznie części firmy METTLER TOLEDO, które są przeznaczone do użycia z Twoim urządzeniem.

2 Instalacja i przygotowanie do eksploatacji

2.1 Dostarczone elementy

- Zasilacz AC/DC
- Przewód zasilający (odpowiedni dla danego kraju)
- Podręcznik użytkownika
- Deklaracja zgodności

2.2 Podłączenie drukarki do zasilania



! OSTRZEŻENIE

Ryzyko śmierci lub poważnych urazów w wyniku porażenia prądem

Kontakt z częściami pod napięciem może doprowadzić do urazów lub śmierci.

- 1 Używaj tylko zatwierzonego kabla zasilającego METTLER TOLEDO oraz zasilacza AC/DC z wyjściem prądowym typu SELV.
- 2 Podłącz kabel zasilający do uziemionego gniazda elektrycznego, odpowiednio ustawiając bieguny.
- 3 Wszystkie przewody elektryczne i połączenia utrzymywać z dala od cieczy i wilgoci.
- 4 Sprawdzić przewody i wtyczkę zasilania pod kątem uszkodzeń; wymienić uszkodzone kable i wtyczki zasilania.



NOTYFIKACJA

Ryzyko uszkodzenia zasilacza AC/DC z powodu przegrzania.

Jeśli zasilacz AC/DC jest przykryty lub znajduje się w pojemniku, nie ma odpowiedniego chłodzenia i się przegrzewa.

- 1 Nie wolno zakrywać zasilacza AC/DC.
- 2 Nie umieszczać zasilacza AC/DC w pojemniku.

Drukarka ta została wyposażona w uniwersalny zasilacz AC/DC lub w zasilacz AC/DC z przewodem zasilającym odpowiednim dla danego kraju.

- Kable należy poprowadzić w taki sposób, aby nie uległy uszkodzeniu ani nie zakłócały pracy urządzenia.
- Włóż wtyczkę przewodu zasilającego do łatwo dostępnego, uziemionego gniazda elektrycznego.

- 1 Należy podłączyć zasilacz AC/DC do wejścia znajdującego się z tyłu drukarki.
- 2 Przykręcić złącze nakrętką.
- 3 Należy podłączyć 3-szykowy przewód zasilający z uziemieniem do gniazda przeznaczonego na zasilacz AC.
- 4 Podłączyć drukarkę do wagi przy użyciu kabla interfejsu.
- 5 Włączyć wagę.
- 6 Podłączyć drukarkę do zasilania.
- 7 Włączyć drukarkę za pomocą przelącznika I/O.

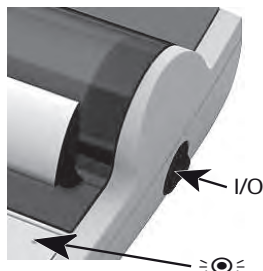

Notatka

Tylko interfejs RS232: dioda kontrolna będzie migotała do momentu podłączenia urządzenia. Jeżeli dioda miga nadal, sprawdź rozdział "Rozwiązywanie problemów" w Podręczniku uzupełniającym.

2.3 Wkładanie papieru

- 1 Zdejmij pokrywę papieru (pociągnij w tylnej części) (1).
- 2 Wsuń obrotową oś w rolkę papieru (2).
- 3 Przełóż papier przez otwór w jednostce drukującej w kierunku wskazanym przez strzałkę (3).
- 4 Naciśnij i przytrzymaj do momentu wprowadzenia odpowiedniej ilości papieru (4).
- 5 Przełóż papier przez otwór w pokrywie papieru.
- 6 Załóż pokrywę papieru (1).

Jeżeli po dokonaniu pierwszych wydruków zmianie ulegną ustawienia połączenia (prędkość transmisji, Bit, Handshake) wagi, należy ponownie uruchomić drukarkę. Wyłącz / włącz w celu ponownego uruchomienia i automatycznego wykrycia prędkości transmisji. Automatyczne wykrywanie prędkości transmisji można wyłączyć.

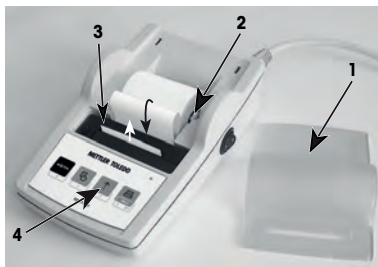

3 Funkcje przycisków

















Drukarka P25

Poziom obsługi	Krótkie wciśnięcie	Wciśnięcie i przytrzymanie
	nowy wiersz	ciągłe podawanie (do czasu zwolnienia)
 + 	Test drukarki z wydrukiem ustawień	otwórz menu
Poziom menu	Krótkie wciśnięcie	Wciśnięcie i przytrzymanie
	kolejna opcja menu	zapisz

Drukarka P26

Poziom obsługi	Krótkie wciśnięcie	Wciśnięcie i przytrzymanie
	zerowanie / tarowanie wagi	–
	wydruk daty i godziny	–
	nowy wiersz	ciągłe podawanie (do czasu zwolnienia)
	drukuj	otwórz menu
Poziom menu	Krótkie wciśnięcie	Wciśnięcie i przytrzymanie
 zamknij	 w dół	 w górę
	następna	zapisz

Drukarka P28

Poziom obsługa	 Krótkie wciśnięcie	 Wciśnięcie i przytrzymanie
	zerowanie / tarowanie wagi	–
	wydruk daty i godziny	–
	nowy wiersz	ciągłe podawanie (do czasu zwolnienia)
	drukuj	otwórz menu
Poziom menu	 Krótkie wciśnięcie	 Wciśnięcie i przytrzymanie
 zamknij  w dół  w górę  następna	 zapisz	
Poziom funkcji	 Krótkie wciśnięcie	 Wciśnięcie i przytrzymanie
	Uruchom program sumowania	Zamknij program sumowania
	Uruchom program statystyki	Zamknij program statystyki

4 Menu

4.1 Drukarka P25

☞ Krótkie wciśnięcie	☞ Wciśnięcie i przytrzymanie	Wydruk
<div style="border: 1px solid black; padding: 2px; text-align: center;">Settings</div> <div style="border: 1px solid black; padding: 2px; text-align: center;">Reset</div>		Settings Reset
<div style="border: 1px solid black; padding: 2px; text-align: center;">Reset drukarki</div>		<pre> ----- Reset done ----- Current settings: Baudrate: 9600 Bit/Parity: 8 Bit Non Handshake: Off Char Set: IBM/DOS </pre>
<div style="border: 1px dashed gray; padding: 2px; text-align: center;">Tylko interfejs RS232</div> <div style="border: 1px solid black; padding: 2px; text-align: center;">Auto Bauderate</div> <div style="border: 1px solid black; padding: 2px; text-align: center;">On</div>	Zapisz	<pre> Auto Bauderate: On -----STORED----- ... "current settings" </pre>
<div style="border: 1px solid black; padding: 2px; text-align: center;">Auto Bauderate</div> <div style="border: 1px solid black; padding: 2px; text-align: center;">Off</div>	Zapisz	<pre> Auto Bauderate: Off -----STORED----- ... "current settings" </pre>
<div style="border: 1px solid black; padding: 2px; text-align: center;">Char Set</div> <div style="border: 1px solid black; padding: 2px; text-align: center;">IBM / DOS</div>	Zapisz	<pre> IBM/DOS -----STORED----- ... "current settings" </pre>
<div style="border: 1px solid black; padding: 2px; text-align: center;">IBM / DOS</div> <div style="border: 1px solid black; padding: 2px; text-align: center;">Cyrillic</div>	Zapisz	<pre> IBM/DOS Cyrillic -----STORED----- ... "current settings" </pre>
<div style="border: 1px solid black; padding: 2px; text-align: center;">IBM / DOS</div> <div style="border: 1px solid black; padding: 2px; text-align: center;">Japanese</div>	Zapisz	<pre> IBM/DOS Japanese -----STORED----- ... "current settings" </pre>
<div style="border: 1px solid black; padding: 2px; text-align: center;">ANSI / WIN</div> <div style="border: 1px solid black; padding: 2px; text-align: center;">Latin 1</div>	Zapisz	<pre> ANSI/WIN Latin 1 -----STORED----- ... "current settings" </pre>
<div style="border: 1px solid black; padding: 2px; text-align: center;">ANSI / WIN</div> <div style="border: 1px solid black; padding: 2px; text-align: center;">Cyrillic</div>	Zapisz	<pre> ANSI/WIN Cyrillic -----STORED----- ... "current settings" </pre>
<div style="border: 1px solid black; padding: 2px; text-align: center;">ANSI / WIN</div> <div style="border: 1px solid black; padding: 2px; text-align: center;">Japanese</div>	Zapisz	<pre> ANSI/WIN Japanese -----STORED----- ... "current settings" </pre>
<div style="border: 1px solid black; padding: 2px; text-align: center;">Balance Feature</div> <div style="border: 1px solid black; padding: 2px; text-align: center;">Enable</div>	Zapisz	<pre> Balance Feature: Enable -----STORED----- ... "current settings" </pre>
<div style="border: 1px solid black; padding: 2px; text-align: center;">Balance Feature</div> <div style="border: 1px solid black; padding: 2px; text-align: center;">Disable</div>	Zapisz	<pre> Balance Feature: Disable -----STORED----- ... "current settings" </pre>
<div style="border: 1px solid black; padding: 2px; text-align: center;">Opcja menu</div> <div style="border: 1px solid black; padding: 2px; text-align: center;">Ustawienie fabryczne</div>		

4.2 Drukarka P26 / P28

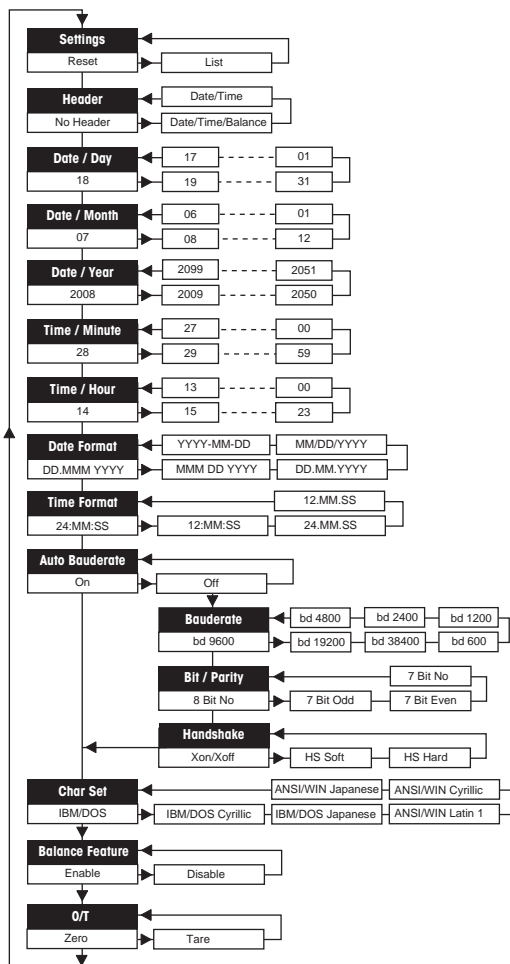

Przykłady stosowania wyświetlacza wagi:



Ustawienia	Reset	rESEt
	List	L 15t
Nagłówek	*No Header	no Hdr
	Date/Time	d t Hdr
	Date/Time/Balance	d t b Hdr
Data Dzień**	18	dAY 18
Data Miesiąc**	07	month 07
Data Rok**	2008	YEAR 2008
Czas Minuty**	28	n in. 28
Czas Godzina**	14	hour 14
Format daty***	DD.MMM.YYYY	ddmmY
	MMM DD.YYYY	mm dd Y
	DD.MM.YYYY	ddmmY
	MM/DD/YYYY	mm dd Y
	YYYY-MM-DD	Y-mm-dd
Format czasu***	24:MM:SS	24:mm:ss
	12:MM:SS	12:mm:ss
	24.MM.SS	24mmSS
	12.MM.SS	12mmSS
Szybkość transmisji	*9600	bd9600
	19200	bd 19200
	38400	bd38400
	600	bd600
	1200	bd 1200
	2400	bd2400
	4800	bd4800
Bity/Parzystość	*8 Bit No	8b-no
	7 Bit Odd	7b-odd
	7 Bit Even	7b-E
	7 Bit No	7b-no
Handshake	*Xon/Xoff	HS oFF
	HS Soft	HS SoFt
	HS Hard	HS HARd
Zestaw znaków	*IBM/DOS	d05
	IBM/DOS Cyrillic	d05 C4r
	IBM/DOS Japanese	d05 JAP
	Ansi/Win Latin 1	11 in LAt
	Ansi/Win Cyrillic	11 in C4r
	Ansi/Win Japanese	11 in JAP
Tara/Zero	*Zero	ZEr-o
	Tare	tAR-E

Opcja menu
Ustawienie fabryczne

- * ustawienia fabryczne
- ** urządzenia z wbudowanym zegarem: nie dotyczy, wbudowany zegar ma priorytet
- *** urządzenia z wbudowanym zegarem: priorytet ma format drukarki

Przykład ustawienia dnia (tylko P26 / P 28)

Otwórz menu

- Przytrzymaj klawisz  aż pojawi się **Reset**.
- Wybierz opcję menu **Day** za pomocą klawisza .
- Wybierz dzień, np. dzień 21.
Przewiń w górę za pomocą klawisza \uparrow .
Przewiń w dół za pomocą klawisza \downarrow .

Zapisz ustawienia



- Przytrzymaj klawisz  aż pojawi się **Stored**.

Program statystyki (tylko P28)



Masa próbki musi być w zakresie 70% - 130% bieżącej wartości średniej.

Minimalna dynamiczna zmiana masy musi wynosić 100 d.

- 1 Naciśnij , aby uruchomić program statystyczny (dioda LED wł.).
- 2 Dodaj nową próbkę i wciśnij **M+**.
- 3 W razie potrzeby wciśnij  w celu wydrukowania sumy częściowej.
- 4 Naciśnij i przytrzymaj  w celu wydrukowania i wyłączenia programu statystycznego (dioda LED wyl.).





Notatka

- Zmiana jednostek podczas działania programu nie jest dozwolona.
- Maksymalnie 999 próbek.

Program sumowania (tylko P28)



Minimalna naważka + 1 d.

- 1 Naciśnij , aby uruchomić program sumowania (dioda LED wł.).
- 2 Dodaj nową próbkę i wciśnij **M+**.
- 3 W razie potrzeby wciśnij  w celu wydrukowania sumy częściowej.
- 4 Naciśnij i przytrzymaj  w celu wydrukowania i wyłączenia programu sumowania (dioda LED wyl.).



Notatka

- Zmiana jednostek podczas działania programu nie jest dozwolona.
- Maksymalnie 999 próbek.

5 Konserwacja



OSTRZEŻENIE

Ryzyko śmierci lub poważnych urazów w wyniku porażenia prądem

Kontakt z częściami pod napięciem może doprowadzić do urazów lub śmierci.

- 1 Przed czyszczeniem i konserwacją należy odłączyć drukarkę od źródła zasilania.
- 2 Zapobiegać przedostawaniu się cieczy do drukarki lub zasilacza AC/DC.

5.1 Wymiana rolki papieru

Procedura zakładania nowej rolki papieru została opisana w rozdziale [Wkładanie papieru ▶ strona 80]. Numer katalogowy rolki papieru można znaleźć w rozdziale [Materiały eksploatacyjne ▶ strona 88].



Notatka

Oś obrotowa papieru musi zostać zawsze przełożona ze starej rolki papieru do nowej.

5.2 Wymiana taśmy

Numer katalogowy kasety z taśmą można znaleźć w rozdziale [Materiały eksploatacyjne ▶ strona 88].

- 1 Zdejmij pokrywkę papieru (1).
- 2 Wyciągnij papier z jednostki drukującej (2).



- 3 Wymij kasety z taśmą, naciskając w kierunku wskazanym przez strzałkę (3).
- 4 Włóż nową kasety z taśmą. W razie potrzeby usuń luz przy pomocy koła napinającego (4)

Procedura zakładania nowej rolki papieru została opisana w rozdziale [Wkładanie papieru ▶ strona 80].



5.3 Czyszczenie obudowy

Ponieważ obudowa drukarki jest wykonana z najwyższej jakości odpornych materiałów, można używać wszelkich powszechnie dostępnych łagodnych środków czyszczących.



NOTYFIKACJA

Uszkodzenie drukarki z powodu zastosowania nieprawidłowych metod czyszczenia

Obudowa drukarki jest wykonana z wysokiej jakości, odpornych materiałów i można ją uszkodzić pewnymi środkami czyszczącymi, rozpuszczalnikami lub materiałami trącymi. Jeśli ciecz przedostanie się do obudowy, może uszkodzić drukarkę.

- 1 Do czyszczenia drukarki należy używać wyłącznie łagodnych detergentów.
- 2 Rozlaną ciecz należy usuwać natychmiast.
- 3 Do wnętrza drukarki nie może przedostać się żadna ciecz.

Aby poznać METTLER TOLEDO aktualną ofertę serwisową, prosimy o kontakt z przedstawicielem — regularna konserwacja przez autoryzowanego pracownika serwisu zapewni niezmienną precyzję ważenia i wydłuży żywotność użytkową tego urządzenia.

6 Dane techniczne

6.1 Ogólne dane techniczne

Zasilanie

Zasilacz AC/DC	Pierwotne: 100-240 V, 50/60 Hz Wtórne: 12 V DC, 2,5 A (z elektronicznym zabezpieczeniem przed przeciążeniem)
Przewód do zasilacza AC/DC:	3-żyłowy z wtyczką specyficzną dla kraju odbiorcy
Polaryzacja:	 z ograniczeniem prądu na wyjściu SELV (Safety Extra Low Voltage)
Napięcie sieci energetycznej:	12 V DC
Pobór mocy:	Maks. 2,5 A

Zabezpieczenia i standardy

Kategoria przepięciowa:	II
Stopień zanieczyszczenia:	2
Standardy bezpieczeństwa i EMC:	Patrz Deklaracja zgodności
Obszar zastosowania:	Do używania tylko w zamkniętych pomieszczeniach

Warunki otoczenia

Wysokość nad poziomem morza:	Do 4000 m
Temperatura otoczenia:	od 0 do +40°C
Warunki przechowywania:	od -25 do +60°C
Względna wilgotność powietrza:	Maks. 80% przy maks. temp. 31°C, liniowe obniżanie do 50% przy 40°C, bez skraplania

Funkcje drukarki

Technologia drukowania:	Drukarka z matrycą punktową 5 x 7, linia o długości 24 znaków
Prędkość drukowania:	2,3 linii na sekundę
Kaseła z taśmą:	Wymienna, czarna
Rolka papieru:	Standardowy papier 57,5 mm x ø od 50 do 60 mm, zintegrowany w obudowie, rozmiar handlowy
Jakość druku:	Druk odporny na światło i termicznie stabilny (GLP, GMP, ISO 9001)
Złącza:	RS-P25, RS-P26, RS-P28, RS232C USB-P25, USB
Limity kompatybilności:	<ul style="list-style-type: none">Funkcja daty / czasu: nie dotyczy wag z wbudowanym zegarem (wbudowany zegar ma priorytet)Funkcja zerowania / tarowania: nie dotyczy wszystkich modeli wag

Wymiary / Masa

Wymiary drukarki (S x G x W):	120 x 203 x 73 mm
Wymiary opakowania (S x G x W):	255 x 205 x 150 mm
Masa netto:	740 g (z rolką papieru)

7 Materiały eksploatacyjne

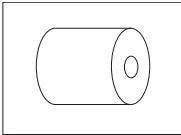
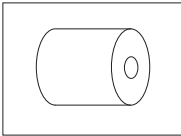
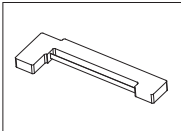
Opis	Nr części	
 A line drawing of a roll of paper, showing the cylindrical shape and the circular end face with a central hole.	Papier w rolce (długość 20 m), zestaw 5 szt.	00072456
 A line drawing of a roll of paper, showing the cylindrical shape and the circular end face with a central hole.	Papier w rolce (długość: 13 m), samoprzylepny, zestaw 3 szt.	11600388
 A line drawing of a black ink cartridge, showing its L-shaped profile and the ink reservoir.	Kaseła z czarną taśmą, zestaw 2 szt.	00065975

1 Informações de Segurança

Para este instrumento, há dois documentos disponíveis: "Manual do Usuário" e "Manual de Operação".

- O Manual do Usuário mostra como começar a usar o instrumento.
- O Manual de Operação contém uma descrição completa do instrumento e seu uso.
- Guarde os dois documentos para referência futura.
- Inclua os dois documentos se você for passar o instrumento para terceiros.

Use apenas o instrumento de acordo com o Manual do Usuário e o Manual de Operação. Se o instrumento não for usado de acordo com esses documentos ou caso seja modificado, a segurança do instrumento poderá ser prejudicada e a Mettler-Toledo GmbH não se responsabiliza.

1.1 Demais documentos aplicáveis



Este Manual do Usuário é uma instrução breve que fornece informações para lidar com as primeiras etapas do instrumento, de forma segura e eficiente. O usuário deve ter lido e entendido cuidadosamente este manual antes de realizar quaisquer tarefas.

Para informações completas, consulte sempre o Manual de Referência (RM).

► www.mt.com/printer-p-20-RM

1.2 Definições de palavras de sinalização e símbolos de advertência

As observações de segurança contêm informações importantes sobre questões de segurança. Ignorar as observações de segurança poderá resultar em lesões pessoais, danos ao instrumento, mau funcionamento e resultados falsos. As observações de segurança são marcadas com as palavras de sinalização e os símbolos de advertência.

Palavras de sinalização

- ATENÇÃO** Uma situação perigosa de risco médio, possivelmente resultando em morte ou lesões graves se não for evitada.
- CAUIDADO** Uma situação perigosa de baixo risco, resultando em lesões leves ou médias se não for evitada.
- AVISO** Uma situação perigosa com baixo risco, resultando em danos ao instrumento, outros danos materiais, defeitos e resultados errados ou perda de dados.

Símbolos de advertência



Choque elétrico



Perigo geral: leia o Manual de Instruções para obter informações sobre os riscos e as medidas consequentes.



Aviso

1.3 Observações de segurança específicas do produto

Uso pretendido

Este instrumento foi projetado para ser usado em laboratórios por pessoal treinado. O instrumento é destinado para fins de protocolo de impressão.

Qualquer outro tipo de uso e operação além dos limites das especificações técnicas, sem o consentimento por escrito da Mettler-Toledo GmbH é considerado não destinado ao uso.

Responsabilidades do proprietário do instrumento

O proprietário do instrumento é a pessoa que detém o título legal do instrumento e que utiliza o instrumento ou autoriza qualquer pessoa a usá-lo, ou a pessoa que é considerada pela lei como o operador do instrumento. O proprietário do instrumento é responsável pela segurança de todos os usuários do instrumento e de terceiros.

METTLER TOLEDO assume que o proprietário do instrumento oferece treinamento aos usuários quanto ao uso seguro do instrumento no local de trabalho e lida com potenciais perigos. METTLER TOLEDO assume que o proprietário do instrumento fornece os equipamentos de proteção necessários.

Avisos de segurança



ATENÇÃO

Morte ou lesões graves devido a choques elétricos

O contato com peças que contêm corrente ativa pode resultar em ferimentos ou morte.

- 1 Use somente um cabo aprovado METTLER TOLEDO para fonte de alimentação e um adaptador CA/CC com uma saída SELV de corrente limitada.
- 2 Conecte o cabo de força a uma tomada aterrada, certifique-se de que a polaridade seja correta.
- 3 Mantenha todos os cabos e conexões elétricas afastados de líquidos e umidade.
- 4 Verifique se os cabos e a tomada estão danificados e substitua os cabos e tomada danificados.



AVISO

Danos ao instrumento devido ao uso de peças inadequadas

O uso de peças inadequadas com o instrumento pode danificá-lo ou fazer com que ele apresente defeitos.

- Use somente peças da METTLER TOLEDO que sejam destinadas a serem utilizadas com seu instrumento.

2 Instalação e colocação em operação

2.1 Escopo da entrega

- Adaptador CA/CC
- Cabo de alimentação (específico do país)
- Manual do usuário
- Declarações de conformidade

2.2 Conectando a impressora à fonte de alimentação



ATENÇÃO

Morte ou lesões graves devido a choques elétricos

O contato com peças que contêm corrente ativa pode resultar em ferimentos ou morte.

- 1 Use somente um cabo aprovado METTLER TOLEDO para fonte de alimentação e um adaptador CA/CC com uma saída SELV de corrente limitada.
- 2 Conecte o cabo de força a uma tomada aterrada, certifique-se de que a polaridade seja correta.
- 3 Mantenha todos os cabos e conexões elétricas afastados de líquidos e umidade.
- 4 Verifique se os cabos e a tomada estão danificados e substitua os cabos e tomada danificados.



AVISO

Danos ao adaptador CA/CC devido ao superaquecimento

Se o adaptador CA/CC for coberto ou colocado em um recipiente, não será suficientemente resfriado e irá superaquecer.

- 1 Não cubra o adaptador CA/CC.
- 2 Não coloque o adaptador CA/CC em um recipiente.

A impressora é fornecida com um adaptador CA/CC universal ou um adaptador CA/CC com um cabo de alimentação específico do país.

- Instale os cabos de forma que não sejam danificados ou não possam interferir na operação.
- Insira o cabo de força em uma tomada aterrada que seja facilmente acessível.

- 1 Conecte o adaptador CA/CC ao soquete de conexão na parte de trás da impressora.
- 2 Trave o conector com a porca do parafuso.
- 3 Conecte o cabo de energia com aterramento de 3 pinos ao soquete para o adaptador CA/CC.
- 4 Conecte a impressora e a balança com o cabo de interface.
- 5 Ligue a balança.
- 6 Conecte a impressora à fonte de alimentação.



7 Ligue a impressora com o interruptor I/O.

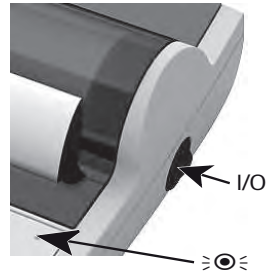

Nota

Somente Interface RS232: a lâmpada piloto piscará até um instrumento ser conectado. Se a lâmpada continuar piscando, consulte o capítulo "Resolução de problemas" no Manual de Referência.

2.3 Inserção de papel



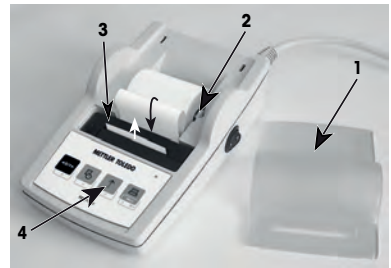





- 1 Remova a tampa do papel (puxe pela parte de trás) (1).
- 2 Insira o eixo rotativo do papel no centro do rolo de papel (2).
- 3 Alimente o papel através da abertura na unidade de impressão, no sentido da seta (3).
- 4 Pressione e segure até que haja alimentação suficiente de papel (4).
- 5 Conduza o papel pela abertura da tampa do papel.
- 6 Coloque a tampa do papel (1).















Se, após as primeiras impressões, as configurações de conexão (velocidade de transmissão, Bit, Handshake) da balança mudarem, a impressora deverá ser reiniciada. Desligue/ligue para iniciar novamente a detecção automática da velocidade de transmissão. A determinação automática da taxa de transmissão de dados pode ser desligada.

3 Funções das teclas

















Impressora P25

Nível de operação	 Pressionar brevemente	 Manter pressionada
	alimentação de uma linha	alimentação contínua (até liberar)
 	Teste da impressora com configuração de impressão	abrir o menu
Nível do menu	 Pressionar brevemente	 Manter pressionada
	próximo item de menu	armazenar

Impressora P26



Nível de operação	 Pressionar brevemente	 Manter pressionada		
	zerar / tarar a balança	—		
	imprimir Data e Hora	—		
	alimentação de uma linha	alimentação contínua (até liberar)		
	imprimir	abrir o menu		
Nível do menu	 Pressionar brevemente	 Manter pressionada		
 sair	 para baixo	 para cima	 próximo	 armazenar

Impressora P28

Nível de operação	 Pressionar brevemente	 Manter pressionada
	zerar / tarar a balança	—
	imprimir Data e Hora	—
	alimentação de uma linha	alimentação contínua (até liberar)
	imprimir	abrir o menu
Nível do menu	 Pressionar brevemente	 Manter pressionada
 sair	 para baixo  para cima  próximo	 armazenar
Nível da função	 Pressionar brevemente	 Manter pressionada
	Iniciar aplicação de totalização	Concluir aplicação de totalização
	Iniciar aplicação de estatística	Concluir aplicação de estatística

4 Menu

4.1 Impressora P25

 Pressionar brevemente	 Manter pressionada	Impressão
<div style="border: 1px solid black; padding: 2px; text-align: center;">Settings</div> <div style="border: 1px solid black; padding: 2px; text-align: center;">Reset</div>		Settings Reset
	Reiniciar a impressora	<pre> ----- Reset done ----- Current settings: Baudrate: 9600 Bit/Parity: 8 Bit Non Handshake: Off Char Set: IBM/DOS </pre>
<div style="border: 1px solid black; padding: 2px; text-align: center;">Somente Interface RS232</div>		
<div style="border: 1px solid black; padding: 2px; text-align: center;">Auto Bauderate</div> <div style="border: 1px solid black; padding: 2px; text-align: center;">On</div>	Armazenar	<pre> Auto Bauderate: On -----STORED----- ..."current settings" </pre>
<div style="border: 1px solid black; padding: 2px; text-align: center;">Auto Bauderate</div> <div style="border: 1px solid black; padding: 2px; text-align: center;">Off</div>	Armazenar	<pre> Auto Bauderate: Off -----STORED----- ..."current settings" </pre>
<div style="border: 1px solid black; padding: 2px; text-align: center;">Char Set</div> <div style="border: 1px solid black; padding: 2px; text-align: center;">IBM / DOS</div>	Armazenar	<pre> IBM/DOS -----STORED----- ..."current settings" </pre>
<div style="border: 1px solid black; padding: 2px; text-align: center;">IBM / DOS Cyrillic</div>	Armazenar	<pre> IBM/DOS Cyrillic -----STORED----- ..."current settings" </pre>
<div style="border: 1px solid black; padding: 2px; text-align: center;">IBM / DOS Japanese</div>	Armazenar	<pre> IBM/DOS Japanese -----STORED----- ..."current settings" </pre>
<div style="border: 1px solid black; padding: 2px; text-align: center;">ANSI / WIN Latin 1</div>	Armazenar	<pre> ANSI/WIN Latin 1 -----STORED----- ..."current settings" </pre>
<div style="border: 1px solid black; padding: 2px; text-align: center;">ANSI / WIN Cyrillic</div>	Armazenar	<pre> ANSI/WIN Cyrillic -----STORED----- ..."current settings" </pre>
<div style="border: 1px solid black; padding: 2px; text-align: center;">ANSI / WIN Japanese</div>	Armazenar	<pre> ANSI/WIN Japanese -----STORED----- ..."current settings" </pre>
<div style="border: 1px solid black; padding: 2px; text-align: center;">Balance Feature</div> <div style="border: 1px solid black; padding: 2px; text-align: center;">Enable</div>	Armazenar	<pre> Balance Feature: Enable -----STORED----- ..."current settings" </pre>
<div style="border: 1px solid black; padding: 2px; text-align: center;">Balance Feature</div> <div style="border: 1px solid black; padding: 2px; text-align: center;">Disable</div>	Armazenar	<pre> Balance Feature: Disable -----STORED----- ..."current settings" </pre>
<div style="border: 1px solid black; padding: 2px; text-align: center;">Opção do menu</div> <div style="border: 1px solid black; padding: 2px; text-align: center;">Configuração de fábrica</div>		

4.2 Impressora P26 / P28

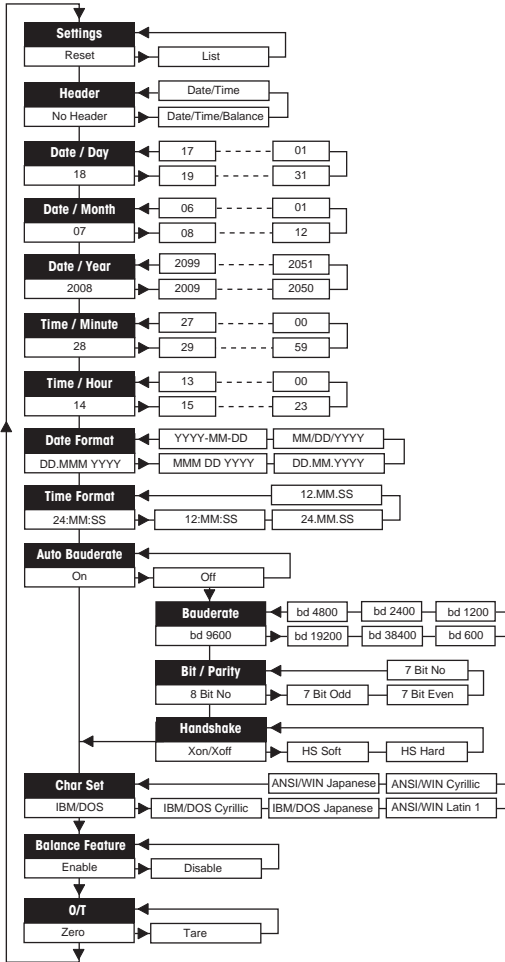

Exemplos ao usar-se o display da balança:



Configurações	
Resel	rESEt
List	L 15t
Cabeçalho	
*No Header	no Hdr
Date/Time	d t Hdr
Date/Time/Balance	dtb Hdr
Data Dia**	
18	dAY 18
Data Mês**	
07	month 07
Data Ano**	
2008	YEAR 2008
Horário Minuto**	
28	min. 28
Horário Hora**	
14	Hour 14
Formato da data***	
DD.MMM.YYYY	ddmmY
MMM DD.YYYY	mm dd Y
DD.MM.YYYY	ddmmY
MM/DD/YYYY	mm dd Y
YYYY-MM-DD	Y-mm-dd
Formato de hora***	
24.MM.SS	24:mm:ss
12.MM.SS	12:mm:ss
24.MM.SS	24mmss
12.MM.SS	12mmss
Velocidade de transmissão	
*9600	bd9600
19200	bd 19200
38400	bd38400
600	bd600
1200	bd 1200
2400	bd2400
4800	bd4800
Bit/Paridade	
*8 Bit No	8b-no
7 Bit Odd	7b-odd
7 Bit Even	7b-E
7 Bit No	7b-no
Handshake	
*Xon/Xoff	HS oFF
HS Soft	HS SoFt
HS Hard	HS HARd
Conjunto de caracteres	
*IBM/DOS	d05
IBM/DOS Cyrillic	d05 C4r
IBM/DOS Japanese	d05 JAP
Ansi/Win Latin 1	11 in LAt
Ansi/Win Cyrillic	11 in C4r
Ansi/Win Japanese	11 in JAP
Tarar/Zerar	
*Zero	ZEr-o
Tare	tAR-E

Opção do menu
Configuração de fábrica

- * configurações de fábrica
- ** instrumentos com relógio incorporado: não aplicável, o relógio incorporado tem prioridade
- *** instrumentos com relógio incorporado: o formato da impressora tem prioridade

Exemplo para a configuração do dia (somente P26/P28)

Abrir o menu

- Mantenha pressionada a tecla  até exibir-se **Redefinir**.
- Selecione a opção do menu **Dia** com a tecla .
- Selecione o dia; por exemplo, dia 21.
Role para cima com a tecla \uparrow .
Role para baixo com a tecla \downarrow .

Salvar as configurações



- Mantenha pressionada a tecla  até exibir-se **Armazenado**.

Aplicação de estatística (somente P28)



O peso de amostra deverá estar na faixa de 70% a 130% do valor médio atual.

O peso dinâmico mínimo alterado deverá ser 100 d.

- 1 Pressione  para iniciar a aplicação Estatística (LED aceso).
- 2 Adicione uma nova amostra e pressione **M+**.
- 3 Pressione  para imprimir o subtotal, se necessário.
- 4 Mantenha a tecla  pressionada para imprimir e encerrar a aplicação Estatística (LED apagado).





Nota

- Não serão permitidas alterações de unidade durante a aplicação.
- Máximo de 999 amostras.

Aplicação de totalização (somente P28)



Pesos mínimos + 1 d.

- 1 Pressione  para iniciar a aplicação Totalização (LED aceso).
- 2 Adicione uma nova amostra e pressione **M+**.
- 3 Pressione  para imprimir o subtotal, se necessário.
- 4 Mantenha a tecla  pressionada para imprimir e encerrar a aplicação Totalização (LED apagado).



Nota

- Não serão permitidas alterações de unidade durante a aplicação.
- Máximo de 999 amostras.

5 Manutenção



⚠ ATENÇÃO

Morte ou lesões graves devido a choques elétricos

O contato com peças que contêm corrente ativa pode resultar em lesões e morte.

- 1 Desconecte a impressora da fonte de alimentação antes de fazer a limpeza e a manutenção.
- 2 Evite a entrada de líquidos na impressora ou no adaptador CA/CC.

5.1 Substituição do rolo de papel

A inserção do novo rolo de papel é descrita no capítulo [Inserção de papel ▶ página 92]. O número de pedido de rolo de papel pode ser encontrado no capítulo [Consumíveis ▶ página 100].



Nota

O eixo rotativo do papel deve sempre ser transferido do rolo de papel antigo para o novo.

5.2 Substituição da fita

O número de pedido do cartucho de fita pode ser encontrado no capítulo [Consumíveis ▶ página 100].

- 1 Remova a tampa do papel (1).
- 2 Puxe o papel para fora da unidade de impressão (2).



- 3 Remova o cartucho de fita, pressionando no sentido da seta (3).
- 4 Insira o novo cartucho de fita. Se necessário, retire a folga com a roda de tensionamento (4).

A inserção de um novo rolo de papel é descrita no capítulo [Inserção de papel ▶ página 92].



5.3 Limpeza da carcaça da impressora

Como o gabinete da impressora é feito de materiais resistentes de alta qualidade, todos os agentes de limpeza suaves disponíveis no mercado podem ser utilizados.



AVISO

Danos à impressora devido a métodos de limpeza inadequados

O gabinete da impressora é feito de materiais resistentes e de alta qualidade que podem ser danificados por certos agentes de limpeza, solventes ou abrasivos. Qualquer líquido que entrar em contato com o gabinete pode danificar a impressora.

- 1 Use somente água e detergente neutro para limpar a impressora.
- 2 Limpe quaisquer derramamentos imediatamente.
- 3 Evite a entrada de líquido no interior da impressora.

Entre em contato com um METTLER TOLEDO representante para informar-se sobre as opções de manutenção disponíveis – a manutenção regular por um engenheiro de serviço autorizado garantirá a exatidão de pesagem em longo prazo e prolongará a vida útil do instrumento.

6 Dados técnicos

6.1 Dados técnicos gerais

Fonte de alimentação

Adaptador CA/CC:	Primário: 100–240 V, 50/60 Hz Secundário: 12 V CC, 2,5 A (com proteção eletrônica contra sobrecargas)
Cabo para o adaptador CA/CC:	3 pinos, com plugue específico do país
Polaridade:	 com saída em tensão extra-baixa (EBT) limitada em corrente
Tensão da linha de força:	12 V CC
Consumo de energia:	Máx. 2,5 A

Proteção e padrões

Categoria de sobretensão:	II
Grau de poluição:	2
Segurança e EMC:	Consulte as Declarações de Conformidade
Faixa de aplicação:	Somente para utilização em ambientes internos fechados

Condições ambientais

Altitude acima do nível médio do mar:	Até 4.000 m
Temperatura ambiente:	0 a 40 °C
Condição de armazenamento:	-25 a 60 °C
Umidade relativa do ar:	Máx. de 80% até 31 °C, diminuindo linearmente para 50% a 40 °C, sem condensação

Recursos da impressora

Tecnologia de impressão:	Impressora matricial 5 × 7, comprimento de linha de 24 caracteres
Velocidade de impressão:	2,3 linhas por segundo
Cartucho de fita:	Substituível, preto
Roletagem de papel:	Papel padrão 57,5 mm × ø 50 a 60 mm, integrado ao gabinete, tamanho comercial
Qualidade de impressão:	Resistente à luz e impressão termicamente estável (BPL, GMP, ISO 9001)
Interfaces:	RS-P25, RS-P26, RS-P28, USB-P25
Limites de compatibilidade:	USB <ul style="list-style-type: none">• Função Data / Hora: não aplicável em balanças com relógio incorporado (o relógio incorporado tem prioridade)• Função Zerar / Tarar: não aplicável em todos os modelos de balanças

Dimensão / peso

Dimensões da impressora (L × P × A):	120 × 203 × 73 mm
--------------------------------------	-------------------

Dimensões da embalagem (L x P x A): 255 x 205 x 150 mm
Peso líquido: 740 g (incluindo rolo de papel)

7 Consumíveis

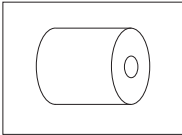
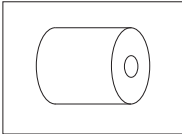
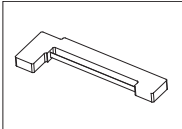
	Descrição	Código nº
	Rolo de papel (comprimento: 20 m), conjunto de 5 peças	00072456
	Rolo de papel, autoadesivo (comprimento: 13 m), conjunto de 3 peças	11600388
	Cartucho de fita, preto, conjunto de 2 peças	00065975

1 Informații privind siguranța

Pentru acest instrument sunt disponibile două documente: „Manual de operare” și „Instrucțiuni de utilizare”.

- Manualul de operare vă arată cum să utilizați instrumentul.
- Instrucțiunile de utilizare descriu în detaliu instrumentul și utilizarea acestuia.
- Păstrați ambele documente pentru consultare ulterioară.
- În cazul în care transferați instrumentul altor părți, transferați și manualele împreună cu acesta.

Folosiți instrumentul numai conform Manualului de operare și Instrucțiunilor de utilizare. Dacă instrumentul nu este folosit conform acestor documente sau dacă instrumentul este modificat, siguranța acestuia poate fi compromisă, iar Mettler-Toledo GmbH nu își asumă nicio răspundere în acest sens.

1.1 Alte documente aplicabile



Acest Manual de operare oferă scurte instrucțiuni cu privire la primii pași care trebuie urmați pentru o utilizare sigură și eficientă a instrumentului. Personalul trebuie să citească cu atenție și să înțeleagă acest manual înainte de efectuarea oricăror activități.

Pentru informații complete, consultați întotdeauna Manualul de referință (MR).

► www.mt.com/printer-p-20-RM

1.2 Definițiile cuvintelor și ale simbolurilor de avertizare

Notele de siguranță conțin informații importante privind aspecte legate de siguranță. Ignorarea notelor de siguranță poate conduce la vătămări corporale, deteriorarea instrumentului, defecțiuni și rezultate false. Notele de siguranță sunt marcate cu următoarele cuvinte și simboluri de avertizare:

Cuvinte de avertizare

AVERTISMENT Situație periculoasă cu risc mediu care, dacă nu este evitată, poate conduce la deces sau vătămări grave.

ATENȚIE Situație periculoasă cu risc redus care, dacă nu este evitată, conduce la vătămări minore sau moderate.

AVIZ Situație periculoasă cu risc redus care conduce la deteriorarea instrumentului, alte daune materiale, la defecțiuni și rezultate eronate sau la pierderea de date.

Simboluri de avertizare



Pericol de electrocutare



Pericol general: citiți instrucțiunile de utilizare pentru informații despre pericole și măsurile ce trebuie luate.



Notificare

1.3 Note de siguranță specifice produsului

Scop utilizare

Acest instrument este conceput pentru a fi folosit în laboratoare de către personal calificat. Instrumentul este destinat imprimării protocoalelor.

Orice altă utilizare și operare în afara limitelor specificațiilor tehnice, fără acordul în scris al producătorului Mettler-Toledo GmbH este considerată ca neadecvată.

Responsabilitățile proprietarului instrumentului

Proprietarul instrumentului este persoana care deține titlul de proprietate asupra instrumentului și care utilizează instrumentul sau care autorizează orice persoană să-l utilizeze ori persoana considerată prin lege a fi operatorul instrumentului. Proprietarul instrumentului este responsabil de siguranța tuturor persoanelor care utilizează instrumentul și de siguranța terților.

METTLER TOLEDO presupune că proprietarul instrumentului își instruește utilizatorii cum să folosească în siguranță instrumentul la locul de muncă și cum să facă față posibilelor pericole. METTLER TOLEDO presupune că proprietarul instrumentului pune la dispoziție echipamentul de protecție necesar.

Note de siguranță



AVERTISMENT

Accident grav sau mortal ca urmare a electrocutării

Contactul cu piesele sub tensiune poate conduce la accidente sau deces.

- 1 Utilizați exclusiv un cablu de alimentare METTLER TOLEDO și un adaptor de c.a./c.c. omologat, cu o tensiune de ieșire SELV cu limitare de curent.
- 2 Conectați cablul de alimentare la o priză electrică cu împământare, asigurând polaritatea corectă.
- 3 Nu țineți lichide în apropierea cablurilor și a conexiunilor electrice și păstrați-le la loc uscat.
- 4 Verificați cablurile și ștecărele și asigurați-vă că nu sunt deteriorate. Înlocuiți-le dacă sunt deteriorate.



AVIZ

Deteriorare a instrumentului ca urmare a folosirii de piese neadecvate

Folosirea de piese neadecvate în instrument poate conduce la deteriorarea sau funcționarea necorespunzătoare a acestuia.

- Folosiți doar piese de la METTLER TOLEDO care sunt destinate pentru a fi utilizate cu instrumentul dvs.

2 Instalarea și punerea în funcțiune

2.1 Conținutul pachetului

- Adaptor de c.a./c.c.
- Cablu de alimentare (în funcție de țară)
- Manual de operare
- Declarație de conformitate

2.2 Conectarea imprimantei la sursa de alimentare



! AVERTISMENT

Accident grav sau mortal ca urmare a electrocutării

Contactul cu piesele sub tensiune poate conduce la accidente sau deces.

- 1 Utilizați exclusiv un cablu de alimentare METTLER TOLEDO și un adaptor de c.a./c.c. omologat, cu o tensiune de ieșire SELV cu limitare de curent.
- 2 Conectați cablul de alimentare la o priză electrică cu împământare, asigurând polaritatea corectă.
- 3 Nu țineți lichide în apropierea cablurilor și a conexiunilor electrice și păstrați-le la loc uscat.
- 4 Verificați cablurile și ștecărele și asigurați-vă că nu sunt deteriorate. Înlocuiți-le dacă sunt deteriorate.



AVIZ

Defectare a adaptorului de c.a./c.c. ca urmare a supraîncălzirii

Dacă adaptorul de c.a./c.c. este acoperit sau se află într-un recipient, acesta nu se poate răci suficient și se va supraîncălzi.

- 1 Nu acoperiți adaptorul de c.a./c.c.
- 2 Nu introduceți adaptorul de c.a./c.c. într-un recipient.

Imprimanta este livrată cu un adaptor universal de c.a./c.c. sau cu un adaptor de c.a./c.c. cu cablu de alimentare în funcție de țară.

- Instalați cablurile în așa fel încât să nu se poată deteriora sau să nu poată interfera cu funcționarea instrumentului.
- Introduceți ștecărul cablului de alimentare într-o priză electrică cu împământare, ușor de accesat.

- 1 Conectați adaptorul de c.a./c.c. la priza de conectare din spatele imprimantei.
- 2 Fixați conectorul cu piulița.
- 3 Conectați cablul de alimentare 3 pini cu împământare la priza corespunzătoare adaptorului de c.a./c.c.
- 4 Conectați imprimanta la balanță folosind cablul pentru interfață.
- 5 Porniți balanța.
- 6 Conectați imprimanta la sursa de alimentare.



7 Porniți imprimanta de la comutatorul I/O.

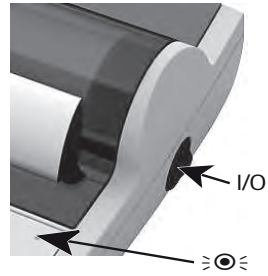

Notă

Numai interfață RS232: becul de semnalizare va lumina intermitent până când instrumentul este conectat. Dacă becul încă mai luminează intermitent, consultați capitolul "Depanare" din Manualul de referință.

2.3 Introducerea hârtiei





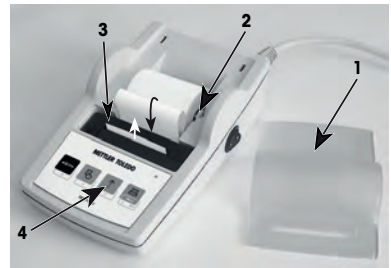



- 1 Îndepărtați capacul (trăgându-l pe spate) (1).
- 2 Introduceți axul rotativ în rola de hârtie (2).
- 3 Introduceți hârtia prin fanta unității de imprimare, în direcția săgeții (3).
- 4 Apăsăți și țineți apăsat până când imprimanta se alimentează cu suficientă hârtie (4).
- 5 Ghidați hârtia prin fanta capacului.
- 6 Puneți capacul la loc (1).

Dacă, după primele materiale imprimate, setările conexiunii (rata de transfer, rata de biți, dialogul de confirmare) balanței se schimbă, imprimanta trebuie repornită. Oprii și porniți imprimanta pentru a reactiva detectarea ratei automate de transfer. Rata de transfer automată poate fi dezactivată.















3 Funcțiile tastelor

















Imprimanta P25

Nivel de operare	 Apăsăți scurt	 Apăsăți și țineți apăsat
	Alimentează o singură linie	Alimentează continuu (până când este eliberată)
 +  On	Efectuează un test de imprimare	Deschide meniul
Nivel de meniu	 Apăsăți scurt	 Apăsăți și țineți apăsat
	Trece la următorul element de meniu	Stochează

Imprimanta P26

Nivel de operare	 Apăsăți scurt	 Apăsăți și țineți apăsat		
	Resetează la zero/tarează balanța	–		
	Imprimă data și ora	–		
	Alimentează o singură linie	Alimentează continuu (până când este eliberată)		
	Imprimă	Deschide meniul		
Nivel de meniu	 Apăsăți scurt		 Apăsăți și țineți apăsat	
 leșire	 Jos	 Sus	 Următorul	Stochează

Imprimanta P28

Nivel de operare	 Apăsai scurt	 Apăsai și țineți apăsat
	Resetează la zero/tarează balanța	–
	Imprimă data și ora	–
	Alimentează o singură linie	Alimentează continuu (până când este eliberată)
	Imprimă	Deschide meniul
Nivel de meniu	 Apăsai scurt	 Apăsai și țineți apăsat
 leșire  Jos  Sus  Următorul	 Stochează	
Nivel de funcție	 Apăsai scurt	 Apăsai și țineți apăsat
	Pornește aplicația Adunare	Oprește aplicația Adunare
	Pornește aplicația Statistici	Oprește aplicația Statistici

4 Meniu

4.1 Imprimanta P25

Apăsăți scurt	Apăsăți și țineți apăsat	Lista tipărită
<div style="border: 1px solid black; padding: 2px; text-align: center;">Settings</div> <div style="border: 1px solid black; padding: 2px; text-align: center;">Reset</div>		Settings Reset
<div style="border: 1px solid black; padding: 2px; text-align: center;">Resetează imprimanta</div>		<pre> ----- Reset done ----- Current settings: Baudrate: 9600 Bit/Parity: 8 Bit Non Handshake: Off Char Set: IBM/DOS </pre>
<div style="border: 1px solid black; padding: 2px; text-align: center;">Numai interfață RS232</div> <div style="border: 1px solid black; padding: 2px; text-align: center;">Auto Bauderate</div> <div style="border: 1px solid black; padding: 2px; text-align: center;">On</div>	Stocează	<pre> Auto Bauderate: On -----STORED----- ... "current settings" </pre>
<div style="border: 1px solid black; padding: 2px; text-align: center;">Auto Bauderate</div> <div style="border: 1px solid black; padding: 2px; text-align: center;">Off</div>	Stocează	<pre> Auto Bauderate: Off -----STORED----- ... "current settings" </pre>
<div style="border: 1px solid black; padding: 2px; text-align: center;">Char Set</div> <div style="border: 1px solid black; padding: 2px; text-align: center;">IBM / DOS</div>	Stocează	<pre> IBM/DOS -----STORED----- ... "current settings" </pre>
<div style="border: 1px solid black; padding: 2px; text-align: center;">IBM / DOS</div> <div style="border: 1px solid black; padding: 2px; text-align: center;">Cyrillic</div>	Stocează	<pre> IBM/DOS Cyrillic -----STORED----- ... "current settings" </pre>
<div style="border: 1px solid black; padding: 2px; text-align: center;">IBM / DOS</div> <div style="border: 1px solid black; padding: 2px; text-align: center;">Japanese</div>	Stocează	<pre> IBM/DOS Japanese -----STORED----- ... "current settings" </pre>
<div style="border: 1px solid black; padding: 2px; text-align: center;">ANSI / WIN</div> <div style="border: 1px solid black; padding: 2px; text-align: center;">Latin 1</div>	Stocează	<pre> ANSI/WIN Latin 1 -----STORED----- ... "current settings" </pre>
<div style="border: 1px solid black; padding: 2px; text-align: center;">ANSI / WIN</div> <div style="border: 1px solid black; padding: 2px; text-align: center;">Cyrillic</div>	Stocează	<pre> ANSI/WIN Cyrillic -----STORED----- ... "current settings" </pre>
<div style="border: 1px solid black; padding: 2px; text-align: center;">ANSI / WIN</div> <div style="border: 1px solid black; padding: 2px; text-align: center;">Japanese</div>	Stocează	<pre> ANSI/WIN Japanese -----STORED----- ... "current settings" </pre>
<div style="border: 1px solid black; padding: 2px; text-align: center;">Balance Feature</div> <div style="border: 1px solid black; padding: 2px; text-align: center;">Enable</div>	Stocează	<pre> Balance Feature: Enable -----STORED----- ... "current settings" </pre>
<div style="border: 1px solid black; padding: 2px; text-align: center;">Balance Feature</div> <div style="border: 1px solid black; padding: 2px; text-align: center;">Disable</div>	Stocează	<pre> Balance Feature: Disable -----STORED----- ... "current settings" </pre>

Opțiune de meniu

Setare din fabrică

4.2 Imprimanta P26/P28

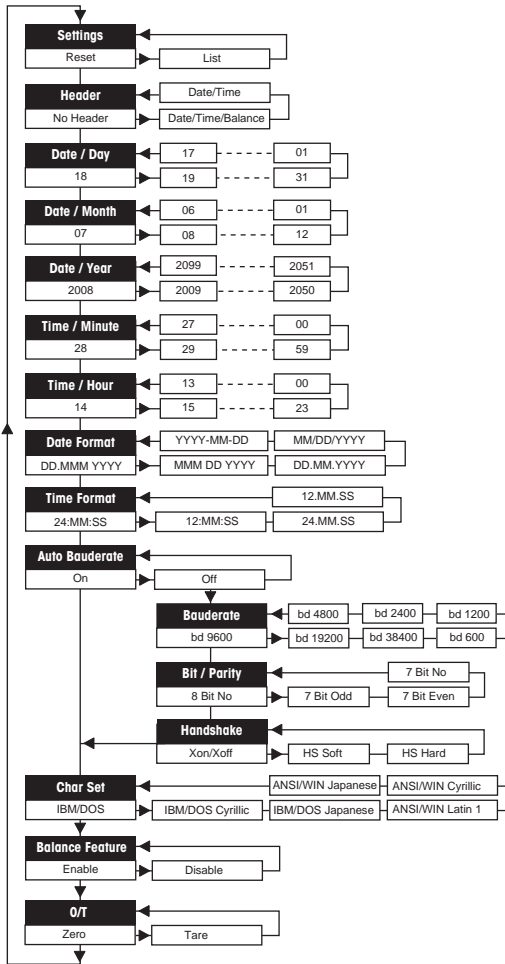

Exemple de folosire a afişajului balanţei:





Setări	Reset	rESEt
	List	L 15t
Antet	*No Header	no Hdr
	Date/Time	d t Hdr
	Date/Time/Balance	dtb Hdr
Data zi**	18	dRY 18
Data lună**	07	Month 07
Data an**	2008	YEAR 2008
Imp minut**	28	n in 28
Imp oră**	14	Hour 14
Data format***	DD.MMM.YYYY	ddMMnY
	MMM DD.YYYY	MMn ddY
	DD.MM.YYYY	ddMMnY
	MM/DD/YYYY	MM ddYY
	YYYY-MM-DD	Y-MM-dd
Imp format***	24.MM.SS	24:MM=SS
	12.MM.SS	12:MM=SS
	24.MM.SS	24MMSS
	12.MM.SS	12MMSS
Rata de transfer	*9600	bd9600
	19200	bd 19200
	38400	bd38400
	600	bd600
	1200	bd 1200
	2400	bd2400
	4800	bd4800
Bit/Paritate	*8 Bit No	8b-no
	7 Bit Odd	7b-odd
	7 Bit Even	7b-E
	7 Bit No	7b-no
Dialog de confirmare	*Xon/Xoff	HS oFF
	HS Soft	HS 5oFt
	HS Hard	HS HRRd
Set caractere	*IBM/DOS	d05
	IBM/DOS Cyrillic	d05 C4r
	IBM/DOS Japanese	d05 JRP
	Ansi/Win Latin 1	11 in LRt
	Ansi/Win Cyrillic	11 in C4r
	Ansi/Win Japanese	11 in JRP
Tară/Zero	*Zero	ZEro
	Tare	tAR-E

Opţiune de meniu
Setare din fabrică

- * setări din fabrică
- ** instrumente cu ceas integrat: nu este cazul, ceasul integrat are prioritate
- *** instrumente cu ceas integrat: formatul imprimantei are prioritate

Exemplu de setare a zilei (numai P26/P28)

Deschideți meniul

- Țineți apăsat pe tasta  până când apare **Reset** (Resetare).
- Selectați opțiunea de meniu **Day** (Zi) folosind tasta .
- Selectați ziua, de exemplu ziua 21.
Derulați în sus folosind tasta .
- Derulați în jos folosind tasta .



Salvați setările

- Țineți apăsat pe tasta  până când apare **Stored** (Stocat).

Aplicația Statistici (numai P28)



Greutatea probei trebuie să se încadreze în intervalul 70-130 % din valoarea medie curentă.
Greutatea minimă dinamică modificată trebuie să fie 100 d.

- 1 Apăsați pe  pentru a deschide aplicația Statistici (LED aprins).
- 2 Adăugați o probă nouă și apăsați pe **M+**.
- 3 Apăsați pe  pentru a imprima subtotalul, dacă este necesar.
- 4 Apăsați și țineți apăsat pe  pentru a imprima și închide aplicația Statistici (LED stins).



Notă

- Nu este permisă schimbarea unității atât timp cât aplicația este deschisă.
- Număr maxim probe 999.

Aplicația Adunare (numai P28)



Greutăți minime + 1 d.

- 1 Apăsați pe  pentru a deschide aplicația Adunare (LED aprins).
- 2 Adăugați o probă nouă și apăsați pe **M+**.
- 3 Apăsați pe  pentru a imprima subtotalul, dacă este necesar.
- 4 Apăsați și țineți apăsat pe  pentru a imprima și închide aplicația Adunare (LED stins).

Notă

- Nu este permisă schimbarea unității atât timp cât aplicația este deschisă.
- Număr maxim probe 999.

5 Întreținerea



AVERTISMENT

Accident grav sau mortal ca urmare a electrocutării

Contactul cu piese sub tensiune poate conduce la accidente și deces.

- 1 Deconectați imprimanta de la sursa de alimentare înainte de curățare și întreținere.
- 2 Asigurați-vă că niciun lichid nu intră în imprimantă sau în adaptorul de c.a./c.c.

5.1 Înlocuirea rolei de hârtie

Introducerea unei role noi de hârtie este descrisă în capitolul [Introducerea hârtiei ▶ pagina 104]. Codul de comandă al rolei de hârtie poate fi găsit în capitolul [Consumabile ▶ pagina 112].

Notă

Axa rotativă trebuie să fie întotdeauna transferată din rola de hârtie consumată în cea nouă.

5.2 Înlocuirea panglicii

Codul de comandă al cartușului cu panglică poate fi găsit în capitolul [Consumabile ▶ pagina 112].

- 1 Scoateți capacul (1).
- 2 Scoateți hârtia din unitatea de imprimare (2).



- 3 Scoateți cartușul cu panglică apăsând în direcția săgeții (3).
- 4 Introduceți cartușul cu panglică nou. Dacă este necesar, folosiți roțița de tensionare (4).

Introducerea unei role noi de hârtie este descrisă în capitolul [Introducerea hârtiei ▶ pagina 104].



5.3 Curățarea carcasei

Întrucât carcasa imprimantei este realizată din materiale rezistente, de calitate superioară, pot fi utilizați orice agenți de curățare slabi, disponibili în comerț.



AVIZ

Deteriorare a imprimantei ca urmare a folosirii de metode de curățare necorespunzătoare

Carcasa imprimantei este fabricată din materiale rezistente, de calitate superioară, și poate fi deteriorată de anumii agenți de curățare, solvenți sau agenți abrazivi. Lichidele care pătrund în carcasă pot deteriora imprimanta.

- 1 Folosiți apă și un detergent slab pentru a curăța imprimanta.
- 2 Ștergeți imediat orice scurgeri.
- 3 Nu lăsați lichidele să pătrundă în interiorul imprimantei.

Contactați un METTLER TOLEDO reprezentant METTLER TOLEDO pentru a afla despre opțiunile de service disponibile – întreținerea regulată de către un inginer de service autorizat va asigura precizia constantă a cântărilorilor pe termen lung și va prelungi durata de viață a imprimantei.

6 Date tehnice

6.1 Date tehnice generale

Sursă de alimentare

Adaptor de c.a./c.c.:	Principal: 100 – 240 V, 50/60 Hz Secundar: 12 V c.c., 2,5 A (cu protecție electronică la suprasarcină)
Cablu pentru adaptorul de c.a./c.c.:	Cu 3 conductoare, cu fișă în funcție de țară
Polaritate:	 cu o tensiune de ieșire SELV (Safety Extra Low Voltage, tensiune de siguranță foarte joasă) limitată
Tensiune rețea de alimentare:	12 V c.c.
Consum de energie:	Max. 2.5 A

Protecție și standarde

Categorie de supratensiune:	II
Grad de poluare:	2
Standarde privind siguranța și CEM:	Consultați Declarația de conformitate
Domeniul de aplicare:	Exclusiv pentru uz în spații interioare închise

Condiții de mediu

Altitudine față de nivelul mediu al mării:	Până la 4000 m
Temperatură ambiantă:	0 – 40 °C
Condiție de depozitare:	-25 – 60 °C
Umiditate relativă a aerului:	Max. 80% până la 31 °C, în scădere lineară la 50% la 40 °C, fără condens

Caracteristicile imprimantei

Tehnologie de imprimare:	Imprimantă matriceală 5x7, lungime a rândului de 24 de caractere
Viteză de imprimare:	2,3 rânduri pe secundă
Cartuș cu panglică:	Înlocuibil, negru
Rola de hârtie:	Hârtie standard 57,5 mm x ø 50-60 mm, integrată în carcasă, mărime comercială
Calitatea imprimării:	Imprimare rezistentă la lumină și stabilă termic (GLP, GMP, ISO 9001)
Interfețe:	RS-P25, RS-P26, RS-P28, USB-P25, RS232C
Limite de compatibilitate:	USB <ul style="list-style-type: none">• Funcția dată/oră: nu este cazul la balanțele cu ceas integrat (ceasul integrat are prioritate)• Funcția de resetare la zero/tarare: nu este cazul la niciunul dintre modelele de cântare

Dimensiune/greutate

Dimensiunile imprimantei (l x A x Î):	120 x 203 x 73 mm
Dimensiunile ambalajului (l x A x Î):	255 x 205 x 150 mm
Greutate netă:	740 g (cu rola de hârtie)

7 Consumabile

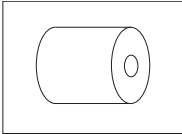
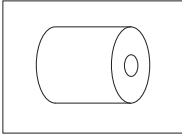
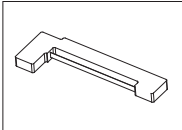
	Descriere	Piesă nr.
	Rolă de hârtie (lungime: 20 m), set 5 buc.	00072456
	Rolă de hârtie (lungime: 13 m), autoadezivă, set 3 buc.	11600388
	Cartuș cu panglică, negru, set 2 buc.	00065975

1 Bezpečnostné informácie

Pre tento prístroj sú dostupné dva dokumenty s názvom "Používateľská príručka" a "Návod na používanie".

- Používateľská príručka opisuje, ako začať prístroj používať.
- Návod na používanie obsahuje úplný opis prístroja a jeho použitie.
- Uchovajte obidva dokumenty pre prípad budúcej potreby.
- Pri predávaní prístroja iným stranám obidva dokumenty priložte.

Prístroj používajte výlučne v súlade s návodom na používanie a používateľskou príručkou. V prípade, že prístroj nepoužívate v súlade s týmito dokumentmi alebo ak ho zmeníte, môže dôjsť k zníženiu bezpečnosti prístroja a Mettler-Toledo GmbH nepreberá žiadnu zodpovednosť.

1.1 Ďalšie platné dokumenty



Táto používateľská príručka je stručný návod, ktorý poskytuje informácie pre vykonávanie prvých krokov práce s prístrojom bezpečným a efektívnym spôsobom. Personál je pred vykonávaním akýchkoľvek pracovných úloh povinný dôkladne si preštudovať tento návod a porozumieť jeho obsahu.

Na získanie kompletných informácií si vždy pozrite návod na používanie (NP).

► www.mt.com/printer-p-20-RM

1.2 Definície signálnych slov a výstražných symbolov

Bezpečnostné upozornenia obsahujú dôležité informácie týkajúce sa bezpečnosti. V dôsledku ignorovania týchto bezpečnostných upozornení môže dôjsť k zraneniam osôb, poškodeniu prístroja, poruchám a vykazovaniu nesprávnych výsledkov. Bezpečnostné upozornenia sú označené nasledujúcimi signálnymi slovami a výstražnými symbolmi:

Signálne slová

VAROVANIE Nebezpečná situácia so strednou mierou rizika, ktorá v prípade výskytu môže viesť k ťažkým zraneniam alebo smrti.

UPOZORNENIE Nebezpečná situácia s nízkou mierou rizika, ktorá v prípade výskytu môže viesť k ľahkým alebo mierne ťažkým zraneniam.

OZNÁMENIE Nebezpečná situácia s nízkou mierou rizika, ktorá v prípade výskytu môže viesť k poškodeniu prístroja, inej materiálnej škode, poruchám a chybným výsledkom alebo k strate údajov.

Výstražné symboly



Zásah elektrickým prúdom



Všeobecné nebezpečenstvo: Prečítajte si návod na používanie, v ktorom nájdete informácie o nebezpečenstvách a výsledných opatreniach.



Oznámenie

1.3 Bezpečnostné upozornenia vzťahujúce sa na konkrétny produkt

Určené použitie

Tento prístroj je určený na používanie vyškoleným personálom v laboratóriách. Prístroj je určený na tlač protokolov.

Akýkoľvek iný druh používania a prevádzky presahujúci limity technických parametrov bez písomného súhlasu Mettler-Toledo GmbH sa považuje za nezamýšľaný.

Zodpovednosť vlastníka prístroja

Vlastníkom prístroja je osoba, ktorá je držiteľom vlastníckeho práva k prístroju, a ktorá prístroj používa alebo poverí inú osobu jeho používaním, alebo osoba, ktorá sa považuje zo zákona za operátora prístroja. Vlastník prístroja je zodpovedný za bezpečnosť všetkých používateľov prístroja a tretích strán.

METTLER TOLEDO predpokladá, že vlastník prístroja poskytne používateľom školenie o bezpečnom používaní prístroja na pracovisku a informácie o potenciálnych rizikách. METTLER TOLEDO predpokladá, že vlastník prístroja poskytne potrebný ochranný výstroj.

Bezpečnostné upozornenia



VAROVANIE

Smrť alebo vážny úraz v dôsledku zásahu elektrickým prúdom

Kontakt s časťami pod prúdom môže viesť k smrti alebo poraneniu.

- 1 Používajte iba schválený METTLER TOLEDO napájací kábel a napájací adaptér s obmedzeným výkonom SELV.
- 2 Pripájajte napájací kábel do uzemnenej elektrickej zásuvky so správnou polaritou.
- 3 Všetky elektrické káble a prípojky chráňte pred kvapalinami a vlhkosťou.
- 4 Skontrolujte, či káble a zástrčka nie sú poškodené a v prípade poškodenia ich vymeňte.



OZNÁMENIE

Poškodenie prístroja použitím nevhodných súčastí

Použitie nevhodných súčastí v prístroji môže prístroj poškodiť alebo spôsobiť jeho poruchu.

- Používajte len súčasti METTLER TOLEDO určené na použitie s vašim prístrojom.

2 Inštalácia a uvedenie do prevádzky

2.1 Obsah balenia

- Napájací adaptér
- Napájací kábel (špecifický podľa krajiny)
- Užívateľská príručka
- Vyhlásenie o zhode

2.2 Pripojenie tlačiarne k zdroju napájania



VAROVANIE

Smrť alebo vážny úraz v dôsledku zásahu elektrickým prúdom

Kontakt s časťami pod prúdom môže viesť k smrti alebo poraneniu.

- 1 Používajte iba schválený METTLER TOLEDO napájací kábel a napájací adaptér s obmedzeným výkonom SELV.
- 2 Pripájajte napájací kábel do uzemnenej elektrickej zásuvky so správnou polaritou.
- 3 Všetky elektrické káble a prípojky chráňte pred kvapalinami a vlhkosťou.
- 4 Skontrolujte, či káble a zástrčka nie sú poškodené a v prípade poškodenia ich vymeňte.



OZNÁMENIE

Poškodenie napájacieho adaptéra v dôsledku prehriatia

Ak je napájací adaptér prikrytý alebo v nejakej nádobe, nie je dostatočne chladený a prehrieva sa.

- 1 Napájací adaptér neprikrývajte.
- 2 Napájací adaptér nevkladajte do nádoby.

Tlačiareň je napájaná cez univerzálny napájací adaptér alebo napájací adaptér s napájacím káblom špecifickým pre danú krajinu.

- Káble nainštalujte tak, aby sa nemohli poškodiť a neprekážali pri prevádzke.
- Vložte napájací kábel do uzemnenej elektrickej zásuvky, ktorá je ľahko prístupná.

- 1 Pripojte napájací adaptér do pripájacej zdiery na zadnej strane tlačiarne.
- 2 Upevnite konektor pomocou matice.
- 3 Pripojte 3-kolíkový uzemnený napájací kábel do zásuvky pre napájací adaptér.
- 4 Pripojte tlačiareň a váhy pomocou kábla rozhrania.
- 5 Zapnite váhy.
- 6 Pripojte tlačiareň k zdroju napájania.
- 7 Vypínačom I/O zapnite tlačiareň.

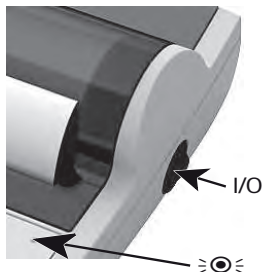

Poznámka

Len rozhranie RS232: kontrolka blinká, kým sa nepripojí prístroj. Ak kontrolka stále blinká, riešenie vyhľadajte v časti "Riešenie problémov" v návode na používanie.

2.3 Vloženie papiera





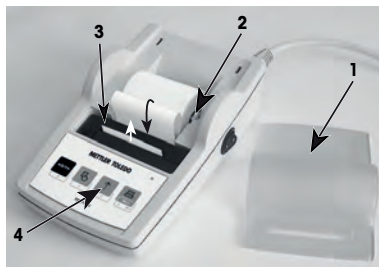



- 1 Odstráňte kryt papiera (potiahnite za zadnú časť) (1).
- 2 Zasuňte rotačnú os na papier cez jadro kotúča papiera (2).
- 3 Papier podajte cez štrbinu v jednotke tlačiarnie v smere šípky (3).
- 4 Stlačte a podržte, kým sa nevysunie dostatok papiera (4).
- 5 Zavedte papier cez štrbinu v kryte papiera.
- 6 Nasadte kryt papiera (1).

Ak sa po prvých výťažkoch zmenia nastavenia pripojenia váh (prenosová rýchlosť baud, biť, handshake), musíte tlačiareň reštartovať. Na opätovné spustenie detekcie automatickej prenosovej rýchlosti baud tlačiareň vypnite a zapnite. Automatická prenosová rýchlosť baud sa dá vypnúť.















3 Funkcie tlačidiel

















Tlačiareň P25

Úroveň operácie	 Stlačte krátko	 Stlačte a podržte
	podávanie po jednom riadku	súvislé podávanie (do uvoľnenia tlačidla)
 +  On	test tlačiarne s tlačou nastavení	otvorenie ponuky
Úroveň ponuky	 Stlačte krátko	 Stlačte a podržte
	nasledujúca položka ponuky	uloženie

Tlačiareň P26

Úroveň operácie	 Stlačte krátko	 Stlačte a podržte			
	vynulovanie/farovanie strán	–			
	tlač dátumu a času	–			
	podávanie po jednom riadku	súvislé podávanie (do uvoľnenia tlačidla)			
	tlač	otvorenie ponuky			
Úroveň ponuky	 Stlačte krátko	 Stlačte a podržte			
 ukončenie	 nadol	 nahor	 ďalej	 uloženie	

Tlačiareň P28

Úroveň operácie	 Stlačte krátko	 Stlačte a podržte
	vynulovanie/tarovanie váh	–
	tlač dátumu a času	–
	podávanie po jednom riadku	súvislé podávanie (do uvoľnenia tlačidla)
	tlač	otvorenie ponuky
Úroveň ponuky	 Stlačte krátko	 Stlačte a podržte
 ukončenie	 nadol	 nahor
	 ďalej	 uloženie
Úroveň funkcie	 Stlačte krátko	 Stlačte a podržte
 M+	spustenie aplikácie Súčet	ukončenie aplikácie Súčet
 M+	spustenie aplikácie Štatistika	ukončenie aplikácie Štatistika

4 Ponuka

4.1 Tlačiareň P25

☞ S tlačiacom S tlačiacom	☞ S tlačiacom S tlačiacom	Tlač
<div style="border: 1px solid black; padding: 2px; text-align: center;">Settings</div> <div style="border: 1px solid black; padding: 2px; text-align: center;">Reset</div>	resetovanie tlačiarne	Settings Reset
<div style="border: 1px dashed gray; padding: 2px;"> <div style="border: 1px solid black; padding: 2px; text-align: center;">Len rozhranie RS232</div> </div>		<pre>----- Reset done ----- Current settings: Baudrate: 9600 Bit/Parity: 8 Bit Non Handshake: Off Char Set: IBM/DOS</pre>
<div style="border: 1px solid black; padding: 2px; text-align: center;">Auto Baudrate</div> <div style="border: 1px solid black; padding: 2px; text-align: center;">On</div>	uloženie	<pre>Auto Baudrate: On -----STORED----- ... "current settings"</pre>
<div style="border: 1px solid black; padding: 2px; text-align: center;">Auto Baudrate</div> <div style="border: 1px solid black; padding: 2px; text-align: center;">Off</div>	uloženie	<pre>Auto Baudrate: Off -----STORED----- ... "current settings"</pre>
<div style="border: 1px solid black; padding: 2px; text-align: center;">Char Set</div> <div style="border: 1px solid black; padding: 2px; text-align: center;">IBM / DOS</div>	uloženie	<pre>IBM/DOS -----STORED----- ... "current settings"</pre>
<div style="border: 1px solid black; padding: 2px; text-align: center;">IBM / DOS</div> <div style="border: 1px solid black; padding: 2px; text-align: center;">Cyrillic</div>	uloženie	<pre>IBM/DOS Cyrillic -----STORED----- ... "current settings"</pre>
<div style="border: 1px solid black; padding: 2px; text-align: center;">IBM / DOS</div> <div style="border: 1px solid black; padding: 2px; text-align: center;">Japanese</div>	uloženie	<pre>IBM/DOS Japanese -----STORED----- ... "current settings"</pre>
<div style="border: 1px solid black; padding: 2px; text-align: center;">ANSI / WIN</div> <div style="border: 1px solid black; padding: 2px; text-align: center;">Latin 1</div>	uloženie	<pre>ANSI/WIN Latin 1 -----STORED----- ... "current settings"</pre>
<div style="border: 1px solid black; padding: 2px; text-align: center;">ANSI / WIN</div> <div style="border: 1px solid black; padding: 2px; text-align: center;">Cyrillic</div>	uloženie	<pre>ANSI/WIN Cyrillic -----STORED----- ... "current settings"</pre>
<div style="border: 1px solid black; padding: 2px; text-align: center;">ANSI / WIN</div> <div style="border: 1px solid black; padding: 2px; text-align: center;">Japanese</div>	uloženie	<pre>ANSI/WIN Japanese -----STORED----- ... "current settings"</pre>
<div style="border: 1px solid black; padding: 2px; text-align: center;">Balance Feature</div> <div style="border: 1px solid black; padding: 2px; text-align: center;">Enable</div>	uloženie	<pre>Balance Feature: Enable -----STORED----- ... "current settings"</pre>
<div style="border: 1px solid black; padding: 2px; text-align: center;">Balance Feature</div> <div style="border: 1px solid black; padding: 2px; text-align: center;">Disable</div>	uloženie	<pre>Balance Feature: Disable -----STORED----- ... "current settings"</pre>

Položka ponuky
Nastavenie z výroby

4.2 Tlačiareň P26/P28

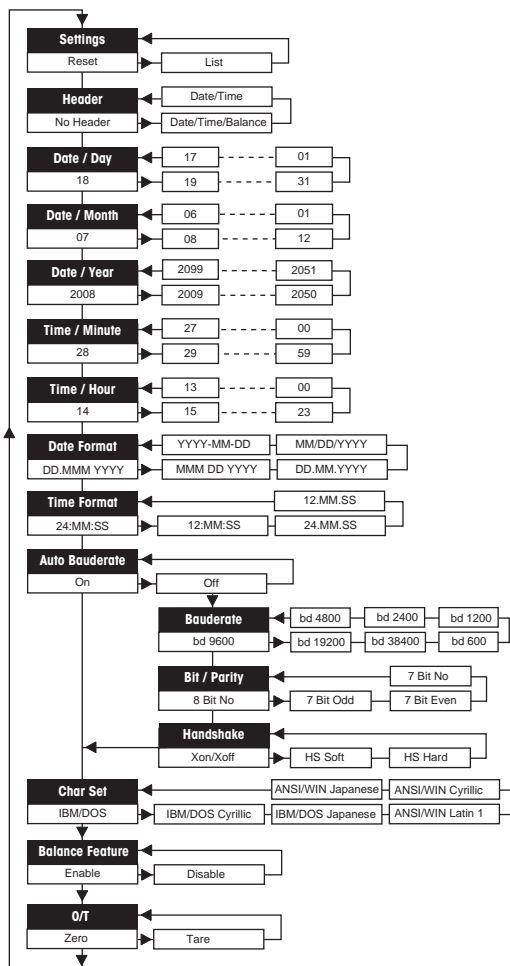

Príklady, ak sa používa displej váš:





Nastavenia	
Reset	<i>rESEt</i>
List	<i>L ISt</i>
Hlavička	
*No Header	<i>no Hdr</i>
Date/Time	<i>d t Hdr</i>
Date/Time/Balance	<i>dtb Hdr</i>
Deň dátumu**	
18	<i>dRY 18</i>
Mesiac dátumu**	
07	<i>Month 07</i>
Rok dátumu**	
2008	<i>YEAR-2008</i>
Minúta času**	
28	<i>Min. 28</i>
Hodina času**	
14	<i>Hour 14</i>
Formát dátumu***	
DD.MMM.YYYY	<i>ddMMY Y</i>
MMM DD YYYY	<i>MMY dd Y</i>
DD.MM.YYYY	<i>ddMM.Y</i>
MM/DD/YYYY	<i>MM dd YY</i>
YYYY-MM-DD	<i>Y-MM-dd</i>
Formát času***	
24:MM:SS	<i>24-MM-SS</i>
12:MM:SS	<i>12-MM-SS</i>
24.MM.SS	<i>24MMSS</i>
12.MM.SS	<i>12MMSS</i>
Prenosová rýchlosť baud	
*9600	<i>bd9600</i>
19200	<i>bd.19200</i>
38400	<i>bd38400</i>
600	<i>bd600</i>
1200	<i>bd.1200</i>
2400	<i>bd2400</i>
4800	<i>bd4800</i>
Bits/parita	
*8 Bit No	<i>8b-no</i>
7 Bit Odd	<i>7b-odd</i>
7 Bit Even	<i>7b-E</i>
7 Bit No	<i>7b-no</i>
Handshake	
*Xon/Xoff	<i>HS oFF</i>
HS Soft	<i>HS SoFFt</i>
HS Hard	<i>HS HARd</i>
Súbor znakov	
*IBM/DOS	<i>d05</i>
IBM/DOS Cyrillic	<i>d05 C4r</i>
IBM/DOS Japanese	<i>d05 JAP</i>
Ansi/Win Latin 1	<i>11 in LAt</i>
Ansi/Win Cyrillic	<i>11 in C4r</i>
Ansi/Win Japanese	<i>11 in JAP</i>
Tarovať/nulovať	
*Zero	<i>ZERo</i>
Tare	<i>TARe</i>

Položka ponuky
Nastavenie z výroby

- * nastavenia z výroby
- ** **prístroje so zabudovanými hodinami:** nevzťahuje sa, zabudované hodiny majú prioritu
- *** **prístroje so zabudovanými hodinami:** formát tlačiarne má prioritu

Príklad pre nastavenie dňa (len P26/P28)

Otvorenie ponuky

- Podržte stlačené tlačidlo , kým sa nezobrazí **Reset** (Resetovať).
- Tlačidlom , vyberte položku ponuky **Day** (Deň).
- Vyberte deň, napr. deň 21.
Tlačidlom  prechádzajte nahor.
Tlačidlom  prechádzajte nadol.



Uloženie nastavení

- Podržte stlačené tlačidlo , kým sa nezobrazí **Stored** (Uložené).

Aplikácia Štatistika (len P28)



Hmotnosť vzorky musí byť v rozmedzí 70 % – 130 % aktuálnej priemernej hodnoty.
Minimálna zmenená dynamická hmotnosť musí byť 100 d.

- 1 Stlačením tlačidla  spustíte aplikáciu Štatistika (svieti LED dióda).
- 2 Pridajte novú vzorku a stlačte tlačidlo **M+**.
- 3 V prípade potreby vytlačte medzisúčet stlačením tlačidla .
- 4 Na vytlačenie a ukončenie aplikácie Štatistika stlačte a podržte tlačidlo  (LED dióda nesvieti).





Poznámka

- Keď je aplikácia spustená, nie je povolená zmena jednotky.
- Maximálne 999 vzoriek.

Aplikácia Súčet (len P28)



Minimálne hmotnosti + 1 d.

- 1 Stlačením tlačidla  spustíte aplikáciu Súčet (svieti LED dióda).
- 2 Pridajte novú vzorku a stlačte tlačidlo **M+**.
- 3 V prípade potreby vytlačte medzisúčet stlačením tlačidla .
- 4 Na vytlačenie a ukončenie aplikácie Súčet stlačte a podržte tlačidlo  (LED dióda nesvieti).



Poznámka

- Keď je aplikácia spustená, nie je povolená zmena jednotky.
- Maximálne 999 vzoriek.

5 Údržba



VAROVANIE

Smrť alebo vážny úraz v dôsledku zásahu elektrickým prúdom

Kontakt s časťami pod prúdom môže viesť k poraneniu a smrti.

- 1 Pred čistením a údržbou odpojte tlačiareň od zdroja napájania.
- 2 Zabezpečte, aby do tlačiarne alebo napájacieho adaptéra neprenikli žiadne kvapaliny.

5.1 Výmena kotúča papiera

Vloženie nového kotúča papiera je opísané v kapitole [Vloženie papiera ▶ stranu 116]. Objednávacie číslo kotúča papiera nájdete v kapitole [Spotrebný materiál ▶ stranu 124].



Poznámka

Rotáciu os na papier musíte vždy preložiť zo starého kotúča papiera do nového kotúča.

5.2 Výmena pásky

Objednávacie číslo páskovej kazety nájdete v kapitole [Spotrebný materiál ▶ stranu 124].

- 1 Odstráňte kryt papiera (1).
- 2 Vytiahnite papier z jednotky tlačiarne (2).



- 3 Stlačením v smere šípky (3) odstráňte kazetu s páskou.
- 4 Vložte novú kazetu s páskou. V prípade potreby pásku napnite napínacím kolieskom (4).

Vloženie nového kotúča papiera je opísané v kapitole [Vloženie papiera ▶ stranu 116].



5.3 Čistenie krytu

Keďže telo tlačiarne je vyrobené z odolných materiálov špičkovej kvality, na čistenie môžete používať všetky na trhu dostupné šetrné čistiace prostriedky.



OZNÁMENIE

Poškodenie tlačiarne dôsledkom použitia nevhodných čistiacich metód

Tlačiareň je vyrobená z vysokokvalitných, odolných materiálov a niektoré čistiace prostriedky, rozpúšťadlá alebo abrazíva ju môžu poškodiť. Ak do telesa preniknú kvapaliny, tlačiareň sa môže poškodiť.

- 1 Na čistenie tlačiarne používajte iba vodu a šetrné čistiace prostriedky.
- 2 Vyliatu tekutinu okamžite utrite.
- 3 Zabezpečte, aby sa do vnútra tlačiarne nedostali žiadne tekutiny.

Kontaktujte zástupcu spoločnosti METTLER TOLEDO a požiadajte o informácie o dostupných možnostiach servisu – pravidelná údržba autorizovaným servisným technikom zabezpečí dlhodobú presnosť váženia a predĺži prevádzkovú životnosť prístroja.

6 Technické údaje

6.1 Všeobecné technické údaje

Napájanie

Napájací adaptér AC/DC:	Primárny: 100 – 240 V, 50/60 Hz Sekundárny: 12 V DC, 2,5 A (s ochranou proti elektrickému preťaženiu)
Kábel pre napájací adaptér AC/DC:	3-žilový so zástrčkou špecifickou podľa krajiny
Polarita:	 s obmedzeným výkonom SELV (ochrana malým napätím)
Napätie elektrického vedenia:	12 V DC
Spotreba energie:	Max. 2,5 A

Ochrana a normy

Kategória prepätia:	II
Stupeň znečistenia:	2
Normy v oblasti bezpečnosti a EMC:	Pozrite Vyhlásenie o zhode
Rozsah použitia:	Na použitie výlučne v uzavretých interiérových priestoroch

Okolité podmienky

Nadmorská výška:	do 4000 m
Teplota prostredia:	0 až 40 °C
Podmienky skladovania:	-25 až 60 °C
Relatívna vlhkosť vzduchu:	Max. 80 % do 31 °C, lineárny pokles na 50 % pri 40 °C, nekondenzujúca

Vlastnosti tlačiarnie

Technológia tlače:	Maticová bodová tlačiareň 5 × 7, dĺžka riadku 24 znakov
Rýchlosť tlače:	2,3 riadka za sekundu
Kazeta s páskou:	vymeniteľná, čierna
Kotúč papiera:	Štandardný papier 57,5 mm × ø 50 do 60 mm, integrovaný v telese, komerčná veľkosť
Kvalita tlače:	Svetlostála a tepelne stála tlač (GLP, GMP, ISO 9001)
Rozhrania:	RS-P25, RS-P26, RS-P28 USB-P25
Obmedzenia kompatibility:	USB <ul style="list-style-type: none">Funkcia Dátum/čas: nevzťahuje sa na váhy so zabudovanými hodinami (zabudované hodiny majú prioritu)Funkcia Vynulovanie/tarovanie: nevzťahuje sa na všetky modely váh

Rozmery/hmotnosť

Rozmery tlačiarnie (š × h × v):	120 × 203 × 73 mm
Rozmery balenia (š × h × v):	255 × 205 × 150 mm
Čistá hmotnosť:	740 g (paper roll incl.)

7 Spotrebný materiál

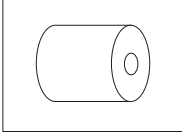
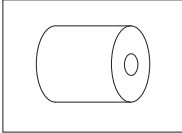
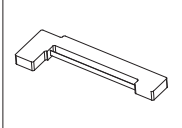
Opis	Č. položky	
 A simple line drawing of a roll of paper, showing the cylindrical shape and the circular end face with a central hole.	Kotúč papiera (dĺžka: 20 m), súprava 5 kusov	00072456
 A simple line drawing of a roll of paper, showing the cylindrical shape and the circular end face with a central hole.	Kotúč papiera (dĺžka: 13 m), samolepiaci, súprava 3 kusov	11600388
 A line drawing of a ribbon cartridge, showing its L-shaped profile and the internal structure of the ribbon.	Pásková kazeta, čierna, súprava 2 kusov	00065975

1 Säkerhetsinformation

Två dokument som heter "User Manual" ("Användarmanual") och "Operating Instructions" ("Bruksanvisning") finns tillgängliga för detta instrument.

- I användarmanualen finns information om hur du gör när du ska börja använda instrumentet.
- Bruksanvisningen innehåller en fullständig beskrivning av instrumentet och hur man använder det.
- Spara båda dokumenten för framtida bruk.
- Om du lämnar instrumentet vidare till någon annan part ska du inkludera båda dokumenten.

Använd instrumentet endast på det sätt som beskrivs i användarmanualen och bruksanvisningen. Om du inte använder instrumentet på det sätt som beskrivs i de här dokumenten eller om du utför några ändringar på det kan det inverka negativt på användarens säkerhet och Mettler-Toledo GmbH fransäger sig allt ansvar.

1.1 Ytterligare relevanta dokument



Denna användarhandbok ger korrfattad information om hur du använder instrumentet på ett säkert och effektivt sätt. All personal måste ha läst och förstått innehållet i denna handbok innan de använder enheten.

Mer information finns i referenshandboken.

► www.mt.com/printer-p-20-RM

1.2 Förklaring av uppmärksamhetsord och varningssymboler

Säkerhetsanvisningarna innehåller viktig information gällande säkerhet. Om säkerhetsanvisningarna inte beaktas kan det leda till personskador, skador på instrumentet, funktionsfel eller felaktiga resultat. Säkerhetsanvisningarna är märkta med följande signalord och varningssymboler:

Signalord

WARNING

En riskfylld situation med medelstor risk som eventuellt kan leda till dödsfall eller allvarliga personskador om situationen inte undviks.

OBSERVERA

En riskfylld situation med låg risk som kan leda till mindre eller måttliga personskador om situationen inte undviks.

OBS

En riskfylld situation med låg risk som kan leda till skador på instrumentet, andra materialskador, funktionsfel och felaktiga resultat eller förlust av data.

Varningssymboler



Elstöt



Allmän risk: information om faror och nödvändiga åtgärder finns i bruksanvisningen.



Obs!

1.3 Produktspecifika säkerhetsanvisningar

Avsedd användning

Detta instrument är avsett för användning i laboratorier av utbildad personal. Instrumentet ska användas för utskrift av protokoll.

All annan typ av användning utöver det som anges i de tekniska specifikationerna utan skriftligt medgivande från Mettler-Toledo GmbH anses som icke avsedd användning.

Instrumentägarens ansvarsskyldigheter

Instrumentägaren är den person som innehar äganderätten till instrumentet och som använder instrumentet eller ger andra personer behörighet att använda det, alternativt den person som enligt lag är instrumentets operatör. Instrumentägaren ansvarar för alla användares och tredje parts säkerhet.

METTLER TOLEDO utgår från att instrumentägaren utbildar alla användare i hur instrumentet ska användas på ett säkert sätt på den aktuella arbetsplatsen samt hanterar alla potentiella risker och faror. METTLER TOLEDO utgår från att instrumentägaren tillhandahåller all nödvändig skyddsutrustning.

Säkerhetsanvisningar



VARNING

Risk för dödsfall eller allvarlig personskada till följd av elektrisk stöt

Kontakt med strömförande delar kan leda till dödsfall eller personskada.

- 1 Använd endast en godkänd METTLER TOLEDO nätadapter med strömbegränsning i form av ett SELV-uttag.
- 2 Anslut strömkabeln till ett jordat vägguttag och kontrollera att polariteten är korrekt.
- 3 Håll alla elkablar och anslutningar på avstånd från vätskor och fukt.
- 4 Kontrollera kablar och kontakter med avseende på skador och byt ut eventuella skadade kablar och kontakter.



OBS

Skada på instrumentet på grund av användning av olämpliga delar

Om olämpliga delar används för instrumentet kan det leda till skador eller funktionsfel på instrumentet.

- Använd endast delar från METTLER TOLEDO som är avsedda för instrumentet.

2 Installation och idrifttagning

2.1 Ingår i leveransen

- Nätadapter
- Strömkabel (landsspecifik)
- Användarhandbok
- Försäkran om överensstämmelse

2.2 Ansluta skrivaren till strömförsörjningen



! VARNING

Risk för dödsfall eller allvarlig personskada till följd av elektrisk stöt

Kontakt med strömförande delar kan leda till dödsfall eller personskada.

- 1 Använd endast en godkänd METTLER TOLEDO nätadapter med strömbegränsning i form av ett SELV-uttag.
- 2 Anslut strömkabeln till ett jordat vägguttag och kontrollera att polariteten är korrekt.
- 3 Håll alla elkablar och anslutningar på avstånd från vätskor och fukt.
- 4 Kontrollera kablar och kontakter med avseende på skador och byt ut eventuella skadade kablar och kontakter.



OBS

Risk för skada på nätadaptern på grund av överhettning

Om nätadaptern är övertäckt eller ligger i en behållare kommer den att överhettas.

- 1 Täck inte över nätadaptern.
- 2 Placera inte nätadaptern i en behållare.

Skrivaren levereras med en universalnätadapter eller en nätadapter med en landsspecifik strömkabel.

- Led kablarna så att de inte kan komma till skada eller störa användningen av vågen.
 - Anslut strömkabeln till ett lättillgängligt jordat vägguttag.
- 1 Anslut nätadaptern till uttaget på baksidan av skrivaren.
 - 2 Spänn fast kontakten med skruvmuttern.
 - 3 Anslut den jordade trestiftsströmkabeln till uttaget för nätadaptern.
 - 4 Koppla samman skrivaren och vågen med hjälp av gränssnittskabeln.
 - 5 Starta vågen.
 - 6 Anslut skrivaren till strömförsörjningen.
 - 7 Starta skrivaren med **I/O**-brytaren.

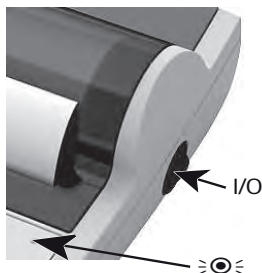

Anteckning

Endast RS232-gränssnitt: kontrolllampan blinkar tills ett instrument ansluts. Om lampan fortsätter att blinka ska du titta i avsnittet "Felsökning" i referensmanualen.

2.3 Sätta i papper

- 1 Ta bort pappersskyddet (dra på baksidan) (1).
- 2 För in den roterande pappersaxeln i mitten av pappersrullen (2).
- 3 Mata in papper genom spåret i utskriftsenheten i pilens riktning (3).
- 4 Håll knappen intryckt tills en tillräcklig mängd papper har matats in (4).
- 5 För papret genom pappersskyddsspåret.
- 6 Sätt tillbaka pappersskyddet (1).

Om anslutningsinställningarna (baudhastighet, bit, handskakning) för vågen ändras efter de första utskrifterna måste skrivaren startas om. Tryck av och därefter på för att starta den automatiska baudhastighetsavkänningen igen. Funktionen för automatisk baudhastighet kan stängas av.

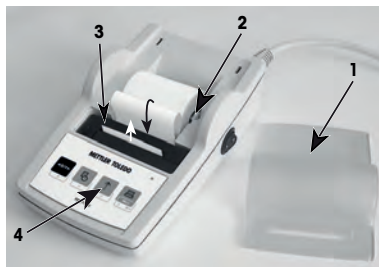

3 Knappfunktioner











Skrivare P25

Driftsnivå	Tryck snabbt	Håll nedtryckt
	enlinjematning	kontinuerlig matning (fills knappen släpps upp)
 	Skrivartest med utskrift av inställningar	öppna meny
Menynivå	Tryck snabbt	Håll nedtryckt
	nästa menyobjekt	lagra

Skrivare P26

Driftsnivå	Tryck snabbt	Håll nedtryckt
	nolla/tarera vågen	–
	skriv ut datum och tid	–
	enlinjematning	kontinuerlig matning (fills knappen släpps upp)
	skriva ut	öppna meny
Menynivå	Tryck snabbt	Håll nedtryckt
		lagra
avsluta	ned	
	upp	
	nästa	

Skrivare P28

Driftsnivå		Tryck snabbt	Håll nedtryckt
	nolla/tarera vågen	—	—
	skriv ut datum och tid	—	—
	enlinjematning	kontinuerlig matning (fills knappen släpps upp)	
	skriva ut	öppna menyn	
Menynivå		Tryck snabbt	Håll nedtryckt
	avsluta	 ned	 upp
		 nästa	 lagra
Funktionsnivå		Tryck snabbt	Håll nedtryckt
	Starta tillämpning för summering	Avsluta tillämpning för summering	
	Starta tillämpning för statistik	Avsluta tillämpning för statistik	

4 Meny

4.1 Skrivare P25

Tryck snabbt	Håll nedtryckt	Utskrift
<div style="border: 1px solid black; padding: 2px; text-align: center;">Settings</div> <div style="border: 1px solid black; padding: 2px; text-align: center;">Reset</div>		Settings Reset
<div style="border: 1px solid black; padding: 2px; text-align: center;">Återställ skrivaren</div>		<pre>----- Reset done ----- Current settings: Baudrate: 9600 Bit/Parity: 8 Bit Non Handshake: Off Char Set: IBM/DOS</pre>
<div style="border: 1px dashed gray; padding: 2px; text-align: center;">Endast RS232-gränssnitt</div> <div style="border: 1px solid black; padding: 2px; text-align: center;">Auto Baudrate</div> <div style="border: 1px solid black; padding: 2px; text-align: center;">On</div>	Lagra	<pre>Auto Baudrate: On -----STORED----- ... "current settings"</pre>
<div style="border: 1px solid black; padding: 2px; text-align: center;">Auto Baudrate</div> <div style="border: 1px solid black; padding: 2px; text-align: center;">Off</div>	Lagra	<pre>Auto Baudrate: Off -----STORED----- ... "current settings"</pre>
<div style="border: 1px solid black; padding: 2px; text-align: center;">Char Set</div> <div style="border: 1px solid black; padding: 2px; text-align: center;">IBM / DOS</div>	Lagra	<pre>IBM/DOS -----STORED----- ... "current settings"</pre>
<div style="border: 1px solid black; padding: 2px; text-align: center;">IBM / DOS</div> <div style="border: 1px solid black; padding: 2px; text-align: center;">Cyrillic</div>	Lagra	<pre>IBM/DOS Cyrillic -----STORED----- ... "current settings"</pre>
<div style="border: 1px solid black; padding: 2px; text-align: center;">IBM / DOS</div> <div style="border: 1px solid black; padding: 2px; text-align: center;">Japanese</div>	Lagra	<pre>IBM/DOS Japanese -----STORED----- ... "current settings"</pre>
<div style="border: 1px solid black; padding: 2px; text-align: center;">ANSI / WIN</div> <div style="border: 1px solid black; padding: 2px; text-align: center;">Latin 1</div>	Lagra	<pre>ANSI/WIN Latin 1 -----STORED----- ... "current settings"</pre>
<div style="border: 1px solid black; padding: 2px; text-align: center;">ANSI / WIN</div> <div style="border: 1px solid black; padding: 2px; text-align: center;">Cyrillic</div>	Lagra	<pre>ANSI/WIN Cyrillic -----STORED----- ... "current settings"</pre>
<div style="border: 1px solid black; padding: 2px; text-align: center;">ANSI / WIN</div> <div style="border: 1px solid black; padding: 2px; text-align: center;">Japanese</div>	Lagra	<pre>ANSI/WIN Japanese -----STORED----- ... "current settings"</pre>
<div style="border: 1px solid black; padding: 2px; text-align: center;">Balance Feature</div> <div style="border: 1px solid black; padding: 2px; text-align: center;">Enable</div>	Lagra	<pre>Balance Feature: Enable -----STORED----- ... "current settings"</pre>
<div style="border: 1px solid black; padding: 2px; text-align: center;">Balance Feature</div> <div style="border: 1px solid black; padding: 2px; text-align: center;">Disable</div>	Lagra	<pre>Balance Feature: Disable -----STORED----- ... "current settings"</pre>

Menyalternativ
Fabriksinställning

4.2 Skrivare P26/P28

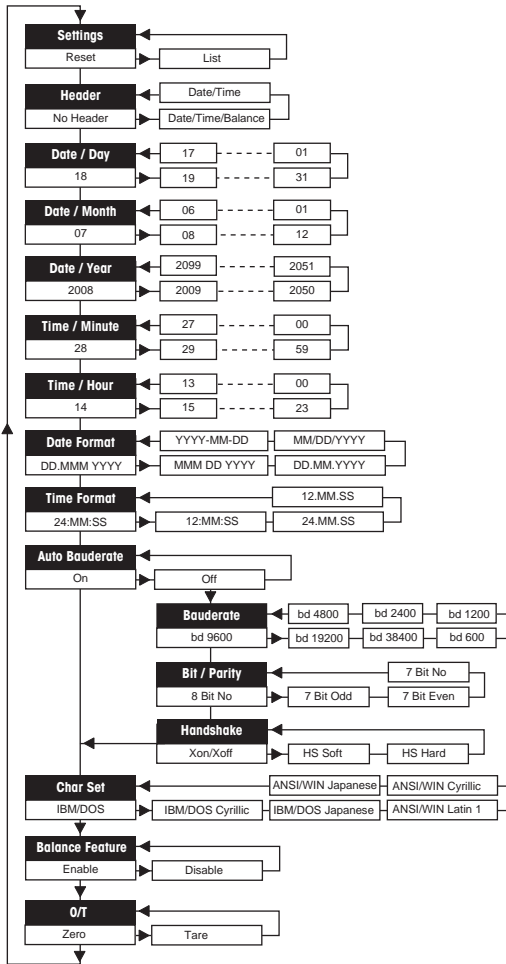

Exempel om vågens display används:





Inställningar		
Reset		rESEt
List		L 15t
Rubrik		
*No Header		no Hdr
Date/Time		d t Hdr
Date/Time/Balance		dtb Hdr
Datum dag**		
18		dAY 18
Datum månad**		
07		month 07
Datum år**		
2008		YEAR 2008
Tid minuter**		
28		in. 28
Tid timmar**		
14		hour 14
Datumformat***		
DD.MMM.YYYY		ddmmY
MMM DD.YYYY		mm dd Y
DD.MM.YYYY		ddmmY
MM/DD/YYYY		mm dd Y
YYYY-MM-DD		Y-mm-dd
Tidsformat***		
24:MM:SS		24:mm:ss
12:MM:SS		12:mm:ss
24.MM.SS		24mmSS
12.MM.SS		12mmSS
Baudhastighet		
*9600		bd9600
19200		bd 19200
38400		bd38400
600		bd600
1200		bd 1200
2400		bd2400
4800		bd4800
Bit/paritet		
*8 Bit No		8b-no
7 Bit Odd		7b-odd
7 Bit Even		7b-E
7 Bit No		7b-no
Handskakning		
*Xon/Xoff		HS oFF
HS Soft		HS SoFt
HS Hard		HS HArD
Teckenuppsättning		
*IBM/DOS		d05
IBM/DOS Cyrillic		d05 C4r
IBM/DOS Japanese		d05 JAP
Ansi/Win Latin 1		11 in LAt
Ansi/Win Cyrillic		11 in C4r
Ansi/Win Japanese		11 in JAP
Tarering/nollning		
*Zero		ZEr-o
Tare		tAr-E

Menyalternativ
Fabriksinställning

- * fabriksinställningar
- ** instrument med inbyggd klocka: inte tillämpligt, den inbyggda klockan har prioritet
- *** instrument med inbyggd klocka: skrivarformatet har prioritet

Exempel på hur man ställer in dagens datum (endast P26/P28)

Öppna menyn

- Håll knappen  intryckt tills **Reset** (återställ) visas.
- Välj menyalternativet **Day** (datum) med knappen .
- Välj datum, t.ex. 21.
Bläddra uppåt med knappen .
Bläddra nedåt med knappen .



Spara inställningarna

- Håll knappen  nedtryckt tills **Stored** (lagrad) visas.

Tillämpning för statistik (endast P28)



Provvikten måste vara inom 70–130 % av det aktuella genomsnittsvärdet.
Minsta dynamiska viktändring måste vara 100 d.

- 1 Tryck på  för att starta tillämpningen för statistik (lysdioden tänds).
- 2 Lägg till ett nytt prov och tryck på **M+**.
- 3 Tryck vid behov på  för att skriva ut totalsumman.
- 4 Håll  intryckt för att skriva ut och avsluta tillämpningen för statistik (lysdioden släcks).



Anteckning

- Det är inte tillåtet att göra enhetsändringar medan tillämpningen är igång.
- Max. 999 prover.

Tillämpning för summering (endast P28)



Minimivikter + 1 d.

- 1 Tryck på  för att starta tillämpningen för summering (lysdioden tänds).
- 2 Lägg till ett nytt prov och tryck på **M+**.
- 3 Tryck vid behov på  för att skriva ut totalsumman.
- 4 Håll  intryckt för att skriva ut och avsluta tillämpningen för summering (lysdioden släcks).

Anteckning

- Det är inte tillåtet att göra enhetsändringar medan tillämpningen är igång.
- Max. 999 prover.

5 Underhåll



VARNING

Risk för dödsfall eller allvarlig personskada till följd av elektrisk stöt

Kontakt med strömförande delar kan leda till personskada eller dödsfall.

- 1 Dra ut kontakten till skrivaren före rengöring och underhåll.
- 2 Se till att ingen vätska kan tränga in i skrivaren eller nätadaptorn.

5.1 Byta ut pappersrullen

I avsnittet [Sätta i papper ▶ sidan 128] finns en beskrivning av hur man sätter i en ny pappersrulle. Ordernumret för pappersrullen finns i avsnittet [Förbrukningsmaterial ▶ sidan 136].

Anteckning

Den roterande pappersaxeln måste alltid flyttas över från den gamla pappersrullen till den nya.

5.2 Byta ut färgbandet

Ordernumret för färgbandskassetten finns i avsnittet [Förbrukningsmaterial ▶ sidan 136].

- 1 Ta bort pappersskyddet (1).
- 2 Dra ut papper ur utskriftsenhet (2).



- 3 Byt ut färgbandshållaren genom att trycka i pilens riktning (3).
- 4 Sätt i den nya färgbandshållaren. Spänn vid behov färgbandet med hjälp av spännhjulet (4).

I avsnittet [Sätta in papper ▶ sidan 128] finns en beskrivning av hur man sätter in en ny pappersrulle.



5.3 Rengöra armaturen

Eftersom skrivarens hölje är tillverkat av högklassiga, beständiga material, kan alla typer av milda rengöringsmedel på marknaden användas.



OBS

Skada på skrivaren på grund av felaktiga rengöringsmetoder

Skrivaren är tillverkad av högkvalitativa, beständiga material och kan skadas vid användning av vissa typer av rengöringsmedel, lösningsmedel eller slipmedel. Om vätska kommer in i höljet kan skrivaren skadas.

- 1 Använd vatten och ett mildt rengöringsmedel för att rengöra skrivaren.
- 2 Torka omedelbart bort eventuellt spill.
- 3 Se till att ingen vätska kan tränga in i skrivaren.

Kontakta en METTLER TOLEDO -representant för att ta reda på vilka servicealternativ som finns att välja mellan. Regelbundet underhåll som utförs av en behörig servicetekniker ger garanterad konsekvent vägningsexakthet på lång sikt och ökad livslängd för skrivaren.

6 Tekniska uppgifter

6.1 Allmänna tekniska uppgifter

Strömförsörjning

Nätadapter:

Primär: 100–240 V, 50/60 Hz

Sekundär: 12 V DC, 2,5 A (med elektroniskt överbelastnings-skydd)

Kabel för nätadapter:

Tre ledare, med landsspecifik kontakt

Polaritet:

⊖ ⊕ med SELV-utström (Safety Extra Low Voltage)

Kraffledningsspänning:

12 V DC

Strömuttag:

Max. 2,5 A

Skydd och standarder

Överspänningskategori:

II

Föroreningsgrad:

2

Standarder för säkerhet och EMC:

Se Försäkran om överensstämmelse

Användningsområde:

Får endast användas i slutna inomhusmiljöer

Miljöförhållanden

Höjd över havsytans medelnivå:

Upp till 4 000 m

Omgivande temperatur:

0 till 40 °C

Förvaringsmiljö:

-25 till 60 °C

Relativ luftfuktighet:

max. 80 % upp till 31 °C, linjärt minskande till 50 % vid 40 °C, icke-kondenserande

Skrivarens funktioner

Utskriftsteknik:

Punktmatrisskrivare 5 x 7, 24 tecken per rad

Utskriftshastighet:

2,3 rader per sekund

Färgbandshållare:

utbytbar, svart

Pappersrulle:

Standardpapper 57,5 mm x ø 50 till 60 mm, integrerat i höljet, handelsstorlek

Utskriftskvalitet:

ljusbeständig och termostabil utskrift (GLP, GMP, ISO 9001)

Gränssnitt: RS-P25, RS-P26,
RS-P28

RS232C

USB-P25

USB

Kompatibilitetsbegränsningar:

- Datum-/tidsfunktion: inte tillämpligt för vågar med inbyggd klocka (den inbyggda klockan har prioritet)
- Nollnings-/tareringsfunktion: inte tillämpligt för alla vågmodeller

Mått/vikt

Skrivarmått (B x D x H)

120 x 203 x 73 mm

Förpackningsmått (B x D x H):

255 x 205 x 150 mm

Nettovikt:

740 g (inkl. pappersrulle)

7 Förbrukningsmaterial

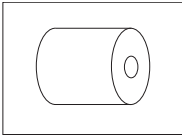
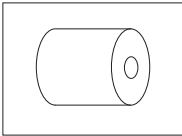
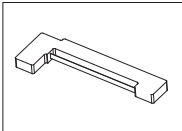
Beskrivning	Artikelnr	
 A simple line drawing of a roll of paper, showing the cylindrical shape and a small circle on the end face representing the core.	Pappersrulle (längd: 20 m), set om 5 st	00072456
 A simple line drawing of a roll of paper, showing the cylindrical shape and a small circle on the end face representing the core.	Pappersrulle (längd: 13 m), självhäftande, set om 3 st	11600388
 A line drawing of a color ribbon cassette, showing its L-shaped profile and the internal structure of the ribbon.	Färgbandskasset, svart, set om 2 st	00065975

1 Güvenlik Bilgileri

Bu enstrüman için "Kullanım Kılavuzu" ve "Kullanım Talimatları" adlı iki belge mevcuttur.

- Kullanım Kılavuzunda enstrümanı nasıl kullanmaya başlayacağınız gösterilmektedir.
- Kullanım Talimatlarında ise enstrümana ve kullanımına dair ayrıntılı bir açıklama bulunur.
- İki belgeyi de ileride başvurabilmek için saklayın.
- Enstrümanı başkalarına verirken beraberinde bu belgeleri de verin.

Enstrümanı yalnızca Kullanım Kılavuzu ve Kullanım Talimatlarına göre kullanın. Enstrümanın bu belgelere uygun şekilde kullanılmaması veya üzerinde değişiklik yapılması durumunda, enstrümanın güvenliği olumsuz etkilenebilir ve Mettler-Toledo GmbH hiçbir yükümlülük kabul edilmez.

1.1 Daha fazla ilgili doküman



Bu Kullanım Kılavuzu, enstrümanın ilk adımlarının güvenli ve verimli bir şekilde gerçekleştirilmesi-ne ilişkin bilgi sağlayan kısa bir talimattır. Lütfen personelinizin ilk önce bu kılavuza dikkatli bir şekilde okuması ve anlamasını sağlayınız.

Tam bilgi için, her zaman Referans Kılavuza (RM) başvurabilirsiniz.

► www.mt.com/printer-p-20-RM

1.2 Uyarı kelimeleri ve sembollerinin tanımları

Güvenlik notları, güvenlik konuları hakkında önemli bilgiler içerir. Güvenlik notlarını dikkate almamak kişisel yaralanmalara, enstrümanda hasara, arızalara ve yanlış sonuçlara neden olabilir. Güvenlik notları aşağıdaki uyarı işaret ve sembolleriyle belirtilmiştir:

İkaz sözcükleri

UYARI Kaçınılmadığı takdirde muhtemelen ölüme veya ciddi yaralanmalara neden olabilecek, orta risk seviyesinde tehlikeli bir durum.

DİKKAT Kaçınılmadığı takdirde küçük veya orta düzeyde yaralanmalara neden olabilecek orta risk seviyesinde tehlikeli bir durum.

DUYURU Kaçınılmadığı takdirde enstrümana hasar verebilecek veya başka maddi zarar, arıza ve hatalı sonuçlar veya veri kaybına yol açan düşük risk seviyesinde tehlikeli bir durum.

Uyarı sembolleri



Elektrik çarpması



Genel tehlike: tehlikeler ve bunlara ilişkin alınan önlemler hakkında bilgi almak için Kullanım Talimatlarını okuyun.



Bildirim

1.3 Ürüne özel güvenlik notları

Kullanım amacı

Bu enstrüman, analitik laboratuvarlarda kalifiye çalışanlar tarafından kullanılmak üzere tasarlanmıştır. Enstrüman, protokolü yazdırma işleminde kullanım amaçlıdır.

Yazılı izin olmaksızın, teknik özelliklerin sınırları dışında kalan her türlü kullanım ve çalıştırma biçimi, Mettler-Toledo GmbH amaç dışı olarak değerlendirilir.

Enstrüman sahibinin sorumlulukları

Enstrüman sahibi, enstrümanın kanuni mülkiyetine sahip olan ve enstrümanı kullanan, kullanması için yetkilendirilen ya da kanunen enstrümanın operatörü olarak kabul edilen kişidir. Enstrüman sahibi; tüm enstrüman kullanıcılarının ve üçüncü tarafların güvenliğinden sorumludur.

METTLER TOLEDO enstrüman sahibinin, enstrümanın iş yerinde güvenle kullanılması ve potansiyel tehlikelerle başa çıkılması için kullanıcılara eğitim verdiğini varsaymaktadır. METTLER TOLEDO enstrüman sahibinin gerekli koruyucu aletleri sağladığını varsaymaktadır.

Güvenlik notları



UYARI

Elektrik çarpması nedeniyle ölüm veya ciddi yaralanma

Yüklü akım taşıyan parçalarla temas, yaralanma ve ölüme yol açabilir.

- 1 Yalnızca onaylı METTLER TOLEDO güç kaynağını ve akım sınırlamalı SELV çıkışına sahip AC/DC adaptörünü kullanın.
- 2 Güç kablosunu topraklanmış bir güç çıkışına bağlayın, doğru polariteyi sağlayın.
- 3 Bütün elektrik kablolarını ve bağlantıları sıvılardan ve nemden uzak tutun.
- 4 Kablolarda ve elektrik prizinde hasar olup olmadığını kontrol edin ve hasarlı kablo ve elektrik prizlerini değiştirin.



DUYURU

Uygun olmayan parçaların kullanımından dolayı enstrümanda hasar

Enstrümanda uygun olmayan parçaların kullanılması enstrümana zarar verebilir veya işlevinin bozulmasına neden olabilir.

- Yalnızca enstrümanızla kullanılmak üzere tasarlanmış METTLER TOLEDO parçaları kullanın.

2 Kurulum ve Çalıştırmayı Başlatma

2.1 Teslimat kapsamı

- AC/DC adaptörü
- Elektrik kablosu (ülkeye göre değişir)
- Kullanım Kılavuzu
- Uygunluk bildirimini

2.2 Yazıcıyı güç kaynağına bağlama



! UYARI

Elektrik çarpması nedeniyle ölüm veya ciddi yaralanma

Yüklü akım taşıyan parçalarla temas, yaralanma ve ölüme yol açabilir.

- 1 Yalnızca onaylı METTLER TOLEDO güç kaynağını ve akım sınırlamalı SELV çıkışına sahip AC/DC adaptörünü kullanın.
- 2 Güç kablosunu topraklanmış bir güç çıkışına bağlayın, doğru polariteyi sağlayın.
- 3 Bütün elektrik kablolarını ve bağlantıları sıvılardan ve nemden uzak tutun.
- 4 Kablolarda ve elektrik prizinde hasar olup olmadığını kontrol edin ve hasarlı kablo ve elektrik prizlerini değiştirin.



DUYURU

Aşırı ısınma nedeniyle AC/DC adaptöründe hasar

AC/DC adaptörü örtülü veya bir kap içindeyse yeterince soğumaz ve aşırı ısınır.

- 1 AC/DC adaptörünün üstünü örtmeyin.
- 2 AC/DC adaptörünü kap içine koymayın.

Bu yazıcı, evrensel bir AC/DC adaptörü veya ülkeye özel güç kablosuna sahip bir AC/DC adaptörü ile tedarik edilir.

- Kabloları hasar görmeyecek veya çalışma sırasında sorun teşkil etmeyecek şekilde kurun.
- Güç kablosunu kolay erişilebilir topraklanmış bir güç çıkışına takın.

- 1 AC/DC adaptörünü yazıcının arkasındaki bağlantı soketine bağlayın.
- 2 Cıvata somunuyla konektörü kilitleyin.
- 3 3 pimli topraklı elektrik kablosunu AC/DC adaptörü için olan sokete bağlayın.
- 4 Yazıcı ve teraziye arabirim kablosuyla bağlayın.
- 5 Teraziyi açın.
- 6 Yazıcıyı güç kaynağına bağlayın.
- 7 I/O anahtarı ile yazıcıyı açın.

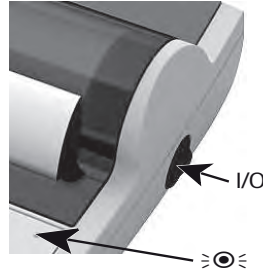

Not

Yalnızca RS232 arabirimi: Enstrüman bağlanana kadar pilot lamba yanıp sönecektir. Lamba hala yanıp sönüyorsa Referans Kılavuzdaki "Sorun Giderme" bölümünü kontrol edin.

2.3 Kağıdı yerleştirme

- 1 Kağıt kapağını (arkadan çekerek) (1) çıkarın.
- 2 Kağıt döner eksenini kağıt rulusunun merkezinden (2) geçirin.
- 3 Kağıdı yazdırma ünitesindeki yuvadan ok yönünde (3) besleyin.
- 4 Yeterli kağıt beslemesi gerçekleşene kadar basılı tutun (4).
- 5 Kağıdı kağıt kapağı yuvasından geçirin.
- 6 Kağıt kapağını (1) yerleştirin.





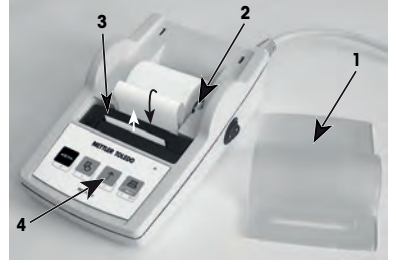



İlk çıktıdan sonra terazinin bağlantı ayarları (Baud Hızı, Bit, Mutabakat) değişirse yazıcının yeniden başlatılması gerekir.

Otomatik Baud hızı algılamasını yeniden başlatmak için kapatıp açın. Otomatik Baud hızı kapatılabilir.















3 Tuş İşlevleri











Yazıcı P25

Çalışma düzeyi	 Kısa süreli basın	 Basılı tutun
	tek satır besleme	sürekli besleme (çıkana kadar)
 +  On	Ayar çıkışı ile yazıcı testi	menüyü açma
Menü düzeyi	 Kısa süreli basın	 Basılı tutun
	sonraki menü ögesi	depolama

Yazıcı P26

Çalışma düzeyi	 Kısa süreli basın	 Basılı tutun		
	terazinin sıfırlanması / darasının alınması	–		
	Tarih ve Saat yazdırma	–		
	tek satır besleme	sürekli besleme (çıkana kadar)		
	yazdırma	menüyü açma		
Menü düzeyi	 Kısa süreli basın	 Basılı tutun		
 çıkış	 aşağı	 yukarı	 ileri	 depolama

Yazıcı P28

Çalışma düzeyi	Kısa süreli basın	Basılı tutun
	terazinin sıfırlanması / darasının alınması	–
	Tarih ve Saat yazdırma	–
	tek satır besleme	sürekli besleme (çıkana kadar)
	yazdırma	menüyü açma
Menü düzeyi	Kısa süreli basın	Basılı tutun
 çıkış	 aşağı	 yukarı
	 ileri	 depolama
İşlev düzeyi	Kısa süreli basın	Basılı tutun
 M+	Toplama uygulamasını başlatma	Toplama uygulamasını sonlandırma
 M+	İstatistik uygulamasını başlatma	İstatistik uygulamasını sonlandırma

4 Menü

4.1 Yazıcı P25

Kısa süreli basın	Basılı tutun	Yazıcı çıktısı
Settings Reset		Settings Reset
Yalnızca RS232 arabirimi	Yazıcıyı sıfırlama	----- Reset done ----- Current settings: Baudrate: 9600 Bit/Parity: 8 Bit Non Handshake: Off Char Set: IBM/DOS
Auto Baudrate On	Depolama	Auto Baudrate: On -----STORED----- ..."current settings"
Auto Baudrate Off	Depolama	Auto Baudrate: Off -----STORED----- ..."current settings"
Char Set IBM / DOS	Depolama	IBM/DOS -----STORED----- ..."current settings"
IBM / DOS Cyrillic	Depolama	IBM/DOS Cyrillic -----STORED----- ..."current settings"
IBM / DOS Japanese	Depolama	IBM/DOS Japanese -----STORED----- ..."current settings"
ANSI / WIN Latin 1	Depolama	ANSI/WIN Latin 1 -----STORED----- ..."current settings"
ANSI / WIN Cyrillic	Depolama	ANSI/WIN Cyrillic -----STORED----- ..."current settings"
ANSI / WIN Japanese	Depolama	ANSI/WIN Japanese -----STORED----- ..."current settings"
Balance Feature Enable	Depolama	Balance Feature: Enable -----STORED----- ..."current settings"
Balance Feature Disable	Depolama	Balance Feature: Disable -----STORED----- ..."current settings"
Menü Seçeneği Fabrika Ayarı		

4.2 Yazıcı P26/P28

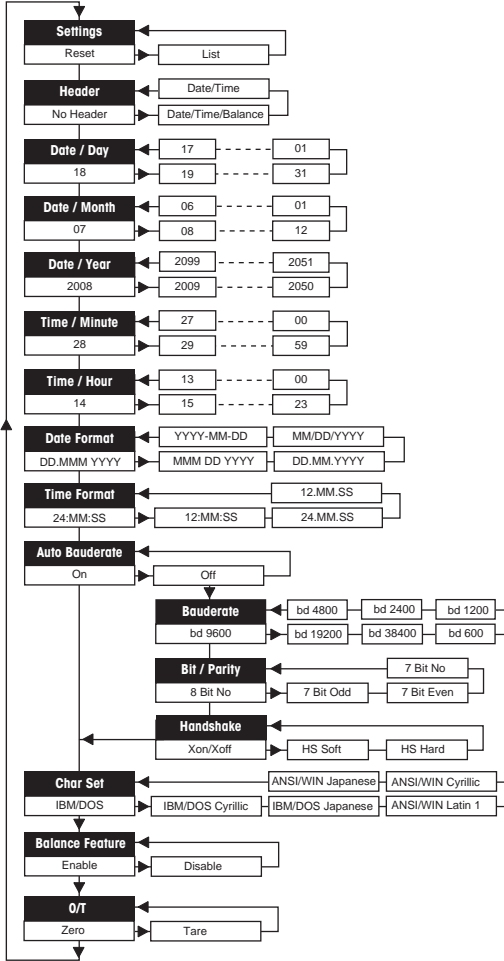

Terazi ekranı kullanımına dair örnekler:



Ayarlar	
Reset	rESEt
List	L 15t
Hacim başlığı	
*No Header	no Hdr
Date/Time	d t Hdr
Date/Time/Balance	dtb Hdr
Gün**	
18	dRY 18
Ay**	
07	month 07
Yıl**	
2008	YEAR 2008
Dakika**	
28	n in. 28
Saat**	
14	Hour 14
Tarih Biçimi***	
DD.MMM.YYYY	ddmmn y
MMM DD YYYY	mmn dd y
DD.MM.YYYY	ddmm.y
MM/DD/YYYY	mm ddd yy
YYYY-MM-DD	y-mm-dd
Saat Biçimi***	
24:MM:SS	24:nn:ss
12:MM:SS	12:nn:ss
24.MM.SS	24nn.ss
12.MM.SS	12nn.ss
Baud hızı	
*9600	bd9600
19200	bd 19200
38400	bd38400
600	bd600
1200	bd 1200
2400	bd2400
4800	bd4800
Bit/Eşlik Oranı	
*8 Bit No	8b-no
7 Bit Odd	7b-odd
7 Bit Even	7b-E
7 Bit No	7b-no
Mutabakat	
*Xon/Xoff	HS oFF
HS Soft	HS 5oFt
HS Hard	HS HRRd
Karakter Seti	
*IBM/DOS	d05
IBM/DOS Cyrillic	d05 C4r
IBM/DOS Japanese	d05 JRP
Ansi/Win Latin 1	11 in LARt
Ansi/Win Cyrillic	11 in C4r
Ansi/Win Japanese	11 in JRP
Dara Alma/ Sıfırlama	
*Zero	ZEro
Tare	tAR-E

Menü Seçeneği
Fabrika Ayarı

- * Fabrika ayarları
 ** **dahili saatli enstrümanlar:** Geçerli değildir, dahili saat önceliklidir
 *** **dahili saatli enstrümanlar:** Yazıcı formatı önceliklidir

Gün ayarı örneği (yalnızca P26/P28)

Menüyü açma

- **Sıfırla** yazısı görünene kadar  tuşuna basılı tutun.
-  tuşu ile **Gün** menü seçeneğini seçin.
- Günü seçin, örneğin 21.
↑ tuşunu yukarı kaydırın.
↓ tuşunu aşağı kaydırın.



Ayarları kaydetme

- **Kaydedildi** yazısı görünene kadar  tuşuna basılı tutun.

İstatistik uygulaması (yalnızca P28)



Numune ağırlık, geçerli ortalama değerin %70-130 aralığında olmalıdır.
Değiştirilen minimum dinamik ağırlık 100 d olmalıdır.

- 1 İstatistik uygulamasını başlatmak için  tuşuna basın (LED açık).
- 2 Yeni bir numune ekleyin ve **M+** tuşuna basın.
- 3 Gerekirse ara toplamın çıktısını almak için  tuşuna basın.
- 4 İstatistik uygulamasını yazdırmak ve sonlandırmak için  tuşuna basılı tutun (LED kapalı).



Not

- Uygulama sırasında birim değişikliğine izin verilmez.
- Maksimum 999 numune.

Toplama uygulaması (yalnızca P28)



Minimum ağırlıklar + 1 d.

- 1 Toplama uygulamasını başlatmak için  tuşuna basın (LED açık).
- 2 Yeni bir numune ekleyin ve **M+** tuşuna basın.
- 3 Gerekirse ara toplamın çıktısını almak için  tuşuna basın.
- 4 Toplama uygulamasını yazdırmak ve sonlandırmak için  tuşuna basılı tutun (LED kapalı).

Not

- Uygulama sırasında birim değişikliğine izin verilmez.
- Maksimum 999 numune.

5 Bakım



⚠ UYARI

Elektrik çarpması nedeniyle ölüm veya ciddi yaralanma

Yükü akım taşıyan parçalarla temas, yaralanma ve ölüme yol açabilir.

- 1 Temizlik ve bakım öncesinde yazıcı ile güç kaynağı arasındaki bağlantıyı kesin.
- 2 Yazıcı veya AC/DC adaptörüne sıvı girişini önleyin.

5.1 Kağıt rulosunu değiştirme

Yeni kağıt rulosunun yerleştirilmesi [Kağıdı yerleştirme ▶ sayfa 140] bölümünde açıklanmıştır. Kağıt rulosunun sipariş numarasına [Sarf Malzemeler ▶ sayfa 148] bölümünden ulaşılabilir.

Not

Kağıt döner eksenini her zaman eski kağıt rulosundan yeni ruloa aktarılmalıdır.

5.2 Şeridi deęiřtirme

Şerit kartuşun sipariř numarasına [Sarf Malzemeler ▶ sayfa 148] bölümünden ulařılabilir.

- 1 Kağıt kapađını (1) çıkarın.
- 2 Kağıdı yazdırma ünitesinden (2) çekin.



- 3 Ok yönünde basarak (3) řerit kartuşu çıkarın.
- 4 Yeni řerit kartuşu takın. Gerekirse gerdirme tekerleđi (4) ile gevřetin.

Yeni kağıt rulusunun yerleřtirilmesi [Kağıdı yerleřtirme ▶ sayfa 140] bölümünde açıklanmıřtır.



5.3 Muhafazanın temizlenmesi

Yazıcı muhafazası yüksek kaliteli ve dayanıklı malzemelerden üretildiđi için piyasada satılan hafif temizlik maddeleri kullanılabilir.



DUYURU

Uygun olmayan temizlik yöntemleri nedeniyle yazıcının zarar görmesi

Yazıcı muhafazası yüksek kaliteli ve dayanıklı malzemelerden üretilmiřtir ve belli temizlik maddeleri, çözücüler veya aşındırıcılar nedeniyle zarar görebilir. Muhafaza bölümüne giren herhangi bir sıvı, yazıcıda hasar oluşturabilir.

- 1 Yazıcıyı temizlemek için yalnızca su ve hafif bir deterjan kullanın.
- 2 Herhangi bir dökülme durumunda derhal silin.
- 3 Yazıcının içine sıvı giriřini önleyin.

Mevcut servis seçenekleri hakkında daha fazla bilgi için bir METTLER TOLEDO temsilciyle iletiřime geçin. Yetkili servis mühendisi tarafından sađılanak düzenli servis hizmeti, uzun vadede istikrarlı bir tartım dođruluđu sađlayacak ve enstrümanın hizmet ömrünü uzatacaktır.

6 Teknik Veriler

6.1 Genel teknik veriler

Güç kaynağı

AC/DC adaptörü:

Birincil: 100 – 240 V, 50/60 Hz

İkincil: 12 V DC, 2,5 A (elektronik aşırı yük korumalı)

AC/DC adaptör kablosu:

3 telli, ülkeye özel fişi

Polarite:

⊖ ⊕ akım sınırlı SELV (Güvenlik Ekstra Düşük Voltaj) çıkışı ile

Güç hattı voltajı:

12 V DC

Güç tüketimi:

Maks. 2.5 A

Koruma ve standartlar

Aşırı voltaj kategorisi:

II

Kirlenme derecesi:

2

Güvenlik ve EMC standartları:

Uygunluk Beyanı'na bakın

Uygulama aralığı:

Sadece kapalı iç mekanlarda kullanım içindir

Çevresel koşullar

Ortalama deniz seviyesinden yükseklik:

4000 m'ye kadar

Ortam sıcaklığı:

0 ila 40 °C

Depolama koşulu:

-25 ila 60 °C

Bağıllı hava nemi:

31°C'ye kadar maksimum %80 yoğuşmasız, 40°C'de doğrusal olarak %50'ye düşer

Yazıcı özellikleri

Yazdırma teknolojisi:

Nokta vuruşlu yazıcı 5 x 7, 24 karakter satır uzunluğu

Yazdırma hızı:

Saniyede 2,3 satır

Şerit kartuş:

Değiştirilebilir, siyah

Kağıt rulosu:

Standart kağıt 57,5 mm x ø 50 ila 60 mm, muhafazaya entegre, ticari boyut

Yazdırma kalitesi:

Işığa karşı dayanıklı ve ısı olarak stabil yazdırma (GLP, GMP, ISO 9001)

Arabirimler: RS-P25, RS-P26,
RS-P28
USB-P25

RS232C

USB

Uyumluluk sınırları:

- Saat / Tarih İşlevi: Dahili saate sahip terazilerde geçerli değildir (dahili saat önceliklidir)
- Sıfırlama / Darasını Alma İşlevi: Tüm terazi modellerinde geçerli değildir

Boyut / ağırlık

Yazıcının boyutları (G x D x Y):

120 x 203 x 73 mm

Paket boyutları (G x D x Y):

255 x 205 x 150 mm

Net ağırlık:

740 g (kağıt rulosu dahil)

7 Sarf Malzemeler

Açıklama

Parça No.

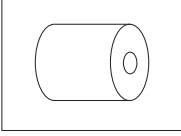

Kağıt rulosu (uzunluk: 20 m), 5 parçalık set

00072456

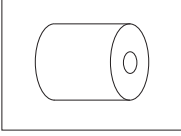

Kağıt rulosu (uzunluk: 13 m), kendinden yapışkanlı, 3 parçalık set

11600388

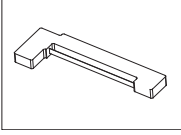

Şerit kartuş, siyah, 2 parçalık set

00065975

1 안전 정보

제목이 "사용자 매뉴얼" 및 "사용자 설명서"인 두 문서를 이 장비에서 사용할 수 있습니다.

- 사용자 매뉴얼은 장비 사용 시작 방법을 설명합니다.
- 사용자 설명서에는 장비 및 사용법에 대한 모든 설명이 포함되어 있습니다.
- 나중에 참조할 수 있도록 두 문서를 보관하십시오.
- 장비를 타인에게 양도하는 경우 두 문서를 함께 제공하십시오.

사용자 매뉴얼 및 사용자 설명서에 따라 장비를 사용해야 합니다. 이러한 문서를 따라 장비를 사용하지 않거나 장비가 수정된 경우 장비 안전에 문제가 발생할 수 있으며 Mettler-Toledo GmbH 당사는 이에 책임을 지지 않습니다.

1.1 추가 해당 문서



본 사용자 매뉴얼은 장치를 처음 시작할 때 안전하고 효과적으로 사용할 수 있도록 다루는 방법에 대한 간략한 정보를 제공합니다. 직원은 어떠한 작업이든 수행하기 전에 이 매뉴얼을 자세히 읽고 숙지해야 합니다.

전체 정보와 관련해 참조 매뉴얼(RM)을 참조하십시오.

▶ www.mt.com/printer-p-20-RM

1.2 신호어 및 경고 기호 정의

안전 경고에는 안전 문제에 대한 중요한 정보가 포함되어 있습니다. 안전 경고를 무시하면 상해, 저울 손상, 오작동 및 결과 오류가 발생할 수 있습니다. 안전 경고를 나타내는 신호어 및 경고 기호는 다음과 같습니다.

신호어

- 경고** 방지되지 않는 경우 사망이나 중상에 이를 수 있는 중간 위험 수준의 위험 상황입니다.
- 주의** 방지되지 않는 경우 경미하거나 중간 수준의 부상이 발생할 수 있는 낮은 위험 수준의 위험 상황입니다.
- 주의 사항** 기기, 기타 소재 손상, 오작동 및 부정확한 결과 또는 데이터 손실이 발생할 수 있는 낮은 위험 수준의 위험 상황입니다.

경고 기호



전기 충격



일반 위험: 위험 및 결과 조치 관련 정보에 대한 사용자 설명서를 읽어보십시오.



참고

1.3 제품별 안전성 참고

용도

이 장비는 교육을 받은 인력이 실험실에서 사용하도록 설계되었습니다. 이 장비는 프로토콜 인쇄용입니다.

메틀러 토레도의 서면 동의 없이 기술 규격 한계를 초과하는 모든 다른 모든 유형의 사용 및 작동은 Mettler-Toledo GmbH 본 제품의 용도에 적합하지 않은 것으로 간주됩니다.

장비 소유자의 책임

장비 소유자는 장비에 대한 법적 권한을 가지며 장비를 사용하거나 타인이 사용하도록 승인하는 사람 또는 법에 의해 장비 작동자로 간주되는 사람입니다. 장비 소유자는 장비의 모든 사용자 및 제3자의 안전에 대한 책임이 있습니다.

METTLER TOLEDO 장비 소유자는 장비 사용자에게 작업장에서의 안전한 장비 사용과 잠재적인 위험 처리에 관한 교육을 제공하는 것으로 간주됩니다. METTLER TOLEDO 장비 소유자는 필요한 보호 장구를 제공하는 것으로 간주됩니다.

안전 참고사항



⚠ 경고

감전으로 인한 사망 또는 심각한 부상

전류가 흐르는 부품에 접촉하면 부상 또는 사망에 이를 수 있습니다.

- 1 전류 제한 SELV 출력을 갖춘 승인된 METTLER TOLEDO 전원 공급 케이블 및 AC/DC 어댑터만 사용하십시오.
- 2 전원 케이블을 접지된 전원 콘센트에 연결하십시오. 극성이 올바른지 확인하십시오.
- 3 모든 전기 케이블과 연결부를 액체와 습기로부터 멀리 하십시오.
- 4 케이블 및 전원 플러그 손상 여부를 확인하고 손상된 케이블과 전원 플러그는 교체하십시오.



주의 사항

적합하지 않은 부품의 사용으로 인한 기기 손상

기기에 적합하지 않은 부품을 사용하면 기기 손상 또는 기기 오작동을 초래할 수 있습니다.

- 기기와 사용하도록 설계된 METTLER TOLEDO의 부품만 사용하십시오.

2 설치 및 운영

2.1 제품 구성

- AC/DC 어댑터
- 전원 케이블(국가별)
- 사용자 매뉴얼
- 적합성 선언

2.2 전원 공급 장치에 프린터 연결



⚠ 경고

감전으로 인한 사망 또는 심각한 부상

전류가 흐르는 부품에 접촉하면 부상 또는 사망에 이를 수 있습니다.

- 1 전류 제한 SELV 출력을 갖춘 승인된 METTLER TOLEDO 전원 공급 케이블 및 AC/DC 어댑터만 사용하십시오.
- 2 전원 케이블을 접지된 전원 콘센트에 연결하십시오. 극성이 올바른지 확인하십시오.
- 3 모든 전기 케이블과 연결부를 액체와 습기로부터 멀리 하십시오.
- 4 케이블 및 전원 플러그 손상 여부를 확인하고 손상된 케이블과 전원 플러그는 교체하십시오.



주의 사항

과열로 인한 AC/DC 어댑터의 손상

AC/DC 어댑터가 덮여있거나 컨테이너 내에 있는 경우, 충분히 냉각되지 않고 과열됩니다.

- 1 AC/DC 어댑터를 덮지 마십시오.
- 2 AC/DC 어댑터를 컨테이너에 넣지 마십시오.

프린터는 범용 AC/DC 어댑터 또는 국가별 전원 케이블이 포함된 AC/DC 어댑터와 함께 제공됩니다.

- 케이블이 손상되거나 작동에 방해가 되지 않도록 케이블을 설치합니다.
- 쉽게 접근할 수 있는 접지된 전원 콘센트에 전원 케이블을 삽입합니다.

- 1 AC/DC 어댑터를 프린터 후면의 연결 소켓에 연결합니다.
- 2 나사 너트를 사용해 커넥터를 고정합니다.
- 3 3핀 접지 전원 케이블을 AC/DC 어댑터용 소켓에 연결합니다.
- 4 인터페이스 케이블로 프린터 및 저울을 연결합니다.
- 5 저울을 켭니다.
- 6 전원 공급 장치에 프린터를 연결합니다.



7 I/O 스위치를 사용하여 프린터를 켭니다.

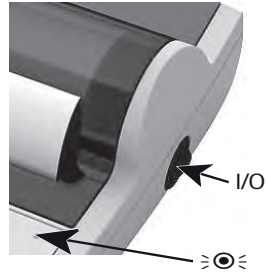

참고

RS232 인터페이스 전용: 장비가 연결될 때까지 파일럿 램프가 깜빡입니다. 램프가 계속해서 깜빡이면 참조 매뉴얼의 "문제 해결" 장을 확인하십시오.

2.3 용지 삽입





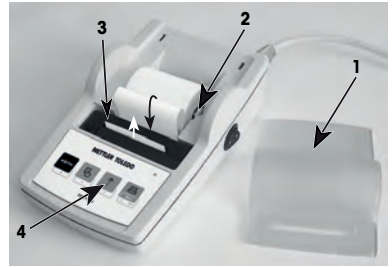



- 1 (뒷면을 당겨) 용지 커버(1)를 제거합니다.
- 2 용지 롤(2) 중앙을 따라 로터리 축을 삽입합니다.
- 3 인쇄 장치의 슬롯을 따라 화살표(3) 방향으로 용지를 공급합니다.
- 4 충분한 용지가 공급될 때까지 길게 누릅니다(4).
- 5 용지 커버 슬롯을 따라 용지를 투입합니다.
- 6 용지 커버(1)를 덮습니다.

첫 번째 인쇄물 이후에 저울의 연결 설정(Bauderate, Bit, Handshake)이 변경된 경우 프린터를 다시 시작해야 합니다. 스위치를 끄거나 켜 자동 전송 속도 감지를 다시 시작합니다. 자동 전송 속도가 꺼질 수 있습니다.















3 키 누름 기능









프린터 P25

작동 수준	 짧게 누르기	 길게 누르기
	라인 피드 1개	연속 급지(손을 댄 때까지)
 +  On	인쇄물 설정으로 프린터 테스트	메뉴 열기
메뉴 레벨	 짧게 누르기	 길게 누르기
	다음 메뉴 항목	저장

프린터 P26

작동 수준	 짧게 누르기	 길게 누르기		
	저울 영점 또는 용기 설정	-		
	날짜 및 시간 인쇄	-		
	라인 피드 1개	연속 급지(손을 댄 때까지)		
	인쇄	메뉴 열기		
메뉴 레벨	 짧게 누르기	 길게 누르기		
 종료	 아래로	 위로	 다음	 저장

프린터 P28

작동 수준		짧게 누르기	길게 누르기
	저울 영점 또는 용기 설정	-	-
	날짜 및 시간 인쇄	-	-
	라인 피드 1개	연속 금지(손을 떼 때까지)	
	인쇄	메뉴 열기	
메뉴 레벨		짧게 누르기	길게 누르기
	종료	 아래로	 위로
		 다음	 저장
기능 수준		짧게 누르기	길게 누르기
	합산 애플리케이션 시작		합산 애플리케이션 종료
	통계 애플리케이션 시작		통계 애플리케이션 종료

4 메뉴

4.1 프린터 P25

짧게 누르기	길게 누르기	인쇄물
<div style="background-color: black; color: white; padding: 2px; text-align: center;">Settings</div> <div style="border: 1px solid black; padding: 2px; text-align: center;">Reset</div>		Settings Reset
	프린터 리셋	<pre>----- Reset done ----- Current settings: Baudrate: 9600 Bit/Parity: 8 Bit Non Handshake: Off Char Set: IBM/DOS</pre>
<div style="border: 1px dashed gray; padding: 2px;"> <div style="background-color: black; color: white; padding: 2px; text-align: center;">Auto Baudrate</div> <div style="border: 1px solid black; padding: 2px; text-align: center;">On</div> </div>	저장	<pre>Auto Baudrate: On -----STORED----- ..."current settings"</pre>
<div style="border: 1px dashed gray; padding: 2px;"> <div style="border: 1px solid black; padding: 2px; text-align: center;">Auto Baudrate</div> <div style="border: 1px solid black; padding: 2px; text-align: center;">Off</div> </div>	저장	<pre>Auto Baudrate: Off -----STORED----- ..."current settings"</pre>
<div style="background-color: black; color: white; padding: 2px; text-align: center;">Char Set</div> <div style="border: 1px solid black; padding: 2px; text-align: center;">IBM / DOS</div>	저장	<pre>IBM/DOS -----STORED----- ..."current settings"</pre>
<div style="border: 1px solid black; padding: 2px; text-align: center;">IBM / DOS Cyrillic</div>	저장	<pre>IBM/DOS Cyrillic -----STORED----- ..."current settings"</pre>
<div style="border: 1px solid black; padding: 2px; text-align: center;">IBM / DOS Japanese</div>	저장	<pre>IBM/DOS Japanese -----STORED----- ..."current settings"</pre>
<div style="border: 1px solid black; padding: 2px; text-align: center;">ANSI / WIN Latin 1</div>	저장	<pre>ANSI/WIN Latin 1 -----STORED----- ..."current settings"</pre>
<div style="border: 1px solid black; padding: 2px; text-align: center;">ANSI / WIN Cyrillic</div>	저장	<pre>ANSI/WIN Cyrillic -----STORED----- ..."current settings"</pre>
<div style="border: 1px solid black; padding: 2px; text-align: center;">ANSI / WIN Japanese</div>	저장	<pre>ANSI/WIN Japanese -----STORED----- ..."current settings"</pre>
<div style="background-color: black; color: white; padding: 2px; text-align: center;">Balance Feature</div> <div style="border: 1px solid black; padding: 2px; text-align: center;">Enable</div>	저장	<pre>Balance Feature: Enable -----STORED----- ..."current settings"</pre>
<div style="border: 1px solid black; padding: 2px; text-align: center;">Balance Feature</div> <div style="border: 1px solid black; padding: 2px; text-align: center;">Disable</div>	저장	<pre>Balance Feature: Disable -----STORED----- ..."current settings"</pre>

메뉴 옵션
공장 출고 시 설정

4.2 프린터 P26 / P28

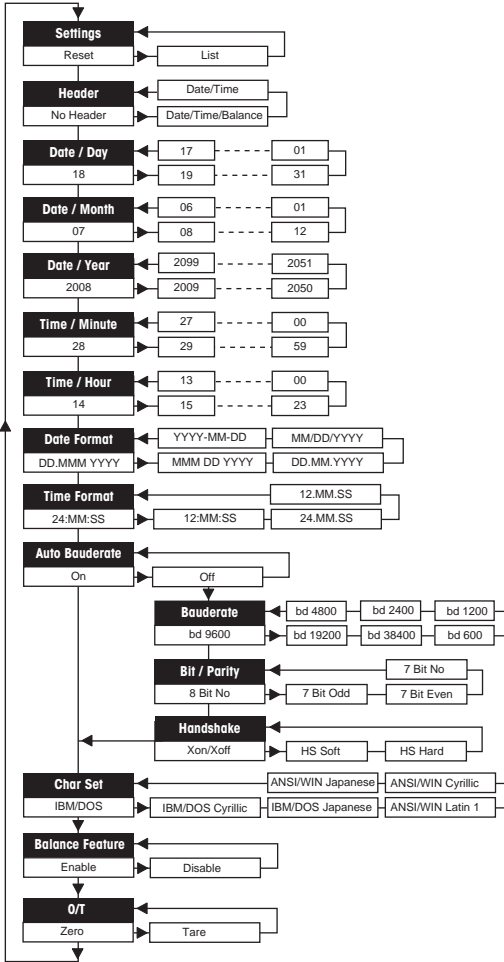

저울 디스플레이를 사용하는 경우의 예:

설정	Reset	rESEt
	List	LlSt
헤더	*No Header	no Hdr
	Date/Time	d t Hdr
	Date/Time/Balance	dtb Hdr
날짜 일**	18	dAY 18
날짜 월**	07	Month 07
날짜 년**	2008	YEAR 2008
시간 분**	28	Min. 28
시간 시간**	14	Hour 14
날짜 형식***	DD.MMM YYYY	ddMMn Y
	MMM DD YYYY	MMn dd Y
	DD.MM.YYYY	ddMM.Y
	MM/DD/YYYY	MM dd YY
	YYYY-MM-DD	Y-MM-dd
시간 형식***	24:MM:SS	24:MM:SS
	12:MM:SS	12:MM:SS
	24.MM.SS	24MM.SS
	12.MM.SS	12MM.SS
전송 속도	*9600	bd9600
	19200	bd 19200
	38400	bd38400
	600	bd600
	1200	bd 1200
	2400	bd2400
	4800	bd4800
비트/패리티	*8 Bit No	8b-no
	7 Bit Odd	7b-odd
	7 Bit Even	7b-E
	7 Bit No	7b-no
핸드셰이크	*Xon/Xoff	HS oFF
	HS Soft	HS SoFT
	HS Hard	HS HARd
문자 세트	*IBM/DOS	d05
	IBM/DOS Cyrillic	d05 C4r
	IBM/DOS Japanese	d05 JAP
	Ansi/Win Latin 1	11 in LARt
	Ansi/Win Cyrillic	11 in C4r
	Ansi/Win Japanese	11 in JAP
용기 측정/영점	*Zero	ZErO
	Tare	tARt

메뉴 옵션
공장 출고 시 설정

- * 공장 출고 시 설정
- ** 시계 내장 기기 해당 사항 없음, 내장 시계가 우선 순위를 갖음
- *** 시계 내장 기기 프린터 형식이 우선 순위를 갖음

하루 설정의 예(P26/P28 전용)

메뉴 열기

- 리셋이 표시될 때까지 **⏻** 키를 길게 누릅니다.
- **⏻** 키를 사용하여 메뉴 옵션 **날짜**를 선택합니다.
- 날짜를 선택합니다(예: 21 일).
 - ↑ 키를 사용하여 스크롤을 위로 올립니다.
 - ⏻ 키를 사용하여 스크롤을 아래로 내립니다.

설정 저장

- **저장됨**이 표시될 때까지 **⏻** 키를 길게 누릅니다.

통계 애플리케이션(P28 전용)



샘플 중량은 현재 평균 값의 70%-130% 범위 이내여야 합니다.

최소 동적 중량 변화는 100d여야 합니다.

- 1 **⏻**를 눌러 통계 애플리케이션을 시작합니다(LED 켜짐).
- 2 새 샘플을 추가하고 **M+**를 누릅니다.
- 3 필요한 경우, **⏻**를 눌러 소계를 인쇄합니다.
- 4 **⏻**를 길게 눌러 인쇄하고 통계 애플리케이션을 종료합니다(LED 꺼짐).

참고

- 애플리케이션 실행 도중 단위 변경은 허용되지 않습니다.
- 최대 샘플은 999입니다.

합산 애플리케이션(P28 전용)



최소유효무게는 + 1d입니다.

- 1 **⏻**를 눌러 합산 애플리케이션을 시작합니다(LED 켜짐).
- 2 새 샘플을 추가하고 **M+**를 누릅니다.
- 3 필요한 경우, **⏻**를 눌러 소계를 인쇄합니다.
- 4 **⏻**를 길게 눌러 인쇄하고 합산 애플리케이션을 종료합니다(LED 꺼짐).

참고

- 애플리케이션 실행 도중 단위 변경은 허용되지 않습니다.
- 최대 샘플은 999입니다.

5 유지보수



⚠ 경고

감전으로 인한 사망 또는 심각한 부상

전류가 흐르는 부위에 접촉하면 부상 및 사망에 이를 수 있습니다.

- 1 세척 및 유지보수에 앞서 프린터를 전원 공급 장치에서 분리하십시오.
- 2 액체가 프린터 또는 AC/DC 어댑터에 유입되지 않게 하십시오.

5.1 용지 롤 교체

새 용지 롤 삽입은 [용지 삽입 ▶ 152 페이지] 장에 설명되어 있습니다. 용지 롤 주문 번호는 [소모품 ▶ 160 페이지] 장에서 확인할 수 있습니다.

참고

용지 로터리 측은 항상 기존 용지 롤에서 새 용지 롤로 전달되어야 합니다.

5.2 리본 교체

리본 카트리지 주문 번호는 [소모품 ▶ 160 페이지] 장에서 확인할 수 있습니다.

- 1 용지 커버(1)를 제거합니다.
- 2 인쇄 장치(2)에서 용지를 당겨 꺼냅니다.



- 3 화살표 방향(3)으로 눌러 리본 카트리지를 제거합니다.
- 4 새 리본 카트리지를 삽입합니다. 필요한 경우, 장력 조정 휠(4)로 조입니다.



새 용지 롤 삽입은 [용지 삽입 ▶ 152 페이지] 장에 설명되어 있습니다.

5.3 하우징 청소

프린터 하우징은 최상급의 내성 재료로 만들어져 있으므로 시판되는 중성 세제를 모두 사용할 수 있습니다.



주의 사항

부적절한 청소 방법으로 인한 프린터 손상

프린터 하우징은 고품질의 저항성 소재로 제작되며 특정 세제, 용매 또는 연마재에 의해 손상될 수 있습니다. 하우징에 유입되는 모든 액체로 인해 프린터가 손상될 수 있습니다.

- 1 물과 중성세제를 사용하여 프린터를 청소하십시오.
- 2 흘린 액체는 즉시 닦아내십시오.
- 3 액체가 프린터 내부에 유입되지 않도록 하십시오.

담당자에게 METTLER TOLEDO 문의하여 사용 가능한 서비스 옵션에 대해 알아보십시오. 인증을 받은 서비스 기술자가 수행하는 정기적인 유지보수를 통해 오랜 시간에 걸쳐 일관된 계량 정확도를 보장하고 장비의 서비스 수명이 연장되도록 보장해드립니다.

6 기술 데이터

6.1 일반 기술 데이터

전원 공급 장치

AC/DC 어댑터:

기본: 100 – 240 V, 50/60 Hz

보조: 12V DC, 2.5A(전자 과부하 보호 포함)

AC/DC 어댑터용 케이블:

3코어, 국가별 플러그 포함

극성:

⊖ ⊕ 현재 제한 SELV(안전 초저전압) 출력단자 포함

전력선 전압:

12V DC

소비 전력:

최대 2.5 A

보호 및 기준

과전압 카테고리:

II

오염 등급:

2

안전 및 EMC 기준:

적합성 선언 참조

활용 범위:

밀폐된 실내에서만 사용

환경 조건

해수면 위 고도:

최대 4000m

주변 온도:

0 ~ 40 °C

보관 조건:

-25 ~ 60 °C

상대 대기 습도:

최대 80%(최대 31 °C), 40 °C에서 50%까지 선형 감소, 비 응축

프린터 기능

인쇄 기술:

도트 매트릭스 프린터 5x7, 24자 라인 길이

인쇄 속도:

초당 2.3라인

리본 카트리지:

교체식, 블랙

종이 롤:

표준 용지 57.5mm x ø 50~60mm, 하우징 통합, 상용 크기

인쇄 품질:

차광 및 열적으로 안정적인 인쇄(GLP, GMP, ISO 9001)

인터페이스: RS-P25, RS-P26,

RS232C

RS-P28

USB-P25

USB

호환성 한계:

- 기능 날짜/시간: 내장 시계 포함 저울에 해당 사항 없음 (내장 시계가 우선 순위를 갖음)
- 기능 영점/용기 측정: 모든 저울 모델에 해당 사항 없음

치수/중량

프린터 치수(W × D × H):

120 × 203 × 73mm

포장 치수(W × D × H):

255 × 205 × 150mm

순 중량:

740g(용지 롤 포함)

7 소모품

설명

부품 번호

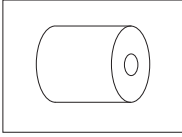

종이 롤(길이: 20m), 5개 세트

00072456

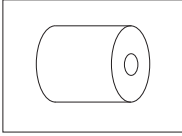

종이 롤(길이: 13m), 자체 접착식, 3개 세트

11600388

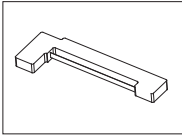

리본 카트리지, 검정색, 2개 세트

00065975

1 معلومات السلامة

يتوفر مستندتان باسم "دليل المستخدم" و"تعليمات التشغيل" لهذا الجهاز.

- يوضح لك دليل المستخدم كيفية بدء استخدام الجهاز.
- تحتوي تعليمات التشغيل على وصف كامل للجهاز واستخدامه.
- احتفظ بكلا المستنديين للرجوع إليهما في المستقبل.
- أرفق كلا المستنديين إذا نقلت الجهاز إلى أطراف أخرى.

لا تستخدم الجهاز إلا وفقًا لدليل المستخدم وتعليمات التشغيل. إذا لم تستخدم الجهاز وفقًا لهذه المستندات أو إذا تم تعديل الجهاز، فقد تتأثر سلامة الجهاز ولا تتحمل Mettler-Toledo GmbH أي مسؤولية.

1.1 المزيد من الوثائق المعمول بها

دليل المستخدم هذا هو إرشادات موجزة توفر معلومات للتعامل مع الإجراءات الأولى للجهاز بصورة آمنة وفعالة. يجب أن يقوم الموظفون بقراءة هذا الدليل بعناية واستيعابه قبل تنفيذ أي من المهام للحصول على المعلومات الكاملة، قم دائمًا بالرجوع للدليل المرجعي (RM).



► www.mt.com/printer-p-20-RM

1.2 تعريفات كلمات الإشارة ورموز التحذير

تتضمن ملاحظات السلامة معلومات هامة حول مشكلات السلامة. قد ينتج عن تجاهل ملاحظات السلامة حدوث إصابات شخصية وتلف في الجهاز وأعطال وظهور نتائج خاطئة. يتم تحديد ملاحظات السلامة بالإشارات المكتوبة ورموز التحذير التالية:

الإشارات المكتوبة

تحذير	موقف ينطوي على خطر ذي درجة متوسطة والذي قد ينتج عنه الوفاة أو إصابة خطيرة في حالة عدم تجنبه.
تنبيه	موقف ينطوي على خطر ذي درجة منخفضة والذي ينتج عنه إصابة خفيفة أو متوسطة في حالة عدم تجنبه.
إنذار	موقف ينطوي على خطر ذي درجة منخفضة، ينتج عنه تلف الجهاز أو تلف مواد أخرى أو أعطال أو ظهور نتائج خاطئة أو فقدان البيانات.

رموز التحذير

صدمة كهربائية



خطر عام: اقرأ تعليمات التشغيل للاطلاع على معلومات حول المخاطر والتدابير الناتجة.



إشعار



1.3 ملاحظات السلامة الخاصة بالمنتج

الغرض المخصص

هذا الجهاز مصمم للاستخدام في المختبرات بمعرفه موظفين مدربين. يتمثل الغرض من الجهاز في طباعة أغراض البروتوكول.

أي نوع آخر من الاستخدام والتشغيل يتجاوز حدود المواصفات الفنية دون موافقة خطية من Mettler-Toledo GmbH يُعتبر خارج نطاق غرض الاستخدام.

المسؤوليات التي تقع على عاتق مالك الجهاز

مالك الجهاز هو الشخص الذي يمتلك حق الملكية القانوني للجهاز والذي يستخدم الجهاز أو يقوم بتحويل أي شخص لاستخدامه، أو هو الشخص الذي يُعتبر بموجب القانون بمثابة المشغل للجهاز. يكون مالك الجهاز مسؤولاً عن سلامة جميع مستخدمي الجهاز والأطراف الثالثة.

تفترض شركة METTLER TOLEDO أن مالك الجهاز يقوم بتدريب المستخدمين على استخدام الجهاز بأمان في مواقع عملهم وعلى التعامل مع المخاطر المحتملة. تفترض شركة METTLER TOLEDO بأن مالك الجهاز سيوفر معدات الوقاية.

ملاحظات السلامة

تحذير



الوفاة أو الإصابة الخطيرة بسبب الصدمة الكهربائية

قد تؤدي ملامسة الأجزاء التي تنقل تيارًا مباشرًا إلى الوفاة أو الإصابة.

- 1 لا تستخدم سوى كابل إمداد الطاقة METTLER TOLEDO المعتمد ومحول التيار المتردد/التيار المستمر مع خرج الجهد شديد الانخفاض (SELV) محدود التيار.
- 2 وصل كابل الطاقة بمأخذ طاقة مؤرض، وتأكد من القطبية الصحيحة.
- 3 احتفظ بجميع الكابلات والوصلات الكهربائية بعيدًا عن السوائل والرطوبة.
- 4 افحص الكابلات وقابس الطاقة بحثًا عن أي تلف، واستبدل الكابلات ومقابس الطاقة التالفة.

إشعار



التلف الذي يلحق بالجهاز نتيجة استخدام أجزاء غير ملائمة

قد ينتج عن استخدام أجزاء غير ملائمة مع الجهاز حدوث تلف في الجهاز أو حدوث أعطال.

- لا تستخدم إلا الأجزاء المقدمة من شركة METTLER TOLEDO والمعدة للاستخدام مع جهازك.

2 التركيب وبدء التشغيل

2.1 نطاق التسليم

- محول التيار المتردد/المستمر
- كابل الطاقة (محدد حسب البلد)
- دليل المستخدم
- إعلان المطابقة

2.2 توصيل الطابعة بمصدر الطاقة

تحذير ⚠



الوفاة أو الإصابة الخطيرة بسبب الصدمة الكهربائية

قد تؤدي ملامسة الأجزاء التي تنقل تيارًا مباشرًا إلى الوفاة أو الإصابة.

- 1 لا تستخدم سوى كابل إمداد الطاقة METTLER TOLEDO المعتمد ومحول التيار المتردد/التيار المستمر مع خرج الجهد شديد الانخفاض (SELV) محدود التيار.
- 2 وصل كابل الطاقة بمأخذ طاقة مؤرض، وتأكد من القطبية الصحيحة.
- 3 احتفظ بجميع الكابلات والوصلات الكهربائية بعيدًا عن السوائل والرطوبة.
- 4 افحص الكابلات وقابس الطاقة بحثًا عن أي تلف، واستبدل الكابلات ومقابس الطاقة التالفة.

إشعار



حدوث تلف في محول التيار المتردد/المباشر بسبب فرط السخونة

إذا تمت تغطية محول التيار المتردد/المباشر أو وضعه في حاوية، فلن يبرد بشكل كافي وسيسخن بشدة.

- 1 تجنب تغطية محول التيار المتردد/المباشر.
- 2 تجنب وضع محول التيار المتردد/المباشر في حاوية.

تُسلّم الطابعة مرفقة بمحول تيار متردد/تيار مباشر شامل أو محول تيار متردد/تيار مستمر مع كابل طاقة خاص بالبلد.

- ركب الكابلات بحيث لا تكون عرضة للتلف أو التداخل في عملية التشغيل.
- أدخل كابل الطاقة في مصدر تيار مؤرض يسهل الوصول إليه.



- 1 وصل محول التيار المتردد/التيار المباشر بمقبس التوصيل الموجود خلف الطابعة.
- 2 افقل الموصل بصامولة البرغي.
- 3 وصل كابل الطاقة المؤرض ثلاثي الأسنان بمقبس محول التيار المتردد/التيار المباشر.
- 4 وصل الطابعة والميزان بكابل الواجحة.
- 5 شغل الميزان.
- 6 وصل الطابعة بمصدر الطاقة على النحو التالي:

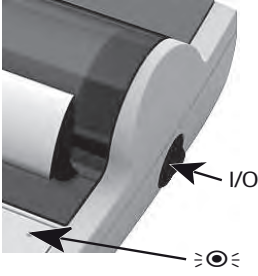

ملاحظة

واجهة RS232 فقط: سيومض المصباح الإرشادي حتى يتم توصيل الجهاز. إذا استمر المصباح في الوميض، فراجع فصل "استكشاف الأخطاء وإصلاحها" في الدليل المرجعي.

2.3 إدخال الورق

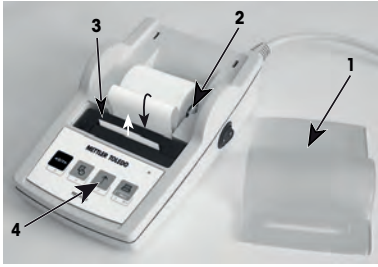

- 1 قم بإزالة غطاء الورق (اسحبه من الخلف) (1).
 - 2 أدخل محور الورق الدوار عبر مركز لفة الورق (2).
 - 3 قم بتغذية الورق عبر الفتحة الموجودة في وحدة الطباعة في اتجاه السهم (3).
 - 4 اضغط مع الاستمرار حتى تتم تغذية ورق كافي (4).
 - 5 وجه الورق عبر فتحة غطاء الورق.
 - 6 ضع غطاء الورق (1) على الورق.
- إذا تغيرت إعدادات الاتصال (معدل البود، البت، تأكيد الاتصال) بعد النسخ المطبوعة الأولى، فيجب إعادة تشغيل الطابعة. قم بالإيقاف/التشغيل لبدء الكشف التلقائي عن معدل البود مرة أخرى. يمكن إيقاف تشغيل معدل البود التلقائي.

3 وظائف ضغط المفاتيح

الطابعة P25

مستوى التشغيل	اضغط لفترة وجيزة	اضغط مع الاستمرار
↑	تغذية خط واحد	تغذية مستمرة (حتى ترك المفتاح)
↑ + On	اختبار الطابعة من خلال طباعة الإعداد	افتح القائمة
مستوى القائمة	اضغط لفترة وجيزة	اضغط مع الاستمرار
↑	عنصر القائمة التالي	التخزين

الطابعة P26

مستوى التشغيل	اضغط لفترة وجيزة	اضغط مع الاستمرار
→0/2←	تصغير/تفريغ الميزان	-
	طباعة التاريخ والوقت	-
↑	تغذية خط واحد	تغذية مستمرة (حتى ترك المفتاح)
	طباعة	افتح القائمة
مستوى القائمة	اضغط لفترة وجيزة	اضغط مع الاستمرار
→0/2←	خروج	التخزين
↑	لأسفل	التالي
↓	لأعلى	

اضغط مع الاستمرار		اضغط لفترة وجيزة		مستوى التشغيل	
-	-	تصغير/تفريغ الميزان			
-	-	طباعة التاريخ والوقت			
تغذية مستمرة (حتى ترك المفتاح)	تغذية خط واحد	طباعة			
افتح القائمة	اضغط مع الاستمرار <th colspan="2">اضغط لفترة وجيزة</th> <th>مستوى القائمة</th>	اضغط لفترة وجيزة		مستوى القائمة	
التخزين					
	التالي	لأعلى	لأسفل	خروج	
اضغط مع الاستمرار		اضغط لفترة وجيزة		مستوى الوظيفة	
اختتام تطبيق المجموع	اختتام تطبيق الإحصائيات	بدء تطبيق المجموع			
		بدء تطبيق الإحصائيات			

طابعة	اضغط مع الاستمرار	اضغط لفترة وحيدة
<p>Settings Reset</p> <p>----- Reset done ----- Current settings: Baudrate: 9600 Bit/Parity: 8 Bit Non Handshake: Off Char Set: IBM/DOS</p> <p>Auto Bauderate: On -----STORED----- ... "current settings"</p> <p>Auto Bauderate: Off -----STORED----- ... "current settings"</p> <p>IBM/DOS -----STORED----- ... "current settings"</p> <p>IBM/DOS Cyrillic -----STORED----- ... "current settings"</p> <p>IBM/DOS Japanese -----STORED----- ... "current settings"</p> <p>ANSI/WIN Latin 1 -----STORED----- ... "current settings"</p> <p>ANSI/WIN Cyrillic -----STORED----- ... "current settings"</p> <p>ANSI/WIN Japanese -----STORED----- ... "current settings"</p> <p>Balance Feature: Enable -----STORED----- ... "current settings"</p> <p>Balance Feature: Disable -----STORED----- ... "current settings"</p>	<pre> graph TD A[Settings Reset] --> B[واجهة RS232 Auto Bauderate On] B --> C[واجهة RS232 Auto Bauderate Off] C --> D[Char Set IBM / DOS] D --> E[IBM / DOS Cyrillic] E --> F[IBM / DOS Japanese] F --> G[ANSI / WIN Latin 1] G --> H[ANSI / WIN Cyrillic] H --> I[ANSI / WIN Japanese] I --> J[Balance Feature Enable] J --> K[Balance Feature Disable] </pre>	<p>إعادة تعيين الطابعة</p> <p>التخزين</p> <p>التخزين</p> <p>التخزين</p> <p>التخزين</p> <p>التخزين</p> <p>التخزين</p> <p>التخزين</p> <p>التخزين</p> <p>التخزين</p> <p>التخزين</p>

خيار القائمة
إعداد المصنع

أمثلة على استخدام شاشة الميزان:

الإعدادات	
Reset	r ESEt
List	L ISt
الرأس	
*No Header	no Hdr
Date/Time	d t Hdr
Date/Time/Balance	d t b Hdr
يوم التاريخ**	
18	dRy 18
شهر التاريخ**	
07	Month 07
سنة التاريخ**	
2008	Year 2008
دقيقة الوقت**	
28	Min. 28
ساعة الوقت**	
14	Hour 14
تنسيق التاريخ***	
DD.MMM.YYYY	ddMMM Y
MMM.DD.YYYY	MMM dd Y
DD.MM.YYYY	ddMMY
MM/DD/YYYY	MM dd Y
YYYY-MM-DD	Y-MM-dd
تنسيق الوقت***	
24:MM:SS	24:MM:SS
12:MM:SS	12:MM:SS
24.MM.SS	24MM.SS
12.MM.SS	12MM.SS
معدل الود	
*9600	bd 9600
19200	bd 19200
38400	bd 38400
600	bd 600
1200	bd 1200
2400	bd 2400
4800	bd 4800
بت/تبادل	
*8 Bit No	8b-no
7 Bit Odd	7b-odd
7 Bit Even	7b-E
7 Bit No	7b-no
تأكيد الاتصال	
*Xon/Xoff	HS OFF
HS Soft	HS Soft
HS Hard	HS Hard
حزمة الرموز	
*IBM/DOS	dOS
IBM/DOS Cyrillic	dOS Cyr
IBM/DOS Japanese	dOS JRP
ANSI/Win Latin 1	11 in LRt
ANSI/Win Cyrillic	11 in Cyr
ANSI/Win Japanese	11 in JRP
تفريغ/تصفير	
*Zero	ZErO
Tare	tARt

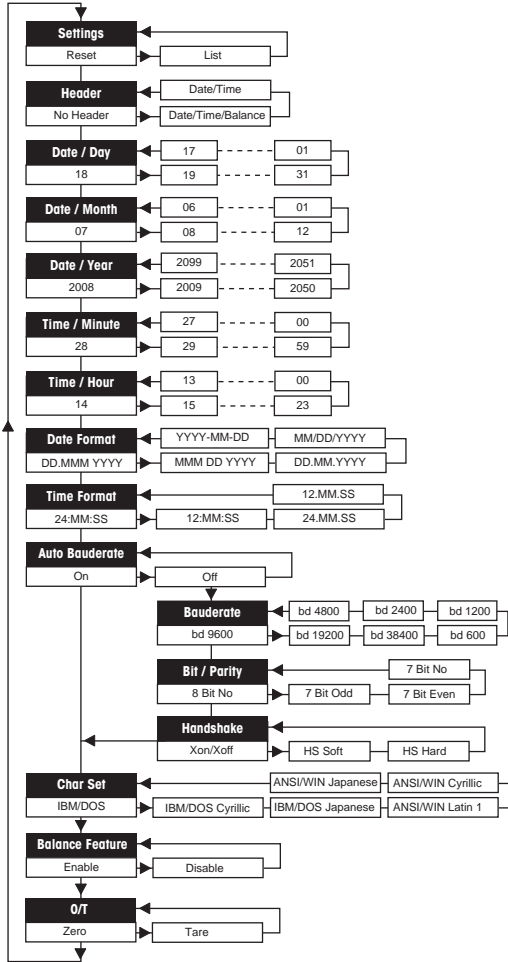

إعدادات المصنع *





الأجهزة المزودة بساعة مدمجة: غير منطبق، الساعة المضمنة لها الأولوية **

الأجهزة المزودة بساعة مدمجة: تنسيق الطابعة له الأولوية ***

خيار القائمة
إعداد المصنع

مثال لتعيين اليوم (P26 / P28 فقط)

افتح القائمة

- اضغط مع الاستمرار على المفتاح  حتى تظهر إعادة التعيين.
- حدد خيار القائمة اليوم باستخدام المفتاح .
- حدد اليوم، على سبيل المثال اليوم 21.
- مرر لأعلى باستخدام المفتاح .
- مرر لأسفل باستخدام المفتاح .



احفظ الإعدادات

- اضغط مع الاستمرار على المفتاح  حتى يظهر تم التخزين.

تطبيق الإحصائيات (P28 فقط)

- يجب أن يتراوح وزن العينة بين 70% و130% من القيمة المتوسطة الحالية.
- يجب أن يكون الحد الأدنى للوزن الديناميكي المتغير 100 d.



- 1 اضغط على  لبدء تطبيق الإحصائيات (بضوء مؤشر LED).
- 2 أضف عينة جديدة واضغط على **M+**
- 3 اضغط على  لطباعة المجموع الفرعي، إذا لزم الأمر.
- 4 اضغط مع الاستمرار على  للطباعة وإنهاء تطبيق الإحصائيات (ينطفئ مؤشر LED).



ملاحظة

- غير مسموح بتغيير الوحدة أثناء التطبيق.
- الحد الأقصى 999 عينة.

تطبيق الجمع (P28 فقط)

- الحد الأدنى للأوزان + 1 d.



- 1 اضغط على  لبدء تطبيق الجمع (بضوء مؤشر LED).
- 2 أضف عينة جديدة واضغط على **M+**
- 3 اضغط على  لطباعة المجموع الفرعي، إذا لزم الأمر.
- 4 اضغط مع الاستمرار على  للطباعة وإنهاء تطبيق الجمع (ينطفئ مؤشر LED).

ملاحظة

- غير مسموح بتغيير الوحدة أثناء التطبيق.
- الحد الأقصى 999 عينة.

5 الصيانة

تحذير

الوفاة أو الإصابة الخطيرة بسبب الصدمة الكهربائية

قد تؤدي ملامسة الأجزاء التي تنقل تيارًا مباشرًا إلى الإصابة والوفاة.

- 1 افصل الطابعة عن مصدر الطاقة قبل التنظيف والصيانة.
- 2 تجنب دخول السوائل إلى الطابعة أو محول التيار المتردد/التيار المستمر.



5.1 استبدال لفة الورق

توضِّح طريقة إدخال لفة الورق الجديدة في فصل [إدخال الورق « صفحة 164]. يمكن الاطلاع على رقم طلب لفة الورق في فصل [المواد الاستهلاكية « صفحة 172].

ملاحظة

يجب دائمًا نقل محور دوران الورق من لفة الورق القديمة إلى الجديدة.

5.2 استبدال الشريط

يمكن العثور على رقم طلب خرطوشة الشريط في فصل [المواد الاستهلاكية « صفحة 172].



- 1 قم بإزالة غطاء الورق (1).
- 2 اسحب الورق خارج وحدة الطباعة (2).



- 3 قم بإزالة خرطوشة الشريط بالضغط في اتجاه السهم (3).
- 4 أدخل خرطوشة الشريط الجديدة. إذا لزم الأمر، قم بخطوة إضافية بعجلة الشد (4).
- توضّح طريقة إدخال لفة الورق الجديدة في فصل [إدخال الورق « صفحة 164].

5.3 تنظيف الغلاف

نظرًا لأن غلاف الطباعة مصنوع من مواد مقاومة من الدرجة الأولى، فيمكن استخدام جميع مواد التنظيف المخففة المتوفرة تجاريًا.

إشعار



تعرض الطباعة للتلف بسبب طرق التنظيف غير المناسبة

إن غلاف الطباعة مصنوع من مواد عالية الجودة ومقاومة ويمكن أن يتعرض لتلف بسبب بعض مواد التنظيف أو المذيبات أو المواد الكاشطة. قد يؤدي دخول أي سائل داخل الغلاف إلى تلف الطباعة.

- 1 استخدم الماء ومنظف مُخفف لتنظيف الطباعة.
- 2 امسح أي سوائل منسكبة على الفور.
- 3 امنع دخول السائل إلى داخل الطباعة.

اتصل بأحد وكلاء METTLER TOLEDO لمعرفة خيارات الخدمة المتاحة - ستضمن الصيانة الدورية من قبل مهندس خدمة معتمد دقة وزن ثابتة على المدى الطويل بالإضافة إلى إطالة العمر الافتراضي للجهاز.

6 البيانات الفنية

6.1 البيانات الفنية العامة

مصدر الطاقة

محول التيار المتردد/التيار المستمر:

الأساسي: 100 - 240 فولت، 50/60 هرتز
التانوي: 12 فولت تيار مستمر، 2.5 أمبير (مع حماية إلكترونية من
الأحمال الزائدة)

كابل لمحول التيار المتردد/التيار
المستمر:

ثلاثي النواة، مع قابس خاص بالبلد

القطبية:

⊖ ⊕ من خلال خرج الجهد شديد الانخفاض (SELV) محدود
التيار

جهد خط الطاقة:

12 فولت تيار مستمر

استهلاك الطاقة:

الحد الأقصى 2.5 أمبير

الحماية والمعايير

فئة الجهد الزائد:

الثانية

درجة التلوث:

2

معايير السلامة والتوافق
الكهرومغناطيسي:

انظر إقرار المطابقة

نطاق التطبيق:

للاستخدام في الغرف الداخلية المغلقة فقط

الظروف البيئية

الارتفاع فوق مستوى سطح البحر:

حتى 4000 م

درجة الحرارة المحيطة:

من 0 إلى 40 درجة مئوية

ظروف التخزين:

من -25 إلى 60 درجة مئوية

رطوبة الهواء النسبية:

الحد الأقصى 80% حتى 31 درجة مئوية، تتناقص خطيًا إلى 50%
عند 40 درجة مئوية، بدون تكاثف

مميزات الطباعة

تقنية الطباعة:

طباعة مصفوفة نقطية 5 × 7، طول الخط 24 حرفًا

سرعة الطباعة:

2.3 سطر في الثانية

خرطوشة الشريط:

قابل للتبديل، باللون الأسود

لغة الورق:

ورق قياسي 57.5 مم × قطر من 50 إلى 60 مم، مدمج في
الغلاف، الحجم التجاري

جودة الطباعة:

طباعة مقاومة للضوء ومستقرة حراريًا (GLP، GMP، ISO 9001)

RS232C

RS-P25، RS-P26،

RS-P28

USB

USB-P25

حدود التوافق:

• تاريخ / وقت الوظيفة: غير منطبق على الموازين ذات الساعة
الدمجة (الساعة المدمجة لها الأولوية)

• تصفير / تفريغ الوظائف غير منطبق على جميع طُرُز الموازين

البُعد / الوزن

120 × 203 × 73 مم

أبعاد الطابعة (العرض × العمق ×
الارتفاع):

255 × 205 × 150 مم

أبعاد العبوة (العرض × العمق ×
الارتفاع):

740 جم (يشمل لفة الورق)

الوزن الصافي:

7 المواد الاستهلاكية

رقم القطعة

الوصف

00072456

لفة ورق (الطول: 20 م)، مجموعة مكونة من 5 قطع

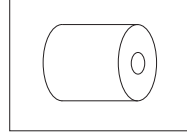

11600388

لفة ورق (الطول: 13 م) ذاتي اللصق، مجموعة مكونة من 3 قطع

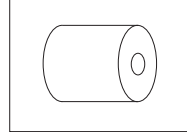

00065975

خرطوشة الشريط، باللون الأسود، مجموعة مكونة من قطعتين

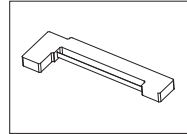

GWP®

Good Weighing Practice™

GWP® is the global weighing standard, ensuring consistent accuracy of weighing processes, applicable to all equipment from any manufacturer. It helps to:

- Choose the appropriate balance or scale
- Calibrate and operate your weighing equipment with security
- Comply with quality and compliance standards in laboratory and manufacturing

 www.mt.com/GWP

www.mt.com/lab-printers

For more information

Mettler-Toledo GmbH

Im Langacher 44
8606 Greifensee, Switzerland
www.mt.com/contact

Subject to technical changes.

© Mettler-Toledo GmbH 07/2021

30419763G cs, da, hr, hu, it, nl, pl, pt, ro, sk, sv, tr, ko, ar



30419763