

# InFit 761e/InFit 764e Immersion Housing



**METTLER TOLEDO**

© It is forbidden to reprint this instruction manual in whole or part.

No part of this manual may be reproduced in any form, or modified, copied or distributed using electronic systems, in particular in the form of photocopies, photographs, magnetic or other recordings, without written consent of Mettler-Toledo GmbH, Process Analytics, CH-8902 Urdorf, Switzerland.

# **InFit 761e/InFit 764e Immersion Housing**

## **Instruction Manual**

InFit and InPro are trademarks of the METTLER TOLEDO Group.  
Viton® and Kalrez® are registered trademarks of DuPont Performance Elastomers LLC.  
All other trademarks are the property of their respective owners.

## How to use this Instruction Manual

This Instruction Manual is an integral part of the METTLER TOLEDO insertion housing InFit® 761/4e Series and contains notes and instructions that are important for safety and operation.

All persons working on or with the InFit 761/4e must have first read and understood the sections appropriate to the work in hand.

Please read this Instruction Manual carefully before using the housing. Keep this document close to the unit, so that operating personnel may easily be able to refer to it at any time.



**Caution!** Please first read Section 1 "Introduction" and Section 2 "Important Notes".

Proprietary designations:

- InFit and InPro are trademarks of the METTLER TOLEDO Group.
- Viton® and Kalrez® are registered trademarks of DuPont Performance Elastomers LLC.

### Use of warnings and symbols:



**Danger!** Warning of a dangerous situation that can lead to death or severe injury, or cause extensive material damage.



**Caution!** Warning of a possibly dangerous situation that can lead to light bodily harm and/or material damage.



**Attention:** Information referring to technical requirements. Non-adherence can lead to malfunction, uneconomic working and possibly also to loss of productivity.

### Explanation of housing designations:

The generic term InFit 761/4e Series used in this document refers to:

- **InFit 761e** – Insertion housing for pH/Redox electrodes with gel-type or polymer electrolyte, O<sub>2</sub>, CO<sub>2</sub>, conductivity and turbidity sensors (with 12 mm diameter and Pg 13.5 thread);
- **InFit 764e** – Insertion housing for pressurized pH/Redox electrodes with liquid electrolyte (such as InPro® 2000 (i)).

## Contents

	Page
How to use this Instruction Manual .....	4
1 Introduction .....	8
1.1 Declaration of Conformity/Type Examinations .....	8
1.2 Housing Designations .....	9
1.3 Basic Principles .....	12
1.4 Responsibilities, Organizational Measures .....	12
1.4.1 Responsibilities of the Operator .....	12
1.4.2 Responsibilities of the Personnel .....	13
1.4.3 Selection and Qualification of Personnel – Basic Duties .....	13
1.5 Product-Specific Hazards .....	13
1.5.1 Removal of Electrode/Sensor.....	13
1.5.2 Manipulation and Maintenance Work on the Housings.....	14
1.5.3 Plastic Housings .....	14
1.5.4 Installation in Pressurized Systems.....	14
1.5.5 Installation in Potentially Explosive Areas (Hazardous Areas) .....	15
1.6 Residual Hazards .....	16
1.6.1 Leaky Connections .....	16
1.6.2 Medium Residues.....	16
1.6.3 Heat Protection .....	16
1.6.4 External Impacts .....	16
1.7 Emergency Measures .....	16
1.8 Safety Measures .....	16
1.9 Modifications .....	17
2 Important Notes.....	17
2.1 Notes on Operating Instructions .....	17
2.2 Intended Use .....	18
2.3 Safety Instructions .....	18
2.4 Correct Disposal of the Housing.....	19
2.5 Use in Ex zones .....	19
2.6 Ex classification ATEX/IECEx .....	20
2.6.1 Introduction .....	20
2.6.2 Special Conditions.....	20
2.7 Ex classification FM Approved .....	21
2.7.1 Introduction .....	22
2.7.2 Special Conditions.....	22
2.7.3 Applied Standards .....	23
2.8 Hygienic Instruction.....	23

	Page
3	Product Description ..... 24
3.1	Scope of Delivery ..... 24
3.2	Packing ..... 24
3.3	Checking the Shipment ..... 24
3.4	Product Overview ..... 25
3.5	Functional Description of the Housing ..... 30
4	Installation and Start-Up ..... 31
4.1	Preparation of the Equipment..... 31
4.2	Fitting and Installation Work ..... 32
4.2.1	Fitting the Housing ..... 32
4.2.1.1	Fitting with a Weld-in Socket ..... 33
4.2.1.2	Fitting with a Flange ..... 33
4.2.1.3	Fitting via NPT External Thread ..... 33
4.2.1.4	Fitting with Tri-Clamp and Varivent Flange Connection ..... 34
4.2.1.5	Installation with NPSM Thread ..... 34
4.2.2	Fitting the Electrode/Sensor ..... 34
4.2.2.1	InFit 761e ..... 34
4.2.2.2	InFit 764e ..... 35
4.3	Startup Procedures for Housings ..... 37
4.4	Dismantling Work ..... 38
4.4.1	Removing the Insertion Housing ..... 38
4.4.2	Removing the Electrode/Sensor ..... 38
4.5	Sterilization ..... 40
5	Operation ..... 41
5.1	Important Information for Everyday Operation ..... 41
5.2	Inspection Work in Everyday Operation ..... 41
5.3	Cleaning the Electrode/Sensor ..... 41
5.4	Calibrating the Measuring System ..... 42
6	Maintenance ..... 42
6.1	Important Information on Maintenance..... 42
6.2	Topping up Reference Electrolyte ..... 43
6.3	Replacement of Medium-Wetted Seals ..... 43
7	Trouble Shooting ..... 45

	Page
8	Product Specifications ..... 46
8.1	Technical Data ..... 46
8.1.1	Technical Specifications InFit 761e ..... 46
8.1.2	Technical Specifications InFit 764e ..... 48
8.2	Spare Parts and Accessories ..... 49
9	Terms of Warranty ..... 53
10	Decommissioning, Storage, Disposal ..... 54
10.1	Decommissioning ..... 54
10.1.1	Proceed as Described in Section 4.4 "Dismantling Work" ..... 54
10.1.2	Repair ..... 54
10.2	Storage ..... 54
10.3	Disposal ..... 54
11	Appendices ..... 55
11.1	Electrode/Sensor Selection ..... 55
11.2	Product Key ..... 57

# 1 Introduction

- The insertion housing InFit 761/4e is safe to operate and has been tested by METTLER TOLEDO and dispatched ready for installation.
- Before starting to use the housing, carefully read this Instruction Manual: the safety precautions and warnings contained in it must be observed.

**In addition to this Instruction Manual please also note the following:**

- All local safety regulations;
- All instructions and warning remarks in the publications of the products that are used in conjunction with the insertion housing (electrodes, sensors, etc.);
- All safety precautions for the plant into which the housing InFit 761/4e will be installed;
- All instructions and warnings labeled on the housing InFit 761/4e;
- All safety information relative to operation in potentially explosive atmosphere/hazardous areas (Ex classified zones).

The Instruction Manual contains the most important information for using the InFit 761/4e housings efficiently and in accordance with regulations. A basic condition for safe handling and operation without malfunctions is the knowledge of these safety instructions and the observance of the further warnings in the Instruction Manual.

This Instruction Manual, and in particular the safety regulations, are intended for personnel entrusted with the operation and maintenance of the housings. It is assumed that these persons are familiar with the equipment in which the housing is installed. Therefore, before any work is started with the housing, this Instruction Manual must be read and understood by those persons involved.

The Instruction Manual must be stored where it is constantly accessible and available to any person working with the InFit 761/4e housing.

On receipt of the shipment, check immediately:

- The housing and accessories for any sign of transport damage. Report any damage immediately to the carrier and to your supplier;
- The type designation on the housing body;
- For completeness of the supply. Please notify your supplier immediately if the shipment is incomplete or in any way incorrect (see Section 3.1 "Scope of Delivery").

## 1.1 Declaration of Conformity/Type Examinations



**Attention:** The "Declarations of Conformity and Type Examinations" are dependent on the design and the individual type of housing, and have no general validity for the complete InFit product range.

Declarations of conformity and certificates specific to particular products are included in housing delivery (when applicable).

1. Housings with CE marking with Notified Body according to PED directives and according to Ex directives: medium-wetted parts made of metallic material > DN25.
2. Housings with CE marking with Notified Body according to EX directives: medium-wetted parts made of metallic material > DN25.



3. Housings with CE marking without Notified Body according to PED directives (Module A, Category I): medium-wetted parts made of plastic  $\leq$  DN25.
4. Housings without CE marking: mediumwetted parts made of plastic  $\leq$  DN25.

## 1.2 Housing Designations

Housing designations as well as part and serial numbers can be noted from the type plate and used for clear identification when communicating with the manufacturer.



**Attention:** The specifications shown on the type plate are dependent on the design and the individual type of housing and have no general validity for the complete InFit product range.

### Example of InFit 761/4e label:



**Note:** The label shown only as an example. Depending on appropriate compliances (i.e. ATEX, FM, PED or others), the final label may be different.

PartNo.: Part number  
 SNR: Serial number  
 PS: Permissible pressure  
 TS: Permissible temperature

PartNo: **XX XX XXXX**  
 SNR: **6519000 / 2016**  
 PS: **16bar** TS: **140°C**  
 PS: TS:  
 Material: **1.4435/316L**

InFit 761/4e with ATEX/cFMus approval for use in Ex classified area.

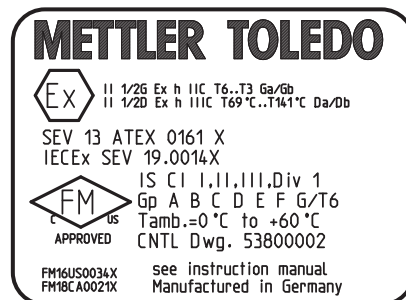

InFit 761/4e housing for use in non ex classified area.

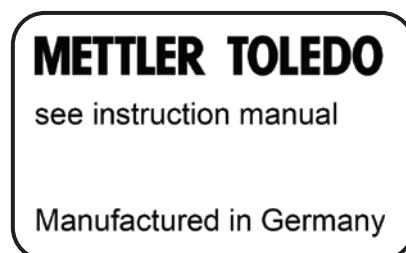

## 1.3 Basic Principles

The insertion housing InFit 761/4e is built in accordance with state-of-the-art technology and recognized technical safety regulations.

However, the housing can be a source of risk and danger:

- If the housing is operated by insufficiently trained persons;
- If the housing is not used in compliance with regulations and/or stipulations for appropriate use.

InFit 761/4e housings must be used only in perfect technical condition and for the purpose intended by the manufacturer. It is assumed that the user is fully aware of safety/danger issues and respects the Instruction Manual and all local safety regulations.

Malfunction and damage that can affect safety and function of the housing must immediately be remedied by the operator or an expert, and notified to the manufacturer in writing!



**Danger!** Defective insertion housings must neither be installed nor put into operation. Leakage and inappropriate installation may lead to the escape of medium or to pressure surges (explosion), potentially harmful both to persons and to the environment.

## 1.4 Responsibilities, Organizational Measures

### 1.4.1 Responsibilities of the Operator

- The operator must restrict permission to work with InFit 761/4e insertion housings to persons who are familiar with the basic requirements of work safety and accident prevention, and who have been instructed in the handling of the housing. This Instruction Manual serves as the basic document;
- In addition to the Instruction Manual there are also generally applicable legal and other binding regulations for work safety and accident prevention as well as for environmental protection, and these must be provided by the operator and instructed to personnel using the housings;
- The operator/user must periodically check that the personnel is fully aware of regulations on safety and risk prevention;
- Measures must be taken to ensure that the insertion housings are only operated in a safe and fully functional condition;
- If the housings are employed in hazardous areas, compliance with prevailing regulations must be ensured.



**Caution!** Before the insertion housing is put into operation, the operator has to make sure that use of the housing in conjunction with the other associated equipment and resources is fully authorized.

## 1.4.2 Responsibilities of the Personnel

- All persons operating the insertion housings must have read Sections 1 "Introduction" and 2 "Important Notes" as well as the warning notices in this Instruction Manual;
- In addition to the Instruction Manual, generally applicable legal and other binding regulations for work safety and accident prevention must be adhered to;
- Avoid any kind of working that is doubtful from a safety perspective or which exceeds the admissible scope of use;
- Do not use high-pressure cleaning equipment for polymer/plastic components of the housing.



**Attention:** Before every start-up, the insertion housing must be checked for:

- Damage to the connections, fastenings, etc.;
- Leakage;
- Proper functioning;
- Authorization for use in conjunction with other plant equipment and resources.



**Danger!** Defective insertion housings must neither be installed nor put into operation. Leakage and inappropriate installation may lead to the escape of medium or to pressure surges (explosion), potentially harmful both to persons and to the environment.

## 1.4.3 Selection and Qualification of Personnel – Basic Duties

- Work on or with the insertion housings may only be carried out by authorized and appropriately trained or instructed personnel. The personnel must have read this Instruction Manual in advance;
- Clear responsibilities must be established for the personnel entrusted with operation, service, repair, etc. of the housings;
- It must be ensured that only specifically assigned personnel may operate the housings.



**Danger!** Incorrect manipulation or operation of the housings or non-observance of safety regulations can lead to malfunction of the housing and to the escape of process medium, thus presenting a potential hazard to the environment, personnel and material.

## 1.5 Product-Specific Hazards

### 1.5.1 Removal of Electrode/Sensor



**Danger!** The electrode or sensor must be removed only after the piping/vessel has been depressurized and emptied. Otherwise, the removed electrode/sensor may cause the process medium to escape thus presenting a severe danger to persons, material and the environment. Any toxic or aggressive medium may cause severe poisoning or causticization.



**Note:** Any broken sensor or defective/cut O-ring must be replaced without delay.



**Danger!** Broken sensors prevent accurate measurements and thus adversely affect process safety.

## 1.5.2 Manipulation and Maintenance Work on the Housings



**Attention:** Before dismantling an insertion housing or commencing any maintenance work on it, ensure that the equipment in which the insertion housing is installed is in a safe condition (depressurized, explosion-proof, emptied, rinsed, vented, etc.). Insertion housings may only be stripped down after having been completely dismantled.

Manipulation of the sensor and the housing may only take place after it has been ensured that no process medium can escape through the housing in the event of incorrect manipulation. For this reason, the complete system must be emptied and vented in advance (safe condition).

It is mandatory to wear personal protective outfit such as protective goggles and clothing.

Only maintenance and repair work specified in this Instruction Manual may be performed on the insertion housing.

Exclusively use genuine spare parts from METTLER TOLEDO when replacing defective components (see Section 8.2 "Spare Parts and Accessories").



**Danger!** Non-compliance with the prescribed maintenance instructions may endanger personnel and the environment.

## 1.5.3 Plastic Housings



**Attention:**

- Insertion housings made of plastic do not have the same mechanical resistance as steel housings;
- Insertion housings made of plastic require more frequent servicing than steel housings;
- Defective components may be replaced by an authorized service center only.



**Danger!** Plastic housings may not be used in applications subject to high mechanical stress as this could break the protective cage.

## 1.5.4 Installation in Pressurized Systems



**Attention:** The specified maximum temperature and pressure must not be exceeded. The respective specifications depend on the design and type of housing and are given on the individual type plates.



**Danger!** If temperature and pressure limits are exceeded, there is a risk to the integrity of the system, thus presenting a potential threat to human life and to the environment.



**Attention:** Ample specifications of maximum admissible temperature and pressure are given in Section 8.

## 1.5.5 Installation in Potentially Explosive Areas (Hazardous Areas)



### Attention:

- It should be considered to include the METTLER TOLEDO insertion housing InFit 761/4e and the process connections in your recurring pressure test program for the complete plant as a whole;
- The operator must ensure that the housing can be used safely in conjunction with other associated plant resources;
- The insertion housing and the process connections must be connected to the main potential equalization system of the plant (see drawing below).

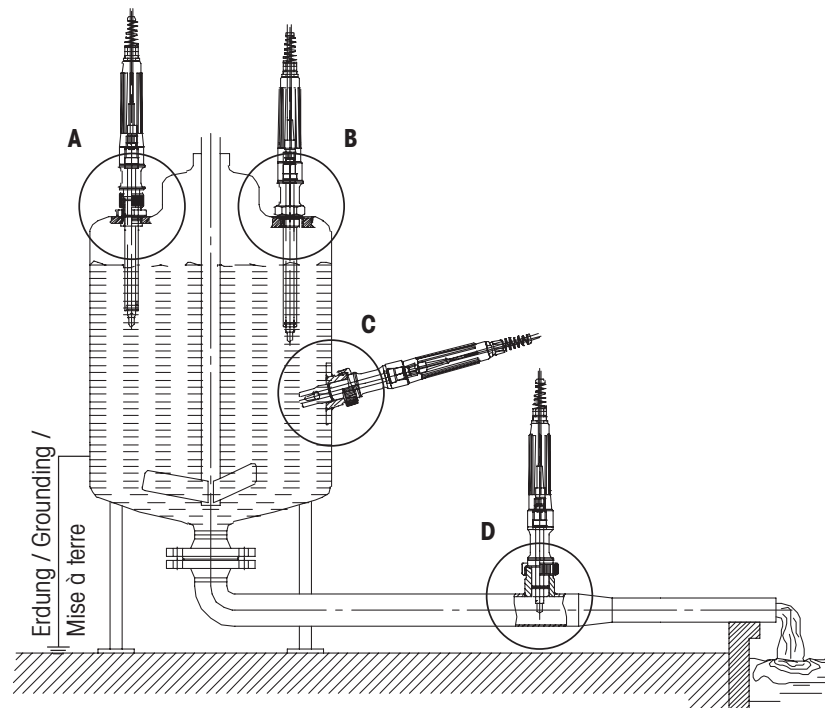

Connection of the housing to the potential equalization system of the plant.

- A.** Installation from top InFit 761/NY/\*\*/P01/\*\*/2-
- B.** Installation from top InFit 761/NY/\*\*/P02/\*\*/--
- C.** Lateral installation InFit 761/WS/\*\*/D00/\*\*/9-
- D.** Installation in piping InFit 761/NS/\*\*/D00/\*\*/9-



**Danger!** Non-observance of legal regulations concerning use in hazardous areas can endanger human life and the environment.

## 1.6 Residual Hazards



**Attention:** Despite all precautionary measures taken, residual hazards still remain.

### 1.6.1 Leaky Connections

- Connections can become loose through the effects of vibration;
- The connection between housing and process adaptor is a potential source of leakage.



**Attention:** The connections between the housing and the process adaptor must be checked regularly by the customer/operator, and kept in full working condition.



**Danger!** Leaky connections can cause the process medium to escape to the environment, presenting a hazard for persons and the environment.

### 1.6.2 Medium Residues



**Danger!** When retracting/replacing an electrode/sensor, small quantities of process medium will remain at the electrode/sensor. If the medium is a toxic or environmentally harmful substance, or contains pathogenic germs, then such contamination must be removed and disposed of in accordance with the applicable regulations!

### 1.6.3 Heat Protection



**Danger!** The housing is not equipped with heat protection. During steam-sterilization procedure, the surface of the housing can reach high temperatures and cause burns.

### 1.6.4 External Impacts



**Attention:** Objects falling on the housing can damage or destroy the unit, or cause leaks etc.

## 1.7 Emergency Measures



**Attention:** Always observe and comply with local regulations!

## 1.8 Safety Measures



**Attention:** Always observe and comply with local laws and regulations! These are not an integral part of this Instruction Manual.



**Danger!** It is mandatory to wear protective equipment such as protective goggles and protective clothing. Aggressive process medium escaping from the system may be hazardous to persons or the environment.



**Attention:** The operator is responsible for the instruction of personnel. Additional copies of this Instruction Manual can be ordered from the equipment supplier. As an integral part of the insertion housing, this Instruction Manual must at all times be readily accessible to users at the point of operation of the housing.

The operator must inform the supplier/manufacturer of the insertion housing immediately about any safety-relevant incidents, or observations made, during use of the housing.



**Danger!** Incorrect manipulation and/or instruction errors can lead to potential hazards for persons and for the environment.



**Attention:** Before every start-up, the insertion housing must be checked for:

- Damage to the connections, fastenings, etc.;
- Leakage;
- Defective cables and lines etc.;
- Authorization for use of the housing in conjunction with the associated plant resources.



**Danger!** Defective insertion housings must neither be installed nor put into operation. Leakage and inappropriate installation may lead to the escape of medium and cause a potential threat to life (including the risk of explosion).

## 1.9 Modifications



**Attention:** No attachments or modifications to the insertion housings are allowed.



**Danger!** The manufacturer/supplier accepts no responsibility for any damage caused by unauthorized attachments and alterations or for the incorporation of spare parts which are not of METTLER TOLEDO provenance. The risk is borne entirely by the operator.

## 2 Important Notes

---

### 2.1 Notes on Operating Instructions

These operating instructions contain all the information needed for safe and proper use of the housing.

The operating instructions are intended for personnel entrusted with the operation and maintenance of sensors and housings. It is assumed that these persons are familiar with the equipment in which the sensors and housings are installed.

#### Warning notices and symbols

This instruction manual identifies safety instructions and additional information by means of the following symbols:





This symbol draws attention to **safety instructions and warnings of potential danger which**, if neglected, could result in injury to persons and/or damage to property.



This symbol identifies **additional information and instructions** which, if neglected, could lead to defects, inefficient operation and possible loss of production.

## 2.2 Intended Use

The insertion housings InFit 761/4e are intended solely for measurement tasks in conjunction with the specified METTLER TOLEDO electrodes/sensors, namely pH and redox (ORP) combination electrodes as well as oxygen, CO<sub>2</sub>, conductivity or turbidity sensors. Use the housings only for this purpose.

Housings with the  or  symbol on the type plate have received approval for operation in potentially explosive/hazardous areas.

Any use of these housings which differs from or exceeds the scope of use described in this instruction manual will be regarded as inappropriate and incompatible with the intended purpose.

The manufacturer/supplier accepts no responsibility whatsoever for any damage resulting from such improper use. The risk is borne entirely by the user/operator.

Other prerequisites for appropriate use include:

- Compliance with the instructions, notes and requirements set out in this instruction manual;
- Correct maintenance of the housings;
- Acceptance of responsibility for regular inspection, maintenance and functional testing of all associated components, also including compliance with local operational and plant safety regulations;
- Operation in compliance with prevailing regulations concerning the environmental and operating conditions as well as with the admissible mounting positions;
- Compliance with all information and warnings given in the documentation relating to the products used in conjunction with the housings;
- Correct equipment operation in conformance with the prescribed environmental and operational conditions, and admissible installation positions;
- Consultation with METTLER TOLEDO Process Analytics in the event of any uncertainties.



**Danger!** The housing must be operated only with the specified electrodes/sensors. The absence or the installation of an inappropriate electrode/sensor may adversely affect the resistance to pressure and temperature, the chemical resistance and the protection against explosion. Consequently, there can be leakage from the housing and/or risk of explosion that may endanger persons and the environment.

## 2.3 Safety Instructions



- The plant operator must be fully aware of the potential risks and hazards attached to operation of the particular process or plant. The operator is responsible for correct training of the workforce, for signs and markings indicating sources of possible danger, and for the selection of appropriate, state-of-the-art instrumentation.
- It is essential that personnel involved in the commissioning, operation or maintenance of these housings or of any of the associated equipment (e.g. sensors, transmitters, etc.) be properly trained in the process itself, as well as in the use and handling of the associated equipment. This includes having read and understood this instruction manual.
- The safety of personnel as well as of the plant itself is ultimately the responsibility of the plant operator. This applies in particular in the case of plants operating in hazardous zones.
- The housings and associated components have no effect on the process itself and cannot influence it in the sense of any form of control system.



- Maintenance and service intervals and schedules depend on the application conditions, composition of the sample media, plant equipment and significance of the safety control features of the measuring system. Processes vary considerably, so that schedules, where such are specified, can only be regarded as tentative and must in any case be individually established and verified by the plant operator.
- Where specific safeguards such as locks, labels, or redundant measuring systems are necessary, these must be provided by the plant operator.
- A defective housing must neither be installed nor put into service.
- Only maintenance work described in these operating instructions may be performed on the housings.
- When changing faulty components, use only original spare parts obtainable from your METTLER TOLEDO supplier (see spare parts list, Section 8.2).
- No modifications to the housings and the accessories are allowed. The manufacturer accepts no responsibility for damage caused by unauthorized modifications. The risk is borne entirely by the user.
- Care must be taken during installation to avoid impacts or friction that could create an ignition source.
- Tampering and replacement with non-factory components may adversely affect the safe use of the system.
- Insertion or withdrawal of removable electrical connectors or modules is to be accomplished only when the area is known to be free of flammable vapors.
- **Warning!**  
Intrinsically safe apparatus can be a source of ignition if internal spacings are shorted or connections opened.
- **Warning!**  
Do not open when an explosive atmosphere is present.
- **Warning!**  
Substitution of components may impair intrinsic safety.
- **Warning!**  
Substitution of components may impair suitability of the equipment
- **Warning!**  
For connection only to non-flammable processes.

## 2.4 Correct Disposal of the Housing

When the housing is finally removed from service, observe all local environmental regulations for proper disposal.

## 2.5 Use in Ex zones



**Attention!** For an installation in Ex zones please read the guidelines following hereafter:



### Ex classification ATEX/IECEx:

II 1/2G Ex h IIC T6...T3 Ga/Gb

II 1/2D Ex h IIIC T69°C...T141°C Da/Db

**Number of the test certificate:**

SEV 13 ATEX 0161X

IECEX SEV 19.0014X

**Ex classification FM approved:**

IS/I,II,III/1/ABCDEFG/T6 Ta = 60 °C

–53 800 002; Entity

Project ID: 3021227

FM certificate number: FM16US0034X

FM18CA0021X

## 2.6 Ex classification ATEX/IECEX

### 2.6.1 Introduction

According to RL 2014/34/EU (ATEX114) Appendix I, InFit 7XX/\*1/\*2/\*3/\*4/\*5/\*6\*7\*8 housings are devices group II, category 1/2G and according to RL 99/92/EG (ATEX 137) may be used in zones 0/1 or 0/2 and gas group IIC that are potentially explosive due to combustible substances in the temperatures classes T3 to T6.

For use/installation, the requirements of EN 60079-14 must be observed.

According to RL 2014/34/EU (ATEX114) Appendix I, InFit 7XX/\*1/\*2/\*3/\*4/\*5/\*6\*7\*8 housings are devices group III, category 1/2D and according to RL 99/92/EG (ATEX 137) may also be used in zones 20/21 resp. 20/22 that contain combustible dusts.

For use/installation, the requirements of EN 60079-14 must be observed.

### 2.6.2 Special Conditions

1. The housings with pneumatic actuation position of the sensors with electrical feedback signal may be operated in hazardous areas Zone 1 and Zone 2 or Zone 21 and Zone 22 with separately certified intrinsically safe inductive proximity switches e.g. Pepperl + Fuchs types NCB2 \*\*\*– if the gas groups and temperature classes coincide with the used flammable substances and the special conditions of the Certificates are observed.
2. The maximum permissible ambient or process temperatures for Zone 0 (flammable gases or flammable liquids) shall be taken according to the following table:

Temperature class	Max. environment resp. media temp.
T6	68 °C (154.4 °F)
T5	80 °C (176 °F)
T4	108 °C (226.4 °F)
T3	140 °C (284 °F)

The maximum permissible ambient or process temperatures must not exceed the aforementioned values and they will be found in this instruction manual Section 8.

3. The maximum permissible surface temperature for Zone 20 (combustible dust) shall be taken accordingly to the following table:

Temperature class	Max. environment resp. media temp.
T 69 °C	68 °C (154.4 °F)
T 81 °C	80 °C (176 °F)
T 109 °C	108 °C (226.4 °F)
T 141 °C	140 °C (284 °F)

The maximum permissible ambient or process temperatures must not exceed the aforementioned values and they will be found in this instruction manual Section 8.

4. The metallic body of the housing type InFit 761/4e\*/1/\*2/\*3/\*4/\*5/\*6/\*7/\*8 has to be connected conductively to the equipotential system of the plant.
5. The housings type InFit 761/4e\*/1/\*2/\*3/\*4/\*5/\*6/\*7/\*8 are included in the periodic pressure testing of the system, where appropriate.
6. **Warning!**  
Potential electrostatic charging hazard – by installation, use and maintenance work, see instruction manual.
7. The housings made of titanium must be installed adequately protected against impact and friction sparks.

## 2.7 Ex classification FM Approved



IS/I,II,III/1/ABCDEFG/T6 Ta = 60 °C

## 2.7.1 Introduction

The following FM control drawing and the standards listed in Section 2.7.3 must be observed, where applicable:

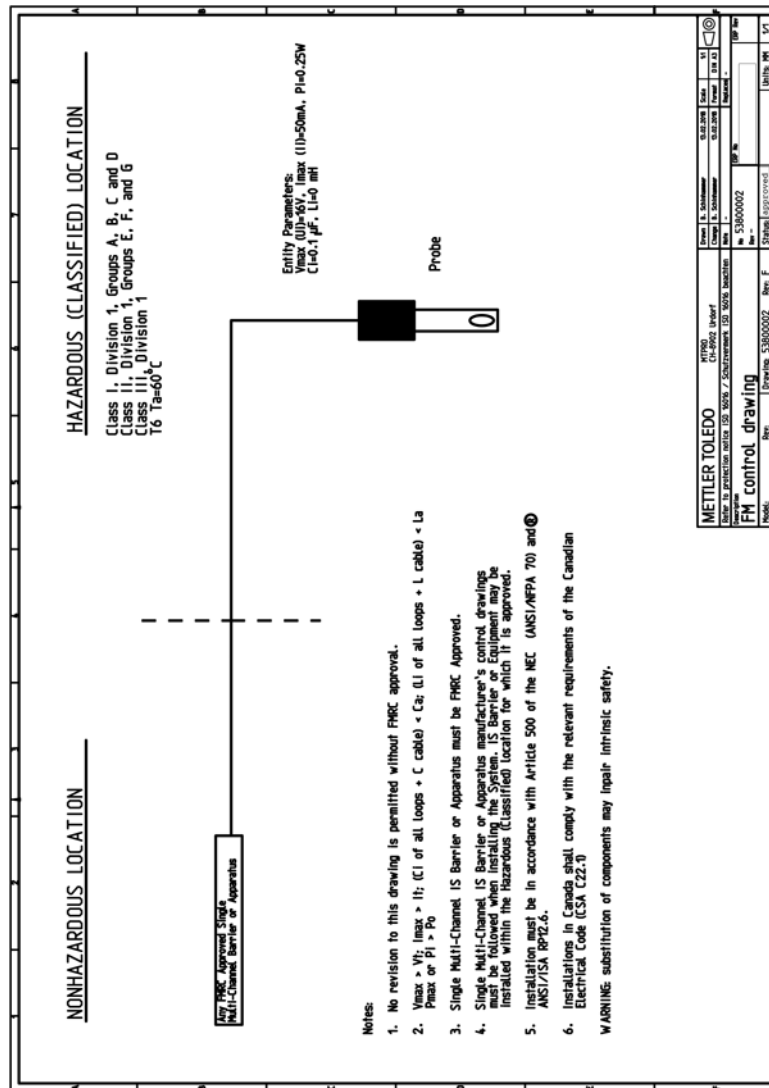

## 2.7.2 Special Conditions

See Section 2.6.2.

## 2.7.3 Applied Standards

### United States Standards

Title	Number	Issue Date
Approval Standard for Electrical Equipment for Use in Hazardous (Classified) Locations – General Requirements.	FM Class 3600	2011
Approval Standard for Intrinsically Safe Apparatus and Associated Apparatus for Use in Class I, II & III, Division 1, Hazardous (Classified) Locations.	FM Class 3610	2015
Approval Standard for Electrical Equipment for Measurement, Control and Laboratory Use.	FM Class 3810	2005
Explosive Atmospheres – Part 0: Equipment – General Requirements.	ANSI/ISA-60079-0 (12.00.01)	2005
Explosive Atmospheres – Part 11: Equipment Protection by Intrinsic Safety "i".	ANSI/ISA-60079-11 (12.02.01)	2009
Safety Requirements for Electrical Equipment for Measurement, Control, and Laboratory Use – Part 1: General Requirements.	ANSI/ISA-61010-1 (82.02.01)	2004

### Canadian Standards

Title	Number	Issue Date
Explosive Atmospheres – Part 0: Equipment – General Requirements.	FM Class 3600 CAN/CSA-C22.2 No. 60079-0	2015
Explosive Atmospheres – Part 11: Equipment Protection by Intrinsic Safety "i".	CAN/CSA-C22.2 No. 60079-11	2014
Safety Requirements for Electrical Equipment for Measurement, Control, and Laboratory Use – Part 1: General Requirements.	CAN/CSA-C22.2 No. 61010-1	2015

## 2.8 Hygienic Instruction

For the operation according EHEDG, please follow the instructions:

### 1. Use of instruments according EHEDG

The use of components with the EHEDG logo provides proof that the configuration was tested. The certificate always refers to a combination of sensor and process fitting.

### 2. Mounting

All parts of the measuring point must be certified according to EHEDG.

### 3. Installation position

The sensor has to be mounted that self-drainage of the sensor resp. housing is possible. If the sensor is mounted in a different position, the user must ensure the self-drainage of the sensor through suitable measures.

### 4. Socket

The height of the socket (h) can be at most twice as large as the difference between the sensor and the pipe inner diameter (D)

The following formula is applicable:

$$h \leq (D-d).$$

H Permissible socket height (sealing surface to tube inner diameter)

D Socket inner diameter

d Sensor diameter

## 3 Product Description

---

### 3.1 Scope of Delivery

Standard supply of the insertion housing is made up of the following:

#### Housing InFit 761e

- Protective sleeve with antikink protection;
- Cable grommet (for 5 mm or 7 mm cable);
- An instruction manual and a quick setup guide;
- Certificates depending on specifications.

#### Housing InFit 764e

- Protective sleeve with antikink protection;
- Manual air pump;
- Electrolyte recharge syringe;
- Pressure connection set;
- Cable grommet (for 5 mm or 7 mm cable);
- An instruction manual and a quick setup guide;
- Certificates depending on specifications.

### 3.2 Packing

The packing consists of cardboard with protective paddings.

Keep the packing for possible later use, such as for storage or transport of the housing. However, if you wish to dispose of the packing, please observe your local regulations on waste disposal.



**Attention:** Also see Section 10.3 "Disposal".

### 3.3 Checking the Shipment

When unpacking the shipment, carefully examine for signs of damage. Any damage must be reported to the carrier and your supplier without delay. Check that the shipment meets the delivery papers and your order.



**Attention:** Damaged housings must not be installed or put into operation (see Section 2).

### 3.4 Product Overview

The insertion housings are available in different versions, based on the "Product Key" on page 57):

**H = Immersion length, a = Sensor length**

**InFit 761/WS/\*\*/D00/\*9-  
oder / or / ou  
InFit 761/WS/\*\*/D11/\*9-**

**InFit 761/NS/\*\*/D00/\*9-  
oder / or / ou  
InFit 761/NS/\*\*/D11/\*9-**

**InFit 761/WS/\*\*/D10/\*2-**

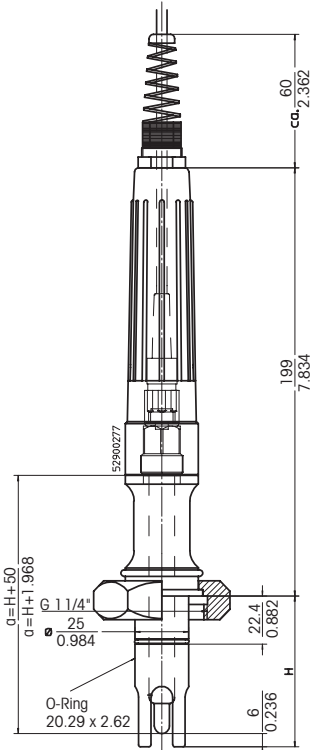
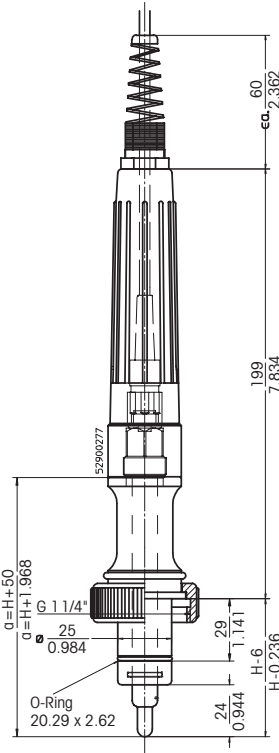
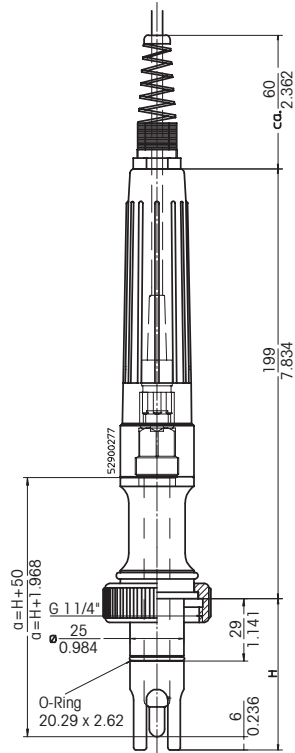

Dim.	mm
(app.)	inch

**H = Immersion length, a = Sensor length**

**InFit 761/NY/\*\*/P01/\*2-**

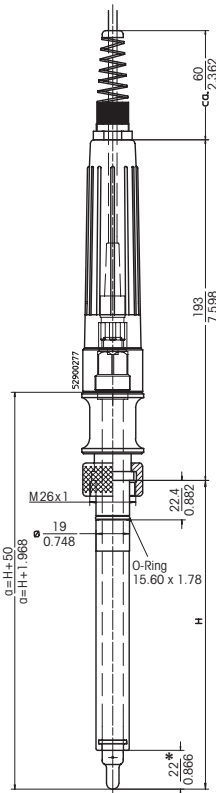

**InFit 761/WY/\*\*/P01/\*2-**

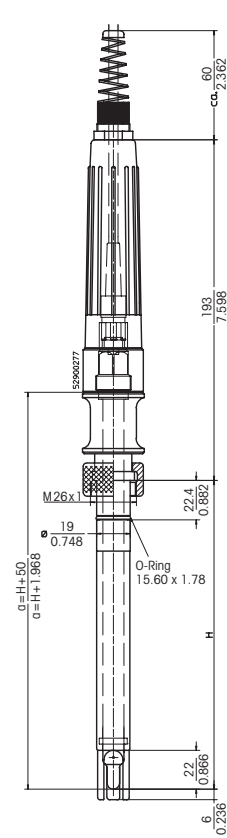

30 \* For housings with immersion length  
1.181 H=70 and without protective cage

**InFit 761/NY/\*\*/P01/\*2-**

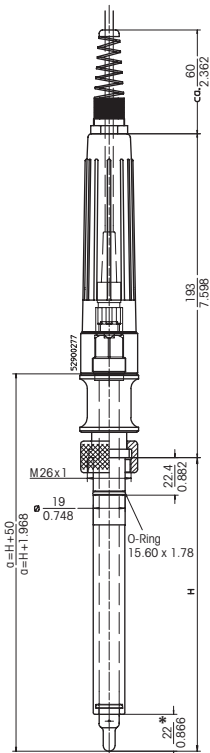

Dim.	mm
(app.)	inch



**H = Immersion length, a = Sensor length**

**InFit 761/WY/\*\*\*/P02/\*\*--**

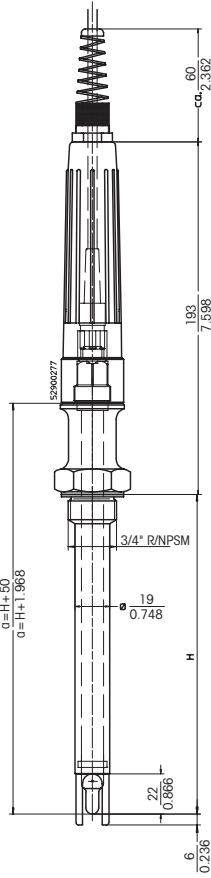

**InFit 761/NY/\*\*\*/N04/\*\*--  
oder / or / ou  
InFit 761/NY/\*\*\*/N01/\*\*--**

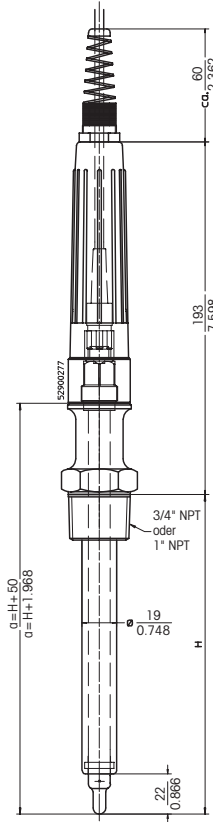

**InFit 761/WY/\*\*\*/N04/\*\*--  
oder / or / ou  
InFit 761/WY/\*\*\*/N01/\*\*--**

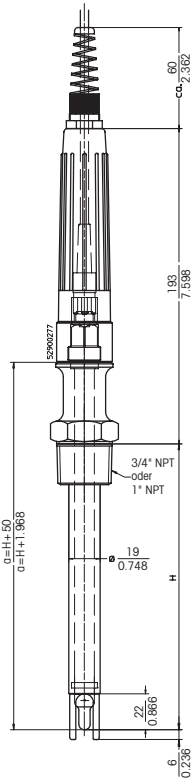

Dim.	mm
(app.)	inch



**H = Immersion length, a = Sensor length**

InFit 761/NC/\*/\*T02/\*--

InFit 761/NC/\*/\*T01/\*--

InFit 761/NC/0033/\*/\*T03/\*--

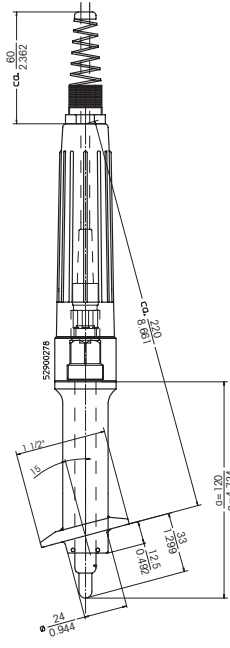
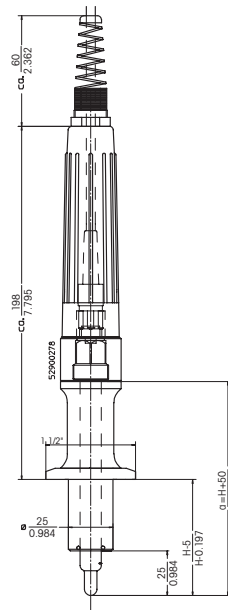
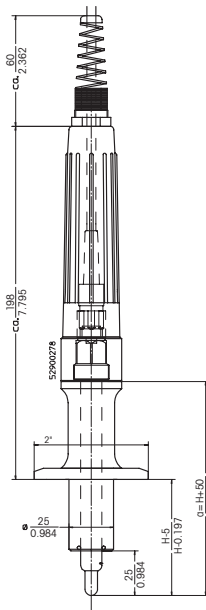

Dim.	mm
(app.)	inch

**H = Immersion length, a = Sensor length**

InFit764/NS/\*/\*D11/\*4-  
oder / or / ou  
InFit764/NS/\*/\*D00/\*4-

InFit764/WS/\*/\*D11/\*4-  
oder / or / ou  
InFit764/WS/\*/\*D00/\*4-

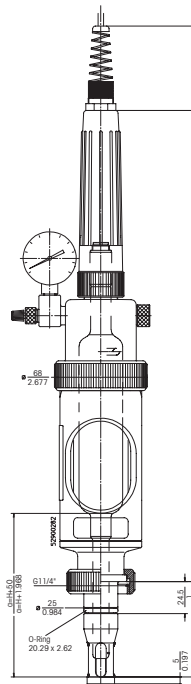
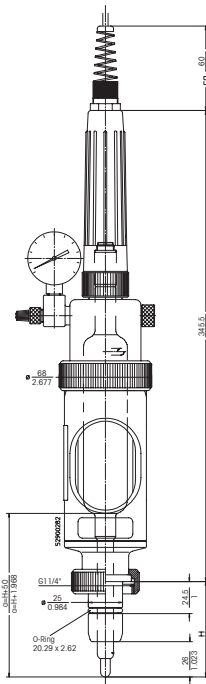

Form / shape / forme A

Form / shape / forme B

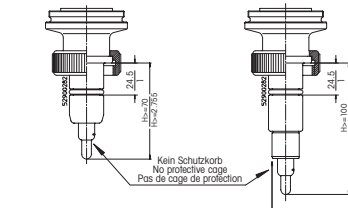

Optionaler Schutzkorb  
Optional protective cage  
Cage de protection optionnelle



- Aufsteckbarer Schutzkorb; nur erhältlich für den unteren Teil Form B mit der Länge  $\geq 100$ mm
- Plug-type protective cage; available only for lower probes shape B with lengths  $\geq 100$ mm
- Cage de protection attachable; seulement disponible pour les formes B avec longueurs  $\geq 100$ mm

Different shapes for the lower part of the immersion tube.

Dim.	mm
(app.)	inch





**Note:** Housings suitable for operation in hazardous areas carry a respective  or  symbol on their type plate. Housings that do not carry this additional marking are not admissible for use in hazardous areas.

All medium wetted parts of the housing are available in stainless steel according to DIN 1.4435/316L, DIN 2.4602/Alloy C22 or titanium, or made of PVDF and PP plastics. The head (top piece) is made of antistatic PP and nickel-plated brass. The O-ring seals between the housing and the medium are made of Viton® (FKM), Kalrez® (FFKM), silicone (MVQ) or EPDM.

## 4 Installation and Start-Up

---

### 4.1 Preparation of the Equipment

The insertion housings are mounted and fixed on a vessel (reactor, tank, pipe, etc.) either by means of a cap nut in conjunction with a weld-in socket, by a flange connection, by a Tri-Clamp or Varivent adaption or via an external NPT thread.



**Attention:** Attachment of the weld-in socket, flange connection or Tri-Clamp or Varivent adaption or threaded bushing is the responsibility of the customer.



**Attention:** Weld-in sockets or safety weld-in sockets G 1 1/4" (inner Ø = 25 mm, straight or 15° inclined) made of various material are available from your supplier.



**Danger!** Our welding instructions (included in the supply of the original METTLER TOLEDO socket) for the weld-in socket must be fully complied with, as otherwise the process connection can be untight (leak) or the pressure resistance insufficient.



**Caution!** After welding, the bore of the weld-in socket is to be checked and if necessary reamed to the dimension 25-H7.

In order to ensure correct function of the insertion housing, please observe the following installation instructions:

- The insertion housing can be mounted vertically or in an inclined position. In the case of inclined mounting, the angle of the housing must be equal to or greater than 15° above the horizontal.



**Caution!** Installation outside the admissible range of mounting positions is not allowed, otherwise correct operation of the electrodes/sensors may be impaired.

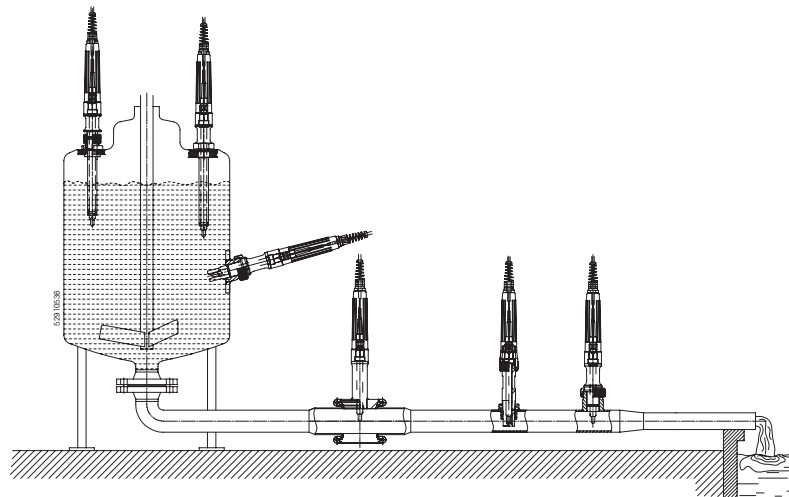

Admissible mounting position.

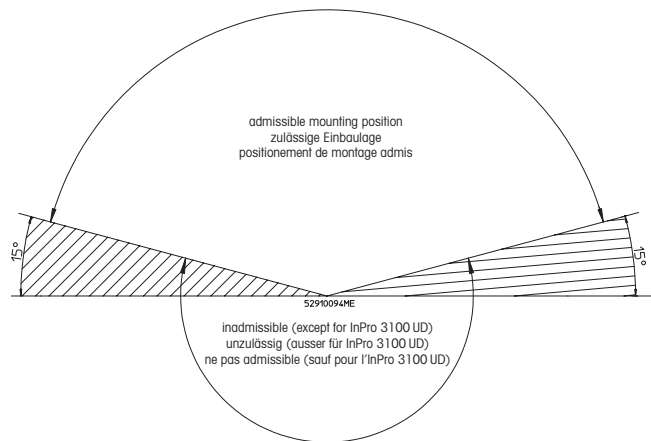

Installation options.

- The insertion housing is to be mounted in such a position that there is always enough clearance available for its correct functioning (correct measuring position in the process medium) as well as for maintenance work (checks, fitting and removal of the electrodes/sensors or the housing). The respective dimensions can be found in the drawings in the appendix to this Instruction Manual, or in the specifications.
- Installation of the insertion housing in exposed positions should be avoided. If this is not possible, appropriate protective measures against damage or interference must be taken.

## 4.2 Fitting and Installation Work



**Caution!** For all installation work described below, make sure the equipment in which the housing is to be installed is in a safe condition (depressurized, emptied, rinsed, vented, etc.).

### 4.2.1 Fitting the Housing



**Caution!** Never place the housing on the front end of the centering spigot or on the immersion tube (risk of damage e.g. damage of the N5 surface). Make sure the housing is fitted to the designated, appropriate socket or flange as directed (see Section 3.5).

### 4.2.1.1 Fitting with a Weld-in Socket

1. Clean the centering spigot of the insertion housing and the bore of the weld-in socket (25-H7) and check for damage.



**Caution!** Fitting of the insertion housing with a damaged spigot or into a damaged weld-in socket is not allowed and can present a hazard to persons and/or lead to material damage.



**Caution!** Make sure there are no obstacles in the insertion path that could hamper the motion of the immersion tube or damage the sensor/housing.

2. Check the O-ring on the spigot for damage and replace it if necessary. Slightly grease the O-ring. Ensure appropriate quality and positioning of the O-ring.
3. Position the housing on the weld-in socket and carefully insert the spigot into the bore.
4. Finally, tighten the cap nut until the connection is completely sealed.



**Caution!** Checking the sealing/tightness of the process adaptor is the responsibility of the operator who must also guarantee same by adopting appropriate measures. Additional safety provisions are required if the connection is subject to stress caused by vibrations.

### 4.2.1.2 Fitting with a Flange

1. Clean the sealing surfaces of the flange (housing and flange connection on vessel) and check for damage.



**Caution!** If the process media/reaction products are considered to be dangerous, it is imperative that an embedded seal is used at the flange interface and/or a splash guard is mounted. Fitting of the insertion housing with damaged flange connections is not allowed and can present a hazard to persons and/or lead to material damage.

2. Use the appropriate flange gasket and check for damage. Replace if necessary.



**Attention in the case of housings made of special alloy:** Check that the seal is present on the flange of the insertion housing and that it is not damaged. Replace if necessary. Ensure correct quality and positioning of the seal.

3. Position the housing on the flange connection, align, and tighten evenly crosswise using the prescribed number of bolts and nuts.

### 4.2.1.3 Fitting via NPT External Thread

1. Wind PTFE tape around the external male thread.
2. Screw the housing carefully into the female socket.
3. Check the Installation for leaks.

### 4.2.1.4 Fitting with Tri-Clamp and Varivent Flange Connection

1. Clean the sealing surfaces of the flange (housing and flange connection on vessel) and check for damage.



**Caution!** If the process media/reaction products are considered to be dangerous, it is imperative that an embedded seal is used at the flange interface and/or a splash guard is mounted. Fitting of the insertion housing with damaged flange connections is not allowed and can present a hazard to persons and/or lead to material damage.



**Caution!** Make sure there are no obstacles in the insertion path that could hamper the motion of the immersion tube or damage the sensor/housing.

2. Use the appropriate flange gasket and check for damage. Replace if necessary.
3. Position the housing on the flange connection, align, then thoroughly tighten the clamp fastener.

### 4.2.1.5 Installation with NPSM Thread

1. Carefully screw in the housing from the top.
2. First tighten by hand, then securely tighten with fork wrench (36 mm size).
3. Check the installation for leaks.

## 4.2.2 Fitting the Electrode/Sensor

### 4.2.2.1 InFit 761e



**Caution!** Damaged electrodes/sensors must never be installed.



**Attention:** To ensure tightness of the housing it is mandatory to use the antikink cable gland "A". In this case, lead the cable from the bottom through the antikink cable gland "A" before connecting it to the transmitter.

Attention: If the cable is already in place and the antikink cable gland "A" is not required you may lead the cable from the top through the protective sleeve "C". In this case, the supplied slotted cable grommet "F" (5 or 7 mm) must be used. However, in this scenario the tightness of the housing is not ensured.

1. Make sure the white PTFE sliding disk "D" is located directly below the electrode/sensor head, with the chamfered part facing the bottom, followed by the O-ring "E".
2. Check sliding disk and O-ring for damage and replace, as required.
3. Remove watering cap from the electrode/sensor tip and rinse electrode/sensor tip (membrane) with water.
4. Carefully insert the electrode/sensor into the tube and screw in by hand to the stop.
5. Push cable with connector "B" through protective sleeve "C".
6. Screw connector "B" to pH/Redox electrode or O<sub>2</sub> sensor. Tighten protective sleeve "C" on housing by hand.
7. Tighten antikink cable gland "A" or mount slotted cable grommet "F" to cable and push into protective sleeve "C".



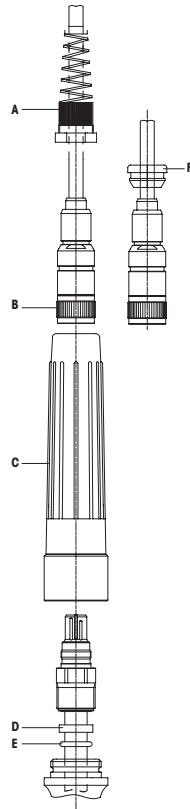



Fitting of electrode/sensor to InFit 761e.

 **Attention:** The protective sleeve efficiently guards the plug-type connection between electrode and cable against dirt, humidity and mechanical stress. **Therefore it is mandatory to use the protective sleeve for any installation.**

#### 4.2.2.2 InFit 764e

 **Caution!** Damaged electrodes/sensors must never be installed.

 **Attention:** To ensure tightness of the housing it is mandatory to use the antikink cable gland "A". In this case, lead the cable from the bottom through the antikink cable gland "A" before connecting it to the transmitter.

 **Attention:** If the cable is already in place and the antikink cable gland "A" is not required you may lead the cable from the top through the protective sleeve "C". In this case, the supplied slotted cable grommet "F" (5 or 7 mm) must be used. However, in this scenario the tightness of the housing is not ensured.

 **Caution!** It is mandatory to follow the sequence outlined below when fastening the cap nut "E" and the plastic adapter "D" (see illustration on page 39), otherwise the pH/Redox electrode may break.

1. Remove protective sleeve "C", plastic adapter "D", and finally undo cap nut "E".
2. Make sure you have chosen the appropriate type of pH/Redox electrode (see Section 1.1).
3. Remove watering cap from electrode tip, then undo the filling plug and the rubber band. Rinse the electrode tip (membrane) with water. The rubber band must always be removed before the electrode is fitted.



**Danger!** Do not tilt the electrode once the filling plug has been removed as this could cause the reference electrolyte to drain from the filling orifice.

4. Check the level of the reference electrolyte inside the electrode, and top up as required (see Instruction Manual of the respective electrode).
5. Carefully insert the electrode into the immersion tube until it is properly seated on the PTFE saddle.



**Attention:** For lateral installation make sure the marking "Position electrode this side up" is on top. Assuming the level is correct, no reference electrolyte can drain from the filling orifice in this position.

6. Check flat gasket of upper part for damage and replace, as required. Locate upper part and fasten the cap nut "E" by hand.



**Caution!** Cap nut "E" must be fastened only after the plastic adapter "D" has been removed.

7. Check seal of plastic adapter "D" and replace, as required. Locate plastic adapter and tighten by hand.
8. Remove cap of the plug-type connector from the electrode.
9. Push connector of cable through the protective sleeve "C" and fasten connector to plug-type head of the sensor.
10. Mount protective sleeve "C" and tighten by hand. Secure cable gland "A" or mount slotted cable grommet "F" to cable and push into protective sleeve "C".
11. Adjust compensation pressure: The compensation pressure may be adjusted at the valve insert of the pressure gauge using the supplied air pump, or by connecting a permanent, oil-free and filtered pressure supply (use pressure connection set included in the delivery).

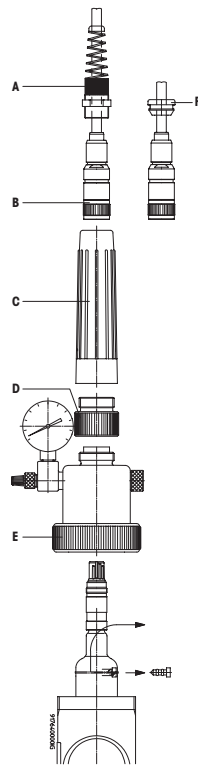

Fitting of electrode/sensor to InFit 764e.



**Attention:** The protective sleeve efficiently guards the plug-type connection between electrode and cable against dirt, humidity and mechanical stress. **Therefore it is mandatory to use the protective sleeve for any installation.**

### 4.3 Startup Procedures for Housings



**Attention:** Before startup, all fitting and installation work (see Section 4.2) must have been completed!

- Each time before startup, check the measuring system;
- Inspect the electrode/sensor assembly and examine housing and system for leaks;
- Do not commence operation until the measuring system has been checked and any necessary corrective action taken.

Before startup of an Ex-proof housing in a hazardous area, it is to be clarified beyond doubt that it is permitted to use the housing in question in conjunction with the other associated plant resources.



**Caution!** Be careful when manipulating the housing after it has been set into operation. It is mandatory to observe the information given in Section 5.1.

Pressure compensation is required only when using an electrode with liquid electrolyte.

In order to clearly define the flow direction of the reference electrolyte, there must always be an overpressure (0.5 to 2 bar/7.25 to 29 psig) in the reference electrode relative to the medium (pressure in the stirrer vessel).

Note that the hydrostatic pressure of the medium must be taken into account. The pressure required for the pressure compensation of the reference electrode is either supplied by the air pump included in the delivery or by a separate oil-free and dust-free pressure supply. If you wish to connect a separate pressure supply replace the valve insert with the pressure connection set. The actual pressure can be read from the pressure gauge.



**Attention:** If the pressure is supplied by the pump the actual pressure must be checked and re-adjusted on a regular schedule.

To relieve the system from the compensation pressure slightly loosen the valve insert or disconnect and purge the pressure supply.

## 4.4 Dismantling Work

### 4.4.1 Removing the Insertion Housing

Put the system into which the housing is incorporated in a safe state (depressurized, emptied, rinsed, purged, vented, etc.).

Then, loosen the appropriate connection and withdraw the housing.

### 4.4.2 Removing the Electrode/Sensor



**Caution!** Installation and removal of electrodes/sensors must be carried out only in safe conditions.

#### **InFit 761e:**

1. Undo antikink cable gland "A" or remove slotted cable grommet "F" from protective sleeve "C" and from cable.
2. Remove protective sleeve "C" from housing. Remove connector "B" from electrode cable and withdraw it from protective sleeve "C".
3. Carefully unscrew electrode/sensor and smoothly remove it from tube.
4. Check sliding disk and O-ring of electrodes/sensors for damage and replace, as required.



**Attention:** Specific information on the electrode (matching to the measuring system, storage of electrodes, etc.) is found in the documentation supplied with the electrode or the measuring system.

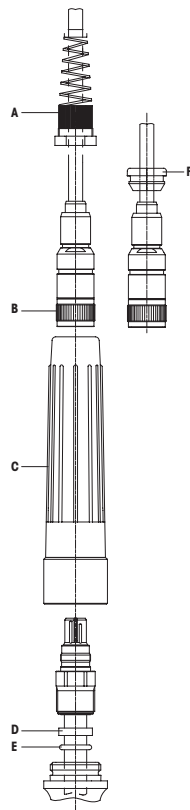

Removal of electrode/sensor from InFit 761e housing.

### InFit 764e



**Caution!** It is mandatory to follow the sequence outlined below when removing the plastic adapter "D" and the cap nut "E", otherwise the pH/Redox electrode may break.

1. Depressurize the upper part by slightly undoing the valve insert of the pressure gauge, or by disconnecting the external pressure supply. Fasten the valve insert again.
2. Undo antikink cable gland "A" or remove slotted cable grommet "F" from protective sleeve "C" and from cable.
3. Remove protective sleeve "C" from housing. Remove connector "B" from electrode cable and withdraw it from protective sleeve "C".
4. Undo and remove plastic adapter "D".
5. Undo cap nut "E" and remove upper part.
6. Carefully withdraw electrode from the immersion tube.



**Attention:** Specific information on the electrode (matching to the measuring system, storage of electrodes, etc.) is found in the documentation supplied with the electrode or the measuring system.

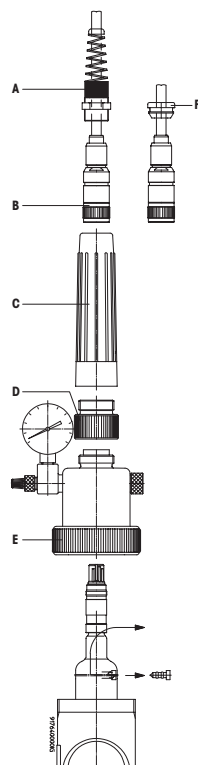

Removal of electrode/sensor from InFit 764e housing.

## 4.5 Sterilization

The InFit 761e housing equipped with the appropriate electrodes/sensors are suitable for sterilization and autoclaving.



**Caution!** Pay attention to the specifications of electrodes/sensors.



**Caution!** Do not sterilize or autoclave the InFit 761/4e housing with wetted parts made of plastic!



**Attention (InFit 761e):** Prior to autoclaving the (black) protection sleeve and the connection cable must be removed. Wait until the reactor has cooled down before re-installing these parts!

The InFit 764e insertion housing allows for sterilization of the built-in electrode.



**Caution!** Pay attention to the specifications of electrodes/sensors.



**Caution (InFit 764e)!** Autoclaving and heating of the entire housing is prohibited!

## 5 Operation

---

### 5.1 Important Information for Everyday Operation

During operation:

- Never remove fastening components (screws/bolts of flange, cap nut, etc.);
- If any malfunction occurs during operation, the equipment in which the housing is installed must first be made safe before any corrective measures are taken;
- For all work on the equipment during everyday operation, wear the stipulated protective clothing (protective goggles, gloves, breathing apparatus, etc.).

### 5.2 Inspection Work in Everyday Operation

The following inspection work should be performed in everyday operation:

- Check fastenings (cap nut, flange, NPT thread) of the housing at the vessel for firm seating and possible leaks.
- Check the condition of the electrode/sensor. A faulty or damaged electrode/sensor must be replaced without delay.

#### **Housings with pressure compensation (InFit 764e):**

- Check functioning of pressure gauge;
- Check air pressure in upper part (read pressure gauge). The air pressure must be at least 0.5 bar/7.25 psig (2 bars/29 psig maximum) above that of the sample medium (take hydrostatic pressure of the sample medium into account) to ensure the flow of electrolyte from the reference electrode to the sample medium.



**Attention:** The desired overpressure is set with the supplied air pump via the valve insert at the pressure gauge or established by means of a compressed air supply.

- Check level of the reference electrolyte. The level of the reference electrolyte steadily sinks due to outflow through the diaphragm. If the liquid level has sunk to a level below the mouth of the bulb (reservoir) of the pH/Redox electrode, then the reference electrolyte must be topped up (see Section 6 "Maintenance").

### 5.3 Cleaning the Electrode/Sensor

The electrode/sensor must be cleaned before removal, before calibration of the measurement system or at regular intervals during operation (depending on the process medium).

## 5.4 Calibrating the Measuring System

It is not mandatory to remove the electrode from the housing for calibration. The same applies to the pressure compensation of the InFit 764e housing which does not need to be disconnected. The installed electrode may be directly immersed in the buffer solutions.

For further details on the calibration procedure please refer to the Instruction Manuals of the electrode and the pH/mV transmitter.



**Attention:** After installation of the housing check for possible leaks.



**Important!** Further information on the operation of pH/Redox electrodes and O<sub>2</sub>, CO<sub>2</sub>, turbidity and conductivity sensors is found in the respective Instruction Manuals.

## 6 Maintenance

---

### 6.1 Important Information on Maintenance



**Caution!** The process medium may be harmful to your health and/or the environment (toxic, caustic, etc.). For this reason you have to put the system into a safe state before starting any maintenance work.

Always keep electrode/sensor, housing and socket clean.

Replace defective seals and other components without delay.

The information and instructions given in Section 1 and Section 2 must be fully adhered to.

Maintenance and service work on the housings may be carried out by appropriately trained personnel only.

Only genuine spare parts from METTLER TOLEDO must be used, otherwise all guarantees become automatically invalid.

Only the maintenance and repair work described in the following sections may be performed on the insertion housings.

Information on the maintenance of electrodes and sensors are found in the respective Instruction Manuals.



**Attention:** Service carried out by authorized METTLER TOLEDO technicians: Your local distributor will be pleased to offer professional service and care. Please contact your local supplier for more information.



## 6.2 Topping up Reference Electrolyte

The work described below applies only to pH/Redox electrodes with liquid reference electrolyte. In order to top up the reference electrolyte, proceed as follows:

1. Remove electrode (see Section 4.4).



**Attention:** The reference electrolyte may not be topped up with the electrode installed.

2. Top up reference electrolyte (Electrolyte no. see "Refill" marking on the electrode).



**Caution!** Take care not to exceed the maximum filling level.

3. Re-install the electrode (see Section 4.2.2).



**Do not allow any spillage of reference electrolyte to remain in the housing. Wash down and dry the housing.**

## 6.3 Replacement of Medium-Wetted Seals

All medium-wetted seals should be replaced at least every 6 months for reasons of safety. With aggressive media, the seals may need to be replaced at correspondingly shorter intervals. Medium-wetted seals must be examined at least once a month, as well as during normal maintenance procedures, to check for soiling or damage.



**Attention:** Seals are wearing parts which must be regularly examined by the operator of the housing, and replaced if necessary (dependent upon application).

### Replacement of medium-wetted seals

All medium-wetted seals should under all circumstances be replaced at least every 6 months.

### Check on medium-wetted seals

METTLER TOLEDO recommends that medium-wetted seals should under all circumstances be examined and checked every 3 months.

In the case of aggressive or abrasive media, the seals may need to be checked/replaced at shorter intervals.



**Attention:** Recommendations by METTLER TOLEDO concerning maintenance intervals are based solely on experience gained in standard applications and in no way binding or an admission of any guarantee liability whatsoever on the part of the manufacturer/supplier. Depending upon the degree of aggressiveness of the process medium, the necessary maintenance intervals to support smooth operation of the equipment may be correspondingly shorter.



**Attention:** All O-rings are made of FDA approved materials. In addition, Kalrez® O-rings are certified according to USP Class VI.



**Caution!**

- Insertion housings may only be stripped down for maintenance and repair work after having been completely dismantled from the equipment in which they were installed for operation;
- Only perform the dismantling work described and instructed in this section and replace only the seals listed above. Check that the correct types of seals have been selected, examine for any signs of damage and for correct seating;
- Ensure that the seals are of the correct material quality (see Section 8).

**Proceed as follows to replace the seals:**

1. Set the housing out of service (see Section 4.4).
2. Remove electrode/sensor from the housing (see Section 4.4.2) and store as described in the electrode/sensor operating instructions.
3. Remove the housing from the equipment (reactor, vessel, pipe, etc.) in which it is installed (see Section 4.4.1) and place it on a clean working surface.



**Caution!** Never place or support the housing on the front ends of the centering spigot or on the immersion tube (risk of damage).

4. Remove the indicated seals with a fine hook making sure not to scratch their contact surfaces.
5. Lightly grease new O-rings (set of seals) with lab grease!



**Caution!** No grease may be applied to the O-Ring "B" in the immersion tube, as there is a danger that grease could contact and adhere to the electrode/sensor tip (diaphragm/glass membrane) when reinstalling the electrode/sensor, and have adverse effects on its function.

6. Carefully insert O-rings "B" and "A" using the assembly mandrel, (part no. 59 908 798).

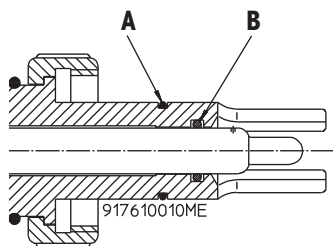

Replacement of O-rings.

## 7 Troubleshooting

In this section you will find an overview of possible malfunctions which could appear during operation of the insertion housings, their cause, as well as a guide to appropriate remedial measures.



**Danger!** It is essential to comply with the safety instructions given in Section 1 and Section 2.

**M = Malfunction**

**C = Cause**

**R = Remedial action**

**M 1:** **Incorrect measuring/fluctuations in measured data**

**C 1:** Electrode/sensor defective, Transmitter defective.

**R 1:** Check electrode/sensor and transmitter. Repair or replace if necessary.

**InFit 764e:**

**M 2:** **No pressure in upper part (pressure compensation) or drops rapidly**

**C 2a:** Compensation pressure not set.

**R 2a:** Set compensation pressure with pump or check compressed air supply.

**C 2b:** Leak in upper part.

**R 2b:** Check screw fittings and seals.

**C 2c:** Electrode broken.

**R 2c:** Replace electrode.

**M 3:** **Sample medium escapes through the NPT thread**

**C 3:** Thread insufficiently sealed.

**R 3:** Seal using PTFE tape.

**M 4:** **Sample medium escapes at the flange connection**

**C 4a:** Flange connection not or unevenly fastened.

**R 4a:** Check flange connection and/or tighten the fastenings.

**C 4b:** Flange gasket defective.

**R 4b:** Check gasket and replace if necessary.

**M 5:** **Sample medium escapes between cap nut and weld-in socket**

**C 5:** O-ring at centering spigot of insertion housing defective.

**R 5:** Remove housing and replace O-ring.

**M 6:** **Housing leaks**

**C 6:** O-ring "A" or "B" is defective (see page 49).

**R 6a:** The housing has to be tested for leaks with the electrode installed. Use the air pump to adjust the pressure in the housing to 6 bars/87 psig. An air-tight housing loses less than 0.5 bar/7.25 psig within 10 hours.

**R 6b:** For testing the connection between the weld-in socket and the housing for leaks the reactor/piping/flowthrough chamber must be pressurized. Air escaping from the system may be detected using a leak detection spray.



**Danger!** Before carrying out any work on the housing make sure the system is in a safe state (depressurized, emptied, rinsed, purged, vented, etc.).

# 8 Product Specifications

## 8.1 Technical Data

### 8.1.1 Technical Specifications InFit 761e



**Note:** The technical specifications of the installed electrode/sensor must be taken into consideration.

**Ambient conditions**

Temperature 0...70°C (32...158°F)

**Process conditions**

Housing	Material	Max. permissible pressure and temperature [PS]/[TS]: (linear relation with plastic housings)
InFit 761/*S	DIN 1.4435, DIN 2.4602/AISI Alloy C22, Ti  PP PVDF	16 bar / 140°C (232 psig / 284°F)

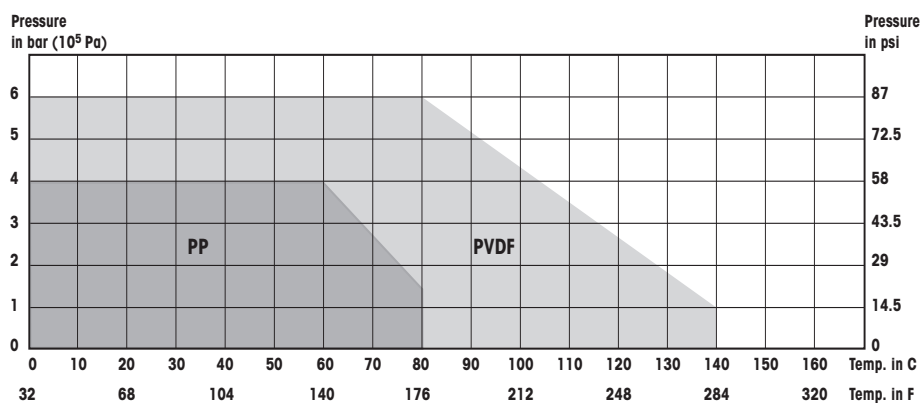

InFit 761/WK	PP PVDF
--------------	------------

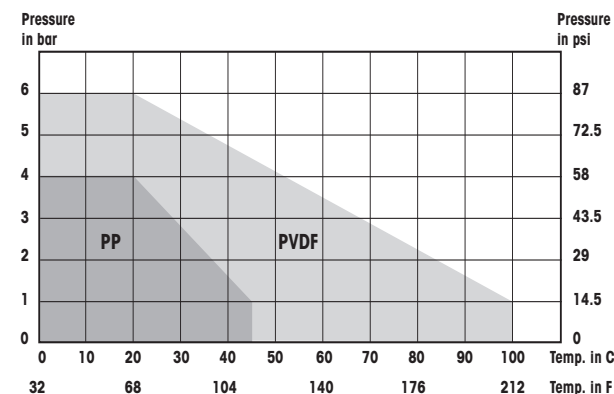

InFit 761/NC	DIN 1.4435 DIN 2.4602/AISI Alloy C22 Ti	16 bar / 140°C (232 psig / 284°F)
--------------	---	--------------------------------------

InFit 761/*Y	DIN 1.4435,	6 bar/140 °C
	DIN 2.4602/AISI Alloy C22,	(87 psig/284 °F)
	Ti,	
	PVDF	6 bar/20 °C
		(87 psig/68 °F)
		1 bar/100 °C
		(14.5 psig/212 °F)

**Immersion length**

Immersion length and appropriate sensor length see Section 11.

<b>Wetted materials</b>	DIN 1.4435, DIN 2.4602/Alloy C22, titanium, PP, PVDF
-------------------------	--

<b>Wetted seals</b>	Silicone (MVQ)-FDA USP Class VI, Viton® (FKM)-FDA, EPDM-FDA, Kalrez® (FFKM)-FDA USP Class VI
---------------------	---

<b>Non-wetted materials</b>	Handle complete	Polypropylene (PP antistatic)
-----------------------------	-----------------	-------------------------------

<b>Weight</b>	approx. 0.5 kg
---------------	----------------

<b>Pressure information</b>	According to PED 97/23/EG-Article 1, Section 2.2 "Intended Use" is referenced to atmospheric pressure, e.g. an overpressure. Accordingly, a pressure in the vacuum region will be expressed as a negative pressure.
-----------------------------	---

**Explosion protection**

(Applicable for all housings with wetted parts made of metal)

According to ATEX directives (2014/34/EU):

Ⓔ II 1/2G Ex h IIC T6...T3 Ga/Gb  
 Ⓔ II 1/2D Ex h IIC T69 °C...T141 °C Da/Db  
 SEV 13 ATEX 0161 X  
 IECEx SEV 19.0014X

According to FM directives:

IS CL I,II,III, Div 1, GR A,B,C,D,E,F,G  
 Tamb. = 0 °C to +60 °C,  
 indoor and outdoor environments.  
 FM control drawing: 53800002;  
 Original project ID 3021227;  
 FM Certificate number: FM16US0034X  
 FM18CA0021X

<b>Certificates/approvals</b>	Depending on housing model, following certificates/approvals are included: <ul style="list-style-type: none"> <li>• CE Declaration of Conformity</li> <li>• Pressure Equipment directive</li> <li>• Certificate of Conformity according to EN10204 2.1, material certificate according to 3.1B</li> <li>• ATEX</li> <li>• cFMus Approval</li> <li>• MaxCert™</li> </ul>
-------------------------------	---

<b>Appropriate types of electrodes</b>	See Section 11.  For more detailed information regarding electrodes and sensors please refer to the corresponding data sheets or contact your METTLER TOLEDO representative.
--	--

## 8.1.2 Technical Specifications InFit 764e



**Note:** The technical specifications of the installed electrode/sensor must be taken into consideration.

### Ambient conditions

Temperature	0...70°C (32...158°F)
-------------	-----------------------

### Process conditions

Housing	Material	Max. permissible pressure and temperature [PS]/[TS]: (linear relation with plastic housings)
InFit 764	DIN 1.4435, DIN 2.4602/AISI Alloy C22, Ti	16 bar/130°C (232 psig/266°F)
	PVDF	6 bar/20°C (87 psig/68°F) 1 bar/110°C (14.5 psig/230°F)

### Immersion length

Immersion length and appropriate sensor length see Section 11.

<b>Wetted materials</b>	DIN 1.4435, DIN 2.4602/Alloy C22, Titanium, PVDF
-------------------------	--

<b>Wetted seals</b>	Silicone (MVQ)-FDA USP Class VI, Viton® (FKM)-FDA, EPDM-FDA, Kalrez® (FFKM)-FDA USP Class VI
---------------------	---

### Non-wetted materials

Top piece:	Nickel-plated brass, Polypropylene (PP) antistatic
Cylinder:	Glass
Saddle:	PTFE
Handle compl.:	Polypropylene (PP) antistatic

<b>Weight</b>	approx. 2 kg
---------------	--------------

<b>Pressure information</b>	According to PED 97/23/EG-Article 1, Section 2.2 "Intended Use" is referenced to atmospheric pressure, e.g. an overpressure. Accordingly, a pressure in the vacuum region will be expressed as a negative pressure.
-----------------------------	---

**Explosion protection**

(Applicable for all housings with wetted parts made of metal and antistatic PVDF.)

According to ATEX directives (2014/34/EU):

Ⓔ II 1/2G Ex h IIC T6...T3 Ga/Gb  
 Ⓔ II 1/2D Ex h IIC T69°C...T141 °C Da/Db  
 SEV 13 ATEX 0161 X  
 IECEx SEV 19.0014X

According to FM directives:

IS CL I,II,III, Div 1, GR A,B,C,D,E,F,G  
 Tamb. = 0 °C to +60 °C,  
 indoor and outdoor environments.  
 FM control drawing: 53800002;  
 Original project ID 3021227;  
 FM Certificate number: FM16US0034X  
 FM18CA0021X

**Certificates/approvals**

Depending on housing model, following certificates/approvals are included:

- CE Declaration of Conformity
- Pressure Equipment directive
- Certificate of Conformity according to EN10204 2.1, material certificate according to 3.1B
- ATEX directive
- cFMus Approval
- MaxCert°C

**Appropriate types of electrodes**

See Section 11.

For more detailed information regarding electrodes and sensors please refer to the corresponding data sheets or contact your METTLER TOLEDO representative.

## 8.2 Spare Parts and Accessories

**Spare parts** (see drawings).

No. and designation	Order no.
O-ring replacement set Silicone USP 76Xe	52 403 459
O-ring replacement set Ethylene Propylene FDA 76Xe (both numbers need to be ordered!)	52 403 460 30 558 412
O-ring replacement set Viton® FDA 76Xe	52 403 461
O-ring replacement set Kalrez® USP 76Xe (25 mm ø shaft)	52 403 462
O-ring replacement set Kalrez® USP 76Xe (19 mm shaft ø)	52 403 504
Retrofit kit for InPro 6860i/6970i	52 403 811
<b>(100)</b> Antikink cable gland Pg 16	52 403 470
<b>(90)</b> Cable grommet set 5 mm/7 mm	52 403 463
<b>(110)</b> Cap nut G 1¼" (NPSM), Ms, height = 18 mm	59 901 133
<b>(120)</b> Cap nut G 1¼" (NPSM), Ms for sensor holder type "C"	59 909 320
<b>(130)</b> Protective tube InFit 761/4e	52 403 465
<b>Spare parts only for InFit 761e:</b>	
<b>(140)</b> Protective tube long 761e	52 403 464
<b>(150)</b> Adapter InFit 761/WK	52 403 466

**Spare parts only for InFit 764e:**

<b>(10)</b>	Adapter cpl. with gasket 764e	52 403 468
<b>(20)</b>	PTFE bushing	59 901 136
<b>(30)</b>	Glass cylinder	59 901 147
<b>(40)</b>	Flat gasket set 764e	52 403 523
<b>(50)</b>	Top piece complete 7XX	52 403 524
<b>(60)</b>	Pressure gauge 0...6 bar compl.	59 901 296
<b>(70)</b>	Pressure connection set	59 905 552
<b>(80)</b>	Valve insert	59 905 517

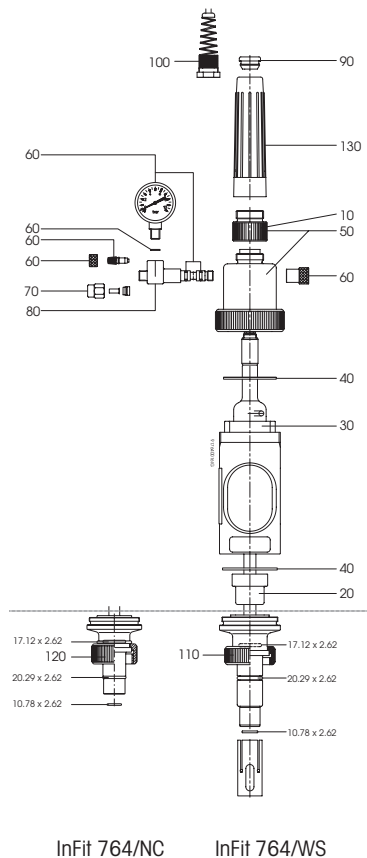
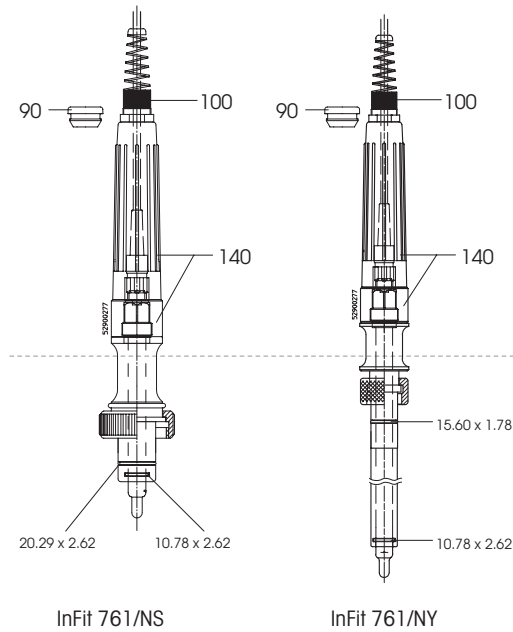



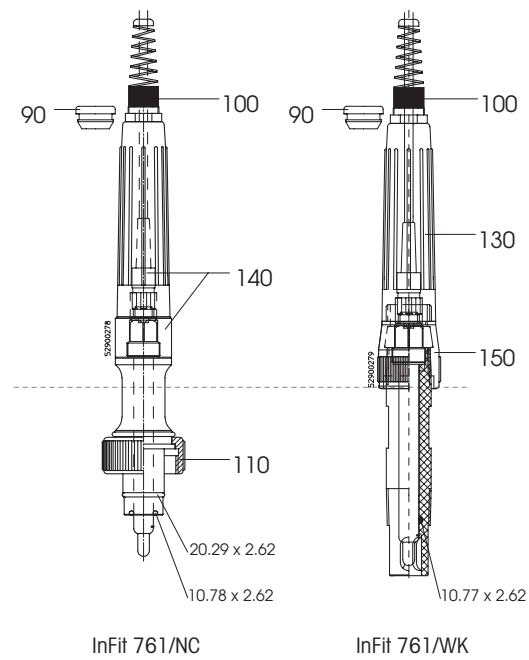

## Accessories

Designation	Order no.
<b>Weld-in socket</b>	
Weld-in socket L=40/DN25/inclined/1.4435	59 900 903
Weld-in socket L=48/DN25/inclined/1.4435	59 901 125
Weld-in socket L=55/DN25/inclined/1.4435	59 901 126
Weld-in socket L=40/DN25/straight/1.4435	59 901 127
Weld-in socket L=50/DN25/straight/1.4435	59 901 128
Weld-in socket L=60/DN25/straight/1.4435	59 901 129
Threaded socket L=40/DN19/1.4435	59 901 290
Safety weld-in socket L=47/DN25/straight/1.4435	52 400 518
Safety weld-in socket L=40/DN25/inclined/1.4435	52 400 462
Weld-in socket L=40/DN25/inclined/Alloy C22	59 901 245
Weld-in socket L=40/DN25/straight/Alloy C22	59 901 242
Weld-in socket L=40/DN25/straight/PVDF	59 901 206
Weld-in socket L=40/DN25/inclined/PVDF	59 901 208

**Blind plug**

Blind plug DN25 L=40/inclined/1.4435/Silicone USP	59 901 283
Blind plug DN25 L=48/inclined/1.4435/Silicone USP	59 901 284
Blind plug DN25 L=55/inclined/1.4435/Silicone USP	59 901 285
Blind plug DN25 L=40/straight/1.4435/Silicone USP	59 901 287
Blind plug DN25 L=50/straight/1.4435/Silicone USP	59 901 288
Blind plug DN25 L=60/straight/1.4435/Silicone USP	59 901 289
Blind plug DN19 L=42/straight/1.4435	59 901 294
Safety blind plug DN25/L=30/1.4435/Silicone USP	52 400 464
Blind plug DN25/L=40/straight/Alloy C22/Kalrez® USP	59 908 917
Blind plug DN25/L=40/inclined/PVDF/Viton®-FDA	59 901 318

**Protective cage**

Protective cage, for immersion length H>=100 mm/1.4435	59 901 132
Protective cage, for immersion length H>=100 mm/Alloy C22	52 402 858

Further accessories on request at your local METTLER TOLEDO representative.



**Note:** The replacement of other parts of the housing may be made only by a trained specialized person. Please contact your local METTLER TOLEDO distributor.



**Note on accessories:** Further information on particular accessories is found in the respective technical documentation. For more ample information please contact you local METTLER TOLEDO distributor.

## 9 **Terms of Warranty**

---

The housings employ state-of-the-art technology and are very reliable. They are permanently revised to meet the latest technical evolutions and leave the factory only after having passed thorough quality testing. The warranty period of 12 months starts from the date of delivery. The warranty covers all defects due to faulty material or manufacturing.

Normal wear or damage caused by inadequate use (such as chemical incompatibility, etc.) are not covered by the warranty. In any case, the warranty is limited to the replacement or repair of faulty products, depending on manufacturer's choice. The warranty is void if the customer or any third party apply modifications to products supplied by METTLER TOLEDO. Any defect that may be subject to warranty must be reported to the supplier without delay or, at the latest, before the warranty period ends.

## 10 **Decommissioning, Storage, Disposal**

---



**Caution:** The safety notes in Section 2 "Important Notes" must be observed. Decommissioning may only be carried out by persons with appropriate training or by skilled technicians.

### 10.1 **Decommissioning**

#### 10.1.1 **Proceed as Described in Section 4.4 "Dismantling Work".**

#### 10.1.2 **Repair**

If you cannot remedy a problem on the spot send the housing to your local distributor, together with an ample description of the problem.



**Caution:** To protect our service staff, housings that have been in touch with toxic or otherwise dangerous substances must be thoroughly cleaned and clearly marked before dispatching.

### 10.2 **Storage**

Store the InFit 761/4e in a dry place. Before storage, the housing must properly cleaned and dry.

### 10.3 **Disposal**



It is mandatory that the operator disposes of the device in accordance with local regulations. The operator must deliver the device either to a licensed private or public disposal company, or dispose of it himself in accordance with prevailing regulations. Waste is to be recycled or disposed of without causing any risk to human health, and without using procedures or methods that might harm the environment.

#### **Sorting**

Sorting into waste groups takes place when dismantling the device. The groups are listed in the current European Waste Catalogue. This catalog is valid for all kinds of waste, whether intended for disposal or for recycling.

The packaging is made up of the following materials:

- cardboard;
- foam plastic.

The housing is made of the materials specified in the technical data.

# 11 Appendices

## 11.1 Electrode/Sensor Selection

Concise overview of electrode and sensor length in relation to the length of the housing (immersion length = H).

### InFit 761e

H = Immersion length	$\alpha$ -Length of the electrode/sensor
H = 25 mm, H = 33 mm, H = 40 mm, H = 70 mm	120 mm
<b>pH</b>	DPA/DPAS, DXK, InPro 3030, InPro 3100, InPro 3200, InPro 3250, InPro 3300, InPro 4010, InPro 4250, InPro 4800
<b>Dissolved oxygen</b>	InPro 6050, InPro 6800, InPro 6900
<b>CO<sub>2</sub></b>	InPro 5000
<b>Conductivity</b>	InPro 7001-VP
<b>Turbidity</b>	InPro 8050, InPro 8100, InPro 8200
H = 100 mm	150 mm (pH)
<b>pH</b>	DPA/DPAS, DXK, InPro 3030, InPro 3100, InPro 3200, InPro 3250, InPro 3300, InPro 4010, InPro 4250, InPro 4800
H = 175 mm	205 mm (turbidity), 220 mm (DO, CO <sub>2</sub> ) or 225 mm (pH, conductivity)
<b>pH</b>	DPA/DPAS, DXK, InPro 3030, InPro 3100, InPro 3200, InPro 3250, InPro 3300, InPro 4250, InPro 4800
<b>Dissolved oxygen</b>	InPro 6800, InPro 6900
<b>CO<sub>2</sub></b>	InPro 5000
<b>Conductivity</b>	InPro 7001-VP
<b>Turbidity</b>	InPro 8100, InPro 8200
H = 275 mm	297 mm (turbidity), 320 mm (DO, CO <sub>2</sub> ) or 325 mm (pH)
<b>pH</b>	DPA/DPAS, DXK, InPro 3030, InPro 3100, InPro 3200, InPro 3250, InPro 3300, InPro 4250, InPro 4800
<b>Dissolved oxygen</b>	InPro 6800, InPro 6900
<b>CO<sub>2</sub></b>	InPro 5000
<b>Turbidity</b>	InPro 8100, InPro 8200
H = 375 mm	407 mm (turbidity), 420 mm (CO <sub>2</sub> ) or 425 mm (pH)
<b>pH</b>	DPA/DPAS, DXK, InPro 3030, InPro 3100, InPro 3200, InPro 3250, InPro 3300, InPro 4250, InPro 4800
<b>Dissolved oxygen</b>	InPro 6800, InPro 6900
<b>Turbidity</b>	InPro 8100, InPro 8200



**Note:** For more information on the wide range of available METTLER TOLEDO electrodes and sensors please contact your METTLER TOLEDO representative.

**InFit 764e**

<b>H = Immersion length</b>	<b>α-Length of the electrode/sensor</b>
H = 70 mm	120 mm
<b>pH</b>	(HA, HF, LoT) 465-50, InPro 2000
<b>Redox</b>	Pt4865-50
H = 100 mm	150 mm
<b>pH</b>	(HA, HF, LoT) 465-50, InPro 2000
<b>Redox</b>	Pt4865-50
H = 150 mm	200 mm
<b>pH</b>	(HA, HF, LoT) 465-50, InPro 2000
<b>Redox</b>	Pt4865-50
H = 200 mm	250 mm
<b>pH</b>	(HA, HF, LoT) 465-50, InPro 2000
<b>Redox</b>	Pt4865-50









For addresses of METTLER TOLEDO  
Market Organizations please go to:  
**[www.mt.com/pro-MOs](http://www.mt.com/pro-MOs)**

**[www.mt.com/pro](http://www.mt.com/pro)**

For more information



Management System  
certified according to  
ISO 9001/ISO 14001

**METTLER TOLEDO Group**  
Process Analytics  
Local contact: [www.mt.com/pro-MOs](http://www.mt.com/pro-MOs)

Subject to technical changes  
© 09/2021 METTLER TOLEDO  
All rights reserved. 52 403 547 K  
Printed in Switzerland

