

# Operation Manual 4000TOCe Sensor M300 TOC Transmitter



## Total Organic Carbon Measurement System

4000TOCe Sensor  
M300 TOC Transmitter  
30 415 924 Rev A

**METTLER TOLEDO**



# Operation Manual

## 4000TOCe Sensor

### M300 TOC Transmitter

©METTLER TOLEDO Thornton, Inc. 2017

No part of this manual may be reproduced or transmitted in any form or by any means, electronic or mechanical, including photocopying (other than where specifically noted), for any purpose without the express written permission of METTLER TOLEDO, Inc. U.S. Government Restricted Rights: This documentation is furnished with Restricted Rights.

**METTLER TOLEDO THORNTON RESERVES THE RIGHT TO MAKE REFINEMENTS OR CHANGES WITHOUT NOTICE.**

This document contains proprietary information, which is protected by copyright. All rights are reserved. No part of this document may be photocopied (other than where specifically noted), reproduced or translated, into another language without the prior written consent of METTLER TOLEDO Thornton, Inc.



# Content

<b>1</b>	<b>Introduction</b>	<b>9</b>
<b>2</b>	<b>Safety instructions</b>	<b>10</b>
2.1	Definition of equipment and documentation symbols and designations	10
2.2	Correct disposal of the unit	11
<b>3</b>	<b>Unit overview</b>	<b>12</b>
3.1	Overview, 4000TOCe Sensor	12
3.1.1	Sensor Details	12
3.1.2	High Pressure Applications	13
3.1.3	Potential Condensation Applications	13
3.1.4	High Temperature Applications	13
3.2	Overview, M300 TOC	13
3.2.1	1/4DIN	13
3.2.2	1/2DIN	14
3.3	Control/Navigation Keys	14
3.3.1	Menu Structure	14
3.3.2	Navigation keys	15
3.3.2.1	Navigating the menu tree	15
3.3.2.2	Escape	15
3.3.2.3	Enter	15
3.3.2.4	Menu	15
3.3.2.5	Calibration mode	15
3.3.2.6	Info mode	15
3.3.3	Navigation of data entry fields	15
3.3.4	Entry of data values, selection of data entry options	16
3.3.5	Navigation with ↑ in Display	16
3.3.6	"Save changes" dialog	16
3.3.7	Security Passwords	16
3.4	Display	16
<b>4</b>	<b>M300 TOC Installation instruction</b>	<b>17</b>
4.1	Unpacking and inspection of the M300 TOC	17
4.1.1	Panel cutout dimensional information – 1/4DIN models	17
4.1.2	Installation procedure – 1/4DIN models	18
4.1.3	Panel cutout dimensional information – 1/2DIN models	19
4.1.4	Installation procedure – 1/2DIN models	20
4.1.5	Assembly – 1/2DIN version	20
4.1.6	1/2DIN version – Dimension drawings	21
4.1.7	1/2DIN version – Pipe mounting	21
4.1.8	1/4DIN version – Dimension drawings	22
4.2	Connection of power supply	23
4.2.1	1/4DIN housing (panel mount)	23
4.2.2	1/2DIN housing (wall mount)	24
4.3	Connector PIN definition	24
4.3.1	TB1 and TB2 for 1/2DIN and 1/4DIN versions	25
4.3.2	TB3 for 1/2DIN and 1/4DIN versions	25
4.4	Connection of TOC Sensor	25
<b>5</b>	<b>4000TOCe Installation Instructions</b>	<b>26</b>
5.1	Unpacking and inspection of the 4000TOCe	26
5.2	Installation of the 4000TOCe	26
5.3	Sample Tubing Connections	27
5.4	Sample Conditioning Coil	28
5.5	AC Power Connection	28
5.6	Sensor Connection	29
<b>6</b>	<b>Placing transmitter in, or out, of service</b>	<b>30</b>
6.1	Placing transmitter in service	30
6.2	Placing transmitter out of service	30
<b>7</b>	<b>4000TOCe Sensor Operation</b>	<b>31</b>
7.1	Initial Startup	31
7.2	Initiate Sample Flow	31
7.3	Start TOC Measurement	31
7.4	Normal Operation	31
7.5	System Suitability Testing	32
7.6	Calibration	32
7.6.1	TOC Calibration Methods	32

<b>8</b>	<b>Quick Setup</b>	<b>33</b>
<b>9</b>	<b>Sensor Calibration</b>	<b>34</b>
9.1	Enter Calibration Mode	34
<b>10</b>	<b>Configuration</b>	<b>35</b>
10.1	Enter Configuration Mode	35
10.2	Measurement	35
10.2.1	Channel Setup	35
10.2.2	Conductivity/Resistivity Temperature Compensation	36
10.2.3	Set Averaging	36
10.3	TOC Setup	36
10.3.1	TOC General Parameters	36
10.3.2	Lamp Control	37
10.3.3	Autobalance	37
10.4	Analog Outputs	38
10.5	Setpoints	39
10.6	Alarm	42
10.7	Display	43
10.7.1	Measurement	43
10.7.2	Resolution	43
10.7.3	Backlight	43
10.7.4	Name	44
10.8	Hold Analog Outputs	44
<b>11</b>	<b>System</b>	<b>45</b>
11.1	Set Language	45
11.2	Passwords	45
11.2.1	Changing Passwords	46
11.2.2	Configuring Menu Access for Operator	46
11.3	Set/Clear Lockout	46
11.4	Reset	46
11.4.1	Reset System	47
11.4.2	Reset Analog Calibration	47
11.4.3	Reset Sensor Calibration Data to Factory Settings	47
11.4.4	Reset Calibration Data of Sensor Electronics to Factory Settings	47
<b>12</b>	<b>4000TOCe Sensor Service Requirements</b>	<b>48</b>
12.1	UV Lamp Replacement	48
12.2	High Capacity Inlet Filter Replacement	49
12.3	Front Panel Cleaning	49
12.4	Technical Support	50
12.5	Draining and Shipping Instructions	50
<b>13</b>	<b>M300 TOC Service</b>	<b>51</b>
13.1	Enter Service Menu	51
13.2	Diagnostics	51
13.2.1	Model/Software Revision	51
13.2.2	Display	51
13.2.3	Keypad	52
13.2.4	Memory	52
13.2.5	Set Relay	52
13.2.6	Read Relays	52
13.2.7	Set Analog Outputs	53
13.2.8	Read Analog Outputs	53
13.3	Calibrate	53
13.3.1	Verify Conductivity Electronics	53
13.3.2	Calibrate Analog	53
13.3.3	Calibrate Unlock	54
13.4	Tech Service	54
<b>14</b>	<b>Info</b>	<b>55</b>
14.1	Info Menu	55
14.2	Messages	55
14.3	Calibration Data	55
14.4	Model/Software Revision	56
14.5	TOC Sensor Info	56
<b>15</b>	<b>Troubleshooting the M300 TOC Transmitter</b>	<b>57</b>
15.1	Changing the Fuse	57
15.2	Warning- and Alarm indication on the display	58
15.2.1	Warning indication	58
15.2.2	Alarm indication	58

---

<b>16</b>	<b>Troubleshooting the 4000TOCe Sensor</b>	<b>59</b>
16.1	Basic Troubleshooting	59
16.2	Fault and Error Messages	59
<b>17</b>	<b>Accessories and Spare Parts</b>	<b>61</b>
17.1	M300 TOC Transmitter	61
17.2	4000TOCe Sensor	61
17.2.1	4000TOCe Sensor Spare Parts	61
17.2.2	4000TOCe Sensor Consumable Items	61
<b>18</b>	<b>Specifications</b>	<b>62</b>
18.1	4000TOCe	62
18.2	M300 TOC	63
18.2.1	Electrical Specifications for 1/2DIN and 1/4DIN versions	63
18.2.2	Mechanical Specifications for 1/4DIN models	63
18.2.3	Mechanical Specifications for 1/2DIN version	63
18.2.4	Environmental Specifications for 1/2DIN and 1/4DIN versions	64
<b>19</b>	<b>Default Tables</b>	<b>65</b>
19.1	M300 TOC Default Settings	65
19.2	4000TOCe Default Settings	66
<b>20</b>	<b>Certificate</b>	<b>67</b>
<b>21</b>	<b>Warranty</b>	<b>68</b>





# 1 Introduction

Statement of intended use – The 4000TOCe sensor is a Total Organic Carbon sensor designed to measure the concentration of organic substances in pure and ultra pure water applications. The M300 TOC is a single channel transmitter with a large four line backlit Liquid Crystal Display which conveys measuring and setup information for the 4000TOCe sensor.

When used in combination, the 4000TOCe sensor and M300 TOC transmitter, form a TOC measurement system which provides the design flexibility for full integration into water systems. The separate components allow for close positioning of the sensor to the sample point for fastest response, while allowing integration of the transmitter into the control system.

This manual applies to the 4000TOCe sensor, and M300 TOC transmitter:

## 4000TOCe

Designation	Order no.
4000TOCe Sensor, 110VAC, 50/60 Hz	30 415 866
4000TOCe Sensor, 220VAC, 50/60 Hz	30 415 867

## M300 TOC

Designation	Order no.
M300 TOC 1/4DIN	30 414 214
M300 TOC 1/2DIN	30 414 212

Throughout this manual, the terms 'M300' and 'M300 TOC' are used. Within the context of this document, both terms should be taken to refer to the M300 TOC transmitter.

The print screen images in this manual have a general explaining character and can differ from the real display in your transmitter.

This description corresponds to the firmware release, version 1.0 of the M300 TOC transmitter. Changes are taking place constantly, without prior notification

## 2 Safety instructions

This manual includes safety information with the following designations and formats.

### 2.1 Definition of equipment and documentation symbols and designations



**WARNING:** POTENTIAL FOR PERSONAL INJURY.



**CAUTION:** possible instrument damage or malfunction.



**NOTE:** Important operating information.



**On the transmitter or in this manual text indicates:** Caution and/or other possible hazard including risk of electric shock (refer to accompanying documents).

The following is a list of general safety instructions and warnings. Failure to adhere to these instructions can result in damage to the equipment and/or personal injury to the operator.

- The M300 Transmitter should be installed and operated only by personnel familiar with the transmitter and who are qualified for such work.
- The M300 Transmitter must only be operated under the specified operating conditions (see section 18).
- Repair of the M300 Transmitter must be performed by authorized, trained personnel only.
- With the exception of routine maintenance, cleaning procedures or fuse replacement, as described in this manual, the M300 Transmitter must not be tampered with or altered in any manner.
- METTLER TOLEDO accepts no responsibility for damage caused by unauthorized modifications to the transmitter.
- Follow all warnings, cautions, and instructions indicated on and supplied with this product.
- Install equipment as specified in this instruction manual. Follow appropriate local and national codes.
- Protective covers must be in place at all times during normal operation.
- If this equipment is used in a manner not specified by the manufacturer, the protection provided by it against hazards may be impaired.

#### WARNINGS:

- Installation of cable connections and servicing of this product require access to shock hazard voltage levels.
- Main power and relay contacts wired to separate power source must be disconnected before servicing.
- Switch or circuit breaker shall be in close proximity to the equipment and within easy reach of the OPERATOR; it shall be marked as the disconnecting device for the equipment.
- Main power must employ a switch or circuit breaker as the disconnecting device for the equipment.
- Electrical installation must be in accordance with the National Electrical Code and/or any other applicable national or local codes.



- Safety and performance require that this instrument be connected and properly grounded through a three-wire power source.



**NOTE! RELAY CONTROL ACTION:** the M300 transmitter relays will always de-energize on loss of power, equivalent to normal state, regardless of relay state setting for powered operation. Configure any control system using these relays with fail-safe logic accordingly.



**NOTE! PROCESS UPSETS:** Because process and safety conditions may depend on consistent operation of this transmitter, provide appropriate means to maintain operation during sensor cleaning, replacement or sensor or instrument calibration.



**NOTE:** This is a 4-wire-product with an active 4–20 mA analog output.  
Please do not supply power to Pin1–Pin6 of TB2.

## 2.2 Correct disposal of the unit

When the transmitter is finally removed from service, observe all local environmental regulations for proper disposal.

## 3 Unit overview

M300 models are available in both a 1/4DIN and 1/2DIN case size. The 1/4DIN is a panel-mount only design and the 1/2DIN models provide an integral IP65 housing for wall-, or pipe-mount.

### 3.1 Overview, 4000TOCe Sensor

#### 3.1.1 Sensor Details

The 4000TOCe Sensor is a Total Organic Carbon sensor designed for use with the M300 TOC transmitter. The M300 TOC will automatically identify the 4000TOCe Sensor when it is connected, and all factory calibration data is automatically read and used for operation and indication.

The 4000TOCe Sensor and M300 TOC transmitter are configured with factory default settings to minimize measurement setup time. These default settings allow for sensor operation with minimal keystrokes. The 4000TOCe Sensor has more features than other sensors and may require additional configuration dependant upon the operational setup. Once these parameters are set, the TOC sensor will function automatically, and will require user interface only for periodic service and maintenance. Measurements available from the 4000TOCe Sensor include TOC, Conductivity/Resistivity (compensated and uncompensated) and Temperature.

The 4000TOCe Sensor is designed with four local LED indicators and a UV Lamp control key on the front panel, as shown in the illustration below. The LEDs are designed to provide local indication of sensor status. The operation of the LEDs is synchronized with the M300 TOC display status messages that appear in the INFO/Messages menu.

Function	Color	Operation
Fault	Red	Flashes during Fault condition, sensor operation stopped
Error	Amber	Illuminates during Error condition, sensor remains operational
Sensor Status	Green	Illuminates whenever AC Power is on and the M300 TOC is connected to the sensor
UV Lamp On	Green	Illuminates whenever the UV Lamp is on

The UV Lamp control key is designed to provide a local On/Off control for the UV lamp to allow for quick lamp change-out and assist the operator during troubleshooting, if necessary.



**NOTE:** If the UV Lamp Key is pressed to turn the UV Lamp off, the UV Lamp cannot be turned on from the M300 TOC, it can only be turned on by pressing the sensor key again.

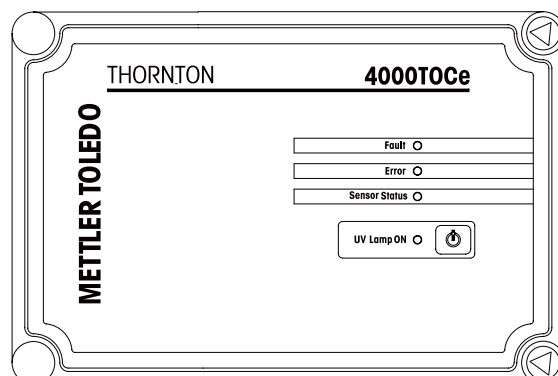

The front cover of the sensor is hinged on the left side. Located at the top and bottom right corners of the sensor enclosure are two triangle-shaped door fasteners. The installation kit provided with the 4000TOCe sensor includes the special tool needed to loosen these fasteners and open the front door to the enclosure. Periodic access will be required to perform routine service and maintenance. Additional front cover tools are available from METTLER TOLEDO Thornton, Inc. See Section 17 for part numbers and descriptions.

### 3.1.2 High Pressure Applications

For installations with process pressure above 85 psig (5.9 barg), the High Pressure Regulator (p/n 58 091 552) is required (see section 5.3). Installation instructions are supplied with the High Pressure Regulator.

### 3.1.3 Potential Condensation Applications

Certain ambient and process temperatures may cause condensation to occur inside the 4000TOCe Sensor. The METTLER TOLEDO Thornton Sample Conditioning Coil provided with the sensor installation kit is designed to reduce condensation conditions by allowing the sample temperature to partially equalize with the ambient temperature.

### 3.1.4 High Temperature Applications

For water temperatures above 70°C (158°F), the included Sample Conditioning Coil (p/n 58 091 518) is required. In high pressure applications, the High Pressure Regulator (p/n 58 091 552) must be installed upstream of the Sample Conditioning Coil.

## 3.2 Overview, M300 TOC

### 3.2.1 1/4DIN

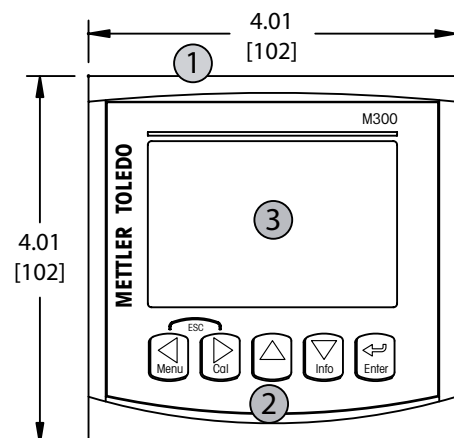
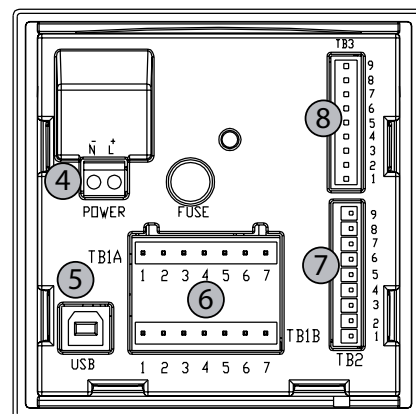

- 1: Hard Polycarbonate case
- 2: Five Tactile-Feedback Navigation Keys
- 3: Four-line LCD Display
- 4: Power Supply Terminals

- 5: USB Interface Port
- 6: Relay Output Terminals
- 7: Analog Output Terminals
- 8: Sensor Input Terminals

### 3.2.2 1/2DIN

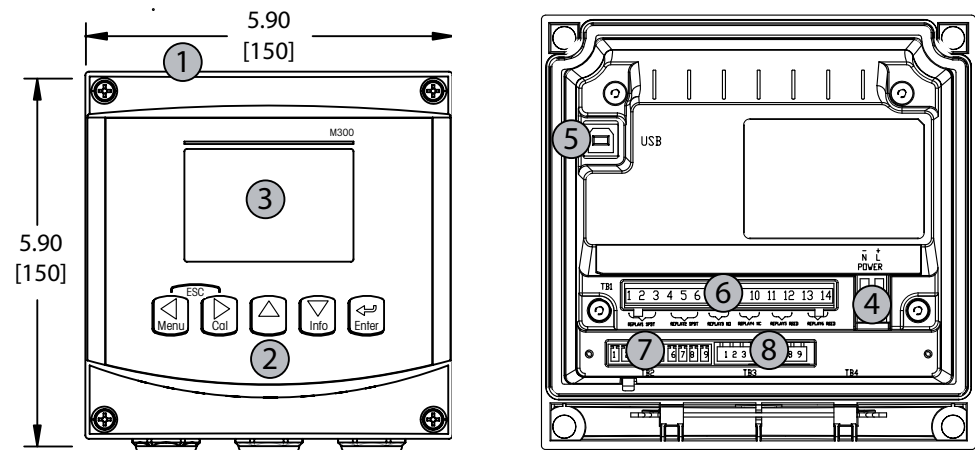

- 1: Hard Polycarbonate case
- 2: Five Tactile-Feedback Navigation Keys
- 3: Four-line LCD Display
- 4: Power Supply Terminals

- 5: USB Interface Port
- 6: Relay Output Terminals
- 7: Analog Output Terminals
- 8: Sensor Input Terminals

## 3.3 Control/Navigation Keys

### 3.3.1 Menu Structure

Below is the structure of the M300 menu tree:

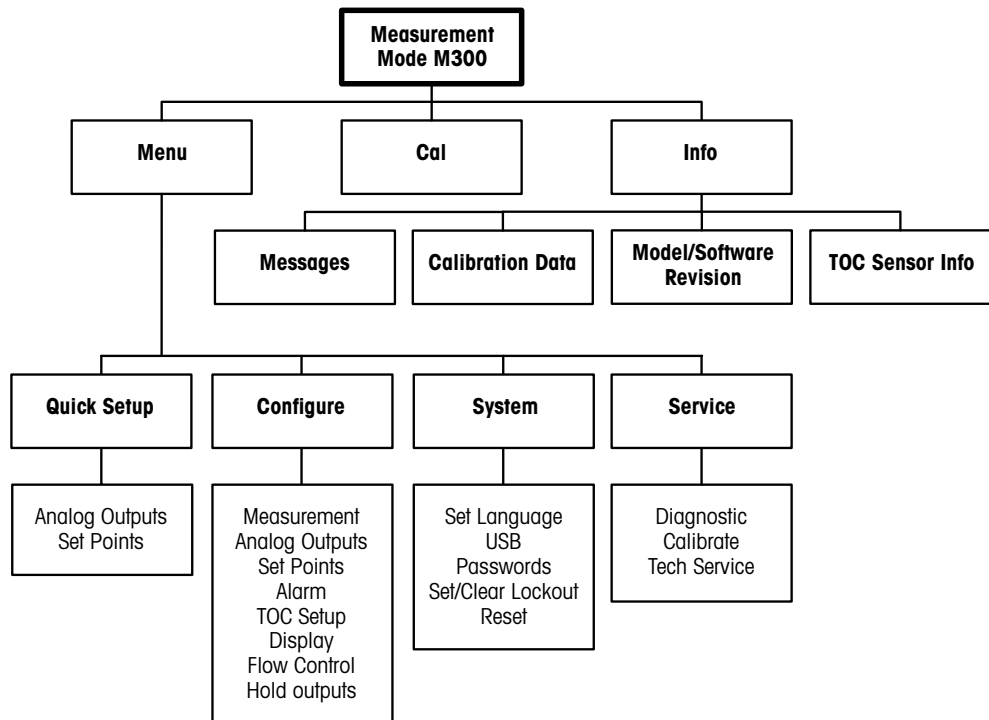

## 3.3.2 Navigation keys

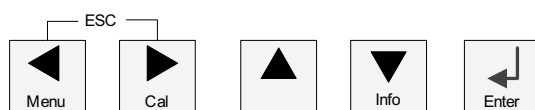

### 3.3.2.1 Navigating the menu tree

Enter the desired main Menu branch with the ◀ ▶ or ▼ keys. Use the ▲ and ▼ keys to navigate through the selected Menu branch.



**NOTE:** In order to back up one menu page, without escaping to the measurement mode, move the cursor under the UP Arrow character (↑) at the bottom right of the display screen and press [Enter].

### 3.3.2.2 Escape

Press the ◀ and ▶ key simultaneously (escape) to return to the Measurement mode.

### 3.3.2.3 Enter

Use the ↵ key to confirm action or selections.

### 3.3.2.4 Menu

Press the ◀ key to access the main Menu.

### 3.3.2.5 Calibration mode

Press the ▶ key to enter Calibration Mode.

### 3.3.2.6 Info mode

Press the ▼ key to enter Info Mode

## 3.3.3 Navigation of data entry fields

Use the ▶ key to navigate forward or the ◀ key to navigate backwards within the changeable data entry fields of the display.

### 3.3.4 Entry of data values, selection of data entry options

Use the ▲ key to increase or the ▼ key to decrease a digit. Use the same keys to navigate within a selection of values or options of a data entry field.



**NOTE:** Some screens require configuring multiple values via the same data field (ex: configuring multiple setpoints). Be sure to use the ► or ◀ key to return to the primary field and the ▲ or ▼ key to toggle between all configuration options before entering to the next display screen.

### 3.3.5 Navigation with ↑ in Display

If a ↑ is displayed on the bottom right hand corner of the display, you can use the ► or the ◀ key to navigate to it. If you click [ENTER] you will navigate backwards through the menu (go back one screen). This can be a very useful option to move back up the menu tree without having to exit into the measuring mode and re-enter the menu.

### 3.3.6 "Save changes" dialog

Three options are possible for the "Save changes" dialog: Yes & Exit (Save changes and exit to measuring mode), "Yes & ↑" (Save changes and go back one screen) and "No & Exit" (Don't save changes and exit to measuring mode). The "Yes & ↑" option is very useful if you want to continue configuring without having to re-enter the menu.

### 3.3.7 Security Passwords

The M300 transmitter allows a security lock-out of various menus. If the security lock-out feature of the transmitter has been enabled, a security password must be entered to allow access to the menu. See section 11.3 for more information.

## 3.4 Display



**NOTE:** In the event of an alarm or other error condition the M300 Transmitter will display a flashing ⚠ in the upper right corner of the display. This symbol will remain until the condition that caused it has been cleared.



**NOTE:** During calibrations with Analog Output/Relay/USB in Hold state, a flashing H will appear in the upper left corner of the display. This symbol will remain for 20 seconds until after the calibration is completed.



## 4 M300 TOC Installation instruction

### 4.1 Unpacking and inspection of the M300 TOC

Inspect the shipping container. If it is damaged, contact the shipper immediately for instructions. Do not discard the box.

If there is no apparent damage, unpack the container. Be sure all items shown on the packing list are present.

If items are missing, notify METTLER TOLEDO immediately.

#### 4.1.1 Panel cutout dimensional information – 1/4DIN models

1/4DIN Model transmitters are designed for panel-mount installation only. Each transmitter is supplied with mounting hardware to provide fast and simple installation to a flat panel or flat enclosure door. To insure a good seal and maintain IP integrity of installation, the panel or door must be flat and have a smooth finish. Hardware consists of:

2 snap-on Mounting brackets

1 mounting gasket seal

Transmitter dimensions and mounting are shown in the figures below.

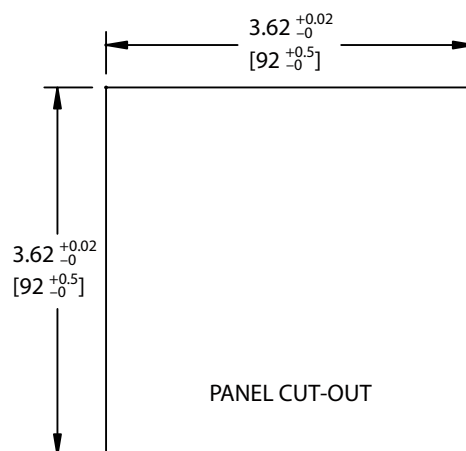

## 4.1.2 Installation procedure – 1/4DIN models

- Make cutout in panel (see dimensions cutout drawing).
- Be sure surface surrounding cutout is clean, smooth and free of burrs.
- Slide face gasket (supplied with transmitter) around transmitter from the back of the unit.
- Place transmitter into cutout hole. Be sure there are no gaps between the transmitter and panel surface.
- Place the two mounting brackets on either side of the transmitter as shown.
- While holding transmitter firmly into the cutout hole, push the mounting brackets toward the backside of panel.
- Once secure, use a screwdriver to tighten the brackets against the panel. In order to provide IP65 environmental enclosure rating, the two clamps provided shall be securely tightened to create an adequate seal between the panel enclosure and M300 front face.
- Face gasket will compress between transmitter and panel.



**CAUTION:** Do not over tighten brackets.

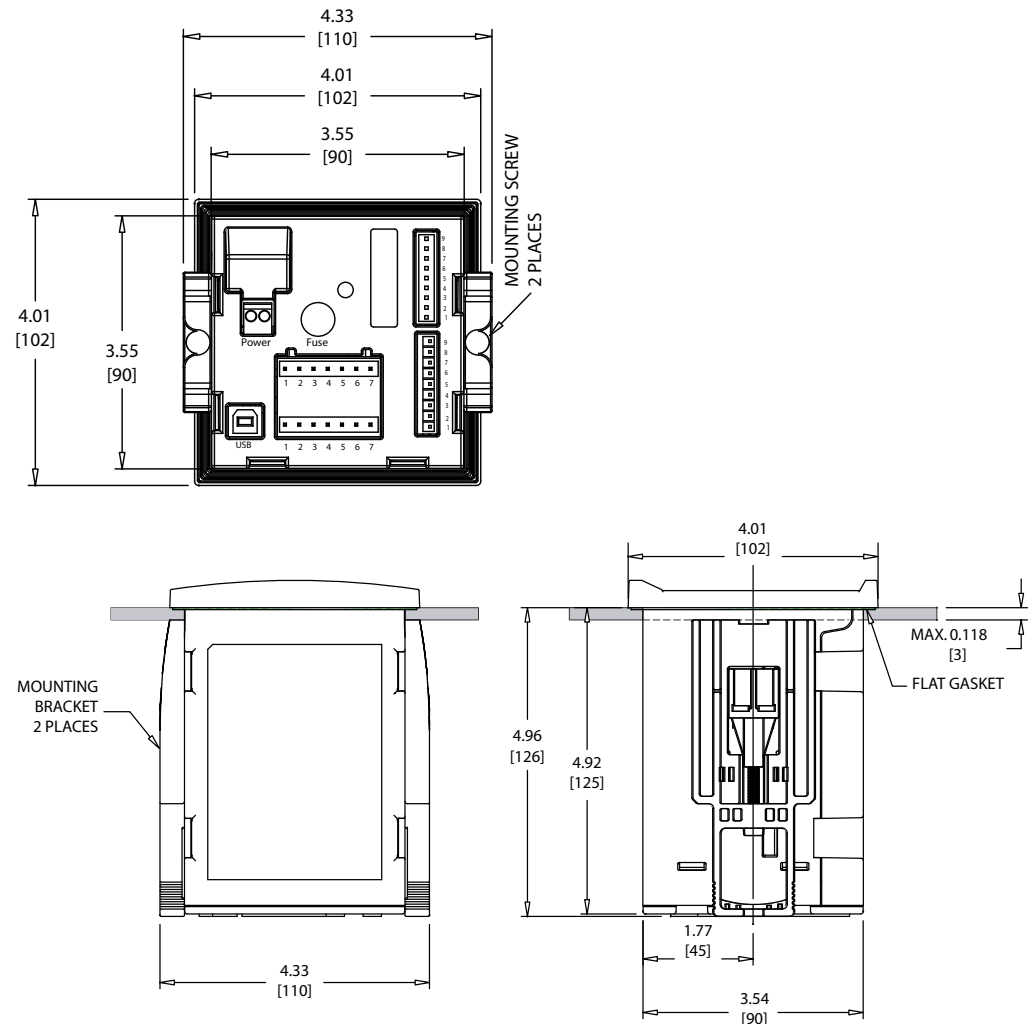

### 4.1.3 Panel cutout dimensional information – 1/2DIN models

Below are cut-out dimensions required by the 1/2DIN models when mounted within a flat panel or on a flat enclosure door. This surface must be flat and smooth. Textured or rough surfaces are not recommended and may limit the effectiveness of the gasket seal provided.

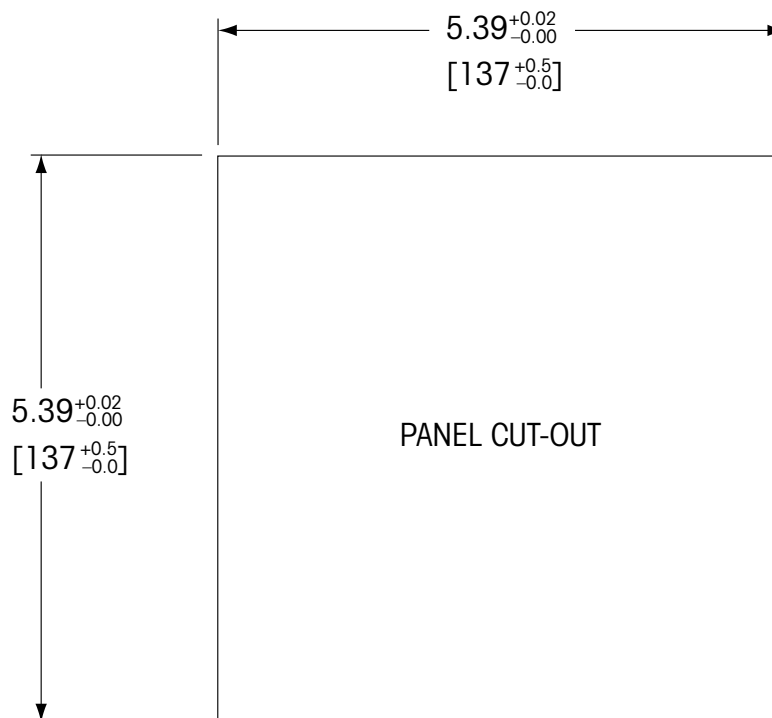

**NOTE:** An optional accessory is required to panel mount the 1/2 DIN models. Refer to Section 17 "Accessories and Spare Parts" for ordering information.

### 4.1.4 Installation procedure – 1/2DIN models

#### General:

- Orient the transmitter so that the cable grips face downward.
- Wiring routed through the cable grips shall be suitable for use in wet locations.
- In order to provide IP65 enclosure ratings, all cable glands must be in place. Each cable gland must be filled using a cable, or suitable Cable Gland Hole Seal.

#### For Wall Mount:

- Remove rear cover from front housing.
- Start by unscrewing the four screws located on the face of the transmitter, in each corner. This allows the front cover to swing away from the rear housing.
- Remove the hinge-pin by squeezing the pin from each end. This allows the front housing to be removed from the rear housing.
- Mount rear housing to wall. Secure mounting kit to the M300 according to the supplied instructions. Attach to wall using appropriate mounting hardware for wall surface. Be sure it is level and securely fastened and the installation adheres to any and all clearance dimensions required for transmitter service and maintenance. Orient the transmitter so that the cable grips are facing downward.
- Reattach the front housing to the rear housing. Securely tighten the rear-cover screws to ensure that IP65 enclosure environmental rating is provided. The unit is ready to be wired.

#### For Pipe Mount:

- Use only manufacturer-supplied components for pipe-mounting the M300 transmitter and install per the supplied instructions. See section 17 for ordering information.

### 4.1.5 Assembly – 1/2DIN version

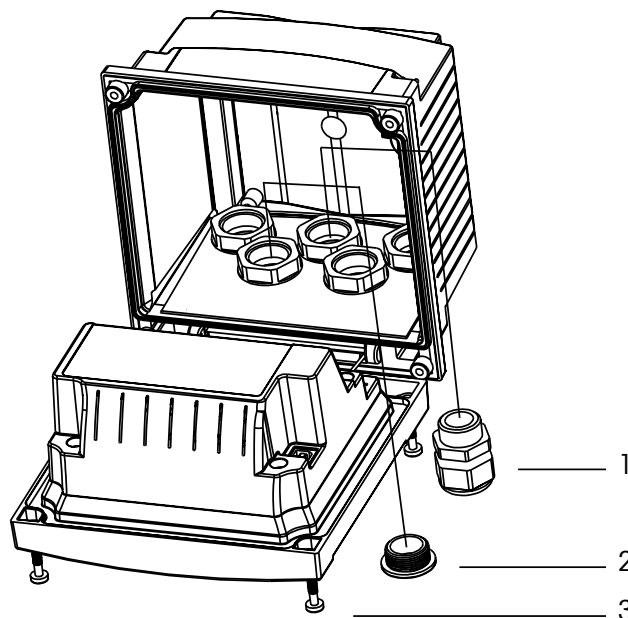

- 1: 3 Pg 13.5 cable glands  
2: 2 plastic plugs  
3: 4 screws

### 4.1.6 1/2DIN version – Dimension drawings

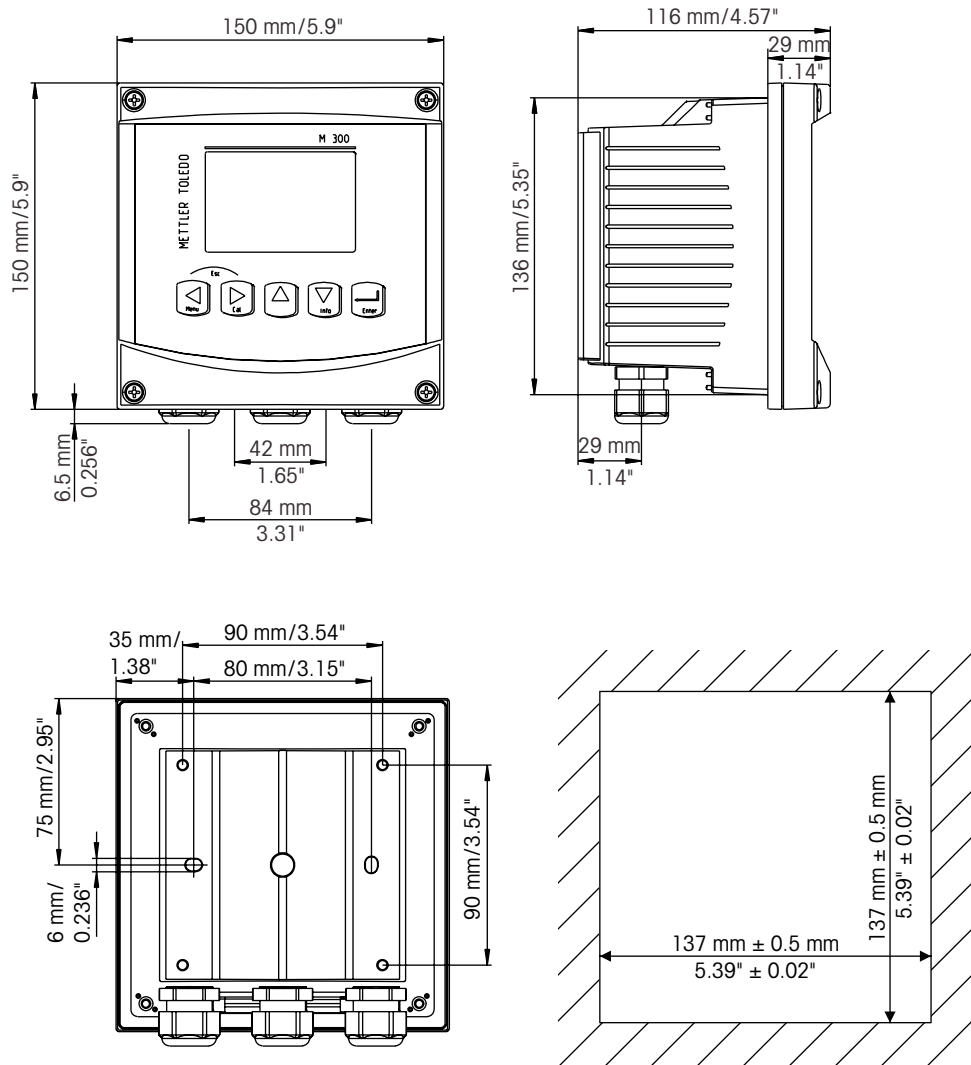

### 4.1.7 1/2DIN version – Pipe mounting

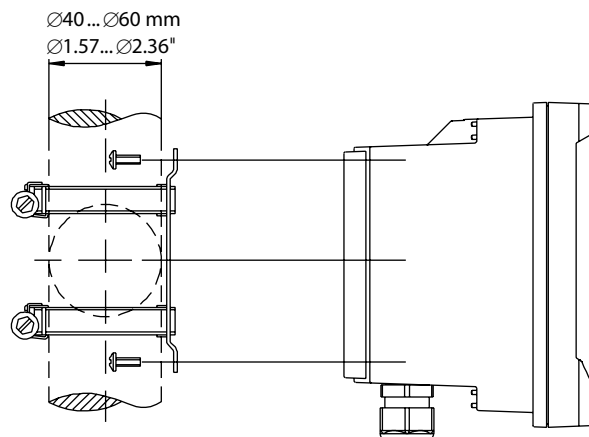

### 4.1.8 1/4DIN version – Dimension drawings

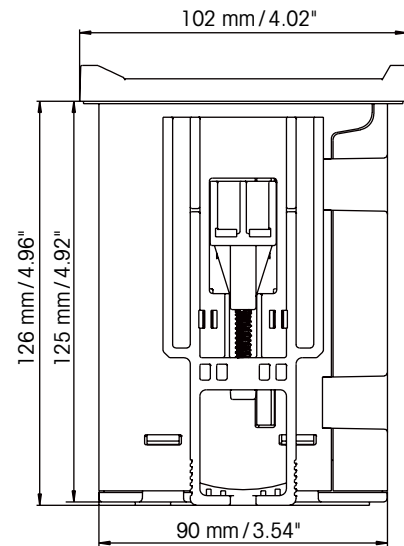
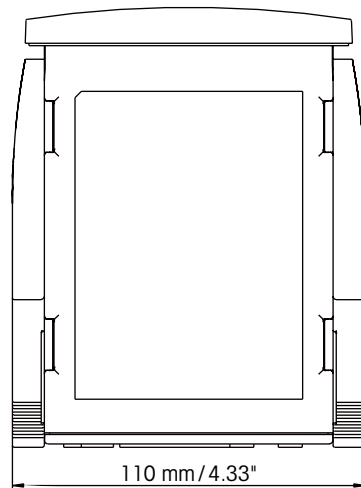
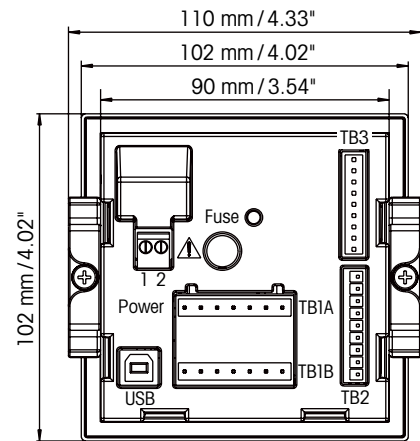
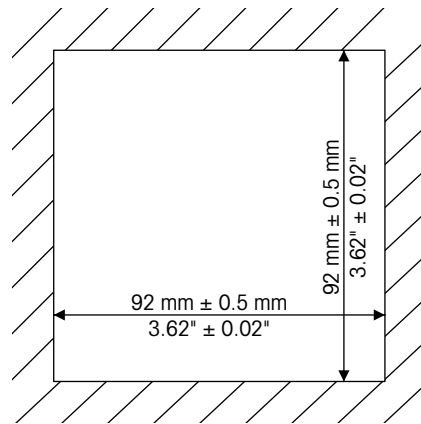

## 4.2 Connection of power supply

All connections to the transmitter are made on the rear panel of all models.



Be sure power to all wires is turned off before proceeding with the installation. High voltage may be present on the input power wires and relay wires.

A two-terminal connector on the rear panel of all M300 models is provided for power connection. All M300 models are designed to operate from a 20–30 VDC or a 100 to 240 VAC power source. Refer to specifications for power requirements and ratings and size power wiring accordingly.

The terminal block for power connections is labeled “Power” on the rear panel of the transmitter. One terminal is labeled **-N** for the Neutral wire and the other **+L** for the Line (or Load) wire. The terminals are suitable for single wires and flexible leads up to 2.5 mm<sup>2</sup> (AWG 14). There is no earth ground terminal on the transmitter. For this reason the internal power wiring within the transmitter is double insulated and the product label designates this using the  symbol.

### 4.2.1 1/4DIN housing (panel mount)

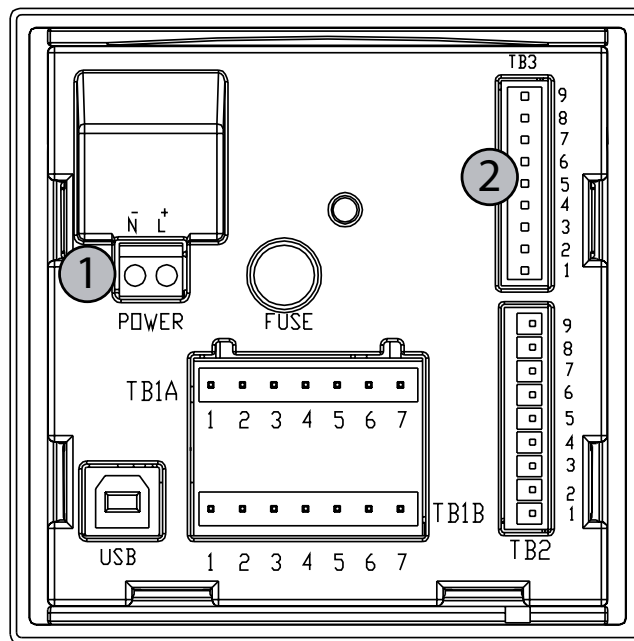

- 1: Connection of power supply
- 2: Terminal for 4000TOCe sensor

### 4.2.2 1/2DIN housing (wall mount)

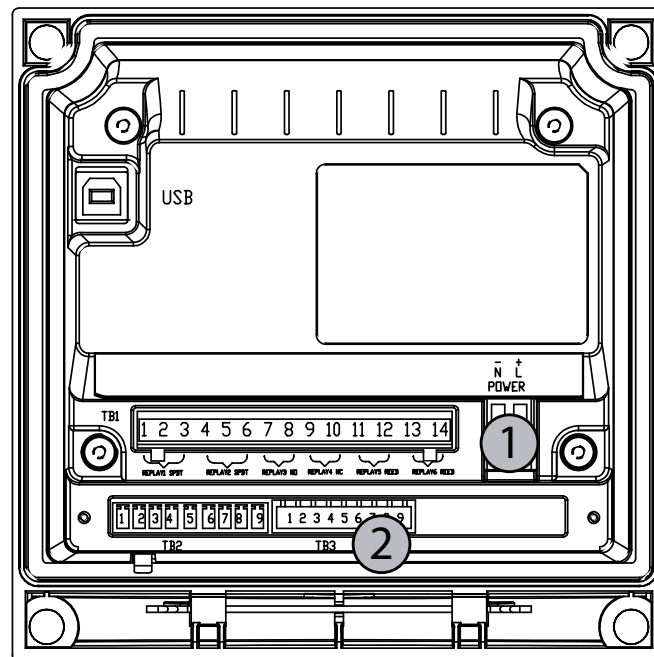

- 1: Connection of power supply
- 2: Terminal for 4000TOCe sensor

### 4.3 Connector PIN definition

To connect the 4000TOCe sensor to the M300 TOC transmitter, connect the sensor patch cord to the orange terminal block provided with the M300 TOC transmitter. Carefully insert the wire lead with the correct color shielding to the appropriate terminal connection on the terminal block, using the table provided in section 4.3.2 for guidance.



### 4.3.1 TB1 and TB2 for 1/2DIN and 1/4DIN versions

Power connections are labeled **-N** for Neutral and **+L** for Line, for 100 to 240 VAC or 20–30 VDC.

**¼ DIN**

TB2 for ¼ DIN	
1	AO1+
2	AO1-/AO2-
3	AO2+
4	-
5	-
6	-
7	-
8	-
9	-

TB1A for ¼ DIN	
1	NO2
2	COM2
3	NC2
4	-
5	-
4	NO4
5	COM4

TB1B for ¼ DIN	
1	NO1
2	COM1
3	NC1
4	-
5	-
4	NO3
5	COM3

**½ DIN**

TB2 for ½ DIN	
1	AO1+
2	AO1-/AO2-
3	AO2+
4	-
5	-
6	-
7	-
8	-
9	-

TB1 for ½ DIN			
1	NO1	8	-
2	COM1	9	-
3	NC1	10	-
4	NO2	11	NO3
5	COM2	12	COM3
6	NC2	13	NO4
7	-	14	COM4

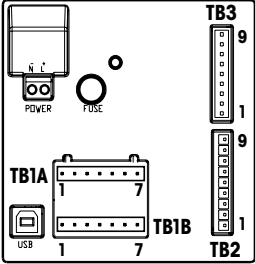

NO: normally open (contact open if un-actuated)  
 NC: normally closed (contact closed if un-actuated)

AO: Analog Output

### 4.3.2 TB3 for 1/2DIN and 1/4DIN versions

TB3 provides access to channel A signal inputs

TOC sensors use 58 080 27X series cables. A full listing of cables can be found in section 17.1.

Pin no.	Sensor wire Color	Function
1	–	not used
2	–	not used
3	–	not used
4	–	not used
5	–	not used
6	White	GND
7	Black	RS485-B
8	Red	RS485-A
9	Blue	+5V

## 4.4 Connection of TOC Sensor

To connect the 4000TOCe sensor to the M300 TOC transmitter, connect the sensor patch cord to the orange terminal block provided with the M300 TOC transmitter. Carefully insert the wire lead with the correct color shielding to the appropriate terminal connection on the terminal block, using the table provided in section 4.3.2 for guidance.

## 5 400TOCe Installation Instructions

### 5.1 Unpacking and inspection of the 400TOCe

Carefully unpack the 400TOCe sensor. The box should contain the following items:

- 400TOCe Sensor
- 400TOCe Sensor Instruction Manual CD
- 400TOCe Start-up Booklet
- Certificate of Calibration
- Installation Kit includes:
  - One - 6 foot (2 m) length of PTFE tubing, 0.125 inch (3 mm) O.D.
  - One - 5 foot (1.5 m) length of tubing, 0.31 inch (8 mm) O.D.
  - One stainless steel drain tube
  - One - Plastic 30cc Syringe
  - One - Tool, TOC Cover
  - One - High Capacity Inlet Filter Assembly
  - One - Adapter, 0.25 inch (6 mm) O.D. to 0.125 inch (3 mm) O.D. Tubing Reducer
  - One – Sample Conditioning Coil

### 5.2 Installation of the 400TOCe

Shown below are the case dimensions for the 400TOCe Sensor.

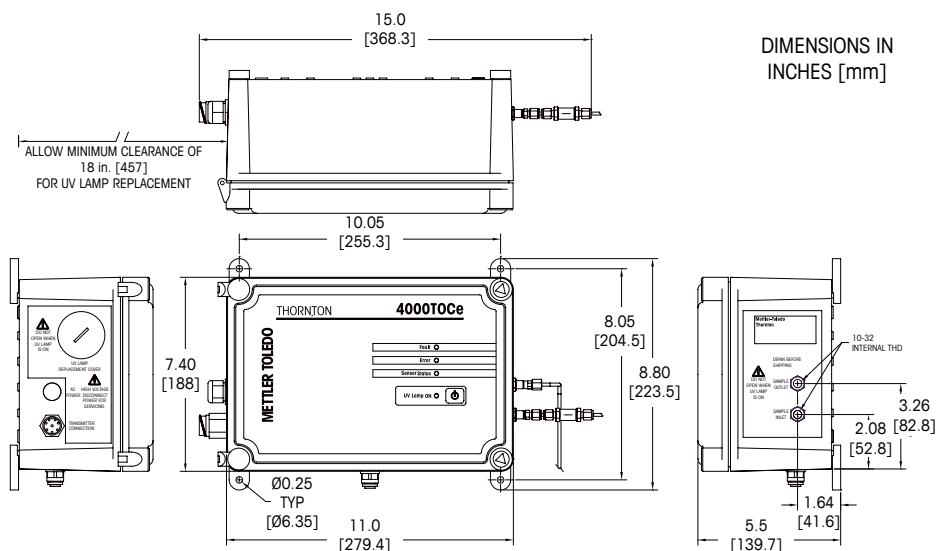

Mount the 400TOCe Sensor as close to the sample point of your system as possible. Shorter sample tubing length between the sampling point and the 400TOCe Sensor will provide faster response time. As shown above, the 400TOCe Sensor is supplied with wall-mounting tabs for wall or panel mount.

The 400TOCe Sensor can also be placed on a bench-top or table. In this type of installation, the mounting tabs must be removed from the bottom of the sensor enclosure in order for the sensor to stand on its own. The bottom safety drain fitting should also be removed for bench top installation, leaving the small opening in the bottom of the enclosure open.

Some of the internal components for the sensor are made of fragile materials; therefore precautions should be taken to avoid damage due to improper handling. The 400TOCe Sensor requires routine maintenance; therefore it is beneficial to mount the sensor in an easily accessible location.

### 5.3 Sample Tubing Connections

The installation kit provided with the sensor includes sample tubing consisting of one 5-foot (1.5 m) length of 0.31 inch (8 mm) O.D. tubing, one stainless steel drain tube, and one 6-foot (2 m) length of PTFE tubing for the supply. A 0.25 inch (6 mm) O.D. to 0.125 inch (3 mm) O.D. tubing reducer is also included and can be used where applicable.

The following items are necessary to ensure the proper installation of the sensor:

- Sample isolation valve (not provided with sensor).
- 0.125 inch compression tube fitting for sample point (common tube fitting adapters are available from Thornton; see Section 17.2.1 for details)



**NOTE:** The sample point should contain a shut-off valve to isolate the sensor when necessary. Proper installation guidelines should be followed when installing this valve to reduce the possibility of air entrapment or sediment in the sample line.

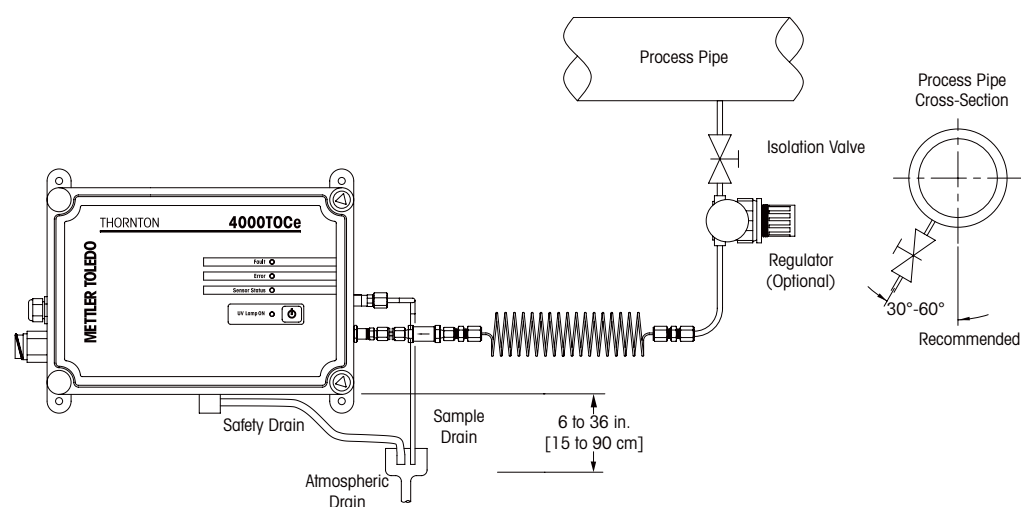

- Remove the protective covers from the sample connections on the sensor.
- Attached the open tube end of the PTFE tubing to the sample isolation valve. Cut excess tubing to minimize sample tubing length. Be sure all fittings are properly fastened to avoid leaks and the possibility of air ingress.

Flush the sample inlet tubing to remove any particles that may be in the line or fittings before connecting it to the 4000TOCe Sensor, or prior to initial sensor startup.

- Connect the stainless steel drain tube to the Sample Outlet connection. The fitting is attached to the tube; therefore thread the fitting into the Sample Outlet connection on the sensor. Do not over tighten.
- Locate the High Capacity Inlet Filter Assembly provided in the sensor installation kit. The male-threaded end of the assembly is screwed into the female-threaded sample inlet fitting. Secure the assembly with a wrench to ensure the connection is tight. Do not over tighten.
- Connect the 0.125 inch (3 mm) PTFE tubing to the high capacity inlet filter by securing the tubing in the compression fitting on the assembly. Do not over tighten.
- Run the safety drain tubing to an atmospheric drain located close to the sensor. See the illustration in section 5.3, for dimensional detail of the drain location. Take note of the 6" (15 cm) to 36" (90 cm) drain requirement.



**Important!** The stainless steel drain tube must be fed to a nearby standpipe or drain sump to create an air gap and prevent siphoning. Installation must adhere to the dimensions shown in section 5.3 for proper sensor operation.

- Once all tubing connections are complete and the sample inlet tubing has been flushed to drain, sample water can be introduced to the sensor. Once there is flow, check to be sure there are no leaks inside the enclosure. Allow the sensor to initially flush with sample water (4-24 hrs is recommended). Shut off the sample flow to the sensor and connect AC power to the 4000TOCe Sensor.

## 5.4 Sample Conditioning Coil

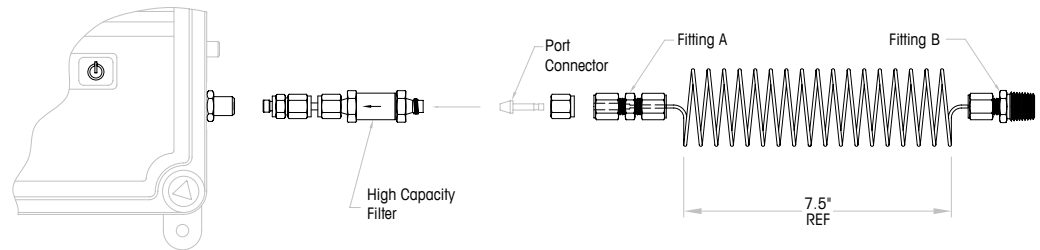

- Remove compression fitting from filter assembly. As shown, insert port connector into compression fitting that was removed from filter. Reconnect compression fitting to the filter assembly and tighten to crimp. Do not over tighten.
- Connect Fitting A (1/8"-1/8") of Sample Conditioning Coil to the port connector and tighten to crimp. Do not over tighten.
- Attach Fitting B (1/8" X 1/4" NPT) of Sample Conditioning Coil to an appropriate connection on the process pipe.
- Ensure that excessive force is not applied to the inlet fittings. If necessary, support the Sample Conditioning Coil in an appropriate manner.



**NOTE:** The Sample Conditioning Coil can be extended in length to 10' (3 m) maximum.

## 5.5 AC Power Connection

As shown in the left side view provided in the installation diagram, there is a bulkhead cable gland located on the left-hand side of the sensor enclosure labeled 'AC POWER' to allow for the passage of the AC power cable (not provided with sensor). The TOC sensor is equipped with an AC power terminal used for the AC line and neutral connections, and a grounding plate used for the AC earth/ground connection.

Main power must employ a switch or circuit breaker as the disconnecting device for the equipment. The breaker should be properly labeled and easily accessible for system isolation by service personnel. The circuit breaker shall have a maximum of 20 amp rating.

The 'Line' and 'Neutral' input terminal connections for AC power are located on the printed circuit board mounted to the front cover of the sensor, as shown in the illustration provided below. The Earth/Ground connection is on the grounding plate mounted at the top of the inside front-cover. A factory-installed ground wire connects the ground/earth connection at the AC power terminal to the grounding plate. To ensure safe operation, this wire must not be removed or altered in any way.

For safe operation, the AC power cable used should meet the following minimum specifications:

VW-1/FT-1; min 300 V; 105°C, Minimum 18 AWG (0.821 mm). Cord diameter shall be Min/Max 0.16"(4.06 mm) to 0.31" (7.87 mm). The free length of the jacketed cable for the AC line cord within the TOC sensor enclosure shall be at least 6 inches (150 mm). The free length of the line and neutral leads should be at least 1 inch (25 mm) in length with a recommended strip-length of ¼" (7 mm). The free length of the earth/ground lead shall be at least 3.5 inches (90 mm), and must be connected to #10 stud located on the grounding plate.

Keep AC power separated from all other internal wiring. Use the fasteners provided as part of the AC terminal and grounding plate to secure the power leads. Ensure there is adequate cable length to avoid putting mechanical stress on the wiring when the front door is fully opened. The diagram below shows the terminal connections for AC power. Be sure the line fuse is properly installed when making electrical connections. A spare fuse kit is available from Thornton. See the spares parts list at the end of this manual for more details.

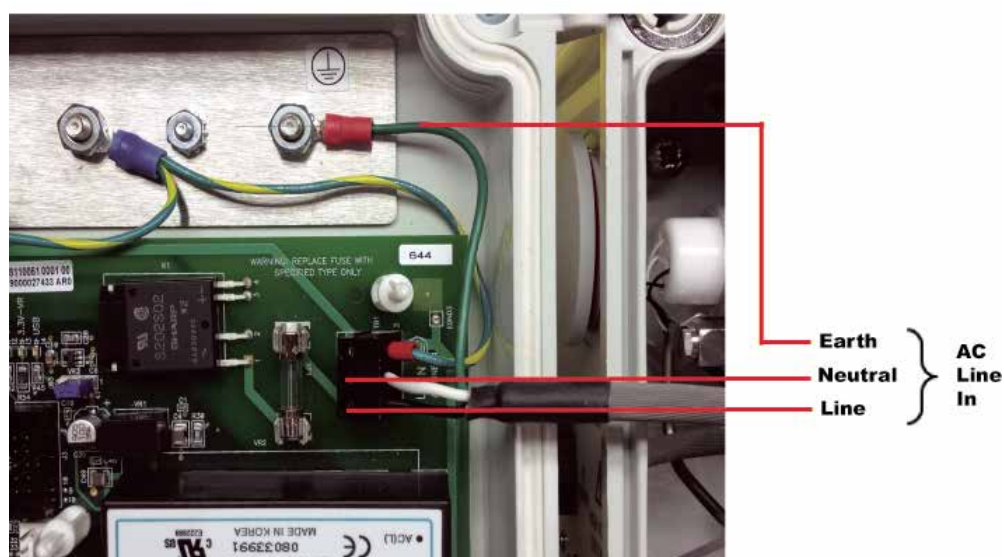

## 5.6 Sensor Connection

Also located on the left-hand side of the sensor enclosure (refer to the illustration in section 5.2) is the connection for the M300 TOC, labeled 'Transmitter Connection'. The standard M300 TOC patch cable attaches directly to this connector. To secure the patch cable, align the pins of the two connectors and thread the cable mating connector until finger tight.

Once both electrical connections are secured, the sample shut-off valve can be opened and the sensor flushed with sample water.

This manual defines the TOC functions available when using the 4000TOCe Sensor in conjunction with the M300 TOC transmitter. Read this section carefully prior to operating the 4000TOCe Sensor.

## **6 Placing transmitter in, or out, of service**

### **6.1 Placing transmitter in service**



After connecting the transmitter to a power supply circuit, it will be active as soon as the circuit is powered.

### **6.2 Placing transmitter out of service**

First disconnect the unit from the main power source, then disconnect all remaining electrical connections. Remove the unit from the wall/panel. Use the installation instruction in this manual as reference for dis-assembling mounting hardware.

## **7 4000TOCe Sensor Operation**

### **7.1 Initial Startup**

Initial start-up refers to the condition where a 4000TOCe Sensor is installed and setup for the first time. Factory default settings for a 4000TOCe Sensor are designed to minimize setup time for this sensor and allow the sensor to measure automatically.

### **7.2 Initiate Sample Flow**

The 4000TOCe Sensor is designed to operate optimally at a flow rate of 20 mL/min. The flow rate through the sensor is controlled by a solenoid-operated automatic flow control valve which is designed to compensate for supply pressure variations.

To establish sample flow, ensure that the 4000TOCe is connected to an M300 TOC Transmitter, and that AC power is supplied to the 4000TOCe and M300 TOC. Slowly open the sample line isolation valve. Once sample flow is established, the 4000TOCe sensor will automatically establish a 20 ml/min flow rate. Allow 3-5 minutes for the sensor to fill, and observe flow at the drain tube. Once there is flow, check that there are no leaks inside the sensor enclosure. The sensor is now ready for normal operation.

### **7.3 Start TOC Measurement**

The factory default for Auto Start is No. It is for this reason that the UV Lamp did not automatically turn on. Navigate to Menu/TOC Setup/TOC General Para. Change the factory default from 'No' to 'Yes'.

At this time, the Key on the sensor must be pressed before the UV Lamp will turn on and a TOC measurement will begin. This process is designed for safety, to insure that an operator is not working inside the sensor when someone at the M300 TOC instrument is trying to turn on the UV Lamp.

During the setup of the TOC sensor, if the Auto Start function in the TOC setup menus is changed from 'No' to 'Yes', the M300 TOC will still prompt the operator to press the key at the sensor during this initial start-up. However after this startup, the Auto Start function takes priority and the sensor will automatically start.

### **7.4 Normal Operation**

Under normal operating conditions, the 4000TOCe Sensor is continuously relaying information to and from the M300 TOC. The M300 TOC display also acts as a status indicator for the sensor. If the display screen is set to display a measurement from the 4000TOCe Sensor, under normal operating conditions the display will show the measurement letter, name (for measurements C and D only) and value.

If an ERROR or FAULT condition occurs a flashing triangle will appear on the measurement screen, the user can go to the Messages screen to retrieve more information regarding the cause of the condition. Refer to Section 14 of this manual for more information. If the Auto-balance function is set to "yes", the 4000TOCe sensor will perform an auto-balance based on the interval set within the M300 TOC TOC sensor setup menus.

## 7.5 System Suitability Testing

In most pharmaceutical water applications, System Suitability Testing is required by the United States Pharmacopoeia USP <643> and European Pharmacopoeia EP 2.2.44 to qualify instruments used for total organic carbon (TOC) measurements. The System Suitability Test and TOC Calibration Kit for the 4000TOCe Sensor is available to meet the requirements of this procedure. The 4000TOCe System Suitability Standard Operating Procedure (p/n 30 424 620) describes the System Suitability Testing procedure in detail. System Suitability Standards (p/n 58 091 526) are also available. Contact METTLER TOLEDO Thornton Customer Service for ordering information. Note: System Suitability Testing should be performed relative to individual user policy, and is recommended after each UV lamp change and TOC calibration.

## 7.6 Calibration

A Combination System Suitability Test, TOC and Conductivity Calibration Test Kit is available for the 4000TOCe Sensor. If TOC calibration only is needed, the Calibration Kit is sufficient to perform this function. The 4000TOCe Sensor TOC Calibration SOP (p/n 30 414 621) describes these calibrations in detail. Calibration standards (p/n 58 091 529) are also available. Contact METTLER TOLEDO Thornton Customer Service for ordering information. Note: It is recommended that a TOC calibration be performed after every UV lamp change, and not to exceed 1 year. A full calibration is recommended annually.

### 7.6.1 TOC Calibration Methods

There are four main TOC calibration “types” available:

- Standard
- 1-point slope (or span)
- 1-point zero pt

**Standard:** For most applications that operate over a wide dynamic range, the recommended TOC calibration type is Standard, referred to as “Standard” in the M300 TOC. A Standard calibration requires two TOC calibration solutions, typically at 250 ppb and 500 ppb. Two calibration multipliers and adders are determined in the range of 0-250 ppb TOC and 250-500 ppb TOC. The two lines intersect at 250 ppb. This calibration features provides an improved system accuracy. This calibration type is the default calibration method with which the 4000TOCe is supplied, and is recommended when low and high TOC may be encountered from either the water purification process or the calibration/SST solutions.

**1-point slope:** A 1-point slope calibration method will adjust the TOC calibration multiplier. If a standard calibration is being used with your 4000TOCe and the “1 point slope” is performed, it will over-write the “Standard” calibration.

**1-point zero pt:** This method will adjust the the TOC calibration adder. If a Standard calibration exists and the “1 point zero pt” is performed, it will modify the adder on the 0-250 ppb range. The TOC calibration standard concentration used for the “1-point zero pt” must be lower than the midpoint of the “Standard” calibration or 50 ppb, whichever is lower. This method is recommended for applications where low TOC is predominantly expected.

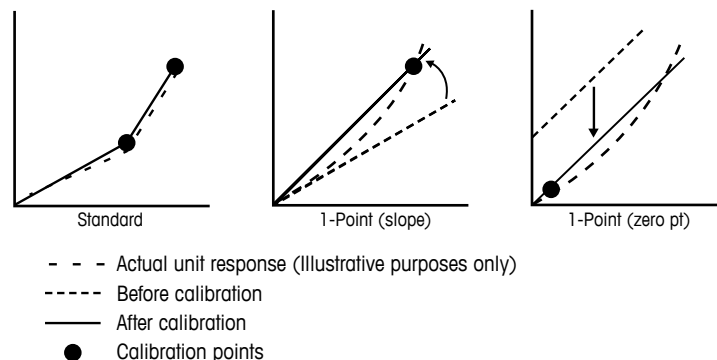



## 8 Quick Setup

(PATH: Menu/Quick Setup)

Select Quick Setup and press the [ENTER] key. Enter the security code if necessary (see section 11 "Passwords").



**NOTE:** Please find the complete description of the Quick Setup routine described in the separate booklet "Quick Setup Guide for Transmitter M300" enclosed in the box.



**NOTE:** Refer to section 3.3 "Control/Navigation Keys" for information on menu navigation.

## 9 Sensor Calibration

(PATH: Cal)

The calibration key ► allows the user one-touch access to Sensor calibration and verification features and Analog Output calibration see chapter 13.3.



**NOTE:** During Calibration, a flashing "H" in the upper left corner of the display indicates a calibration is in process with a Hold condition active. See also chapter 3.4 "Display"

### 9.1 Enter Calibration Mode

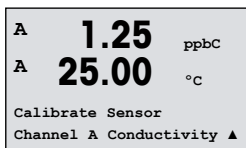

While in Measurement mode press the ► key. If the display prompts you to enter the calibration security code, press the ▲ or ▼ key to set the calibration security mode, then press the [ENTER] key to confirm the calibration security code.

Press the ▲ or ▼ key to select the type of calibration desired. The choices for each sensor type are: TOC, Conductivity1, Conductivity2, Temperature1, Temperature2, Flow, Edit Press [ENTER].

For a detailed explanation on how to perform a calibration in the 4000TOCe please refer to the Standard Operating Procedure, P/N 30 414 621 .

# 10 Configuration

(PATH: Menu/Configure)

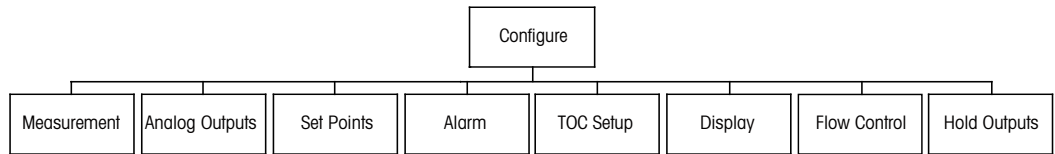

## 10.1 Enter Configuration Mode

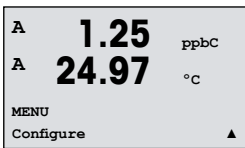

While in Measurement mode, press the ◀ key. Press the ▲ or ▼ key to navigate to the Configure – Menu and press [ENTER].

## 10.2 Measurement

(PATH: Menu/Configure/Measurement)

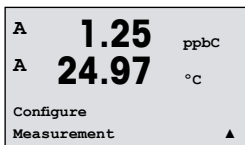

Enter configuration mode as described in Section 10 “Enter Configuration Mode”.

Press the [ENTER] key to select this Menu. The following sub menus can now be selected: Channel Setup, Resistivity, and Set Averaging.

### 10.2.1 Channel Setup

(PATH: Menu/Configure/Measurement/Channel Setup)

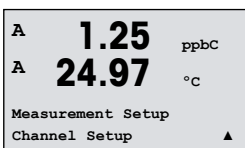

Press the [ENTER] key to select the “Channel Setup” Menu. To select the parameter that will be displayed on each line.

The options include: TOC in ppb, g C/L, Ω-cm, S/cm, S/m, °C, °F, Lamp Remaining, Nothing.

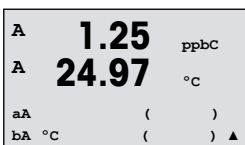

The 4 lines of the display can now be configured for each line of the display, selecting measurements and unit multipliers. Pressing the [ENTER] key will display the selection for lines c and d.

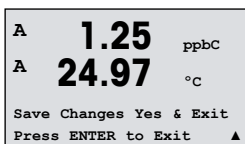

Pressing the [ENTER] key again will bring up the Save Changes dialog. Selecting No will discard the entered values and return to the measurement display screen, selecting Yes will save changes made.

## 10.2.2 Conductivity/Resistivity Temperature Compensation

(PATH: Menu/Configure/Measurement/Resistivity)

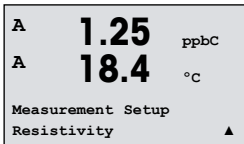

Select Resistivity and press [ENTER].

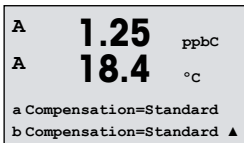

The temperature compensation mode for any of the four measurement lines configured to display conductivity can be selected. Choices are "None", and "Standard".

Standard compensation includes compensation for non-linear high purity effects as well as conventional neutral salt impurities and conforms to ASTM standards D1125 and D5391.

## 10.2.3 Set Averaging

(PATH: Menu/Configure/Measurement/Set Averaging)

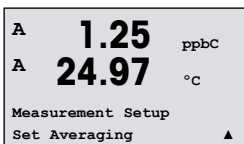

Press the [ENTER] key to select this Menu. The averaging method (noise filter) for each measurement line can now be selected. The options are Special (Default), None, Low, Medium and High:

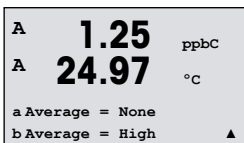

None = no averaging or filtering  
Low = equivalent to a 3 point moving average  
Medium = equivalent to a 6 point moving average  
High = equivalent to a 10 point moving average  
Special = averaging depending on signal change (normally High averaging but Low averaging for large changes in input signal)

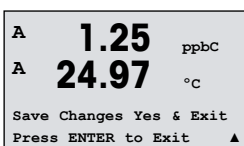

Pressing the [ENTER] key again will bring up the Save Changes dialog. Selecting No will discard the entered values and return to the measurement display screen, selecting Yes will save changes made.

## 10.3 TOC Setup

### 10.3.1 TOC General Parameters

(Path: Menu/Configure/TOC Setup/TOC General Para)

The 'TOC General Para' menu allows the user to configure several basic operational characteristics of the 4000TOCe sensor. These functions are explained in detail below.

#### Auto Start

Auto Start is a feature that allows the 4000TOCe Sensor to automatically start making TOC measurements when it is connected to an M300 TOC or when the M300 TOC or 4000TOCe restarts

offer power loss. The factory default setting for the Auto Start function is 'No'. Therefore during initial start-up, the M300 TOC will identify the sensor as a 4000TOCe Sensor, yet will not start a TOC measurement. To start a TOC measurement, the user must go to the 'UV Lamp: On/Off' screen and set this mode to 'On' to turn on the UV lamp and start a TOC measurement. The user may also push the UV lamp button at the Sensor to start a measurement. Once the 'Auto Start' mode is set to 'Yes', it is no longer necessary to turn the 'UV Lamp' option to 'On' as the 'Auto Start' function will override the UV Lamp: On/Off function.

Select 'Yes' if you want to enable the Auto Start feature. Select 'No' to disable this feature. In the event that direct human interaction is desired to re-start measurements, this feature should be set to 'No'.

#### **Sensor Key Lock**

Sensor Key Lock will deactivate the UV lamp control button located on the 4000TOCe. The Sensor Key Lock option can be set to 'Yes' or 'No'. The default is 'No'. To de-activate the Keypad at the Sensor, change this to 'Yes'. This function can be used to avoid inadvertently turning the UV lamp off at the sensor under normal operating conditions.

#### **Conductivity Limit**

The Conductivity Limit allows configuring the sensor so that exceeding the specified conductivity limit will alert the operator when the limit is exceeded by giving an error indication and message. The limits are selectable, and must be set above 0.0  $\mu\text{S}/\text{cm}$ .

#### **Over-ride Limit**

Related to the Conductivity Limit setting, an error message will occur when the Conductivity Limit is exceeded when 'Yes' is selected. The Conductivity Limit is ignored when 'No' is selected.

### **10.3.2 Lamp Control**

(Path: Menu/Configure/TOC Setup/Lamp Control)

1. UV Lamp: The 'UV Lamp' function allows the user to turn on or off the UV lamp. For initial start-up, the sensor key "UV Lamp On" must be pressed.
2. Lamp Limit: The UV lamp in the 4000TOCe Sensor is rated for 4500 hours of normal usage. The M300 TOC will display an error message when the lamp operating time has exceeded the lamp limit, which is set to 4500 hours by default. The user can adjust the Lamp Limit to any value from 400 to 4500 hours. It is the user's responsibility to assure by calibration or other means that the lamp is outputting sufficient UV light for the sensor to make accurate TOC measurements. Remaining lamp life as Indicated by the lamp life counter can be viewed by pressing the 'Info' key. Please refer to Section 14 for more information.
3. Lamp Time Reset: During normal operation, the 4000TOCe sensor will automatically track the operating time of the UV Lamp. Once the set lamp limit is exceeded, an error indication will be given to alert the user that the lamp should be replaced. Following lamp replacement, the lamp life counter must be re-set by the user. To re-set the lamp life counter, enter the Lamp Control menu, select 'Lamp Time Reset = Yes and press the enter key. This will reset the counter to the Lamp Limit.

### **10.3.3 Autobalance**

(Path: Menu/Configure/TOC Setup/Autobalance)

The 4000TOCe Sensor is capable of automatically balancing the two conductivity sensors. This step is performed to account for small differences in conductivity measurement between the two conductivity sensors. The default factory condition of the AutoBalance feature of the 4000TOCe

Sensor is No. This will result in no AutoBalance activity being performed automatically. The user may change this attribute to 'Yes' at anytime. For applications with very low TOC (<5 ppb) AND high resistivity (>15 Mohm-cm), it is advised to set this feature to 'YES' for improved accuracy. For applications that do not meet both criteria, such as USP water production, the user may elect to remain with 'No' AutoBalance with little observable effect.

If power to the sensor is interrupted and restored, or if the patch cable is disconnected and then re-connected, an Autobalance will occur if the Autobalance function is enabled. The user also has the ability to set or change settings for several functions associated with Autobalance. These additional functions will not be accessible unless Autobalance is enabled.

1. Autobalance: Enable (yes) or disable (no) Autobalance feature
2. Autobalance Now: Perform an immediate Autobalance (AutoBal Now)
3. Autobalance Hold: Set a hold 'last measurement' so the relays are held in their current state while an Autobalance occurs
4. Cycle Time: Set a time interval for the Autobalance to occur automatically. This value is selectable from 24 to 4500 hours, with a factory default setting of 4500 hours. Note that the time remaining until the next autobalance occurs can be viewed by pressing the Info key and selecting 'TOC Sensor Info'. Please refer to Section 14 for additional information.
5. Autopal Limit: Set the tolerance for balancing the sensors (limit in %). This is the percentage difference allowed between the two conductivity cell readings during an Autobalance cycle when the lamp is off.
6. Rinse Time: Set the length of time that the 4000TOCe sensor will have sample water flowing through it before performing the Autobalance function. The Rinse Time can be set from 1 to 999 minutes. During the rinse and autobalance process, the UV lamp will be turned off, and the sensor will not provide a TOC indication.

## 10.4 Analog Outputs

(PATH: Menu/Configure/Analog Outputs)

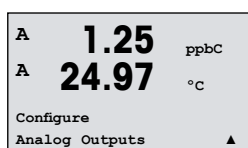

Enter configuration mode as described in Section 10.1 "Enter Configuration Mode" and navigate to the menu "Analog Outputs" by using the ▲ or ▼ key.

Press the [ENTER] key to select this Menu, which lets you configure the 2 Analog Outputs.

Once analog outputs have been selected, use the ◀ and ▶ buttons to navigate between configurable parameters. Once a parameter is selected, its setting can be selected per the following table:

When an Alarm Value is selected, the analog output will go to this value if any alarm condition occurs.

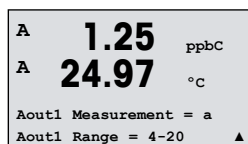

Parameter	Selectable Values
Aout:	1, 2, (default is 1)
Measurement:	a, b, c, d or blank (none) (default is blank)
Alarm Value:	3.6 mA, 22.0 mA or Off (default is off)

The Aout type can be Normal, Bi-Linear, Auto-Range or Logarithmic. The range can be 4–20mA or 0–20mA. Normal provides linear scaling between the minimum and maximum scaling limits and is the default setting. Bi-Linear will also prompt for a scaling value for the mid-point of the signal and allows two different linear segments between the minimum and maximum scaling limits.

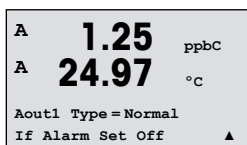

Enter the minimum and maximum Value of Aout1.

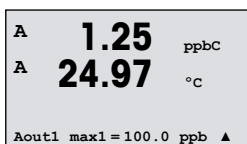
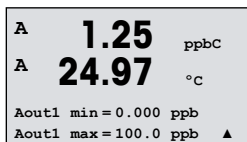

If Auto-range was selected then Aout max1 can be configured. Aout max1 is the maximum value for the first range on Auto-Range. The maximum value for the second range on Auto-Range was set in the previous menu. If Logarithmic Range was selected, it will also prompt for the number of decades as "Aout1 # of Decades =2".

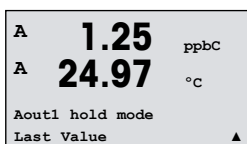

The value for the Hold mode can be configured to hold the Last value or can be set to a Fixed value.

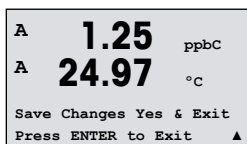

Pressing the [ENTER] key again will bring up the Save Changes dialog. Selecting No will discard the entered values and return to the measurement display screen, selecting Yes will save changes made.

## 10.5 Setpoints

(PATH: Menu/Configure/Setpoints)

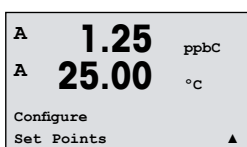

Enter configuration mode as described in Section 10.1 "Enter Configuration Mode".

Press the [ENTER] key to select this Menu.

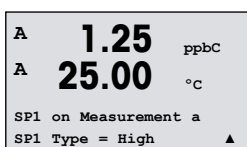

4 Setpoints can be configured on any of the measurements (a thru d). The possible Setpoint types are Off, High, Low, Outside and Between. Options are also provided for measurement, %USP, %EP PW, %EP WFI and JP Cond for configuration with the conductivity measurement.

An "Outside" Setpoint will cause an alarm condition whenever the measurement goes above its high limit or below its low limit. A "Between" Setpoint will cause an alarm condition to occur whenever the measurement is between its high and low limits.

USP and EP Setpoints on Thornton models provide a high alarm used for pharmaceutical water monitoring with non-temperature compensated conductivity measurements. USP (United States Pharmacopoeia) General Chapter <645> and European Pharmacopoeia require that non-temperature compensated conductivity of pharmaceutical waters must be below a limit from tables based on the temperature of the sample.

The METTLER TOLEDO Thornton M300 has these pharmaceutical limit tables in memory and automatically determines the conductivity limit based on the measured temperature. USP and EP WFI (Water for Injection) setpoints use Table 10.1. The limit is the conductivity value corresponding to the 5 °C temperature step immediately below or equal to the measured temperature

value. EP *Highly Purified Water* limits are identical to EP WFI limits.

EP PW (Purified Water) setpoints use Table 10.2. The limit in this case is the conductivity value interpolated for the measured temperature. The M300 takes care of this automatically.

The pharmaceutical setpoint value entered into the M300 is the percentage safety margin *below* the limits to activate the setpoint. For example, the USP table conductivity limit at 15 °C is 1.0 µS/cm. If the setpoint value is set at 40% then the setpoint will activate whenever the conductivity goes above 0.6 µS/cm at 15 °C.

Table 10.1: USP General Chapter <645> Stage 1, EP WFI (Water for Injection), EP Highly Purified Water, and JP Conductivity Limits as a Function of Temperature.

Temperature (°C)	Conductivity Limit (µS/cm)
0	0.6
5	0.8
10	0.9
15	1.0
20	1.1
25	1.3
30	1.4
35	1.5
40	1.7
45	1.8
50	1.9
55	2.1
60	2.2
65	2.4
70	2.5
75	2.7
80	2.7
85	2.7
90	2.7
95	2.9
100	3.1

Table 10.2: EP PW (Purified Water) Conductivity Limits as a Function of Temperature

Temperature (°C)	Conductivity Limit (µS/cm)
0	2.4
10	3.6
20	4.3
25	5.1
30	5.4
40	6.5
50	7.1
60	8.1
70	9.1
75	9.7
80	9.7
90	9.7
100	10.2



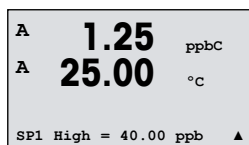

Enter the desired value(s) for the Setpoint and press [ENTER]

This screen provides the option to configure a setpoint to be active on an over range condition. Select the setpoint and "Yes" or "No". Select the desired relay that will activate when the setpoint alarm condition is reached.

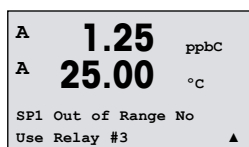

Out of Range

Once configured, the selected relay will be activated if a sensor Out of Range condition is detected on the assigned input channel.

Delay

Enter the delay time in seconds. A time delay requires the setpoint to be exceeded continuously for the specified length of time before activating the relay. If the condition disappears before the delay period is over, the relay will not be activated.

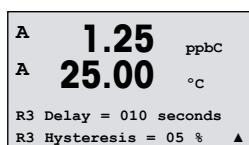

Hysteresis

Enter the hysteresis as a percentage-value. A hysteresis value requires the measurement to return within the setpoint value by a specified percentage before the relay is deactivated.

For a high setpoint, the measurement must decrease more than the indicated percentage below the setpoint value before the relay is deactivated. With a low setpoint, the measurement must rise at least this percentage above the setpoint value before the relay is deactivated. For example, with a high setpoint of 100, when this value is exceeded, the measurement must fall below 90 before the relay is deactivated.

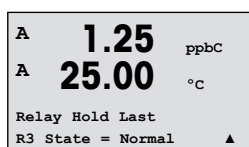

Hold

Enter the Relay Hold Status of "Last", "On" or "Off". This is the state the Relay will go to during a Hold status.

State

Relay contacts are in normal state until the associated setpoint is exceeded, then the relay is activated and the contact states change.

Select "Inverted" to reverse the normal operating state of the relay (i.e. Normally open contacts are in a closed state, and normally closed contacts are in an open state, until the setpoint is exceeded). "Inverted" relay operation is functional when power is applied to the M300 transmitter.

Pressing the [ENTER] key again will bring up the Save Changes dialog. Selecting No will discard the entered values and return to the measurement display screen, selecting Yes will save changes made.

## 10.6 Alarm

(PATH: Menu/Configure/Alarm)

Enter configuration mode as described in Section 10.1 "Enter Configuration Mode".

This Menu allows the configuration of Alarm.

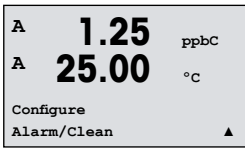

To select "Setup Alarm", press the ▲ or ▼ key so that "Alarm" is flashing.

Using the ◀ and ▶ buttons, navigate to "Use Relay #". Using the ▲ or ▼ keys, select a relay to be used for the Alarm and press [ENTER].

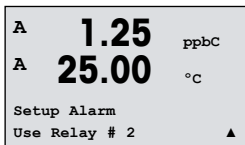

One of the following events may be alarmed:

1. Power Failure
2. Software Failure
3. Channel A disconnected
4. TOC Faults
5. TOC Errors
6. Lamp Off

If any of these criterias are set to Yes and the conditions for an alarm are given, the flashing symbol  $\triangle$  will be shown in the display, an alarm message will be recorded (see also chapter 14.1 "Messages"; PATH: Info/Messages) and the selected relay will be activated. Furthermore an alarm can be indicated by the current output if this has been parameterized (see chapter 10.4 "Analog Outputs"; PATH: Menu/Configure/Analog Outputs)

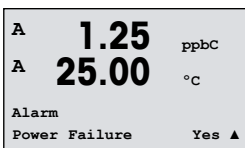

1. There is a power failure or power cycling
2. The software watchdog performs a reset
3. If no sensor is connected on channel A
4. If a TOC fault occurs
5. If a TOC error occurs
6. If the UV lamp is turned off

For 1 and 2 the alarm indicator will be turned off when the alarm message is cleared. It will reappear if the power is constantly cycling or if the watchdog is repeatedly resetting the system.

Each Alarm Relay can be configured in either a Normal or Inverted state. Select "Inverted" to reverse the normal operating state of the relay (i.e. Normally open contacts are in a closed state, and normally closed contacts are in an open state, until an alarm occurs). "Inverted" relay operation is functional when power is applied to the M300 transmitter.

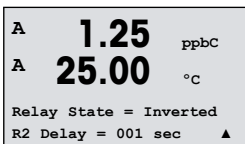

In addition, a Delay for the activation can be set. Enter the delay time in seconds. A time delay requires the alarm to occur continuously for the specified length of time before activating the relay. If the alarm disappears before the delay period is over, the relay will not be activated.

If power failure is turned on, only inverted state is possible and cannot be changed.

Pressing the [ENTER] key again will bring up the Save Changes dialog. Selecting No will discard the entered values, selecting Yes will make the entered values the current ones.



**NOTE:** There are additional alarms, which will be indicated in the display. See therefore in chapter 16 "Troubleshooting" the different warning- and alarm lists.

## 10.7 Display

(PATH: Menu/Configure/Display)

Enter configuration mode as described in Section 10.1 "Enter Configuration Mode".

This Menu allows for the configuration of the values to be displayed and also the configuration of the Display itself.

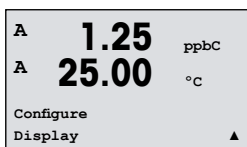

### 10.7.1 Measurement

The Display has 4 lines. Line 1 on top and Line 4 on the bottom.

Select the values (Measurement a, b, c or d) to be displayed on each line of the display.

The selection of the values for a, b, c, d needs to be done under Configuration/Measurement/Channel Setup.

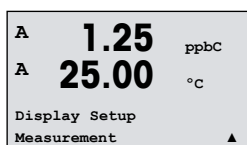

Select the "Error Display" mode. If this is set to "On" when an alarm has occurred, the message "Failure – Press Enter" will be displayed on Line 4 when an alarm occurs in the normal Measurement mode.

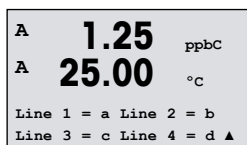

Pressing the [ENTER] key again will bring up the Save Changes dialog. Selecting No will discard the entered values, selecting Yes will make the entered values the current ones.

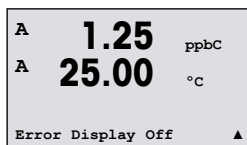

### 10.7.2 Resolution

This menu allows the setting of the resolution of each displayed value.

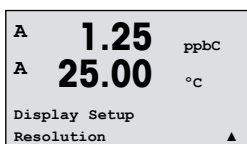

Possible settings are 1, 0.1, 0.01, 0.001 or Auto.

Pressing the [ENTER] key will bring up the Save Changes dialog.

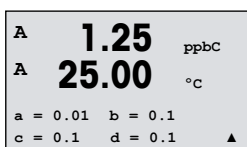

### 10.7.3 Backlight

This Menu allows the setting of the back light options of the display.

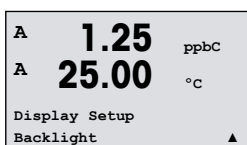



Possible settings are On, On 50% or Auto Off 50%. If Auto Off 50% is selected then the backlight will go to 50% after 4 minutes with no keypad activity. The backlight will automatically come back on if a key is pressed.

Pressing the [ENTER] key will bring up the Save Changes dialog.

## 10.7.4 Name

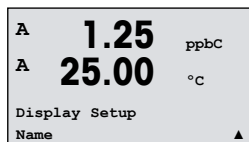

This menu allows for the configuration of an alpha-numeric name which is displayed in the first 9 characters on Lines 3 and 4 of the Display. The default is nothing (blank).

If a name is entered on line 3 and/or 4 a measurement can be still displayed on the same line.

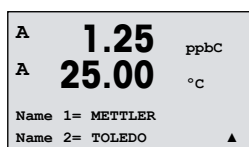

Use the ◀ and ▶ keys to navigate between digits to be altered. Using the ▲ and ▼ keys to change the character to be displayed. Once all digits of both display channels have been entered, press [ENTER] to bring up the Save Changes dialog.

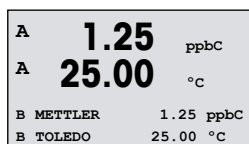

The resulting display in the measurement mode appears on Lines 3 and 4 ahead of the measurements.

## 10.8 Hold Analog Outputs

(PATH: Menu/Configure/Hold Outputs)

Enter configuration mode as described in Section 10.1 "Enter Configuration Mode".

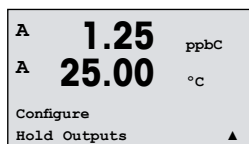

The **"Hold outputs"** function applies during the calibration process. If set "Hold outputs" to Yes, during calibration process the analog output, the output relay and USB output will be at hold state. The hold state depends on the setting. For the possible hold settings, see the list below. The following options are possible:

Hold Outputs? Yes/No

# 11 System

(PATH: Menu/System)

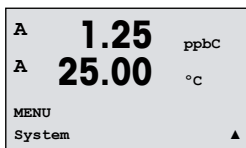
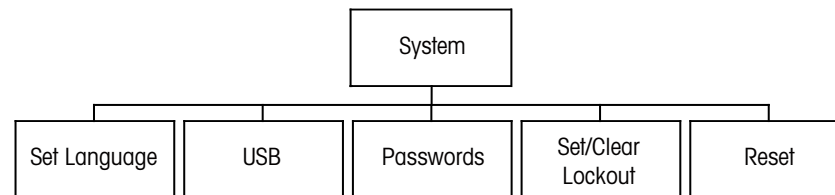

While in Measurement mode press the ◀ key. Press the ▼ or ▲ key to navigate to "System" – Menu and press [ENTER].

## 11.1 Set Language

(PATH: Menu/System/Set Language)

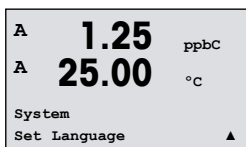

This Menu allows the configuration of the Display language.

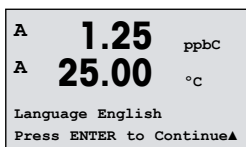

The following selections are possible:  
English, French, German, Italian, Spanish, Russian, Portuguese and Japanese.

Pressing the [ENTER] key will bring up the Save Changes dialog.

## 11.2 Passwords

(PATH: Menu/System/Passwords)

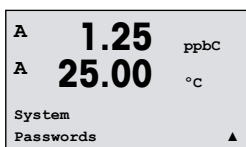

This Menu allows for the configuration of Operator and Administrator Passwords, as well as setting up a List of allowed Menus for the Operator. The Administrator has rights to access all Menus. All default passwords for new transmitters are "00000".

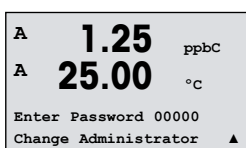

The Passwords Menu is protected: Enter the Administrator Password to enter the Menu.

## 11.2.1 Changing Passwords

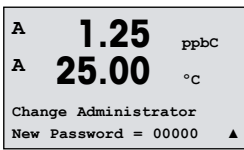

See Section 11.3 "Passwords" how to enter the Passwords Menu. Select Change Administrator or Change Operator and set the new Password.

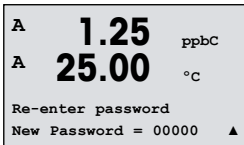

Press the [ENTER] key and confirm the new password. Press [ENTER] again to bring up the Save Changed dialog.

## 11.2.2 Configuring Menu Access for Operator

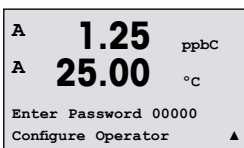

See 9.3 "Passwords" how to enter the Passwords Menu. Select Configure Operator to configure the Access list for the Operator. It is possible to assign/deny rights to the following Menus: Cal Key, Quick Setup, Configuration, System and Service.

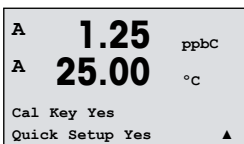

Choose either Yes or No to give/deny access to the above Menus and press [ENTER] to advance to the next items. Pressing the [ENTER] key after configuring all menus will bring up the Save Changes dialog. Selecting No will discard the entered values, selecting Yes will make the entered values the current ones.

## 11.3 Set/Clear Lockout

(PATH: Menu/System/Set/Clear Lockout)

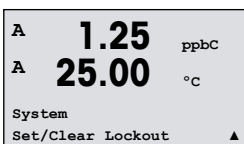

This menu enables/disables the Lockout functionality of the transmitter. The user will be asked for a password before being allowed into any menus if the Lockout functionality is enabled.

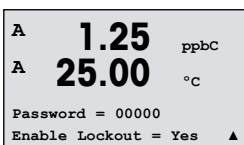

The Lockout – Menu is protected: Enter the Administrator Password and select YES to enable or NO to disable the Lockout functionality. Pressing the [ENTER] key after the selection will bring up the Save Changes dialog. Selecting No will discard the entered value, selecting Yes will make the entered value the current one.

## 11.4 Reset

(PATH: Menu/System/Reset)

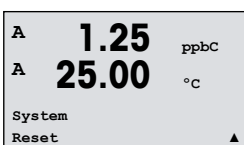

This Menu allows access to the following options:  
Reset System, Reset Analog Cal, Reset Sensor Cal, Reset Elec Cal.

### 11.4.1 Reset System

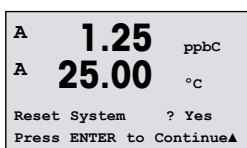

This Menu allows the reset of the M300 TOC transmitter to the factory default settings (Setpoints off, analog outputs off, etc.). The analog output calibration are not affected.

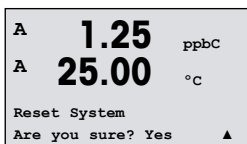

Pressing the [ENTER] key after the selection will bring up a confirmation screen. Selecting No will return the user to the Measurement mode with no changes. Selecting Yes will reset the M300 TOC transmitter.

### 11.4.2 Reset Analog Calibration

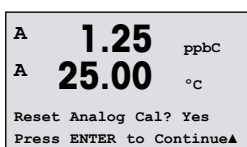

This Menu allows reset of the Analog Output calibration factors to the last factory calibration values.

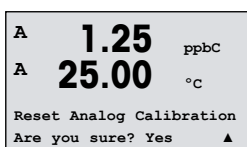

Pressing the [ENTER] key after the selection will bring up a confirmation screen. Selecting No will return the user to the Measurement mode with no changes. Selecting Yes will reset the Analog Output calibration.

### 11.4.3 Reset Sensor Calibration Data to Factory Settings

This menu allows the reset of the calibration data of the TOC sensor to the factory settings. This includes calibration data for the TOC, conductivity, temperature and flow measurements. Please note that the conductivity electronics calibration is performed separately as determined by the needs of the application. The conductivity measurement circuit calibration is reset using the reset Elec Cal function.

Pressing the [ENTER] key after the selection will bring up a confirmation screen. Selecting No will return the user to the Measurement mode with no changes. Selecting Yes will reset the calibration data of the sensor to factory settings.



**NOTE:** To ensure best measuring results, a new calibration of the sensor is recommended after a reset of the calibration data to factory settings.

### 11.4.4 Reset Calibration Data of Sensor Electronics to Factory Settings

This menu allows the rest of the calibration data of the conductivity measurement electronics, separate from the system calibration. To reset the conductivity system calibration, use the Reset Sensor Cal function.

Pressing the [ENTER] key after the selection will bring up a confirmation screen. Selecting No will return the user to the Measurement mode with no changes. Selecting Yes will reset the calibration data of the sensor to factory settings.

## 12 4000TOCe Sensor Service Requirements

The 4000TOCe Sensor is designed to minimize service and maintenance. This reduces the amount of consumable components as well as the amount of time needed to maintain the sensor. Listed below are instructions on how to perform simple periodic maintenance, which includes UV Lamp change (every 4500 hours of operation), filter replacement (typically every 6 months), and general cleaning.

### 12.1 UV Lamp Replacement

**WARNING: UV RADIATION HAZARD**

Apply power to UV lamp only when installed in housing in accordance with instruction manual. DO NOT remove UV lamp from housing unless power is off.

**Always protect eyes and skin from exposure to UV light.**

METTLER TOLEDO recommends replacement of the UV lamp inside the 4000TOCe Sensor after 4500 hours of operation, or 6 months of continuous use. This is a simple procedure that requires only a few minutes to complete. The following steps explain the proper procedure for the UV lamp change-out. Refer to the illustration below..



**CAUTION:** Use of a UV lamp other than those provided by METTLER TOLEDO Thornton specifically for use with the 4000TOCe Sensor will affect performance and void the warranty of this product.

1. At the sensor, turn off the UV lamp by pressing the lamp control button (UV lamp ON LED will turn off). If the LED does not turn off, check that the Sensor Key Lock is in the off position in the M300 TOC. Refer to Section 10.3.1 Sensor Key Lock function in this manual.
2. Once power to the UV lamp is off, open the front cover of the sensor enclosure with the front cover tool.
3. Remove the side cover labeled 'UV LAMP REPLACEMENT COVER' on the left side of the sensor enclosure. Use a large-bladed flat-head screwdriver and turn the cover counter clockwise to loosen and unscrew the cover.
4. Disconnect the power cable to the UV lamp. This connector is located on the backside of the front cover, above the circuit board.
5. Loosen the UV lamp holding screw located on the left side of the oxidation chamber.
6. Slide the cable of the UV lamp through the side opening of the enclosure and gently slide the UV lamp out of the oxidation chamber assembly (stainless steel cylinder). Be careful not to let the UV lamp hit the quartz glass tube inside the chamber.
7. Use the gloves supplied with each replacement bulb. Hold the new lamp from the ends of the lamp. Do not touch the bulb. Slide the new UV lamp into the side opening of the enclosure and into the oxidation chamber opening until it stops. Do not use excessive force to insert the UV lamp as this may cause damage to the lamp or the internal components of the oxidation chamber.
8. Tighten the UV lamp holding screw until snug. Do not over-tighten.
9. Feed the power cable through the side opening of the enclosure. Re-connect it to the power connector on the front door.
10. Close front cover of the sensor and secure fasteners with the front cover tool.



11. Install the UV Lamp replacement cover on the opening on the side of the enclosure.
12. At the M300 TOC, press the 'Menu' key, and select Path: Menu/Configure/TOC Setup/Lamp Control. Press the 'Enter' key until 'Lamp Time Reset' is displayed. Select 'Yes', then press enter twice to confirm your selection and save the changes.
13. After the lamp replacement has been completed, a TOC calibration must be performed. In addition, a System Suitability Test is recommended in applications where compliance with Pharmacopeia regulations is necessary.

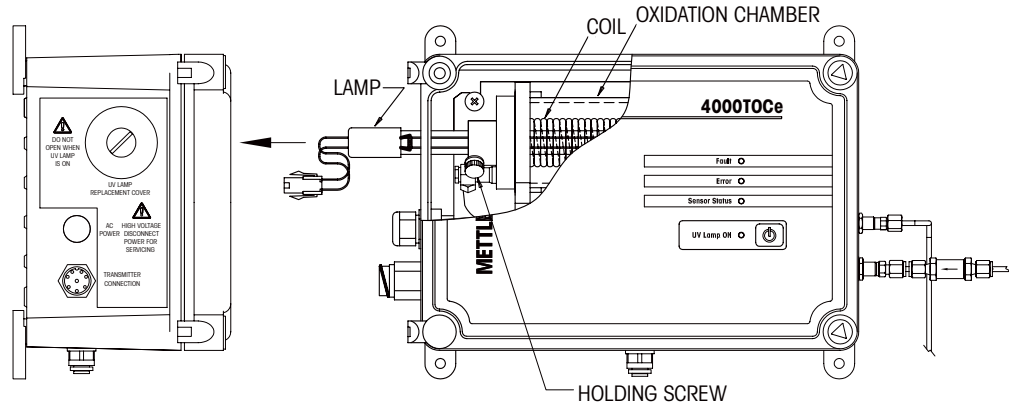

## 12.2 High Capacity Inlet Filter Replacement

The 4000TOCe Sensor includes a high capacity filter (shown below) containing a filter element that should be replaced (p/n 58 091 551, package of 2) every 6 months or sooner, depending on water quality conditions. Detailed instructions to replace this filter are included in the replacement package.

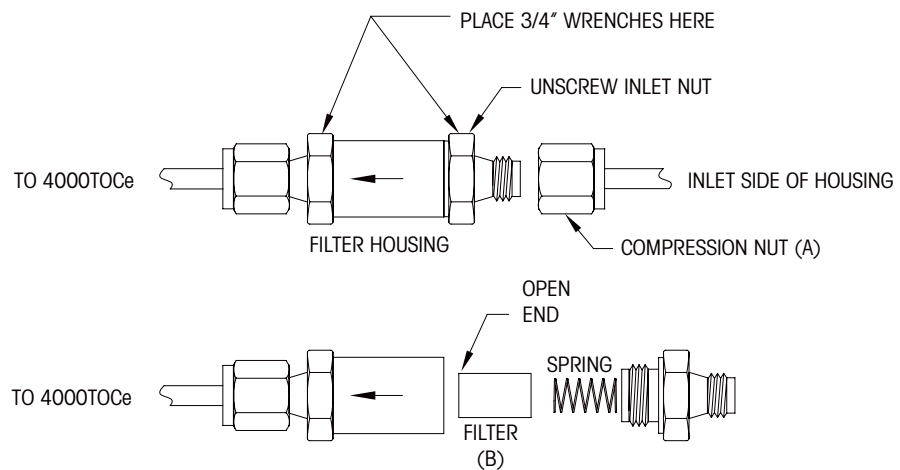

REPLACING THE FILTER ELEMENT FOR THE HIGH CAPACITY INLET FILTER

## 12.3 Front Panel Cleaning

Clean the front panel with a damp soft cloth (water only, no solvents). Gently wipe the surface and dry with a soft cloth.

## **12.4 Technical Support**

For technical support and product information for the 4000TOCe, contact your local METTLER TOLEDO Sales Office or representative.

## **12.5 Draining and Shipping Instructions**

The 4000TOCe contains a glass coil which facilitates oxidation of the water sample. Water freezing within the coil during transportation will cause this coil to break. Therefore, it is important that all water be removed from the TOC sensor prior to shipment.

To drain the water, connect the TOC sensor to AC power. To put the flow control valve into the 'Drain' mode, press and hold the UV Lamp button for 5 seconds until the Sensor Status LED begins flashing. This mode will fully open the automatic flow control valve to allow draining the sensor more easily. Once the valve has been placed into the 'Drain' mode, use the supplied plastic syringe to push the water out of the sensor, blowing from the inlet, and pushing water out through the sensor outlet.

# 13 M300 TOC Service

(PATH: Menu/Service)

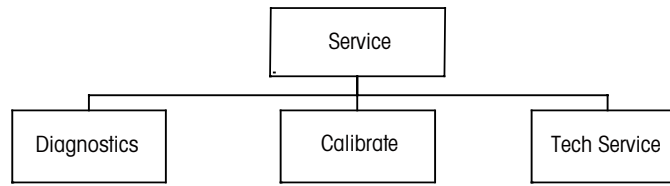

## 13.1 Enter Service Menu

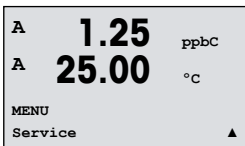

While in Measurement mode press the ◀ key. Press the ▲ or ▼ key to navigate to the “Service” Menu and press [ENTER]. The available system configuration options are detailed below

## 13.2 Diagnostics

(PATH: Menu/Service/Diagnostics)

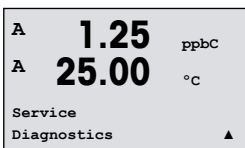

Enter Service Menu as described in section 13.1 “Enter Service Menu” and press [ENTER] .

This Menu is a valuable tool for troubleshooting and provides diagnostic functionality for the following items: Model/Software Revision, Display, Keypad, Memory, Set Relays, Read Relays, Set Analog Outputs, Read Analog Outputs.

### 13.2.1 Model/Software Revision

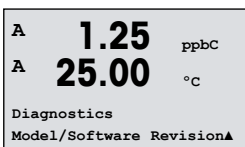

Essential information for every Service call is the model and software revision number. This menu shows the part number, model and the serial number of the TOC Sensor. By using the ▼ key it is possible to navigate forward through this submenu and get additional information including the current version of firmware implemented on the transmitter (Master V\_XXXX and Comm V\_XXXX); and the version of the sensor firmware (FW V\_XXX) and sensor hardware (HW XXXX).

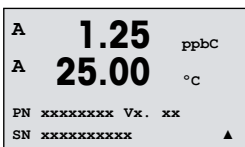

Press [ENTER] to exit from this display.

### 13.2.2 Display

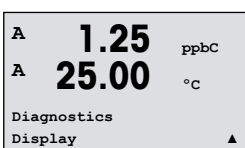

All pixels of the display will be lit for 15 seconds to allow troubleshooting of the display. After 15 seconds the transmitter will return to the normal Measuring mode or press [ENTER] to exit sooner.

### 13.2.3 Keypad

```

A 1.25 ppbC
A 25.00 °C
Diagnostics
Keypad ▲

```

For keypad diagnostics, the display will indicate which key is pressed. Pressing [ENTER] will return the transmitter to the normal Measuring mode.

```

A 1.25 ppbC
A 25.00 °C
Key press = (MENU)
Press ENTER to Continue▲

```

### 13.2.4 Memory

```

A 1.25 ppbC
A 25.00 °C
Diagnostics
Memory ▲

```

If Memory is selected then the transmitter will perform a RAM and ROM memory test. Test patterns will be written to and read from all RAM memory locations. The ROM checksum will be recalculated and compared to the value stored in the ROM.

```

A 1.25 ppbC
A 25.00 °C
Memory Test Passed
Press ENTER to Continue▲

```

### 13.2.5 Set Relay

```

A 1.25 ppbC
A 25.00 °C
Diagnostics
Set Relays ▲

```

The Set Relays diagnostic menu allows to open or close each relay manually. To access relays 5 and 6, press [ENTER].

0 = open the relay  
1 = close the relay

```

A 1.25 ppbC
A 25.00 °C
Relay1 = 0 Relay2 = 0
Relay3 = 0 Relay4 = 0 ▲

```

Press [ENTER] to return to Measurement mode.

### 13.2.6 Read Relays

```

A 0.28 µS/cm
A 25.00 °C
Diagnostics
Read Relays ▲

```

The Read Relays diagnostic menu shows the state of each Relay as defined below. To display Relays 5 and 6, press [ENTER]. Press [ENTER] again to exit from this display.

0 = Normal  
1 = Inverted.

```

A 1.25 ppbC
A 25.00 °C
Relay1 = 0 Relay2 = 0
Relay3 = 0 Relay4 = 0 ▲

```

### 13.2.7 Set Analog Outputs

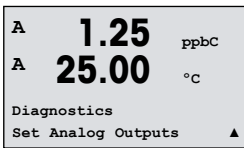

This menu enables the user to set all analog outputs to any mA value within the 0–22 mA range. Press [ENTER] to exit from this display.

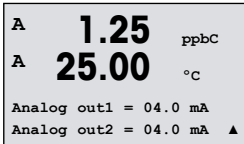

### 13.2.8 Read Analog Outputs

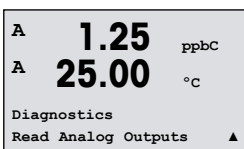

This menu shows the mA value of the analog Outputs. Press [ENTER] to exit from this display.

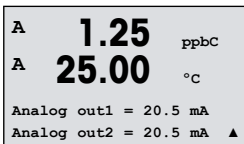

## 13.3 Calibrate

(PATH: Menu/Service/Calibrate)

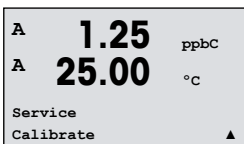

Enter Service Menu as described in section 13.1 “Enter Service Menu”, select Calibrate, and press [ENTER].

This menu has the options to calibrate the transmitter and the analog outputs and also allows the unlocking of calibration functionality.



**NOTE:** For detailed instructions on calibration of the flow, temperature, conductivity and TOC measurements, please refer to Standard Operating Procedure, P/N 30 414 621

### 13.3.1 Verify Conductivity Electronics

In applications where the internal conductivity measurement of the 4000TOCe is being used to monitor compliance with USP and EP requirement for conductivity, verification of the measurement electronics is required. For verification of the measurement electronics, please contact your local METTLER TOLEDO Thornton representative.

### 13.3.2 Calibrate Analog

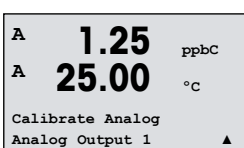

Select the Analog Output you wish to calibrate. Each Analog output can be calibrated at 4 and 20 mA.

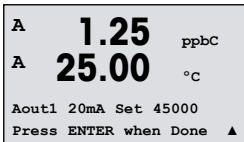

Connect an accurate milliamp meter to the Analog output terminals and then adjust the five digit number in the display until the milliamp meter reads 4.00 mA and repeat for 20.00 mA.

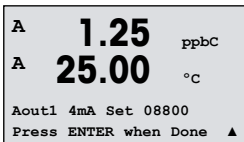

As the five digit number is increased the output current increases and as the number is decreased the output current decreases. Thus coarse changes in the output current can be made by changing the thousands or hundreds digits and fine changes can be made by changing the tens or ones digits.

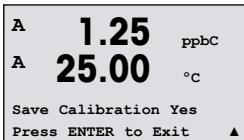

Pressing the [ENTER] key after entering both values will bring up a confirmation screen. Selecting No will discard the entered values, selecting Yes will make the entered values the current ones.

### 13.3.3 Calibrate Unlock

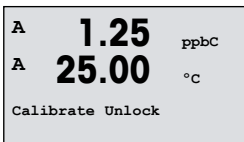

Select this Menu to configure the CAL Menu (see chapter 9 "Sensor Calibration").

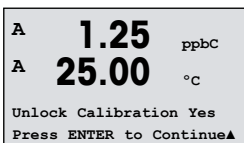

Selecting Yes means that the conductivity verification menu (see chapter 13.3.1 "Verify Conductivity Electronics") and Analog Output calibration menu (see chapter 13.3.2 "Calibrate Analog") will be selectable under the CAL Menu. Selecting No means that only the Sensor calibration is available under the CAL Menu. Press [ENTER] after the selection to display a confirmation screen.

## 13.4 Tech Service

(PATH: Menu/Tech Service)



**NOTE:** This Menu is for METTLER TOLEDO Service personnel use only.

## 14 Info

(PATH: Info)

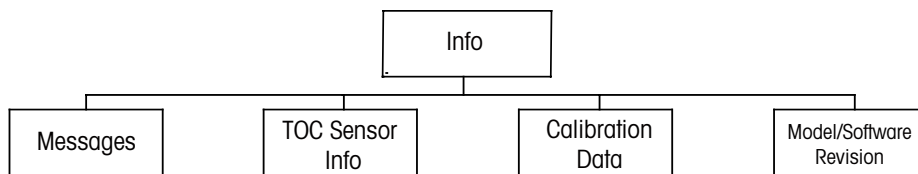

### 14.1 Info Menu

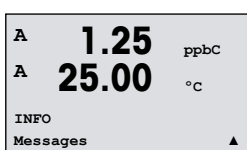

Pressing the ▼ key will display the Info Menu with the options Messages, Calibration Data and Model/Software Revision.

### 14.2 Messages

(PATH: Info/Messages)

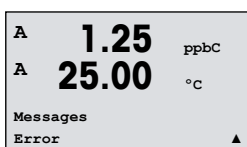

Enter Info Menu as described in section 14.1 "Info Menu" and press [ENTER].

The most recent message is displayed. The up and down arrow keys allow scrolling through the last four messages that have occurred.

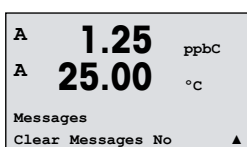

Clear Messages clears all the messages. Messages are added to the message list when the condition that generates the message first occurs. If all messages are cleared and a message condition still exists and started before the clear then it will not appear in the list. For this message to re-occur in the list the condition must go away and then reappear.

### 14.3 Calibration Data

(PATH: Info/Calibration Data)

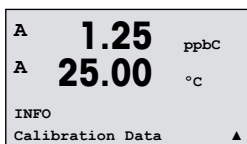

Enter Info Menu as described in section 14.1 "Info Menu", select Calibration Data, and press [ENTER].

The menu displays the calibration constants for each parameter within the TOC sensor. Use the up and down arrow keys to select TOC, Conductivity, Temperature or Flow

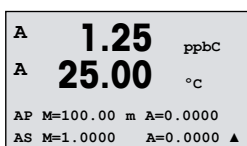

Press [ESC] to exit from this display.

## 14.4 Model/Software Revision

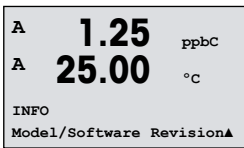

Essential information for every Service call is the model and software revision number.

This menu shows the part number, model and the serial number of the TOC Sensor. By using the ▼ key it is possible to navigate forward through this submenu and get additional information including the current version of firmware implemented on the transmitter (Master V\_XXXX and Comm V\_XXXX); and the version of the sensor firmware (FW V\_XXX) and sensor hardware (HW XXXX).

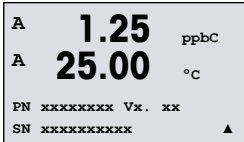

Press [ENTER] to exit from this display.

## 14.5 TOC Sensor Info

(PATH: Info/TOC Sensor Info)

1. TOC: Will display sensor type, sensor firmware version, sensor Serial Number and sensor Part number
2. UV Lamp Time Remaining: Displays remaining life of UV lamp in hours
3. Autobalance: Displays time remaining until next autobalance, and the current autobalance offset value. If the Autobalance function is turned off, the time remaining will be displayed as 'N/A'
4. Flow: Displays current measured flow rate through the sensor will be displayed in ml/min.
5. C1 (C2): Displays sensor serial number.

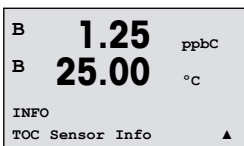

Enter Info Menu as described in section 14.1 "Info Menu", select ISM Sensor Info, and press [ENTER].

After plugging in a TOC sensor, information about the various portions of the TOC sensor will be shown in this menu. Use up and down arrows to scroll through the menu. To select TOC, C1, C2, Flow, auto balance or UV Lamp Time Remaining.

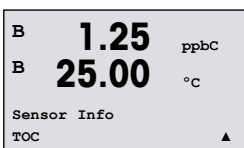

Once selected press the {ENTER} to view additional details pertaining to the selected item.



## 15 Troubleshooting the M300 TOC Transmitter

If the equipment is used in a manner not specified by METTLER TOLEDO Thornton, Inc., the protection provided by the equipment may be impaired.

Review the table below for possible causes of common problems:

Problem	Possible Cause
Display is blank.	<ul style="list-style-type: none"> <li>No power to M300.</li> <li>Blown fuse.</li> <li>LCD display contrast set incorrectly.</li> <li>Hardware failure.</li> </ul>
Incorrect measurement readings.	<ul style="list-style-type: none"> <li>Sensor improperly installed.</li> <li>Incorrect units multiplier entered.</li> <li>Temperature compensation incorrectly set or disabled.</li> <li>Sensor needs calibration.</li> <li>Sensor or patch cord defective or exceeds recommended maximum length.</li> <li>Hardware failure.</li> </ul>
Measurement readings not stable.	<ul style="list-style-type: none"> <li>Sensors or cables installed too close to equipment that generates high level of electrical noise.</li> <li>Recommended cable length exceeded.</li> <li>Averaging set too low.</li> <li>Sensor or patch cord defective.</li> </ul>
Displayed $\Delta$ is flashing.	<ul style="list-style-type: none"> <li>Setpoint is in alarm condition (setpoint exceeded).</li> <li>Alarm, that has been selected (see chapter 10.6 "Alarm"), has occurred.</li> </ul>
Cannot change menu settings.	<ul style="list-style-type: none"> <li>User locked out for security reasons.</li> </ul>

### 15.1 Changing the Fuse

Make sure that the mains cable is unplugged before changing the fuse. This operation should only be carried out by personnel familiar with the transmitter and who are qualified for such work.

If the power consumption of the M300 transmitter is too high or a malfunction leads to a short circuit the fuse will blow. In this case remove the fuse and replace it with one specified in Section 17 "Accessories and Spare Parts".

## 15.2 Warning- and Alarm indication on the display

### 15.2.1 Warning indication

If there are conditions, that generate a warning, the message will be recorded through the menu Messages (see chapter 14.1 "Messages"; PATH: Info/Messages). According to the parameterisation of the transmitter the hint "Failure – Press Enter" will be shown at line 4 of the display if a warning or alarm has occurred (see chapter 10.7 "Display"; PATH: Menu/Configure/Display/Measurement).

### 15.2.2 Alarm indication

Alarms will be shown in the display by a flashing symbol  $\Delta$  and recorded through the menu Messages (see chapter 14.1 "Messages"; PATH: Info/Messages).

Furthermore the detection of some alarms can be activated or deactivated (see chapter 8.5 "Alarm"; PATH: Menu/Configure/Alarm) for an indication on the display. If one of these alarms occurs and the detection has been activated, the flashing symbol  $\Delta$  will be shown on the display. The message will be recorded through the menu Messages (see chapter 14.1 "Messages"; PATH: Info/Messages).

Alarms, that are caused by a violation of the limitation of a setpoint or the range (see chapter 8.4 "Setpoints"; PATH: Menu/Configure/Setpoint) will be shown by a flashing symbol  $\Delta$  and recorded through the menu Messages (see chapter 14.1 "Messages"; PATH: Info/Messages).

According to the parameterisation of the transmitter the hint "Failure – Press Enter" will be shown at line 4 of the display if a warning or alarm has occurred (see chapter 10.7 "Display"; PATH: Menu/Configure/Display/Measurement).

## 16 Troubleshooting the 4000TOCe Sensor

### 16.1 Basic Troubleshooting

Listed below are some techniques that may assist in troubleshooting this piece of equipment. Refer to the Fault Message Table on the next page for Fault and Error messages that appear in the M300 TOC menus when a Fault or Error LED illuminates to signal the user that an undesirable condition exists with the TOC measurement system.

Problem	Possible Cause
None of the LEDs illuminated	<ul style="list-style-type: none"> <li>• LED/Keypad failure.</li> <li>• Circuit board failure</li> <li>• No AC Power available to 4000TOCe sensor</li> </ul>
No Flow from sensor sample outlet	<ul style="list-style-type: none"> <li>• High capacity inlet filter clogged.</li> <li>• Sample flow shut off to sensor inlet.</li> <li>• Internal component leaking.</li> <li>• Sample feed pressure too low.</li> </ul>
Erratic flow through the sensor	<ul style="list-style-type: none"> <li>• Sample outlet tubing not installed per manufacturer's instructions.</li> <li>• Erratic water system/sample feed pressure</li> </ul>

### 16.2 Fault and Error Messages

When an Error or Fault condition exists, the M300 TOC will display the Alarm Status icon. The Fault or Error description can be found by pressing the 'Info' key and accessing the Messages menu (see also Section 14.1 'Messages'; PATH: Info/Messages). The messages associated with the 4000TOCe Sensor are listed in the following tables. The first character of the message will be an F to indicate a fault and an E to indicate an error. A Fault will turn off the UV lamp at the 4000TOCe Sensor, and stop the TOC indication.. Faults cause the M300 TOC to control relays and analog outputs to the defined failsafe condition, i.e., on fault set minimum or maximum.

**Fault Message Table**

Message Displayed	Description	Action
F-UV Lamp Failure	UV lamp not lit when powered up	Check lamp connections or replace lamp
F-No flow detected	Flow < 12 ml/min = no flow or flow sensor failed	Check for obstruction in water line Replace High Capacity Inlet Filter
F-C1 shorted	C1 failure (sensor or cable)	Replace C1
F-C2 shorted	C2 failure (sensor or cable)	Replace C2
F-C1 open	C1 failure or no water	Check for flow. Replace C1.
F-C2 open	C2 failure or no water	Replace C1
F-T1 open/shorted	T1 failure (sensor or cable)	Replace C2
F-T2 open/shorted	T2 failure (sensor or cable)	User must correct
F-Conductivity high	Input conductivity > 100 $\mu$ S/cm compensated on C1	User must correct Misapplication of sensor
F-Communication	Communication failure between M300 TOC and 4000TOCe	Check sensor cable connection Repair sensor Repair transmitter

An Error is generated by a condition that may cause a problem with the proper operation of the sensor. Under an error condition, the sensor will continue to make measurements but the measured value may be in error depending upon the cause of the error message.

**Error Message Table**

<b>Message Displayed</b>	<b>Description</b>	<b>Action</b>
E-UV lamp over time	Lamp life > user limit	Override possible. Change lamp
E-Insufficient flow	Flow rate below 15 mL/min	Check for obstruction in water line Replace inlet filter Flow Control System failure, repair system
E-Flow too high	Flow > 25 mL/min	Check for obstruction in water line Replace inlet filter Flow Control System failure, repair system
E-NVRAM Failure	Can't communicate or checksum invalid	Repair sensor. Will work with default settings. Set by sensor.
E-AutoBal too high	$\Delta C12 < \text{user limit}$	Turn lamp off. Flush system Restart
E-Conductivity unstable	$\Delta C1$ too noisy	Check for air bubbles
E-Conductivity low	Input conductivity < 0.050 $\mu\text{S/cm}$ compensated on C1	User must correct
E-Temp high	Temp Over range > 90 °C at C1	User must correct
E-Temp low	Temperature detected <2 °C at C1	User must correct
E-TOC over range	TOC > 1 ppm	Misapplication of sensor

## 17 Accessories and Spare Parts

Please contact your local METTLER TOLEDO Sales office or representative for details for additional accessories and spare parts.

### 17.1 M300 TOC Transmitter

Description	Order no.
Pipe Mount Kit for 1/2DIN models	52 500 212
Panel Mount Kit for 1/2DIN models	52 500 213
Replacement power fuse 5x20 mm, 1 A, 250 V, time lag, Littlefuse or Hollyland	58 091 220
Terminal blocks for M300	52 121 504
Patch Cord, 1 ft (0.3 m)	58 080 270
Patch Cord, 5 ft (1.5 m)	58 080 271
Patch Cord, 10 ft (3.0 m)	58 080 272
Patch Cord, 15 ft (4.5 m)	58 080 273
Patch Cord, 25 ft (7.6 m)	58 080 274
Patch Cord, 50 ft (15.2 m)	58 080 275
Patch Cord, 100 ft (30.5 m)	58 080 276
Patch Cord, 150 ft (45.7 m)	58 080 277
Patch Cord, 200 ft (61.0 m)	58 080 278
Patch Cord, 300 ft (91.4 m)	58 080 279

### 17.2 4000TOCe Sensor

#### 17.2.1 4000TOCe Sensor Spare Parts

Description	Order no.
Pipe Mounting Kit, 1-1/2" (3.8cm) pipe	58 091 521
Kit, Calibration and System Suitability Test (SST and calibration standards sold separately)	58 091 566
Adapter, 0.25" (6mm) tube to 0.125" (3mm) tube, compression type	58 091 540
Adapter, 0.125" (3mm) O.D. tube X 0.25" (6mm) male-NPT connector	58 091 541
Adapter, 0.125" (3mm) O.D. tube X 0.25" (6mm) female-NPT connector	58 091 542
Adapter, 0.125" (3mm) tube TO 0.5" (13mm) 316 stainless-steel pipe (0.75" [19mm] TRI-CLAMP CONNECTION)	58 091 543
Filter, Large capacity	58 091 550
High pressure regulator	58 091 552
Stainless steel outlet drain assembly	58 091 553
Fuse, 1.25A, Sensor PCB (For use on both 110VAC and 220 VAC Models)	58 091 519
Sampling Conditioning Coil	58 079 518

#### 17.2.2 4000TOCe Sensor Consumable Items

Description	Order no.
Replacement UV Lamp 4000TOCe (recommended every 4,500 hours of operation)	58 079 513
System Suitability Standards (For use with SST KIT #58 091 566)	58 091 526
Solutions, Calibration 4000TOCe (For use with SST KIT #58 091 566)	58 091 529
Combined Calibration and SST Solutions (For use with SST KIT #58 091 566)	58 091 537
Filter element, High Capacity (Pkg. 2)	58 091 551

## 18 Specifications

### 18.1 4000TOCe

#### TOC Sensor

Measurement Range	0.05 - 1000 ppbC ( $\mu\text{gC/L}$ )
Accuracy	$\pm 0.1$ ppbC for TOC < 2.0 ppb (for water quality > 15 M $\Omega$ -cm [0.067 $\mu\text{S/cm}$ ]) $\pm 0.2$ ppbC for TOC > 2.0 ppb and < 10.0 ppb (for water quality > 15 M $\Omega$ -cm [0.067 $\mu\text{S/cm}$ ]) $\pm 5\%$ of measurement for TOC > 10.0 ppb (for water quality 0.5 to 18.2 M $\Omega$ -cm [2.0 to 0.055 $\mu\text{S/cm}$ ])
Repeatability	$\pm 0.05$ ppbC < 5 ppb, $\pm 1.0\%$ > 5 ppb
Resolution	0.001 ppbC ( $\mu\text{gC/L}$ )
Analysis Time	Continuous
Initial response time	< 60 seconds
Limit of Detection	0.025 ppbC

#### Conductivity Sensor

Conductivity Accuracy	$\pm 2\%$ , 0.02-20 $\mu\text{S/cm}$ ; Constant Sensor*
Cell Constant Accuracy	$\pm 2\%$
Temperature Sensor	Pt1000 RTD, Class A
Temperature Accuracy	$\pm 0.25^\circ\text{C}$

#### Sample Water Requirements

Temperature	0 to 100 $^\circ\text{C}$ **
Particle Size	<100 micron
Minimum Water Quality	$\geq 0.5$ M $\Omega$ -cm ( $\leq 2$ $\mu\text{S/cm}$ ), pH < 7.5 ***
Flow Rate	20 mL/min
Pressure	4 to 200 psig (0.3 bar(g)) to 13.6 bar(g)) at sample inlet connection ****

#### General Specifications

Case Dimensions	11" [280 mm] W x 7.4" [188 mm] H x 5.25" [133 mm] D
Weight	5.0 lb. (2.3 kg)
Enclosure material	Polycarbonate plastic, flame retardant, UV and chemical resistant UL # E75645, Vol. 1, Set 2, CSA #LR 49336
Enclosure rating	NEMA 4X, IP65 Industrial environment
Ambient Temperature/ Humidity rating	5 to 50 $^\circ\text{C}$ / 5 to 80% Humidity, non-condensing
Power requirements	100 - 130VAC or 200 - 240VAC, 50/60 Hz, 25W Maximum
Local Indicators	Four LED lights for Fault, Error, Sensor Status and UV Lamp ON
Ratings/Approvals	CE Compliant, UL and cUL (CSA Standards) listed, NEMA 4X, IP65, Conductivity and temperature sensors traceable to NIST, ASTM D1125 and D5391. Meets ASTM D5173 Standard Test Method for On-Line Monitoring of Carbon Compounds in Water by UV Light Oxidation

#### Sample Connections

Inlet connection	0.125" [3 mm] O.D. (6' [2 m] FDA compliant PTFE tubing supplied)
Outlet connection	Fixed stainless steel drain tube provided
Inlet Filter	316SS, inline 60 micron
Wetted parts	316SS/Quartz/PEEK/Titanium/PTFE/EPDM/FKM/FFKM
Wall Mount	Standard, mounting tabs provided
Pipe Mount	Optional, with pipe-mount bracket accessory for nominal pipe sizes 1" [2.5 cm]
Maximum Sensor Distance	300ft [91 m]

\* Readout in equivalent S/m ranges selectable at M300TOC

\*\* Temperature above 70 $^\circ\text{C}$  requires Sample Conditioning Coil (included)

\*\*\* For power plant cycle chemistry samples, pH may be adjusted by measurement after cation exchange.

\*\*\*\* Process pressure above 85 psig (5.9 barg) requires optional High Pressure Regulator p/n 58 091 552.

Specifications subject to change without notice.

## 18.2 M300 TOC

### 18.2.1 Electrical specifications for 1/2DIN and 1/4DIN versions

Power requirements	100 to 240 VAC or 20 to 30 VDC, 10 VA; AWG 14 < 2.5 mm <sup>2</sup>
Frequency	50 to 60 Hz
Analog output signals	2 0/4 to 22 mA outputs, galvanically isolated from input and from earth/ground
Measurement Error through analog outputs	< ±0.05 mA over 1 to 22 mA range, < ±0.1 mA over 0 to 1 mA range
Analog output configuration	Linear, Bi-Linear, Logarithmic, Autoranging
Load	Max. 500 Ω
Connection terminals	Detachable screw terminals
Update Rate	1 sec.
Connection terminals	Detachable screw terminals
Mains power fuse	1.0 A slow blow type FC
Relays	– 2-SPDT mechanical 250 VAC, 30 VDC, 3 Amps – 2-Reed 250 VAC or DC, 0.5 A, 10 W
Alarm Relay delay	0–999 s
Keypad	5 tactile feedback keys
Display	Backlit LCD, four-line



**NOTE:** This is a 4-wire-product with an active 4–20 mA analog output.  
Please do not supply power to Pin1–Pin6 of TB2.

### 18.2.2 Mechanical specifications for 1/4DIN version

Dimensions (housing – H x W x D)*	96 x 96 x 140 mm (1/4DIN model)
Front bezel – (H x W)	102 x 102 mm
Max. depth	125 mm (excludes plug-in connectors)
Weight	0.6 kg (1.5 lb)
Material	ABS/polycarbonate
Ingress rating	IP 65 (front)/IP 20 (housing)

\* H = Height, W = Width, D = Depth

### 18.2.3 Mechanical specifications for 1/2DIN version

Dimensions (housing – H x W x D)*	144 x 144 x 116 mm
Front bezel – H x W	150 x 150 mm
Max. D – panel mounted	87 mm (excludes plug-in connectors)
Weight	0.95 kg (2 lb)
Material	ABS/polycarbonate
Ingress rating	IP 65 (when back cover is attached)

\* H = Height, W = Width, D = Depth

## 18.2.4 Environmental specifications for 1/2DIN and 1/4DIN versions

Storage temperature	–40 to 70 °C (–40 to 158 °F)
Ambient temperature operating range	–10 to 50 °C (14 to 122 °F)
Relative humidity	0 to 95% non-condensing
Emissions	According to EN55011 Class A
UL Electrical Environment	Installation (overvoltage) category II



## 19 Default tables

### 19.1 M300 TOC Default Settings

Parameter	Sub parameter	Value	Unit
Alarm	Relay	2	
	Power Failure	No	
	Software Failure	Yes	
	Disconnect ChA	No	
	TOC Faults	No	
	TOC Errors	No	
	Lamp Off	No	
	Language		English
Passwords	Administrator	00000	
	Operator	00000	
Relays	Delay Relay 1	0	Sec
	Delay Relay 2	1	Sec
	Delay Relay 3	10	Sec
	Delay Relay 4	10	Sec
	Hysteresis Relay 1	0	%
	Hysteresis Relay 2	0	%
	Hysteresis Relay 3	5	%
	Hysteresis Relay 4	5	%
	State Relay 1	Normal	
	State Relay 2	Inverted	
	State Relay 3	Normal	
	State Relay 4	Normal	
	Hold Mode*	Last	
Lockout	Yes/No	No	
Display	Line 1	a	ppbC
	Line 2	b	S/cm
	Line 3	none	
	Line 4	none	
Analog Out	1	a	
	2	b	
All analog out	Mode	4–20 mA	
	Type	Normal	
	Alarm	Off	
	Hold Mode	Last Value	
Conductivity	Value 4 mA	0.1	μS/cm
	Value 20 mA	10	μS/cm
TOC	Value 4 mA	0	ppb
	Value 20 mA	100	ppb
Set Point 1	Measurement	a	
	Type	Off	
TOC	High Value	40	ppb
	Low Value	0.000	ppb
Relay 3	Set point	1	

Parameter	Sub parameter	Value	Unit
Set Point 2	Measurement	b	
	Type	Off	
	High Value	0	
	Low Value	0	
Relay 4	Set Point	2	
Conductivity Resistivity	Compensation	Standard	

\* For analogue output signal if relay is switched

\*\* Not adjustable

*Italics = default values if resistivity instead of conductivity is chosen.*

## 19.2 4000TOCe Default Settings

Parameters	Sub Parameters	Value	Unit
Autobalance Parameters	Autobalance On / Off	Off	
	Autobalance Cycle Time	4500	Hours
	Autobalance Limit	15	%
	Rinse Time	15	Minutes
Lamp Parameters	Lamp Life Limit	4500	Hours
TOC General Parameters	AutoStart On / Off	Off	
	Sensor Keypad Lock Yes / No	No	
	Override Cond. Limit Yes / No	No	
	Conductivity Limit	2.0	µS/cm

## 20 Certificate

Mettler-Toledo Thornton, Inc., 900 Middlesex Turnpike, Building 8, Billerica, MA 01821, USA has obtained Underwriters Laboratories' listing for M300 Model Transmitters. They bear the cULus Listed mark, signifying that the products have been evaluated to the applicable ANSI/UL and CSA Standards for use in the U.S. and Canada



### Declaration of Conformity

We,  
Mettler-Toledo Thornton, Inc.  
900 Middlesex Turnpike, Building 8  
Billerica, MA 01821, USA  
Declare Under our sole responsibility that the product:

4000TOCe Sensor

to which this declaration relates, in conformity with the following European, harmonized and published standards at the date of this declaration:

EMC Emissions: EN 55011 Class A

EMC Emissions and Immunity: EN 61326-1 2013, Measurement Control and Laboratory equipment EMC requirements.

Safety: EN 61010-1: 2010

### UL LISTING

US UL61010-1 Third Edition Safety Requirements for Electrical Equipment for Measurement Control and Laboratory Use. Part 1: General Requirements

CAN/CSA CSA 22.2 No. 61010-1-12, Third Edition



## 21 Warranty

METTLER TOLEDO warrants this product to be free from significant deviations in material and workmanship for a period of one year from the date of purchase. If repair is necessary and not the result of abuse or misuse within the warranty period, please return by freight pre-paid and amendment will be made without any charge. METTLER TOLEDO's Customer Service Dept. will determine if the product problem is due to deviations or customer abuse. Out-of-warranty products will be repaired on an exchange basis at cost.

The above warranty is the only warranty made by METTLER TOLEDO and is lieu of all other warranties, expressed or implied, including, without limitation, implied warranties of merchantability and fitness for a particular purpose. METTLER TOLEDO shall not be liable for any loss, claim, expense or damage caused by, contributed to or arising out of the acts or omissions of the Buyer or Third Parties, whether negligent or otherwise. In no event shall METTLER TOLEDO's liability for any cause of action whatsoever exceed the cost of the item giving rise to the claim, whether based in contract, warranty, indemnity, or tort (including negligence).



- Brazil**      **Mettler-Toledo Ind. e Com. Ltda.**  
Avenida Tamboré, 418 – Tamboré,  
BR - 06460-000 Barueri / SP, Brazil  
Phone +55 11 4166 7400  
e-mail mtbr@mt.com
- France**      **Mettler-Toledo Analyse Industrielle S.A.S.**  
30, Bld. de Douaumont, FR-75017 Paris, France  
Phone +33 1 47 37 06 00  
e-mail mtpro-f@mt.com
- Germany**      **Mettler-Toledo GmbH**  
Prozeßanalytik, Ockerweg 3, DE -35396 Gießen  
Phone +49 641 507-444  
e-mail prozess@mt.com
- Switzerland**      **Mettler-Toledo (Schweiz) GmbH**  
Im Langacher, CH-8606 Greifensee  
Phone +41 44 944 47 60  
e-mail ProSupport.ch@mt.com
- United States**      **Mettler-Toledo**  
Process Analytics  
900 Middlesex Turnpike, Bld. 8, Billerica, MA 01821, USA  
Phone +1 781 301 8800  
Freephone +1 800 352 8763  
e-mail mtprous@mt.com

For more addresses of METTLER TOLEDO Market Organizations please go to:  
[www.mt.com/pro-MOs](http://www.mt.com/pro-MOs)



Management System  
certified according to  
ISO 9001 / ISO 14001

**Mettler-Toledo Thornton, Inc.**  
900 Middlesex Turnpike, Bldg. 8  
Billerica MA, 01821  
Tel. +1-781-301-8600  
Fax +1-781-271-0214

Subject to technical changes.  
© Mettler-Toledo Thornton, Inc.  
08/2017 Printed in USA. 30 415 924 Rev A

[www.mt.com/pro](http://www.mt.com/pro)