



© It is forbidden to reprint this instruction manual in whole or part.

No part of this manual may be reproduced in any form, or modified, copied or distributed using electronic systems, in particular in the form of photocopies, photographs, magnetic or other recordings, without written consent of Mettler-Toledo GmbH, Process Analytics, CH-8902 Urdorf, Switzerland.

All rights reserved, in particular reproduction, translation and patenting/registration.

ISM is a trademark of the METTLER TOLEDO Group.

# **Operation Manual Multi-Parameter Transmitter M400 FF**

## Content

<b>1</b>	<b>Introduction</b>	<b>9</b>
<b>2</b>	<b>Safety Instructions</b>	<b>10</b>
2.1	Definition of Equipment and Documentation Symbols and Designations	10
2.2	Environmental protection	11
2.3	Ex Instructions for M400 Series Multi-Parameter Transmitters – ATEX/IECEX/UKCA	12
2.4	Ex instructions for M400 Series Multi-Parameter Transmitters – FM Approval	14
2.4.1	Instructions of Use to Be Considered under FM Approval	14
2.4.1.1	General Notes	16
2.4.1.2	Cautionary Notes, Warnings and Markings	16
2.4.1.3	Control Drawings	18
<b>3</b>	<b>Unit Overview</b>	<b>19</b>
3.1	Overview ½ DIN	19
3.2	Control/Navigation Keys	20
3.2.1	Menu Structure	20
3.2.2	Navigation Keys	20
3.2.2.1	Navigating the Menu Tree	20
3.2.2.2	Escape	21
3.2.2.3	ENTER	21
3.2.2.4	Menu	21
3.2.2.5	Calibration Mode	21
3.2.2.6	Info Mode	21
3.2.3	Navigation of Data Entry Fields	21
3.2.4	Entry of Data Values, Selection of Data Entry Options	21
3.2.5	Navigation with ↑ in Display	22
3.2.6	“Save Changes” Dialog	22
3.2.7	Security Passwords	22
3.2.8	Display	22
<b>4</b>	<b>Installation Instruction</b>	<b>23</b>
4.1	Unpacking and Inspection of Equipment	23
4.1.1	Panel Cutout Dimensional Information – ½ DIN Models	23
4.1.2	Installation Procedure	24
4.1.3	Assembly – ½ DIN Version	24
4.1.4	½ DIN Version – Dimension Drawings	25
4.1.5	½ DIN Version – Pipe Mounting	25
4.2	Connection of Power Supply	26
4.2.1	Housing (Wall Mount)	26
4.3	Connector PIN Definition	27
4.3.1	Terminal Block (TB) Definitions	27
4.3.2	TB2 – Conductivity 4-e/2-e Analog Sensors	28
4.3.3	TB2 – pH/ORP Analog Sensors	28
4.3.4	TB2 – Oxygen Analog Sensors	29
4.3.5	TB2 – pH, Amp. Oxygen, Conductivity 4-e and Dissolved CO <sub>2</sub> (Low) ISM (Digital) Sensors	29
4.3.6	TB2 – Optical Oxygen, ISM (Digital) Sensors	30
4.3.6.1	With VP8 Cable	30
4.3.6.2	With other Cables	30
4.4	Connection of ISM (Digital) Sensors	31
4.4.1	Connection of ISM Sensors for pH/ORP, Cond 4-e, Amp. Oxygen Measurement and Dissolved CO <sub>2</sub> (Low)	31
4.4.2	TB2 – AK9 Cable Assignment	31
4.4.3	Connection of ISM Sensors for Optical Oxygen Measurement	32
4.5	Connection of Analog Sensors	33
4.5.1	Connection of Analog Sensor for pH/ORP	33
4.5.2	TB2 – Typical Wiring for Analog pH/ORP Sensor	34
4.5.2.1	Example 1	34
4.5.2.2	Example 2	35
4.5.2.3	Example 3	36
4.5.2.4	Example 4	37
4.5.3	Connection of Analog Sensor for Amperometric Oxygen Measurement	38
4.5.4	TB2 – Typical Wiring for Analog Sensor for Amperometric Oxygen Measurement	39
<b>5</b>	<b>Placing Transmitter In, or Out, of Service</b>	<b>40</b>
5.1	Placing Transmitter in Service	40
5.2	Placing Transmitter out of Service	40

<b>6</b>	<b>Quick Setup</b>	<b>41</b>
<b>7</b>	<b>Sensor Calibration</b>	<b>42</b>
7.1	Enter Calibration Mode	42
7.2	Conductivity Calibration for Two- or Four-Electrode Sensors	43
7.2.1	One-Point Sensor Calibration	44
7.2.2	Two-Point Sensor Calibration (Only for Four-Electrode Sensors)	45
7.2.3	Process Calibration	45
7.3	Calibration of Amperometric Oxygen Sensors	46
7.3.1	One-Point Calibration for Amperometric Oxygen Sensors	46
7.3.1.1	Auto Mode	47
7.3.1.2	Manual Mode	47
7.3.2	Process Calibration for Amperometric Oxygen Sensors	48
7.4	Calibration of Optical Oxygen Sensors (Only for ISM Sensors)	49
7.4.1	One-Point Calibration for Optical Oxygen Sensors	49
7.4.1.1	Auto mode	49
7.4.1.2	Manual Mode	50
7.4.2	Two-Point Sensor Calibration	50
7.4.2.1	Auto Mode	51
7.4.2.2	Manual Mode	51
7.4.3	Process Calibration	52
7.5	pH Calibration	53
7.5.1	One-Point Calibration	53
7.5.1.1	Auto Mode	53
7.5.1.2	Manual Mode	54
7.5.2	Two-Point Calibration	54
7.5.2.1	Auto Mode	54
7.5.2.2	Manual Mode	55
7.5.3	Process Calibration	55
7.5.4	mV Calibration (Only for Analog Sensors)	56
7.5.5	ORP Calibration (Only for ISM Sensors)	57
7.6	Dissolved Carbon Dioxide Calibration	57
7.6.1	One-Point Calibration	57
7.6.1.1	Auto Mode	58
7.6.1.2	Manual Mode	58
7.6.2	Two-Point Calibration	58
7.6.2.1	Auto Mode	59
7.6.2.2	Manual Mode	59
7.6.3	Process Calibration	60
7.7	Sensor Temperature Calibration (Only for Analog Sensors)	61
7.7.1	One-Point Sensor Temperature Calibration	61
7.7.2	Two-Point Sensor Temperature Calibration	61
7.8	Edit Sensor Calibration Constants (Only for Analog Sensors)	62
7.9	Sensor Verification	62
<b>8</b>	<b>Configuration</b>	<b>63</b>
8.1	Enter Configuration Mode	63
8.2	Measurement	63
8.2.1	Channel Setup	63
8.2.1.1	Analog Sensor	64
8.2.1.2	ISM Sensor	64
8.2.1.3	Save Changes of the Channel Setup	64
8.2.2	Temperature Source (Only for Analog Sensors)	65
8.2.3	Parameter Related Settings	65
8.2.3.1	Conductivity Temperature Compensation	66
8.2.3.2	Concentration Table	67
8.2.3.3	pH/ORP Parameters	68
8.2.3.4	Parameters for Oxygen Measurement Based on Amperometric Sensors	69
8.2.3.5	Parameters for Oxygen Measurement Based on Optical Sensors	71
8.2.3.6	Adjusting Sampling Rate for Optical Sensors	72
8.2.3.7	LED Mode	72
8.2.3.8	Dissolved Carbon Dioxide Parameters	73
8.2.4	Self Averaging	74
8.3	Alarm/Clean	74
8.3.1	Alarm	74
8.3.2	Clean	76

8.4	ISM Set Up (Available for pH, Oxygen and Dissolved Carbon Dioxid ISM Sensors)	77
8.4.1	Sensor Monitoring	77
8.4.2	CIP Cycle Limit	79
8.4.3	SIP Cycle Limit	79
8.4.4	Autoclaving Cycle Limit	80
8.4.5	Reset ISM Counter/Timer	81
8.4.6	DLI Stress Adjustment (Only for pH ISM Sensors)	81
8.5	Display	82
8.5.1	Measurement	82
8.5.2	Resolution	82
8.5.3	Backlight	83
8.5.4	Name	83
8.5.5	ISM Sensor Monitoring (Available when ISM Sensor Connected)	83
8.6	Hold Outputs	84
<b>9</b>	<b>System</b>	<b>85</b>
9.1	Set Language	85
9.2	Passwords	85
9.2.1	Changing Passwords	86
9.2.2	Configuring Menu Access for Operator	86
9.3	Set/Clear Lockout	86
9.4	Reset	87
9.4.1	Reset System	87
9.4.2	Reset Meter Calibration	87
9.5	Set Date & Time	87
<b>10</b>	<b>Service</b>	<b>88</b>
10.1	Diagnostics	88
10.1.1	Model/Software Revision	88
10.1.2	Display	88
10.1.3	Keypad	89
10.1.4	Memory	89
10.1.5	Read Analog Inputs	89
10.1.6	O <sub>2</sub> Optical	89
10.2	Calibrate	90
10.2.1	Calibrate Meter (Only for Channel A)	90
10.2.1.1	Resistance	90
10.2.1.2	Temperature	91
10.2.1.3	Current	92
10.2.1.4	Voltage	93
10.2.1.5	Rg Diagnostic	93
10.2.1.6	Rr Diagnostic	94
10.2.1.7	Calibrate Analog Input Signal	94
10.2.2	Calibrate Unlock	95
10.3	Tech Service	95
<b>11</b>	<b>Info</b>	<b>96</b>
11.1	Messages	96
11.2	Calibration Data	96
11.3	Model/Software Revision	97
11.4	ISM Sensor Info (Available when ISM Sensor Connected)	97
11.5	ISM Sensor Diagnostics (Available when ISM Sensor Connected)	97
<b>12</b>	<b>FOUNDATION Fieldbus Interface</b>	<b>100</b>
12.1	General	100
12.1.1	System Architecture	100
12.2	M400 FF Block Model	101
12.2.1	Block Configuration	102
12.3	Commissioning	103
12.3.1	Network Configuration	103
12.3.2	Identification and Addressing	103
12.3.3	Commissioning via an FF Configuration Program	104
12.3.4	Scaling the OUT Parameter	106
<b>13</b>	<b>Maintenance</b>	<b>107</b>
13.1	Front Panel Cleaning	107

<b>14</b>	<b>Troubleshooting</b>	<b>108</b>
14.1	Cond (Resistive) Error Messages/Warning- and Alarm List for Analog Sensors	108
14.2	Cond (Resistive) Error Messages/Warning- and Alarm List for ISM Sensors	109
14.3	pH Error Messages/Warning- and Alarm List	109
14.3.1	pH Sensors Except Dual Membrane pH Electrodes	109
14.3.2	Dual Membrane pH Electrodes (pH/pNa)	110
14.3.3	ORP Messages	110
14.4	Amperometric O <sub>2</sub> Error Messages/Warning- and Alarm List	111
14.4.1	High Level Oxygen Sensors	111
14.4.2	Low Level Oxygen Sensors	111
14.4.3	Trace Oxygen Sensors	112
14.5	Optical O <sub>2</sub> Error Messages/Warning- and Alarm List	112
14.6	Dissolved Carbon Dioxide Error Messages/Warning- and Alarm List	113
14.7	Warning- and Alarm Indication on the Display	114
14.7.1	Warning Indication	114
14.7.2	Alarm Indication	114
<b>15</b>	<b>Accessories and Spare Parts</b>	<b>115</b>
<b>16</b>	<b>Specifications</b>	<b>116</b>
16.1	General Specifications	116
16.2	Electrical Specifications	120
16.3	FOUNDATION Fieldbus Specifications	120
16.4	Mechanical Specification	121
16.5	Environmental Specifications	121
16.6	Control Drawings	122
16.6.1	Installation, Maintenance and Inspection	122
16.6.2	Control Installation Drawing General Installation	123
16.6.3	Notes	126
<b>17</b>	<b>Default Table</b>	<b>127</b>
<b>18</b>	<b>Warranty</b>	<b>131</b>
<b>19</b>	<b>Buffer Tables</b>	<b>132</b>
19.1	Standard pH Buffers	132
19.1.1	Mettler-9	132
19.1.2	Mettler-10	133
19.1.3	NIST Technical Buffers	133
19.1.4	NIST Standard Buffers (DIN and JIS 19266: 2000-01)	134
19.1.5	Hach Buffers	134
19.1.6	Ciba (94) Buffers	135
19.1.7	Merck Titrisole, Riedel-de-Haën Fixanale	135
19.1.8	WTW Buffers	136
19.1.9	JIS Z 8802 Buffers	136
19.2	Dual Membrane pH Electrode Buffers	137
19.2.1	Mettler-pH/pNa Buffers (Na+ 3.9M)	137





# 1 Introduction

Statement of Intended Use – The 2-wire M400 multi-parameter transmitter is a single- channel online process instrument with FOUNDATION fieldbus™ communication capabilities for measuring various properties of fluids and gases. These include Conductivity, Oxygen. The parameters are indicated on the label on the back of the system.

The M400 is a unique mixed mode transmitter who can handle conventional sensors (analog) or ISM™ sensors (digital).

## M400 FF parameter fit guide

Parameter	M400 FF	
	Analog	ISM
pH/ORP	•	•
Conductivity 2-e	•	–
Conductivity 4-e	•	•
Amp. DO ppm/ppb/trace	•/•/•	•/•/•
Amp. O <sub>2</sub>	•	•
Optical Oxygen ppm/ppb	–	•/•
Dissolved Carbon Dioxide (low)	–	•

A large four line backlit Liquid Crystal Display conveys measuring data and setup information. The menu structure allows the operator to modify all operational parameters by using keys on the front panel. A menu-lockout feature, with password protection, is available to prevent the unauthorized use of the meter. Via the FF interface the Analog Output Block, Discrete Input Block and Discrete Output Block can be configured for Alarm/Clean status, Hold status and pressure compensation.

This description corresponds to the firmware release, version 1.0.02 for transmitter M400 FF. Changes are taking place constantly, without prior notification.

## 2 Safety Instructions

This manual includes safety information with the following designations and formats.

### 2.1 Definition of Equipment and Documentation Symbols and Designations



**WARNING:** POTENTIAL FOR PERSONAL INJURY.



**CAUTION:** possible instrument damage or malfunction.



**NOTE:** Important operating information.



On the transmitter or in this manual text indicates: Caution and/or other possible hazard including risk of electric shock (refer to accompanying documents)

The following is a list of general safety instructions and warnings. Failure to adhere to these instructions can result in damage to the equipment and/or personal injury to the operator.

- The M400 Transmitter should be installed and operated only by personnel familiar with the transmitter and who are qualified for such work.
- The M400 Transmitter must only be operated under the specified operating conditions (see section 16 "Specifications").
- Repair of the M400 Transmitter must be performed by authorized, trained personnel only.
- With the exception of routine maintenance, cleaning procedures or fuse replacement, as described in this manual, the M400 Transmitter must not be tampered with or altered in any manner.
- METTLER TOLEDO accepts no responsibility for damage caused by unauthorized modifications to the transmitter.
- Follow all warnings, cautions, and instructions indicated on and supplied with this product.
- Install equipment as specified in this instruction manual. Follow appropriate local and national codes.
- Protective covers must be in place at all times during normal operation.
- If this equipment is used in a manner not specified by the manufacturer, the protection provided by it against hazards may be impaired.



#### **WARNINGS:**

Installation of cable connections and servicing of this product require access to shock hazard voltage levels.

Main power wired to separate power source must be disconnected before servicing.

Switch or circuit breaker shall be in close proximity to the equipment and within easy reach of the OPERATOR; it shall be marked as the disconnecting device for the equipment. Main power must employ a switch or circuit breaker as the disconnecting device for the equipment.

Electrical installation must be in accordance with the National Electrical Code and/or any other applicable national or local codes.



**NOTE: PROCESS UPSETS** Because process and safety conditions may depend on consistent operation of this transmitter, provide appropriate means to maintain operation during sensor cleaning, replacement or sensor or instrument calibration.

## 2.2 Environmental protection

Waste electrical products should not be disposed of with household waste. Please recycle where facilities exist. Check with your Local Authority or retailer for recycling advice.



## 2.3 Ex Instructions for M400 Series Multi-Parameter Transmitters – ATEX/IECEX/UKCA

M400 series multi-parameter transmitters are produced by Mettler-Toledo GmbH. It has passed the inspection of IECEX and conforms to following standards:

- **IEC 60079-0 : 2017**  
**Edition: 7.0 Explosive atmospheres –**  
**Part 0: General requirements**
- **IEC 60079-11 : 2011**  
**Edition: 6.0 Explosive atmospheres –**  
**Part 11: Equipment protection by intrinsic safety “i”**

### Ex Marking:

- **Ex ib [ia Ga] IIC T4 Gb**
- **Ex ib [ia Da] IIIC T80 °C Db IP66**

### Certificate No.:

- **IECEX NEP 18.0007X**
- **SEV 12 ATEX 0132X**
- **CML 22 UKEX 2209X**

### 1. Special Conditions of use (X-marking in the Certificate Number):

1. Avoid ignition hazard due to impact or friction, prevent mechanical sparks.
2. Avoid electrostatic discharge on enclosure surface, use wet cloth only for cleaning.
3. In hazardous area, IP66 cable glands (as supplied ) must be mounted.

### 2. Pay particular attention to the following when using the transmitter:

1. Rated ambient temperature range:
  - for gas atmosphere: –20 ~ +60 °C
  - for dust atmosphere: –20 ~ +57 °C
2. No operation on the upgrade interface in hazardous area.
3. Users shall not arbitrarily replace the internal electrical components.
4. When installation, use and maintenance, IEC 60079-14 should be observed.
5. When installation in explosive dust atmosphere
  - 5.1 Cable gland or blanking plug to IEC 60079-0:2017 and IEC 60079-11: 2011 with marking Ex ia IIIC IP66 should be adopted.
  - 5.2 The overlay switch of multi-parameter transmitter shall be protected from light.
  - 5.3 Avoid high risk of mechanical danger on the overlay switch.
6. Observe the warning: potential electrostatic charging hazard- see instructions, avoid ignition hazard due to impact or friction for Ga application.
7. For connection to intrinsically safe circuits, use the maximum values in the following table.

Terminal	Function	Safety Parameters				
10, 11	Power (FF) FISCO field device	$U_i = 17.5 \text{ V}$	$I_i = 380 \text{ mA}$	$P_i = 5.32 \text{ W}$	$L_i = 0$	$C_i = 3 \text{ nF}$
	Linear power	$U_i = 24 \text{ V}$	$I_i = 200 \text{ mA}$	$P_i = 1.2 \text{ W}$	$L_i = 0$	$C_i = 3 \text{ nF}$
P, Q	Analog input	$U_i = 24 \text{ V}$	$I_i = 100 \text{ mA}$	$P_i = 0.8 \text{ W}$	$L_i = 0$	$C_i = 15 \text{ nF}$
N, O	RS485 sensor	$U_o = 5.88 \text{ V}$ $U_i = 24 \text{ V}$	$I_o = 54 \text{ mA}$ $I_i = 100 \text{ mA}$	$P_o = 79 \text{ mW}$ $P_i = 0.8 \text{ W}$	$L_o = 1 \text{ mH}$ $L_i = 0$	$C_o = 1.9 \text{ }\mu\text{F}$ $C_i = 0.7 \text{ }\mu\text{F}$
L, M	One-wire sensor	$U_o = 5.88 \text{ V}$	$I_o = 22 \text{ mA}$	$P_o = 32 \text{ mW}$	$L_o = 1 \text{ mH}$	$C_o = 2.8 \text{ }\mu\text{F}$
I, J, K	Temperature sensor	$U_o = 5.88 \text{ V}$	$I_o = 5.4 \text{ mA}$	$P_o = 8 \text{ mW}$	$L_o = 5 \text{ mH}$	$C_o = 2 \text{ }\mu\text{F}$
B, C, D, H	Dissolved oxygen sensor	$U_o = 5.88 \text{ V}$	$I_o = 29 \text{ mA}$	$P_o = 43 \text{ mW}$	$L_o = 1 \text{ mH}$	$C_o = 2.5 \text{ }\mu\text{F}$
A, B, E, G	Conductivity sensor	$U_o = 5.88 \text{ V}$	$I_o = 29 \text{ mA}$	$P_o = 43 \text{ mW}$	$L_o = 1 \text{ mH}$	$C_o = 2.5 \text{ }\mu\text{F}$
A, E, G	pH sensor	$U_o = 5.88 \text{ V}$	$I_o = 1.3 \text{ mA}$	$P_o = 1.9 \text{ mW}$	$L_o = 5 \text{ mH}$	$C_o = 2.1 \text{ }\mu\text{F}$

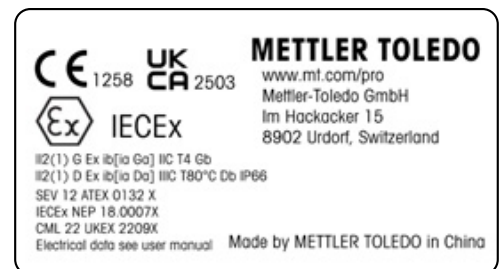
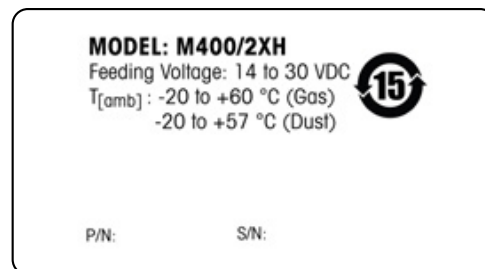

Label M400 FF.

## 2.4 Ex instructions for M400 Series Multi-Parameter Transmitters – FM Approval

### 2.4.1 Instructions of Use to Be Considered under FM Approval



M400 series multi-parameter transmitters are produced by Mettler-Toledo GmbH.

It has passed the inspection of NRTL cFMus and to following requirements.

The equipment is provided with an internal bond wiring and an internal flying lead wire for grounding purposes.

<b>US marking</b>	
Operating temperature range	–20 °C to +60 °C (–4 °F to +140 °F)
Environmental designation	Enclosure type 4X, IP 66
Intrinsically safe	– Class I, Division 1, Groups A, B, C, D T4A – Class II, Division 1, Groups E, F, G – Class III
Intrinsically safe	Class I, Zone 0, AEx ia IIC T4 Ga
Parameters	– Entity: Control drawing 12112601 and 12112602 – FISCO: Control drawing 12112603 and 12112602
Nonincendive	– Class I, Division 2, Groups A, B, C, D T4A – Class I, Zone 2, Groups IIC T4
Certificate no.	3046275
Standards	– FM3810:2005 Approval Standard for Electrical Equipment for Measurement, Control and Laboratory Use – ANSI/IEC-60529:2004 Degrees of Protection Provided by Enclosures (IP Codes) – ANSI/ISA-61010-1:2004 Edition: 3.0 Safety Requirements for Electrical Equipment for Measurement, Control, and Laboratory Use – Part 1: General Requirements – ANSI/NEMA 250:1991 Enclosures for Electrical Equipment (1,000 Volts Maximum) – FM3600:2011 Approval Standard for Electrical Equipment for Use in Hazardous (Classified) Locations – General Requirements – FM3610:2010 Approval Standard for Intrinsically Safe Apparatus and Associated Apparatus for Use in Class I, II & III, Division 1, Hazardous (Classified) Locations – FM3611:2004 Approval Standard for Nonincendive Electrical Equipment for Use in Class I & II, Division 2, and Class III, Division 1 & 2, Hazardous (Classified) Locations – ANSI/ISA-60079-0:2013 Edition: 6.0 Explosive Atmospheres – Part 0: General Requirements – ANSI/ISA-60079-11:2012 Edition: 6.0 Explosive Atmospheres – Part 11: Equipment Protection by Intrinsic Safety “i”

<b>Canadian marking</b>	
Operating temperature range	-20 °C to +60 °C (-4 °F to +140 °F)
Environmental designation	Enclosure type 4X, IP 66
Intrinsically safe	<ul style="list-style-type: none"> <li>- Class I, Division 1, Groups A, B, C, D T4A</li> <li>- Class II, Division 1, Groups E, F, G</li> <li>- Class III</li> </ul>
Intrinsically safe	Class I, Zone 0, Ex ia IIC T4 Ga
Parameters	<ul style="list-style-type: none"> <li>- Entity: Control drawing 12112601 and 12112602</li> <li>- FISCO: Control drawing 12112603 and 12112602</li> </ul>
Nonincendive	Class I, Division 2, Groups A, B, C, D T4A
Certificate no.	3046275
Standards	<ul style="list-style-type: none"> <li>- CAN/CSA-C22.2 No. 60529:2010 Degrees of Protection Provided by Enclosures (IP Codes)</li> <li>- CAN/CSA-C22.2 No. 61010-1:2004 Edition: 3.0 Safety Requirements for Electrical Equipment for Measurement, Control, and Laboratory Use – Part 1: General Requirements</li> <li>- CAN/CSA-C22.2 No. 94:1976 Special Purpose Enclosures – Industrial Products</li> <li>- CAN/CSA-C22.2 No. 213-M1987:2013 Non-Incendive Equipment for Use in Class I, Division 2 Hazardous Locations – Industrial Products</li> <li>- CAN/CSA-C22.2 No. 60079-0:2011 Edition: 2.0 Explosive Atmospheres – Part 0: General Requirements</li> <li>- CAN/CSA-C22.2 No. 60079-11:2014 Edition: 2.0 Explosive Atmospheres – Part 11: Equipment Protection by Intrinsic Safety "i"</li> </ul>

### 2.4.1.1 General Notes

The Multi-parameter Transmitter M400/2(X)H, M400G/2XH, M400FF, M400PA are suitable for use in hazardous atmospheres of all combustible materials of explosion groups A, B, C, D, E, F and G for applications requiring Class I, II, III, Division 1 instruments and groups A, B, C and D for applications requiring Class I, Division 2 instruments (National Electrical Code® (ANSI/NFPA 70 (NEC®), Article 500; or Canadian Electrical (CE) Code® (CEC Part 1, CAN/CSA-C22.1), Appendix F when installed in Canada), or of explosion groups IIC, IIB or IIA for applications requiring Class I, Zone O, AEx/Ex ia IIC T4, Ga instruments (National Electrical Code® (ANSI/NFPA 70 (NEC®), Article 500; or Canadian Electrical (CE) Code® (CEC Part 1, CAN/CSA-C22.1), Appendix F when installed in Canada).

If the Multi-parameter Transmitter M400/2(X)H, M400G/2XH, M400FF, M400PA is installed and operated in hazardous areas, the general Ex installation regulations as well as these safety instructions must be observed.

The operating instructions as well as the installation regulations and standards that apply for explosion protection of electrical systems must always be observed.

The installation of explosion-endangered systems must always be carried out by qualified personnel.

For mounting instructions on specific valves refer to the mounting instructions supplied with the mounting kit. Mounting does not affect the suitability of the SVI FF positioner for use in a potentially hazardous environment.

The equipment is not intended to be used as personal protective equipment. To prevent injury, read the manual before use.

For language translation assistance contact your local representative or email [process.service@mt.com](mailto:process.service@mt.com).

### 2.4.1.2 Cautionary Notes, Warnings and Markings

#### Hazardous location notes:

1. For guidance on US installations, see ANSI/ISA-RP12.06.01, Installation of Intrinsically Safe Systems for Hazardous (Classified) Locations.
2. Installations in the US shall comply with the relevant requirements of the National Electrical Code® (ANSI/NFPA 70 (NEC®)).
3. Installations in Canada shall comply with the relevant requirements of the Canadian Electrical (CE) Code® (CEC Part 1, CAN/CSA-C22.1).
4. Wiring methods must conform to all local and national codes governing the installation, and wiring must be rated for at least +10 °C above the highest expected ambient temperature.
5. Where the protection type allows and depends on wiring glands, the glands must be certified for the type of protection required and area classification identified on the equipment or system nameplate.
6. The internal grounding terminal shall be used as the primary equipment grounding means and the external grounding terminal is only for a supplemental (secondary) bonding connection where local authorities permit or require such a connection.
7. A dust-tight conduit seal shall be used when installed in Class II conductive and non-conductive dust environments and Class III combustible flying environments.



8. Approved seals against ingress of water or dust are required and the NPT or metric thread fittings must be sealed with tape or thread sealant in order to meet the highest level of ingress protection.
9. When the equipment is supplied with plastic dust plugs in the conduit/cable gland entries; it is the end-user's responsibility to provide cable glands, adaptors and/or blanking plugs suitable for the environment in which the equipment is installed. When installed in a hazardous (classified) location, the cable glands, adaptors and/or blanking plugs shall additionally be suitable for the hazardous (classified) location, the product certification, and acceptable to the local authority having jurisdiction for the installation.
10. The end-user must consult the manufacturer for repair disclaimers, and only certified parts, such as entry plugs, mounting and cover lock screws and gaskets, supplied by the manufacturer are permitted. No substitutions with non-manufacturer supplied parts are permitted.
11. Tighten cover screws to 1.8 Nm (15.8 lb-in.). Overtorquing may cause enclosure breakage.
12. The minimum tightening torque for M4 (No. 6) binding screw protective conductor terminals is 1.2 Nm (10.6 lb-in.) or greater, as specified.
13. Care must be taken during installation to avoid impacts or friction that could create an ignition source.
14. Use copper, copper-clad aluminum or aluminum conductors only.
15. The recommended tightening torque for field wiring terminals is 0.8 Nm (7 lb-in.) or greater, as specified.
16. The Nonincendive version of the Multi-parameter Transmitter M400/2H must be connected to limited output NEC Class 2 circuits, as outlined in the National Electrical Code® (ANSI/NFPA 70 (NEC®)), only. If the devices are connected to a redundant power supply (two separate power supplies), both must meet this requirement.
17. The Class I, Zone 2 certifications are based on Division evaluations and the marking acceptance of Article 505 of the National Electrical Code® (ANSI/NFPA 70 (NEC®)).
18. The Multi-parameter Transmitter M400/2(X)H, M400G/2XH, M400FF, M400PA assessed were certified by FM Approvals under a Type 3 Certification System as identified in ISO Guide 67.
19. Tampering and replacement with non-factory components may adversely affect the safe use of the system.
20. Insertion or withdrawal of removable electrical connectors is to be accomplished only when the area is known to be free of flammable vapors.
21. The Multi-parameter Transmitter M400/2(X)H, M400G/2XH, M400FF, M400PA is not intended for servicing or maintenance operation. Malfunctioning units operating out of manufacturer's specification should be discarded and replaced with a new operational unit.
22. Substitution of components may impair intrinsic safety.
23. Do not open when an explosive atmosphere is present.
24. Explosion hazard, do not disconnect while circuit is live unless area is known to be non-hazardous.
25. Explosion hazard, substitution of components may impair suitability for Class I, Division 2.

The Multi-parameter Transmitter M400 FF, M400 PA intrinsically safe apparatus, entity/fieldbus intrinsically safe concept version, bears the following label marking:



Label Model M400 FF

### 2.4.1.3 Control Drawings

Refer to section „16.6 Control Drawings“ on Page 122.

### 3 Unit Overview

The M400 models are available in ½ DIN case size. The M400 models provide an integral IP66/NEMA4X housing for wall- or pipe mount.

#### 3.1 Overview ½ DIN

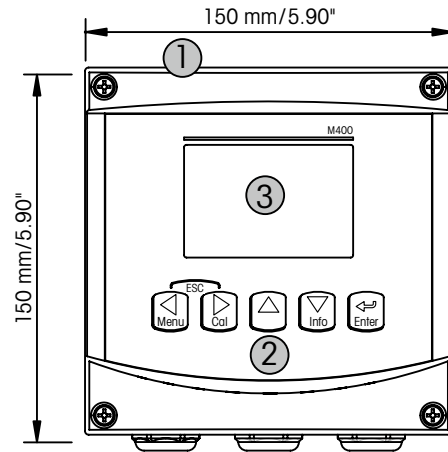

- 1: Hard Polycarbonate Case
- 2: Five Tactile-Feedback Navigation Keys
- 3: Four-line LCD Display

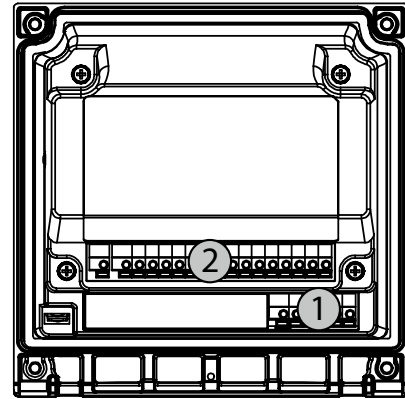

- 1: TB1 – FF-H1
- 2: TB2 – Sensor Signal

## 3.2 Control/Navigation Keys

### 3.2.1 Menu Structure

Below is the structure of the M400 menu tree:

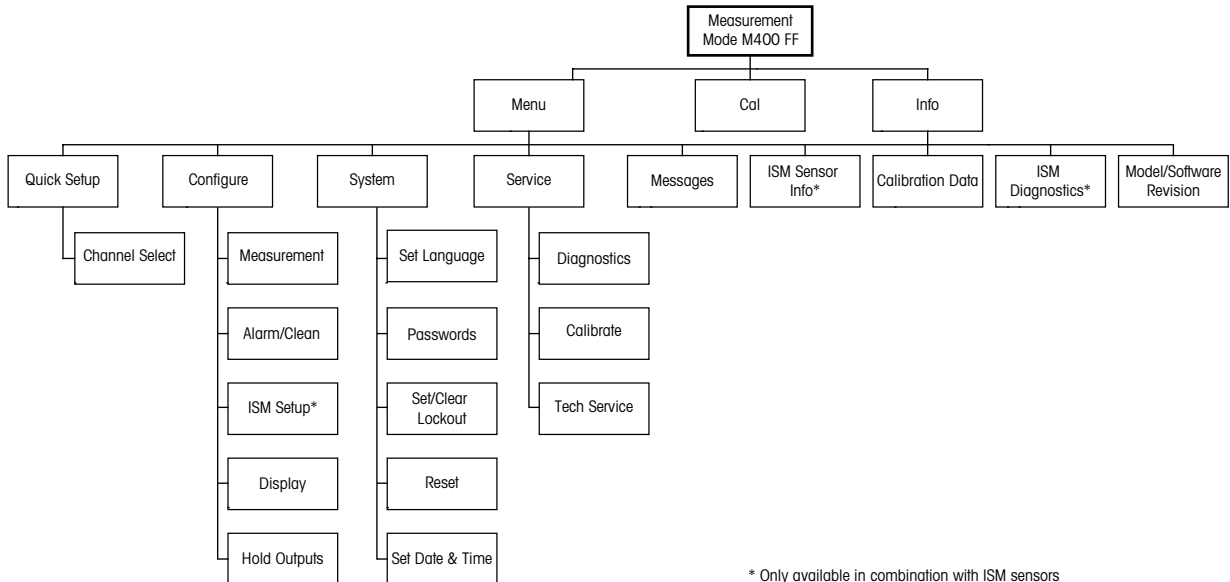

### 3.2.2 Navigation Keys

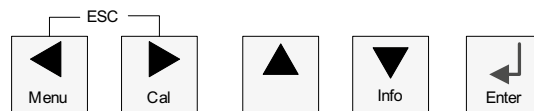

#### 3.2.2.1 Navigating the Menu Tree

Enter the desired main Menu branch with the ◀▶ or ▲ keys. Use the ▲ and ▼ keys to navigate through the selected Menu branch.



**NOTE:** In order to back up one menu page, without escaping to the measurement mode, move the cursor under the UP Arrow character (↑) at the bottom right of the display screen and press [ENTER].

### 3.2.2.2 Escape

Press the ◀ and ▶ key simultaneously (escape) to return to the Measurement mode.

### 3.2.2.3 ENTER

Use the ↵ key to confirm action or selections.

### 3.2.2.4 Menu

Press the ◀ key to access the main Menu.

### 3.2.2.5 Calibration Mode

Press the ▶ key to enter Calibration mode.

### 3.2.2.6 Info Mode

Press the ▼ key to enter Info mode.

## 3.2.3 Navigation of Data Entry Fields

Use the ▶ key to navigate forward or the ◀ key to navigate backwards within the changeable data entry fields of the display.

## 3.2.4 Entry of Data Values, Selection of Data Entry Options

Use the ▲ key to increase or the ▼ key to decrease a digit. Use the same keys to navigate within a selection of values or options of a data entry field.



**NOTE:** Some screens require configuring multiple values via the same data field. Be sure to use the ▶ or ◀ key to return to the primary field and the ▲ or ▼ key to toggle between all configuration options before entering to the next display screen.

### 3.2.5 Navigation with ↑ in Display

If a ↑ is displayed on the bottom right hand corner of the display, you can use the ► or the ◀ key to navigate to it. If you click [ENTER] you will navigate backwards through the menu (go back one screen). This can be a very useful option to move back up the menu tree without having to exit into the measuring mode and re-enter the menu.

### 3.2.6 "Save Changes" Dialog

Three options are possible for the "Save changes" dialog: Yes & Exit (Save changes and exit to measuring mode), "Yes & ↑" (Save changes and go back one screen) and "No & Exit" (Don't save changes and exit to measuring mode). The "Yes & ↑" option is very useful if you want to continue configuring without having to re-enter the menu.

### 3.2.7 Security Passwords

The M400 transmitter allows a security lock-out of various menus. If the security lock-out feature of the transmitter has been enabled, a security password must be entered to allow access to the menu. See section 9.3 "Set/Clear Lockout" for more information.

### 3.2.8 Display



**NOTE:** In the event of an alarm or other error condition the M400 Transmitter will display a flashing  $\Delta$  a in the upper right corner of the display. This symbol will remain until the condition that caused it has been cleared.



**NOTE:** During calibrations (Channel A), clean, a flashing "H" (Hold) will appear in the upper left corner of the display. During calibration on Channel B, a flashing "H" (Hold) will appear in the second line. Change to B and flash. This symbol will remain for 20 sec., after end of calibration. This symbol will remain for 20 seconds until after the calibration or clean is completed. This symbol will also disappear when Digital In is deactivated.



**NOTE:** Channel A (A is shown on the left side of the display) indicates that a conventional sensor is connected to the transmitter.

Channel B (B is shown on the left side of the display) indicates, that an ISM Sensor is connected to the transmitter.

The M400 is a single input channel transmitter, and only one sensor can be connected at the same time.

## 4 Installation Instruction

### 4.1 Unpacking and Inspection of Equipment

Inspect the shipping container. If it is damaged, contact the shipper immediately for instructions. Do not discard the box.

If there is no apparent damage, unpack the container. Be sure all items shown on the packing list are present.

If items are missing, notify METTLER TOLEDO immediately.

#### 4.1.1 Panel Cutout Dimensional Information – ½ DIN Models

½ DIN Model transmitters are designed with an integral rear cover for stand-alone wall mount installation.

The unit may also be wall mounted using the integral rear cover. See installation instructions in section 4.1.2 "Installation Procedure".

Below are cut-out dimensions required by the ½ DIN models when mounted within a flat panel or on a flat enclosure door. This surface must be flat and smooth. Textured or rough surfaces are not recommended and may limit the effectiveness of the gasket seal provided.

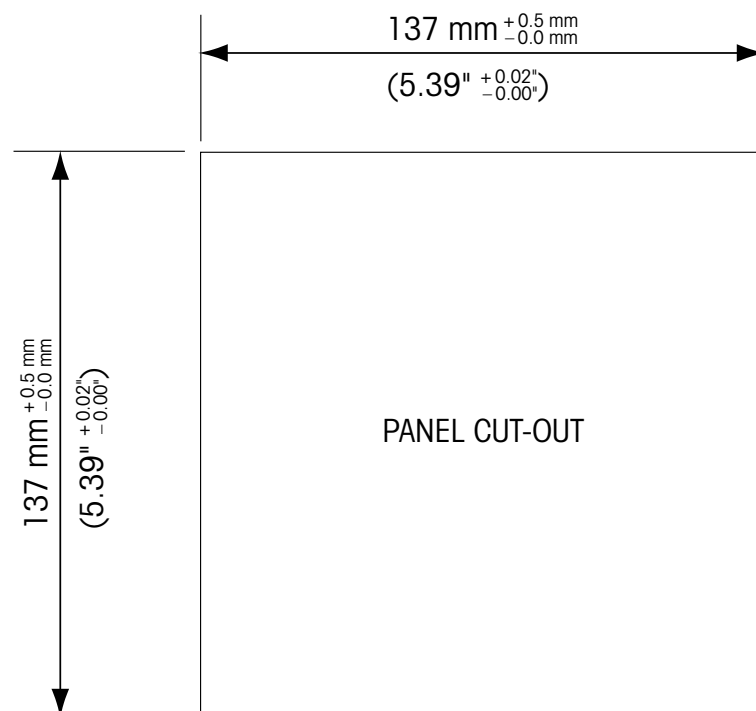

Optional hardware accessories are available that allow for panel- or pipe-mount. Refer to section 15 "Accessories and Spare Parts" for ordering information.

## 4.1.2 Installation Procedure

### General:

- Orient the transmitter so that the cable grips face downward.
- Wiring routed through the cable grips shall be suitable for use in wet locations.
- In order provide IP66 enclosure ratings, all cable glands must be in place. Each cable gland must be filled using a cable, or suitable Cable Gland Hole Seal.

### For Wall Mount:

- Remove rear cover from front housing.
- Start by unscrewing the four screws located on the face of the transmitter, in each corner. This allows the front cover to swing away from the rear housing.
- Remove the hinge-pin by squeezing the pin from each end. This allows the front housing to be removed from the rear housing.
- Mount rear housing to wall. Secure mounting kit to the M400 according to the supplied instructions. Attach to wall using appropriate mounting hardware for wall surface. Be sure it is level and securely fastened and the installation adheres to any and all clearance dimensions required for transmitter service and maintenance. Orient the transmitter so that the cable grips are facing downward.
- Replace the front housing to the rear housing. Securely tighten the rear-cover screws to ensure that IP66/NEMA4X enclosure environmental rating is maintained. The unit is ready to be wired.

### For Pipe Mount:

- Use only manufacturer-supplied components for pipe-mounting the M400 transmitter and install per the supplied instructions. See section 15 "Accessories and Spare Parts" for ordering information.

## 4.1.3 Assembly – ½ DIN Version

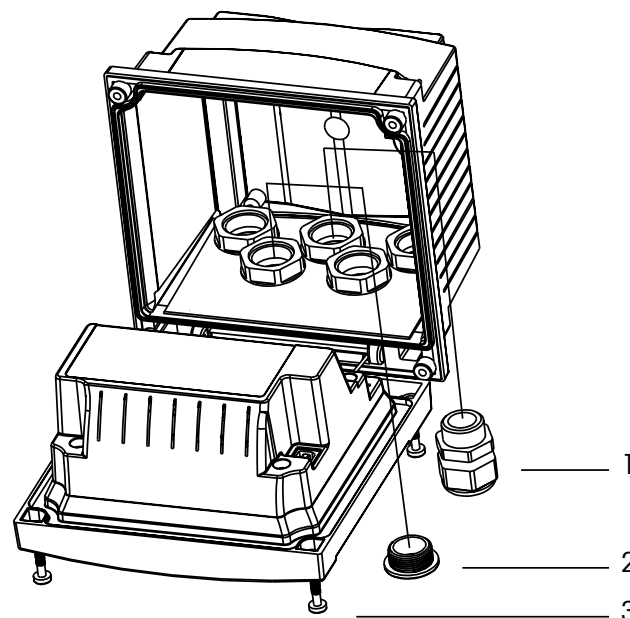

1. 3 M20X1.5 cable glands
2. Plastic plugs
3. 4 screws



### 4.1.4 ½ DIN Version – Dimension Drawings

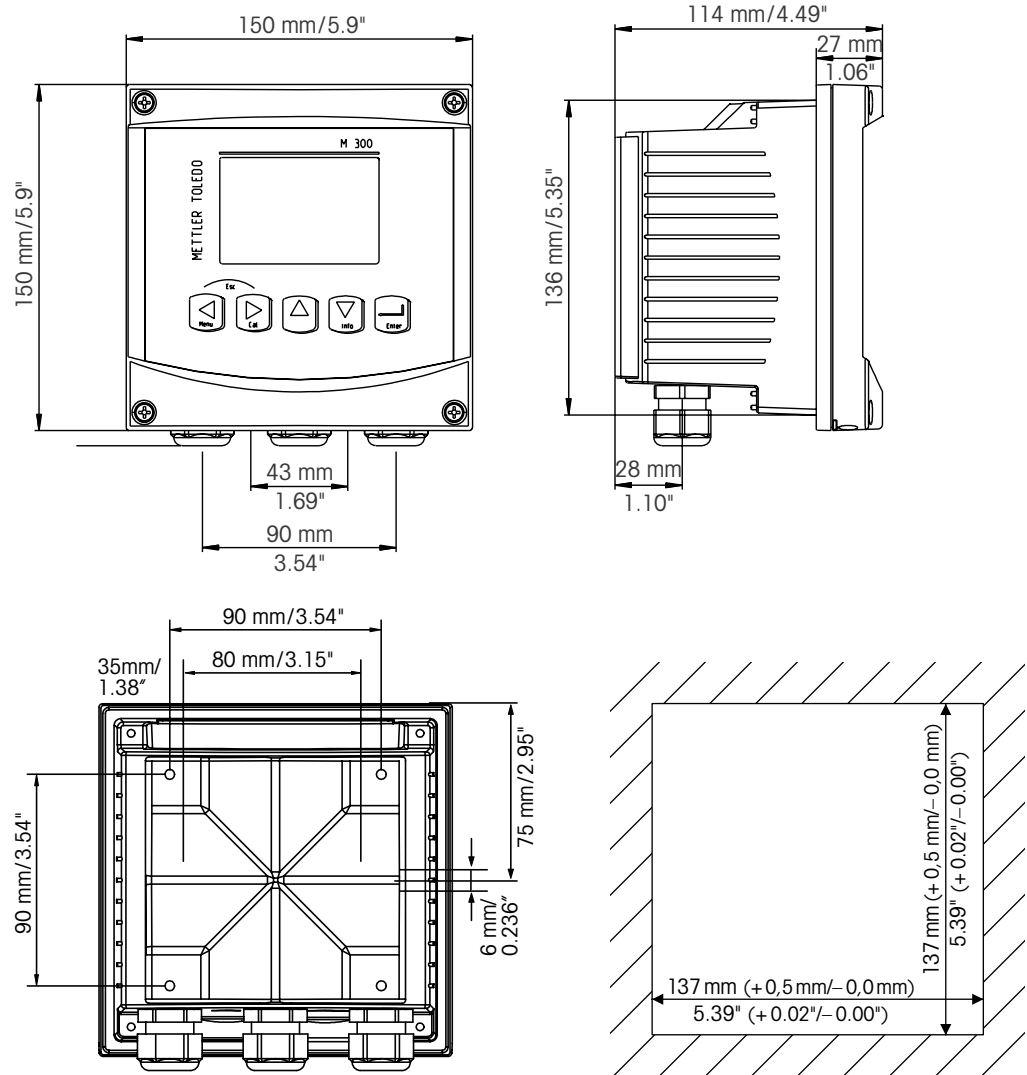

### 4.1.5 ½ DIN Version – Pipe Mounting

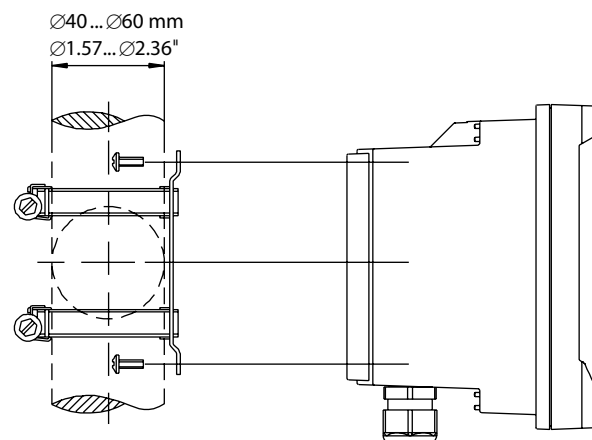

## 4.2 Connection of Power Supply

All connections to the transmitter are made on the rear panel of all models.



Be sure power to all wires is turned off before proceeding with the installation.

A two-terminal connector on the rear panel of all M400 models is provided for power connection. All M400 FF models are designed to operate in non-hazardous area from a 9 to 32 V DC power source (linear barrier: 9 to 24 V DC). Refer to specifications for power requirements and ratings and size power wiring accordingly (AWG 16 – 24, wire cross-section 0.2 mm<sup>2</sup> to 1.5 mm<sup>2</sup>).

The terminal block for power connections is labeled "FF-H1" on the rear panel of the transmitter. Connect the transmitter to the **-FF-H1** and **+FF-H1** terminals.

The terminals are suitable for single wires and flexible leads 0.2 mm<sup>2</sup> to 2.5 mm<sup>2</sup> (AWG 16 – 24). -FF-H1 and +FF-H1 terminals are available twice. There is no earth ground terminal on the transmitter. For this reason the internal power wiring within the transmitter is double insulated and the product label designates this using the □ symbol.

For further information e. g. on the cable specifications, see FOUNDATION fieldbus Guideline and IEC 61158-2 (MBP).

### 4.2.1 Housing (Wall Mount)

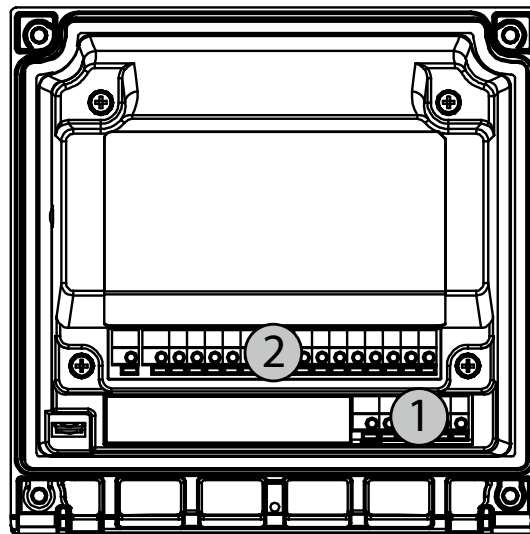

- 1: TB1 – FF-H1
- 2: TB2 – Sensor Signal

## 4.3 Connector PIN Definition

### 4.3.1 Terminal Block (TB) Definitions

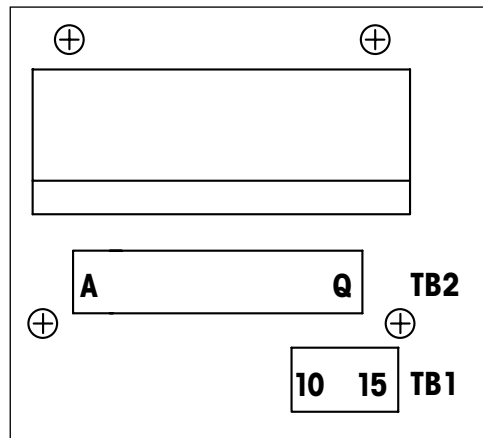

Power connections are labeled +FF-H1 and –FF-H1 for non-hazardous area: 9 to 32 V DC

#### TB1

1	Not available
2	Not available
3	Not available
4	Not available
5	Not available
6	Not available
7	Not available
8	Not available
9	Not available
10	+FF-H1
11	–FF-H1
12	+FF-H1
13	–FF-H1
14	Not used
15	

### 4.3.2 TB2 – Conductivity 4-e/2-e Analog Sensors

#### TB2 – Analog Sensors

Terminal	Cond 4-e or 2-e	
	Function	Color
A	Cnd inner1*	white
B	Cnd outer1*	white/blue
C	Cnd outer1	–
D	Not used	–
E	Cnd outer2	–
F	Cnd inner2**	blue
G	Cnd outer2 (GND)**	black
H	Not used	–
I	RTD ret/GND	bare shield
J	RTD sense	red
K	RTD	green
L	Not used	–
M	Not used	–
N	Not used	–
O	Not used	–
P	Not used	–
Q	Not used	–

\* For third party Cond 2-E sensors may be jumper between A and B has to be installed.

\*\* For third party Cond 2-E sensors may be jumper between F and G has to be installed.

### 4.3.3 TB2 – pH/ORP Analog Sensors

#### TB2 – Analog Sensors

Terminal	pH		Redox (ORP)	
	Function	Color*	Function	Color
A	Glass	transparent	Platinum	transparent
B	Not used	–	–	–
C	Not used	–	–	–
D	Not used	–	–	–
E	Reference	red	Reference	red
F	Reference**	–	Reference**	–
G	Solution GND**	blue***	Solution GND**	–
H	Not used	–	–	–
I	RTD ret/GND	white	–	–
J	RTD sense	–	–	–
K	RTD	green	–	–
L	Not used	–	–	–
M	Shield (GND)	green/yellow	Shield (GND)	green/yellow
N	Not used	–	–	–
O	Not used	–	–	–
P	Not used	–	–	–
Q	Not used	–	–	–

\* Grey wire not used.

\*\* Install jumper between F and G for ORP sensors and pH electrodes without SG.

\*\*\* Blue wire for electrode with SG.

### 4.3.4 TB2 – Oxygen Analog Sensors

		InPro6800(G)	InPro6900	InPro6950
Terminal	Function	Color	Color	Color
A	Not used	–	–	–
B	Anode	red	red	red
C	Anode	–*	–*	–
D	Reference	–*	–*	blue
E	Not used	–	–	–
F	Not used	–	–	–
G	Guard	–	grey	grey
H	Cathode	transparent	transparent	transparent
I	NTC ret (GND)	white	white	white
J	Not used	–	–	–
K	NTC	green	green	green
L	Not used	–	–	–
M	Shield (GND)	green/yellow	green/yellow	green/yellow
N	Not used	–	–	–
O	Not used	–	–	–
P	+ input 4/20 mA signal	–	–	–
Q	– input 4/20 mA signal	–	–	–

\* Install jumper between C and D for InPro 6800(G) and InPro 6900

### 4.3.5 TB2 – pH, Amp. Oxygen, Conductivity 4-e and Dissolved CO<sub>2</sub> (Low) ISM (Digital) Sensors

	pH, Amp. Oxygen, Cond 4-e, Dissolved CO <sub>2</sub>	
Terminal	Function	Color
A	Not used	–
B	Not used	–
C	Not used	–
D	Not used	–
E	Not used	–
F	Not used	–
G	Not used	–
H	Not used	–
I	Not used	–
J	Not used	–
K	Not used	–
L	1-wire	transparent (cable core)
M	GND	red (shield)
N	Not used	–
O	Not used	–
P	Not used	–
Q	Not used	–

## 4.3.6 TB2 – Optical Oxygen, ISM (Digital) Sensors

### 4.3.6.1 With VP8 Cable

Optical Oxygen with VP8 Cable		
Terminal	Function	Color
A	Not used	–
B	Not used	–
C	Not used	–
D	Not used	–
E	Not used	–
F	Not used	–
G	Not used	–
H	Not used	–
I	Not used	–
J	Not used	–
K	Not used	–
L	Not used	–
M	D_GND (shield)	green/yellow
N	RS485-B	brown
O	RS485-A	pink
P	Not used	–
Q	Not used	–

Connect the grey +24 DC wire and the blue D\_GND 24 V wire of the sensor separately.

### 4.3.6.2 With other Cables

Optical Oxygen with other Cables		
Terminal	Function	Color
A	Not used	–
B	Not used	–
C	Not used	–
D	Not used	–
E	Not used	–
F	Not used	–
G	Not used	–
H	Not used	–
I	Not used	yellow
J	Not used	–
K	Not used	–
L	Not used	–
M	D_GND (shield)	grey
N	RS485-B	blue
O	RS485-A	white
P	Not used	–
Q	Not used	–

Connect the brown +24 DC wire and the black D\_GND 24 V wire of the sensor separately.

## 4.4 Connection of ISM (Digital) Sensors

### 4.4.1 Connection of ISM Sensors for pH/ORP, Cond 4-e, Amp. Oxygen Measurement and Dissolved CO<sub>2</sub> (Low)

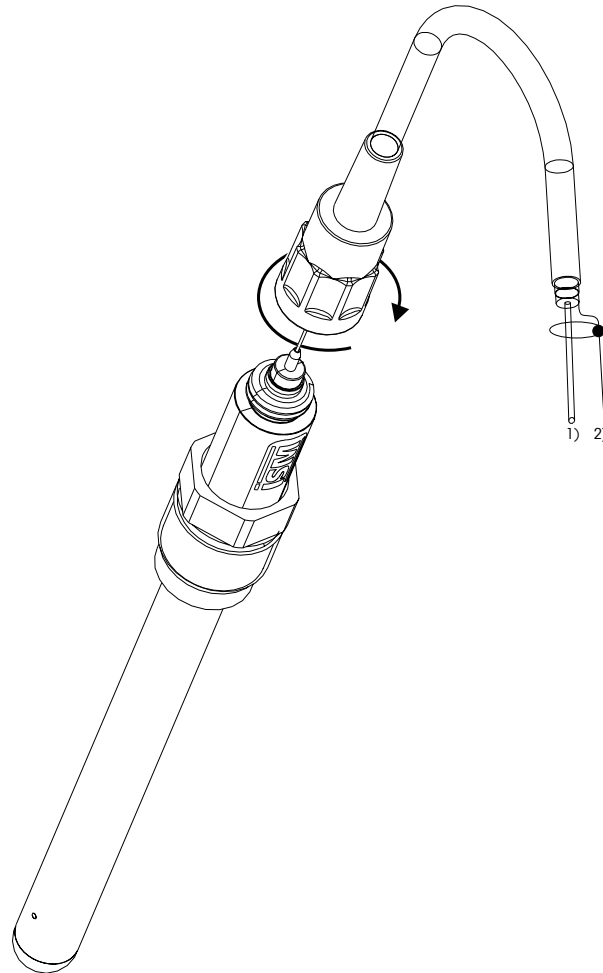



 **NOTE:** Connect the sensor and screw the plug head clockwise (hand tight).

### 4.4.2 TB2 – AK9 Cable Assignment

- \* 1-wire data (transparent)
- \*\* Ground/shield

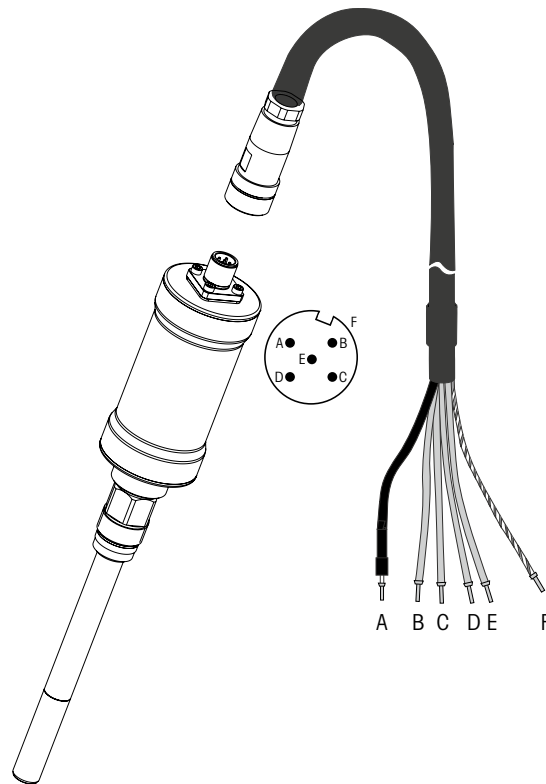
### 4.4.3 Connection of ISM Sensors for Optical Oxygen Measurement



 **NOTE:** Connect the Sensor and screw the plug head clockwise (hand tight).

 **NOTE:** The illustration does not apply for optical oxygen ISM sensors with VP8 cable.



## 4.5 Connection of Analog Sensors

### 4.5.1 Connection of Analog Sensor for pH/ORP

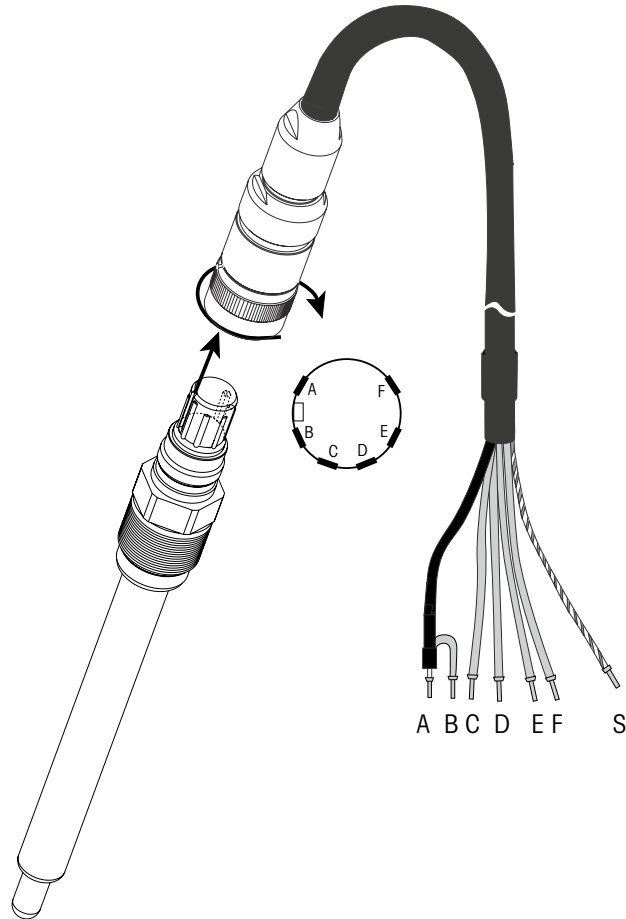

**NOTE:** Cable lengths > 20 m can worsen the response during pH measurement. Be sure to observe the sensor instruction manual.

## 4.5.2 TB2 – Typical Wiring for Analog pH/ORP Sensor

### 4.5.2.1 Example 1

pH measurement without Solution Ground

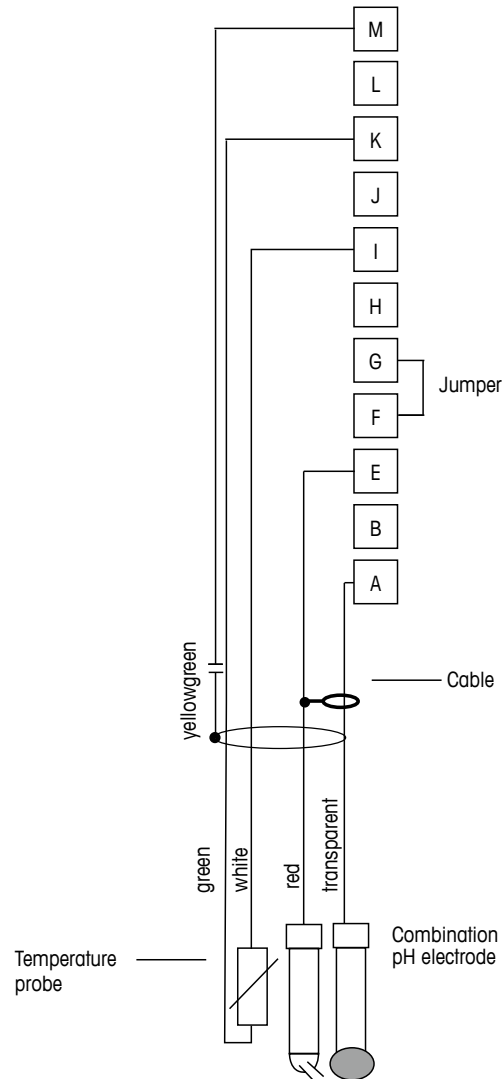

 **NOTE:** Jumper terminals G and F

Wire Colors only valid for connection with VP cable; blue and grey not connected.

A: Glass  
 E: Reference  
 I: RTD ref/GND  
 K: RTD  
 M: Shield/GND

### 4.5.2.2 Example 2

pH measurement with Solution Ground

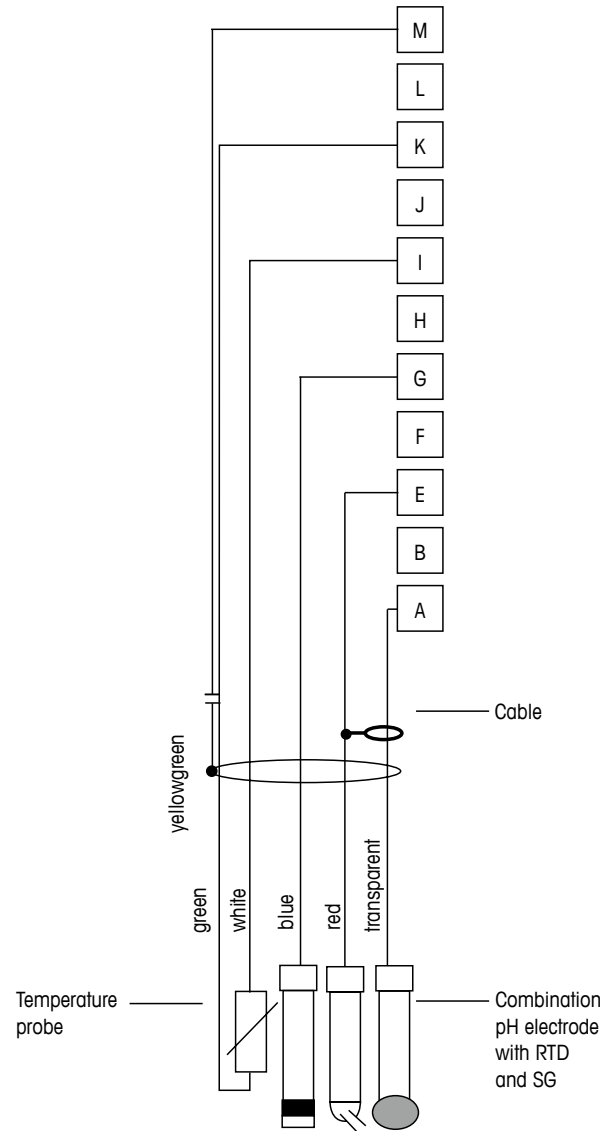

**NOTE:** Wire colors only valid for connection with VP cable, grey not connected.

- A: Glass
- E: Reference
- G: Shield/Solution GND
- I: GND/RTD ref
- K: RTD
- M: Shield (GND)

### 4.5.2.3 Example 3

ORP (redox) measurement (temperature optional)

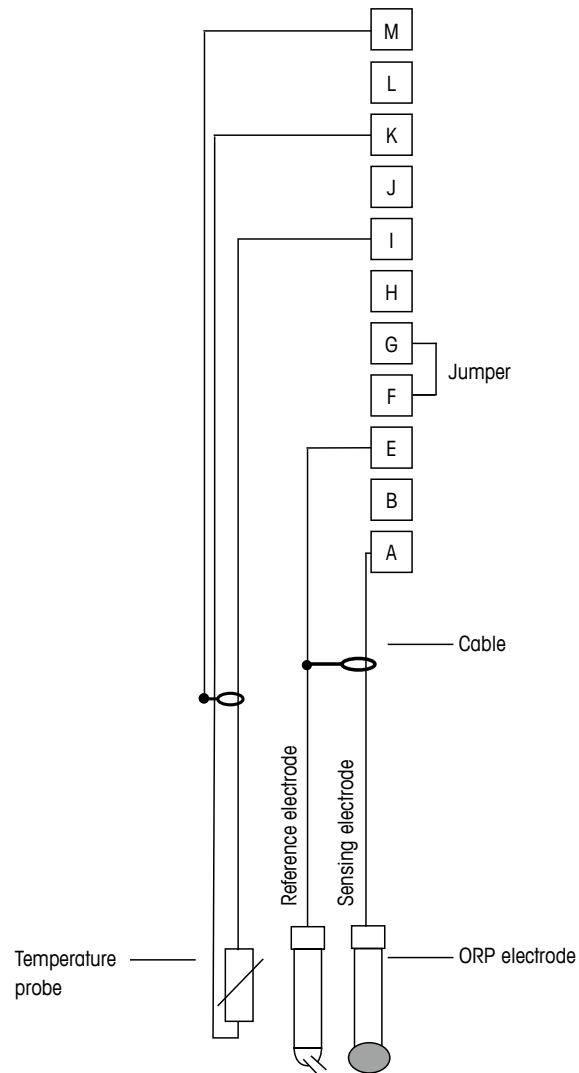



 **NOTE:** Jumper terminal G and F

A: Platinum  
 E: Reference  
 I: RTD ref/GND  
 K: RTD  
 M: Shield (GND)

### 4.5.2.4 Example 4

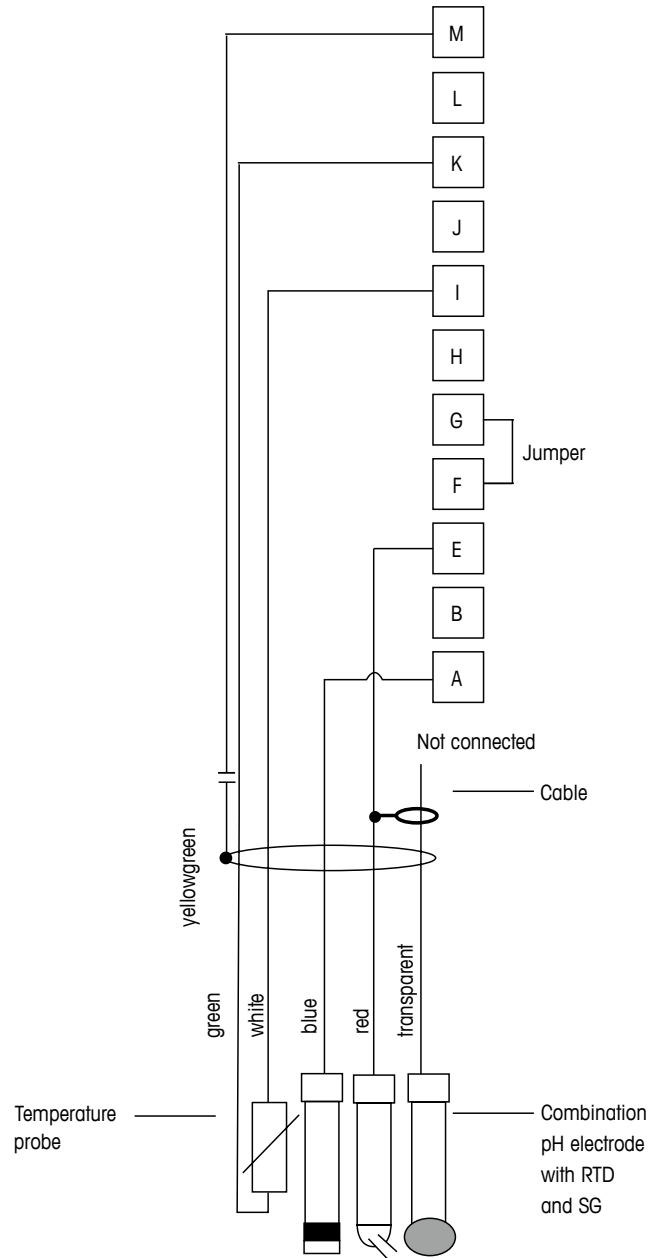
ORP measurement with pH solution ground electrode (e.g. InPro 3250, InPro 4800SG).



 **NOTE:** Jumper terminal G and F

- A: Platinum
- E: Reference
- I: RTD ret/GND
- K: RTD
- M: Shield (GND)

### 4.5.3 Connection of Analog Sensor for Amperometric Oxygen Measurement

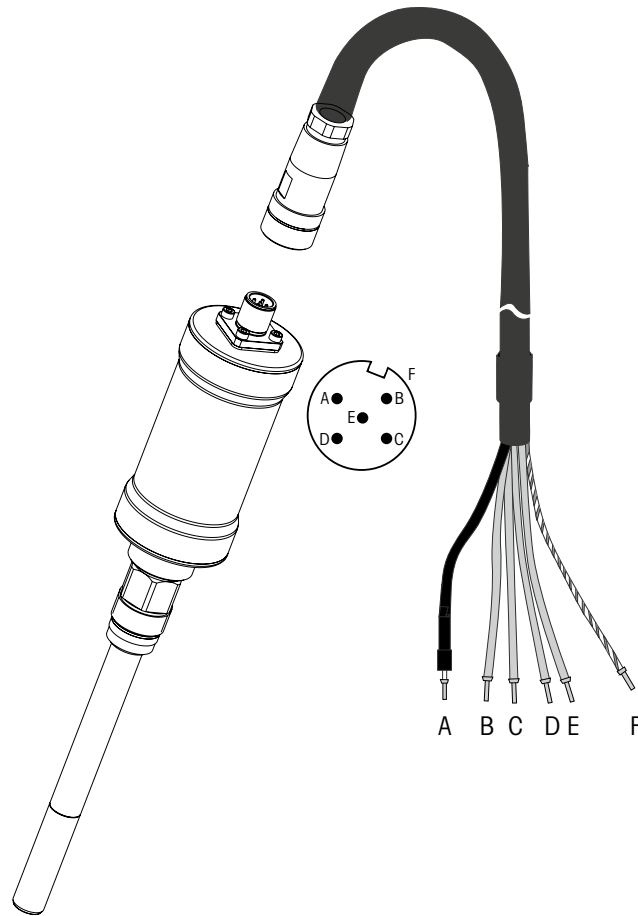

**NOTE:** Be sure to observe the sensor instruction manual.

### 4.5.4 TB2 – Typical Wiring for Analog Sensor for Amperometric Oxygen Measurement

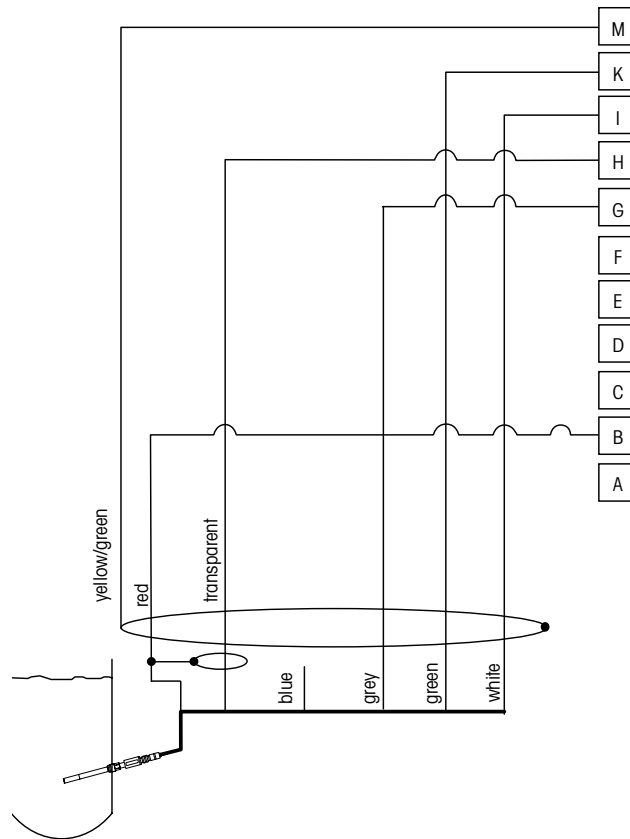

**NOTE:** Wire colors only valid for connection with VP cable, but not connected.

M400 connector:

- B: Anode
- G: Reference
- H: Cathode
- I: NTC ret/Guard
- K: NTC
- M: Shield (GND)

## 5 Placing Transmitter In, or Out, of Service

### 5.1 Placing Transmitter in Service



**WARNING:** After connecting the transmitter to power supply circuit, it will be active as soon as the circuit is powered.

### 5.2 Placing Transmitter out of Service

Switch on power supply. Disconnect the unit from the main power source. Disconnect all remaining electrical connections. Remove the unit from the wall/panel. Use the installation instruction in this manual as reference for dis-assembling mounting hardware.

All transmitter settings stored in memory are non volatile.



## 6 Quick Setup

(PATH: Menu/Quick Setup)

Select Quick Setup and press the [ENTER] key. Enter the security code if necessary (see section 9.2 "Passwords")



**NOTE:** Please find the complete description of the Quick Setup routine described in the separate booklet "Quick Setup Guide for Transmitter M400" enclosed in the box.



**NOTE:** Please do not use Quick Setup menu after configuration of the transmitter, because some of the parameters will may be reseted.



**NOTE:** Refer to section 3.2 "Control/Navigation Keys" for information on menu navigation.

## 7 Sensor Calibration

(PATH: Cal)

The calibration key ► allows the user one-touch access to sensor calibration and verification features.



**NOTE:** During Calibration on Channel A or B, a flashing "H" (Hold) on the left side of the Display indicates a calibration is in process with a Hold condition active. (The hold output needs to be activated.) See also section 3.2.8 "Display".

### 7.1 Enter Calibration Mode

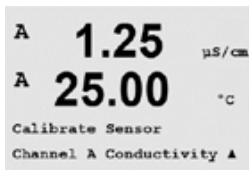

While in Measurement mode press the ► key. If the display prompts you to enter the Calibration security code, press the ▲ or ▼ key to set the calibration security mode, the [ENTER] key to confirm the calibration security code.

Press the ▲ or ▼ key to select the type of calibration desired.

Select the desired sensor Calibration task. The choices for each sensor type are:

Conductivity	= Conductivity, Resistivity, Temperature**, Edit**, Verify
Amp. Oxygen	= Oxygen, Temperature**, Edit**, Verify
Opt. Oxygen	= Oxygen**, Verify**
pH	= pH, mV**, Temperature**, Edit pH**, Edit mV**, Verify, ORP***
CO <sub>2</sub>	= CO <sub>2</sub> ***

Press [ENTER].

\*\* only on channel "A"

\*\*\* only available on channel "B"

After every successful calibration, the three options are available:

**Adjust:** Calibration values will be overtaken und used for the measurement. Additionally, the data will be stored in the calibration history\*.

**Calibrate:** Calibration values will be stored in the calibration history\* for documentation, but will not be used for the measurement. The calibration values from the last valid adjustment will be further used for the measurement.

**Abort:** Calibration values will be discarded.

\* only available with ISM sensors

## 7.2 Conductivity Calibration for Two- or Four-Electrode Sensors

This feature provides the ability to perform a one-point, two-point or process Conductivity resp. Resistivity "Sensor" calibration for two- or four-electrode sensors. The procedure described below works for both types of calibrations. There is no reason to perform a two-point calibration on a two-electrode conductivity sensor.



**NOTE:** When performing calibration on a conductivity sensor, results will vary depending on the methods, calibration apparatus and/or quality of reference standards used to perform the calibration.



**NOTE:** For measuring tasks the temperature compensation for the application as defined at the menu Resistivity will be considered and not the temperature compensation selected thru the calibration procedure (see also section 8.2.3.1 "Conductivity Temperature Compensation"; PATH: Menu/Configure/Measurement/Resistivity).

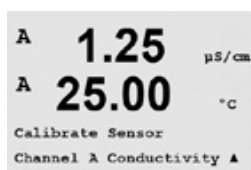

Enter Conductivity sensor calibration mode as described in section 7.1 "Enter Calibration Mode".

The next screen will ask to select the type of temperature compensation mode desired during the calibration process.

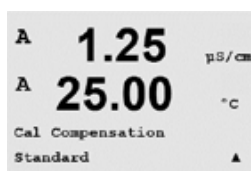

Choices are "None", "Standard", "Light 84", "Std 75 °C", "Lin 25 °C", "Lin 20 °C", "Glycol.5", "Glycol1", "Cation", "Alcohol" and "Ammonia".

**None** does not make any compensation of the measured conductivity value. The uncompensated value will be displayed and proceeded.

**Standard compensation** includes compensation for non-linear high purity effects as well as conventional neutral salt impurities and conforms to ASTM standards D1125 and D5391.

**Light 84 compensation** matches the high purity water research results of Dr. T.S. Light published in 1984. Use only if your institution has standardized on that work.

**Std 75 °C compensation** is the Standard compensation algorithm referenced to 75 °C. This compensation may be preferred when measuring Ultrapure Water at an elevated temperature (Resistivity of ultrapure water compensated to 75 °C is 2.4818 Mohm-cm.)

**Linear 25 °C compensation** adjusts the reading by a coefficient or factor expressed as %/°C (deviation from 25 °C). Use only if the solution has a well-characterized linear temperature coefficient. The factory default setting is 2.0% /°C.

**Linear 20 °C compensation** adjusts the reading by a coefficient or factor expressed as %/°C (deviation from 20 °C). Use only if the solution has a well-characterized linear temperature coefficient. The factory default setting is 2.0% /°C.

**Glycol.5 compensation** matches the temperature characteristics of 50% ethylene glycol in water. Compensated measurements using this solution may go above 18 Mohm-cm.

**Glycol1 compensation** matches the temperature characteristics of 100% ethylene glycol. Compensated measurements may go well above 18 Mohm-cm.

**Cation compensation** is used in power industry applications measuring the sample after a cation exchanger. It takes into account the effects of temperature on the dissociation of pure water in the presence of acids.

**Alcohol compensation** provides for the temperature characteristics of a 75% solution of isopropyl alcohol in pure water. Compensated measurements using this solution may go above 18 Mohm-cm.

**Ammonia compensation** is used in power industry applications for specific conductivity measured on samples using ammonia and/or ETA (ethanolamine) water treatment. It takes into account the effects of temperature on the dissociation of pure water in the presence of these bases.

Choose the compensation mode, modify the factor where appropriate and press [ENTER].

## 7.2.1 One-Point Sensor Calibration

(Display reflects typical Conductivity Sensor calibration)

Enter Conductivity Sensor Calibration mode as described in section 7.1 "Enter Calibration Mode" and choose one of the compensation modes (see section 7.2 "Conductivity Calibration for Two- or Four-Electrode Sensors").

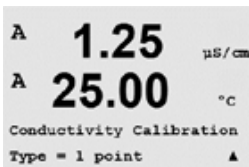

Select 1 point calibration and press [ENTER]. With conductivity sensors a one-point calibration is always performed as a slope calibration.

Place the electrode into the reference solution.

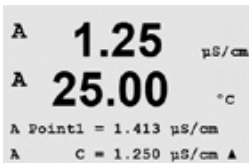

Enter the value for Point 1 including a decimal point and units. The value in the second text line is the value being measured by the transmitter and sensor in the units selected by the user. Press [ENTER] when this value is stable to perform the calibration.



After the calibration the cell multiplier or slope calibration factor "M" i.e. cell constant and the Adder or offset calibration factor "A" are displayed.

In case of a successful calibration, the calibration values are stored in the cal history\* and taken over (Adjust), stored in the cal history\* and not taken over (Calibrate) or discarded (Abort).

\* only available with ISM sensor. The values will be stored in the sensor.

If "Adjust" or "Calibrate" are chosen, the message "Calibration successful" is displayed. In any case you will get the message "Re-install sensor" and "Press ENTER" on the display. After pressing "ENTER" the M400 returns to the measuring mode.

## 7.2.2 Two-Point Sensor Calibration (Only for Four-Electrode Sensors)

(Display reflects typical Conductivity sensor calibration)

Enter Conductivity Sensor Calibration mode as described in section 7.1 "Enter Calibration Mode" and choose one of the compensation modes (see section 7.2 "Conductivity Calibration for Two- or Four-Electrode Sensors").

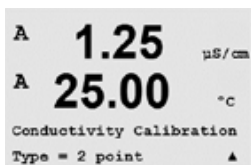

Select 2 point calibration and press [ENTER].

Place the electrode into the first reference solution.

**CAUTION:** Rinse sensors with a high-purity water solution between calibration points to prevent contamination of the reference solutions.

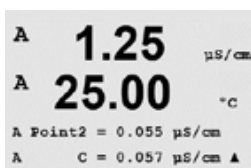

Enter the value for Point 1 including a decimal point and units. The value in the second text line is the value being measured by the transmitter and sensor in the units selected by the user. Press [ENTER] when this value is stable and place the electrode into the second reference solution.

Enter the value for Point 2 including a decimal point and units. The value in the second text line is the value being measured by the transmitter and sensor in the units selected by the user. Press [ENTER] when this value is stable to perform the calibration.

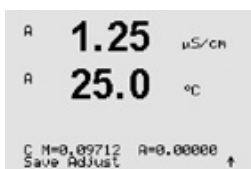

After the calibration of the cell multiplier or slope calibration factor "M" i.e. cell constant and the adder or offset calibration factor "A" are displayed.

In case of a successful calibration, the calibration values are stored in the cal history\* and taken over (Adjust), stored in the cal history\* and not taken over (Calibrate) or discarded (Abort).

\* only available with ISM sensor. The values will be stored in the sensor.

If "Adjust" or "Calibrate" are chosen, the message "Calibration successful" is displayed. In any case you will get the message "Re-install sensor" and "Press ENTER" on the display. After pressing "ENTER" the M400 returns to the measuring mode.

## 7.2.3 Process Calibration

(Display reflects typical Conductivity sensor calibration)

Enter Conductivity Sensor Calibration mode as described in section 7.1 "Enter Calibration Mode" and choose one of the compensation modes (see section 7.2 "Conductivity Calibration for Two- or Four-Electrode Sensors").



Select Process Calibration and press [ENTER]. With conductivity sensors a process calibration is always performed as a slope calibration.

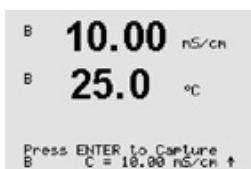

Take a sample and press the [ENTER] key again to store the current measuring value.

During the ongoing calibration process, the letter of the channel, which is concerned by the calibration, "A" or "B" is blinking in the display.

After determining the conductivity value of the sample, press the [CAL] key again to proceed with the calibration.

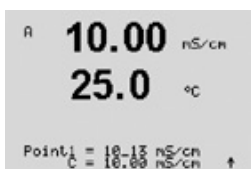

Enter the conductivity value of the sample, then press the [ENTER] key to start the calculation of calibration results.

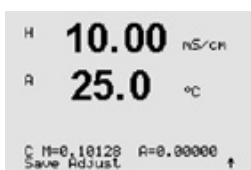

After the calibration the Multiplier or slope calibration factor "M" and the Adder or offset calibration factor "A" are displayed.

In case of a successful calibration, the calibration values are stored in the cal history\* and taken over (Adjust), stored in the cal history\* and not taken over (Calibrate) or discarded (Abort).

\* only available with ISM sensor. The values will be stored in the sensor.

If "Adjust" or "Calibrate" are chosen, the message "Calibration successful" is displayed. The M400 returns to the measuring mode.

## 7.3 Calibration of Amperometric Oxygen Sensors

Oxygen calibration for amperometric sensors is performed as either a one-point or process calibration.



**NOTE:** Before air calibration, for highest accuracy, enter the barometric pressure and relative humidity, as described in section 8.2.3.4 "Parameters for Oxygen Measurement Based on Amperometric Sensors".

### 7.3.1 One-Point Calibration for Amperometric Oxygen Sensors

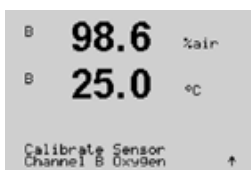

Enter Oxygen calibration mode as described in section 7.1 "Enter Calibration Mode".

A one-point calibration of oxygen sensors is always either a one-point slope (i.e. with air) or a zero (offset) calibration. A one-point slope calibration is done in air and a one-point offset calibration is done at 0 ppb oxygen. A one-point zero dissolved oxygen calibration is available but not normally recommended since zero oxygen is very hard to achieve. A zero-point calibration is only recommended if high accuracy at low oxygen level (below 5% air) is needed.

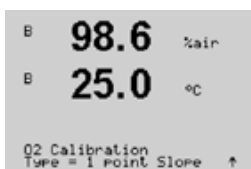

Select 1 point followed by either Slope or ZeroPt as the calibration type. Press [ENTER].

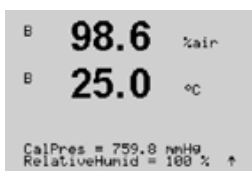

Adjust calibration pressure (CalPres) and relative humidity (RelativeHumid), which are applied during calibration. Press [ENTER].

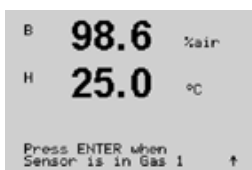

Place the sensor in the calibration gas (e.g. air) resp. solution. Press [ENTER].

Depending on the parameterized Drift control (see section 8.2.3.4 "Parameters for Oxygen Measurement Based on Amperometric Sensors") one of the two following modes is active.

### 7.3.1.1 Auto Mode



**NOTE:** For a zero point calibration the Auto mode is not available. If Auto mode has been configured (see section 8.2.3.4 "Parameters for Oxygen Measurement Based on Amperometric Sensors") and an offset calibration will be executed, the transmitter will perform the calibration in Manual mode.

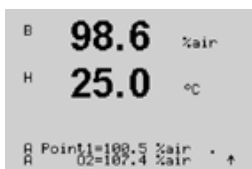

Enter the value for Point 1 including a decimal point and units. The value in the second text line is the value being measured by the transmitter and sensor in the units selected by the user.

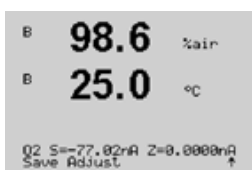

As soon as the stabilization criteria have been fulfilled the display changes. The display shows the calibration result for slope "S" and offset value "Z".

In case of a successful calibration, the calibration values are stored in the cal history\* and taken over (Adjust), stored in the cal history\* and not taken over (Calibrate) or discarded (Abort).

\* only available with ISM sensor. The values will be stored in the sensor.

### 7.3.1.2 Manual Mode

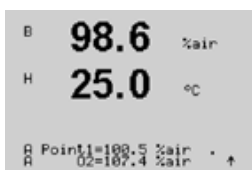

Enter the value for Point 1 including a decimal point and units. The value in the second text line is the value being measured by the transmitter and sensor in the units selected by the user. Press [ENTER] when this value is stable to perform the calibration.

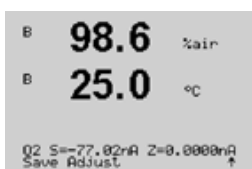

After the calibration the slope "S" and the offset value "Z" are displayed.

In case of a successful calibration, the calibration values are stored in the cal history\* and taken over (Adjust), stored in the cal history\* and not taken over (Calibrate) or discarded (Abort).

\* only available with ISM sensor. The values will be stored in the sensor.

If "Adjust" or "Calibrate" are chosen, the message "Calibration successful" is displayed. In any case you will get the message "Re-install sensor" and "Press ENTER" on the display. After pressing "ENTER" the M400 returns to the measuring mode.



**NOTE:** With ISM sensors: If a one-point calibration is executed, the transmitter sends the polarization voltage, valid for the calibration, to the sensor. If the polarization voltage for the measuring mode and calibration mode is different, the transmitter will wait 120 seconds before starting the calibration. In this case the transmitter will also go after the calibration for 120 seconds to the HOLD Mode, before returning to the measuring mode again. (see also section 8.2.3.4 "Parameters for Oxygen Measurement Based on Amperometric Sensors").

## 7.3.2 Process Calibration for Amperometric Oxygen Sensors

```

B  57.1  %air
B  25.0  °C

Calibrate Sensor
Channel B Oxygen  ↑
  
```

Enter Oxygen calibration mode as described in section 7.1 "Enter Calibration Mode".

A process calibration of oxygen sensors is always either a slope or a offset calibration.

```

B  57.1  %air
B  25.0  °C

O2 Calibration
Type = Process Slope  ↑
  
```

Select Process followed by either Slope or ZeroPt as the calibration type. Press [ENTER]

```

B  57.1  %air
B  25.0  °C

Press ENTER to Capture
A  O2=62.2  %air  ↑
  
```

Take a sample and press the [ENTER] key again to store the current measuring value. To show the ongoing calibration process, A or B (depending on the channel) is blinking in the display.

After determining the O<sub>2</sub> value of the sample press the ► key again to proceed with the calibration.

```

  57.1  %air
  25.0  °C

B Point1=100.5 %air
A  O2=62.2  %air  ↑
  
```

Enter the O<sub>2</sub> value of the sample then press the [ENTER] key to start the calculation of the calibration results.

```

B  57.1  %air
B  25.0  °C

O2 S=-44.63nA Z=0.0000nA
Save Adjust  ↑
  
```

After the calibration the slope "S" and the offset value "Z" are displayed.

In case of a successful calibration, the calibration values are stored in the cal history\* and taken over (Adjust), stored in the cal history\* and not taken over (Calibrate) or discarded (Abort).

\* only available with ISM sensor. The values will be stored in the sensor.

If "Adjust" or "Calibrate" are chosen, the message "Calibration successful" is displayed. The M400 returns to the measuring mode.



## 7.4 Calibration of Optical Oxygen Sensors (Only for ISM Sensors)

Oxygen calibration for optical sensors can be performed as a two-point, process or, depending on the sensor model connected to the transmitter, also as a one-point calibration.

### 7.4.1 One-Point Calibration for Optical Oxygen Sensors

Typically a one-point calibration is done in air. Nevertheless other calibration gases and solutions are possible.

The calibration of an optical sensor is always a calibration of the phase of the fluorescence signal towards the internal reference. During a one-point calibration the phase in this point is measured and extrapolated over the measuring range.

Enter O<sub>2</sub> opt calibration mode as described in section 7.1 "Enter Calibration Mode".

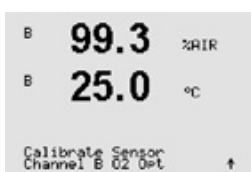

Select 1 point as the calibration type. Press [ENTER].

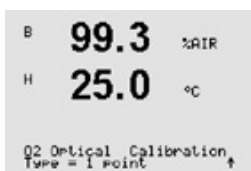

Place the sensor in the calibration gas (e.g. air) resp. solution.

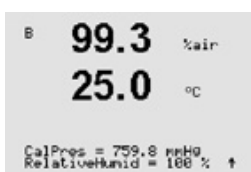

Adjust calibration pressure (CalPres) and relative humidity (RelativeHumid), which are applied during calibration. Press [ENTER].

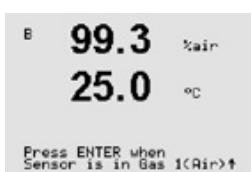

Place the sensor in the calibration gas (e.g. air) resp. solution. Press [ENTER].

Depending on the parameterized Drift control (see section 8.2.3.5 "Parameters for Oxygen Measurement Based on Optical Sensors") one of the two following modes is active.

#### 7.4.1.1 Auto mode

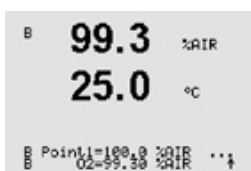

Enter the value for Point 1 including a decimal point and units. The value in the second text line is the value being measured by the transmitter resp. sensor in the units selected by the user.

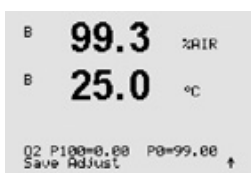

As soon as the stabilization criteria have been fulfilled the display changes. The display shows now the values for the phase of the sensor at 100% air (P100) and at 0% (P0) air.

In case of a successful calibration, the calibration values are stored in the cal history and taken over (Adjust), stored in the cal history and not taken over (Calibrate) or discarded (Abort).

If "Adjust" or "Calibrate" are chosen, the message "Calibration successful" is displayed. In any case you will get the message "Re-install sensor" and "Press ENTER" on the display. After pressing "ENTER" the M400 returns to the measuring mode.

### 7.4.1.2 Manual Mode

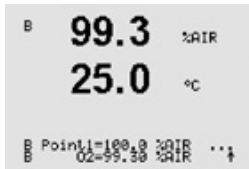

Enter the value for Point 1 including a decimal point and units. The value in the second text line is the value being measured by the transmitter resp. sensor in the units selected by the user.

Press [ENTER] to proceed.

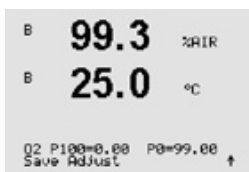

The display shows now the values for the phase of the sensor at 100% air (P100) and at 0% (P0) air.

In case of a successful calibration, the calibration values are stored in the cal history and taken over (Adjust), stored in the cal history and not taken over (Calibrate) or discarded (Abort).

If "Adjust" or "Calibrate" are chosen, the message "Calibration successful" is displayed. In any case you will get the message "Re-install sensor" and "Press ENTER" on the display. After pressing "ENTER" the M400 returns to the measuring mode.

### 7.4.2 Two-Point Sensor Calibration

The calibration of an optical sensor is always a calibration of the phase of the fluorescence signal towards the internal reference. A two-point calibration is a combination of first a calibration in air (100%) where a new phase P100 is measured and then a calibration in nitrogen (0%) where a new phase P0 is measured. This calibration routine gives the most accurate calibration curve over the whole measuring range.

Enter O<sub>2</sub> opt calibration mode as described in section 7.1 "Enter Calibration Mode".

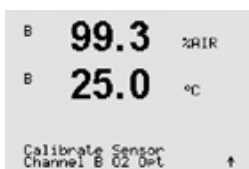

Select 2 point as the calibration type. Press [ENTER].

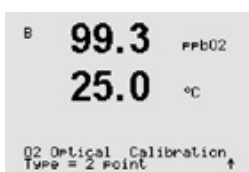

Adjust calibration pressure (CalPres) and relative humidity (RelativeHumid), which are applied during calibration. Press [ENTER].

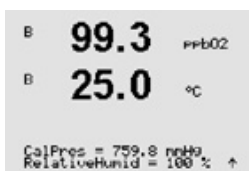

Place the sensor in the first calibration gas (e.g. air) resp. solution. Press [ENTER].

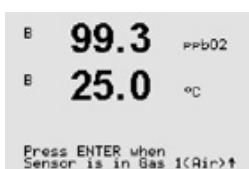

Depending on the parameterized Drift control (see section 8.2.3.5 "Parameters for Oxygen Measurement Based on Optical Sensors") one of the two following modes is active.

### 7.4.2.1 Auto Mode

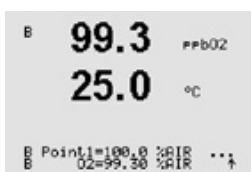

Enter the value for Point 1 including a decimal point and units. The value in the second text line is the value being measured by the transmitter resp. sensor in the units selected by the user.

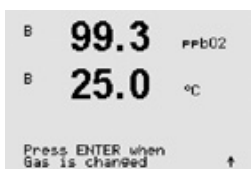

As soon as the stabilisation criteria have been fulfilled, the display changes and prompts you to change the gas.

Place the sensor in the second calibration gas and press the [ENTER] key to go on with the calibration.



Enter the value for Point 2 including a decimal point and units. The value in the second text line is the value being measured by the transmitter resp. sensor.

As soon as the stabilization criteria have been fulfilled the display changes. The display shows now the values for the phase of the sensor at 100% air (P100) and at 0% (P0) air.

In case of a successful calibration, the calibration values are stored in the cal history and taken over (Adjust), stored in the cal history and not taken over (Calibrate) or discarded (Abort).

If "Adjust" or "Calibrate" are chosen, the message "Calibration successful" is displayed. In any case you will get the message "Re-install sensor" and "Press ENTER" on the display. After pressing "ENTER" the M400 returns to the measuring mode.

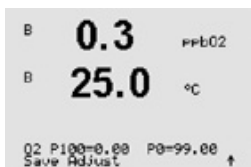

### 7.4.2.2 Manual Mode

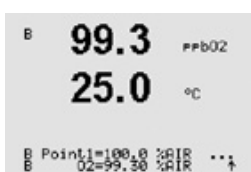

Enter the value for Point 1 including a decimal point and units. The value in the second text line is the value being measured by the transmitter resp. sensor in the units selected by the user.

Press [ENTER] to proceed.

The display changes and prompts you to change the gas.

Place the sensor in the second calibration gas and press the [ENTER] key to go on with the calibration.



Enter the value for Point 2 including a decimal point and units. The value in the second text line is the value being measured by the transmitter resp. sensor.

Press [ENTER] to proceed.

The display shows now the values for the phase of the sensor at 100% air (P100) and at 0% (P0) air.

In case of a successful calibration, the calibration values are stored in the cal history and taken over (Adjust), stored in the cal history and not taken over (Calibrate) or discarded (Abort).

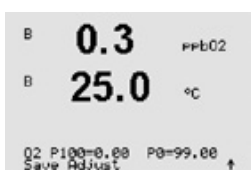
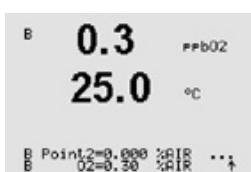

If "Adjust" or "Calibrate" are chosen, the message "Calibration successful" is displayed. In any case you will get the message "Re-install sensor" and "Press ENTER" on the display. After pressing "ENTER" the M400 returns to the measuring mode.

### 7.4.3 Process Calibration

The calibration of an optical sensor is always a calibration of the phase of the fluorescence signal towards the internal reference. During a process calibration the phase in this point is measured and extrapolated over the measuring range.

Enter O<sub>2</sub> opt calibration mode as described in section 7.1 "Enter Calibration Mode".

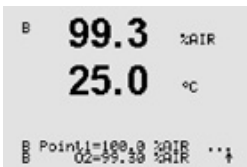

Select 1 point as the calibration type. Press [ENTER].

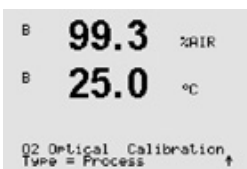

Take a sample and press the [ENTER] key again to store the current measuring value. To show the ongoing calibration process, A or B (depending on the channel) is blinking in the display.

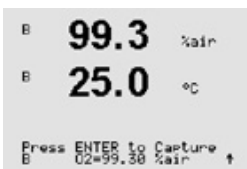

After determining the O<sub>2</sub> value of the sample press the [CAL] key again to proceed with the calibration.

Enter the O<sub>2</sub> value of the sample then press the [ENTER] key to start calibration.

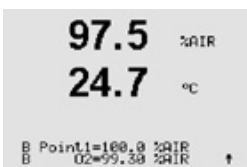

The display shows now the values for the phase of the sensor at 100% air (P100) and at 0% (P0) air.

In case of a successful calibration, the calibration values are taken over and stored in the cal history (Adjust), only stored in the cal history (Calibrate) or aborted.

If "Adjust" or "Calibrate" are chosen, the message "Calibration successful" is displayed. The M400 returns to the measuring mode.

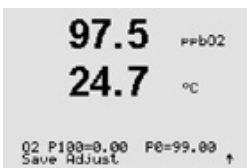

## 7.5 pH Calibration

For pH sensors, the M400 transmitter features one-point, two-point (Auto or Manual mode) or process calibration with 9 preset buffer sets or manual buffer entry. Buffer values refer to 25 °C. To calibrate the instrument with automatic buffer recognition, you need a standard pH buffer solution that matches one of these values. (See section 8.2.3.3 "pH/ORP Parameters" for configuring modes and selecting buffer sets.) Please select the correct buffer table before using automatic calibration (see section 19 "Buffer Tables").



**NOTE:** For dual membrane pH electrodes (pH/pNa) only buffer Na+ 3.9M (see section 19.2.1 "Mettler-pH/pNa Buffers (Na+ 3.9M)") is available.

### 7.5.1 One-Point Calibration



Enter pH calibration mode as described in section 7.1 "Enter Calibration Mode".

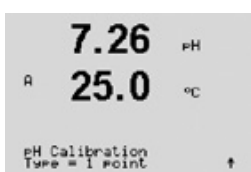

Select 1 point Calibration. With pH sensors a one-point calibration is always performed as a offset calibration.

Depending on the parameterized Drift control (see section 8.2.3.3 "pH/ORP Parameters") one of the two following modes is active.

#### 7.5.1.1 Auto Mode

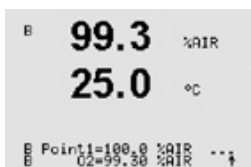

Place the electrode in the buffer solution and press the [ENTER] key to start the calibration.

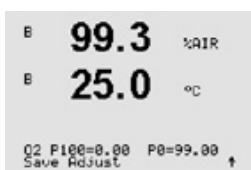

The display shows the buffer the transmitter has recognized (Point 1) and the measured value.

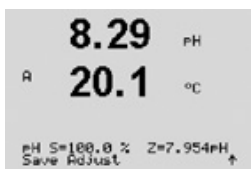

As soon as the stabilisation criteria have been fulfilled the display changes. The display shows now the slope calibration factor S and the offset calibration factor Z.

In case of a successful calibration, the calibration values are stored in the cal history\* and taken over (Adjust), stored in the cal history\* and not taken over (Calibrate) or discarded (Abort).

\* only available with ISM sensor. The values will be stored in the sensor.

If "Adjust" or "Calibrate" are chosen, the message "Calibration successful" is displayed. In any case you will get the message "Re-install sensor" and "Press ENTER" on the display. After pressing "ENTER" the M400 returns to the measuring mode.

### 7.5.1.2 Manual Mode

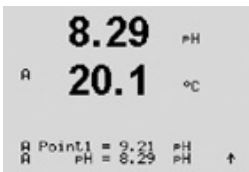

Place the electrode in the buffer solution. The display shows the buffer the transmitter has recognized (Point 1) and the measured value. Press [ENTER] to proceed.



The display shows now the slope calibration factor S and the offset calibration factor Z.

In case of a successful calibration, the calibration values are stored in the cal history\* and taken over (Adjust), stored in the cal history\* and not taken over (Calibrate) or discarded (Abort).

\* only available with ISM sensor. The values will be stored in the sensor.

If "Adjust" or "Calibrate" are chosen, the message "Calibration successful" is displayed. In any case you will get the message "Re-install sensor" and "Press ENTER" on the display. After pressing "ENTER" the M400 returns to the measuring mode.

## 7.5.2 Two-Point Calibration



Enter pH calibration mode as described in section 7.1 "Enter Calibration Mode".

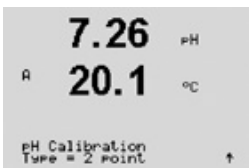

Select 2 Point calibration.

Depending on the parameterized Drift control (see section 8.2.3.3 "pH/ORP Parameters") one of the two following modes is active.

### 7.5.2.1 Auto Mode

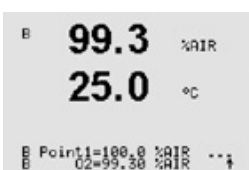

Place the electrode in the first buffer solution and then press the [ENTER] key.

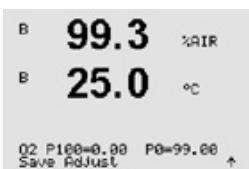

The display shows the buffer the transmitter has recognized (Point 1) and the measured value.



As soon as the stabilisation criteria have been fulfilled stabilisation criteria have been fulfilled, the display changes and prompts you to place the electrode in the second buffer.

Place the electrode in the second buffer solution and press the [ENTER] key to go on with the calibration.

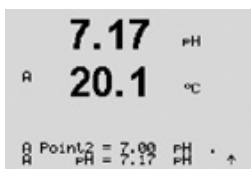

The display shows the second buffer the transmitter has recognized (Point 2) and the measured value.



As soon as the stabilisation criteria have been fulfilled the display changes to show the slope calibration factor S and the offset calibration factor Z.

In case of a successful calibration, the calibration values are stored in the cal history\* and taken over (Adjust), stored in the cal history\* and not taken over (Calibrate) or discarded (Abort).

\* only available with ISM sensor. The values will be stored in the sensor.

If "Adjust" or "Calibrate" are chosen, the message "Calibration successful" is displayed. In any case you will get the message "Re-install sensor" and "Press ENTER" on the display. After pressing "ENTER" the M400 returns to the measuring mode.

### 7.5.2.2 Manual Mode

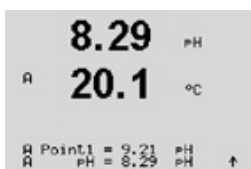

Place the electrode in the first buffer solution. The display shows the buffer the transmitter has recognized (Point 1) and the measured value. Press [ENTER] to proceed.

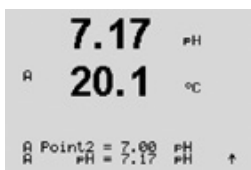

Place the transmitter in the second buffer solution. The display shows the buffer the transmitter has recognized (Point 2) and the measured value. Press [ENTER] to proceed.



The display shows the slope calibration factor S and the offset calibration factor Z.

In case of a successful calibration, the calibration values are stored in the cal history\* and taken over (Adjust), stored in the cal history\* and not taken over (Calibrate) or discarded (Abort).

If "Adjust" or "Calibrate" are chosen, the message "Calibration successful" is displayed. In any case you will get the message "Re-install sensor" and "Press ENTER" on the display. After pressing "ENTER" the M400 returns to the measuring mode.

### 7.5.3 Process Calibration



Enter pH calibration mode as described in section 7.1 "Enter Calibration Mode".

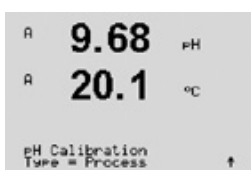

Select Process calibration. With pH sensors a process calibration is always performed as a offset calibration.

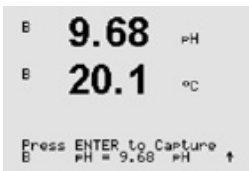

Take a sample and press the [ENTER] key again to store the current measuring Value. To show the ongoing calibration process, A or B (depending on the channel) is blinking in the display.



After determining the pH value of the sample, press the [CAL] key again to proceed with the calibration.

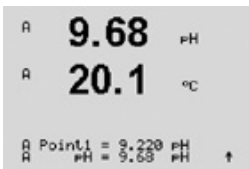

Enter the pH value of the sample then press the [ENTER] key to start the calculation of the calibration results.



After the calibration the slope calibration factor S and the offset calibration factor Z are displayed.

In case of a successful calibration, the calibration values are stored in the cal history\* and taken over (Adjust), stored in the cal history\* and not taken over (Calibrate) or discarded (Abort).

\* only available with ISM sensor. The values will be stored in the sensor.

If "Adjust" or "Calibrate" are chosen, the message "Calibration successful" is displayed. The M400 returns to the measuring mode.

## 7.5.4 mV Calibration (Only for Analog Sensors)



Enter mV calibration mode as described in section 7.1 "Enter Calibration Mode".

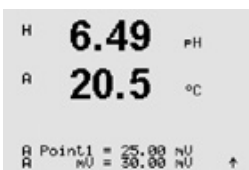

The user can now enter Point 1. The offset calibration factor is calculated by using the value of Point1 instead of the measured value (line 4, mV = ....) and displayed on the next screen.

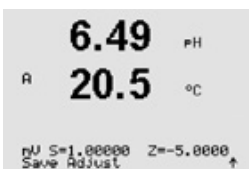

Z is the newly calculated offset calibration factor. The slope calibration factor S is always 1 and does not enter the calculation.

After a successful calibration, the calibration values are taken over (Adjust) or discarded (Calibrate) or (Abort).

If "Adjust" is chosen, the message "Calibration successful" is displayed. In any case you will get the message "Re-install sensor" and "Press ENTER" on the display. After pressing "ENTER" the M400 returns to the measuring mode.



## 7.5.5 ORP Calibration (Only for ISM Sensors)

In case that an pH sensor with solution ground based on ISM technology is connected to the M400, the transmitter gives the option to make in addition to the pH calibration an ORP calibration.



**NOTE:** In case of choosing ORP calibration the parameters defined for pH (see section 8.2.3.3 "pH/ORP Parameters", PATH: Menu/Configure/Measurement/pH) will not be considered.



Enter ORP calibration mode as described in section 7.1 "Enter Calibration Mode".

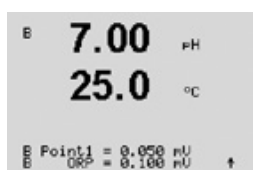

The user can now enter Point 1. In addition the actual ORP is displayed.

Press [ENTER] to proceed.

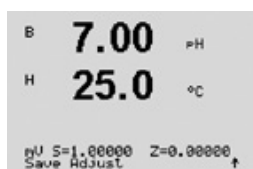

The display shows the slope calibration factor S and the offset calibration factor Z.

After a successful calibration, the calibration values are taken over and stored in the cal history (Adjust), only stored in the cal history (Calibrate) or aborted.

If "Adjust" or "Calibrate" are chosen, the message "Calibration successful" is displayed. In any case you will get the message "Re-install sensor" and "Press ENTER" on the display. After pressing "ENTER" the M400 returns to the measuring mode.

## 7.6 Dissolved Carbon Dioxide Calibration

For dissolved carbon dioxide (CO<sub>2</sub>) sensors, the M400 transmitter features one-point, two-point (Auto or Manual mode) or process calibration. For the one-point or two-point calibration the solution with pH = 7.00 and/or pH = 9.21 of the Mettler – 9 standard buffer can be used (see also section 8.2.3.8 "Dissolved carbon dioxide parameters") or the buffer value can be entered manually.

For "Thermal Conductivity" dissolved carbon dioxide (CO<sub>2</sub> Hi) cali, please consult the Sensor Manual (InPro 5500 i).

### 7.6.1 One-Point Calibration



Enter CO<sub>2</sub> calibration mode as described in section 7.1 "Enter Calibration Mode".



Select 1 point Calibration. With CO<sub>2</sub> sensors a one-point calibration is always performed as a offset calibration.

Depending on the parameterized Drift control (see section 8.2.3.8 "Dissolved Carbon Dioxide Parameters") one of the two following modes is active.

### 7.6.1.1 Auto Mode

H 137.5 hPa  
A 26.1 °C  
Press ENTER when  
Sensor is in Buffer 1 ↑

Place the electrode in the buffer solution and press the [ENTER] key to start the calibration.

H 154.5 hPa  
A 26.1 °C  
Point1 = 7.00 pH  
CO2 = 7.07 pH ↑

The display shows the buffer the transmitter has recognized (Point 1) and the measured value.

H 154.5 hPa  
A 26.1 °C  
pH S=100.0 % Z=7.040pH  
Save Adjust ↑

As soon as the stabilisation criteria have been fulfilled the display changes to show the slope calibration factor S and the offset calibration factor Z.

After a successful calibration, the calibration values are taken over (Adjust) or were aborted (Calibrate or Abort).

If "Adjust" or "Calibrate" are chosen, the message "Calibration successful" is displayed. In any case you will get the message "Re-install sensor" and "Press ENTER" on the display. After pressing "ENTER" the M400 returns to the measuring mode.

### 7.6.1.2 Manual Mode

A 122.4 hPa  
A 26.1 °C  
Point1 = 7.00 pH  
CO2 = 7.17 pH ↑

Place the electrode in the buffer solution. The display shows the buffer the transmitter has recognized (Point 1) and the measured value. Press [ENTER] to proceed.

A 122.4 hPa  
A 26.1 °C  
pH S=100.0 % Z=6.947pH  
Save Adjust ↑

The display shows now the slope calibration factor S and the offset calibration factor Z.

After a successful calibration, the calibration values are taken over (Adjust) or were aborted (Calibrate or Abort).

If "Adjust" or "Calibrate" are chosen, the message "Calibration successful" is displayed. In any case you will get the message "Re-install sensor" and "Press ENTER" on the display. After pressing "ENTER" the M400 returns to the measuring mode.

### 7.6.2 Two-Point Calibration

A 180.4 hPa  
A 26.1 °C  
Calibrate Sensor  
Channel A CO2 ↑

Enter CO<sub>2</sub> calibration mode as described in section 7.1 "Enter Calibration Mode".

H 180.4 hPa  
A 26.1 °C  
CO2 Calibration  
Type = 2 point ↑

Select 2 Point calibration.

Depending on the parameterized Drift control (see section 8.2.3.8 "Dissolved carbon dioxide parameters") one of the two following modes is active.

### 7.6.2.1 Auto Mode

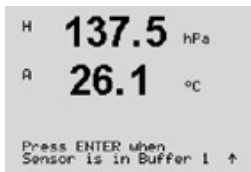

Place the electrode in the first buffer solution and press the [ENTER] key to start the calibration.

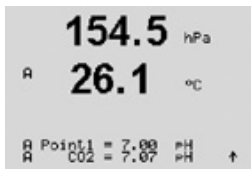

The display shows the buffer the transmitter has recognized (Point 1) and the measured value.

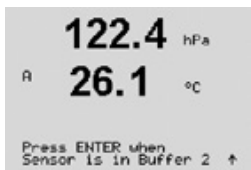

As soon as the stabilisation criteria have been fulfilled, the display changes and prompts you to place the electrode in the second buffer.

Place the electrode in the second buffer solution and press the [ENTER] key to go on with the calibration.

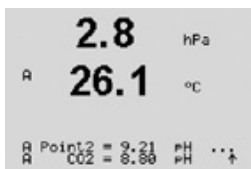

The display shows the second buffer the transmitter has recognized (Point 2) and the measured value.

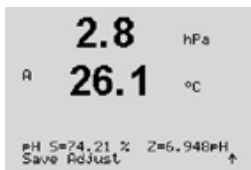

As soon as the stabilisation criteria have been fulfilled, the display changes to show the slope calibration factor S and the offset calibration factor Z.

After a successful calibration, the calibration values are taken over (Adjust) or were aborted (Calibrate or Abort).

If "Adjust" or "Calibrate" are chosen, the message "Calibration successful" is displayed. In any case you will get the message "Re-install sensor" and "Press ENTER" on the display. After pressing "ENTER" the M400 returns to the measuring mode.

### 7.6.2.2 Manual Mode



Place the electrode in the first buffer solution. The display shows the buffer the transmitter has recognized (Point 1) and the measured value. Press [ENTER] to proceed.

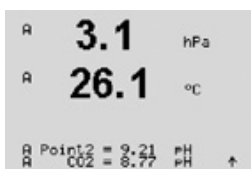

Place the electrode in the second buffer solution. The display shows the buffer the transmitter has recognized (Point 2) and the measured value. Press [ENTER] to proceed.

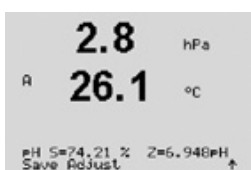

The display shows the slope calibration factor S and the offset calibration factor Z.

After a successful calibration, the calibration values are taken over (Adjust) or were aborted (Calibrate or Abort).

If "Adjust" or "Calibrate" are chosen, the message "Calibration successful" is displayed. In any case you will get the message "Re-install sensor" and "Press ENTER" on the display. After pressing "ENTER" the M400 returns to the measuring mode.

### 7.6.3 Process Calibration



Enter CO<sub>2</sub> calibration mode as described in section 7.1 "Enter Calibration Mode".

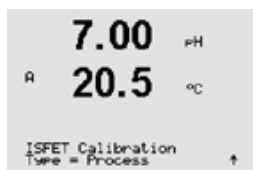

Select Process calibration. With CO<sub>2</sub> sensors a process calibration is always performed as a off-set calibration.

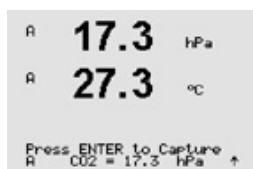

Take a sample and press the [ENTER] key again to store the current measuring value. To show the ongoing calibration process, A or B (depending on the channel) is blinking in the display. After determining the CO<sub>2</sub> value of the sample, press the ► key again to proceed with the calibration.

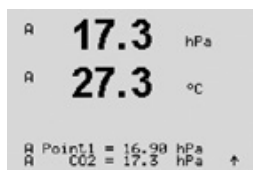

Enter the CO<sub>2</sub> value of the sample then press the [ENTER] key to start calibration.

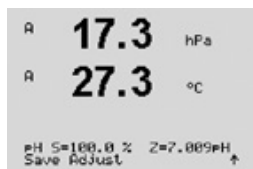

The display shows the slope calibration factor S and the offset calibration factor Z.

After a successful calibration, the calibration values are taken over (Adjust) or were aborted (Calibrate or Abort).

If "Adjust" or "Calibrate" are chosen, the message "Calibration successful" is displayed. The M400 returns to the measuring mode.

## 7.7 Sensor Temperature Calibration (Only for Analog Sensors)

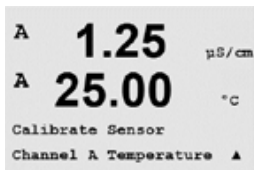

Enter Sensor calibration mode as described in section 7.1 "Enter Calibration Mode" and select Temperature.

### 7.7.1 One-Point Sensor Temperature Calibration

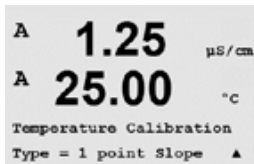

Select 1 Point calibration. Slope or Offset can be selected with the 1 Point calibration. Select Slope to recalculate the Slope factor M (Multiplier) or Offset to recalculate the offset calibration factor A (Adder).



**Note:** Due to non-linearity the 1 Point Slope temperature calibration is not implemented for the NTC22K as temperature source.

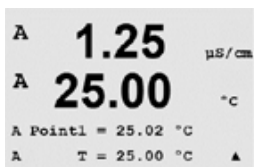

Enter the value for Point 1 and press [ENTER].



After a successful calibration, the calibration values are taken over (Adjust) or aborted (Calibrate, Abort).

If "Adjust" has been chosen, the message "Calibration successful" is displayed. In any case you will get the message "Re-install sensor" and "Press ENTER" on the display. After pressing "ENTER" the M400 returns to the measuring mode.

### 7.7.2 Two-Point Sensor Temperature Calibration



**Note:** Due to non-linearity the 2 Point temperature calibration is not implemented for the NTC22K as temperature source.

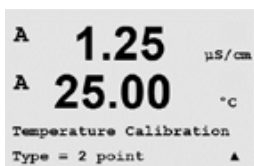

Select 2 Point as calibration type.

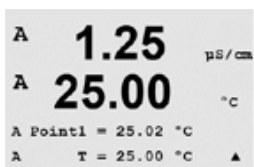

Enter the value for Point 1 and press [ENTER].

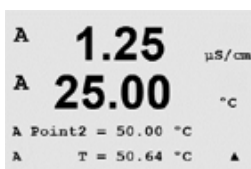

Enter the value for Point 2 and press [ENTER].



After a successful calibration, the calibration values are taken over (Adjust) or aborted (Calibrate, Abort).

If "Adjust" has been chosen, the message "Calibration successful" is displayed. In any case you will get the message "Re-install sensor" and "Press ENTER" on the display. After pressing "ENTER" the M400 returns to the measuring mode.

## 7.8 Edit Sensor Calibration Constants (Only for Analog Sensors)

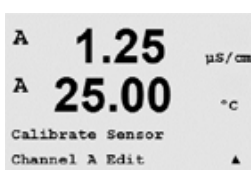

Enter Calibration mode as described in section 7.1 "Enter Calibration Mode" and select Edit, Edit pH, Edit mV.

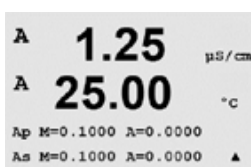

All calibration constants for the selected sensor channel are displayed. Primary measurement constants (p) are displayed on Line 3. Secondary measurement (temperature) constants (s) for the sensor are displayed on Line 4.

The calibration constants can be changed in this menu.

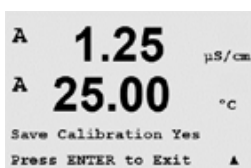

Select Yes to save the new calibration values and the successful calibration is confirmed on the display.



**NOTE:** Each time a new analog conductivity sensor is connected to the M400 transmitter, it is necessary to enter the unique calibration data (cell constant and offset) located on the sensor label.

## 7.9 Sensor Verification

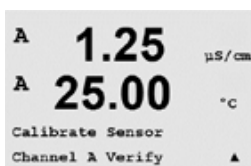

Enter Calibration mode as described in section 7.1 "Enter Calibration Mode" and select Verify.

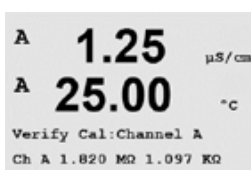

The measured signal of the primary and the secondary measurement in electrical units are shown. The meter calibration factors are used when calculating these values.

Press [ENTER] to exit from this display.

## 8 Configuration

(PATH: Menu/Configure)

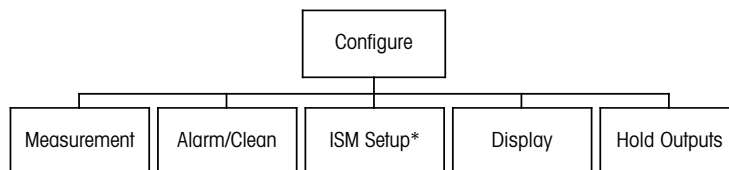

\* Only available in combination with ISM sensors

### 8.1 Enter Configuration Mode



While in Measurement mode, press the ◀ key. Press the ▲ or ▼ key to navigate to the Configure – menu and press [ENTER].

### 8.2 Measurement

(PATH: Menu/Configure/Measurement)

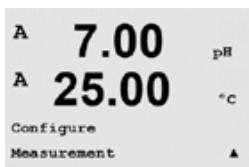

Enter configuration mode as described in section 8.1 “Enter Configuration Mode”.

Press the [ENTER] key to select this menu. The following sub menus can now be selected: Channel Setup, Temperature Source, Resistivity/Comp/pH/O<sub>2</sub>/CO<sub>2</sub>, Concentration Table and Set Averaging.

#### 8.2.1 Channel Setup

(PATH: Menu/Configure/Measurement/Channel Setup)

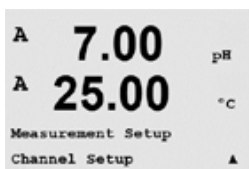

Press the [ENTER] key to select the “Channel Setup” menu.

Depending on the connected sensor (analog or ISM) the channel can be chosen.

### 8.2.1.1 Analog Sensor



Select sensor type Analog and press [ENTER].

Available measurement types are (depends on transmitter type):

Measurement parameter	Transmitter
pH/ORP = pH or ORP	M400 FF
Cond (2) = 2 electrode conductivity	M400 FF
Cond (4) = 4 electrode conductivity	M400 FF
O <sub>2</sub> hi = Dissolved oxygen (ppm) or oxygen in gas	M400 FF
O <sub>2</sub> lo = Dissolved oxygen (ppb) or oxygen in gas	M400 FF
O <sub>2</sub> Trace = Dissolved oxygen (trace) or oxygen in gas	M400 FF

The 4 lines of the display can now be configured with sensor channel "A" for each line of the display as well as measurements and unit multipliers. Pressing the [ENTER] key will display the selection for lines a, b, c and d.

### 8.2.1.2 ISM Sensor



Select sensor type ISM and press [ENTER].

If an ISM sensor is connected, the transmitter automatically (Parameter = Auto) recognizes the type of sensor. You can also fix the transmitter to a certain measurement parameter (Parameter = pH/ORP, pH/pNa, Cond(4), O<sub>2</sub> hi, O<sub>2</sub> lo, O<sub>2</sub> Trace, ppm O<sub>2</sub>G, O<sub>2</sub> Opt, CO<sub>2</sub> (low)), depending on the type of transmitter you have.

Measurement parameter	Transmitter
pH/ORP = pH and ORP	M400 FF
pH/pNa = pH and ORP (with pH/pNa electrode)	M400 FF
Cond (4) = 4 electrode conductivity	M400 FF
O <sub>2</sub> hi = Dissolved oxygen (ppm) or oxygen in gas	M400 FF
O <sub>2</sub> lo = Dissolved oxygen (ppb) or oxygen in gas	M400 FF
O <sub>2</sub> Trace = Dissolved oxygen (trace) or oxygen in gas	M400 FF
O <sub>2</sub> Opt = Dissolved oxygen optical	M400 FF

The 4 lines of the display can now be configured with sensor channel "B" for each line of the display as well as measurements and unit multipliers. Pressing the [ENTER] key will display the selection for lines a, b, c and d.



**NOTE:** Beside the measurement values pH, O<sub>2</sub>, T, etc. also the ISM values DLI, TTM and ACT can be assigned to the different lines and linked to the Analog Input Block of the FF interface. For more information see documentation "FOUNDATION fieldbus parameter Multi-parameter Transmitter M400 FF" on CD-ROM.

### 8.2.1.3 Save Changes of the Channel Setup

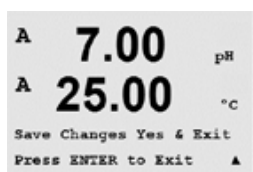

After the procedure of the channel setup described in the previous section pressing the [ENTER] key again will bring up the Save Changes dialog. Selecting No will discard the entered values and return to the measurement display screen, selecting Yes will save changes made.



## 8.2.2 Temperature Source (Only for Analog Sensors)

(PATH: Menu/Configure/Measurement/Temperature Source)



Enter Measurement as described in section 8.2 "Measurement". Select Temperature Source by using the ▲ or ▼ key and press [ENTER].



The following options can be chosen:

Auto: The transmitter automatically recognizes the temperature source.

Use NTC22K: Input will be taken from the sensor attached.

Use Pt1000: Temperature input will be taken from the sensor attached.

Use Pt100: Input will be taken from the sensor attached.

Fixed = 25 °C: Allows a specific temperature value to be entered. It must be chosen when customer use pH sensor without temperature source.



**NOTE:** If temperature source is set to Fixed, the temperature applied during one-point and/or two-point calibration of pH electrodes can be adjusted within the corresponding calibration procedure. After the calibration the fixed temperature defined in this configuration menu is valid again.

Pressing the [ENTER] key will bring up the Save Changes dialog.

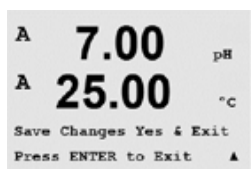

Selecting No will discard the entered values and return to the measurement display screen, selecting Yes will save changes made.

## 8.2.3 Parameter Related Settings

(PATH: Menu/Configure/Measurement/pH, O<sub>2</sub>, O<sub>2</sub> optical, O<sub>2</sub> opt sampling rate, LED Mode or Resistivity, Concentration Table or CO<sub>2</sub>)

Additional measurement and calibration parameters can be set for each parameter; conductivity, pH, O<sub>2</sub> and CO<sub>2</sub>.



**NOTE:** Use pH menu for settings of pH/pNa sensors.

Enter Configuration Mode as described in section 8.1 "Enter Configuration Mode" and select the menu Measurement (see section 8.2 "Measurement").

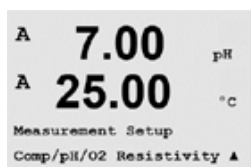

Depending on the connected sensor, the menu pH, O<sub>2</sub>, CO<sub>2</sub> can be selected by using the ▲ or ▼ key. Press [ENTER]

For more details, please see the following explanations depending on the selected parameter.

### 8.2.3.1 Conductivity Temperature Compensation

If during the channel setup (see section 8.2.1 "Channel Setup") the parameter conductivity has been chosen or a four-electrode conductivity sensor based on ISM technology is connected to the transmitter, the temperature compensation mode can be selected. Temperature compensation should be matched to the characteristics of the application. The transmitter considers this value for the temperature compensation by calculating and displaying the result for the measured conductivity.



**NOTE:** For calibration purposes the temperature compensation as defined at the menu "Cal/Compensation" for the buffers resp. samples will be considered (see also section 7.2 "Conductivity Calibration for Two- or Four-Electrode Sensors" resp.)

For doing this adjustment the menu "Resistivity", that will be displayed, has to be chosen (see section 8.2.3 "Parameter Related Settings").

The first two measurement lines are displayed on the screen. This section described the procedure for the first measurement line. By using the key ► the second line will be chosen. To select the 3rd and 4th line press [ENTER]. The procedure itself works at every measurement line in the same way.

Choices are "None", "Standard", "Light 84", "Std 75 °C", "Lin 25 °C", "Lin 20 °C", "Glycol.5", "Glycol1", "Cation", "Alcohol" and "Ammonia".

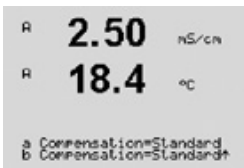

**Standard compensation** includes compensation for non-linear high purity effects as well as conventional neutral salt impurities and conforms to ASTM standards D1125 and D5391.

**None** does not make any compensation of the measured conductivity value. The uncompensated value will be displayed and proceeded.

**Light 84 compensation** matches the high purity water research results of Dr. T.S. Light published in 1984. Use only if your institution has standardized on that work.

**Std 75 °C compensation** is the Standard compensation algorithm referenced to 75 °C. This compensation may be preferred when measuring Ultrapure Water at an elevated temperature (Resistivity of ultrapure water compensated to 75 °C is 2.4818 Mohm-cm.)

**Glycol.5 compensation** matches the temperature characteristics of 50% ethylene glycol in water. Compensated measurements using this solution may go above 18 Mohm-cm.

**Glycol1 compensation** matches the temperature characteristics of 100% ethylene glycol. Compensated measurements may go well above 18 Mohm-cm.

**Cation compensation** is used in power industry applications measuring the sample after a cation exchanger. It takes into account the effects of temperature on the dissociation of pure water in the presence of acids.

**Alcohol compensation** provides for the temperature characteristics of a 75% solution of isopropyl alcohol in pure water. Compensated measurements using this solution may go above 18 Mohm-cm.

**Ammonia compensation** is used in power industry applications for specific conductivity measured on samples using ammonia and/or ETA (ethanolamine) water treatment. It takes into account the effects of temperature on the dissociation of pure water in the presence of these bases.

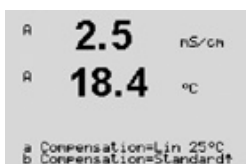

**Linear 25 °C compensation** adjusts the reading by a coefficient or factor expressed as %/°C (deviation from 25 °C). Use only if the solution has a well-characterized linear temperature coefficient.

The factory default setting is 2.0% /°C.



**Linear 20 °C compensation** adjusts the reading by a coefficient or factor expressed as %/°C (deviation from 20 °C). Use only if the solution has a well-characterized linear temperature coefficient.

The factory default setting is 2.0% /°C.

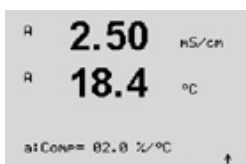

If compensation mode "Lin 25 °C" or "Lin 20 °C" has been chosen, the factor for the adjustment of the reading can be modified after pressing [ENTER] (If working at measurement line 1 or 2 press [ENTER] twice).

Adjust the factor for temperature compensation.

Pressing [ENTER] will bring up the Save Changes dialog. Selecting No will discard the entered values and return to the measurement display screen, selecting Yes will save changes made.

### 8.2.3.2 Concentration Table

If during the channel setup (see section 8.2.1 "Channel Setup") the parameter conductivity has been chosen or an four-electrode conductivity sensor based on ISM technology is connected to the transmitter, a concentration table can be defined.

To specify customers-specific solutions, up to 5 concentration values can be edited in a matrix together with up to 5 temperatures. To do so the desired values are edited under the concentration table menu. Furthermore the conductivity values for the according temperature and concentration values are edited.

For doing the settings the menu "Concentration Table", that will be displayed, has to be chosen. (see section 8.2.3 "Parameter Related Settings").



Define the desired **unit**.

Press [ENTER]



**NOTE:** Refer to section 8.2.1 "Channel Setup" to choose the unit used in the display.

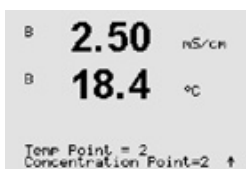

Enter the amount of desired temperature points (**Temp Point**) and **Concentration Points**.

Press [ENTER]

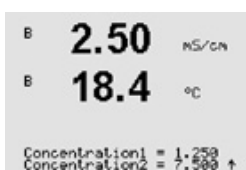

Enter the values for the different concentrations (**ConcentrationX**).

Press [ENTER]

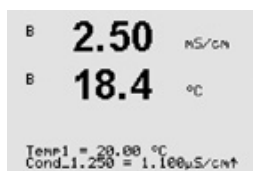

Enter the value of the 1st temperature (**Temp1**) and the value for the conductivity which belongs to the first concentration at this temperature.

Press [ENTER]

Enter the value for the conductivity which belongs to the second concentration at the first temperature and press [ENTER] etc..

After entering all conductivity values, that belong to the different concentrations at the first temperature point, enter in the same way the value of the 2nd temperature point (**Temp2**) and the conductivity value which belongs at the second temperature to the first concentration. Press [ENTER] and go on in the same way for the next concentration points as described for the first temperature point.

Enter in this way the values at every temperature point. After entering the last value, pressing [ENTER] again will bring up the Save Changes dialog. Selecting No will discard the entered values and return to the measurement display screen, selecting Yes will save changes made.



**NOTE:** The values for the temperature have to increase from Temp1 to Temp2 to Temp3 etc.. The values for the concentration have to increase from Concentration1 to Concentration2 to Concentration3 etc.



**NOTE:** The conductivity values at the different temperatures have to increase or decrease from Concentration1 to Concentration2 to Concentration3 etc.. Maxima and/or minima are not permitted. If the conductivity values at Temp1 are increasing with the different concentrations, they have to increase also at the other temperatures. If the conductivity values at Temp1 are decreasing with the different concentrations, they have to decrease also at the other temperatures.

### 8.2.3.3 pH/ORP Parameters

If during the channel setup (see section 8.2.1 "Channel Setup") the parameter pH/ORP has been chosen or an pH sensor based on ISM technology is connected to the transmitter, the parameters drift control, buffer recognition, STC, I P, fixed Calibration temperature and the displayed units for slope and zero point can be set resp. adjusted.

For doing this adjustments resp. settings the menu "pH", that will be displayed, has to be chosen. (see section 8.2.3 "Parameter Related Settings").



Select the **drift control** for calibration as Auto (drift and time criteria have to be fulfilled) or manual (The user can decide when a signal is stable enough to complete calibration) followed by the relevant buffer table for the automatic buffer recognition. If the drift rate is less than 0.4 mV over a 19 second interval then the reading is stable and the calibration is done using the last reading. If the drift criteria is not met within 300 seconds then the calibration times out and the message "Calibration Not Done" Press ENTER Enter to "Exit" is displayed.

Press [ENTER]

For automatic **buffer recognition** during calibration, select the buffer solution set that will be used: Mettler-9, Mettler-10, NIST Tech, NIST Std = JIS Std, HACH, CIBA, MERCK, WTW, JIS Z 8802 or None. See section 19 "Buffer tables" for buffer values. If the auto buffer feature will not be used or if the available buffers are different from those above, select None. Press [ENTER].



**NOTE:** For dual membrane pH electrodes (pH/pNa) only buffer Na+ 3.9M (see section 19.2.1 "Mettler-pH/pNa Buffers (Na+ 3.9M)") is available.

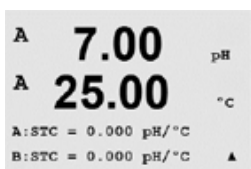

**STC** is the solution temperature coefficient in units of pH/°C referenced to 25 °C (Default = 0.000 for most applications). For pure waters, a setting of 0.016 pH/°C should be used. For low conductivity power plant samples near 9 pH, a setting of 0.033 pH/°C should be used. These positive coefficients compensate for the negative temperature influence on the pH of these samples. Press [ENTER].

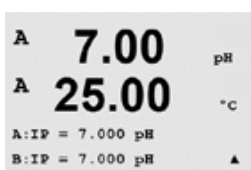

**IP** is the isothermal point value (Default = 7.000 for most applications). For specific compensation requirements or non standard inner buffer value, this value can be changed. Press [ENTER].



**STC RefTemp** sets the temperature to which solution temperature compensation is referenced. The displayed value and the output signal is referenced to STC RefTemp. Selecting "No" means solution temperature compensation is not used. The most common reference temperature is 25°C. Press [ENTER].



The units for the slope and the zero point, that will be shown on the display can be chosen. The default setting for the unit of the slope is [%] and can be changed to [pH/mV]. For the zero point the default setting of the unit is [pH] and can be changed to [mV]. Use the ► key to move to the input field and select the unit by using the ▲ or ▼ key.

Pressing [ENTER] again will bring up the Save Changes dialog. Selecting No will discard the entered values and return to the measurement display screen, selecting Yes will save changes made.

### 8.2.3.4 Parameters for Oxygen Measurement Based on Amperometric Sensors

If during the channel setup (see section 8.2.1 "Channel Setup") the parameter O<sub>2</sub> hi, O<sub>2</sub> lo or O<sub>2</sub> Trace has been chosen or an oxygen sensor based on ISM technology is connected to the transmitter, the parameters calibration pressure, process pressure, ProCalPres, salinity and relative humidity can be set resp. adjusted. If an ISM sensor is connected, there is furthermore the option to adjust the parameterization voltage.

For doing this adjustments resp. settings the menu "O<sub>2</sub>", that will be displayed, has to be chosen. (see section 8.2.3 "Parameter Related Settings")



Enter the Calibration pressure in line 3. The default value for CalPres is 759.8 and the default unit is mmHg.

Select Edit in line 4 for entering the applied process pressure manually. Select Ain if an analog input signal is used for the applied process pressure. Select FF if the pressure compensation value is supplied via FF. Press [ENTER]



If Edit has been chosen an input field for entering the value manually is displayed. In case that Ain has been selected the start value (4mA) and the end value (20 mA) of the range for the 4 to mA input signal have to be entered.

Press [ENTER]



For the algorithm of the process calibration the applied pressure (ProcCalPres) has to be defined. The value of the process pressure (ProcPres) or the calibration pressure (CalPres) can be used. Choose the pressure, that applies during the process calibration, resp. should be used for the algorithm.

Select the required Drift Control of the measuring signal during the calibration procedure. Choose Manual if the user will decide when a signal is stable enough to complete the calibration. Select Auto and an automatic stability control of the sensor signal during calibration through the transmitter will be done. Press [ENTER]



In the next step the salinity of the measured solution can be modified.

In addition the relative humidity of the calibration gas can also be entered. The allowed values for relative humidity are in the range 0% to 100%. When no humidity measurement is available, use 50% (default value).

Press [ENTER]

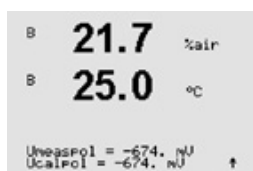

If an ISM sensor has been connected resp. configured there is furthermore the option to adjust the polarization voltage for the sensor. Different value can be entered for the measuring mode (Umeaspol) and for the calibration mode (Ucalpol). For entered values 0 mV to -550 mV the connected sensor will be set to a polarization voltage of -500mV. If the entered value is less than -550mV, the connected sensor will set to a polarization voltage of -674mV.



**NOTE:** During a process calibration, the polarization voltage Umeaspol, defined for the measuring mode, will be used.



**NOTE:** If a one-point calibration is executed, the transmitter sends the polarization voltage, valid for the calibration, to the sensor. If the polarization voltage for the measuring mode and calibration mode is different, the transmitter will wait 120 seconds before starting the calibration. In this case the transmitter will also go after the calibration for 120 seconds to the HOLD Mode, before returning to the measuring mode again.

Press [ENTER]



The display shows the Save Changes dialog. Selecting No will discard the entered values and return to the measurement display screen, selecting Yes will save changes made.

### 8.2.3.5 Parameters for Oxygen Measurement Based on Optical Sensors

If during the channel setup (see section 8.2.1 "Channel Setup") the parameter O<sub>2</sub> Opt has been chosen, the parameters calibration pressure, process pressure, ProCalPres, salinity, drift control and relative humidity can be set resp. adjusted.

For doing these adjustments the menu "O<sub>2</sub> optical", that will be displayed, has to be chosen. (see section 8.2.3 "Parameter Related Settings")

Press [ENTER]



Enter the calibration pressure (line 3). The default value for CalPres is 759.8 and the default unit is mmHg.

Select Edit in line 4 for entering the applied process pressure manually. Select Ain if an analog input signal is used for the applied process pressure. Press [ENTER]



If Edit has been chosen an input field for entering the value manually is displayed. In case that Ain has been selected the start value (4 mA) and the end value (20 mA) of the range for the 4 to 20 mA input signal have to be entered.

Press [ENTER]



**NOTE:** Refer to section 4.3.6 "TB2 – Optical Oxygen, ISM (Digital) Sensors".



For the algorithm of the process calibration the applied pressure (ProcCalPres) has to be defined. The value of the process pressure (ProcPres) or the calibration pressure (CalPres) can be used. Choose the pressure, that applies during the process calibration, resp. should be used for the algorithm.

Select the drift control for calibration as Auto (drift and time criteria have to be fulfilled) or manual (The user can decide when a signal is stable enough to complete calibration). If Auto is selected, the drift is checked by the sensor. If the drift criteria is not met within a defined time (depending on the sensor model) the calibration times out and the message "Calibration Not Done" Press ENTER Enter to "Exit" is displayed.

Press [ENTER]

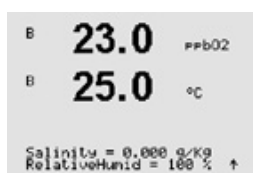

In the next step the salinity of the measured solution can be modified.

In addition the relative humidity of the calibration gas can also be entered. The allowed values for relative humidity are in the range 0% to 100%. When no humidity measurement is available, use 50% (default value).

Press [ENTER]

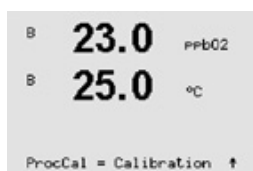

Select through the parameter **ProcCal** between Scaling and Calibration for process calibration. If Scaling has been chosen, the calibration curve of the sensor will be untouched, but the output signal of the sensor will be scaled. In case of calibration value <1%, the offset of the sensor output signal will be modified during scaling, for value >1% the slope of the sensor output will be adjusted. For further information about scaling refer to the sensor manual.

Pressing the [ENTER] key again will bring up the Save Changes dialog. Selecting No will discard the entered values and return to the measurement display screen, selecting Yes will save changes made.

### 8.2.3.6 Adjusting Sampling Rate for Optical Sensors

If during the channel setup (see section 8.2.1 "Channel Setup") the parameter O<sub>2</sub> Opt has been chosen the parameter O<sub>2</sub> opt sampling rate can be adjusted.

For doing this adjustment the menu "O<sub>2</sub> opt sampling rate" has to be chosen (see section 8.2.3 "Parameter Related Settings").



The time interval from one measuring cycle of the sensor to the other can be adjusted i.e. adapted to the application. A higher value will increase the life time of the OptoCap of the sensor.

Pressing the [ENTER] key will bring up the Save Changes dialog. Selecting No will discard the entered values and return to the measurement display screen, selecting Yes will save changes made.

### 8.2.3.7 LED Mode

If during the channel setup (see section 8.2.1 "Channel Setup") the parameter O<sub>2</sub> Opt has been chosen the parameters LED, T off, DI 1 LED control can be set resp. adjusted.

For doing these adjustments the menu "LED Mode" has to be chosen (see section 8.2.3 "Parameter Related Settings").



The operation mode for the LED of the sensor can be selected. There are the following options.

Off: LED is permanently switched off.

On: LED is permanently switched on.

Auto: The LED is switched on as long as the measured media temperature is smaller then Toff (see next value) or switched off thru the digital input signal (see over next value).

**NOTE:** If the LED is switched off, no oxygen measurement is performed.



Press [ENTER]



Depending on the measured media temperature the LED of the sensor can be automatically switched off. If the media temperature is higher then Toff, the LED will be switched off. The LED will be switched on as soon as the media temperature falls below Toff - 3K. This function give the option to increase the lifetime of the OptoCap by switching off the LED thru SIP or CIP cycles.

**NOTE:** This function is only active if the operation mode of the LED is set to "Auto".



Press [ENTER]



The operation mode of the sensor LED can also be influenced by the digital input signal DI1 of the transmitter. If the parameter "DI 1 LED control" is set to Yes, the LED is switched off, if DI1 is active. If "DI 1 LED control" is set to No, the signal of DI1 has now influence on the operation mode of the sensor LED.

This function is helpful for remote control of the sensor thru a SPS or DCS.

**NOTE:** This function is only active if the operation mode of the LED is set to "Auto".



Pressing the [ENTER] key will bring up the Save Changes dialog. Selecting No will discard the entered values and return to the measurement display screen, selecting Yes will save changes made.



### 8.2.3.8 Dissolved Carbon Dioxide Parameters

If during the channel setup (see section 8.2.1 "Channel Setup") the parameter CO<sub>2</sub> has been chosen, the parameters drift control, salinity, HCO<sub>3</sub>, TotPres and the displayed units for slope and zero point can be set resp. adjusted.

For doing this adjustment resp. settings the menu "CO<sub>2</sub>", that will be displayed, has to be chosen. (see section 8.2.3 "Parameter Related Settings")

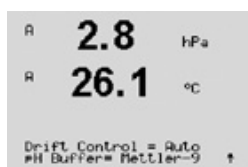

Select **Drift Control** for calibration as Auto (drift and time criteria have to be fulfilled) or manual (the user can decide when a signal is stable enough to complete calibration) followed by the relevant buffer table for the automatic buffer recognition. If the drift rate is less than 0.4 mV over a 19 second interval then the reading is stable and the calibration is done using the last reading. If the drift criteria is not met within 300 seconds then the calibration times out and the message "Calibration Not Done Press ENTER to Exit" is displayed.

For automatic **buffer recognition** during calibration, select the buffer Mettler-9. Use for calibration purposes solution with pH = 7.00 and/or pH = 9.21. If the auto buffer feature will not be used or if the available buffers are different from those above, select None. Press [ENTER] to go on.

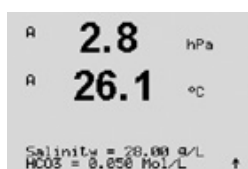

The **Salinity** describes the total amount of solved salts in the CO<sub>2</sub> electrolyte of the sensor connected to the transmitter. It is a sensor specific parameter. The default value (28.00 g/L) is valid for the InPro 5000. Do not change this parameter if the InPro 5000 will be used.

The parameter **HCO<sub>3</sub>** describes the concentration of hydrogen carbonate in the CO<sub>2</sub> electrolyte of the sensor connected to the transmitter. It is also a sensor specific parameter. The default value 0.050 Mol/L is valid for the InPro 5000. Do not change this parameter if the InPro 5000 will be used.

To go on press [ENTER] again.

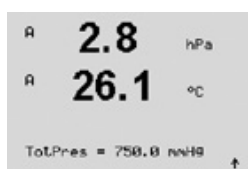

If the unit for the measured dissolved carbon dioxide is %sat, the pressure during the calibration resp. measurement has to be considered. This will be done by setting the parameter TotPres. If another unit than %sat has been selected, the result will not be influenced by this parameter.



The units for the slope and the zero point, that will be shown on the display can be chosen. The default setting for the unit of the slope is [%] and can be changed to [pH/mV]. For the zero point the default setting of the unit is [pH] and can be changed to [mV]. Use the ► key to move to the input field and select the unit by using the ▲ or ▼ key.

Pressing [ENTER] again will bring up the Save Changes dialog. Selecting No will discard the entered values and return to the measurement display screen, selecting Yes will save changes made.

## 8.2.4 Set Averaging

Enter Configuration Mode as described in section 8.1 "Enter Configuration mode" and select the menu Measurement (see section 8.2 "Configuration/Measurement").



Selected the menu "Set Averaging" by using the ▲ or ▼ key. Press [ENTER]

The averaging method (noise filter) for each measurement line can now be selected. The options are Special (Default), None, Low, Medium and High:



None = no averaging or filtering  
 Low = equivalent to a 3 point moving average  
 Medium = equivalent to a 6 point moving average  
 High = equivalent to a 10 point moving average  
 Special = averaging depending on signal change (normally High averaging but Low averaging for large changes in input signal)

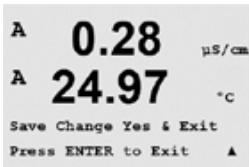

Pressing the [ENTER] key again will bring up the Save Changes dialog. Selecting No will discard the entered values and return to the measurement display screen, selecting Yes will save changes made.

## 8.3 Alarm/Clean

(PATH: Menu/Configure/Alarm/Clean)

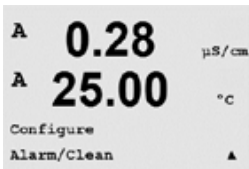

Enter configuration mode as described in section 8.1 "Enter Configuration Mode".

### 8.3.1 Alarm



This menu allows the configuration of alarm functionality for the display. Via FF interface you can read out the alarm status supplied by the Discrete Input Block. For more information see documentation "FOUNDATION fieldbus parameter Multi-parameter Transmitter M400 FF" on CD-ROM.

To select "Setup Alarm", press the ▲ or ▼ key. Confirm selection with [ENTER].



To select "Alarm event", press the ▲ or ▼ key. To navigate to "No/Yes", press the ◀ and ▶ keys. Confirm selection with [ENTER].

One of the following events may be alarmed:

1. Power failure
2. Software failure
3. Rg diagnostics – pH glass membrane resistance (only for pH,; pH/pNa Rg diagnostics detect both pH and pNa membrane glasses)
4. Rr diagnostics – pH reference resistance (only for pH sensors; except pH/pNa)
5. Cond cell open (only for analog cond 2-e/4-e sensors)
6. Cond cell shorted (only for analog cond 2-e/4-e sensors)
7. Channel B disconnected (only for ISM sensors)
8. Shaft error (only for optical sensors)
9. Signal error (only for optical sensors)
10. Hardware error (only for optical sensors)
11. Dry Cond sensor (only for ISM cond sensors)
12. Cell deviation (only for ISM cond sensors)
13. Electrolyte low (only for ISM amperometric oxygen sensors)

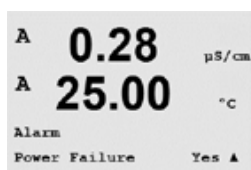

If any of these criteria are set to Yes and the conditions for an alarm are given, the flashing symbol  $\triangle$  will be shown in the display, an alarm message will be recorded (see also section 11.1 "Messages"; PATH: Info/Messages).

Via FF interface you can read out the alarm status supplied by the Discrete Input Block. For more information see documentation "FOUNDATION fieldbus parameter Multi-parameter Transmitter M400 FF" on CD-ROM.

The conditions for alarms are:

1. There is a power failure or power cycling
2. The software watchdog performs a reset
3. Rg is out of tolerance – for example, broken measuring electrode (only for pH; pH/pNa Rg diagnostics detect both pH and pNa membrane glasses)
4. Rr is out of tolerance – for example, coated or depleted reference electrode (only for pH sensors; except pH/pNa)
5. If the conductivity sensor is on air (for example in an empty pipe) (only for resistive conductivity sensors)
6. If the conductivity sensor has a short cut (only for resistive conductivity sensors)
7. If no sensor is connected on channel B (only for ISM sensors)
8. If the temperature is out of range, stray light is too high (e.g. because a glass fiber is broken) or the shaft has been removed (see also section 10.1 "Diagnostics"; PATH: Menu/Service/Diagnostics/O<sub>2</sub> optical) (only for optical sensors)
9. If the signal or the temperature value is out of range (see also section 10.1 "Diagnostics"; PATH: Menu/Service/Diagnostics/O<sub>2</sub> optical) (only for optical sensors)
10. If an hardware error has been detected (see also section 10.1 "Diagnostics"; PATH: Menu/Service/Diagnostics/O<sub>2</sub> optical). (only for optical sensors)
11. If the conductivity sensor is on air (for example in an empty pipe) (only for ISM Conductivity sensors)
12. Cell constant (multiplier) is out of tolerance, i.e. has changed too much compared to the value thru the factory calibration (only for ISM conductivity sensors)
13. Electrolyte in the membrane body reaches such a low level that the connection between cathode and reference is disturbed, an immediate action must be taken e.g. exchange and filling the electrolyte.

For 1 and 2 the alarm indicator will be turned off when the alarm message is cleared. It will reappear if the power is constantly cycling or if the watchdog is repeatedly resetting the system.

### Only for pH sensors

For 3 and 4 the alarm indicator will go off if the message is cleared and the sensor has been replaced or repaired so that the Rg and Rr values are within specification. If the Rg or Rr message is cleared and Rg or Rr is still out of tolerance then the alarm will stay on and the message will reappear. The Rg and Rr alarm can be turned off by going into this menu and setting Rg diagnostics and/or Rr diagnostics to No. The message can then be cleared and the alarm indicator will be off even though Rg or Rr is out of tolerance.

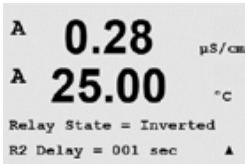

A 0.28  $\mu\text{S}/\text{cm}$   
 A 25.00  $^{\circ}\text{C}$   
 Relay State = Inverted  
 R2 Delay = 001 sec ▲

Pressing the [ENTER] key again will bring up the Save Changes dialog. Selecting No will discard the entered values, selecting Yes will make the entered values the current ones.



**NOTE:** There are additional alarms, which will be indicated in the display. See therefore in section 14 "Troubleshooting" the different warning- and alarm lists.

## 8.3.2 Clean



A 0.28  $\mu\text{S}/\text{cm}$   
 A 25.0  $^{\circ}\text{C}$   
 Setup Clean ▲

This menu allows the configuration of clean functionality for the display.

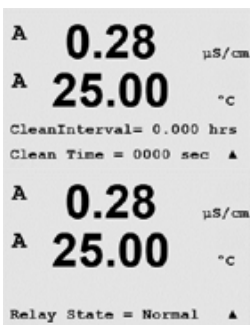

A 0.28  $\mu\text{S}/\text{cm}$   
 A 25.00  $^{\circ}\text{C}$   
 CleanInterval= 0.000 hrs  
 Clean Time = 0000 sec ▲  
 A 0.28  $\mu\text{S}/\text{cm}$   
 A 25.00  $^{\circ}\text{C}$   
 Relay State = Normal ▲

The cleaning interval can be set from 0.000 to 999.9 hours. Setting it to 0 turns the clean cycle off. The cleaning time can be 0 to 9999 seconds and must be smaller than the cleaning interval.

Pressing the [ENTER] key again will bring up the Save Changes dialog. Selecting No will discard the entered values and return to the measurement display screen, selecting Yes will save changes made.



**NOTE:** The clean functionality is also available via FF.

## 8.4 ISM Set Up (Available for pH, Oxygen and Dissolved Carbon Dioxid ISM Sensors)

(PATH: Menu/Configure/ISM Setup)

Enter Configuration mode as described in section 8.1. "Enter Configuration Mode" and navigate to the menu "ISM set up" by using the ▲ or ▼ key. Press [ENTER]

### 8.4.1 Sensor Monitoring



Select the menu "Sensor Monitoring" by pressing [ENTER].

The sensor monitoring options can be turned on or off. Via FF interface you can read out the sensor monitoring values supplied by the Discrete Input Block. The following option is possible:



**Lifetime indicator:** The dynamic lifetime indication allows an estimation, when the pH electrode or the inner body of an amperometric oxygen sensors is at the end of his lifetime, based on the actual stress he is exposed to. The sensor permanently takes the averaged stress of the past days into consideration and is able to increase/decrease the lifetime accordingly.

Lifetime Indicator	YES/NO
Alarm	YES/NO

The following parameters affect the lifetime indicator:

Dynamic parameters:	Static parameters:
– Temperature	– Calibration history
– pH or oxygen value	– Zero and Slope
– Glass impedance (only pH)	– CIP/SIP/Autoclaving cycles
– Reference impedance (only pH)	

The sensor keeps the information stored in the built in electronics and can be retrieved via a transmitter or the iSense asset management suite.

The alarm will be reset if the Lifetime Indicator is not 0 days anymore (e.g. after connecting a new sensor or changing on the measurement conditions).

For amperometric oxygen sensors, the lifetime indicator is related to the inner-body of the sensor. After exchanging the inner-body, reset the lifetime indicator as described in section 8.4.5 "Reset ISM Counter/Timer".

If the Lifetime Indicator is turned on, in the measuring mode the value will be automatically shown in the display on line 3.

Press [ENTER]



**Time to Maintenance:** This timer estimates when the next cleaning cycle should be performed to keep the best possible measurement performance. The timer is influenced by significant changes on the DLI parameters.

Time to Maintenance	YES/NO
Alarm	YES/NO

The time to maintenance can be reset to the initial value by the menu "Reset ISM Counter Timer" (see section 8.4.5 "Reset ISM Counter/Timer"). For amperometric oxygen sensors, the time to maintenance indicates a maintenance cycle for the membrane and electrolyte.

Press [ENTER]



Activation of the **Adaptive Cal Timer:** This timer estimates when the next calibration should be performed to keep the best possible measurement performance. The timer is influenced by significant changes on the DLI parameters.

Adaptive Cal Timer	YES/NO
Alarm	YES/NO

The Adaptive Calibration Timer will be reset to his initial value after a successful calibration. After a successful calibration will also be the alarm reset. If the Adaptive Cal Timer is turned on, the value will be automatically shown in the display on line 4.

Press [ENTER]



The initial value for Time to Maintenance as well as the Adaptive Calibration Timer can be modified according to the application experience and loaded down to the sensor.



**NOTE:** By connecting a sensor, the values for Time to Maintenance and/or Adaptive Calibration Timer are read out by the sensor.

Pressing the [ENTER] key again will bring up the Save Changes dialog. Selecting No will discard the entered values and return to the measurement display screen, selecting Yes will save changes made.

## 8.4.2 CIP Cycle Limit

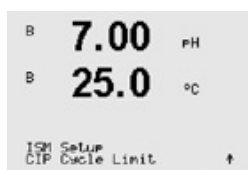

Navigate to the menu "CIP Cycle Limit" by using the ▲ and ▼ keys and press [ENTER].



The CIP cycle limit counts the number of CIP cycles. If the limit (user defined) is reached, an alarm is shown on the display. Via FF interface you can read out the CIP Cycle Limit supplied by the Discrete Input Block. The following option is possible:

CIP Max 000	Temp 055
Alarm	YES/NO

If the Max setting is on 000, the counter functionality is turned off. The alarm will be reset after exchanging the sensor. For oxygen sensors, the counter can be reset (see section 8.4.5 "Reset ISM Counter/Timer").

CIP characteristics: CIP Cycles will be automatically recognized by the sensor. Since CIP cycles will vary in intensity (duration and temperature) for each application the algorithm of the counter recognizes an increase of the measurement temperature above a adjustable limit (parameter **Temp** in °C). If the temperature does not decrease below the defined limit within the next 5 minutes after the temperature was reached, the counter in question will be incremented by one and also locked for the next two hours. In the case the CIP would last longer than two hours the counter would be incremented by one once more.

Pressing the [ENTER] key will bring up the Save Changes dialog. Selecting No will discard the entered values, selecting Yes will make the entered values the current ones.

## 8.4.3 SIP Cycle Limit



Navigate to the menu "SIP Cycle Limit" by using the ▲ and ▼ keys and press [ENTER].



The SIP cycle limit counts the number of SIP cycles. If the limit (user defined) is reached, an alarm can be indicated is shown on the display. Via FF interface you can read out the SIP Cycle Limit supplied by the Discrete Input Block. The following option is possible:

SIP Max 000	Temp 115
Alarm	YES/NO

If the Max setting is on 000, the counter functionality is turned off. The alarm will be reset after exchanging the sensor. For oxygen sensors, the counter can be reset (see section 8.4.5 "Reset ISM Counter/Timer").

SIP characteristics: SIP Cycles will be automatically recognized by the sensor. Since SIP cycles will vary in intensity (duration and temperature) for each application the algorithm of the counter recognizes an increase of the measurement temperature above a adjustable limit (parameter **Temp** in °C). If the temperature does not decrease below the defined limit within the next 5 minutes after the first temperature was reached, the counter in question will be incremented by one and also locked for the next two hours. In the case the SIP would last longer than two hours the counter would be incremented by one once more.

Pressing the [ENTER] key will bring up the Save Changes dialog. Selecting No will discard the entered values, selecting Yes will make the entered values the current ones.

## 8.4.4 Autoclaving Cycle Limit



**NOTE:** The transmitter recognizes the connected ISM sensor and offers this menu only if an auto-clavable sensor is connected.

Navigate to the menu "AutoClave Cycle Limit" by using the ▲ and ▼ keys and press [ENTER].

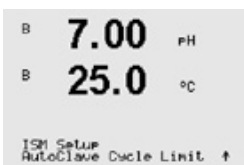

The Autoclaving Cycle Limit counts the number of autoclaving cycles. If the limit (user defined) is reached, an alarm can be indicated is shown on the display. Via FF interface you can read out the Autoclaving Cycle Limit supplied by the Discrete Input Block. The following option is possible:

```
Autoclave Max 000
Alarm          YES/NO
```

If the Max setting is on 000, the counter functionality is turned off. The alarm will be reset after exchanging the sensor. For oxygen sensors, the counter can also be reset manually (see section 8.4.5 "Reset ISM Counter/Timer").

Autoclave characteristics: Since during the autoclaving cycle the sensor is not connected to the transmitter, you will be asked after every sensor connection, whether the sensor was autoclaved or not. According to your selection, the counter will be incremented or not.

Pressing the [ENTER] key will bring up the Save Changes dialog. Selecting No will discard the entered values, selecting Yes will make the entered values the current ones.



## 8.4.5 Reset ISM Counter/Timer

This menu allows resetting counter and timer functions which cannot be reseted automatically. The adaptive calibration timer will be reseted after a successful adjustment or calibration.

Navigate to the menu "Reset ISM Counter/Timer" by using the ▲ and ▼ keys and press [ENTER].

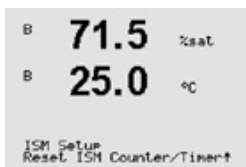

If an pH sensor or amperometric oxygen sensor is connected, the menu for resetting the Time To Maintenance is displayed. Time To Maintenance needs to be reset after the following operations.

pH sensors: manual maintenance cycle on the sensor.  
 oxygen sensor: manual maintenance cycle on the sensor or exchanging of the inner-body or membrane of the sensor

[Press ENTER]



If an oxygen sensor is connected, the menu for resetting the CIP and SIP counter is displayed. These counters should be reset after the following operations.

amperometric sensor: exchanging of the inner-body of the sensor.

[Press ENTER]



## 8.4.6 DLI Stress Adjustment (Only for pH ISM Sensors)

Through this menu the calculation of the diagnostic data DLI, TTM and ACT can be adapted to application requirements and/or experience.



**NOTE:** The function is only available for pH ISM sensors with corresponding firmware versions.

Navigate to the menu "DLI Stress Adjustment" by using the ▲ and ▼ keys and press [ENTER].

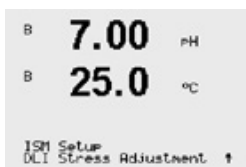

Adjust the Process Stress parameter based on the particular application and/or requirements

Low: DLI, TTM and ACT will be increased approximately 25% compared with "Medium".  
 Medium: Default value, (equal DLI, TTM and ACT values based on former firmware versions of the transmitter).

High: DLI, TTM and ACT will be reduced approximately 25% compared with "Medium".

Pressing the [ENTER] key will bring up the Save Changes dialog. Selecting No will discard the entered values, selecting Yes will make activate entered values.

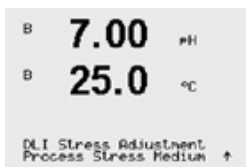

## 8.5 Display

(PATH: Menu/Configure/Display)

Enter configuration mode as described in section 8.1 "Enter Configuration Mode".

This menu allows for the configuration of the values to be displayed and also the configuration of the display itself.



### 8.5.1 Measurement

The display has 4 lines. Line 1 on top and Line 4 on the bottom.

Select the values (Measurement a, b, c or d) to be displayed on each line of the display.

The selection of the values for a, b, c, d needs to be done under Configuration/measurement/Channel Setup.



Select the "Error Display" mode. If this is set to "On" when an alarm or warning has occurred, the message "Failure – Press ENTER" will be displayed on Line 4 when an alarm occurs in the normal measurement mode.

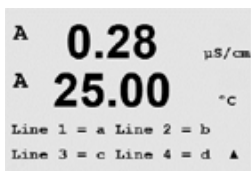

Pressing the [ENTER] key again will bring up the Save Changes dialog. Selecting No will discard the entered values, selecting Yes will make the entered values the current ones.



### 8.5.2 Resolution

This menu allows the setting of the resolution of each displayed value.

The accuracy of the measurement is not effected by this setting.

Possible settings are 1, 0.1, 0.01, 0.001 or Auto.

Pressing the [ENTER] key will bring up the Save Changes dialog.

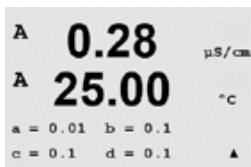

### 8.5.3 Backlight

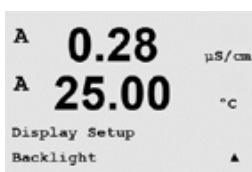

This Menu allows the setting of the back light options of the display.



Possible settings are On, On 50% or Auto Off 50%. If Auto Off 50% is selected then the backlight will go to 50% after 4 minutes with no keypad activity. The backlight will automatically come back on if a key is pressed.

Pressing the [ENTER] key will bring up the Save Changes dialog.

### 8.5.4 Name



This menu allows for the configuration of an alpha-numeric name which is displayed in the first 9 characters on lines 3 and 4 of the display. The default is nothing (blank).

If a name is entered on line 3 and/or 4 a measurement can be still displayed on the same line.



Use the ◀ and ▶ keys to navigate between digits to be altered. Using the ▲ and ▼ keys to change the character to be displayed. Once all digits of both display channels have been entered, press [ENTER] to bring up the Save Changes dialog.



The resulting display in the measurement mode appears on lines 3 and 4 ahead of the measurements.

### 8.5.5 ISM Sensor Monitoring (Available when ISM Sensor Connected)

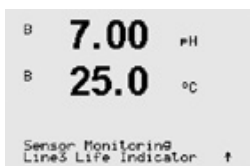

The sensor monitoring allows you to display the sensor monitoring details on line 3 and 4 in the display. The following options are possible:

Line 3 Off/Time Indicator/Time to Maint/Adapt Cal Timer  
Line 4 Off/Time Indicator/Time to Maint/Adapt Cal Timer

## 8.6 Hold Outputs

(PATH: Menu/Configure/Hold Outputs)



Enter configuration mode as described in section 8.1 "Enter Configuration Mode".

The **"Hold outputs"** function applies during the calibration process. If set "Hold outputs" to Yes, during calibration process the corresponding Analog Input of the FF interface will be at hold state. The hold state depends on the setting. For the possible hold settings, see the list below. The following options are possible:



Hold Outputs?      Yes/No

## 9 System

(PATH: Menu/System)

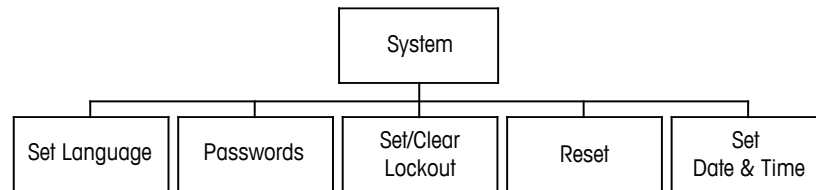

While in measurement mode press the ◀ key. Press the ▼ or ▲ key to navigate to “System” – Menu and press [ENTER].

### 9.1 Set Language

(PATH: Menu/System/Set Language)

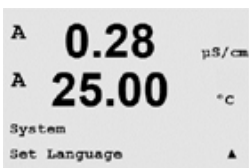

This menu allows the configuration of the display language.

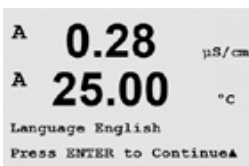

The following selections are possible:  
English, French, German, Italian, Spanish, Portuguese, Russian or Japanese (Katakana).

Pressing the [ENTER] key will bring up the Save Changes dialog.

### 9.2 Passwords

(PATH: Menu/System/Passwords)

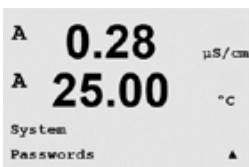

This menu allows for the configuration of operator and administrator passwords, as well as setting up a list of allowed menus for the operator. The administrator has rights to access all menus. All default passwords for new transmitters are “00000”.

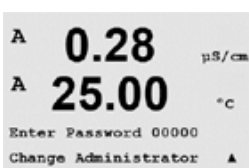

The passwords menu is protected: Enter the administrator password to enter the menu.

## 9.2.1 Changing Passwords

```

A 0.28  μS/cm
A 25.00 °C
Change Administrator
New Password = 00000 ▲

```

See section 9.3 on how to enter the passwords menu. Select Change Administrator or Change Operator and set the new password.

```

A 0.28  μS/cm
A 25.00 °C
Re-enter password
New Password = 00000 ▲

```

Press the [ENTER] key and confirm the new password. Press [ENTER] again to bring up the Save Changed dialog.

## 9.2.2 Configuring Menu Access for Operator

```

A 0.28  μS/cm
A 25.00 °C
Enter Password 00000
Configure Operator ▲

```

See 9.3 on how to enter the passwords Menu. Select Configure Operator to configure the access list for the operator. It is possible to assign/deny rights to the following menus: Cal Key, Quick Setup, Configuration, System, PID Setup and Service.

```

A 0.28  μS/cm
A 25.00 °C
Cal Key Yes
Quick Setup Yes ▲

```

Choose either Yes or No to give/deny access to the above menus and press [ENTER] to advance to the next items. Pressing the [ENTER] key after configuring all menus will bring up the Save Changes dialog. Selecting No will discard the entered values, selecting Yes will make the entered values the current ones.

## 9.3 Set/Clear Lockout

(PATH: Menu/System/Set/Clear Lockout)

```

A 0.28  μS/cm
A 25.00 °C
System
Set/Clear Lockout ▲

```

This menu enables/disables the lockout functionality of the transmitter. The user will be asked for a password before being allowed into any menus if the lockout functionality is enabled.

```

A 0.28  μS/cm
A 25.00 °C
Password = 00000
Enable Lockout = Yes ▲

```

The lockout-menu is protected: Enter the administrator or operator password and select YES to enable or NO to disable the lockout functionality. Pressing the [ENTER] key after the selection will bring up the Save Changes dialog. Selecting No will discard the entered value, selecting Yes will make the entered value the current one.

## 9.4 Reset

(PATH: Menu/System/Reset)



**NOTE:** A reset performed via display, also resets the corresponding FF parameters to factory default setting. For more information see documentation "FOUNDATION fieldbus parameter Multi-parameter Transmitter M400 FF" on CD-ROM.

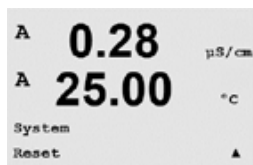

This menu allows access to the following options:

Reset System, Reset Meter Cal, Reset Analog Cal.

### 9.4.1 Reset System

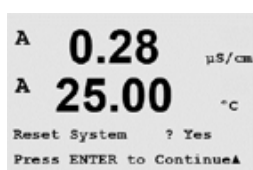

This menu allows the reset of the meter to the factory default settings. The meter calibration is not affected.

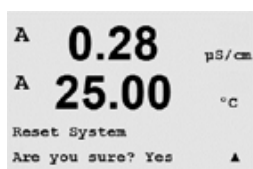

Pressing the [ENTER] key after the selection will bring up a confirmation screen. Selecting No will return the user to the measurement mode with no changes. Selecting Yes will reset the meter.

### 9.4.2 Reset Meter Calibration

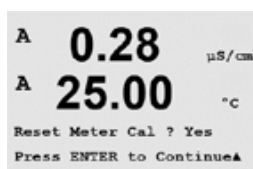

This menu allows the reset of the meter's calibration factors to the last factory calibration values.

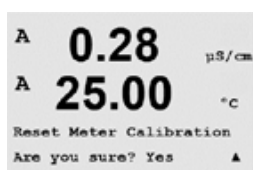

Pressing the [ENTER] key after the selection will bring up a confirmation screen. Selecting No will return the user to the measurement mode with no changes. Selecting Yes will reset the meter calibration factors.

## 9.5 Set Date & Time



Please enter the actual date and time. The following options are possible. This function is automatically activated at every power-up.

Date (YY-MM-DD):

Time (HH:MM:SS):

## 10 Service

(PATH: Menu/Service)

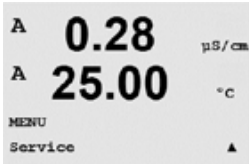
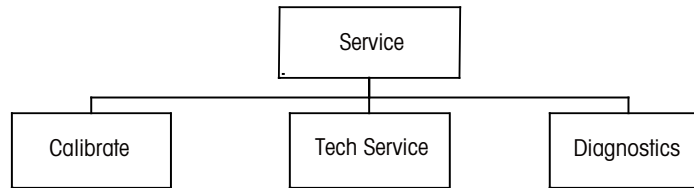

While in measurement mode press the ◀ key. Press the ▲ or ▼ key to navigate to the “Service” menu and press [ENTER]. The available system configuration options are detailed below.

### 10.1 Diagnostics

(PATH: Menu/Service/Diagnostics)



This menu is a valuable tool for troubleshooting and provides diagnostic functionality for the following items: Model/Software Revision, Display, Keypad, Memory, Read Analog Inputs, O<sub>2</sub> Optical.

#### 10.1.1 Model/Software Revision

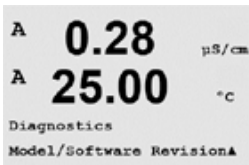

Essential information for every Service call is the model and software revision number. This menu shows the part number, model and the serial number of the transmitter. By using the ▼ key it is possible to navigate forward through this menu and get additional information like the current version of firmware implemented on the transmitter: (Master V\_XXXX and Comm V\_XXXX); and – if an ISM sensor is connected – the version of the sensor firmware (Sensor FW V\_XXX) and sensor hardware (Sensor HW XXXX).

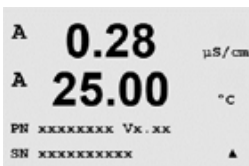

Press [ENTER] to exit from this display.

#### 10.1.2 Display

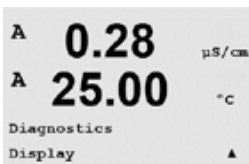

All pixels of the display will be lit for 15 seconds to allow troubleshooting of the display. After 15 seconds the transmitter will return to the normal measuring mode or press [ENTER] to exit sooner.



### 10.1.3 Keypad



For keypad diagnostics, the display will indicate which key is pressed. Pressing [ENTER] will return the transmitter to the normal measuring mode.

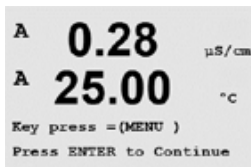

### 10.1.4 Memory

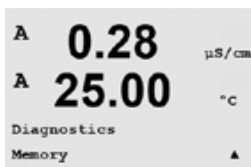

If Memory is selected then the transmitter will perform a RAM and ROM memory test. Test patterns will be written to and read from all RAM memory locations. The ROM checksum will be recalculated and compared to the value stored in the ROM.

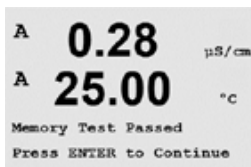

### 10.1.5 Read Analog Inputs



This menu shows the mA value of the analog input.

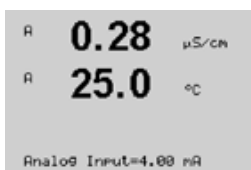

Press [ENTER] to exit from this display.

### 10.1.6 O<sub>2</sub> Optical



This menu shows the state and conditions regarding the optical O<sub>2</sub> sensor. By using the key ▲ or ▼ it is possible to navigate through this menu and get additional information. Press [ENTER] to exit from this display.

## 10.2 Calibrate

(PATH: Menu/Service/Calibrate)

Enter Service Menu as described in section 10 "Service", select Calibrate, and press [ENTER].

This menu has the options to calibrate the transmitter and the analog inputs and also allows the unlocking of calibration functionality.



### 10.2.1 Calibrate Meter (Only for Channel A)

The M400 transmitter is factory calibrated within specifications. It is not normally necessary to perform meter re-calibration unless extreme conditions cause an out of spec operation shown by Calibration Verification. Periodic verification/re-calibration may also be necessary to meet Q.A. requirements. Meter calibration can be selected as current (used for most dissolved oxygen, Voltage, Rg Diagnostic, Rr Diagnostic (used for pH), and temperature (used for all measurements).

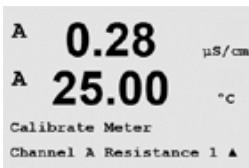

#### 10.2.1.1 Resistance

The meter is equipped with five (5) internal ranges of measurement on each channel. Each resistance range and temperature is calibrated separately, with each resistance range consisting of a two-point calibration.

Below is a table showing the resistance values for all calibration ranges.

Range	Point 1	Point 2	Point 4
Resistivity 1	1.0 Mohms	10.0 Mohms	–
Resistivity 2	100.0 Kohms	1.0 Mohms	–
Resistivity 3	10.0 Kohms	100.0 Kohms	–
Resistivity 4	1.0 Mohms	10.0 Kohms	–
Resistivity 5	100 Ohms	1.0 Mohms	–
Temperature	1000 Ohms	3.0 Kohms	66 Kohms

It is recommended that both calibration and verification be performed using the M400 Calibrator Module Accessory (refer to accessory list, in section 15). Instructions on the use of this accessory are provided with the calibrator module.



Navigate to the Calibrate Meter screen and select Channel A or B, and Resistance 1, designating that the transmitter is ready to calibrate the first range resistor. This resistance may be changed, selecting range 1 thru 5. Each resistance range consists of a two-point calibration.

Press [ENTER] to begin the calibration process.

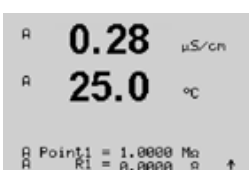

The first text line will ask for the Point 1 resistance value (this will correspond to Resistance 1 value shown on the Calibration Module Accessory). The second text line will show the measured resistance value. When the value stabilizes, press [ENTER] to perform calibration.

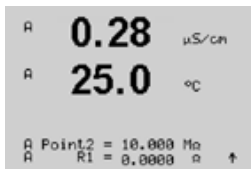

The transmitter screen will then prompt the user to enter the value for Point 2, and R1 will display the measured resistance value. When this value stabilizes, press [ENTER] to calibrate this range and bring up a confirmation screen.

Select Yes to save the calibration values and the successful Calibration is confirmed on the display. The transmitter will return to the Measurement mode in approximately 5 seconds.

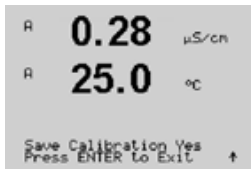

Once point 1 and 2 are calibrated, return to the Calibrate Meter screen. Move the cursor to change to Resistance 2, designating the second calibration range. Proceed with the two-point calibration process as performed for the first range. This same process must be followed to complete the resistance calibration of all 5 ranges.

### 10.2.1.2 Temperature

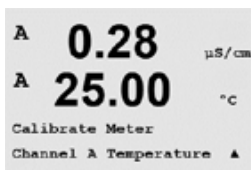

Temperature is performed as a three point calibration. The table above shows the resistance values of these three points.

Navigate to the Calibrate Meter screen and choose Temperature calibration for Channel A.

Press [ENTER] to begin temperature calibration process.

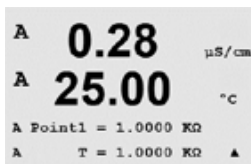

The first text line will ask for the Point 1 temperature resistance value (this will correspond to temperature 1 value shown on the calibration module accessory). The second text line will show the measured resistance value. When the value stabilizes, press [ENTER] to perform calibration.

The transmitter screen will then prompt the user to enter the value for Point 2, and T2 will display the measured resistance value. When this value stabilizes, press [ENTER] to calibrate this range.

Repeat these steps for Point 3.

Press [ENTER] to bring up a confirmation screen. Select Yes to save the calibration values and the successful calibration is confirmed on the display.

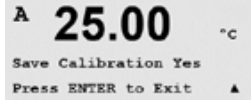

The transmitter will return to the measurement mode in approximately 5 seconds.

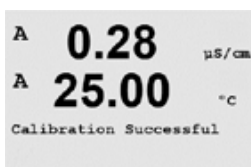

### 10.2.1.3 Current

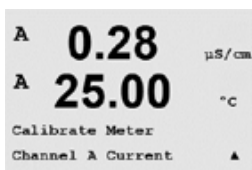

Current calibration is performed as a two-point calibration.

Navigate to the Calibrate Meter screen and select Channel A.

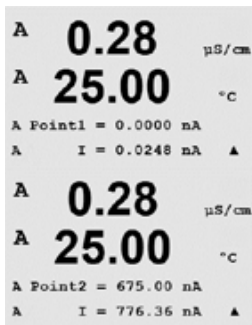

Enter the value for Point 1, in milliamps, of the current source connected to the input. The second display line will show the measured current. Press [ENTER] to begin the calibration process.

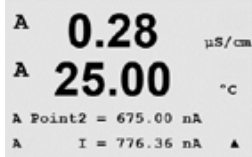

Enter the value for Point 2, in milliamps, of the current source connected to the input. The second display line shows the measured current.

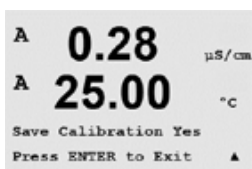

Pressing the [ENTER] key after entering Point 2 will bring up a confirmation screen. Select Yes to save the calibration values and the successful calibration is confirmed on the display. The transmitter will return to the measurement mode in approximately 5 seconds.



**NOTE:** Depending on the range of the measured current of the connected oxygen sensor, select the input range which has to be calibrated. Select Current1 for an input signal 0 to approx. –750 nA and Current2 for an input signal 0 to approx. –7500 nA.

### 10.2.1.4 Voltage

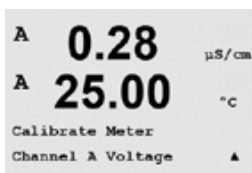

Voltage calibration is performed as a two-point calibration.

Navigate to the Calibrate Meter screen and select Channel A and Voltage.

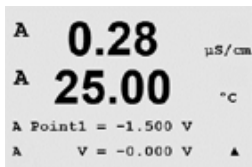

Enter the value for Point 1 in, volts, connected to the input. The second display line will show the measured voltage. Press [ENTER] to begin the calibration process.

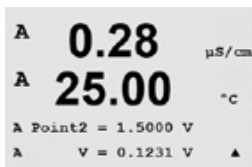

Enter the value for Point 2, in volts, of the source connected to the input. The second display line shows the measured voltage.

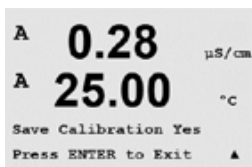

Pressing the [ENTER] key after entering Point 2 will bring up a confirmation screen. Select Yes to save the calibration values and the successful Calibration is confirmed on the display. The transmitter will return to the measurement mode in approximately 5 seconds.

### 10.2.1.5 Rg Diagnostic

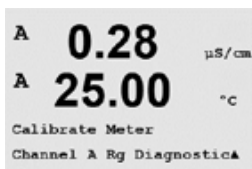

Rg diagnostic is performed as a two-point calibration. Navigate to the Calibrate Meter screen and select Channel A and Rg Diagnostic.

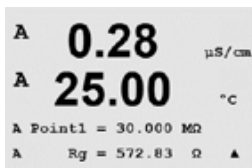

Enter the value for Point 1 of the calibration according to the resistor connected across the pH glass electrode measuring input. Press [ENTER] to begin the calibration process.

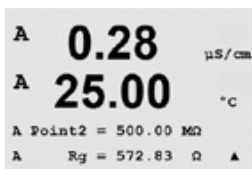

Enter the value for Point 2 of the calibration according to the resistor connected across the pH glass electrode measuring input.

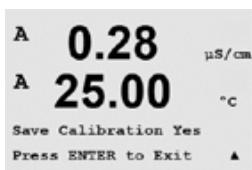

Pressing the [ENTER] key after entering Point 2 will bring up a confirmation screen. Select Yes to save the calibration values and the successful calibration is confirmed on the display. The transmitter will return to the measurement mode in approximately 5 seconds.

### 10.2.1.6 Rr Diagnostic

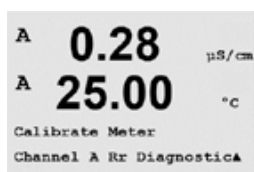

Rr diagnostic is performed as a two-point calibration. Navigate to the Calibrate Meter screen and select Channel A and Rr Diagnostic.



Enter the value for Point 1 of the calibration according to the resistor connected across the pH reference measuring input. Press [ENTER] to begin the calibration process.



Enter the value for Point 2 of the calibration according to the resistor connected across the pH reference measuring input.

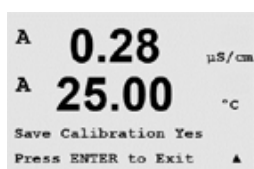

Pressing the [ENTER] key after entering Point 2 will bring up a confirmation screen. Select Yes to save the calibration values and the successful calibration is confirmed on the display. The transmitter will return to the measurement mode in approximately 5 seconds.

### 10.2.1.7 Calibrate Analog Input Signal



The analog input can be calibrated at two current values e.g. 4 mA and 20 mA.



Connect an accurate milliamp meter to the analog input terminals. Enter the value for Point 1, e.g. 4 mA value. The second line shows the measured current.

Press [Enter] to go on.

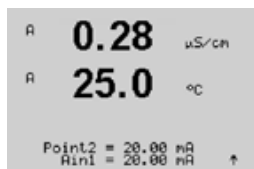

Enter the value for Point 2, e.g. 20 mA value

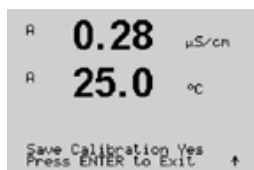

Pressing the [ENTER] key after entering Point 2 will bring up a confirmation screen. Selecting No will discard the entered values, selecting Yes will make the entered values the current ones.

## 10.2.2 Calibrate Unlock



Select this Menu to configure the CAL Menu, see section 7.

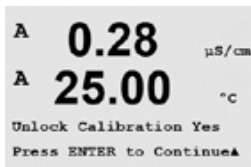

Selecting Yes means that meter calibration menus will be selectable under the CAL Menu. Selecting No means that only the sensor calibration is available under the CAL Menu. Press [ENTER] after the selection to display a confirmation screen.

## 10.3 Tech Service

(PATH: Menu/Tech Service)



**NOTE:** This menu is for METTLER TOLEDO service personnel use only.

# 11 Info

(PATH: Info)

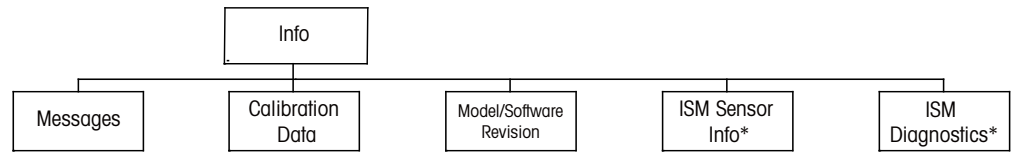

\* Only available in combination with ISM sensors

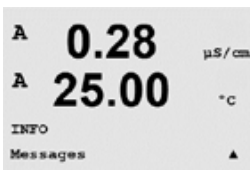

Pressing the ▼ key will display the Info menu with the options Messages, Calibration Data and Model/Software Revision.

## 11.1 Messages

(PATH: Info/Messages)

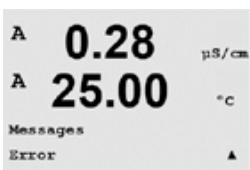

The most recent message is displayed. The up and down arrow keys allow scrolling through the last four messages that have occurred.

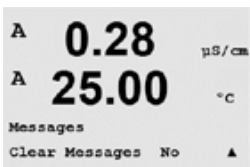

Clear Messages clears all the messages. Messages are added to the message list when the condition that generates the message first occurs. If all messages are cleared and a message condition still exists and started before the clear then it will not appear in the list. For this message to re-occur in the list the condition must go away and then reappear.

Press [ENTER] to exit from this display.

## 11.2 Calibration Data

(PATH: Info/Calibration Data)

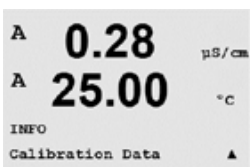

Selecting Calibration Data displays the calibration constants for each sensor.



P = calibration constants for the primary measurement  
S = calibration constants for the secondary measurement

Press ▼ for ORP calibration data of ISM pH sensors.

Press [ENTER] to exit from this display.



## 11.3 Model/Software Revision

(PATH: Info/Model/Software Revision)

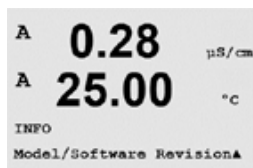

Selecting Model/Software Revision will display the part number, model and the serial number of the transmitter.

By using the ▼ key it is possible to navigate forward through this menu and get additional information like the current version of firmware implemented on the transmitter (Master V\_XXXX and Comm V\_XXXX) and – if an ISM sensor is connected – the version of the sensor firmware (Sensor FW V\_XXX) and sensor hardware (Sensor HW XXXX).

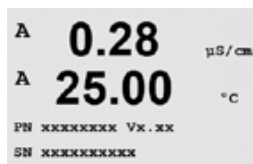

The displayed information is important for any Service call. Press [ENTER] to exit from this display.

## 11.4 ISM Sensor Info (Available when ISM Sensor Connected)

(PATH: Info/ISM Sensor Info)

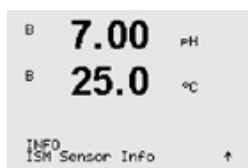

After plugging in an ISM sensor it is possible by using the key ▲ or ▼ to navigate to the Menu "ISM Sensor Info".

Press [ENTER] to select the menu.

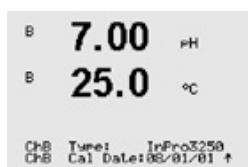

The following information about the sensor will be shown in this menu. Use up and down arrows to scroll in the menu. Type: Type of sensor (e.g. InPro 3250)

Cal Date: Date of the last adjustment

Serial-No.: Serial number of the connected sensor

Part-No.: Part number of the connected sensor

Press [ENTER] to exit from this display.

## 11.5 ISM Sensor Diagnostics (Available when ISM Sensor Connected)

(PATH: Info/ISM Diagnostics)

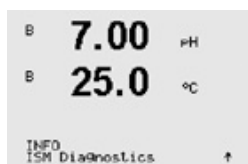

After plugging in an ISM sensor it is possible by using the key ▲ or ▼ to navigate to the Menu "ISM Diagnostics".

Press [ENTER] to select the menu.

Navigate to one of the menus, described in this section, and press [ENTER] again.

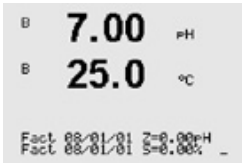

### Cal History

The calibration history is stored with a time stamp in the ISM sensor and is displayed on the transmitter. The calibration history offers the following information:

**Fact (Factory calibration):** This is the original dataset, determined in the factory. This dataset remains stored in the sensor for reference and cannot be overwritten.

**Act (Actual adjustment):** This is the actual calibration dataset which is used for the measurement. This dataset moves to Cal2 position after the next adjustment.

**1. Adj (First adjustment):** This is the first adjustment after the factory calibration. This dataset remains stored in the sensor for reference and cannot be overwritten

**Cal1 (last calibration/adjustment):** This is the last executed calibration/adjustment. This dataset moves to Cal2 and then to Cal3 when a new calibration/adjustment is performed. Afterwards, the dataset is not available anymore.

Cal2 and Cal3 acting in the same way as Cal1.

Definition:

**Adjustment:** The calibration procedure is completed and the calibration values are taken over and used for the measurement (Act) and stated in Cal1. The current values from Act will move to Cal2.

**Calibration:** The calibration procedure is completed, but the calibration values will not be over-taken and the measurement continuous with the last valid adjustment dataset (Act). The dataset will be stored under Cal1.

The calibration history is used for the estimation of the lifetime indicator for ISM sensors.

Press [ENTER] to exit from this display.



**NOTE:** This function requires the correct setting of date and time during calibration and/or adjustment tasks (see section 9.5 "Set Date & Time").

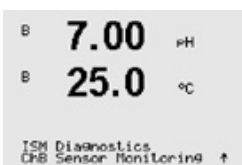

### Sensor monitoring (not available for Cond 4-e sensor)

The sensor monitoring shows the different diagnostics functions available for each ISM sensor. The following information is available:

**Lifetime Indicator:** Shows an estimation of the remaining lifetime to ensure a reliable measurement. The lifetime is indicated in days (d) and percentage (%). For a description of the Lifetime indicator, please see section 8.4 "ISM Set Up (Available for pH, Oxygen and Dissolved Carbon Dioxid ISM Sensors)". For oxygen sensors, the lifetime indicator is related to the inner-body of the sensor. If you want to bring the bar indicator on the screen, see section 8.4 to activate ISM functions.

**Adaptive Cal Timer:** This timer shows a Adaptive Cal Timer, when the next calibration should be performed to keep the best possible measurement performance. The Adaptive Cal Timer is indicated in days (d) and percentage (%). For a description of the Adaptive Cal Timer, please see section 8.4.



**Time to Maintenance:** This timer shows a Time to Maintenance, when the next cleaning cycle should be performed to keep the best possible measurement performance. The Time to Maintenance is indicated in days (d) and percentage (%). For a description of the Time to Maintenance, please see section 8.4. For oxygen sensors, the Time to Maintenance indicates a maintenance cycle for the membrane and electrolyte.

Press [ENTER] to exit from this display.

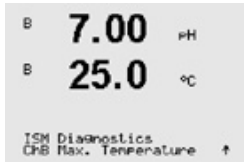

### Max. Temperature

The maximum temperature shows the maximum temperature that this sensor has ever seen, together with a time stamp of this maximum. This value is stored on the sensor and cannot be changed. During autoclaving the Max temperature is not recorded.

Max. Temperature

Tmax           XXX°CYY/MM/DD

Press [ENTER] to exit from this display.



**NOTE:** This function requires the correct setting of date and time of the transmitter, (see section "9.5 "Set Date & Time")



### CIP Cycles

Shows the amount of CIP cycles that the sensor has been exposed to. For a description of the CIP Cycle indicator, please see section 8.4.

CIP Cycles   xxx of xxx

Press [ENTER] to exit from this display.



### SIP Cycles

Shows the amount of SIP cycles that the sensor has been exposed to. For a description of the SIP Cycle indicator, please see section 8.4.

SIP Cycles   xxx of xxx

Press [ENTER] to exit from this display.

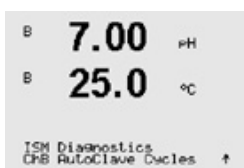

### Autoclaving Cycles

Shows the amount of Autoclaving cycles that the sensor has been exposed to. For a description of the AutoClave Cycle indicator, please see section 8.4.

Autoclaving Cycles       xxx of xxx

Press [ENTER] to exit from this display.

# 12 FOUNDATION Fieldbus Interface

## 12.1 General

### 12.1.1 System Architecture

The following diagram shows typical examples of a FOUNDATION fieldbus network with the associated components.

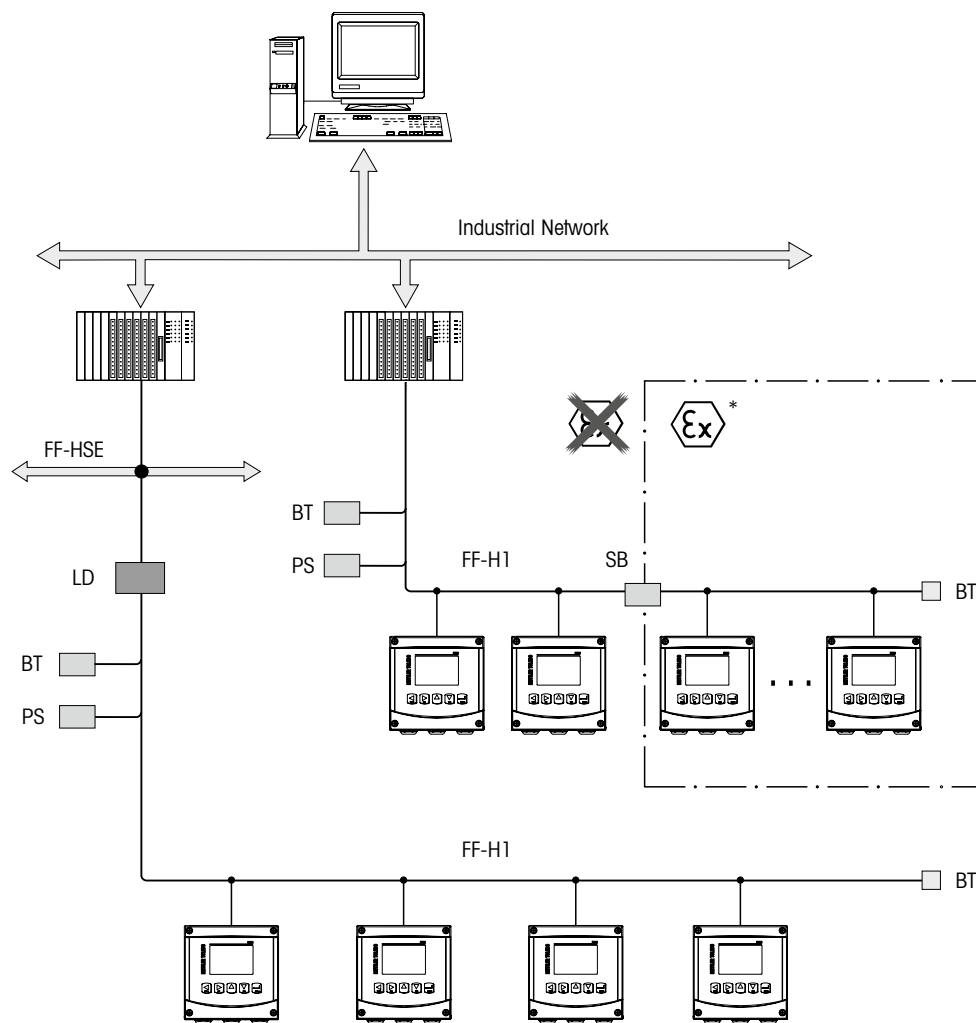

\* Pending

- FF-HSE FOUNDATION fieldbus High Speed Ethernet
- FF-H1 FOUNDATION fieldbus H1
- LD Linking device FF-HSE/FF-H1
- BT Bus termination
- PS Bus power supply
- SB Safety barrier

## 12.2 M400 FF Block Model

With FF, all the instrument parameters are categorized according to their functional properties and task and are generally assigned to three different blocks.

A FF instrument has the following block types:

### **A Resource Block (device block)**

This block contains all the device-specific features of the device.

### **Two Transducer Blocks**

The "General Transducer Block" contains all the measuring and instrument-specific parameters of the instrument. The "Sensor Transducer Block" contains the measuring principles and the sensor-specific parameters.

### **One or more function blocks**

Function blocks contain the automation functions of the instrument. There are different function blocks such as the Analog Input Block or Discrete Input Block. Each of these function blocks is used to execute different application functions.

The function blocks can be connected by means of an FF configuration program, depending on the automation task. The instrument thus takes on simple control functions, thereby relieving the workload on the higher-order process control system.

M400 FF contains the following blocks:

- Resource Block (device block)
- 2 Transducer Blocks
- 10 Function Blocks: 4 Analog Input Blocks (AI), 1 Analog Output Block (AO), 2 Discrete Input Block (DI), 2 Discrete Output Block (DO), 1 PID

### 12.2.1 Block Configuration

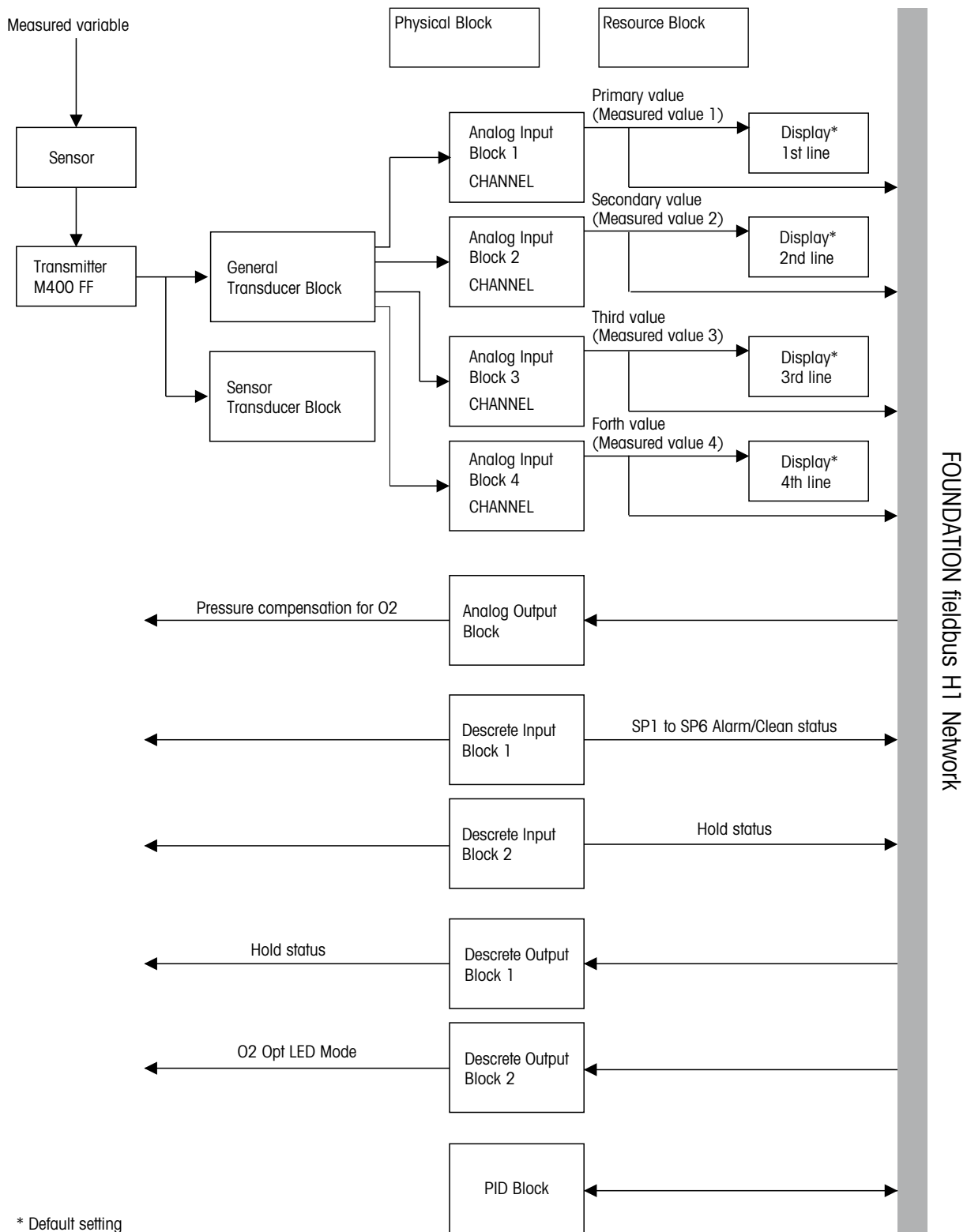

**NOTE:** If a reset by means of the RESTART parameter, "Default" option in the Resource Block is performed, the links between the blocks are deleted and the FF parameters are reset to the default values.

## 12.3 Commissioning

### 12.3.1 Network Configuration

You require the following to configure an instrument and integrate it into an FF network:

- An FF configuration program
- The cff file (Common File Format: \*.cff, \*.fhx)
- The device description (DD: \*.sym, \*.ffo)

Pre-defined standard DDs, which can be obtained from FF, are available for the basic functions of instruments. You require the device-specific DD to be able to access all the functions. The device description is provided on the supplied CD-ROM "METTLER TOLEDO M400 FF Transmitter Series, Operation Documentation".

The files for M400 FF can also be acquired as follows:

- Internet METTLER TOLEDO: <http://www.mt.com/m400-2wire>
- Internet FOUNDATION fieldbus: <http://www.fieldbus.org>

The instrument is integrated into the FF network as follows:

- Start the FF configuration program.
- Download the cff file and device description files (ffo, \*.sym, \*.cff or \*.fhx files) to the system.
- Configure the interface.
- Configure the instrument for the measuring task and for the FF system.



**NOTE:** For further information on integrating the instrument into the FF system, see the description for the configuration software used.

When integrating the instrument into the FF system, ensure you are using the right files. You can read out the required version by means of the DEV\_REV and DD\_REV parameters in the Resource Block.

### 12.3.2 Identification and Addressing

The instrument is identified by the FF in the host or configuration system via the device ID (DEVICE\_ID). The DEVICE\_ID is a combination of the manufacturer ID, instrument and instrument serial number. It is unique and can never be duplicated.

The instrument appears in the network display once you have started the FF configuration program and integrated the instrument into the network. The blocks available are displayed under the instrument name.

M400 FF reports as follows:

METTLER TOLEDO: 465255  
Device type (M400 FF): 0400  
Instrument serial number: xxxxxx (see Certificate)

### 12.3.3 Commissioning via an FF Configuration Program

You can obtain special configuration and operating programs from various manufacturers for the configuration. These configuration programs make it possible to configure FF functions and all the instrument-specific parameters. The pre-defined function blocks allow uniform access to all the network and instrument data. For further information see the appropriate Operating Instructions of the configuration program used.

1. Switch on transmitter.
2. Note the DEVICE\_ID. See nameplate.
3. Open the FF configuration program.
4. Load cff file and device description files into the host system or the configuration program. Ensure you use the correct system files.  
The first time the instrument is connected the instrument reports as follows:
  - MT\_M400\_xxxxxx (Tag name PD\_TAG)
  - 4652550400-xxxxxx (DEVICE\_ID)
 If the device description has not yet been loaded, the blocks report "Unknown" or "(UNK)".

Display text	Register address	Description
RESOURCE_4652550400-xxxxxx		Resource Block
TRANSDUCER_GENERAL_4652550400-xxxxxx	500	"General" Transducer Block
TRANSDUCER_SENSOR_4652550400-xxxxxx	1000	"Sensor" Transducer Block
ANALOG_INPUT_1_4652550400-xxxxxx		Analog Input Block 1
ANALOG_INPUT_2_4652550400-xxxxxx		Analog Input Block 2
ANALOG_INPUT_3_4652550400-xxxxxx		Analog Input Block 3
ANALOG_INPUT_4_4652550400-xxxxxx		Analog Input Block 4
ANALOG_OUTPUT_4652550400-xxxxxx	200	Analog Output Block 1
DESCRETE_INPUT_1_4652550400-xxxxxx		Discrete Input Block 1
DESCRETE_INPUT_2_4652550400-xxxxxx		Discrete Input Block 2
DESCRETE_OUTPUT_1_4652550400-xxxxxx	100	Discrete Output Block 1
DESCRETE_OUTPUT_2_4652550400-xxxxxx		Discrete Output Block 2



**NOTE:** This instrument is supplied with the bus address "247". The LAS (Link Active Scheduler) automatically assigns the device a free bus address in the initialization phase.

5. Identify the instrument using the DEVICE\_ID. Assign the desired tag name to the instrument by means of the PD\_TAG parameter.

#### Configuring the Resource Block

1. Open the Resource Block.
2. If necessary, change the block name. Default setting: RESOURCE\_4652550400-xxxxxx
3. If necessary, assign a description to the block by means of the TAG\_DESC parameter.
4. If necessary, change other parameters as per the requirements.



### Configuring the Transducer Block

The M400 FF contains one "General" Transducer Block and one "Sensor" Transducer Block.

1. If necessary, change the block name. Default setting: TRANSDUCER\_GENERAL\_4652550400-xxxxxx
2. Set the block mode to OOS using the MODE\_BLK parameter, TARGET element.
3. Set SENSOR\_TYPE and SENSOR\_CHANNEL parameter to select the correct sensor.
4. Configure the block in accordance with the measuring task.
5. Set the block mode to Auto using the MODE\_BLK parameter, TARGET element.
6. If necessary, change the block name. Default setting: TRANSDUCER\_SENSOR\_4652550400-xxxxxx
7. Set the block mode to OOS using the MODE\_BLK parameter, TARGET element.
8. Configure the block in accordance with the measuring task.
9. Set the block mode to Auto using the MODE\_BLK parameter, TARGET element.



**NOTE:** So the instrument is working correctly, the Transducer Block mode must be set to "Auto".

### Configuring the Analog Input Blocks

The M400 FF contains 4 Analog Input Blocks that can be assigned as required to the various process variables. The process variables PRIMARY\_VALUE, SECONDARY\_VALUE, THIRD\_VALUE and FOURTH\_VALUE are assigned to one Analog Input Block. One Analog Input Block is assigned to one display line. The factory default setting is:

- Measured value 1 (PRIMARY\_VALUE) – Analog Input Block 1 – First display line
- Measured value 2 (SECONDARY\_VALUE) – Analog Input Block 2 – Second display line
- Measured value 3 (THIRD\_VALUE) – Analog Input Block 3 – Third display line
- Measured value 4 (FOURTH\_VALUE) – Analog Input Block 4: Forth display line

1. If necessary, change the block name.  
Default setting: ANALOG INPUT BLOCK\_4652550400-xxxxxx
2. Open the Analog Input Block.
3. Set the block mode to OOS using the MODE\_BLK parameter, TARGET element.
4. Use the CHANNEL parameter to select the process variable which should be used as the input value for the Analog Input Block. For more information see documentation "FOUNDATION fieldbus parameter Multi-parameter Transmitter M400 FF" on CD-ROM.
5. Use the XD\_SCALE parameter to select the desired engineering unit and the block input range for the process variable. See "Scaling the OUT parameter".  
Ensure that the unit selected suits the process variable selected. If the process variable does not suit the unit, the BLOCK\_ERROR parameter reports "Block Configuration Error" and the block mode cannot be set to "Auto".
6. Use the L\_TYPE parameter to select the type of linearization for the input variable (default setting: Direct).  
Ensure that the settings for the XD\_SCALE and OUT\_SCALE parameters are the same for the "Direct" linearization type. If the process values and units do not match, the BLOCK\_ERROR parameter reports "Block Configuration Error" and the block mode cannot be set to "Auto".
7. Enter the alarm and critical alarm messages by means of the HI\_HI\_LIM, HI\_LIM, LO\_LO\_LIM and LO\_LO\_LIM parameters. The limit values entered have to be within the value range specified for the OUT\_SCALE parameter.

8. Specify the alarm priorities by means of the HI\_HI\_PRI, HI\_PRI, LO\_LO\_PRI and LO\_PRI parameters. Reporting to the field host system only takes place with alarms with a priority greater than 2.
9. Set the block mode to Auto using the MODE\_BLK parameter, TARGET element. For this purpose, the Resource Block must also be set to the "Auto" block mode.

#### Further configurations

1. Depending on the control or automation task, configure additional function blocks and output blocks.
2. Link the function blocks and output blocks.
3. After specifying the active LAS, download all the data and parameters to the field device.
4. Set the block mode to Auto using the MODE\_BLK parameter, TARGET element. For this purpose, the Resource Block must also be set to the "Auto" block mode and the Function Blocks must correctly connected with each other.

### 12.3.4 Scaling the OUT Parameter

In the Analog Input Block, the input value or input range can be scaled in accordance with the automation requirements.

#### Example:

The measuring range X\_LRV to X\_URV should be rescaled to 0 to 100 %.

1. Select XD\_SCALE group.
  - For EU\_0, enter "X\_LRV".
  - For EU\_100, enter "X\_URV".
  - For UNITS\_INDEX, enter "Unit".
2. Select OUT\_SCALE group.
  - For EU\_0, enter "0".
  - For EU\_100, enter "10000".
  - For UNITS\_INDEX, select "%" for example.

Result: The OUT value between 0 and 10000 corresponds to the measured value and is output to a downstream block or to the PCS.

The unit selected here does not have any effect on the scaling. This unit is not displayed on the onsite display.



**NOTE:** If you have selected the "Direct" mode for the L\_TYPE parameter, you cannot change the values and units for XD\_SCALE and OUT\_SCALE.

The L\_TYPE, XD\_SCALE and OUT\_SCALE parameters can only be changed in the OOS block mode.

Ensure sure that the output scaling of the Transducer Block SCALE\_OUT matches the input scaling of the Analog Input Block XD\_SCALE.

## **13 Maintenance**

### **13.1 Front Panel Cleaning**

Clean the front panel with a damp soft cloth (water only, no solvents). Gently wipe the surface and dry with a soft cloth.

## 14 Troubleshooting

If the equipment is used in a manner not specified by METTLER TOLEDO the protection provided by the equipment may be impaired. Review the table below for possible causes of common problems:

Problem	Possible Cause
Display is blank.	<ul style="list-style-type: none"> <li>– No power to M400.</li> <li>– LCD display contrast set incorrectly.</li> <li>– Hardware failure.</li> </ul>
Incorrect measurement readings.	<ul style="list-style-type: none"> <li>– Sensor improperly installed.</li> <li>– Incorrect units multiplier entered.</li> <li>– Temperature compensation incorrectly set or disabled.</li> <li>– Sensor or transmitter needs calibration.</li> <li>– Sensor or patch cord defective or exceeds recommended maximum length.</li> <li>– Hardware failure.</li> </ul>
Measurement readings not stable.	<ul style="list-style-type: none"> <li>– Sensors or cables installed too close to equipment that generates high level of electrical noise.</li> <li>– Recommended cable length exceeded.</li> <li>– Averaging set too low.</li> <li>– Sensor or patch cord defective.</li> </ul>
Displayed $\Delta$ is flashing.	<ul style="list-style-type: none"> <li>– Setpoint is in alarm condition (setpoint exceeded).</li> <li>– Alarm has been selected (see section 8.3.1 "Alarm") and occurred.</li> </ul>
Cannot change menu settings.	<ul style="list-style-type: none"> <li>– User locked out for security reasons.</li> </ul>

### 14.1 Cond (Resistive) Error Messages/Warning- and Alarm List for Analog Sensors

Alarms	Description
Watchdog time-out*	SW/System fault
Cond Cell open*	Cell running dry (no measurement solution) or wires are broken
Cond Cell shorted*	Short circuit caused by sensor or cable

\* According to the parameterization of the transmitter (see section 8.3.1 "Alarm";  
PATH: Menu/Configure/Alarm/Clean/Setup Alarm)

## 14.2 Cond (Resistive) Error Messages/ Warning- and Alarm List for ISM Sensors

Alarms	Description
Watchdog time-out*	SW/System fault
Dry Cond sensor*	Cell running dry (no measurement solution)
Cell deviation*	Multiplier out of tolerance** (depends on sensor model).

\* According to the parameterization of the transmitter (see section 8.3.1 "Alarm";  
PATH: Menu/Configure/Alarm/Clean/Setup Alarm)

\*\* For further information refer to the sensor documentation

## 14.3 pH Error Messages/Warning- and Alarm List

### 14.3.1 pH Sensors Except Dual Membrane pH Electrodes

Warnings	Description
Warning pH slope >102%	Slope too big
Warning pH Slope <90%	Slope too small
Warning pH Zero $\pm 0.5$ pH	Out of range
Warning pHGs change <0.3**	Glass electrode resistance changed by more than factor 0.3
Warning pHGs change >3**	Glass electrode resistance changed by more than factor 3
Warning pHRef change <0.3**	Reference electrode resistance changed by more than factor 0.3
Warning pHRef change >3**	Reference electrode resistance changed by more than factor 3

Alarms	Description
Watchdog time-out*	SW/System fault
Error pH Slope >103%	Slope too big
Error pH Slope <80%	Slope too small
Error pH pH Zero $\pm 1.0$ pH	Out of range
Error pH Ref Res >150 K $\Omega$ **	Reference electrode resistance too big (break)
Error pH Ref Res <2000 $\Omega$ **	Reference electrode resistance too small (short)
Error pH Gls Res >2000 M $\Omega$ **	Glass electrode resistance too big (break)
Error pH Gls Res <5 M $\Omega$ **	Glass electrode resistance too small (short)

\* ISM sensors only

\*\* According to the parameterization of the transmitter (see section 8.3.1 "Alarm";  
PATH: Menu/Configure/Alarm/Clean/Setup Alarm)

### 14.3.2 Dual Membrane pH Electrodes (pH/pNa)

Warnings	Description
Warning pH slope >102%	Slope too big
Warning pH Slope <90%	Slope too small
Warning pH Zero $\pm 0.5$ pH	Out of range
Warning pHGs change <0.3*	Glass electrode resistance changed by more than factor 0.3
Warning pHGs change >3*	Glass electrode resistance changed by more than factor 3
Warning pNaGs change<0.3*	Glass electrode resistance changed by more than factor 0.3
Warning pNaGs change >3*	Reference electrode resistance changed by more than factor 3

Alarms	Description
Watchdog time-out	SW/System fault
Error pH Slope >103%	Slope too big
Error pH Slope <80%	Slope too small
Error pH Zero $\pm 1.0$ pH	Out of range
Error pNa Gls Res > 2000 M $\Omega$ *	Glass electrode resistance too big (break)
Error pNa Gls Res < 5 M $\Omega$ *	Glass electrode resistance too small (short)
Error pH Gls Res > 2000 M $\Omega$ *	Glass electrode resistance too big (break)
Error pH Gls Res < 5 M $\Omega$ *	Glass electrode resistance too small (short)

\* According to the parameterization of the transmitter (see section 8.3.1 "Alarm";  
PATH: Menu/Configure/Alarm/Clean/Setup Alarm)

### 14.3.3 ORP Messages

Warnings*	Description
Warning ORP ZeroPt >30 mV	Zero offset too big
Warning ORP ZeroPt <-30 mV	Zero offset too small

Alarms*	Description
Watchdog time-out	SW/System fault
Error ORP ZeroPt >60 mV	Zero offset too big
Error ORP ZeroPt <-60 mV	Zero offset too small

\* ISM sensors only

## 14.4 Amperometric O<sub>2</sub> Error Messages/Warning- and Alarm List

### 14.4.1 High Level Oxygen Sensors

Warnings	Description
Warning O <sub>2</sub> Slope < -90 nA	Slope too big
Warning O <sub>2</sub> Slope > -35 nA	Slope too small
Warning O <sub>2</sub> ZeroPt > 0.3 nA	Zero offset too big
Warning O <sub>2</sub> ZeroPt < -0.3 nA	Zero offset too small

Alarms	Description
Watchdog time-out*	SW/System fault
Error O <sub>2</sub> Slope < -110 nA	Slope too big
Error O <sub>2</sub> Slope > -30 nA	Slope too small
Error O <sub>2</sub> ZeroPt > 0.6 nA	Zero offset too big
Error O <sub>2</sub> ZeroPt < -0.6 nA	Zero offset too small
Electrolyte Low*	Too low level of electrolyte

\* ISM sensors only

### 14.4.2 Low Level Oxygen Sensors

Warnings	Description
Warning O <sub>2</sub> Slope < -460 nA	Slope too big
Warning O <sub>2</sub> Slope > -250 nA	Slope too small
Warning O <sub>2</sub> ZeroPt > 0.5 nA	Zero offset too big
Warning O <sub>2</sub> ZeroPt < -0.5 nA	Zero offset too small

Alarms	Description
Watchdog time-out*	SW/System fault
Error Install O <sub>2</sub> Jumper	In case of using InPro 6900 a jumper has to be installed (see section 4.3.5 "TB2 – pH, Amp. Oxygen, Conductivity 4-e and Dissolved CO <sub>2</sub> (Low) ISM (Digital) Sensors").
Error O <sub>2</sub> Slope < -525 nA	Slope too big
Error O <sub>2</sub> Slope > -220 nA	Slope too small
Error O <sub>2</sub> ZeroPt > 1.0 nA	Zero offset too big
Error O <sub>2</sub> ZeroPt < -1.0 nA	Zero offset too small
Electrolyte Low*	Too low level of electrolyte

\* ISM sensors only

### 14.4.3 Trace Oxygen Sensors

Warnings	Description
Warning O <sub>2</sub> Slope < -5000 nA	Slope too big
Warning O <sub>2</sub> Slope > -3000 nA	Slope too small
Warning O <sub>2</sub> ZeroPt > 0.5 nA	Zero offset too big
Warning O <sub>2</sub> ZeroPt < -0.5 nA	Zero offset too small

Alarms	Description
Watchdog time-out	SW/System fault
Error O <sub>2</sub> Slope < -6000 nA	Slope too big
Error O <sub>2</sub> Slope > -2000 nA	Slope too small
Error O <sub>2</sub> ZeroPt > 1.0 nA	Zero offset too big
Error O <sub>2</sub> ZeroPt < -1.0 nA	Zero offset too small
Electrolyte Low*	Too low level of electrolyte

\* ISM sensors only

### 14.5 Optical O<sub>2</sub> Error Messages/Warning- and Alarm List

Warnings	Description
Chx Cal Required*	ACT = 0 or measured values out of range
Chx CIP Counter Expired	Limit of CIP cycles reached
Chx SIP Counter Expired	Limit of SIP cycles reached
Chx Autocl. Count. Exp.	Limit of autoclaving cycles reached

\* If this warning is displayed, you will find more information about the cause for the warning in Menu/Service/Diagnostics/O<sub>2</sub> optical

Alarms	Description
Watchdog time-out	SW/System fault
Chx Signal error**	Signal or value for temperature out of range
Chx Shaft error**	Temperature bad or stray light too high (e.g. because a glass is fiber broken) or shaft has been removed
Chx Hardware error**	Electronic components fail

\*\* According to the parameterization of the transmitter (see section 8.3.1 "Alarm";  
PATH: Menu/Configure/Alarm/Clean/Setup Alarm)

If an alarm has occurred, you will find more information about the cause for the alarm in Menu/Service/Diagnostics/O<sub>2</sub> optical



## 14.6 Dissolved Carbon Dioxide Error Messages/ Warning- and Alarm List

Warnings	Description
Warning pH slope >102%	Slope too big
Warning pH Slope <90%	Slope too small
Warning pH Zero $\pm$ 0.5 pH	Out of range
Warning pHGs change <0.3*	Glass electrode resistance changed by more than factor 0.3
Warning pHGs change >3*	Glass electrode resistance changed by more than factor 3

Alarms	Description
Watchdog time-out*	SW/System fault
Error pH Slope >103%	Slope too big
Error pH Slope <80%	Slope too small
Error pH Zero $\pm$ 1.0 pH	Out of range
Error pH Gls Res >2000 M $\Omega$ *	Glass electrode resistance too big (break)
Error pH Gls Res <5 M $\Omega$ *	Glass electrode resistance too small (short)

\* According to the parameterization of the transmitter (see section 8.3.1 "Alarm";  
PATH: Menu/Configure/Alarm/Clean/Setup Alarm).

## **14.7 Warning- and Alarm Indication on the Display**

### **14.7.1 Warning Indication**

If there are conditions, which generate a warning, the message will be recorded and can be selected through the menu Messages (PATH: Info / Messages; see also section 11.1 "Messages"). According to the configuration of the transmitter the hint "Failure – Press ENTER" will be shown at line 4 of the display, if a warning or alarm has occurred (see also section 8.5 "Display"; PATH: Menu/Configure/Display/Measurement).

### **14.7.2 Alarm Indication**

Alarms will be shown in the display by a flashing symbol  $\Delta$  and recorded through the menu point Messages (PATH: Info/Messages; see also section 11.1 "Messages").

Furthermore the detection of some alarms can be activated or deactivated (see section 8.3 "Alarm/Clean"; PATH: Menu/Configure/Alarm/Clean) for an indication on the display. If one of these alarms occurs and the detection has been activated, the flashing symbol  $\Delta$  will be shown on the display and the message will be recorded through the menu Messages (see section 11.1 "Messages"; PATH: Info / Messages).

According to the parameterisation of the transmitter the hint "Failure – Press ENTER" will be shown at line 4 of the display, if a warning or alarm has occurred (see also section 8.5 "Display"; PATH: Menu/Configure/Display/Measurement).

## 15 Accessories and Spare Parts

Please contact your local METTLER TOLEDO sales office or representative for details for Additional accessories and spare parts.

<b>Description</b>	<b>Order no.</b>
Pipe Mount Kit for ½ DIN models	30 300 480
Panel Mount Kit for ½ DIN models	52 500 213
Protective Hood for ½ DIN models	30 073 328

## 16 Specifications

### 16.1 General Specifications

#### Conductivity 2-e/4-e

Measurement parameters	Conductivity/resistivity and temperature
Conductivity ranges 2-electrode sensor	0.02 to 2,000 $\mu\text{S}/\text{cm}$ (500 $\Omega \times \text{cm}$ to 50 $\text{M}\Omega \times \text{cm}$ )
C = 0.01	0.002 to 200 $\mu\text{S}/\text{cm}$ (5000 $\Omega \times \text{cm}$ to 500 $\text{M}\Omega \times \text{cm}$ )
C = 0.1	0.02 to 2000 $\mu\text{S}/\text{cm}$ (500 $\Omega \times \text{cm}$ to 50 $\text{M}\Omega \times \text{cm}$ )
C = 1	15 to 4000 $\mu\text{S}/\text{cm}$
C = 3	15 to 12,000 $\mu\text{S}/\text{cm}$
C = 10	10 to 40,000 $\mu\text{S}/\text{cm}$ (25 $\Omega \times \text{cm}$ to 100 $\text{k}\Omega \times \text{cm}$ )
Conductivity ranges 4-electrode sensor	0.01 to 650 $\text{mS}/\text{cm}$ (1.54 $\Omega \times \text{cm}$ to 0.1 $\text{M}\Omega \times \text{cm}$ )
Display range for 2-e sensor	0 to 40,000 $\text{mS}/\text{cm}$ (25 $\Omega \times \text{cm}$ to 100 $\text{M}\Omega \times \text{cm}$ )
Display range for 4-e sensor	0.01 to 650 $\text{mS}/\text{cm}$ (1.54 $\Omega \times \text{cm}$ to 0.1 $\text{M}\Omega \times \text{cm}$ )
Chemical concentration curves	– NaCl: 0–26% @ 0 °C to 0–28% @ +100 °C – NaOH: 0–12% @ 0 °C to 0–16% @ +40 °C to 0–6% @ +100 °C – HCl: 0–18% @ –20 °C to 0–18% @ 0 °C to 0–5% @ +50 °C – HNO <sub>3</sub> : 0–30% @ –20 °C to 0–30% @ 0 °C to 0–8% @ +50 °C – H <sub>2</sub> SO <sub>4</sub> : 0–26% @ –12 °C to 0–26% @ +5 °C to 0–9% @ +100 °C – H <sub>3</sub> PO <sub>4</sub> : 0–35% @ +5 °C to +80 °C – User-defined concentration table (5 × 5 matrix)
TDS ranges	NaCl, CaCO <sub>3</sub>
Cond/Res accuracy <sup>1)</sup>	Analog: $\pm 0.5\%$ of reading or 0.25 $\Omega$ , whichever is greater, up to 10 $\text{M}\Omega\text{-cm}$
Cond/Res repeatability <sup>1)</sup>	Analog: $\pm 0.25\%$ of reading or 0.25 $\Omega$ , whichever is greater
Cond/Res resolution	Auto/0.001/0.01/0.1/1 (can be selected)
Temperature input	Pt1000/Pt100/NTC22K
Temperature measuring range	–40 to +200 °C (–40 to +392 °F)
Temperature resolution	Auto/0.001/0.01/0.1/1 (can be selected)
Temperature accuracy	– ISM: $\pm 1$ digit – Analog: $\pm 0.25$ °C ( $\pm 32.5$ °F) within –30 to +150 °C (–22 to +302 °F); $\pm 0.50$ °C ( $\pm 32.9$ °F) outside
Temperature repeatability <sup>1)</sup>	$\pm 0.13$ °C ( $\pm 32.2$ °F)
Max. sensor cable length	– ISM: 80 m (260 ft) – Analog: 61 m (200 ft); with 4-e sensors: 15 m (50 ft)
Calibration	1-point, 2-point or process

1) ISM input signal causes no additional error.

**pH/ORP**

Measurement parameters	pH, mV and temperature
pH display range	-2.00 to +20.00 pH
pH resolution	Auto/0.001/0.01/0.1/1 (can be selected)
pH accuracy <sup>1)</sup>	Analog: $\pm 0.02$ pH
mV range	-1500 to +1500 mV
mV resolution	Auto/0.001/0.01/0.1/1 mV (can be selected)
mV accuracy <sup>1)</sup>	Analog: $\pm 1$ mV
Temperature input <sup>2)</sup>	Pt1000/Pt100/NTC30K
Temperature measuring range	-30 to 130 °C (-22 to 266 °F)
Temperature resolution	Auto/0.001/0.01/0.1/1 (can be selected)
Temperature accuracy <sup>1)</sup>	Analog: $\pm 0.25$ °C in the range of -10 to +150 °C ( $\pm 32.5$ °F in the range of +14 to +176 °F)
Temperature repeatability <sup>1)</sup>	$\pm 0.13$ °C ( $\pm 32.2$ °F)
Temperature compensation	Automatic/Manual
Max. sensor cable length	- Analog: 10 to 20 m (33 to 65 ft) depending on sensor - ISM: 80 m (260 ft)
Calibration	1-point (offset), 2-point (slope or offset) or process (offset)

1) ISM input signal causes no additional error.

2) Not required on ISM sensors

**Available Buffer Sets**

Standard buffers	MT-9 buffers, MT-10 buffers, NIST Technical Buffers, NIST Standard Buffers (DIN 19266:2000-01), JIS Z 8802 buffers, Hach buffers, CIBA (94) buffers, Merck Titrisols-Reidel Fixanals, WTW buffers
Dual membrane electrode pH buffers (pH/pNa)	Mettler-pH/pNa buffers (Na+ 3.9M)

**Amperometric oxygen**

Measurement parameters	– Dissolved oxygen: Saturation or concentration and temperature – Oxygen in gas: Concentration and temperature
Current range	Analog: 0 to –7000 nA
Oxygen measuring ranges, dissolved oxygen	– Saturation: 0 to 500 % air, 0 to 200 % O <sub>2</sub> – Concentration: 0 ppb (µg/L) to 50.00 ppm (mg/L)
Oxygen measuring ranges, oxygen in gas	0 to 9999 ppm O <sub>2</sub> gas, 0 to 100 vol % O <sub>2</sub>
Oxygen accuracy, dissolved oxygen <sup>1)</sup>	– Saturation: ±0.5 % of the measured value or ±0.5 %, depending on which is larger – Concentration at high values: ±0.5 % of the measured value or ±0.050 ppm/±0.050 mg/L, depending on which is larger – Concentration at low values: ±0.5 % of the measured value or ±0.001 ppm/±0.001 mg/L, depending on which is larger – Concentration at traces values: ±0.5 % of the measured value or ±0.100 ppb/±0.1 µg/L, depending on which is larger
Oxygen accuracy, oxygen in gas <sup>1)</sup>	– ±0.5 % of the measured value or ±5 ppb, depending on which is larger for ppm O <sub>2</sub> gas – ±0.5 % of the measured value or ±0.01%, depending on which is larger for vol % O <sub>2</sub>
Resolution current <sup>1)</sup>	Analog: 6 pA
Polarization voltage	– Analog: –1000 to 0 mV – ISM: –550 mV or –674 mV (configurable)
Temperature input	NTC 22 kΩ, Pt1000, Pt100
Temperature compensation	Automatic
Temperature measuring range	–10 to +80 °C (+14 to +176 °F)
Temperature accuracy	±0.25 K in the range of –10 to +80 °C (+14 to +176 °F)
Max. sensor cable length	– Analog: 20 m (65 ft) – ISM: 80 m (260 ft)
Calibration	1-point (slope and offset) or process (slope and offset)

1) ISM input signal causes no additional error.

**Optical oxygen**

Measurement parameters	DO saturation or concentration and temperature
DO concentration range	0.1 ppb (µg/L) to 50.00 ppm (mg/L)
DO saturation range	0 to 500 % air, 0 to 100 % O <sub>2</sub>
DO resolution	Auto/0.001/0.01/0.1/1 (can be selected)
DO accuracy	±1 digit
Temperature measuring range	–30 to +150 °C (–22 to +302 °F)
Temperature resolution	Auto/0.001/0.01/0.1/1 (can be selected)
Temperature accuracy	±1 digit
Temperature repeatability	±1 digit
Temperature compensation	Automatic
Max. sensor cable length	15 m (50 ft)
Calibration	1-point (depending on sensor model), 2-point, process

**Dissolved carbon dioxide**

Measurement parameters	Dissolved carbon dioxide and temperature
CO <sub>2</sub> measuring ranges	– 0 to 5000 mg/L – 0 to 200 %sat – 0 to 1500 mm Hg – 0 to 2000 mbar – 0 to 2000 hPa
CO <sub>2</sub> accuracy	± 1 digit
CO <sub>2</sub> resolution	Auto/0.001/0.01/0.1/1 (can be selected)
mV range	– 1500 to + 1500 mV
mV resolution	Auto/0.01/0.1/1 mV
mV accuracy	± 1 digit
Total pressure range (TotPres)	0 to 4000 mbar
Temperature input	Pt1000/NTC22K
Temperature measuring range	0 to +60 °C (–32 to +140 °F)
Temperature resolution	Auto/0.001/0.01/0.1/1, (can be selected)
Temperature accuracy	± 1 digit
Temperature repeatability	± 1 digit
Max. sensor cable length	80 m (260 ft)
Calibration	1-point (offset), 2-point (slope or offset) or process (offset)

**Available Buffer Sets**

Buffer	MT-9 buffers with solution pH = 7.00 and pH = 9.21 @ 25 °C
--------	--

## 16.2 Electrical Specifications

Display	Backlit LCD, 4 lines
Running capacity	Ca. 4 days
Keypad	5 tactile feedback keys
Languages	8 (English, German, French, Italian, Spanish, Portuguese, Russian and Japanese)
Connection terminals	Spring cage terminals, appropriate for wire cross section 0.2 to 1.5 mm <sup>2</sup> (AWG 16 – 24)
Analog input	4 to 20 mA (for pressure compensation)

## 16.3 FOUNDATION Fieldbus Specifications

Supply voltage	– Non hazardous area (Non-IS): 9 to 32 V DC – Linear Barrier: 9 to 24 V DC – FISCO: 9 to 17.5 V DC
Current	22 mA
Max. current in case of fault (FDE)	< 28 mA
Number of current inputs	1 for pressure compensation
Physical interface	According to IEC 61158-2
Transfer rate	31.25 kbit/s
Profile	FF_H1 (Foundation fieldbus)
Communication protocol	FF-816
ITK version	6.0.1
Manufacturer ID (DEV_TYPE)	0x465255
FF Type (DEV_REV)	1
FF communication model	– 1 Resource Block – 1 Physical Block – 2 Transducer Blocks (General and Sensor) – 4 Analog Input Blocks – 1 Analog Output Block – 2 Discrete Input Blocks – 2 Discrete Output Blocks



## 16.4 Mechanical Specification

Dimensions	Housing – Height × Width × Depth	144 × 144 × 116 mm (5.7 × 5.7 × 4.6 inch)
	Front bezel – Height × Width	150 × 150 mm (5.9 × 5.9 inch)
	Max. depth – panel mounted	87 mm (excludes plug-in connectors)
Weight		1.50 kg (3.3 lb)
Material		Aluminum die cast
Enclosure rating		IP 66/NEMA4X

## 16.5 Environmental Specifications

Storage temperature	–40 to +70 °C (–40 to +158 °F)
Ambient temperature operating range	–20 to +60 °C (–4 to +140 °F)
Relative humidity	0 to 95 % non-condensing
EMC	According to EN 61326-1 (general requirements) Emission: Class B, Immunity: Class A
Approvals and certificates	– ATEX/IECEX/UKCA Zone 1 Ex ib [ia Ga] IIC T4 Gb – cFMus Class I, Division 1, Groups A, B, C, D T4A – NEPSI EX Zone
CE mark	The measuring system is in conformity with the statutory requirements of the EC Directives. METTLER TOLEDO confirms successful testing of the device by affixing to it the CE mark.

## 16.6 Control Drawings

### 16.6.1 Installation, Maintenance and Inspection

1. Intrinsically Safe Apparatus can be a source of ignition if internal spacings are shorted or connections opened.
2. Although intrinsically safe circuits are inherently low energy, they may still present a shock hazard because of the operating voltage.
3. Refer to manufacturer's written instructions before working on associated apparatus.
4. Inspection should be performed periodically to ensure that intrinsic safety has not been compromised. Inspections should include reviewing for unauthorized modifications, corrosion, accidental damage, change of flammable materials, and the effects of aging.
5. User replaceable parts of an intrinsically safe system should not be replaced with other than the manufacturer's direct equivalent.
6. Maintenance work may be performed on energized apparatus in hazardous areas subject to the conditions as follows:
  - Disconnection of, and removal or replacement of, items of electrical apparatus and cabling if such action will not result in shorting of different intrinsically safe circuits.
  - Adjustment of any control that is necessary for the calibration of the electrical apparatus or system.
  - Only test instruments specified in the written instructions should be used.
  - Performance of other maintenance activities specifically permitted by the relevant control drawing and instruction manual.
7. Maintenance of Associated Apparatus and parts of intrinsically safe circuits located in unclassified areas should be restricted to that described in a way such that electrical apparatus or parts of circuits remain interconnected with parts of intrinsically safe systems located in hazardous areas. Safety barrier ground connections should not be removed without first disconnecting the hazardous-area circuits.
8. Other maintenance work on Associated Apparatus or parts of an intrinsically safe circuit mounted in an unclassified area should be performed only if the electrical apparatus or part of a circuit is disconnected from the part of the circuit located in a hazardous area.
9. The location classification and the suitability of the intrinsically safe system for that classification should be verified. This includes verifying that the class, group, and temperature ratings of both the Intrinsically Safe Apparatus and the Associated Apparatus agree with the actual classification of the location.

10. Prior to energizing, an intrinsically safe system should be inspected to ensure the following:
  - Installation is in compliance with the documentation;
  - Intrinsically safe circuits are properly separated from non-intrinsically safe circuits;
  - Cable shields are grounded in accordance with the installation documentation;
  - Modifications have been authorized;
  - Cables and wiring are not damaged;
  - Bonding and grounding connections are tight;
  - Bonding and grounding hardware is not corroded;
  - Resistance of any grounding conductor, including termination resistance from shunt-type-Associated Apparatus to the grounding electrode does not exceed one ohm;
  - Protection has not been defeated by bypassing; and
  - Check for signs of corrosion on the equipment and connections.
11. All deficiencies should be corrected.

## 16.6.2 Control Installation Drawing General Installation

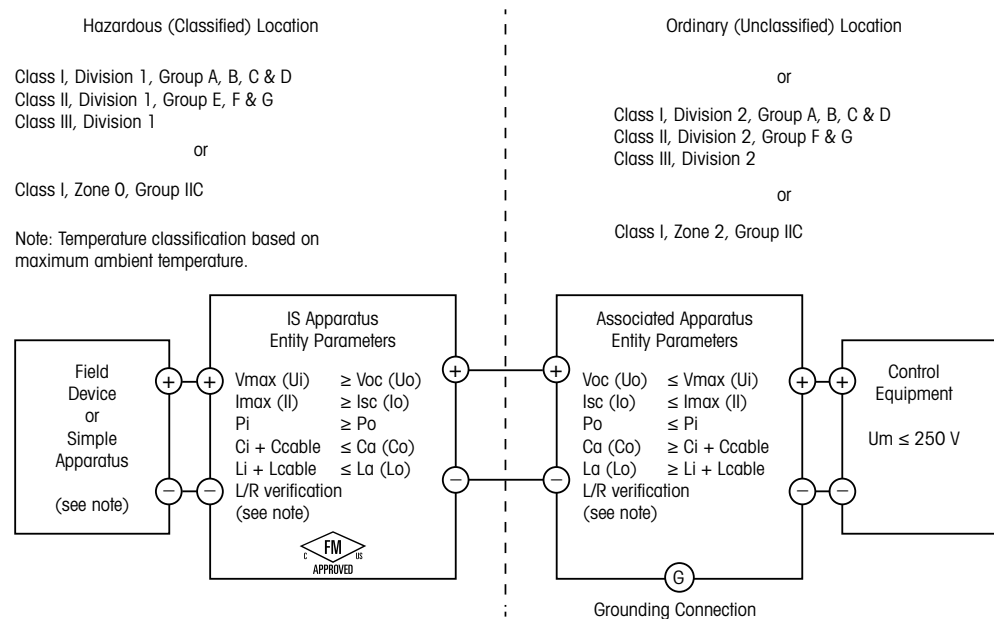

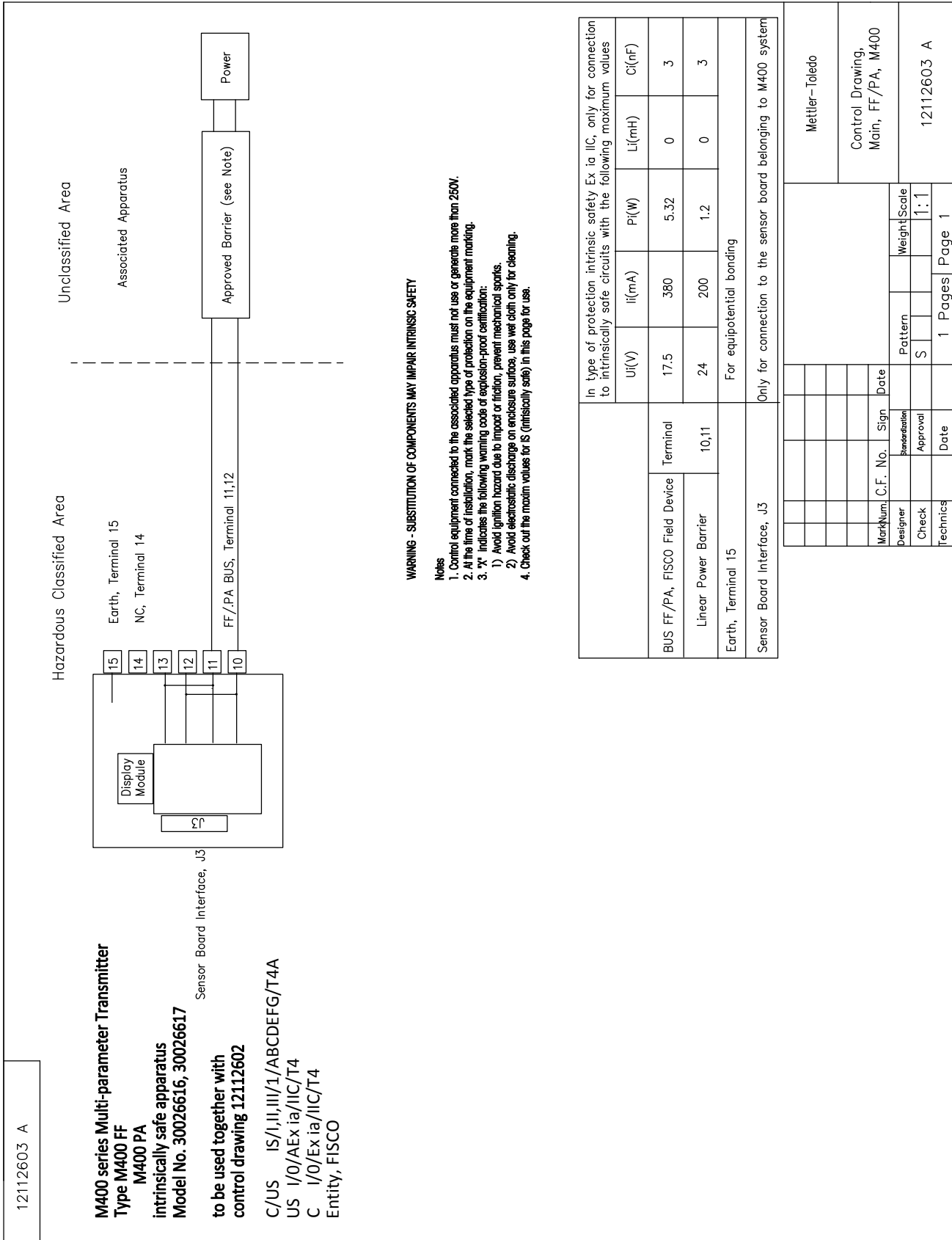

12112602 A

**Hazardous Classified Area  
Sensor Board  
belonging to  
M400 Multi-parameter Transmitters  
control drawing 12112601 or 12112603**

Sensor interface	In type of protection intrinsic safety, only for connection to M400, with the following maximum values				
	U(V)	I(mA)	P(mW)	L(mH)	C(uF)
pH measuring loop, Terminal A,E,G	Uo=5.88	Io=1.3	Po=1.9	Lo=5	Co=2.1
Conductivity measuring loop, Terminal A,B,E,G	Uo=5.88	Io=29	Po=4.3	Lo=1	Co=2.5
DO measuring loop, Terminal B,C,D,H	Uo=5.88	Io=29	Po=4.3	Lo=1	Co=2.5
Temperature measuring loop, Terminal I,J,K	Uo=5.88	Io=5.4	Po=8	Lo=5	Co=2
One-wire measuring loop, Terminal L,M	Uo=5.88	Io=22	Po=32	Lo=1	Co=2.8
485 measuring loop, Terminal N,O	Uo=5.88 Ui=30V	Io=54 Ii=100	Po=80 Pi=0.8	Lo=1 Li=0	Co=1.9 Ci=0.7
Analog input measuring loop, Terminal P,Q	Ui=30	Ii=100	Pi=800	Li=0	Ci=0.015

The measuring circuits are galvanically connected.

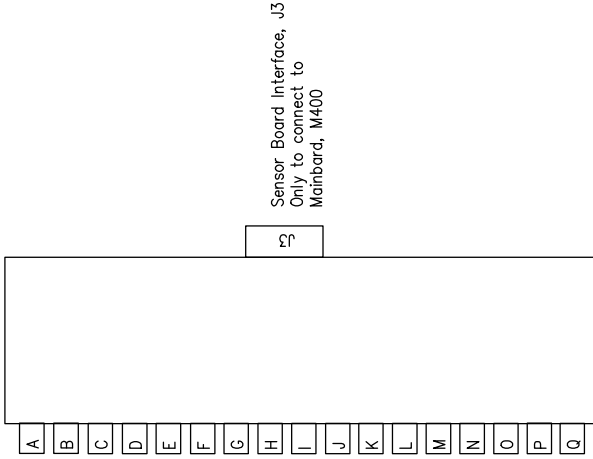

**WARNING - SUBSTITUTION OF COMPONENTS MAY IMPAIR INTRINSIC SAFETY**  
**WARNING - SUBSTITUTION OF COMPONENTS MAY IMPAIR THE SUITABILITY FOR ZONE 2**

- Notes  
IECEX, ATEX, FM, CSA  
1. When installed in M400, intrinsically safe equipment connecting to A-Q must be approved or be a Simple Apparatus.  
2. A Simple Apparatus is defined as a device that does not generate more than 1.5V, 0.1A or 25mW.  
3. Check out the maximum values for IS (intrinsically safe) in this page for use.

MarkNum	C.F. No.	Sign	Date	Mettler-Toledo Instruments (Shanghai) Co. Ltd.		
Designer	Standardization	Approval	Date	Control Drawing, Sensor, M400		
Check	Pattern	Weight/Scale		12112602 A		
Technics	S	1:1		1	Pages	Page 1

### 16.6.3 Notes

1. The intrinsic safety entity concept allows the interconnection of FM Approved intrinsically safe devices with entity parameters not specifically examined in combination as a system when:  $V_{oc} (U_o) \text{ or } V_t \leq V_{max}$ ,  $I_{sc} (I_o) \text{ or } I_t \leq I_{max}$ ,  $C_a (C_o) \geq C_i + C_{cable}$ ,  $L_a (L_o) \geq L_i + L_{cable}$ ,  $P_o \leq P_i$
2. The intrinsic safety fieldbus intrinsically safe concept allows the interconnection of FM Approved intrinsically safe devices with fieldbus intrinsically safe concept parameters not specifically examined in combination as a system when:  $V_{oc} (U_o) \text{ or } V_t < V_{max}$ ,  $I_{sc} (I_o) \text{ or } I_t \leq I_{max}$ ,  $P_o \leq P_i$
3. The configuration of associated apparatus must be FM Approved under the entity concept.
4. Associated Apparatus manufacturer's installation drawing must be followed when installing this equipment.
5. The configuration of field device sensor must be FM Approved under the entity concept.
6. The installation must be in accordance with the National Electrical Code. (ANSI/NFPA 70 (NEC.)), Articles 504 and 505, and ANSI/ISA-RP12.06.01, or the Canadian Electrical (CE) Code. (CEC Part 1, CAN/CSA-C22.1), Appendix F, and ANSI/ISARP12.06.01 when installed in Canada.
7. A dust-tight conduit seal must be used when installed in Class II and Class III environments.
8. Control equipment connected to the associated apparatus must not use or generate more than the maximum unclassified location voltage,  $U_m$ , or 250 VAC/DC.
9. Resistance between intrinsically safe ground and earth ground must be less than one ohm.
10. For Class I, Zone 0 and Division 1 locations, installation of the Multi-parameter Transmitter M400/2(X)H, M400G/2XH, M400FF, M400PA should be in accordance with ANSI/ISA RP12.06.01 "Installation of Intrinsically Safe Systems for Hazardous (Classified) Locations" and the National Electrical Code. (ANSI/ NRPA 70), or Canadian Electrical (CE) Code. (CEC Part 1, CAN/CSA-C22.1) when installed in Canada.
11. The Multi-parameter Transmitter M400/2(X)H, M400G/2XH, M400FF, M400PA are FM Approved for Class I, Zone 0 and Division 1 applications. If connecting [AEx ib] or [Ex ib] associated apparatus to the Multiparameter Transmitter M400/2(X)H, M400G/2XH, M400FF, M400PA, the above system is only suitable for Class I, Zone 1, and is not suitable for Class I, Zone 0, or Division 1 hazardous (classified) locations.
12. For Division 2 installations, the associated apparatus is not required to be FM Approved under entity concept if the Multi-parameter Transmitter M400/2(X)H, M400G/2XH is installed in accordance with the National Electrical Code. (ANSI/NFPA 70), Articles 504 and 505 or Canadian Electrical (CE) Code., CAN/CSA-C22.1, Part 1, Appendix F, for Division 2 wiring methods excluding nonincendive field wiring.
13.  $L_i$  may be greater than  $L_a$  and the cable length restrictions due to cable inductance ( $L_{cable}$ ) can be ignored if both the following conditions are met:  $L_a/R_a \text{ (or } L_o/R_o) > L_i/R_i$ ;  $L_a/R_a \text{ (or } L_o/R_o) > L_{cable}/R_{cable}$
14. If the electrical parameters of the cable used are unknown, the following values may be used: Capacitance - 197 pF/m (60 pF/ft.); Inductance - 0.66  $\mu$ H/m (0.20  $\mu$ H/ft.)
15. Simple apparatus is defined as a device that does not generate more than 1.5 V, 0.1 A, or 25 mW.
16. No revision to the control installation drawing without prior authorization by FM Approvals.

# 17 Default Table

## Common

Parameter	Sub parameter	Value	Unit
Measurement	Power failure	No	
	Software failure	No	
	ChB disconnected	Yes	
Clean	Interval time	0	hrs
	Clean time	0	sec
Language		English	
Passwords	Administrator	00000	
	Operator	00000	
Set/Clear LockOut		No	
Hold Output		Yes	
Display	Line1	a	
	Line2	b	
	Line3	c	
	Line4	d	
		On	
Name1	blank		
Name2	blank		
Resolution	Temperature	0.1	°C
	Conductivity	0.01	S/cm(Auto)
	Resistivity	0.01	Ω-cm(Auto)_
	pH	0.01	pH
	ORP	1.0	mV
	O <sub>2</sub> ppb	1.	ppb
	O <sub>2</sub> ppm	0.1	ppm
CIP Max		100	
CIP Temp		55 (30-100)	°C
SIP Max		100	
SIP Temp		115 (90-130)	°C
AutoClave Max		0	
ACT Initial		0	
TTM Initial		0	

**pH**

Parameter	Sub parameter	Value	Unit
Channel X	a	pH	pH
	b	Temperature	°C
	c	None	
	d	None	
Temperature source (for Analog sensor)		Auto	
pH buffer		Mettler-9	
Drift Control		Auto	
IP		7.0 (ISM sensor reading from sensor)	pH
STC		0.000	pH/°C
Fix CalTemp		No	
Cal constants (for Analog sensor)	pH	S = 100.0 %, Z = 7.000 pH	
	Temperature	M = 1.0, A = 0.0	
Cal constants (for ISM sensor)		Read from sensor	
Resolution	pH	0.01	pH
	Temperature	0.1	°C
Alarm	Rg diagnostics	Yes	
	Rr diagnostics	Yes	

**pH/pNa**

Parameter	Sub parameter	Value	Unit
Channel X	a	pH	pH
	b	Temperature	°C
	c	None	
	d	None	
Temperature source (for Analog sensor)		Auto	
pH buffer		Na+3.9M	
Drift Control		Auto	
IP		Reading form sensor	pH
STC		0.000	pH/°C
Fix CalTemp		No	
Cal constants		Read from sensor	
Resolution	pH	0.01	pH
	Temperature	0.1	°C
Alarm	Rg diagnostics	Yes	



## Oxygen

Parameter	Sub parameter	Value	Unit
Channel X	a	O <sub>2</sub>	%air - O <sub>2</sub> Hi ppb - O <sub>2</sub> Lo, Trace ppm - MecSens
	b	Temperature	°C
	c	None	
	d	None	°C
Temperature source (for Analog sensor)		UseNTC22K	
CalPres		759.8	mmHg
ProcPres		759.8	mmHg
ProcCalPres		CaPres	
Drift control		Auto	
Salinity		0.0	g/Kg
Humidity		100	%
Umeaspol		ISM: Read from sensor Analog: -674 for O <sub>2</sub> Hi, others: -500.0	
Ucalpol		-674	mV
Cal constants (for Analog sensor)	O <sub>2</sub> high	S = -70.00 nA, Z = 0.00 nA	
	O <sub>2</sub> low	S = -350.00 nA, Z = 0.00 nA	
	O <sub>2</sub> Trace	S = -4000.0 nA, Z = 0.00 nA	
	Temperature	M = 1.0, A = 0.0	
Cal constants (for ISM sensor)		Read from sensor	
Resolution	O <sub>2</sub>	0.1	%air
		1	ppb
	Temperature	0.1	°C
Alarm	Electrolyte low (ISM sensor)	Yes	

## Resistivity/Conductivity

Parameter	Sub parameter	Value	Unit
Channel X	a	Conductivity	mS/cm
	b	Temperature	°C
	c	None	
	d	None	
Temperature source (for Analog sensor)		Auto	
Compensation		Standard	
Cal constants (for Analog sensor)	Cond/Res	M = 0.1, A = 0.0	
	Temperature	M = 1.0, A = 0.0	
Cal constants (for ISM sensor)		Read from sensor	
Resolution	Conductivity	0.01	mS/cm
	Temperature	0.1	°C
Alarm	Cond cell shorted	No	
	Dry cond sensor	No	
	Cell deviation (ISM sensor)	No	

## CO<sub>2</sub>

Parameter	Sub parameter	Value	Unit
Channel X	a	%CO <sub>2</sub>	%CO <sub>2</sub>
	b	Temperature	°C
	c	----	
	d	----	
Temperature source (for Analog sensor)		Auto	
pH buffer		Mettler-9	
Drift Control		Auto	
Salinity		28.0	g/L
HCO <sub>3</sub>		0.05	mol/L
TotPres		750.1	mmHg
Cal constants	CO <sub>2</sub>	Read from sensor	
Resolution	CO <sub>2</sub>	0.1	hPa
	Temperature	0.1	°C
Alarm	Rg diagnostics	No	

## 18 Warranty

METTLER TOLEDO warrants this product to be free from significant deviations in material and workmanship for a period of one year from the date of purchase. If repair is necessary and not the result of abuse or misuse within the warranty period, please return by freight pre-paid and amendment will be made without any charge. METTLER TOLEDO's Customer Service Dept. will determine if the product problem is due to deviations or customer abuse. Out-of-warranty products will be repaired on an exchange basis at cost.

The above warranty is the only warranty made by METTLER TOLEDO and is lieu of all other warranties, expressed or implied, including, without limitation, implied warranties of merchantability and fitness for a particular purpose. METTLER TOLEDO shall not be liable for any loss, claim, expense or damage caused by, contributed to or arising out of the acts or omissions of the Buyer or Third Parties, whether negligent or otherwise. In no event shall METTLER TOLEDO's liability for any cause of action whatsoever exceed the cost of the item giving rise to the claim, whether based in contract, warranty, indemnity, or tort (including negligence).

## 19 Buffer Tables

M400 transmitters have the ability to do automatic pH buffer recognition. The following tables show different standard buffers that are automatically recognized.

### 19.1 Standard pH Buffers

#### 19.1.1 Mettler-9

Temp (°C)	pH of buffer solutions			
0	2.03	4.01	7.12	9.52
5	2.02	4.01	7.09	9.45
10	2.01	4.00	7.06	9.38
15	2.00	4.00	7.04	9.32
20	2.00	4.00	7.02	9.26
25	2.00	4.01	7.00	9.21
30	1.99	4.01	6.99	9.16
35	1.99	4.02	6.98	9.11
40	1.98	4.03	6.97	9.06
45	1.98	4.04	6.97	9.03
50	1.98	4.06	6.97	8.99
55	1.98	4.08	6.98	8.96
60	1.98	4.10	6.98	8.93
65	1.98	4.13	6.99	8.90
70	1.99	4.16	7.00	8.88
75	1.99	4.19	7.02	8.85
80	2.00	4.22	7.04	8.83
85	2.00	4.26	7.06	8.81
90	2.00	4.30	7.09	8.79
95	2.00	4.35	7.12	8.77

## 19.1.2 Mettler-10

Temp (°C)	pH of buffer solutions			
0	2.03	4.01	7.12	10.65
5	2.02	4.01	7.09	10.52
10	2.01	4.00	7.06	10.39
15	2.00	4.00	7.04	10.26
20	2.00	4.00	7.02	10.13
25	2.00	4.01	7.00	10.00
30	1.99	4.01	6.99	9.87
35	1.99	4.02	6.98	9.74
40	1.98	4.03	6.97	9.61
45	1.98	4.04	6.97	9.48
50	1.98	4.06	6.97	9.35
55	1.98	4.08	6.98	
60	1.98	4.10	6.98	
65	1.98	4.13	6.99	
70	1.99	4.16	7.00	
75	1.99	4.19	7.02	
80	2.00	4.22	7.04	
85	2.00	4.26	7.06	
90	2.00	4.30	7.09	
95	2.00	4.35	7.12	

## 19.1.3 NIST Technical Buffers

Temp (°C)	pH of buffer solutions				
0	1.67	4.00	7.115	10.32	13.42
5	1.67	4.00	7.085	10.25	13.21
10	1.67	4.00	7.06	10.18	13.01
15	1.67	4.00	7.04	10.12	12.80
20	1.675	4.00	7.015	10.07	12.64
25	1.68	4.005	7.00	10.01	12.46
30	1.68	4.015	6.985	9.97	12.30
35	1.69	4.025	6.98	9.93	12.13
40	1.69	4.03	6.975	9.89	11.99
45	1.70	4.045	6.975	9.86	11.84
50	1.705	4.06	6.97	9.83	11.71
55	1.715	4.075	6.97		11.57
60	1.72	4.085	6.97		11.45
65	1.73	4.10	6.98		
70	1.74	4.13	6.99		
75	1.75	4.14	7.01		
80	1.765	4.16	7.03		
85	1.78	4.18	7.05		
90	1.79	4.21	7.08		
95	1.805	4.23	7.11		

## 19.1.4 NIST Standard Buffers (DIN and JIS 19266: 2000–01)

Temp (°C)	pH of buffer solutions			
0				
5	1.668	4.004	6.950	9.392
10	1.670	4.001	6.922	9.331
15	1.672	4.001	6.900	9.277
20	1.676	4.003	6.880	9.228
25	1.680	4.008	6.865	9.184
30	1.685	4.015	6.853	9.144
37	1.694	4.028	6.841	9.095
40	1.697	4.036	6.837	9.076
45	1.704	4.049	6.834	9.046
50	1.712	4.064	6.833	9.018
55	1.715	4.075	6.834	8.985
60	1.723	4.091	6.836	8.962
70	1.743	4.126	6.845	8.921
80	1.766	4.164	6.859	8.885
90	1.792	4.205	6.877	8.850
95	1.806	4.227	6.886	8.833



**NOTE:** The pH(S) values of the individual charges of the secondary reference materials are documented in a certificate of an accredited laboratory. This certificate is supplied with the respective buffer materials. Only these pH(S) values shall be used as standard values for the secondary reference buffer materials. Correspondingly, this standard does not include a table with standard pH values for practical use. The table above only provides examples of pH(PS) values for orientation.

## 19.1.5 Hach Buffers

Buffer values up to 60 °C as specified by Bergmann & Beving Process AB.

Temp (°C)	pH of buffer solutions		
0	4.00	7.14	10.30
5	4.00	7.10	10.23
10	4.00	7.04	10.11
15	4.00	7.04	10.11
20	4.00	7.02	10.05
25	4.01	7.00	10.00
30	4.01	6.99	9.96
35	4.02	6.98	9.92
40	4.03	6.98	9.88
45	4.05	6.98	9.85
50	4.06	6.98	9.82
55	4.07	6.98	9.79
60	4.09	6.99	9.76

## 19.1.6 Ciba (94) Buffers

Temp (°C)	pH of buffer solutions				
0	2.04	4.00	7.10	10.30	
5	2.09	4.02	7.08	10.21	
10	2.07	4.00	7.05	10.14	
15	2.08	4.00	7.02	10.06	
20	2.09	4.01	6.98	9.99	
25	2.08	4.02	6.98	9.95	
30	2.06	4.00	6.96	9.89	
35	2.06	4.01	6.95	9.85	
40	2.07	4.02	6.94	9.81	
45	2.06	4.03	6.93	9.77	
50	2.06	4.04	6.93	9.73	
55	2.05	4.05	6.91	9.68	
60	2.08	4.10	6.93	9.66	
65	2.07*	4.10*	6.92*	9.61*	
70	2.07	4.11	6.92	9.57	
75	2.04*	4.13*	6.92*	9.54*	
80	2.02	4.15	6.93	9.52	
85	2.03*	4.17*	6.95*	9.47*	
90	2.04	4.20	6.97	9.43	
95	2.05*	4.22*	6.99*	9.38*	

\* Extrapolated

## 19.1.7 Merck Titrisole, Riedel-de-Haën Fixanale

Temp (°C)	pH of buffer solutions				
0	2.01	4.05	7.13	9.24	12.58
5	2.01	4.05	7.07	9.16	12.41
10	2.01	4.02	7.05	9.11	12.26
15	2.00	4.01	7.02	9.05	12.10
20	2.00	4.00	7.00	9.00	12.00
25	2.00	4.01	6.98	8.95	11.88
30	2.00	4.01	6.98	8.91	11.72
35	2.00	4.01	6.96	8.88	11.67
40	2.00	4.01	6.95	8.85	11.54
45	2.00	4.01	6.95	8.82	11.44
50	2.00	4.00	6.95	8.79	11.33
55	2.00	4.00	6.95	8.76	11.19
60	2.00	4.00	6.96	8.73	11.04
65	2.00	4.00	6.96	8.72	10.97
70	2.01	4.00	6.96	8.70	10.90
75	2.01	4.00	6.96	8.68	10.80
80	2.01	4.00	6.97	8.66	10.70
85	2.01	4.00	6.98	8.65	10.59
90	2.01	4.00	7.00	8.64	10.48
95	2.01	4.00	7.02	8.64	10.37

## 19.1.8 WTW Buffers

Temp (°C)	pH of buffer solutions			
0	2.03	4.01	7.12	10.65
5	2.02	4.01	7.09	10.52
10	2.01	4.00	7.06	10.39
15	2.00	4.00	7.04	10.26
20	2.00	4.00	7.02	10.13
25	2.00	4.01	7.00	10.00
30	1.99	4.01	6.99	9.87
35	1.99	4.02	6.98	9.74
40	1.98	4.03	6.97	9.61
45	1.98	4.04	6.97	9.48
50	1.98	4.06	6.97	9.35
55	1.98	4.08	6.98	
60	1.98	4.10	6.98	
65	1.99	4.13	6.99	
70		4.16	7.00	
75		4.19	7.02	
80		4.22	7.04	
85		4.26	7.06	
90		4.30	7.09	
95		4.35	7.12	

## 19.1.9 JIS Z 8802 Buffers

Temp (°C)	pH of buffer solutions			
0	1.666	4.003	6.984	9.464
5	1.668	3.999	6.951	9.395
10	1.670	3.998	6.923	9.332
15	1.672	3.999	6.900	9.276
20	1.675	4.002	6.881	9.225
25	1.679	4.008	6.865	9.180
30	1.683	4.015	6.853	9.139
35	1.688	4.024	6.844	9.102
38	1.691	4.030	6.840	9.081
40	1.694	4.035	6.838	9.068
45	1.700	4.047	6.834	9.038
50	1.707	4.060	6.833	9.011
55	1.715	4.075	6.834	8.985
60	1.723	4.091	6.836	8.962
70	1.743	4.126	6.845	8.921
80	1.766	4.164	6.859	8.885
90	1.792	4.205	6.877	8.850
95	1.806	4.227	6.886	8.833



## 19.2 Dual Membrane pH Electrode Buffers

### 19.2.1 Mettler-pH/pNa Buffers (Na+ 3.9M)

Temp (°C)	pH of buffer solutions			
0	1.98	3.99	7.01	9.51
5	1.98	3.99	7.00	9.43
10	1.99	3.99	7.00	9.36
15	1.99	3.99	6.99	9.30
20	1.99	4.00	7.00	9.25
25	2.00	4.01	7.00	9.21
30	2.00	4.02	7.01	9.18
35	2.01	4.04	7.01	9.15
40	2.01	4.05	7.02	9.12
45	2.02	4.07	7.03	9.11
50	2.02	4.09	7.04	9.10





For addresses of METTLER TOLEDO  
Market Organizations please go to:  
**[www.mt.com/contacts](http://www.mt.com/contacts)**

**[www.mt.com/pro](http://www.mt.com/pro)**

For more information



Management System  
certified according to  
ISO 9001/ISO 14001



**METTLER TOLEDO Group**  
Process Analytics  
Local contact: [www.mt.com/contacts](http://www.mt.com/contacts)

Subject to technical changes  
© 02/2023 METTLER TOLEDO  
All rights reserved  
Printed in Switzerland. 30 078 302 H

