



© It is forbidden to reprint this instruction manual in whole or part.

No part of this manual may be reproduced in any form, or modified, copied or distributed using electronic systems, in particular in the form of photocopies, photographs, magnetic or other recordings, without written consent of Mettler-Toledo GmbH, Process Analytics, CH-8902 Urdorf, Switzerland.

All rights reserved, in particular reproduction, translation and patenting/registration.

GPro is a trademark of the METTLER TOLEDO Group.

Operation Manual Multi-parameter Transmitter M400 ISM

Content

1	Introduction	9
2	Safety instructions	10
2.1	Definition of equipment and documentation symbols and designations	10
2.2	Correct disposal of the unit	11
2.3	Ex Classification	12
2.4	Ex instructions for M400 series multi-parameter Transmitters – FM Approval	12
2.4.1	Instructions of use to be considered under FM approval	12
2.4.1.1	General notes	14
2.4.1.2	Cautionary notes, warnings and markings	14
3	Unit Overview	17
3.1	M400 1/2 DIN Versions	17
3.2	Menu Structure	18
3.3	Display	19
3.4	Operating Elements	20
3.5	Entry of Data	20
3.6	Selection Menus	20
3.7	“Save changes” Dialog	21
3.8	Security Passwords	21
3.9	Graphic Trend Measurement	21
3.9.1	Activation Trend Display Screen	22
3.9.2	Settings for Trend Display Screen	23
3.9.3	Deactivation Trend Display Screen	23
4	Installation instruction	24
4.1	Unpacking and inspection of equipment	24
4.2	Mounting 1/2 DIN Versions	24
4.2.1	Dimensions 1/2 DIN Version	24
4.2.2	Mounting Procedure – 1/2 DIN Version	25
4.2.3	1/2 DIN – Panel Mounting	26
4.2.4	1/2 DIN Version – Wall Mounting	27
4.2.5	1/2 DIN Version – Pipe Mounting	28
4.3	Electrical Connection	28
4.4	Terminal Definition	29
4.4.1	TB1 Terminal definition – All transmitter versions	30
4.4.2	TB2 Terminal definition	30
4.4.3	TB3 Terminal definition – ISM sensors	31
5	Placing transmitter in, or out, of service	32
5.1	Placing transmitter in service	32
5.2	Placing transmitter out of service	32
6	Calibration	33
6.1	Sensor Calibration	33
6.1.1	Terminate Sensor Calibration	34
6.2	Calibration of UniCond 2-e and UniCond 4-e Sensors	34
6.2.1	Conductivity Calibration of UniCond 2-e and UniCond 4-e Sensors	34
6.2.1.1	One-Point Calibration	36
6.2.1.2	Two-Point Calibration	37
6.2.1.3	Process Calibration	38
6.2.2	Temperature Calibration of UniCond 2-e Sensors and UniCond 4-e Sensors	39
6.2.2.1	One-Point Calibration	39
6.2.2.2	Two-Point Calibration	40
6.3	Calibration of Cond4e Sensors	42
6.3.1	One-Point Calibration	42
6.3.2	Two-Point Calibration	43
6.3.3	Process Calibration	43
6.4	pH Calibration	44
6.4.1	One-Point Calibration	44
6.4.2	Two-Point Calibration	45
6.4.3	Process Calibration	45
6.5	ORP Calibration of pH Sensors	46
6.6	Calibration of Amperometric Oxygen Sensors	46
6.6.1	One-Point Calibration	47
6.6.2	Process Calibration	48

6.7	Calibration of Optical Oxygen Sensors	48
6.7.1	One-Point Calibration	49
6.7.2	Two-Point Calibration	49
6.7.3	Process Calibration	50
6.8	Calibration of Dissolved Carbon Dioxide Sensors	51
6.8.1	One-Point Calibration	51
6.8.2	Two-Point Calibration	52
6.8.3	Process Calibration	53
6.9	Calibration of O ₃ Sensors	54
6.9.1	One-Point Calibration	54
6.9.2	Process Calibration	55
6.10	Sensor Verification	56
6.11	UniCond 2-e Electronics Calibration	57
6.12	Analog Output Calibration	57
6.13	Analog Input Calibration	58
6.14	Maintenance	58
7	Configuration	59
7.1	Measurement	59
7.1.1	Channel Setup	59
7.1.2	ISM sensor	60
7.1.3	Parameter Related Settings	61
7.1.3.1	Conductivity Settings	61
7.1.3.2	pH Settings	62
7.1.3.3	Settings for Oxygen Measurement Based on Amperometric Sensors	64
7.1.3.4	Settings for Oxygen Measurement Based on Optical Sensors	65
7.1.3.5	Dissolved Carbon Dioxide Settings	66
7.1.4	Concentration Curve Table	67
7.2	Analog Outputs	68
7.3	Set Points	69
7.4	ISM Setup	70
7.4.1	Sensor Monitor	70
7.4.2	CIP Cycle Limit	72
7.4.3	SIP Cycle Limit	72
7.4.4	AutoClave Cycle Limit	73
7.4.5	DLI Stress Adjustment	74
7.4.6	SAN Cycle Parameters	74
7.4.7	Reset Counters for UniCond 2-e Sensors	75
7.4.8	Set Calibration Interval for UniCond 2-e Sensors	75
7.5	General Alarm	75
7.6	ISM / Sensor Alarm	76
7.7	Clean	76
7.8	Display Setup	77
7.9	Digital Inputs	77
7.10	System	78
7.11	PID Controller	79
7.12	Service	83
7.12.1	Set Analog Outputs	83
7.12.2	Read Analog Outputs	83
7.12.3	Set Relay	83
7.12.4	Read Relay	83
7.12.5	Read Digital Inputs	83
7.12.6	Memory	84
7.12.7	Display	84
7.12.8	Calibrate TouchPad	84
7.12.9	Channel Diagnostic	84
7.13	User Management	85
7.14	Reset	86
7.14.1	System Reset	86
7.14.2	Reset Sensor Calibration for UniCond 2-e Sensors	86
7.15	USB	87
7.15.1	Printer Output Configuration	87
7.15.2	USB data logging	88
7.16	Configuration via USB	89

8	ISM	90
8.1	iMonitor	90
8.2	Messages	91
8.3	ISM Diagnostics	91
8.3.1	pH/ORP, Oxygen, O ₃ , Cond4e Sensors	92
8.3.2	UniCond 2-e and UniCond 4-e Sensors	92
8.4	Calibration Data	93
8.4.1	Calibration Data for All ISM Sensors excluding UniCond 2-e and UniCond 4-e	93
8.4.2	Calibration Data for UniCond 2-e and UniCond 4-e Sensors	94
8.5	Sensor Info	94
8.6	HW / SW Version	95
9	Custom Key	96
9.1	Set Favorite	96
10	Maintenance	97
10.1	Front panel cleaning	97
11	Software History	98
12	Troubleshooting	99
12.1	Conductivity (resistive) Error messages/Warning- and Alarm list for ISM sensors	100
12.2	pH Error messages/Warning- and Alarm list	100
12.2.1	pH, pH/pNa and Dissolved Carbon Dioxide sensors	100
12.2.2	ORP messages	101
12.3	Amperometric O ₂ Error messages/Warning- and Alarm list	102
12.3.1	High level oxygen sensors	102
12.3.2	Low level oxygen sensors	102
12.3.3	Trace oxygen sensors	103
12.4	Warning- and Alarm Indication	104
12.4.1	Warning Indication	104
12.4.2	Alarm Indication	105
13	Ordering Information, Accessories and Spare Parts	106
14	Specifications	107
14.1	General specifications	107
14.2	Electrical specifications	110
14.3	Environmental specifications	110
14.4	Mechanical specifications	111
15	Warranty	112
16	Buffer tables	113
16.1	Standard pH buffers	113
16.1.1	Mettler-9	113
16.1.2	Mettler-10	114
16.1.3	NIST Technical Buffers	114
16.1.4	NIST standard buffers (DIN and JIS 19266: 2000-01)	115
16.1.5	Hach buffers	115
16.1.6	Ciba (94) buffers	116
16.1.7	Merck Titrisole, Riedel-de-Haën Fixanale	116
16.1.8	WTW buffers	117
16.1.9	JIS Z 8802 buffers	117
16.2	Dual membrane pH electrode buffers	118
16.2.1	Mettler-pH/pNa buffers (Na+ 3.9M)	118

1 Introduction

The M400 is a 4-wire transmitter, with 4(0) to 20 mA output signal and HART or FOUNDATION Fieldbus communication capabilities, for analytical measurements. The M400 is a multi-parameter transmitter and supports the measurements listed in the parameter fit guide below.

The M400 transmitter is designed for use in the process industries.

M400 parameter fit guide

	M400 Type 1 ISM	M400 Type 2 ISM
pH/ORP	•	•
pH/pNa	•	•
UniCond 2-e/4-e	•	•
Conductivity 2-e	–	–
Conductivity 4-e	•	•
Amp. DO ppm/ppb/trace	–	•/• ¹⁾ /–
Opt. DO ppm/ppb	–	•/• ¹⁾
Amp. O ₂ gas ppm/ppb/trace	–	–/–/–
Opt. O ₂ gas ppm	–	–
Dissolved Ozone	–	•
Dissolved Carbon Dioxide	–	•
CO ₂ hi	–	–
GPro™ 500 TDL	–	–

1) Thornton high performance dissolved oxygen and pure water optical sensors only

A black & white touch screen conveys measuring data and setup information. The menu structure allows the operator to modify all operational parameters. A menu-lockout feature, with password protection, is available to prevent the unauthorized use of the meter. The M400 Multi-parameter transmitter can be configured to use up to four analog and/or up to four relay outputs as well as HART communication protocol for process control.

The M400 Multi-parameter transmitter is equipped with a USB communication interface. This interface provides up- and download capabilities of the transmitter configuration via a Personal Computer (PC).

This description corresponds to the firmware release, version 1.0. Changes are taking place constantly, without prior notification.

2 Safety instructions

This manual includes safety information with the following designations and formats.

2.1 Definition of equipment and documentation symbols and designations



WARNING: POTENTIAL FOR PERSONAL INJURY.



CAUTION: Possible instrument damage or malfunction.



NOTE: Important operating information.



On the transmitter or in this manual text indicates: Caution and/or other possible hazard including risk of electric shock (refer to accompanying documents).

The following is a list of general safety instructions and warnings. Failure to adhere to these instructions can result in damage to the equipment and/or personal injury to the operator.

- The M400 Transmitter should be installed and operated only by personnel familiar with the transmitter and who are qualified for such work.
- The M400 Transmitter must only be operated under the specified operating conditions (see chapter "14 Specifications" on page 106).
- Repair of the M400 Transmitter must be performed by authorized, trained personnel only.
- With the exception of routine maintenance, cleaning procedures, as described in this manual, the M400 Transmitter must not be tampered with or altered in any manner.
- Mettler-Toledo accepts no responsibility for damage caused by unauthorized modifications to the transmitter.
- Follow all warnings, cautions, and instructions indicated on and supplied with this product.
- Install equipment as specified in this instruction manual. Follow appropriate local and national codes.
- Protective covers must be in place at all times during normal operation.
- If this equipment is used in a manner not specified by the manufacturer, the protection provided by it against hazards may be void.



WARNINGS:

- Installation of cable connections and servicing of this product require access to shock hazard voltage levels.
- Main power and relay contacts wired to a separate power source must be disconnected before servicing.
- Switch or circuit breaker shall be in close proximity to the equipment and within easy reach of the OPERATOR; it shall be marked as the disconnecting device for the equipment.
- Main power must employ a switch or circuit breaker as the disconnecting device for the equipment.
- Electrical installation must be in accordance with the National Electrical Code and/or any other applicable national or local codes.

**NOTE: RELAY CONTROL ACTION**

the M400 Transmitter relays will always de-energize on loss of power, equivalent to normal state, regardless of relay state setting for powered operation. Configure any control system using these relays with fail-safe logic accordingly.

**NOTE: PROCESS UPSETS**

Because process and safety conditions may depend on consistent operation of this transmitter, provide appropriate means to maintain operation during sensor cleaning, replacement, or sensor or instrument calibration.



NOTE: This is a 4-wire-product with an active 4–20 mA analog output.

Do not supply power to the analog output terminals (TB2: terminal 1 to 8).

2.2 Environmental protection



Waste electrical products should not be disposed of with household waste. Please recycle where facilities exist. Check with your Local Authority or retailer for recycling advice.



2.3 Ex Classification



NOTE: The Ex classification is valid for the transmitters M400 Type 1 and M400 Type 2.

Standards	CSA Std C22.2 No. 213-16;	UL 60079-0-2013
	CAN/CSA-C22.2 No. 60079-0-15	UL 60079-15-2013
	CAN/CSA-C22.2 No. 60079-15-16	EN 60079-0:2012/A11:2013
	ANSI/ISA-12.12.01-2016	EN 60079-15:2010

Special condition of safe use

1. This equipment uses external non-metallic components, therefore may generate an ignition-capable level of electrostatic charge under certain extreme conditions. The user should ensure that the equipment is not installed in a location where it may be subjected to external conditions (such as high pressure steam) which might cause a build up of electrostatic charge on non-conducting surfaces.
2. The display has not been tested for resistance to ultraviolet light. The display shall be protected from direct light (e.g. from sunlight or luminaires).



- **WARNING**
THE EQUIPMENT IS SUITABLE FOR USE IN CLASS I, DIVISION 2, GROUPS A, B, C, D OR NON-HAZARDOUS LOCATIONS ONLY;
- **WARNING**
EXPLOSION HAZARD – DO NOT REMOVE OR REPLACE LAMPS, FUSES OR PLUG-IN MODULES (AS APPLICABLE) UNLESS POWER HAS BEEN DISCONNECTED OR THE AREA IS FREE OF IGNITIBLE CONCENTRATIONS.
- **WARNING**
EXPLOSION HAZARD. DO NOT CONNECT OR DISCONNECT WHILE THE CIRCUIT IS LIVE OR UNLESS THE AREA IS FREE OF IGNITIBLE CONCENTRATIONS;
- **WARNING**
DO NOT OPEN WHEN ENERGISED.
- **WARNING**
THIS EQUIPMENT IS DESIGNED TO BE USED IN RESTRICTED ACCESS LOCATION. ONLY SERVICE PERSONS OR TRAINED PERSONS ARE ALLOWED TO ACCESS THIS EQUIPMENT.

2.4 Ex instructions for M400 series multi-parameter Transmitters – FM Approval

2.4.1 Instructions of use to be considered under FM approval



M400 series multi-parameter transmitters are produced by Mettler-Toledo GmbH. It has passed the inspection of NRTL FM and to following requirements:

US marking	
Operating temperature range	–20 °C to +50 °C (–4 °F to +122 °F)
Environmental designation	Enclosure type 4X, 1P 66
Nonincendive	– Class 1, Division 2, Groups A, B, C, D T4 – Class 1, Zone 2, Group 11C T4
Certificate no.	FM17US0240X
Standards	<ul style="list-style-type: none"> – FM3810:2018 Approval Standard for Electrical Equipment for Measurement, Control and Laboratory Use. – FM3611:2018 Approval Standard for Nonincendive Electrical Equipment for Use in Class 1 & 11, Division 2, and Class 111, Division 1 & 2, Hazardous (Classified) Locations. – FM3600:2018 Approval Standard for Electrical Equipment for Use in Hazardous (Classified) Locations – General Requirements. – ANSI/IEC 60529-2004: R2011 Degrees of Protection Provided by Enclosures (1P Codes). – ANSI/UL 121201: 2017 Nonincendive Electrical Equipment for Use in Class 1 & 2, Division 2, and Class 111, Divisions 1 & 2, Hazardous (Classified) Locations. – ANSI/UL 61010-1: 2016 Safety Requirements for Electrical Equipment for Measurement, Control, and Laboratory Use. – Part 1: General Requirements – ANSI/UL 50E: 2015 Enclosures for Electrical Equipment, Environmental Considerations

2.4.1.1 General notes

The Multi-parameter Transmitter M400 Type 1, 2 are suitable for use in hazardous atmospheres of all combustible materials of explosion groups A, B, C, D for applications requiring Class 1, Division 2 and Class 1, Zone 2 instruments (National Electrical Code® (ANSI/NFPA 70 (NEC®), Article 500.

If the Multi-parameter Transmitter M400 Type 1, 2 is installed and operated in hazardous areas, the general Ex installation regulations as well as these safety instructions must be observed.

The operating instructions as well as the installation regulations and standards that apply for explosion protection of electrical systems must always be observed.

The installation of explosion-endangered systems must always be carried out by qualified personnel.

For mounting instructions on specific valves refer to the mounting instructions supplied with the mounting kit. Mounting does not affect the suitability of the transmitter for use in a potentially hazardous environment.

The equipment is not intended to be used as personal protective equipment. To prevent injury, read the manual before use.

For language translation assistance contact your local representative or email process.service@mt.com

2.4.1.2 Cautionary notes, warnings and markings

Hazardous location notes:

1. Installations in the US shall comply with the relevant requirements of the National Electrical Code® (ANSI/NFPA 70 [NEC®]), Article 500.
2. Installations shall comply with the latest edition of the manufacturer's instruction manual.
3. Care must be taken during installation to avoid impacts or friction that could create an ignition source.
4. Extreme care should be taken with the installation of his equipment, and any problems should be resolved by consultation with the factory or the authorized representative.
5. For equipment marked with an environmental ingress protection rating, provision shall be made for maintaining that environmental ingress protection rating whether the cable assembly is connected to the equipment or not, within the enclosure and within the connector body.
6. Any plugs and sockets incorporated as part of the equipment apparatus shall be capable of being connected to a wiring method as permitted by the National Electrical Code® (ANSI/NFPA 70 [NEC®]) for the involved hazardous (classified) location in accordance with the associated location restrictions.
7. The internal grounding terminal shall be used as the primary equipment grounding means and the external grounding terminal is only for a supplemental (secondary) bonding connection where local authorities permit or require such a connection.
8. Tighten cover screws to 2.5 N·m (22 lb·in.) maximum. Over-torquing may cause enclosure breakage.
9. The minimum tightening torque for M4 (No. 6) binding screw protective conductor terminals is 1.2 N·m (10.6 lb·in.) or greater, as specified.
10. Use copper, copper-clad aluminum or aluminum conductors only.
11. For ambient temperatures above +40 °C (+104 °F) use installation wiring connection suitable for maximum ambient temperatures, as prescribed by the manufacturer.

12. The multi-parameter transmitter must be connected to limited output NEC Class 2 circuits, as outlined in the National Electrical Code® (ANSI/NFPA 70 [NEC®]) only. If the devices are connected to a redundant power supply (two separate power supplies), both must meet this requirement
13. The Class I, Zone 2 certifications are based on Division evaluations and the marking acceptance of Article 505 of the National Electrical Code® (ANSI/NFPA 70 [NEC®]).
14. Tampering and replacement with non-factory components may adversely affect the safe use of the system.
15. The multi-parameter transmitter is intended for servicing or maintenance operation. Mal-functioning units operating out of manufacturer's specification should be returned to the authorized service center for repair. On-site repairs are not permitted.
16. If the equipment is installed via panel-mount configuration within an ultimate enclosure, the inner service temperature of the enclosure corresponds to the ambient temperature of the module.
17. If the panel-mount configuration module is operated in an ambient temperature between +40 °C and +50 °C, the temperature of the module housing may be higher than +50 °C. The device must therefore be installed to that it is only accessible to service personnel or users that are aware of the reason for restricted access and the required safety measures at an ambient temperature of +40 °C to +50 °C.
18. Insertion or withdrawal of removable electrical connectors or modules is to be accomplished only when the area is known to be free of flammable vapors.
- 19. WARNING** – POTENTIAL ELECTROSTATIC CHARGING HAZARD – SEE INSTRUCTIONS.
- 20. WARNING** – SUBSTITUTION OF COMPONENTS MAY IMPAIR SUITABILITY FOR DIVISION 2.
- 21. WARNING** – DO NOT REMOVE OR REPLACE WHILE CIRCUIT IS LIVE WHEN A FLAMMABLE OR COMBUSTIBLE ATMOSPHERE IS PRESENT.
- 22. WARNING** – EXPLOSION HAZARD, DO NOT DISCONNECT EQUIPMENT WHEN A FLAMMABLE OR COMBUSTIBLE ATMOSPHERE IS PRESENT.
- 23. WARNING** – FOR CONNECTION ONLY TO NON-FLAMMABLE PROCESSES.
- 24. WARNING** – SUBSTITUTION OF COMPONENTS MAY IMPAIR SUITABILITY OF THE EQUIPMENT.
- 25. CAUTION** – TO PREVENT INJURY, READ THE MANUAL BEFORE USE.
- 26. WARNING** – TO MAINTAIN THE ENCLOSURE TYPE AND INGRESS PROTECTION RATING, THE COVER MUST BE CLOSED AND SECURED.

The Multi-parameter Transmitter M400 Type 1, 2 ISM non-incentive version, bears the following label marking :

Analog Sensor Input,
See Manual

A	B	C	D	E	F	G	H	I	J	K	L	M	N	O	P	Q
---	---	---	---	---	---	---	---	---	---	---	---	---	---	---	---	---

TB2 (Sensor Input)

D11+	D11-	D12+	D12-	NC	OC1+	OC1-	OC2+	OC2-
1	2	3	4	5	6	7	8	9

HART®

■ ■

+ -

Aout1+	Aout1-	Aout2+	Aout2-	Earth	
10	11	12	13	14	15

TB1 (I/O Terminal) TB1 (Aout)

METTLER TOLEDO

MODEL: M400/2H
 Feeding Voltage: 14 to 30 VDC
 T_[amb]: -20 to +60 °C

P/N: S/N:

MODEL: M400/2H
 Feeding Voltage: 14 to 30 VDC
 T_[amb]: -20 to +60 °C

P/N: S/N:

METTLER TOLEDO
 www.mt.com/pro
 Mettler-Toledo GmbH
 Im Hackacker 15
 8902 Urdorf, Switzerland

Made by METTLER TOLEDO in China

Nonincandive Version

C/US NI/V2/ABCD/T4A
 US NI/V2/IC/T4
 30 VDC, 100 mA, 0.8 W max

Enclosure Type 4X IP66
 -20 °C ≤ T_a ≤ +60 °C
 FM16US0216X, FM16CA0119X

Entry thread: Metric, 5xM20;
 NOTE:
 1. Conduit Hubs/Fittings Entry Thread;
 2. Must use minimum Class 1, Division 2, Groups A, B, C, D, Type 4X and IP66 suitable Hubs/Fittings & Cable Glands to fulfill the complete FM certification.
 Operation Manual No. 30031683

WARNING - EXPLOSION HAZARD. DO NOT REMOVE OR REPLACE WHILE CIRCUIT IS LIVE WHEN A FLAMMABLE OR COMBUSTIBLE ATMOSPHERE IS PRESENT.
 WARNING - POTENTIAL ELECTROSTATIC CHARGE HAZARD. USE ONLY DAMP CLOTH WHEN CLEANING OR WIPING DO NOT USE SOLVENT.
 AVERTISSEMENT - RISQUE D'EXPLOSION. NE PAS DÉBRANCHER TANT QUE LE CIRCUIT EST SOUS TENSION, À MOINS QU'IL NE S'AGISSE D'UN EMPLACEMENT NON DANGEREUX

3 Unit Overview

The M400 transmitter is available as 1/2 DIN version.

For dimensions refer to chapter "13 Ordering Information, Accessories and Spare Parts" on page 105.

3.1 M400 1/2 DIN Versions

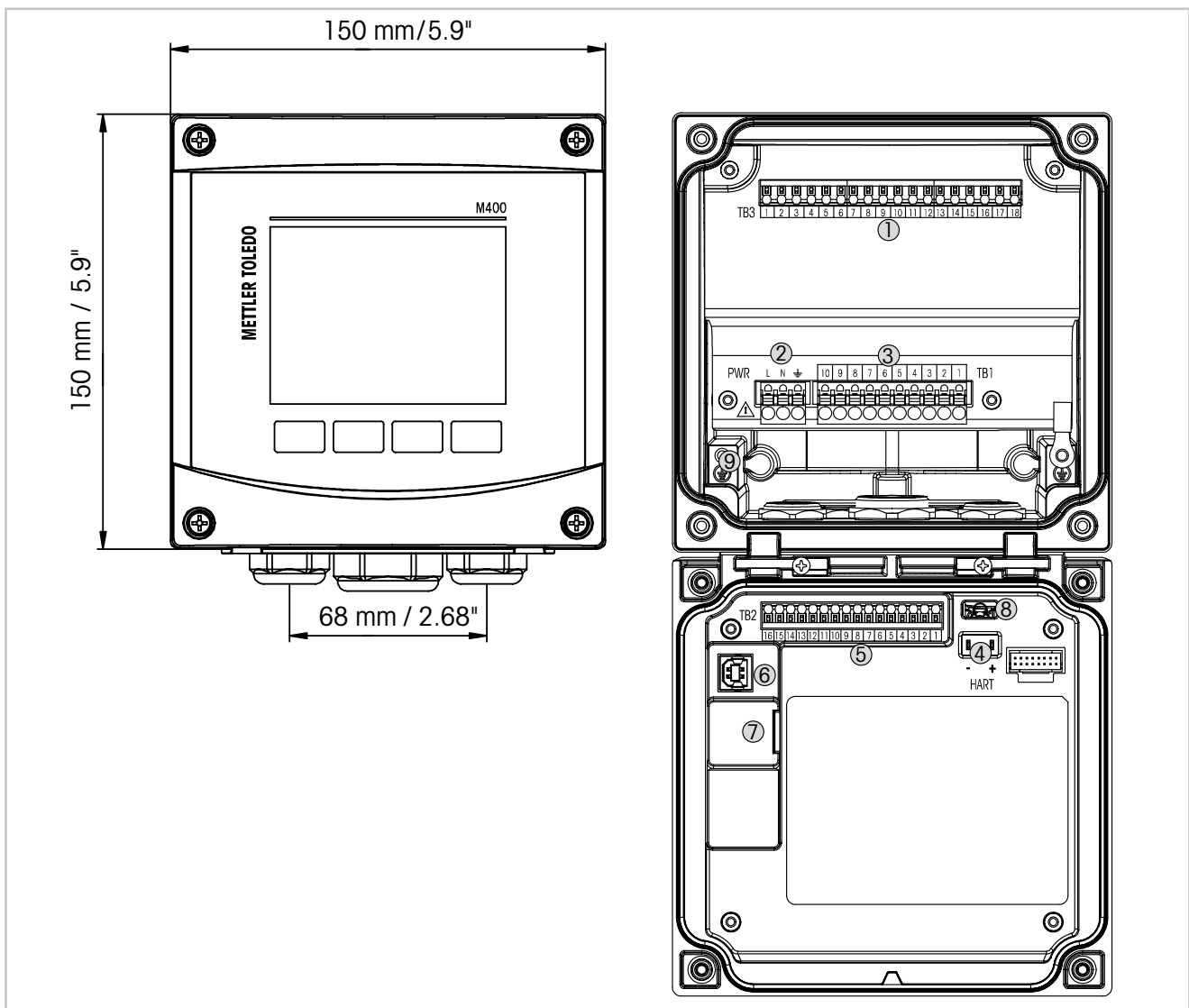

Fig. 1: M400 1/2 DIN versions

- 1 TB3 – Terminal block for sensor connection
- 2 Terminals for supply voltage
- 3 TB1 – Terminal block for relay outputs
- 4 HART, for M400 Type 1, Type 2, Type 3 only
- 5 TB2 – Terminal block for analog output and digital input signals
- 6 USB Device – Software update interface
- 7 USB Host – Printer connection, data logging, loading and saving configuration
- 8 **Warning! Do not disconnect the internal ground wire between the front and back modules.**
- 9 **Warning! Tightly secure an earth wire to the internal PE screw terminal:
⊥ (Protective Conductor Terminal).
The cross-section of the PE wire must be above 18 AWG (0.8 mm).**



3.2 Menu Structure

Below is the structure of the M400 menu tree:

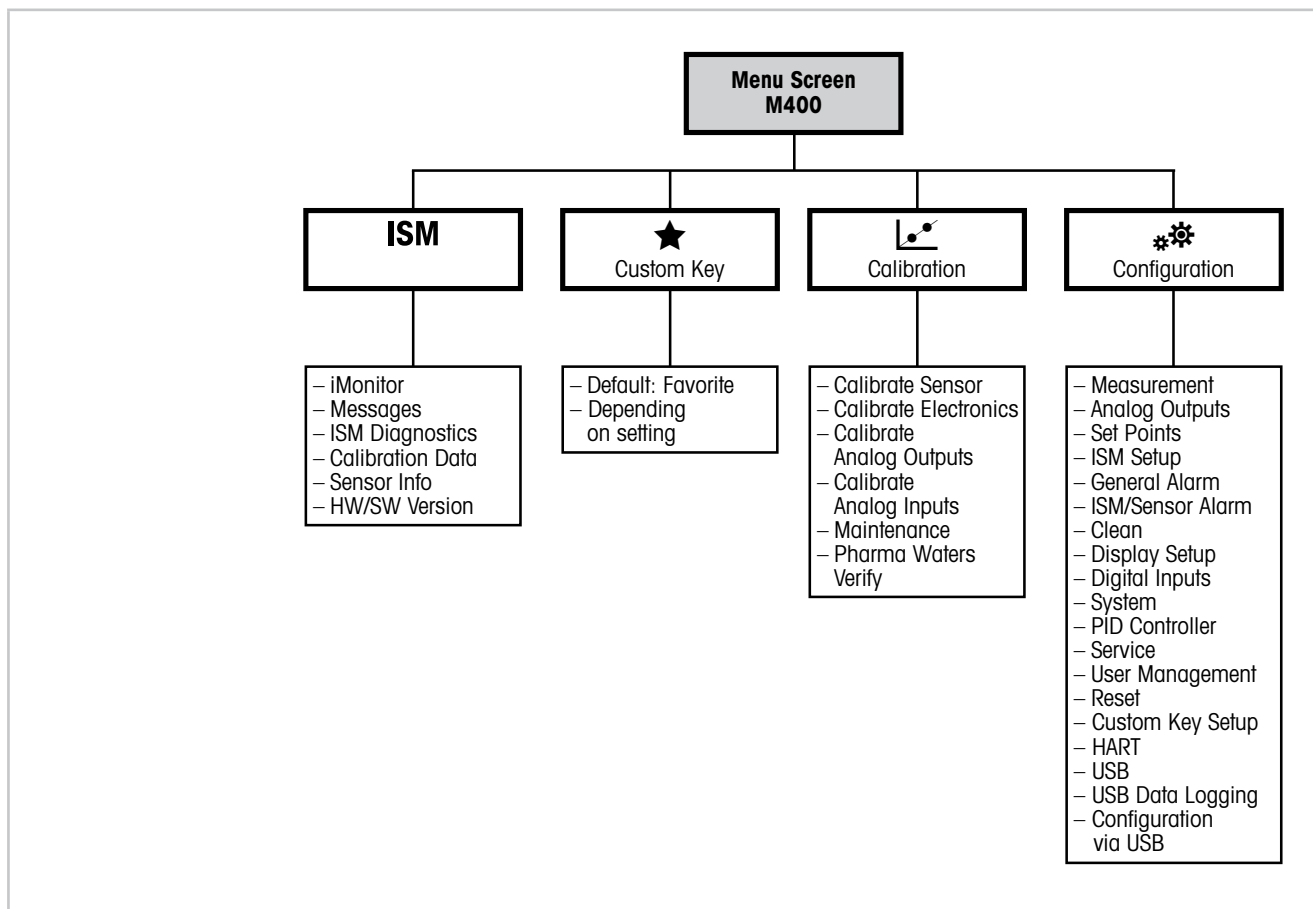

Fig. 2: Menu overview

3.3 Display

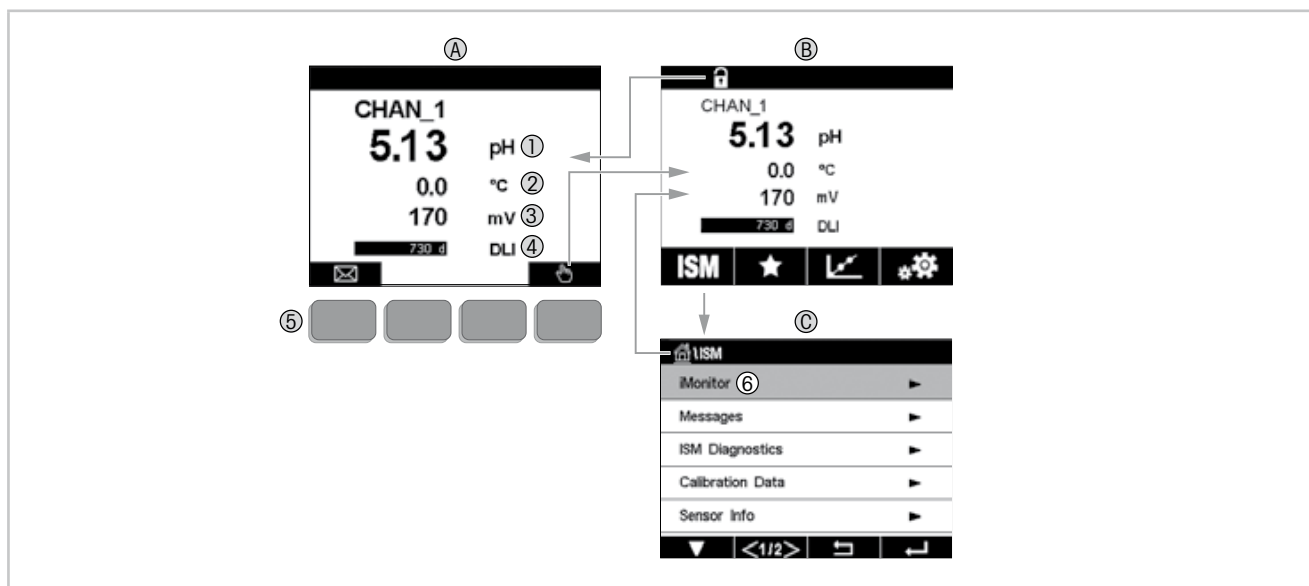



Fig. 3: M400 Display, navigation

A Start screen (example)

- 1 1st line, standard configuration
- 2 2nd line, standard configuration
- 3 3rd line, depends on configuration
- 4 4th line, depends on configuration
- 5 Soft key with indicated functions on the screen
- 6 Cursor, indicates the current item for soft key operation











B Menu screen (example)

C ISM Menu screen

 **NOTE:** In the event of an alarm or other error conditions the M400 Transmitter will display a symbol in the head line of the display. This head line is blinking until the condition that caused it has been cleared (see chapter "12.4 Warning- and Alarm Indication" on page 103).

 **NOTE:** During calibrations, clean, Digital In with Analog Output/Relay/USB in HOLD state, a flashing "H" (HOLD) will appear in the upper right corner of the display for the corresponding channel. This symbol will remain for 20 sec., after end of calibration. This symbol will remain for 20 seconds until after the calibration or clean is completed. This symbol will also disappear when Digital In is deactivated.

3.4 Operating Elements

Operating element	Description
	Enter Messages menu
	Enter Menu screen
	Enter Start screen
ISM	Enter ISM menu
	Enter Favorite menu
	Enter Calibration menu
	Enter Configuration menu
	Return to Menu screen
	Enter next-lower menu level, here e.g. iMonitor, Messages or ISM Diagnostics
	Return to next-higher menu level
	Navigate menu for soft key operation
	Enter selected menu or item for soft key operation

3.5 Entry of Data

The M400 displays a keypad for modifying values. Press the  button and the transmitter will store the value. Press the ESC button to exit the keypad without changing data.

 **NOTE:** For some values, the units can be modified. In this case the keypad shows a button with a U. To select another unit for the entered value on the keypad press the U button. To return again press the 0–9 button.

 **NOTE:** For some entries letters and/or numbers can be used. In this case the keypad shows a button 'A,a,0'. Press this button to change between capital letters, small letters and numbers on the keypad.

3.6 Selection Menus

Some menus require a selection of a parameter / data. In this case the transmitter displays a pop up window. Press the according field to select the value. The pop-up window will be closed and the selection will be stored.

3.7 “Save changes” Dialog

If the M400 brings up the “Save changes” dialog there are the following options. No will discard the entered values, Yes will save changes made and Cancel will bring you back to continue configuring.

3.8 Security Passwords

The M400 Transmitter allows a security lock-out of various menus. If the security lock-out feature of the transmitter has been enabled, a security password must be entered to allow access to the menu. See chapter “7.13 User Management” on page 85.

3.9 Graphic Trend Measurement

Any single measurement may be displayed as a trend measurement over time. Measurement values will be indicated by a value on the Y-axis and time elapsed on the X-axis of the graph displayed. An actual measurement for the selected value will also be displayed numerically above the graphic trend display. The measurement value is refreshed once per second.

Graphic trending will only display the data within maximum/minimum range. Out of range values or invalid values will not be displayed. The Y-axis will display the maximum value unit with its range; X-axis unit uses “mins” for minutes for measurements less than one hour and “hrs” for one day. 4 scales for X/Y-axis. The maximum value on Y-axis is one decimal place.

3.9.1 Activation Trend Display Screen

While the M400 is displaying the Menu Screen, touch any measurement value line of the display screen once to activate the trend display for that measurement. Or you can use custom key setup to access this function when operating with tactile keys. (See chapter "9 Custom Key" on page 96.)

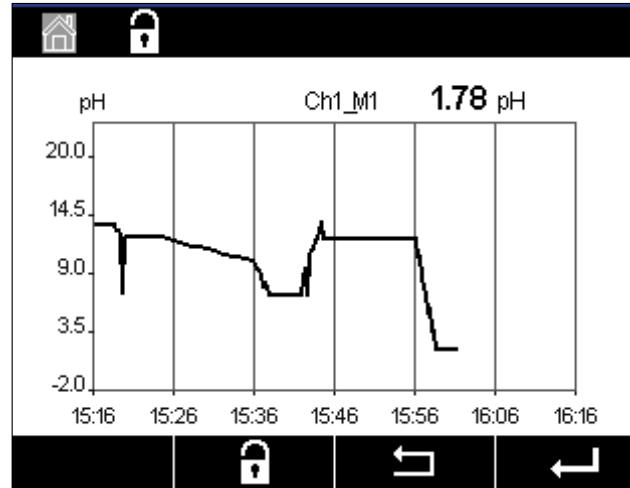

When a sensor is disconnected/connected a pop-up window will appear; after closing the window, the display will return to the Menu Screen.

The top line will display any message that occurs during trending. "H", "P" will display when this channel is in hold or process.

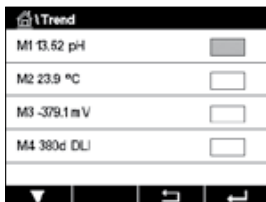

When using custom key setup to access trend display, press second left soft key after setting trend as the custom key. (See chapter "9 Custom Key" on page 96)

Use ▼ and ↶ to select the measurement.

3.9.2 Settings for Trend Display Screen

For setting configurations, touch any area of the graphic trend display to go to the pop-up window of this measurement parameter. Settings are at the default values. However, these settings may be changed when options are available, as needed.

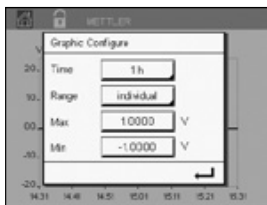

Time: Option button. For graphic display time (X-axis)

1-h (default value)

1-day



NOTE: 1 h means: 1 meas storage/15 seconds, totally 240 measurements for 1h. 1 day means: 1 meas storage/6 minutes, totally 240 measurements for 1 day;

Range: Option button

Default(default value)

Individual

When "Default" modes are set for the maximum or minimum value, this indicates the full measurement range for this unit. A Max or Min button is not displayed. If setting is selectable, the user can set maximum and minimum settings manually.

Max: Edit button.

Maximum value of this unit on Y-axis. xxxxxx, floating decimal point.

Min: Edit button.

Minimum value of this unit on Y-axis. xxxxxx, floating decimal point.

Max Value > Min Value



NOTE: Settings for Y-and Y-axis and the corresponding measurement values are stored the transmitters memory. A power down returns to default settings.

3.9.3 Deactivation Trend Display Screen

Press  in activated graphic trend screen to return to Menu Screen.



NOTE: If a sensor is disconnected/connected a pop-up window come up; after closing the window, it will go back to the Menu Screen.

4 Installation instruction

4.1 Unpacking and inspection of equipment

Inspect the shipping container. If it is damaged, contact the shipper immediately for instructions. Do not discard the box.

If there is no apparent damage, unpack the container. Be sure all items shown on the packing list are present.

If items are missing, notify Mettler-Toledo immediately.

4.2 Mounting 1/2 DIN Versions

4.2.1 Dimensions 1/2 DIN Version

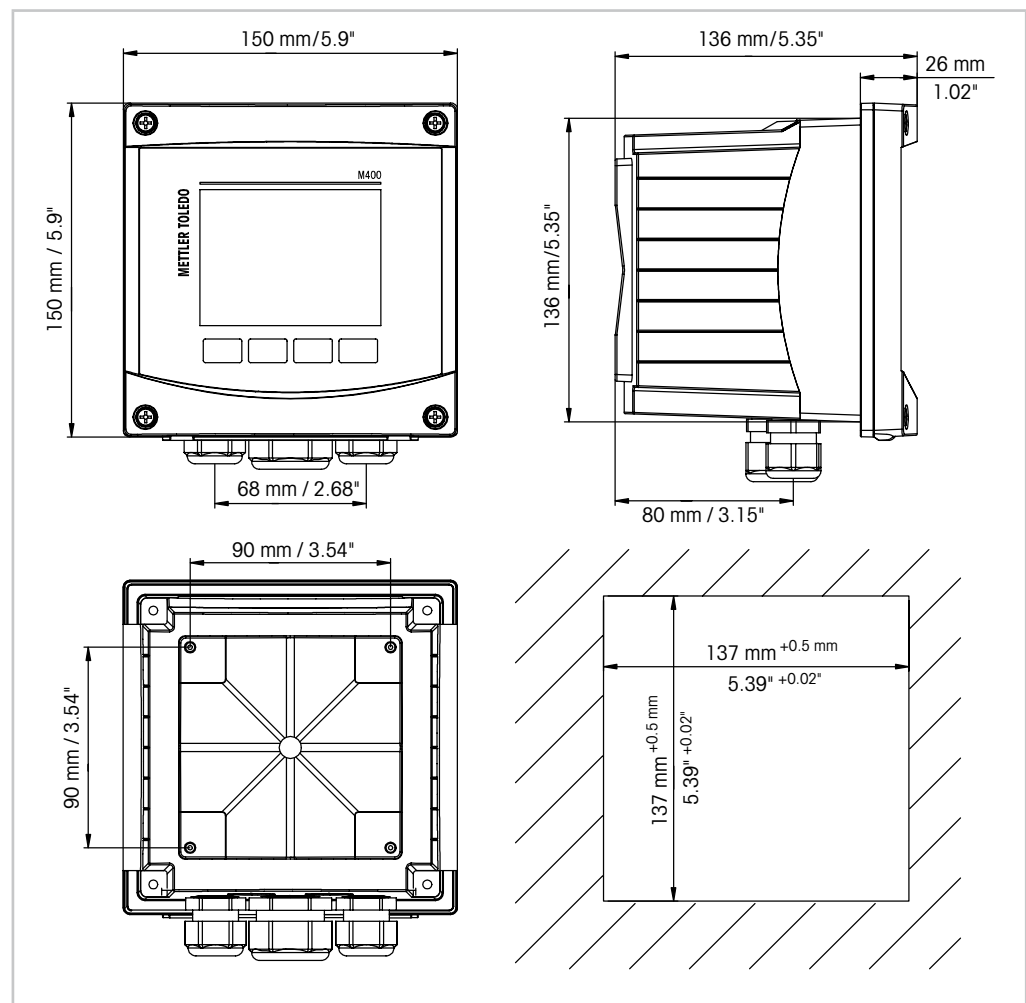

Fig. 4: Dimensions 1/2 DIN version

1 Dimensions for panel cutout

4.2.2 Mounting Procedure – 1/2 DIN Version

1/2 DIN versions transmitters are designed for the following mounting versions: panel mount, wall mount or pipe mount. For wall mount the integral rear cover is used.

Optional hardware accessories are available that allow for panel- or pipe-mount. Refer to section "13 Ordering Information, Accessories and Spare Parts" on page 105.

Assembly:

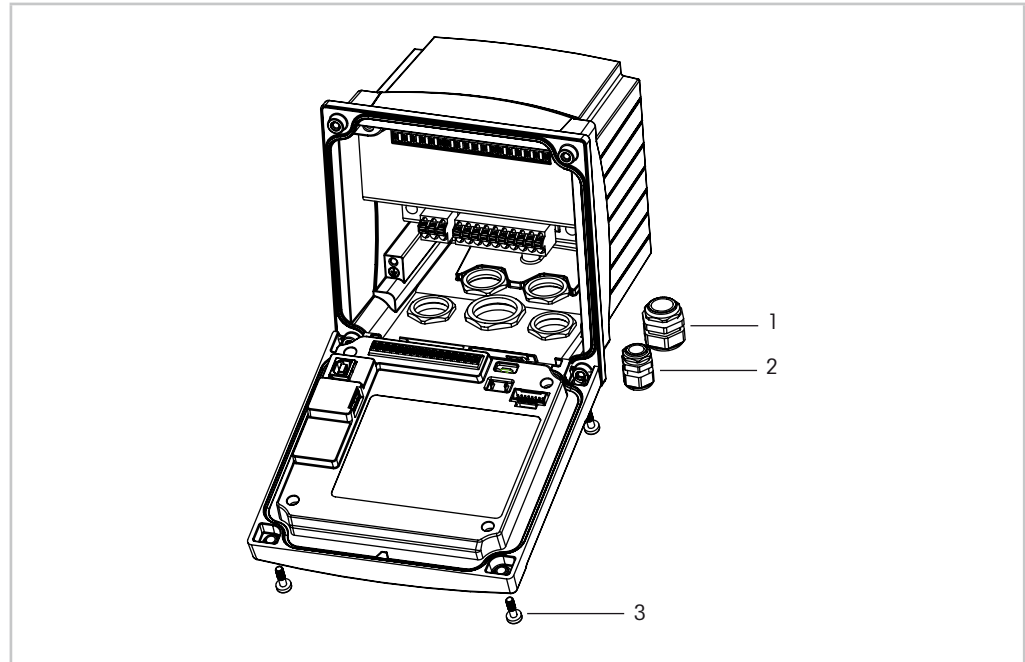

Fig. 5: Assembly

- 1 1 piece M25 x 1.5 cable gland
- 2 4 pieces M20 x 1.5 cable glands
- 3 4 pieces screws

General:

- Orient the transmitter so that the cable grips face downward.
- Wiring routed through the cable grips shall be suitable for use in wet locations.
- In order to provide IP66 enclosure ratings, all cable glands must be in place. Each cable gland must be filled using a cable.
- Tighten the screws of the front panel with a tightening torque of 2 Nm to 2.5 Nm.

4.2.3 1/2 DIN – Panel Mounting

To insure a good seal, the panel or door must be flat and have a smooth finish. Textured or rough surfaces are not recommended and may limit the effectiveness of the gasket seal provided.

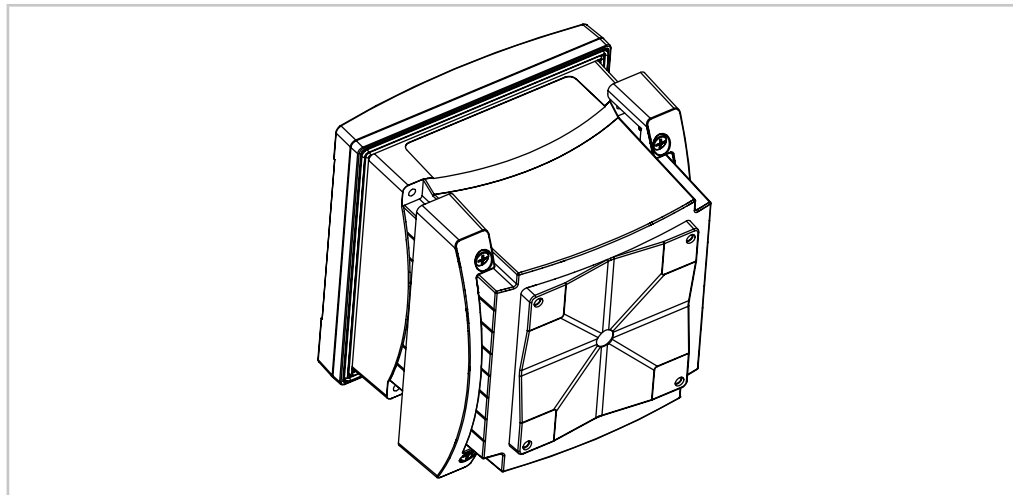

Fig. 6: Panel mounting

1. Make cutout in panel. For dimensions refer to chapter "4.2.1 Dimensions 1/2 DIN Version" on page 24.
 - Be sure surface surrounding cutout is clean, smooth and free of burrs.
2. Slide face gasket around transmitter from the back of the unit.
3. Place transmitter into cutout hole. Be sure there are no gaps between the transmitter and panel surface.
4. Place the two mounting brackets on either side of the transmitter as shown.
5. While holding transmitter firmly into the cutout hole, push the mounting brackets toward the backside of panel.
6. Once secure, use a screwdriver to tighten the brackets against the panel. In order to provide IP66 environmental enclosure rating, the two clamps provided shall be securely tightened to create an adequate seal between the panel enclosure and transmitter.
 - Face gasket will compress between transmitter and panel.

4.2.4 1/2 DIN Version – Wall Mounting



DANGER! Mortal danger by electric shock or risk of electrical shock: The maximum screw-in depth of the mounting holes in the housing is 12 mm (0.47 inch). Do not exceed maximum screw-in depth.

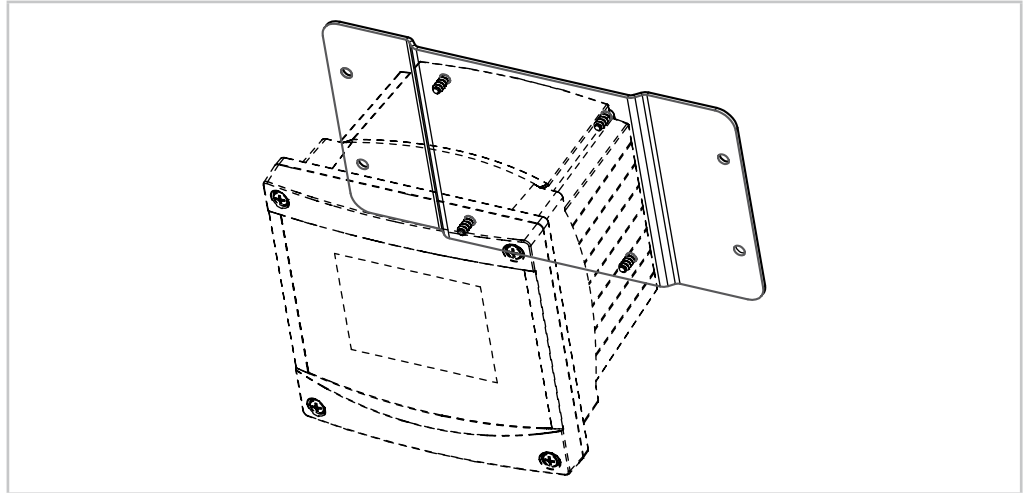

Fig. 7: Wall mounting with wall mounting kit

1. Mount wall mounting kit to the housing. Do not exceed maximum screw-in depth.
2. Mount wall mounting kit with the housing to the wall.
Attach to wall using appropriate mounting hardware for wall surface. Be sure it is level and securely fastened and the installation adheres to any and all clearance dimensions required for transmitter service and maintenance. Orient the transmitter so that the cable grips are facing downward.

4.2.5 1/2 DIN Version – Pipe Mounting

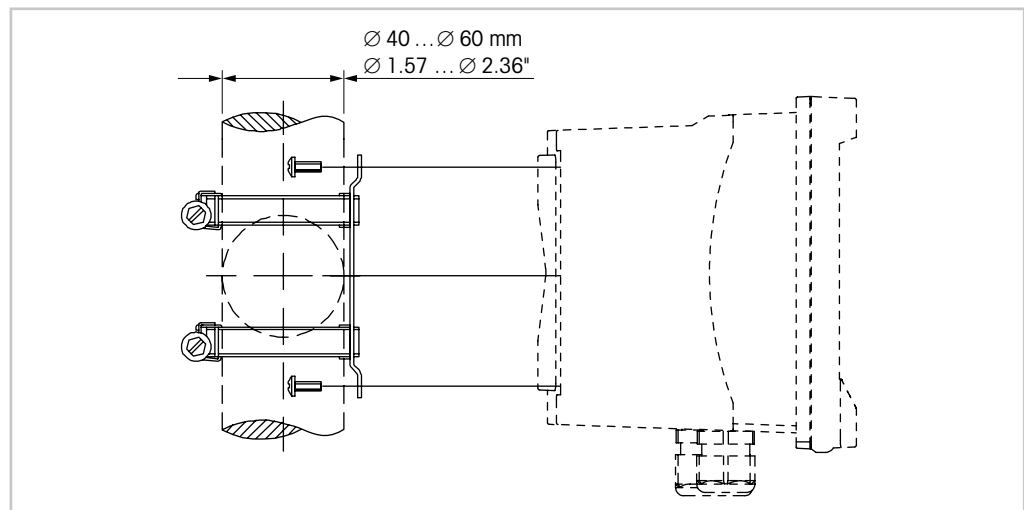

Fig. 8: Pipe mounting 1/2 DIN version

- Use only manufacturer-supplied components for pipe-mounting the M400 transmitter. See chapter “13 Ordering Information, Accessories and Spare Parts” on page 105 for ordering information.
- Tighten the fixing screws with a tightening torque of 2 to 3 Nm.

4.3 Electrical Connection



DANGER! Mortal danger by electric shock: Power off instrument during electrical connection.

1. Switch off supply voltage.
2. Connect mains supply to the terminals L, N, and \perp (Ground).
3. Connect sensor to terminal block TB3.
4. Connect analog output, analog input and digital input signals to terminal block TB2.
5. Connect relay output signals to terminal block TB1.
6. Connect the HART modem to AO1+/HART+ and AO1-/HART- for HART communication (communication load 230–500 ohm). Notice polarity.
7. Connect FOUNDATION fieldbus to FF+ and FF- for FF communication. Notice polarity.

For terminal definitions refer to the Operation Manual.

This is a 4-wire-product with an active 4–20 mA analog output. Do not supply power to the analog output terminals. M400 4-wire FF version has no analog outputs.



Warning! Do not disconnect the internal ground wire between the front and back modules.

Warning! Tightly secure an earth wire to the internal PE screw terminal:

\perp (Protective Conductor Terminal).

The cross-section of the PE wire must be above 18 AWG (0.8 mm).

4.4 Terminal Definition

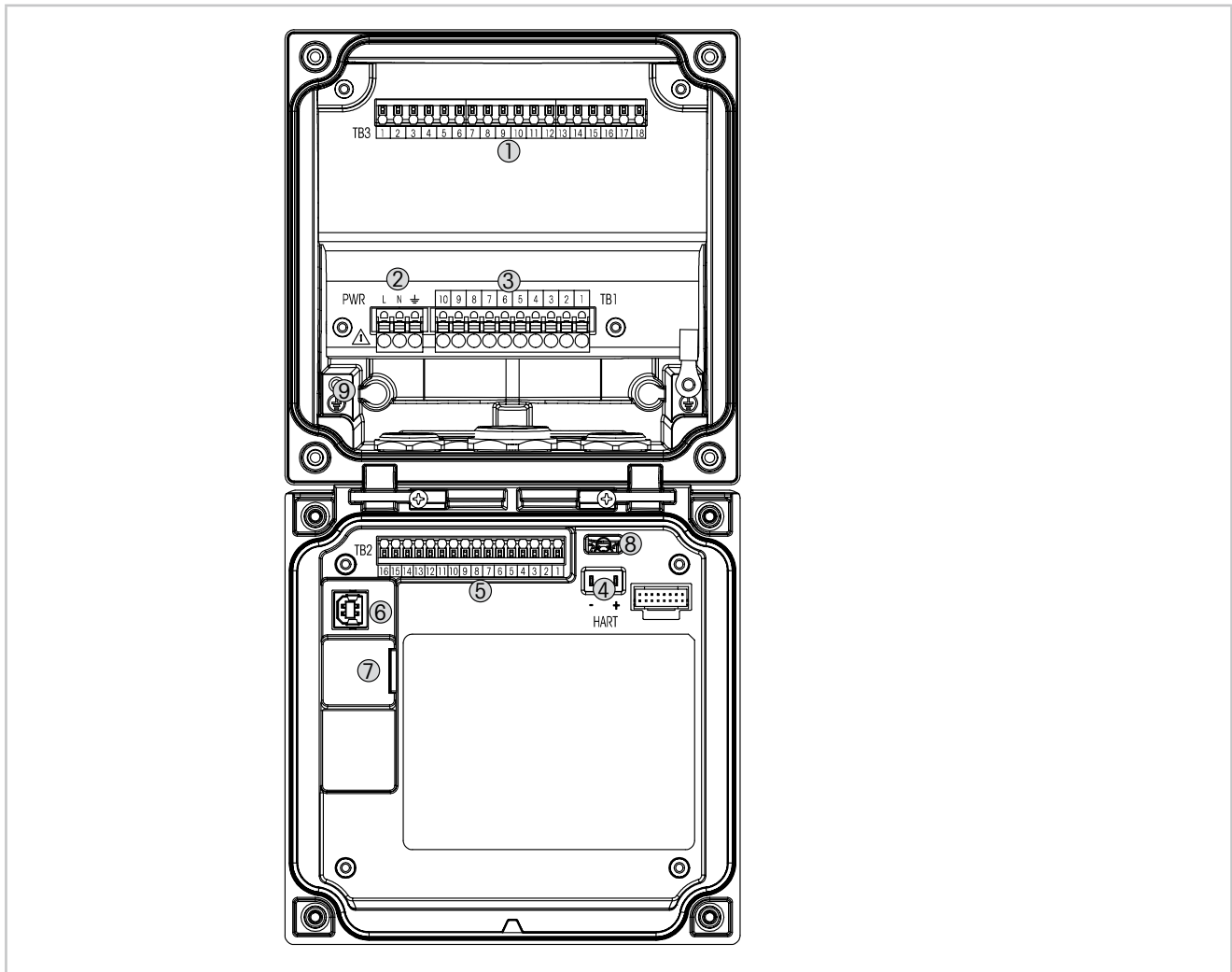

Fig. 9: M400 1/2 DIN versions

- 1 TB3 – Terminal block for sensor connection
- 2 Terminals for supply voltage
- 3 TB1 – Terminal block for relay outputs
- 4 HART, for M400 Type 1, Type 2, Type 3 only
- 5 TB2 – Terminal block for analog output and digital input signals
- 6 USB Device – Software update interface
- 7 USB Host – Printer connection, data logging, loading and saving configuration
- 8 **Warning! Do not disconnect the internal ground wire between the front and back modules.**
- 9 **Warning! Tightly secure an earth wire to the internal PE screw terminal:
⏚ (Protective Conductor Terminal).
The cross-section of the PE wire must be above 18 AWG (0.8 mm).**



4.4.1 TB1 Terminal definition – All transmitter versions

Terminal	Description	Contact rating
1	NO 1	250VAC or 30VDC, 3 A
2	COM	
3	NC 1	
4	NO 2	250VAC or 30VDC, 3 A
5	COM	
6	NC 2	
7	NO 3	250VAC or 30VDC, 0.5 A, 10 W
8	COM	
9	NO 4	250VAC or 30VDC, 0.5 A, 10 W
10	COM	

4.4.2 TB2 Terminal definition

Type 1, 2, 3		FF version	
Terminal	Description	Terminal	Description
1	AO 1 +/HART +	1	FF+
2	AO 1 –/HART –	2	FF-
3	AO 2 +	3	FF+
4	AO 2 –	4	FF–
5	AO 3 +	5	Not used
6	AO 3 –	6	Not used
7	AO 4 +	7	Not used
8	AO 4 –	8	Not used
9	DI 1 +	9	DI1+
10	DI 1 –/DI 2 –	10	DI1–/DI2–
11	DI 2 +	11	DI2+
12	AI +	12	AI+
13	AI –	13	AI–
14 to 16	Not used	14 to 16	Not used

4.4.3 TB3 Terminal definition – ISM sensors

pH/ORP, amperometric oxygen, dissolved ozone, conductivity 4-e, dissolved CO₂ low

Terminal	Function	Color
1 to 11	Not used	–
12	1-wire	Transparent (cable core)
13	GND	Red (shield)
14	RS485-B	–
15	RS485-A	–
16	5V	–
17	GND 24V	–
18	24V	–

UniCond 2-e, UniCond 4-e

Terminal	Function	Color
1 to 12	Not used	–
13	GND	White
14	RS485-B	Black
15	RS485-A	Red
16	5V	Blue
17 to 18	Not used	–

Optical oxygen

Terminal	Function	VP8 cables wire color	5-pin cables wire color
1 to 12	Not used	–	–
13	GND	Green/Yellow	Gray/Yellow
14	RS485-B	Brown	Blue
15	RS485-A	Pink	White
16	5V	–	–
17	GND (24V)	Blue	Black
18	24V	Grey	Brown

5 Placing transmitter in, or out, of service

5.1 Placing transmitter in service



After connecting the transmitter to power supply circuit, it will be active as soon as the circuit is powered.

5.2 Placing transmitter out of service

First disconnect the unit from the main power source, then disconnect all remaining electrical connections. Remove the unit from the panel. Use the installations instruction in this manual as reference for dis-assembling mounting hardware.

All transmitter settings stored in memory are non volatile.

6 Calibration

For the menu structure refer to chapter "3.9 Graphic Trend Measurement" on page 21.

PATH:  \ Cal



NOTE: During calibration, the outputs for the corresponding channel will default to be held at their current values until 20 seconds after the calibration menu is exited. A flashing H appears in the upper right corner of the display while outputs are held. Refer to chapter "7.2 Analog Outputs" on page 68 and chapter "7.3 Set Points" on page 69 to change the HOLD output status.

6.1 Sensor Calibration

PATH:  \ Cal \ Calibrate Sensor

Depending on sensor type, the following choices are available:

ISM sensor	Calibration task
pH	pH, ORP, Verify
Conductivity	Conductivity, Resistivity, Verify
Amp. Oxygen	Oxygen, Verify
Ozone	Ozone, Verify
Opt. Oxygen	Oxygen, Verify
Carbon Dioxide	Carbon dioxide, Verify

6.1.1 Terminate Sensor Calibration

After every successful calibration different options are available. If "Adjust" or "Calibrate" is chosen, the message "Calibration saved successfully! Reinstall sensor" is displayed. Press "Done" to return to the measuring mode.

Option	ISM (digital) sensors
Adjust	Calibration values are stored in the sensor and used for the measurement. Additionally, the calibration values are stored in the calibration history.
Calibrate	Calibration values are stored in the calibration history for documentation, but not be used for the measurement. The calibration values from the last valid adjustment are further used for the measurement.
Cancel	Calibration values are discarded.

6.2 Calibration of UniCond 2-e and UniCond 4-e Sensors

6.2.1 Conductivity Calibration of UniCond 2-e and UniCond 4-e Sensors

The M400 provides the ability to perform a one-point, two-point or process conductivity or resistivity calibration for 2-e-sensors and 4-e-sensors.



NOTE: When performing calibration on a conductivity sensor, results will vary depending on the method, calibration apparatus and/or quality of reference standards used to perform the calibration.



NOTE: For measuring tasks the temperature compensation for the application as defined through the parameter settings for conductivity will be considered and not the temperature compensation selected through the calibration procedure (see also chapter "7.1.3.1 Conductivity Settings" on page 61; PATH: \CONFIG\Meas\Parameter Setting).

Enter the menu Calibrate Sensor (see chapter "6.1 Sensor Calibration" on page 33; PATH: \Cal\ Calibrate Sensor) and choose the desired channel for calibration.

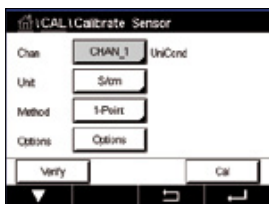

The following menus can be called up:

Unit: Choose between the units for conductivity (S/cm) and resistivity (Ω -cm).

Method: Select the desired calibration procedure. Available are 1-point, 2-point or process calibration.

Options: The desired compensation mode for the calibration process can be selected.

Choices are "None", "Standard", "Light 84", "Std 75 °C", "Linear 25°C", "Linear 20°C", "Glycol.5", "Glycol1", "Cation", "Alcohol" and "Ammonia".

None does not make any compensation of the measured conductivity value. The uncompensated value will be displayed and proceeded.

Standard compensation includes compensation for non-linear high purity effects as well as conventional neutral salt impurities and conforms to ASTM standards D1125 and D5391.

Light 84 compensation matches the high purity water research results of Dr. T.S. Light published in 1984. Use only if your institution has standardized on that work.

Std 75 °C compensation is the Standard compensation algorithm referenced to 75 °C. This compensation may be preferred when measuring Ultrapure Water at an elevated temperature (Resistivity of ultrapure water compensated to 75 °C is 2.4818 Mohm-cm.)

Linear 25 °C compensation adjusts the reading by a coefficient or factor expressed as %/°C (deviation from 25 °C). Use only if the solution has a well-characterized linear temperature coefficient. The factory default setting is 2.0%/°C. (2.4818 Mohm-cm.)

Linear 20 °C compensation adjusts the reading by a coefficient or factor expressed as %/°C (deviation from 20 °C). Use only if the solution has a well-characterized linear temperature coefficient. The factory default setting is 2.0%/°C.

Glycol.5 compensation matches the temperature characteristics of 50% ethylene glycol in water. Compensated measurements using this solution may go above 18 Mohm-cm.

Glycol1 compensation matches the temperature characteristics of 100% ethylene glycol. Compensated measurements may go well above 18 Mohm-cm.

Alcohol compensation provides for the temperature characteristics of a 75% solution of isopropyl alcohol in pure water. Compensated measurements using this solution may go above 18 Mohm-cm.



NOTE: If compensation mode "Linear 25 °C" or "Linear 20 °C" has been chosen, the coefficient for the adjustment of the reading can be modified. In this case an additional input field will be displayed.

The changes are valid until the calibration mode has been escaped. After the values defined in the configuration menu are valid again.

6.2.1.1 One-Point Calibration

Select calibration procedure 1-Point (see chapter "6.2.1 Conductivity Calibration of UniCond 2-e and UniCond 4-e Sensors" on page 34). With 2-e-sensors or 4-e-sensors a one-point calibration is always performed as a slope calibration. The following procedure shows the calibration with a 2-e-sensor. The calibration with a 4-e-sensor works respectively.

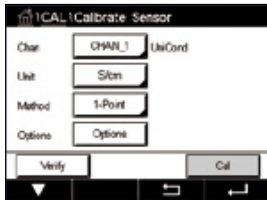

Press the button Cal for starting calibration.



Place the electrode in the reference solution and press Next button.

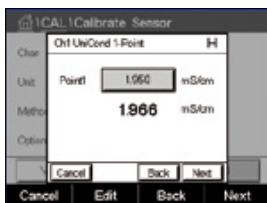

The second value displayed on the screen is the value being measured by the transmitter and sensor in units selected by the user.

Press the input field for **Point1** to enter the value for the calibration point. The M400 displays a keypad for modifying the value. Press the \leftarrow button and the transmitter will take over the value.



NOTE: To select another unit for the entered value on the keypad press the U button. To return again press the 0-9 button.

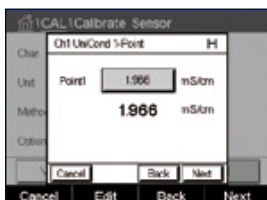

The screen shows the entered value for the reference solution (1st line) and the measured value of the M400 (2nd line).

Press the Next button to start the calculation of the calibration results.

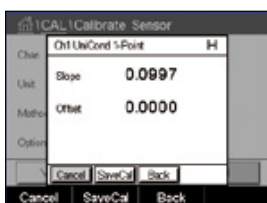

The display shows the value for the slope and the offset as the result of the calibration.

The calibration values are stored in the calibration history and taken over (press button SaveCal) or discarded (press button Cancel).

Use the Back button to go one step back in the calibration procedure.



6.2.1.2 Two-Point Calibration

Select calibration procedure 2-Point. With 4-e-sensors a two-point calibration is always performed as an offset and slope calibration. The following procedure shows the calibration with a 4-e-sensor.

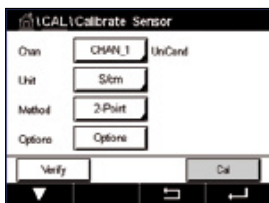

Press the button Cal for starting calibration.



Place the electrode in the first reference solution and press Next button.

CAUTION: Rinse sensors with a high-purity water solution between calibration points to prevent contamination of the reference solutions.

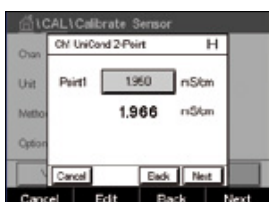

The second value displayed on the screen is the value being measured by the transmitter and sensor in the units selected by the user.

Press the input field for **Point1** to enter the calibration point. The M400 displays a keypad for modifying the value. Press the \leftarrow button to accept the value.



NOTE: To select another unit for the entered value on the keypad press the U button. To return again press the 0-9 button.

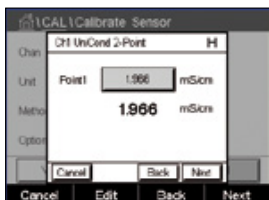

The screen shows the entered value for the first reference solution (1st line) and the measured value of the M400 (2nd line).

Press the Next button to go on with the calibration.



Place the electrode in the second reference solution and press Next button.

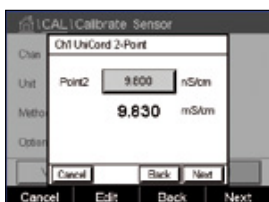

The second value displayed on the screen is the value being measured by the transmitter and sensor in the units selected by the user.

Press the input field for **Point2** to enter the calibration point. The M400 displays a keypad for modifying the value. Press the \leftarrow button to accept the value.



NOTE: To select another unit for the entered value on the keypad press the U button. To return again press the 0-9 button.

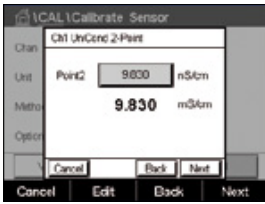

The screen shows the entered value for the second reference solution (1st line) and the measured value of the M400 (2nd line).

Press the Next button to start the calculation of the calibration results.



The display shows the value for the slope and the offset as the result of the calibration.

The calibration values are stored in the calibration history. To save (press button SaveCal) or to discard (press button Cancel).

Use the Back button to go one step back in the calibration procedure.

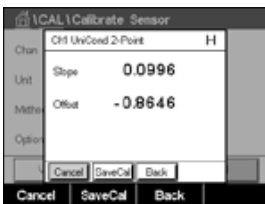

6.2.1.3 Process Calibration

Select calibration procedure Process (see chapter "6.2.1 Conductivity Calibration of UniCond 2-e and UniCond 4-e Sensors" on page 34). With 2-e-sensors or 4-e-sensors a process calibration is always performed as a slope calibration. The following procedure shows the calibration with a 2-e-sensor. The calibration with a 4-e-sensor works respectively.

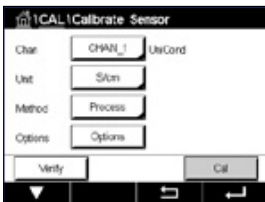

Press the button Cal for starting calibration.

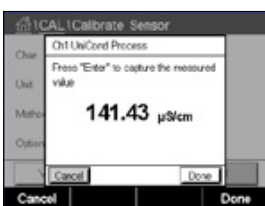

Take a sample and press the DONE button to store the current measuring value. To show the ongoing calibration process, P is blinking in the Start and Menu screen if the related channel is selected in the display.

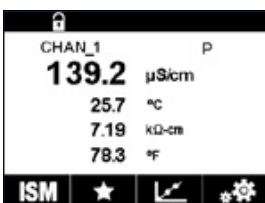

After determining the conductivity value of the sample, press the calibration icon in the Menu Screen again.



Press the input field for **Point1** and enter the conductivity value of the sample. Press the Next button to start the calculation of the calibration results.

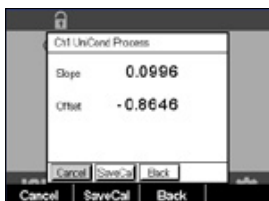

The display shows the value for the slope and the offset as the result of the calibration.

The calibration values are stored in the calibration history. To save (press button SaveCal) or to discard (press button Cancel).

Use the Back button to go one step back in the calibration procedure.



6.2.2 Temperature Calibration of UniCond 2-e Sensors and UniCond 4-e Sensors

The M400 provides the ability to perform a one-point or two-point calibration for the temperature sensor of the UniCond 2-e and UniCond 4-e.

Enter the menu Calibrate Sensor (see chapter “6.1 Sensor Calibration” on page 33; PATH: \ Cal \ Calibrate Sensor).

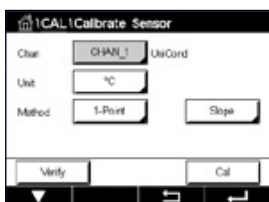

The following menus can be called up:

- Unit:** Choose between the units °C and °F.
- Method:** Select the desired calibration procedure. Available are 1-point and 2-point calibration.

6.2.2.1 One-Point Calibration

Select calibration procedure 1-Point. With 2-e-sensors or 4-e-sensors a one-point temperature calibration can be performed as a slope or offset calibration. The following procedure shows the calibration with a 2-e-sensor. The calibration with a 4-e-sensor works respectively.

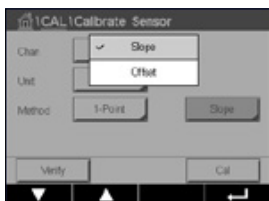

Press the right input field for the parameter **Method**. Choose Slope or Offset calibration through pressing the corresponding field.

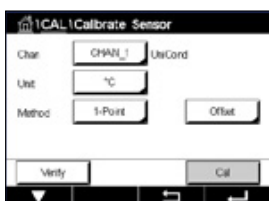

Press the button Cal for starting calibration.



Place the electrode in the reference solution and press Next button.

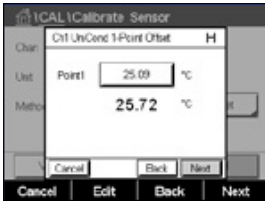

The second value displayed on the screen is the value being measured by the transmitter and sensor.

Press the input field or EDIT button for **Point1** to enter the value for the calibration point. The M400 displays a keypad for modifying the value. Press the \leftarrow button to accept the value.

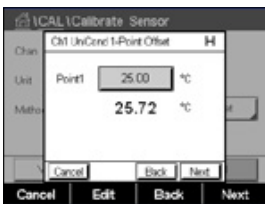

The screen shows the entered value for the reference solution (1st line) and the measured value of the M400 (2nd line).

Press the Next button to start the calculation of the calibration results.

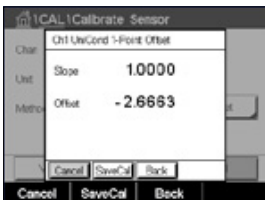

The display shows the value for the slope and the offset as the result of the calibration.

The calibration values are stored in the calibration history. To save (press button SaveCal) or to discard (press button Cancel).

Use the Back button to go one step back in the calibration procedure.



6.2.2.2 Two-Point Calibration

Select calibration procedure 2-Point (see chapter "6.2.2 Temperature Calibration of UniCond 2-e Sensors and UniCond 4-e Sensors" on page 39). With 2-e-sensors or 4-e-sensor a two-point calibration is always performed as an offset and slope calibration. The following procedure shows the calibration with a 2-e-sensor. The calibration with a 4-e-sensor works respectively.

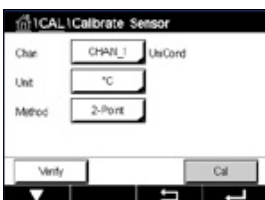

Press the button Cal for starting calibration.



Place the electrode in the first reference solution and press Next button.

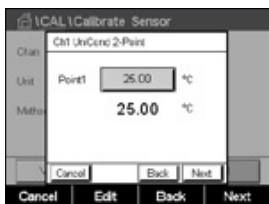

The second value displayed on the screen is the value being measured by the transmitter and sensor in the units selected by the user.

Press the input field for **Point1** to enter the calibration point. The M400 displays a keypad for modifying the value. Press the \leftarrow button and to accept the value.

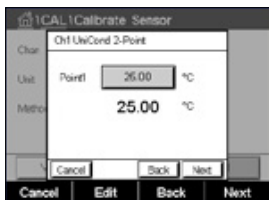

The screen shows the entered value for the first reference solution (1st line) and the measured value of the M400 (2nd line).

Press the Next button to go on with the calibration.



Place the electrode in the second reference solution and press Next button.

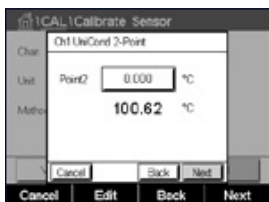

The second value displayed on the screen is the value being measured by the transmitter and sensor in the units selected by the user.

Press the input field for **Point2** to enter the calibration point. The M400 displays a keypad for modifying the value. Press the \leftarrow button and to accept the value.

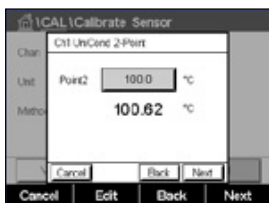

The screen shows the entered value for the second reference solution (1st line) and the measured value of the M400 (2nd line).

Press the Next button to start the calculation of the calibration results.

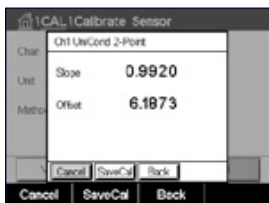

The display shows the value for the slope and the offset as the result of the calibration.

The calibration values are stored in the calibration history. To save (press button SaveCal) or to discard (press button Cancel).

Use the Back button to go one step back in the calibration procedure.



6.3 Calibration of Cond4e Sensors

PATH:  \ Cal \ Calibrate Sensor

The M400 provides the ability to perform a one-point, two-point or process conductivity or resistivity calibration for 4-e-sensors.

 **NOTE:** When performing calibration on a conductivity sensor, results will vary depending on the method, calibration apparatus and/or quality of reference standards used to perform the calibration.

 **NOTE:** For measuring tasks the temperature compensation for the application as defined through the parameter settings for conductivity will be considered and not the temperature compensation selected through the calibration procedure (see also chapter "7.1.3.1 Conductivity Settings" on page 61).

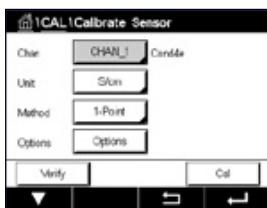

The following menus can be called up:

Unit: Between the units for conductivity and resistivity can be chosen.

Method: Select the desired calibration procedure, 1-point, 2-point or process calibration.

Options: Select the desired temperature compensation mode for the calibration process.

 **NOTE:** If compensation mode "Linear 25 °C" or "Linear 20 °C" has been chosen, the coefficient for the adjustment of the reading can be modified.

The changes are valid until the calibration mode has been exited. After the values defined in the configuration menu are valid again.

6.3.1 One-Point Calibration

With 4-e-sensors a one-point calibration is always performed as a slope calibration.

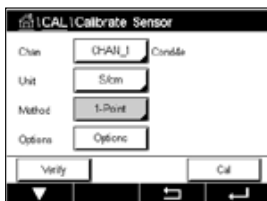

Press the button Cal for starting calibration.

Place the electrode in the reference solution and press Next button.

Enter the value for the calibration point (**Point1**).

Press the Next button to start the calculation of the calibration results.

The display shows the value for the slope and the offset as the result of the calibration.

For ISM (digital) sensors select "Adjust", "Calibrate" or "Cancel" to finish calibration. For Analog sensors select "SaveCal" or "Cancel" to finish calibration. See chapter "6.1.1 Terminate Sensor Calibration" on page 34.

6.3.2 Two-Point Calibration

With 4-e-sensors a two-point calibration is always performed as an offset and slope calibration.

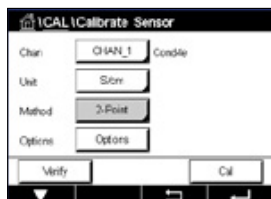

Press the button Cal for starting calibration.

Place the electrode in the first reference solution and press Next button.

CAUTION: Rinse sensors with a high-purity water solution between calibration points to prevent contamination of the reference solutions.

Enter the value for the first calibration point (**Point1**).

Press the Next button to go on with the calibration.

Place the electrode in the second reference solution and press Next button.

Enter the value for the second calibration point (**Point2**).

Press the Next button to start the calculation of the calibration results.

The display shows the value for the slope and the offset as the result of the calibration.

For ISM (digital) sensors select "Adjust", "Calibrate" or "Cancel" to finish calibration. For Analog sensors select "SaveCal" or "Cancel" to finish calibration. See "6.1.1 Terminate Sensor Calibration" on page 34.

6.3.3 Process Calibration

With 4-e-sensors a process calibration is always performed as a slope calibration.

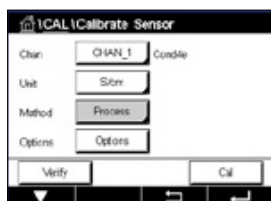

Press the button Cal for starting calibration.

Take a sample and press the \leftarrow button to store the current measuring value. To show the ongoing calibration process, P is blinking in the Start and Menu screen if the related channel is selected in the display.

After determining the conductivity value of the sample, press the calibration icon in the Menu Screen again.

Enter the conductivity value of the sample. Press the Next button to start the calculation of the calibration results.

The display shows the value for the slope and the offset as the result of the calibration.

For ISM (digital) sensors select "Adjust", "Calibrate" or "Cancel" to finish calibration. For Analog sensors select "SaveCal" or "Cancel" to finish calibration. See "6.1.1 Terminate Sensor Calibration" on page 34.

6.4 pH Calibration

PATH:  \ Cal \ Calibrate Sensor

For pH sensors, the M400 Transmitter features one-point, two-point or process calibration with 9 preset buffer sets or manual buffer entry. Buffer values refer to 25 °C. To calibrate the instrument with automatic buffer recognition, you need a standard pH buffer solution that matches one of these values. Please select the correct buffer table before using automatic calibration (see chapter "16 Buffer tables" on page 111). The stability of the sensor signal during calibration can be checked by the user or automatically by the transmitter (see chapter "7.1.3.2 pH Settings" on page 62).



NOTE: For dual membrane pH electrodes (pH/pNa) only buffer Na+ 3.9M (see chapter "16.2.1 Mettler-pH/pNa buffers (Na+ 3.9M)" on page 116) is available.

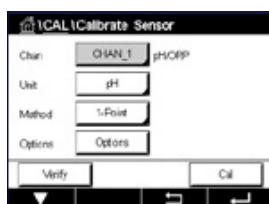

The following menus can be called up:

Unit: Select pH.

Method: Select the desired calibration procedure, 1-point, 2-point or process calibration.

Options: The buffer used for the calibration and the required stability of the sensor signal during the calibration can be selected (see also chapter "7.1.3.2 pH Settings" on page 62). The changes are valid until the calibration mode has been escaped. After the values defined in the configuration menu are valid again.

6.4.1 One-Point Calibration

With pH sensors a one-point calibration is always performed as an offset calibration.

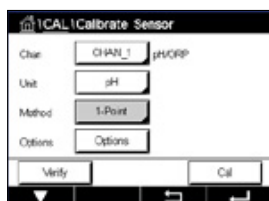

Press the button Cal for starting calibration.

Place the electrode in the buffer solution and press the Next button.

The display shows the buffer the transmitter has recognized **Point 1** and the measured value.

The M400 checks the stability of the measuring signal and proceeds as soon as the signal is sufficiently stable.



NOTE: If **option** Stability is set to Manual press 'Next' after the measuring signal is stable enough to go on with the calibration.

The transmitter shows the value for the slope and the offset as the result of the calibration.

Select "Adjust", "Calibrate" or "Cancel" to finish calibration. See "6.1.1 Terminate Sensor Calibration" on page 34.

6.4.2 Two-Point Calibration

With pH sensors a two-point calibration is always performed as calibration of slope and offset.

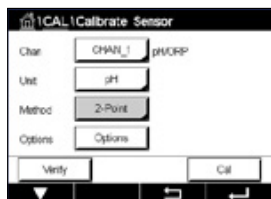

Press the Cal button to start calibration.

Place the electrode in buffer solution 1 and press Next button.

The display shows the buffer the transmitter has recognized **Point 1** and the measured value.

The M400 checks the stability of the measuring signal and proceeds as soon as the signal is sufficiently stable.



NOTE: If **option** Stability is set to Manual press 'Next' after the measuring signal is stable enough to go on with the calibration.

The transmitter prompts you to place the electrode in the second buffer solution.

Press the Next button to proceed with the calibration.

The display shows the buffer the transmitter has recognized **Point 2** and the measured value.

The M400 checks the stability of the measuring signal and proceeds as soon as the signal is sufficiently stable.



NOTE: If **option** Stability is set to Manual press 'Next' after the measuring signal is stable enough to go on with the calibration.

The transmitter shows the value for the slope and the offset as the result of the calibration.

Select "Adjust", "Calibrate" or "Cancel" to finish calibration. See chapter "6.1.1 Terminate Sensor Calibration" on page 34.

6.4.3 Process Calibration

With pH sensors a process calibration is always performed as an offset calibration.

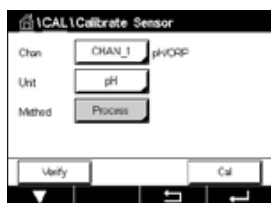

Press the Cal button to start calibration.

Take a sample and press the ↵ button to store the current measuring value. To show the ongoing calibration process, P is blinking in the Start and Menu Screen if the related channel is selected in the display.

After determining the pH value of the sample, press the calibration icon in the Menu Screen again.

Enter the pH value of the sample. Press the Next button to start the calculation of the calibration results.

The display shows the value for the slope and the offset as the result of the calibration.

Select "Adjust", "Calibrate" or "Cancel" to finish calibration. See chapter "6.1.1 Terminate Sensor Calibration" on page 34.

6.5 ORP Calibration of pH Sensors

PATH:  \ Cal \ Calibrate Sensor

For pH sensors with solution ground based on ISM technology the M400 Transmitter gives the option to make, in addition to the pH calibration, an ORP calibration.



NOTE: In case of choosing ORP calibration the parameters defined for pH (see chapter "7.1.3.2 pH Settings" on page 62) will not be considered. For pH sensors, the M400 Transmitter features one-point calibration for ORP.

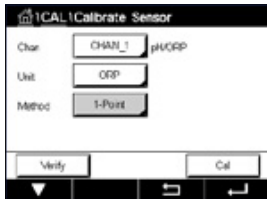

The following menus can be called up:

Unit: Select ORP through pressing the corresponding field.

Method: 1-Point calibration is displayed.

Press the button Cal for starting calibration.

Enter the value for calibration point 1 (**Point1**).

Press the Next button to start the calculation of the calibration results.

The display shows the value for the slope and the offset as the result of the calibration.

Select "Adjust", "Calibrate" or "Cancel" to finish calibration. See "6.1.1 Terminate Sensor Calibration" on page 34.

6.6 Calibration of Amperometric Oxygen Sensors

PATH:  \ Cal \ Calibrate Sensor

The M400 provides the ability to perform a one-point or process calibration for amperometric oxygen sensors.



NOTE: Before air calibration, for highest accuracy, enter the barometric pressure and relative humidity, as described in chapter "7.1.3.3 Settings for Oxygen Measurement Based on Amperometric Sensors" on page 64.

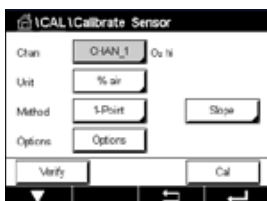

The following menus can be called up:

Unit: Between several units for Dissolved Oxygen can be chosen.

Method: Select the desired calibration procedure, 1-point or process calibration.

Options: In case the method 1-point has been chosen the calibration pressure, relative humidity and - for slope calibration - the stability mode for the sensor signal during the calibration can be selected. For the method Process the values for the process pressure, calibration pressure and the parameter ProcCalPress can be modified. See also chapter "7.1.3.3 Settings for Oxygen Measurement Based on Amperometric Sensors" on page 64. The changes are valid until the calibration mode has been escaped. After the values defined in the configuration menu are valid again.

6.6.1 One-Point Calibration

A one-point calibration of oxygen sensors is always either a one-point slope (i.e. with air) or a zero (offset) calibration. A one-point slope calibration is done in air and a one-point offset calibration is done at 0 ppb oxygen. A one-point zero dissolved oxygen calibration is available but not normally recommended since zero oxygen is very hard to achieve. A zero-point calibration is only recommended if high accuracy at low oxygen level (below 5% air) is needed.

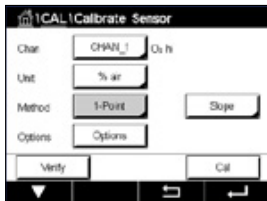

Choose Slope or Offset calibration through pressing the corresponding field.

Press the button Cal for starting calibration.



NOTE: If the polarization voltage for the measuring mode and calibration mode is different, the transmitter will wait 120 seconds before starting the calibration. In this case the transmitter will also go after the calibration for 120 seconds to the HOLD Mode, before returning to the measuring mode again.

Place the sensor in air or the calibration gas and press Next button

Enter the value for the calibration point (**Point1**).

The M400 checks the stability of the measuring signal and proceeds as soon as the signal is sufficiently stable.



NOTE: If **option** Stability is set to Manual press 'Next' after the measuring signal is stable enough to go on with the calibration.



NOTE: For an offset calibration the Auto mode is not available. If Auto mode has been chosen and afterwards slope calibration has been changed to offset calibration, the transmitter will perform the calibration in Manual mode.

The transmitter shows the value for the slope and the offset as the result of the calibration.

Select "Adjust", "Calibrate" or "Cancel" to finish calibration. See "6.1.1 Terminate Sensor Calibration" on page 34.

6.6.2 Process Calibration

A process calibration of oxygen sensors is always either a slope or an offset calibration.

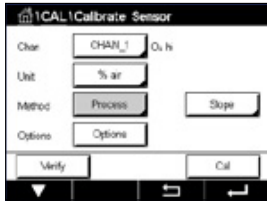

Choose Slope or Offset calibration through pressing the corresponding field.

Press the Cal button to start calibration.

Take a sample and press the \leftarrow button to store the current measuring value. To show the ongoing calibration process, P is blinking in the Start and Menu screen if the related channel is selected in the display.

After determining the oxygen value of the sample, press the calibration icon in the Menu Screen again.

Enter the oxygen value of the sample. Press the Next button to start the calculation of the calibration results.

The display shows the value for the slope and the offset as the result of the calibration.

Select "Adjust", "Calibrate" or "Cancel" to finish calibration. See "6.1.1 Terminate Sensor Calibration" on page 34.

6.7 Calibration of Optical Oxygen Sensors

PATH: \ Cal \ Calibrate Sensor

Oxygen calibration for optical sensors can be performed as a two-point, process or, depending on the sensor model connected to the transmitter, also as a one-point calibration.



NOTE: Before air calibration, for highest accuracy, enter the barometric pressure and relative humidity, as described in chapter "7.1.3.4 Settings for Oxygen Measurement Based on Optical Sensors" on page 65.

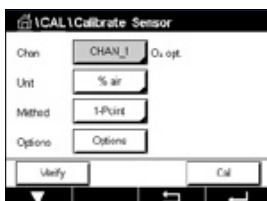

The following menus can be called up:

- Unit:** Between several units can be chosen. The units are displayed during the calibration.
- Method:** Select the desired calibration procedure, 1-point, 2-point or process calibration.
- Options:** In case the method 1-point has been chosen the calibration pressure, relative humidity and the stability mode for the sensor signal during the calibration can be selected. For the method Process the values for the process pressure, calibration pressure, the parameter ProcCalPress and the mode of the process calibration can be modified. See also chapter "7.1.3.4 Settings for Oxygen Measurement Based on Optical Sensors" on page 65. The changes are valid until the calibration mode has been escaped. After the values defined in the configuration menu are valid again.

6.7.1 One-Point Calibration

Typically a one-point calibration is done in air. Nevertheless other calibration gases and solutions are possible.

The calibration of an optical sensor is always a calibration of the phase of the fluorescence signal towards the internal reference. During a one-point calibration the phase in this point is measured and extrapolated over the measuring range.

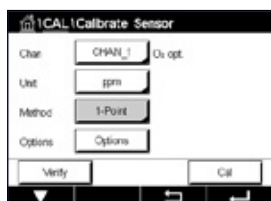

Press the button Cal for starting calibration.

Place the sensor in air or the calibration gas and press Next button

Enter the value for the calibration point (**Point1**).

The M400 checks the stability of the measuring signal and proceeds as soon as the signal is sufficiently stable.



NOTE: If **option** Stability is set to Manual press 'Next' after the measuring signal is stable enough to go on with the calibration.

The transmitter shows the value for the phase of the sensor at 100% air (P100) and at 0% air (P0) as the result of the calibration.

Press the Adjust button to perform the calibration and store the calculated values in the sensor. Press the Calibrate button to store the calculated values in the sensor. Calibration is not performed. Press the Cancel button to terminate the calibration.

If "Adjust" or "Calibrate" are chosen, the message "Calibration Saved Successfully!" is displayed. In either case you will see the message "Please re-install sensor".

6.7.2 Two-Point Calibration

The calibration of an optical sensor is always a calibration of the phase of the fluorescence signal towards the internal reference. A two-point calibration is a combination of first a calibration in air (100%) where a new phase P100 is measured and then a calibration in nitrogen (0%) where a new phase P0 is measured. This calibration routine gives the most accurate calibration curve over the whole measuring range.

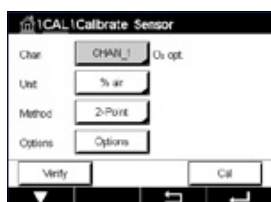

Press the Cal button to start calibration.

Place the sensor in air or the calibration gas and press Next button

Enter the value for the first calibration point (**Point1**).

The M400 checks the stability of the measuring signal and proceeds as soon as the signal is sufficiently stable.



NOTE: If **option** Stability is set to Manual press 'Next' after the measuring signal is stable enough to go on with the calibration.

The transmitter prompts you to change the gas.

Press the Next button to proceed with the calibration.

The M400 checks the stability of the measuring signal and proceeds as soon as the signal is sufficiently stable.



NOTE: If **option** Stability is set to Manual press 'Next' after the measuring signal is stable enough to go on with the calibration.

The transmitter shows the value for the phase of the sensor at 100% air (P100) and at 0% air (P0) as the result of the calibration.

Press the Adjust button to perform the calibration and store the calculated values in the sensor. Press the Calibrate button to store the calculated values in the sensor. Calibration is not performed. Press the Cancel button to terminate the calibration.

If "Adjust" or "Calibrate" are chosen, the message "Calibration Saved Successfully!" is displayed. In either case you will see the message "Please re-install sensor".

6.7.3 Process Calibration

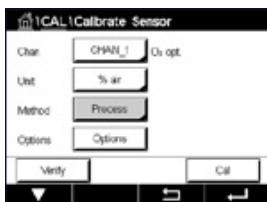

Press the Cal button to start calibration.

Take a sample and press the \leftarrow button to store the current measuring value. To show the ongoing calibration process, P is blinking in the start and Menu Screen if the related channel is selected in the display.

After determining the oxygen value of the sample, press the calibration icon in the Menu Screen.

Enter oxygen value of the sample. Press the Next button to start the calculation of the calibration results.

The display shows now the values for the phase of the sensor at 100% air (P100) and at 0% (P0) air.

Press the Adjust button to perform the calibration and store the calculated values in the sensor. Press the Calibrate button to store the calculated values in the sensor. Calibration is not performed. Press the Cancel button to terminate the calibration.



NOTE: If for process calibration Scaling has been chosen (see chapter "7.1.3.4 Settings for Oxygen Measurement Based on Optical Sensors" on page 65) the calibration values are not stored in the calibration history.

If "Adjust" or "Calibrate" are chosen, the message "Calibration Saved Successfully!" is displayed.

6.8 Calibration of Dissolved Carbon Dioxide Sensors

For dissolved carbon dioxide (CO₂) sensors, the M400 Transmitter features one-point, two-point or process calibration. For the one-point or two-point calibration the solution with pH = 7.00 and/or pH = 9.21 of the Mettler – 9 standard buffer can be used (see also chapter "7.1.3.5 Dissolved Carbon Dioxide Settings" on page 66) or the buffer value can be entered manually.

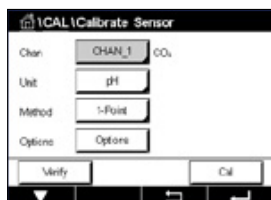

The following menus can be called up:

Unit: Between several units for partial pressure, and dissolved carbon dioxide can be selected.

Method: Select the desired calibration procedure, 1-point or process calibration.

Options: The buffer used for the calibration and the required stability of the sensor signal during the calibration can be selected (see also chapter "7.1.3.5 Dissolved Carbon Dioxide Settings" on page 66). The changes are valid until the calibration mode has been escaped. After the values defined in the configuration menu are valid again.

6.8.1 One-Point Calibration

With CO₂ sensors a one-point calibration is always performed as an offset calibration.

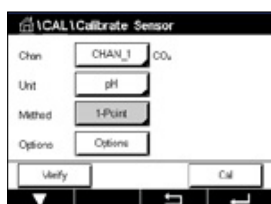

Press the button Cal for starting calibration.

Place the electrode in the buffer solution and press the Next button.

The display shows the buffer the transmitter has recognized **Point 1** and the measured value.

The M400 checks the stability of the measuring signal and proceeds as soon as the signal is sufficiently stable.



NOTE: If **option** Stability is set to Manual press 'Next' after the measuring signal is stable enough to go on with the calibration.

The transmitter shows the value for the slope and the offset as the result of the calibration.

Press the Adjust button to perform the calibration and store the calculated values in the sensor. Press the Calibrate button to store the calculated values in the sensor. Calibration is not performed. Press the Cancel button to terminate the calibration.

If "Adjust" or "Calibrate" are chosen, the message "Calibration Saved Successfully!" is displayed. In either case you will get the message "Please re-install sensor".

6.8.2 Two-Point Calibration

With CO₂ sensors a two-point calibration is always performed as calibration of slope and offset.

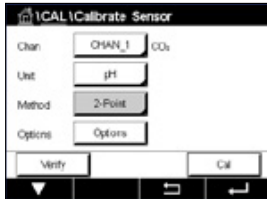

Press the Cal button to start calibration.

Place the electrode in buffer solution 1 and press Next button.

The display shows the buffer the transmitter has recognized **Point 1** and the measured value.

The M400 checks the stability of the measuring signal and proceeds as soon as the signal is sufficiently stable.



NOTE: If **option** Stability is set to Manual press 'Next' after the measuring signal is stable enough to go on with the calibration.

The transmitter prompts you to place the electrode in the second buffer solution.

Press the Next button to proceed with the calibration.

The display shows the buffer the transmitter has recognized **Point 2** and the measured value.

The M400 checks the stability of the measuring signal and proceeds as soon as the signal is sufficiently stable.



NOTE: If **option** Stability is set to Manual press 'Next' after the measuring signal is stable enough to go on with the calibration.

The transmitter shows the value for the slope and the offset as the result of the calibration.

Press the Adjust button to perform the calibration and store the calculated values in the sensor. Press the Calibrate button to store the calculated values in the sensor. Calibration is not performed. Press the Cancel button to terminate the calibration.

If "Adjust" or "Calibrate" are chosen, the message "Calibration Saved Successfully!" is displayed. In either case you will see the message "Please re-install sensor".

6.8.3 Process Calibration

With CO₂ sensors a process calibration is always performed as an offset calibration.

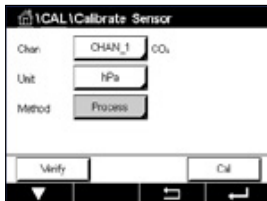

Press the Cal button to start calibration.

Take a sample and press the \leftarrow button to store the current measuring value. To show the ongoing calibration process, P is blinking in the Start and Menu Screen if the related channel is selected in the display.

After determining the corresponding value of the sample, press the calibration icon in the Menu Screen again.

Enter the value of the sample. Press the Next button to start the calculation of the calibration results.

The display shows the value for the slope and the offset as the result of the calibration.

Press the Adjust button to perform the calibration and store the calculated values in the sensor. Press the Calibrate button to store the calculated values in the sensor. Calibration is not performed. Press the Cancel button to terminate the calibration. If "Adjust" or "Calibrate" are chosen, the message "Calibration Saved Successfully!" is displayed.

6.9 Calibration of O₃ Sensors

The M400 provides the ability to perform a 1-Point or process calibration for O₃ sensors. Dissolved Ozone must be performed quickly because O₃ decays rapidly into oxygen, especially at warm temperatures.

Enter the menu Calibrate Sensor (see chapter "6.1 Sensor Calibration" on page 33; PATH: \Cal\Calibrate Sensor) and choose the desired channel for calibration.

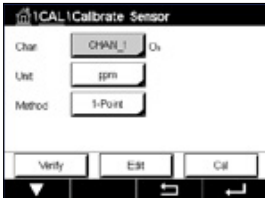

The following menus can be called up:

Unit: Several units for dissolved O₃ can be chosen.

Method: Select the desired calibration procedure, 1-Point or process calibration.

6.9.1 One-Point Calibration

Select the 1-Point calibration method. A one-point calibration of O₃ sensors is always a zero (offset) calibration

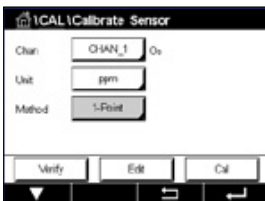

Press the button Cal for starting calibration.



Place the sensor in the calibration gas, such as air, and press the Next button.

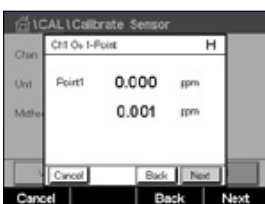

The second value displayed on the screen is the value being measured by the transmitter and sensor in the units selected by the user.

Press the input field for **Point1** to enter the value for the calibration point. The M400 displays a keypad for modifying the value. Press the button to accept the value.

When the measuring signal is stable, press Next to continue with the calibration

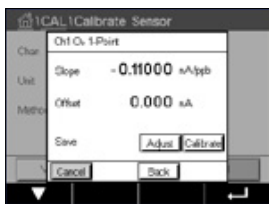

The display shows the value for the slope and the offset as result of the calibration.

Select "Adjust", "Calibrate" or "Cancel" to finish calibration. See "6.1.1 Terminate Sensor Calibration" on page 34.

Use the Back button to go one step back in the calibration procedure



6.9.2 Process Calibration

Select the Process calibration method. A Process calibration of O₃ sensors can be performed as a slope or offset calibration.



Select the desired calibration **Method**.

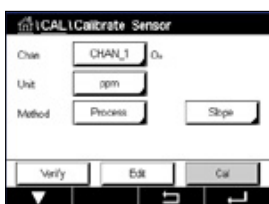

Press Cal to start the calibration.



Take a sample and press the \leftarrow button to store the current measuring value. "P" will blink in the measurement screen indicating a Process calibration is active.

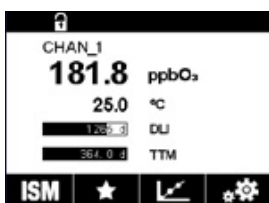

After determining the O₃ value of the sample, press the calibration icon to complete the Process calibration.



Press the input field for **Point1** and enter the O₃ value of the sample. Press the \leftarrow button to accept the value.

Press the Next button to start the calculation of the calibration results.



The display shows the value for the slope and the offset as the result of the calibration.

Select "Adjust", "Calibrate" or "Cancel" to finish calibration. See "6.1.1 Terminate Sensor Calibration" on page 34.

Use the Back button to go one step back in the calibration procedure.



6.10 Sensor Verification

Enter the menu Calibrate Sensor (see chapter "6.1 Sensor Calibration" on page 33; PATH: \ Cal \ Calibrate Sensor) and choose the desired channel for verification

Press the Verify button to start verification.

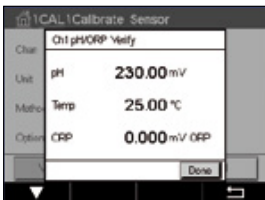

The measured signal of the primary and the secondary measurement in basic (mostly electrical) units are shown. The meter calibration factors are used when calculating these values.

Press the button and the transmitter returns to the calibration menu.

6.11 UniCond 2-e Electronics Calibration

The M400 provides the ability to calibrate or verify the electronic circuits of UniCond 2-e conductivity sensors. UniCond 2-e sensors have 3 resistance range circuits that require individual calibration. These measuring circuits are calibrated using the THORNTON ISM Conductivity Sensor Calibration Module part number 58 082 305 and supplied Y-connector. Before calibration, remove the sensor from the process, rinse with deionized water and allow to completely dry. Power the transmitter and sensor at least 10 minutes prior to calibration to assure stable operating temperature of the circuitry.

Press the Cal button.

Enter menu Calibrate Electronics.

Press the Chan_x button and select the desired channel for calibration.

Choose **Verify** or **Cal**.

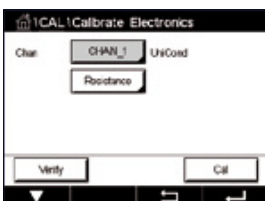

Reference THORNTON ISM Conductivity Sensor Calibration Module (part number 58 082 305) for detailed calibration and verification instructions.

6.12 Analog Output Calibration

PATH:  \ CAL \ Calibrate Analog Outputs

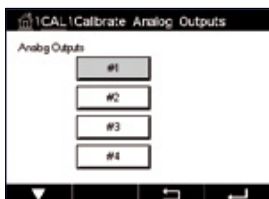

Each analog output can be calibrated at 4 and 20 mA. Select the desired output signal for calibration by pressing the #1 button for output signal 1, #2 for output signal 2, etc.

Connect an accurate milliamp meter to the analog output terminals and then adjust the 5-digit number in the display until the milliamp meter reads 4.00 mA and repeat for 20.00 mA.

As the 5-digit number is increased the output current increases and as the number is decreased the output current decreases. Thus coarse changes in the output current can be made by changing the thousands or hundreds digits and fine changes can be made by changing the tens or ones digits.

After adjusting both values press the Next button to start the calculation of the calibration results.

The display shows the calibration slope and zero point as the result of the output signal calibration.

Select "SaveCal" or "Cancel" to finish calibration. See "6.1.1 Terminate Sensor Calibration" on page 34.

6.13 Analog Input Calibration

PATH:  \ CAL \ Calibrate Analog Inputs

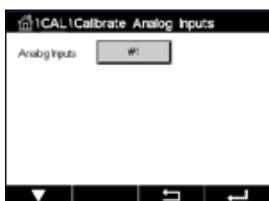

Analog input can be calibrated at 4 and 20 mA by pressing the #1 button.

Connect an 4 mA signal to the analog input terminals. Press the Next button.

Enter the right value for the input signal (**Point1**).

Press the Next button to go on with the calibration.

Connect an 20 mA signal to the analog input terminals. Press the Next button.

Enter the right value for the input signal (**Point2**)

Press the Next button to go on with the calibration.

The display shows the calibration slope and zero point as the result of the input signal calibration.

Selecting Cancel will discard the entered values. Pressing SaveCal will making the entered values the current ones.

If "SaveCal" is chosen, "Calibration Saved Successfully" is displayed.

6.14 Maintenance

PATH:  \ CAL \ Maintenance

The different channels of the M400 Transmitter can be switched manually into HOLD state. Furthermore a cleaning cycle can be started/stopped manually.

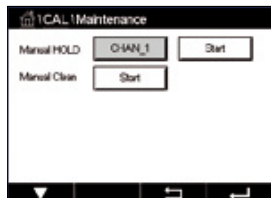

Press Start button for **Manual HOLD** to activate the HOLD state for the selected channel. To deactivate the HOLD state again, press the Stop button, which is now displayed instead of the Start button.

Press the Start button for **Manual Clean** to switch the cleaning relay to the state for starting a cleaning cycle. To switch back the relay press the Stop button, which is now displayed instead of the Start button.

7 Configuration

For the menu structure refer to chapter "3.2 Menu Structure" on page 18.

7.1 Measurement

PATH:  \ CONFIG \ Meas

7.1.1 Channel Setup

PATH:  \ CONFIG \ Meas \ Channel Setup

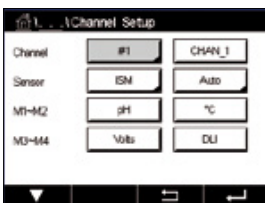

Press the right input field in the line of the setting for **the transmitter**. A parameter for the corresponding channel is chosen through pressing the according field.

If Auto is selected, M400 Transmitter automatically recognizes the ISM sensor type. The channel can also be fixed to a certain measurement parameter, depending on the type of transmitter.

7.1.2 ISM sensor

Select sensor type ISM.

If an ISM sensor is connected, the transmitter automatically (Parameter = Auto) Recognizes the type of sensor. You can also fix the transmitter to a certain measurement parameter e.g. "pH", depending on the type of transmitter you have.

	M400 Type 1 ISM	M400 Type 2 ISM
pH/ORP	•	•
pH/pNa	•	•
UniCond 2-e/4-e	•	•
Conductivity 2-e	–	–
Conductivity 4-e	•	•
Amp. dissolved oxygen ppm/ppb/trace	–	•/• ¹⁾ /–
Opt. dissolved oxygen ppm/ppb	–	•/• ¹⁾
Amp. O ₂ gas ppm/ppb/trace	–	–
Opt. O ₂ gas ppm	–	–
Dissolved ozone	–	•
Dissolved carbon dioxide	–	•
CO ₂ hi	–	–
GPro 500 TDL	–	–

1) Thornton high performance dissolved oxygen and pure water optical sensors only.

Enter the name with a maximum length of 6 characters for the channel through pressing the input field in the line **Descriptor**. The name of the channel will always be displayed. The name will also be displayed on the Start Screen and Menu Screen.

Choose one of the measurements **M1 to M4** (e.g. for measuring value M1 the left button, for measuring M2 the right button in the corresponding line).

Select in the input field for **Measurement** the desired parameter to show.



NOTE: Beside the parameters pH, O₂, T, etc. also the ISM values DLI, TTM and ACT can be linked to the measurements.

Choose **Range factor** of the measuring value. Not all parameters allow a modification of the range.

The menu **Resolution** allows the setting of the resolution for the measurement. The accuracy of the measurement is not effected by this setting. Possible setting are 1, 0.1, 0.01, 0.001.

Selected the menu **Filter**. The averaging method (noise filter) for the measurement can be selected. The options are None (default), Low, Medium, High, Special and Custom.

Option	Description
None	No averaging or filtering
Low	Equivalent to a 3 point moving average
Medium	Equivalent to a 6 point moving average
High	equivalent to a 10 point moving average
Special	Averaging depending on signal change (normally High averaging, but Low averaging for large changes in input signal)
Custom	1 point to 15 points moving average selection

7.1.3 Parameter Related Settings

PATH:  \ CONFIG \ Meas \ Parameter Setting

Measuring and calibration parameters can be set for the parameters pH, conductivity and oxygen.

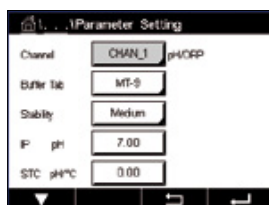

Depending on the selected channel and assigned sensor the measuring and calibration parameters are displayed.

See the following explanation to get more details about the different parameter settings.

7.1.3.1 Conductivity Settings

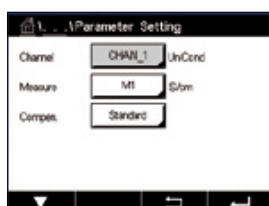

Select measurement (M1-M4). For more information regarding measurements see chapter "7.1.1 Channel Setup" on page 59.

If the selected measurement can be temperature compensated, the compensation method may be selected.



NOTE: During calibration, the compensation method must also be selected. (see chapter "6.2 Calibration of UniCond 2-e and UniCond 4-e Sensors" on page 34 and chapter "6.3 Calibration of Cond4e Sensors" on page 42).

Press **Compen.** to select the desired temperature compensation method. Choices are "None", "Standard", "Light 84", "Std 75 °C", "Linear 25°C", "Linear 20°C", "Glycol.5", "Glycol1", "Cation", "Alcohol" and "Ammonia".

None does not make any compensation of the measured conductivity value. The uncompensated value will be displayed and proceeded.

Standard compensation includes compensation for non-linear high purity effects as well as conventional neutral salt impurities and conforms to ASTM standards D1125 and D5391.

Light 84 compensation matches the high purity water research results of Dr. T.S. Light published in 1984. Use only if your institution has standardized on that work.

Std 75 °C compensation is the Standard compensation algorithm referenced to 75 °C. This compensation may be preferred when measuring Ultrapure Water at an elevated temperature (Resistivity of ultrapure water compensated to 75 °C is 2.4818 Mohm-cm.)

Linear 25 °C compensation adjusts the reading by a coefficient or factor expressed as %/°C (deviation from 25 °C). Use only if the solution has a well-characterized linear temperature coefficient. The factory default setting is 2.0%/°C.

Linear 20 °C compensation adjusts the reading by a coefficient or factor expressed as %/°C (deviation from 20 °C). Use only if the solution has a well-characterized linear temperature coefficient. The factory default setting is 2.0%/°C.

Glycol.5 compensation matches the temperature characteristics of 50% ethylene glycol in water. Compensated measurements using this solution may go above 18 Mohm-cm.

Glycol1 compensation matches the temperature characteristics of 100% ethylene glycol. Compensated measurements may go well above 18 Mohm-cm.

Cation compensation is used in power industry applications measuring the sample after a cation exchanger. It takes into account the effects of temperature on the dissociation of pure water in the presence of acids.

Alcohol compensation provides for the temperature characteristics of a 75% solution of isopropyl alcohol in pure water. Compensated measurements using this solution may go above 18 Mohm-cm.

Ammonia compensation is used in power industry applications for specific conductivity measured on samples using ammonia and/or ETA (ethanolamine) water treatment. It takes into account the effects of temperature on the dissociation of pure water in the presence of these bases.



NOTE: If compensation mode "Linear 25 °C" or "Linear 20 °C" has been chosen, the coefficient for the adjustment of the reading can be modified. In this case an additional input field will be displayed.

Press the input field for **Coef.** and adjust the coefficient or factor for the compensation.

7.1.3.2 pH Settings

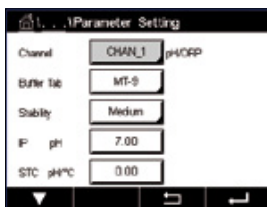

If a pH sensor is connected while during the channel setup (see chapter "7.1.1 Channel Setup" on page 59) Auto has been chosen the parameters Buffer Tab, Stability, IP, STC and calibration temperature as well as the displayed units for slope and/or zero point can be set or adjusted. The same parameters will be displayed if during the channel setup not Auto but pH/ORP has been set.

Select the buffer through the parameter **Buffer Tab**.

For automatic buffer recognition during calibration, select the buffer solution set that will be used: Mettler-9, Mettler-10, NIST Tech, NIST Std = JIS Std, HACH, CIBA, MERCK, WTW, JIS Z 8802 or None. See chapter "16 Buffer tables" on page 111 for buffer values. If the auto buffer feature will not be used or if the available buffers are different from those above, select None.



NOTE: For dual membrane pH electrodes (pH/pNa) buffer Na+ 3.9M (see chapter "16.2.1 Mettler-pH/pNa buffers (Na+ 3.9M)" on page 116.

Select the required **Stability** of the measuring signal during the calibration procedure. Choose manual if the user will decide when a signal is stable enough to complete the calibration. Select Low, Medium or Strict if an automatic stability control of the sensor signal during calibration through the transmitter should be done.

If the parameter stability is set to medium (default) the signal deviation has to be less than 0.8 mV over a 20 second interval to be recognized by the transmitter as stable. The calibration is done using the last reading. If the criteria is not met within 300 seconds then the calibration times out and the message "Calibration Not Done" is displayed.

Adjust the parameter **IP pH**.

IP is the isothermal point value (Default = 7.000 for most applications). For specific compensation requirements or non standard inner buffer value, this value can be changed.

Adjust the value of the parameter **STC pH/°C**.

STC is the solution temperature coefficient in units of pH/°C referenced to the defined temperature. (Default = 0.000 pH/°C for most applications). For pure waters, a setting of -0.016 pH/°C should be used. For low conductivity power plant samples near 9 pH, a setting of -0.033 pH/°C should be used.

If the value for STC is $\neq 0.000$ pH/°C an additional input field for the reference temperature will be displayed.

The value for **pH Ref Temperature** indicates to which temperature the solution temperature compensation is referenced. The displayed value and the output signal is referenced to this temperature. Most common reference temperature is 25°C.

7.1.3.3 Settings for Oxygen Measurement Based on Amperometric Sensors

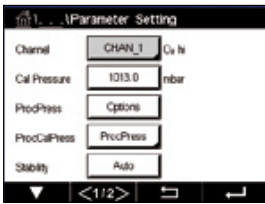

If an amperometric oxygen sensor is connected while during the channel setup (see chapter "7.1.1 Channel Setup" on page 59) Auto has been chosen the parameters CalPressure, ProcPressure, ProcCalPress, Stability, Salinity, RelHumidity, UpolMeas and UpolCal can be set or adjusted. The same parameters will be displayed if during the channel setup not Auto but O₂ hi, or O₂ lo has been set.

Enter the value for the calibration pressure through the parameter **CalPressure**.



NOTE: For a modification of the unit for the calibration pressure press U on the displayed keypad.

Press the Option button for the parameter **ProcPressure** and select the how to get applying process pressure through choosing the **Type**.

The applied process pressure can be entered by choosing Edit or measured over the analog input of the M400 by choosing Ain_1.

If Edit has been chosen an input field for entering the value manually is displayed on the screen. In case that Ain_1 has been selected two input fields are displayed to enter the start value (4 mA) and the end value (20 mA) of the range for the 4 to 20 mA input signal.

For the algorithm of the process calibration the applied pressure has to be defined. Select the pressure through the parameter **ProcCalPress**. For the process calibration the value of the process pressure (ProcPress) or the calibration pressure (CalPress) can be used.

Select the required **Stability** of the measuring signal during the calibration procedure. Choose Manual if the user will decide when a signal is stable enough to complete the calibration. Select Auto and an automatic stability control of the sensor signal during calibration through the transmitter will be done.

Additional settings can be done by navigating to the next page of the menu.

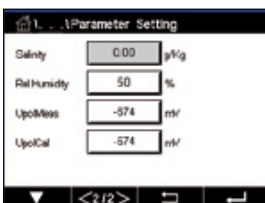

The **Salinity** of the measured solution can be modified.

In addition the relative humidity (button **Rel.Humidity**) of the calibration gas can also be entered. The allowed values for relative humidity are in the range 0% to 100%. When no humidity measurement is available, use 50% (default value).

The polarization voltage of amperometric oxygen sensors in the measuring mode can be modified through the parameter **UpolMeas**. For entered values 0 mV to -550 mV the connected sensor will be set to a polarization voltage of -500mV. If the entered value is less than -550 mV, the connected sensor will set to a polarization voltage of -674 mV.

The polarization voltage of amperometric oxygen sensors for calibration can be modified through the parameter **UpolCal**. For entered values 0 mV to -550 mV the connected sensor will be set to a polarization voltage of -500mV. If the entered value is less than -550mV, the connected sensor will set to a polarization voltage of -674mV.



NOTE: During a process calibration, the polarization voltage UpolMeas, defined for the measuring mode, will be used.



NOTE: If a one-point calibration is executed, the transmitter sends the polarization voltage, valid for the calibration, to the sensor. If the polarization voltage for the measuring mode and calibration mode is different, the transmitter will wait 120 seconds before starting the calibration. In this case the transmitter will also go after the calibration for 120 seconds to the HOLD Mode, before returning to the measuring mode again.

7.1.3.4 Settings for Oxygen Measurement Based on Optical Sensors

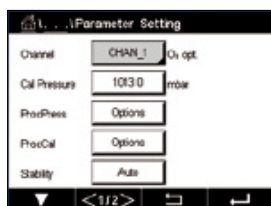

If an optical oxygen sensor is connected while during the channel setup (see chapter “7.1.1 Channel Setup” on page 59) Auto has been chosen the parameters CalPressure, ProcPressure, ProcCalPress, Stability, Salinity, RelHumidity, Sample Rate, LED Mode and Toff can be set or adjusted. The same parameters will be displayed if during the channel setup not Auto but Optical O₂ has been set.

Enter the value for the calibration pressure through the parameter **CalPressure**.

Press the button Option for the parameter **ProcPress** and select the how to get applying process pressure through pressing the according button in the line **Type**.

The applied process pressure can be entered by choosing Edit or measured over the analog input of the M400 by choosing AIN_1.

If Edit has been chosen an input field for entering the value manually is displayed on the screen. In case that AIN_1 has been selected two input fields are displayed to enter the start value (4mA) and the end value (20 mA) of the range for the 4 to 20 mA input signal.

For the algorithm of the process calibration the applied pressure has to be defined. Select the pressure through the parameter **ProcCal**. For the process calibration the value of the process pressure (ProcPress) and the value of the calibration pressure (CalPress) can be used. Select between Scaling and Calibration for the process calibration. If Scaling has been chosen, the calibration curve of the sensor will be untouched, but the output signal of the sensor will be scaled. In case of calibration value <1%, the offset of the sensor output signal will be modified during scaling, for value >1% the slope of the sensor output will be adjusted. For further information about scaling refer to the sensor manual.

Selecting the required **Stability** of the measuring signal during the calibration procedure. Choose Manual if the user will decide when a signal is stable enough to complete the calibration. Select Auto and an automatic stability control of the sensor signal during calibration through the transmitter will be done.

Additional settings can be done by navigating to the next page of the menu.

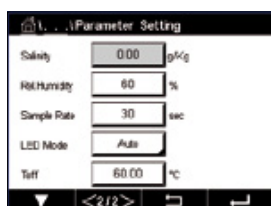

The **Salinity** of the measured solution can be modified.

In addition the relative humidity (button **Rel.Humidity**) of the calibration gas can also be entered. The allowed values for relative humidity are in the range 0% to 100%. When no humidity measurement is available, use 50% (default value).

Adjust the required **Sample Rate** of the optical sensor during measurement. The time interval from one measuring cycle of the sensor to the next can be adjusted i.e. adapted to the application. A higher value will increase the life time of the OptoCap of the sensor.

Select the **LED Mode** of the sensor. There are the following options.

Off: LED is permanently switched off.

On: LED is permanently switched on.

Auto: The LED is switched on as long as the measured media temperature is smaller then Toff (see next value) or switched off through a digital input signal (see chapter "7.9 Digital Inputs" on page 77).



NOTE: If the LED is switched off, no oxygen measurement is performed.

Enter the limit for the measuring temperature to switch off the LED of the sensor automatically for the M400 through the parameter **Toff**.

If the media temperature is higher then Toff, the LED will be switched off. The LED will be switched on as soon as the media temperature falls below Toff –3 K. This function give the option to increase the lifetime of the OptoCap by switching off the LED during SIP or CIP cycles.



NOTE: This function is only active if the LED Mode is set to "Auto".

7.1.3.5 Dissolved Carbon Dioxide Settings

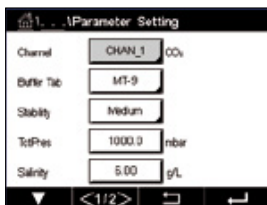

If an dissolved carbon dioxide sensor is connected while during the channel setup (see chapter "7.1.1 Channel Setup" on page 59) Auto or CO₂ has been chosen, the buffer used for calibration and the parameters stability, salinity, HCO₃, TotPres can be set resp. adjusted.

Select the buffer through the parameter **Buffer Tab**. For automatic buffer recognition during calibration, select buffer solution Mettler-9 if it will be used. If the auto buffer feature will not be used or if the available buffer are different from Mettler-9 select None.

Select the required **Stability** of the measuring signal during the calibration procedure. Choose manual if the user will decide when a signal is stable enough to complete the calibration. Select Low, Medium or Strict if an automatic stability control of the sensor signal during calibration through the transmitter should be done.

If the unit for the measured dissolved carbon dioxide is %sat, the pressure during the calibration resp. measurement has to be considered. This will be done by setting the parameter **TotPres**. If another unit then %sat has been selected, the result will not be influenced by this parameter.

The **Salinity** describes the total amount of solved salts in the CO₂ electrolyte of the sensor connected to the transmitter. It is a sensor specific parameter. The default value (28.00 g/L) is valid for the InPro5000i. Do not change this parameter if the InPro 5000 i will be used.

Additional settings can be done by navigating to the next page of the menu.



The parameter **HCO₃** describes the concentration of hydrogen carbonate in the CO₂ electrolyte of the sensor connected to the transmitter. It is also a sensor specific parameter. The default value 0.050 Mol/L is valid for the InPro 5000 i. Do not change this parameter if the InPro 5000 i will be used.

7.1.4 Concentration Curve Table

To specify a concentration curve for customer-specific solutions, up to 5 concentration values can be edited in a matrix together with up to 5 temperatures. To do so the desired values are edited under the concentration curve table menu. Beside the temperature values, the conductivity and concentration values for the corresponding temperature are edited. The concentration curve can be selected resp. used in combination with conductivity sensors.

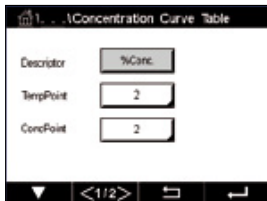

Enter the name with a maximum length of 6 characters for the concentration curve through pressing the input field in the line **Descriptor**.

Enter the amount of desired temperature points (**TempPoint**) and concentration points (**ConcPoint**).

The different values can be entered by navigating to the next page of the menu.

The screenshot shows a table with the following structure:

Temp	Conc	Conc1	Conc2	Conc3	Conc4	Conc5
T1	0.000	0.000h	0.300h	0.300h	0.000h	0.000h
T2	0.000	0.000h	0.300h	0.300h	0.000h	0.000h
T3	0.000	0.000h	0.300h	0.300h	0.000h	0.000h
T4	0.000	0.000h	0.300h	0.300h	0.000h	0.000h
T5	0.000	0.000h	0.300h	0.300h	0.000h	0.000h

Enter the values for temperature (**T1...T5**), concentration (**Conc1...Conc5**) and the corresponding conductivity through pressing the according input field. The unit for the value of the conductivity can be adjusted as well in the according input field.



NOTE: The values for the temperature have to increase from T1 to T2 to T3, etc. The values for the concentration have to increase from Conc 1 to Conc2 to Conc3, etc.



NOTE: The conductivity values at the different temperatures have to increase or decrease from Conc1 to Conc2 to Conc3, etc. Maxima and/or minima are not permitted. If the conductivity values at T1 are increasing with the different concentrations, they have to increase also at the other temperatures. If the conductivity values at T1 are decreasing with the different concentrations, they have to decrease also at the other temperatures.

7.2 Analog Outputs

PATH:  \ CONFIG \ Analog Outputs

See the following explanation to get more details about the different settings for the analog outputs.

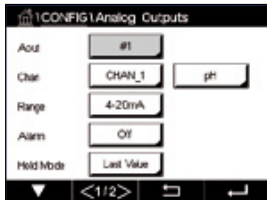

Press the input field in the line of the setting for **Aout** and select the desired output signal for configuration by pressing button #1 for output signal 1, #2 for output signal 2 etc. Press the related button for the assignment of the channel (**Chan**). Select the channel, which has to be linked to the output signal.

Press the button for the assignment of the measuring parameter – based on the selected channel – that has to be linked to the output signal.



NOTE: Besides the measurement values pH, O₂, T, etc. also the ISM values DLI, TTM and ACT can be linked to the output signal.

Select the **Range** for the output signal.

To adjust the value for the analog output signal if an alarm occurs, press the input field in the line for the setting of **Alarm**. Off means, that an alarm has now influence on the output signal.



NOTE: Not only the alarms occurred on the assigned channel will be considered, but every alarm coming up on the transmitter.

The value for the output signal if the transmitter goes into HOLD mode can be defined. It can be chosen between the last value (i.e. the value before the transmitter switched to the HOLD mode) or an fixed value.

Press the input field in the line for the setting of the **HOLD Mode** and select the value. If a fixed value is chosen, the transmitter shows an additional input field.

Additional settings can be done by navigating to the next page of the menu.

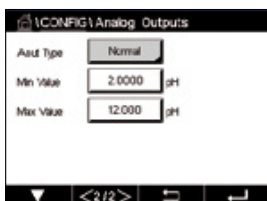

The **Aout Type** can be Normal, Bi-Linear, Auto-Range or Logarithmic. The range can be 4–20 mA or 0–20 mA. Normal provides linear scaling between the minimum and maximum scaling limits and is the default setting. Bi-Linear will also prompt for a scaling value for the mid-point of the signal and allows two different linear segments between the minimum and maximum scaling limits.

Press the button for the **Min Value**, that corresponds with start point of the analog output range.

Press the button for the **Max Value**, that corresponds with end point of the analog output signal.

Depending on the chosen Aout type additional values can be entered.

Bi-Linear will also prompt for a scaling value for the Mid Value of the signal and allows two different linear segments between the defined Min and Max Values.

Auto-Range scaling provides two ranges of output. It is designed to work with a PLC to provide a wide measurement range at the high end of the scale, and a narrower range with high resolution at the low end. Two separate settings are used, one for the maximum limit of the high range and one for the maximum limit of the low range, for the single 0/4-20 mA signal.

Max1 is the maximum limit of the low range on auto-range. The maximum value for the high range on auto-range is set with the Max Value. Both ranges have the same minimum value that is set through Min Value. If the input value is higher than value of Max1, the transmitter switches automatically to the second range. To indicate the currently valid range a relay can be assigned. The relay will be switched if the transmitter changes from on range to the other.

If **Logarithmic** Range was selected, it will prompt for the Max Value and also for the number of decades.

7.3 Set Points

PATH: \ CONFIG \ Set Points

See the following explanation to get more details about the different settings for the set points.

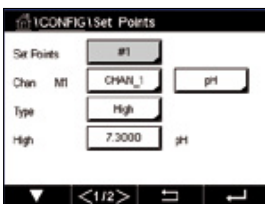

Press the input field in the line of the setting for **Set Point** and select the desired set point for configuration through pressing the button #1 for set point 1, #2 for set point 2 etc..

Press the related button for the assignment of the channel (**Chan**). Select the channel, which has to be linked to the set point.

Press the button for the assignment of the measuring parameter – based on the selected channel – that has to be linked to the set point.

Mx in the display indicates the measurement assigned to the set point. (see chapter 7.1.1 "Channel Setup").



NOTE: Beside the parameters pH, O₂, T, mS/cm, %EP WFI etc. also the ISM values DLI, TTM and ACT can be linked to the set point.

The **Type** of the setpoint can be High, Low, Between, Outside or Off. An "Outside" setpoint will cause an alarm condition whenever the measurement goes above its high limit or below its low limit. A "Between" setpoint will cause an alarm condition to occur whenever the measurement is between its high and low limits.



NOTE: If the type of set point is not Off additional settings can be done. See the following description.

According to the selected type of setpoint, value(s) regarding the limit(s) can be entered.

Additional settings can be done by navigating to the next page of the menu.

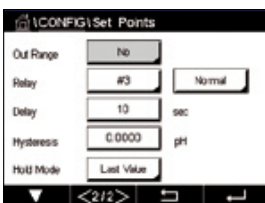

Once configured a relay could be activated if a sensor **Out of Range** condition is detected on the assigned input channel.

To select the desired relay that will be activated if the defined conditions are reached press the input field in the line for the setting of **SP Relay**. If the chosen relay is used for another task, the transmitter shows the message on the screen that there is a Relay Conflict.

The operation mode of the relay can be defined.

Relay contacts are in normal mode until the associated setpoint is exceeded, then the relay is activated and the contact states change. Select Inverted to reverse the normal operating state of the relay (i.e. normally open contacts are in a closed state, and normally closed contacts are in an open state, until the setpoint is exceeded).

Enter the **Delay** time in seconds. A time delay requires the setpoint to be exceeded continuously for the specified length of time before activating the relay. If the condition disappears before the delay period is over, the relay will not be activated.

Enter the value for the **Hysteresis**. A hysteresis value requires the measurement to return within the setpoint value by a specified percentage before the relay is deactivated.

For a high setpoint, the measurement must decrease more than the indicated percentage below the setpoint value before the relay is deactivated. With a low setpoint, the measurement must rise at least this percentage above the setpoint value before the relay is deactivated. For example, with a high setpoint of 100, when this value is exceeded, the measurement must fall below 90 before the relay is deactivated.

Enter the relay **HOLD Mode** of "Off", "Last Value" or "On". This is the state of the relay during HOLD status.

7.4 ISM Setup

PATH:  \ CONFIG \ ISM Setup

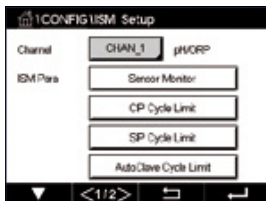

See the following explanation to get more details about the different parameter settings for the ISM Setup.

7.4.1 Sensor Monitor

If a ISM sensor is connected while during the channel setup (see "7.1.1 Channel Setup" on page 59) Auto has been chosen the parameter Sensor Monitor can be set or adjusted. The menu Sensor Monitor will also be displayed if during the channel setup not Auto but one of the mentioned sensors has been set.

Press the button Sensor Monitor.

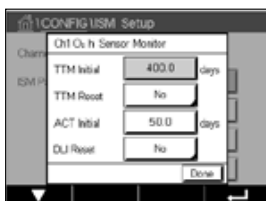

Enter the value for the initial Time To Maintenance interval (**TTM Initial**) in days. The initial value for TTM can be modified according to the application experience.

For pH/ORP sensor the timer estimates when the next cleaning cycle should be performed to keep the best possible measurement performance. The timer is influenced by significant changes on the DLI parameters.

For amperometric oxygen and ozone sensors, the time to maintenance indicates a maintenance cycle for the membrane and electrolyte.

Press the input field for **TTM Reset**. Select Yes if Time To Maintenance (TTM) for the sensor should be reset to the initial value.

Time To Maintenance needs to be reset after the following operations.

pH sensors: manual maintenance cycle on the sensor.
 Oxygen or ozone sensor: manual maintenance cycle on the sensor or exchanging of the membrane of the sensor

 **NOTE:** By connecting a sensor, the actual value for TTM of the sensor is read out from the sensor.

Enter the **ACT Initial** value in days. The new value will be loaded down to the sensor after saving the changes.

The Adaptive Calibration Timer (ACT) estimates when the next calibration should be performed to keep the best possible measurement performance. The timer is influenced by significant changes on the DLI parameters. The ACT will be reset to its initial value after a successful calibration. The initial value for the ACT can be modified according to the application experience and loaded down to the sensor.

 **NOTE:** By connecting a sensor, the actual value for the ACT of the sensor is read out from the sensor.

Press the input field for **DLI Reset**. Select Yes if Dynamic Lifetime Indicator (DLI) for the sensor should be reset to the initial value. The reset will be done after saving the changes.

The DLI allows an estimation, when the pH electrode, the inner body of an amperometric oxygen or ozone sensor is at the end of his lifetime, based on the actual stress he is exposed to. The sensor permanently takes the averaged stress of the past days into consideration and is able to increase/decrease the lifetime accordingly.

The following parameters affect the lifetime indicator:

Dynamic parameter

- Temperature
- pH or oxygen value
- Glass impedance (only pH)
- Reference impedance (only pH)

Static parameters

- Calibration history
- Zero and Slope
- CIP/SIP/Autoclaving cycles

The sensor keeps the information stored in the built in electronics and can be retrieved via a transmitter or the iSense asset management suite.

For amperometric oxygen sensors, the DLI is related to the inner-body of the sensor. After exchanging the inner-body perform DLI Reset.

 **NOTE:** By connecting a sensor, the actual values for the DLI of the sensor are read out from the sensor.

 **NOTE:** The menu DLI Reset for pH sensors not available. If the actual value for the DLI of a pH sensor is 0 the sensor has to be replaced.

7.4.2 CIP Cycle Limit

If a pH/ORP, oxygen or conductivity sensor is connected during the channel setup (see chapter "7.1.1 Channel Setup" on page 59) Auto has been chosen the parameter CIP Cycle Limit can be set or adjusted. The menu CIP Cycle Limit will also be displayed if during the channel setup not Auto but one of the mentioned sensors has been set.

Press the button CIP Cycle Limit.

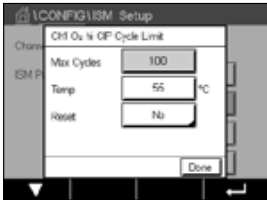

Press the button in the input field for the parameter **Max Cycles** and enter the value for the maximum CIP cycles. The new value will be written to the sensor after saving the changes.

The CIP cycles are counted by the transmitter. If the limit (value for Max Cycles) is reached, an alarm can be indicated and set to a certain output relays.

If the Max Cycles setting is on 0, the counter functionality is turned off.

Press the button in the input field for the parameter **Temp** and enter the temperature, which has to be exceeded, that the a CIP cycle will be counted.

CIP Cycles will be automatically recognized by the transmitter. Since CIP cycles will vary in intensity (duration and temperature) for each application the algorithm of the counter recognizes an increase of the measurement temperature above the level defined through the value for Temp. If the temperature does not decrease below the defined temperature level -10 °C within the next 5 minutes after the first temperature was reached, the counter in question will be incremented by one and also locked for the next two hours. In the case the CIP would last longer than two hours the counter would be incremented by one once more.

Press the input field for **Reset**. Select Yes if CIP counter for the sensor should be reset to 0. The reset will be done after saving the changes.

If an oxygen sensor is connected, the reset should be performed after the following operations.
amperometric sensor: exchanging of the inner-body of the sensor.



NOTE: For pH/ORP sensor the menu Reset is not available. A pH/ORP sensor should be replaced if the number for Max Cycles has been exceeded.

7.4.3 SIP Cycle Limit

If a pH/ORP, oxygen or conductivity sensor is connected during the channel setup (see chapter "7.1.1 Channel Setup" on page 59) Auto has been chosen the parameter SIP Cycle Limit can be set or adjusted. The menu SIP Cycle Limit will also be displayed if during the channel setup not Auto but one of the mentioned sensors has been set.

Press the button SIP Cycle Limit.

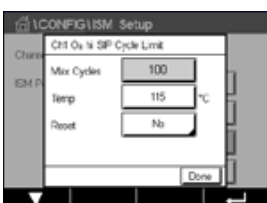

Press the button in the input field for the parameter **Max Cycles** and enter the value for the maximum SIP cycles. The new value will be written to the sensor after saving the changes.

The SIP cycles are counted by the transmitter. If the limit (value for Max Cycles) is reached, an alarm can be indicated and set to a certain output relays.

If the Max Cycles setting is on 0, the counter functionality is turned off.

Press the button in the input field for the parameter **Temp** and enter the temperature, which has to be exceeded, that the a SIP cycle will be counted.

SIP Cycles will be automatically recognized by the transmitter. Since SIP cycles will vary in intensity (duration and temperature) for each application the algorithm of the counter recognizes an increase of the measurement temperature above the level defined through the value for Temp. If the temperature does not decrease below the defined temperature level - 10°C within the next 5 minutes after the first temperature was reached, the counter in question will be incremented by one and also locked for the next two hours. In the case the SIP would last longer than two hours the counter would be incremented by one once more.

Press the input field for **Reset**. Select Yes if SIP counter for the sensor should be reset to 0. The reset will be done after saving the changes.

If an oxygen sensor is connected, the reset should be performed after the following operations.
Amperometric sensor: exchanging of the inner-body of the sensor.



NOTE: For pH/ORP sensor the menu Reset is not available. A pH/ORP sensor should be replaced if the number for Max Cycles has been exceeded.

7.4.4 AutoClave Cycle Limit

If a pH/ORP, amperometric oxygen is connected during the channel setup (see chapter "7.1.1 Channel Setup" on page 59) Auto has been chosen the parameter AutoClave Cycle Limit can be set or adjusted. The menu AutoClave Cycle Limit will also be displayed if during the channel setup not Auto but one of the mentioned sensors has been set.

Press the button AutoClave Cycle Limit.

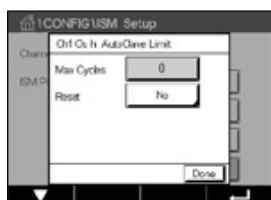

Press the button in the input field for the parameter **Max Cycles** and enter the value for the maximum AutoClave cycles. The new value will be written to the sensor after saving the changes.

If the Max Cycles setting is on 0, the counter functionality is turned off.

Since during the autoclaving cycle the sensor is not connected to the transmitter, you will be asked after every sensor connection, whether the sensor was autoclaved or not. According to your selection, the counter will be incremented or not. If the limit (value for Max Cycles) is reached, an alarm can be indicated and set to a certain output relay. Press the input field for **Reset**. Select Yes if the AutoClave counter for the sensor should be reset to 0. The reset will be done after saving the changes.

If an oxygen sensor is connected, the reset should be performed after the following operations.
Amperometric sensor: exchanging of the inner-body of the sensor.



NOTE: For pH/ORP sensor the menu Reset is not available. A pH/ORP sensor should be replaced if the number for Max Cycles has been exceeded.

7.4.5 DLI Stress Adjustment

If a pH/ORP is connected during the channel setup (see chapter “7.1.1 Channel Setup” on page 59) Auto has been chosen the parameter DLI Stress Adjustment can be adjusted. With this setting the user can adjust the sensor sensitivity to the stress of his specific application for the DLI calculation.

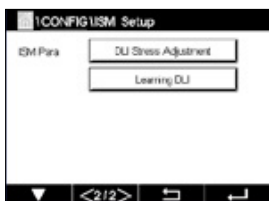

Browse to page 2 of “ISM Setup”.

Press the button **DLI Stress Adjustment**.

Select between low / medium / high for the **Type** of DLI Stress Adjustment.

LOW: DLI extended (–30% sensitivity)

MEDIUM: standard DLI (default)

HIGH: DLI reduced (+30% sensitivity)

Press \leftarrow to accept the setting.

7.4.6 SAN Cycle Parameters

If an ozone sensor is connected , values for the following SAN Cycle Parameters can be set, Max Cycles (the maximum number of sanitization cycles), Conc. Max (the maximum allowed O_3 concentration), Conc. Min (the minimum allowed O_3 concentration), Cycle Time (length of cycle), and Reset.

Press the button SAN Cycle Parameters.

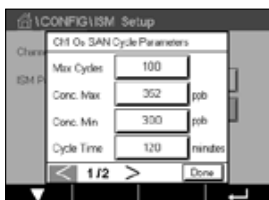

Press the input field next to Max Cycles and enter the value for the maximum SAN cycles. Press \leftarrow to accept the value. The new value will be written to the sensor after saving the changes.

The SAN cycles are counted by the transmitter. If the limit (value for Max Cycles) is reached, an alarm can be configured. If the Max Cycles setting = 0, the counter functionality is turned off.

Press the input field next to Conc. Max and enter the ozone concentration above which a sanitization cycle is to be detected. Press \leftarrow to accept the value.

Press the input field next to Conc. Min. Enter the value for the ozone concentration below which a sanitization cycle is no longer detected. Press \leftarrow to accept the value

Press the input field next to Cycle Time. Enter the value for the time, the ozone concentration has to be higher then the Conc. Min value after the Conc. Max value has been exceeded to count a sanitization cycle. Press \leftarrow to accept the value.

Press the input field next to Reset. Select Yes to reset the sanitization counter to zero. This is typically performed after sensor replacement. The reset will be done after saving the changes

Press \leftarrow to exit the menu SAN Cycle Parameters.

7.4.7 Reset Counters for UniCond 2-e Sensors

For UniCond 2-e sensors, the following counters can be reset: High Temp and High Conductivity.

Press the button Reset Counters.



Select Yes for the desired counter to be reset and press enter. The reset will be done after saving the changes.

Press \leftarrow to exit the menu Reset Counters.

7.4.8 Set Calibration Interval for UniCond 2-e Sensors

For UniCond 2-e sensor the Cal Interval (calibration interval) can be set.

Press the button Cal Interval.

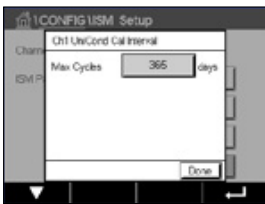

Press the input field next to **Cal Interval** and enter the value for the calibration interval. Based on this value the Time To Calibration (TTCal) will be calculated by the transmitter. Press \leftarrow to accept the value. The new value will be written to the sensor after saving the changes.

Press \leftarrow to exit the menu Cal Interval.

7.5 General Alarm

PATH: \leftarrow \ CONFIG \ General Alarm

See the following explanation to get more details about the different settings for General Alarm.



Press the button Event in the line of the settings for **Option** and select the events, that should be considered for an alarm.

To activate a relay if the defined conditions are reached press the input field in the line for the settings of **Relay**. Only relay 1 can be assigned to general alarm. For general alarms the operation mode of the assigned relay is always inverted.

Enter the **Delay** time in seconds. A time delay requires the setpoint to be exceeded continuously for the specified length of time before activating the relay. If the condition disappears before the delay period is over, the relay will not be activated.

7.6 ISM / Sensor Alarm

PATH:  \ CONFIG \ ISM / Sensor Alarm

See the following explanation to get more details about the different settings for ISM / Sensor Alarm.

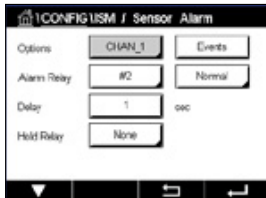

Depending on the assigned sensor the **Events** that will be considered for generating an alarm can be selected. Some alarms will be considered in any case and not have to be selected or deactivated.

To select the desired relay that will be activated if an event has taken place press the input field in the line for the settings for **Relay**.

The operation mode of the relay can be defined.

Relay contacts are in normal mode until one of the selected events has taken place. Then the relay is activated and the contact states change. Select Inverted to reverse the normal operating state of the relay (i.e. normally open contacts are in a open state, and normally closed contacts are in a closed state if an event has taken place).

Enter the **Delay** time in seconds. A time delay requires the event to be occurred continuously for the specified length of time before activating the relay. If the condition disappears before the delay period is over, the relay will not be activated.

7.7 Clean

PATH:  \ CONFIG \ Clean

See the following explanation to get more details about the different settings for Clean

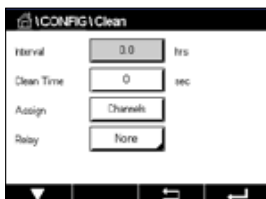

Enter the cleaning **Interval** time in hours. The cleaning interval can be set from 0.000 to 99999 hours. Setting it to 0 turns the clean cycle off.

Enter the **Clean Time** in seconds. The clean time can be 0 to 9999 seconds and must be smaller than the cleaning interval.

Assign the channel(s) for cleaning cycles. The assigned channels will be in HOLD state during the cleaning cycle.

Choose a **Relay**. Relay contacts are in normal mode until the cleaning cycle starts, then the relay is activated and the contact states change. Select Inverted to reverse the normal operating state of the relay (i.e. normally open contacts are in a open state, and normally closed contacts are in a closed state when the cleaning cycle starts).

7.8 Display Setup

PATH:  \ CONFIG \ Display Setup

See the following explanation to get more details about the different settings for Display Setup

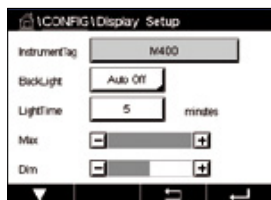

Enter the name for the M400 Transmitter (**Instrument Tag**). The instrument tag will also be displayed on the line at the top of the Start Screen and Menu Screen.

Use **BackLight** to switch off or dim the transmitter screen after a defined time period without interaction. The transmitter screen will automatically come back after pressing the display.

Enter the **Light Time** in minutes. The light time is the time period without interaction before the transmitter screen will be dimmed or switched off.



NOTE: In case of an unacknowledged warning or alarm the transmitter screen will not be dimmed or switched off even if the light time has been elapsed

The parameter **Max** allows the setting of the backlight during operation. With the parameter **Dim** the backlight of the transmitter screen during the dimmed state can be adjusted. Press the + or – buttons in the corresponding line to adjust the parameters.

7.9 Digital Inputs

PATH:  \ CONFIG \ Digital Inputs

See the following explanation to get more details about the different settings for the digital inputs

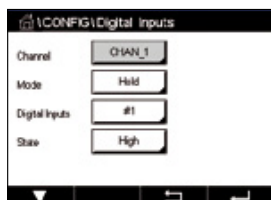

Press the input field in the line of the setting for **Mode** and select the impact of an active digital input signal. Choose 'HOLD' to lead the assigned channel in HOLD state.

Press the related button for the assignment of the **Digital Inputs** (#1 for DI1, #2 for DI2 etc.) and select the digital input signal, which has to be linked to the channel.

An additional setting can be done, if a digital input signal has been selected.

Press the input field in the line for the setting of the **State** and select if the digital input is active at high or low level of the voltage input signal.

7.10 System

PATH:  \ CONFIG \ System

See the following explanation to get more details about the different settings for the System.

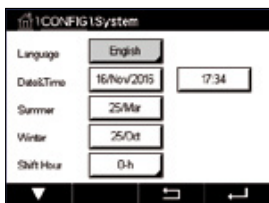

Select the desired **Language**. The following languages are available: English, French, German, Italian, Spanish, Portuguese, Russian, Chinese, Korean or Japanese.

Enter **Date&Time**.

The automatic change-over from summertime to wintertime and vice-versa frees the users from having to correct the time twice a year.

The winter to summer time-change is carried out automatically using the 12-month clock integrated in the transmitter. The date for the time-change can be set with the parameter **Summer**.

Provided it is a Sunday, the time-change would take place on the day that equates with the value, otherwise on the following Sunday. The winter/summer time-change takes place at 02:00 h.

The summer to winter time-change is carried out automatically using the 12-month clock integrated in the transmitter. The date for the time-change can be set through the parameter **Winter**.

Provided it is a Sunday, the time-change would take place on the day that equates with the value, otherwise on the following Sunday. The winter/summer time-change takes place at 03:00 h.

The number of hours, the clock will be shifted through the winter to summer and summer to winter time-change can be chosen. Press the related button for the setting of the **Shift Hour**.

7.11 PID Controller

PATH:  \ CONFIG \ PID Controller

PID control is proportional, integral and derivative control action that can provide smooth regulation of a process. Before configuring the transmitter, the following process characteristics must be identified.

Identify the **control direction** of the process

– **Conductivity:**

Dilution – direct acting where increasing measurement produces increasing control output such as controlling the feed of low conductivity diluting water to rinse tanks, cooling towers or boilers

Concentrating – reverse acting where increasing measurement produces decreasing control output, such as controlling chemical feed to attain a desired concentration

– **Dissolved Oxygen:**

Deaeration – direct acting where increasing Dissolved Oxygen concentration produces increasing control output such as controlling the feed of a reducing agent to remove oxygen from boiler feedwater

Aeration – reverse acting where increasing Dissolved Oxygen concentration produces decreasing control output, such as controlling an aerator blower speed to maintain a desired Dissolved Oxygen concentration in fermentation or wastewater treatment

– **pH/ORP:**

Acid feed only – direct acting where increasing pH produces increasing control output, also for ORP reducing reagent feed

Base feed only – reverse acting where increasing pH produces decreasing control output, also for ORP oxidizing reagent feed

Both acid and base feed – direct and reverse acting

Identify the **control output type** based on the control device to be used:

Pulse frequency – used with pulse input metering pump

Pulse length – used with solenoid valve

Analog – used with current input device such as electric drive unit, analog input metering pump or current-to-pneumatic (I/P) converter for pneumatic control valve

Default control settings provide linear control, which is appropriate for conductivity, dissolved oxygen. Therefore, when configuring PID for these parameters (or simple pH control) ignore settings of deadband and corner points in the tuning parameter section below. The non-linear control settings are used for more difficult pH/ORP control situations.

If desired, identify the non-linearity of the pH/ORP process. Improved control can be obtained if the non-linearity is accommodated with an opposing non-linearity in the controller. A titration curve (graph of pH or ORP vs. reagent volume) made on a process sample provides the best information. There is often a very high process gain or sensitivity near the setpoint and decreasing gain further away from the setpoint. To counteract this, the instrument allows for adjustable non-linear control with settings of a deadband around the setpoint, corner points further out and proportional limits at the ends of control as shown in the figure below.

Determine the appropriate settings for each of these control parameters based on the shape of the pH process titration curve.

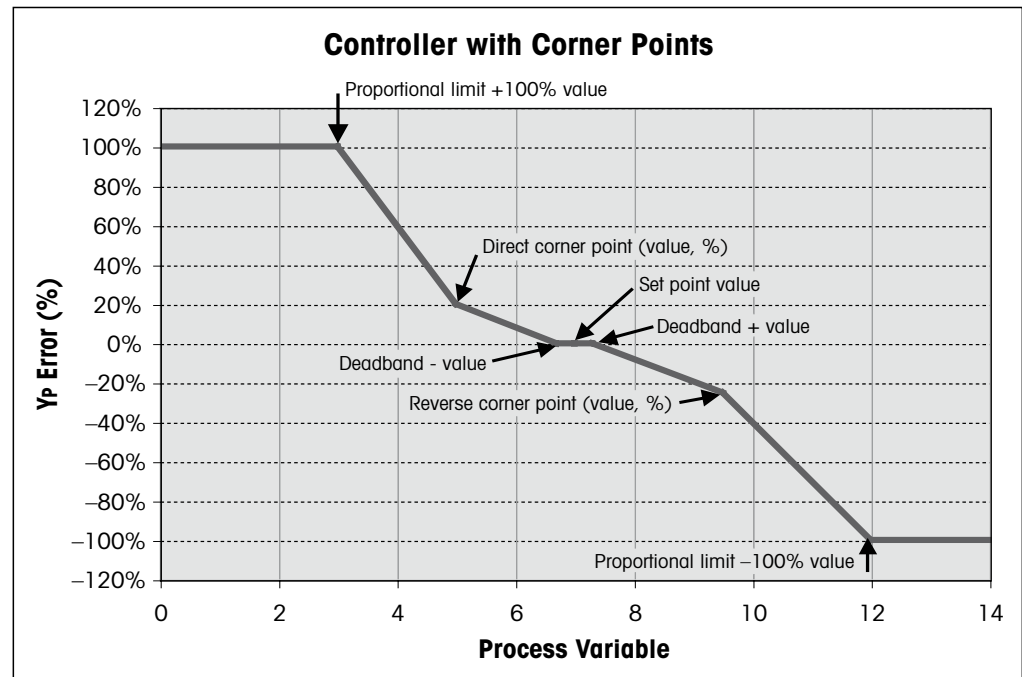

See the following explanation to get more details about the different settings for PID Controller.

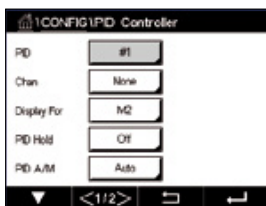

The M400 provides to one PID controller.

Press the related button for the assignment of the channel (**Chan**). Select the channel, which has to be linked to the PID Controller. To deactivate the PID controller press None.

Press the button for the assignment of the measuring parameter – based on the selected channel – that has been linked to the PID controller. Choose the measuring parameter by pressing the according field. Mx in the display indicates the measurement assigned to the PID Controller. (see chapter 7.1.1 "Channel Setup").

The M400 offers the display of control output (%PID) of the PID controller in the Start Screen and Menu Screen. Press the related button for **Display For** and select the line, the control output should be displayed by pressing the corresponding field.



NOTE: The control output of the PID controller will be displayed instead of the measurement, that has been defined to be shown in the corresponding line (see chapter "7.1.1 Channel Setup" on page 59).

Select with the parameter **PID HOLD** the state of the control output for the PID controller if the M400 Transmitter is in HOLD mode. Off means that the control output will be 0%PID if the transmitter is in HOLD mode. If Last Value has been chosen, the value for the control output signal before the transmitter went into HOLD mode will be used.

The parameter **PID A/M** allows selection of auto or manual operation for the PID controller. If auto has been chosen, the transmitter calculates the output signal based on the measured value and the settings of the parameters for the PID controller. In the case of manual operation, the transmitter shows in the Menu Screen at the line where the output signal is displayed two additional arrow buttons. Press the arrows buttons to increase or decrease the PID output signal.



NOTE: If Manual has been chosen the values for the time constants, gain, corner points, proportional limits, setpoint and deadband do not have any influence on the output signal.

Additional settings can be done by navigating to the next page of the menu.

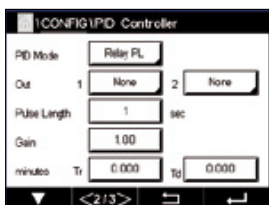

The **PID Mode** assigns a relay or analog output for PID control action. Based on the control device being used, select one of the three options Relay PL, Relay PF and Aout through pressing the corresponding field

- Relay PL: If using a solenoid valve, select Relays PL (Pulse Length).
- Relay PF: If using a pulse input metering pump, select Relays PF (Pulse Frequency)
- Aout: For using an analog control select Aout.

Link the output signal **Out1,2** of the PID controller to the desired output of the transmitter. Press the related button for Out 1 and Out 2 and select the corresponding number for the output through pressing the according field. #1 means relay 1 or Aout 1, #2 means relay 2 our Aout 2 etc.



NOTE: Take care if reed type relays are linked to the controlling function. The reed type relays could be used for pulse frequency control devices and light duty applications. The current is limited to 0.5 amps and 10 watts (see also chapter "14.2 Electrical specifications" on page 108). Do not connect to this relays higher current devices.

If the PID Mode is set to Relay PL, the Puls Length for the output signal of the transmitter can be adjusted. Press the button for **Pulse Length** and the M400 displays a keypad for modifying the value. Enter the new value in the unit seconds according to the table below and press **↵**.



NOTE: A longer pulse length will reduce wear on the solenoid valve. The % "on" time in the cycle is proportional to the control output.

	1st Relay Position (Out 1)	2nd Relay Position (Out 2)	Pulse Length (PL)
Conductivity	Controlling concentrating reagent feed	Controlling dilution water	Short (PL) provides more uniform feed. Suggested start point = 30 sec
pH/ORP	Feeding base	Feeding acid	Reagent addition cycle: short PL provides more uniform addition of reagent. Suggested start point = 10 sec
Dissolved Oxygen	Reverse control action	Direct acting control action	Feed cycle time: short PL provides more uniform feed. Suggested start point = 30 sec

If the PID Mode is set to Relay PF, the Pulse Frequency for the output signal of the transmitter can be adjusted. Press the button for **Pulse Freq** and enter the new value in the unit pulse / minute according to the table below.



NOTE: Set the pulse frequency to the maximum frequency allowed for the particular pump being used, typically 60 to 100 pulses/minute. Control action will produce this frequency at 100% output.



CAUTION: Setting the pulse frequency too high may cause the pump to overheat.

	1 st Relay Position = #3	2 nd Relay Position = #4	Pulse Frequency (PF)
Conductivity	Controlling concentrating chemical feed	Controlling dilution water	Max allowed for the pump used (typically 60–100 pulses/minute)
pH/ORP	Feeding base	Feeding acid	Max allowed for the pump used (typically 60–100 pulses/minute)
Dissolved Oxygen	Reverse control action	Direct acting control action	Max allowed for the pump used (typically 60–100 pulses/minute)

If the PID Mode is set to **Aout**, the type for the analog output signal of the transmitter can be selected. Press the corresponding button and choose between 4 to 20 mA and 0 to 20 mA for the output signal by pressing the according field.

For the assignment of the analog output signal consider the table below.

	1 st Analogout Position = Out 1	2 nd Analogout Position = Out 2
Conductivity	Controlling concentrating chemical feed	Controlling dilution water
pH/ORP	Feeding base	Feeding acid
Dissolved Oxygen	Reverse control action	Direct acting control action

Press the input field for the parameter **Gain** to enter the gain of the PID controller as a unitless value. Gain represents the maximum value of the output signal of the PID controller in per cent (value 1 corresponds to 100%).

Press the corresponding input field in the line of **min** to adjust the Parameter integral or reset time **Tr** (left button) and/or rate of derivate time **Td** (right button).



NOTE: Gain, integral and derivate time are usually adjusted later by trial and error on process response. It is recommended to start with the value $T_d = 0$.

Further settings can be done by navigating to the next page of the menu.

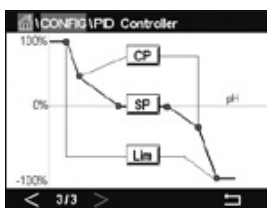

The display shows PID controller curve with input buttons for the corner points, setpoint and proportional limit for 100%.

Press the button **CP** to enter the menu for adjusting the corner points.

Page 1 shows the Corner Limit Low settings. Press the corresponding button to modify the value for the process parameter and the related output signal in %.

Browse to page 2 and the Corner Limit High settings are displayed. Press the corresponding button to modify the value for the process parameter and the related output signal in %.

Press the button **SP** to enter the menu for adjusting the setpoint and the dead band.

Press the button **Lim** to enter the menu for adjusting the proportional limit high and the proportional limit low, the range over which control action is required.

7.12 Service

PATH:  \ CONFIG \ Service

This menu is a valuable tool for troubleshooting and provides diagnostic functionality for the following items: Calibrate TouchPad, Set Analog Outputs, Read Analog Outputs, Read Analog Inputs, Set Relays, Read Relays, Read Digital Inputs, Memory and Display.

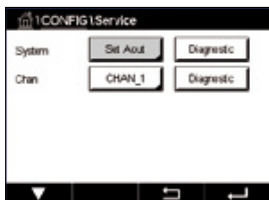

Select through the parameter **System** the desired item for diagnostic by pressing the according field.

Select through **Chan** the channel for diagnostic information of the sensor. This menu is only displayed if a sensor is connected.

The provided diagnostic functionality can now be called up through pressing the button **Diagnostic**.

7.12.1 Set Analog Outputs

The menu enables the user to set all analog outputs to any mA value within the 0–22 mA range. Use the + and – button to adjust the mA output signal. The transmitter will adjust the output signals according to the measurement and configuration of the analog output signals.

7.12.2 Read Analog Outputs

The menu shows the mA value of the analog outputs.

7.12.3 Set Relay

The menu allows the user to open or close each relay manually. If the menu is exited, the transmitter will switch the relay according to configuration.

7.12.4 Read Relay

The menu shows the state of every relay. On indicates the relay is closed, Off indicates that the relay is open.

7.12.5 Read Digital Inputs

The menu shows the state of the digital input signals.

7.12.6 Memory

If Memory is selected the transmitter will perform a memory test of all connected transmitter boards and ISM sensors.

7.12.7 Display

The transmitter shows every 5 seconds red, green, blue, grey and dark grey display and returns afterwards to the menu Service. If within the 5 seconds for every color the screen is pressed the transmitter will go to the next step.

7.12.8 Calibrate TouchPad

During the 4 calibrations steps, always press the center of the circle shown circle in the 4 corners of the display. The transmitter will show the calibration result.

7.12.9 Channel Diagnostic

If an error has occurred with the sensor, the corresponding messages are displayed.

7.13 User Management

PATH:  \ CONFIG \ User Management

This menu allows for the configuration of different user and administrator passwords, as well as setting up a list of allowed menus for the different users. The administrator has rights to access all menus. All default passwords for new transmitters are "00000000".

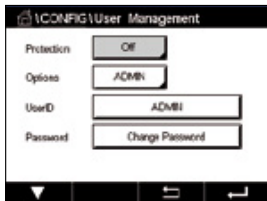

Press the input field in the line of **Protection** and select the desired kind of protection. The following options are available:

Off: No protection

Active: Activation of the Menu Screen (see chapter 3.3 "Display") has to be confirmed

Password: Activation of the Menu Screen is only possible with a password

Press the according button for **Option** to select the profile for the administrator (Admin) or one of the users.



NOTE: The administrator always has the rights to access all menus. For different users the access rights can be defined.

Press the input button for **UserID** to enter the name for the user or administrator. The name for the user or administrator will be displayed if the protection via password is selected for activation of the Menu Screen.

For changing the password of the selected user or administrator press the input field for **Password**. Enter the old password in the field Old PW, the new one in the field New PW and confirm it in the field confirm PW. The default password is "00000000" for the administrator and all users.

If the profile for a user has been selected an additional input field to define the access rights will be displayed.

To assign access rights the according button for the menu has to be pressed. In case of an assignment of the access rights, is displayed in the related button.

7.14 Reset

PATH:  \ CONFIG \ Reset

Depending on the transmitter version and configuration different options for a reset are available.

See the following explanation to get more details about the different option to reset data and / or configurations.

7.14.1 System Reset

This menu option allows the reset of the M400 Transmitter to the factory default settings (set-points off, analog outputs off, passwords, etc.). Furthermore the calibration factors for analog in- and outputs, meter etc. can be set to the last factory values.

Press the input field for **Options** and select System.

Press the input field for **Items** (Configure button) and select the different parts of the configuration that will be reset.

If an item has been selected the Action menu is displayed. Press the Reset button.

7.14.2 Reset Sensor Calibration for UniCond 2-e Sensors

For UniCond 2-e sensors, the SensorCal (sensor calibration) and ElecCal (sensor electronics calibration) can be restored to factory settings.

Press the input field for **Options** and select the channel the UniCond 2-e sensor is connected to.

Press the input field for **Item** (Configure button). Select SensorCal to Factory and/or ElecCal to Factory by checking the adjacent box. Press  enter to accept the value.

If an item has been selected the Action menu is displayed. Press the Reset button.

The M400 will bring up the confirmation dialog. Select Yes and the reset will be executed. Press No to go back to menu Reset without performing the reset.

7.15 USB

PATH: \ CONFIG \ USB

This menu allows to output measurement values by a printer or to output measurement values for data log by USB communication.

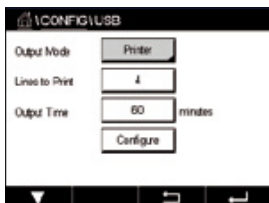

Select the Output Mode, Off or Printer or Data Log.

7.15.1 Printer Output Configuration

The Printer menu option allows configuring the M400 USB output to send data to a suitable printer. The printer output may be configured to print up to 4 configure measurements on separate lines, for each available sensor input, including pulsed input channels. At each print cycle, the output will include a header line with data and time based on the M400 internal clock, and one line for each configured measurement including channel, measurement descriptor, measurement value and unit of measure.

The output will appear as follows:

```
11/May/2012 15:36
Ch   Label Measurement
1    CHAN_1 4.01 pH
2    CHAN_1 25 centigrade
3    CHAN_1 200 DLI
```

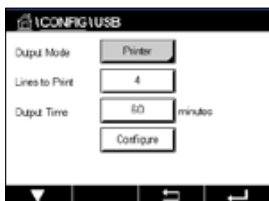

To configure the printer output, select option Printer for Output Mode. Configure the following options:

Lines to Print will configure the number of measurements that will be printed for each print cycle. Enter the total number of measurements to be configured for output. Lines to Print may be set from 1 to 4.

Output Time defines the time in minutes between each print cycle. Output time may be set from 1 to 1000 minutes.

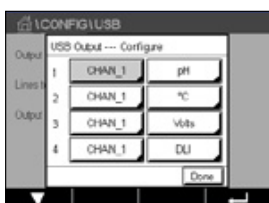

Once the output time and print lines have been established, press the Configure button to format the printer output. The number at the left of the window shows the order in which the lines will appear on the printer output. From the first dropdown, select the channel which the desired sensor is connected. This dropdown will list the labels associated with each channel as configured under Channel Setup. Using the second dropdown, select the unit associated with the measurement to be displayed.

7.15.2 USB data logging

The data log option allows configuring the M400 USB output to send data to a compatible USB memory stick. The data log may be configured to print up to 4 configure measurements on separate lines, for each available sensor input, including pulsed input channels. At each logging cycle, the output will include a header line with data and time based on the M400 internal clock, and one line for each configured measurement including channel, measurement descriptor, measurement value and unit of measure.

The output will appear as follows:

```
11/May/2012 15:36
Ch   Label Measurement
1    CHAN_1 4.01 pH
2    CHAN_1 25 °C
3    CHAN_1 200 DLI
```

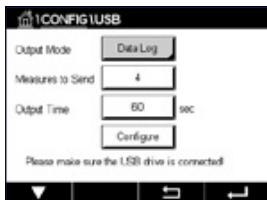

To configure the data log, select option Data log for Output Mode. Configure the following options:

Measures to Send will configure the number of measurements that will be sent for each print cycle.

Enter the total number of measurements to be configured for output. Lines to Print may be set from 1 to 4.

Output Time defines the time in minutes between each print cycle. Output time may be set from 1 to 1000 minutes.

Once the output time and print lines have been established, press the Configure button to format the data log. The number at the left of the window shows the order in which the lines will appear on the printer output. From the first dropdown, select the channel on which the desired sensor is connected. This dropdown will list the labels associated with each channel as configured under Channel Setup. Using the second dropdown, select the unit associated with the measurement to be displayed.



Start or Stop the data log with PATH: \Config\USB data logging after the data log is configured. Or you can setup the custom key to start or stop the data log. (See chapter "9 Custom Key" on page 96). The default setup of USB data logging is "Stop".

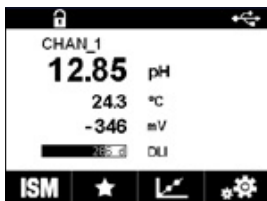

NOTE: Please make sure the USB memory stick is connected before starting the data log. A USB symbol will be displayed on the top of menu screen when a USB memory stick is connected. The compatible USB file system formats are FAT and FAT32.

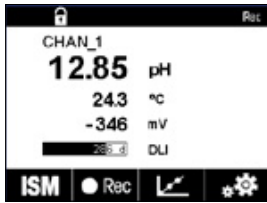

NOTE: A "Rec" symbol will blink while the data is logging to a USB memory stick on the top of the menu screen.

7.16 Configuration via USB

PATH: \Config\Configuration via USB

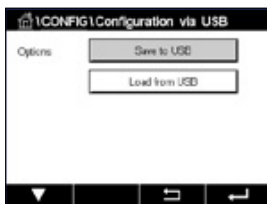

This menu allows the configuration of the current transmitter to be saved to a USB memory stick as a file or upload the configuration from a USB memory stick.

NOTE: The compatible USB file system formats are FAT and FAT32.

The naming of the configuration file must be MT_CFG_x. While x is 1 to 8. Please do not re-name the saved configuration file. The configuration file saved by Transmitter Configuration Tool (TCT) can be used for uploading configuration to the transmitter.

Note: Configuration file cannot be used for M400 transmitter series across different transmitter series. e.g. M300 or M800.

8 ISM

For the menu structure refer to chapter 3.9 "Graphic Trend Measurement".

PATH:  \ ISM

8.1 iMonitor

PATH:  \ ISM \ iMonitor

The iMonitor gives an overview of the current state of the complete loop at a glance.

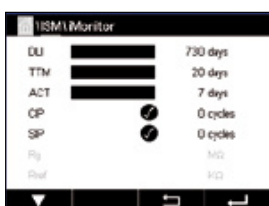

The iMonitor of the first channel is displayed on the screen. To browse through the iMonitor for the different channels press > at the bottom of the display.

The values DLI, TTM and ACT as well as TTCal in combination with UniCond 2-e sensors are shown as bar graph. If the values falls below 20% of the initial value the bar graph changes from green to yellow color. If the value falls below 10% the color changes to red.

For Cond4e sensors the days in operation of the sensor are displayed.

Furthermore SIP-, CIP-, AutoClave-, SAN-cycles as well as the values for Rg and Rref can be displayed and assigned to a colored button if the values are provided by the sensor.

The color for the related button of SIP-, CIP-, Autoclave- and SAN-cycles will change from green to yellow if less then 20% of the defined maximum quantity for the cycle remain and to red if less then 10% remain. For configuration of the maximum quantity see chapter "7.4 ISM Setup" on page 70.

The buttons for Rg and Rref change to yellow if the conditions for a warning messages are fulfilled and to red if the conditions for a alarm message are fulfilled. The buttons remain grey if the corresponding ISM alarm is not configured (see chapter "7.6 ISM / Sensor Alarm" on page 76).

Depending on the measured parameter (connected sensor) the following data are available in the menu iMonitor:

pH: DLI, TTM, ACT, CIP, AutoClave, SIP*, Rg**, Rref**
 Amperometric O₂: DLI, TTM, ACT, CIP, AutoClave, SIP*, Electrolyte***
 O₃: DLI, TTM, ACT, SAN
 Conductivity: Days in operation, TTCal****, CIP, SIP

- * if AutoClave has not been activated (see chapter "7.6 ISM / Sensor Alarm" on page 76)
- ** if the alarm for Rg and/or Rref has been activated (see chapter "7.6 ISM / Sensor Alarm" on page 76)
- *** if the alarm for Electrolyte Level Error has been activated (see chapter "7.6 ISM / Sensor Alarm" on page 76)
- **** if UniCond 2-e sensor is connected

8.2 Messages

PATH:  \ ISM \ Messages

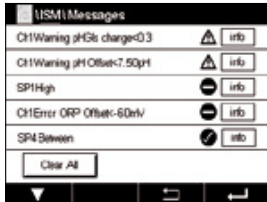

The messages for occurred warnings and alarms are listed in this menu. Up to 100 entries will be listed.



5 messages per page are listed. If more than 5 messages are available additional pages can be accessed.

Unacknowledged alarms or warning will be listed at the beginning. Then the acknowledged but still existing alarm or warning are listed. At the end of the list the already solved warning and alarms are described. Between these groups the messages are listed chronologically.

The state of the warning or alarm is indicated through the following signs:

Symbol	Description	Meaning
	Alarm symbol is blinking	Alarm exists and has not been acknowledged
	Alarm symbol is not blinking	Alarm exists and has been acknowledged
	Warning symbol blinking	Warning exists and has not been acknowledged
	Warning symbol is not blinking	Warning exists and has been acknowledged
	OK symbol is not blinking	Warning or alarm has been solved

An unacknowledged warning or alarm will be acknowledged by pressing the **Info** button in the corresponding line.

For every message the corresponding **Info** button can be pressed. Message information, date and time the warning or alarm has been occurred and the status of the alarm or message are displayed.

If warning or alarm has already been solved the pull up window for the message shows an additional button to clear the message i.e. to delete it from the message list.

8.3 ISM Diagnostics

PATH:  \ ISM \ ISM Diagnostics

The M400 Transmitter provides for all ISM sensors a diagnostic menu. Access the menu Channel and select the channel by pressing the related input field.

Depending on the selected channel and assigned sensor different diagnostic menus are displayed. See the following explanation to get more details about the different diagnostic menus.

8.3.1 pH/ORP, Oxygen, O₃, Cond4e Sensors

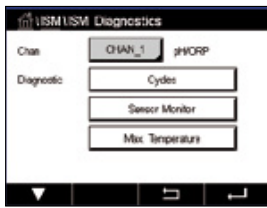

If an pH/ORP, oxygen, O₃ or Cond4e sensor is connected, the diagnostic menus cycles, sensor monitor and max. temperature are available.

Press the **Cycle** button and the information for CIP, SIP and Autoclave cycles of the connected sensor are displayed. The displayed information shows the amount of cycles the sensor has been exposed and the max. limitation for the corresponding cycle as defined in the menu ISM Setup (see chapter "7.4 ISM Setup" on page 70).



NOTE: For Cond4e, which are not autoclavable the menu AutoClave Cycles is not displayed.



NOTE: For O₃ sensors the SAN cycles are displayed.

Press the **Sensor Monitor** button and the information for DLI, TTM and ACT of the connected sensor are displayed. The values DLI, TTM and ACT are shown as bar graph. If the values falls below 20% of the initial value the bar graph changes from green to yellow color. If the value falls below 10% the color changes to red.



NOTE: For Cond4e sensors the operating hours are displayed.

Press the **Max. Temperature** button and the information about the maximum temperature, that the connected sensor has ever seen, together with a time stamp of this maximum is displayed. This value is stored on the sensor and cannot be changed. During autoclaving the max. temperature is not recorded.

8.3.2 UniCond 2-e and UniCond 4-e Sensors

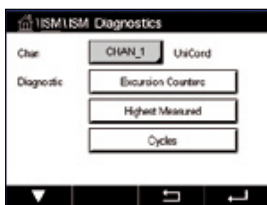

For UniCond 2-e and UniCond 4-e sensors, the following diagnostic items can be viewed: Excursion Counters including High Temp and High Conductivity, Highest Measured including Highest Temp and Highest Cond, Cycles including CIP cycles and SIP Cycles.

8.4 Calibration Data

PATH:  \ ISM \ Calibration Data

The M400 Transmitter provides a calibration history for all ISM sensors. Depending on the assigned sensor different data is available for the calibration history.

See the following explanation to get more details about the different data available for the calibration history.

8.4.1 Calibration Data for All ISM Sensors excluding UniCond 2-e and UniCond 4-e

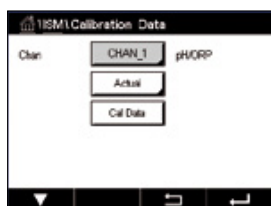

If an ISM sensor – excluding UniCond 2-e and UniCond 4-e – is connected to between the calibration data set of

Actual (Actual adjustment): This is the actual calibration dataset which is used for the measurement. This dataset moves to Cal1 position after the next adjustment.

Factory (Factory calibration): This is the original dataset, determined in the factory. This dataset remains stored in the sensor for reference and cannot be overwritten.

1.Adjust (First adjustment): This is the first adjustment after the factory calibration. This dataset remains stored in the sensor for reference and cannot be overwritten

Cal1 (last calibration/adjustment): This is the last executed calibration/adjustment data set. This dataset moves to Cal2 and then to Cal3 when a new calibration/adjustment is performed. Afterwards, the dataset is not available anymore. Cal2 and Cal3 acting in the same way as Cal1.

Cal2 and **Cal3** can be chosen. For the selection of the calibration data set press the corresponding field.



NOTE: The amperometric oxygen sensor of THORNTON and the O₃ sensor do not provide the data set Cal1, Cal2, Cal3 and 1.Adjust.

Press the **Cal Data** button and the corresponding calibration data set is displayed. Furthermore the time stamp for the calibration and the User ID is listed.



NOTE: This function requires the correct setting of date and time during calibration and / or adjustment tasks (see chapter "7.10 System" on page 78).

8.4.2 Calibration Data for UniCond 2-e and UniCond 4-e Sensors

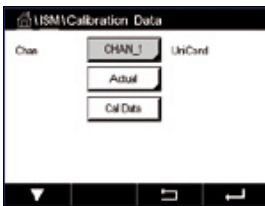

For UniCond 2-e and UniCond 4-e sensors the following three sets of calibration data may be selected:

Actual (Actual calibration): This is the actual calibration dataset which is used for the measurement.

Factory (Factory calibration): This is the original dataset, determined in the factory. This dataset remains stored in the sensor for reference and cannot be overwritten.

Cal1 (last calibration/adjustment): This is the last executed calibration/adjustment data set.

Press the Cal Data button and the corresponding calibration data set is displayed.

If the data set of the actual calibration has been chosen, on page 1, the date and time of the calibration, User ID, conductivity calibration constants, and reference conductivity values to calibrate are displayed. On page 2 the As-found conductivity values and the deviation from the reference are shown. On page 3 and 4 the same information for temperature is displayed. On page 5 the calibration cycles applied to the sensor and the next calibration date for conductivity (C) and temperature (T) are displayed.

If the dataset of the factory calibration has been chosen, on page 1, the date and time of the calibration, the conductivity calibration constants, and reference conductivity values used to calibrate are displayed. On page 2, the same values for temperature are shown.

Press \leftarrow to exit the menu Cal Data.



NOTE: This function requires the correct setting of date and time during calibration and / or adjustment tasks (see chapter "7.10 System" on page 78).

8.5 Sensor Info

PATH: \leftarrow \ ISM \ Sensor Info

The model, hardware and software version, last calibration date as well as the product and serial number of the ISM sensors, that are connected to the M400 Transmitter can be displayed on the screen.

Enter Sensor Info.

The data of the channel, a sensor is connected, are displayed on the screen.

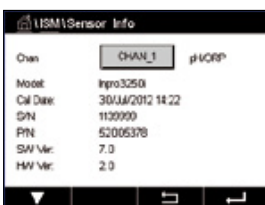

The data Model, Cal Date (date of last adjustment), S/N (serial number), P/N (product number), SW Ver (software version) and HW Ver (hardware version) of the select sensor are displayed.



NOTE: If a UniCond 2-e sensor is connected the following data is also displayed, Temp Sens. (temperature sensor) Electrode (electrode material), Body/Ins Mat: (body and/or insulator material), Inner: (inner electrode material), Outer (outer electrode material) Fitting: (fitting material), Class VI (FDA Class VI material).

To exit the menu Sensor Info press \leftarrow . To return to the Menu Screen press Home .

8.6 HW / SW Version

PATH: Home \ ISM \ HW/SW Version

The hardware and software version as well as the product number and serial number of the M400 Transmitter itself or the different boards, that are plugged in can be displayed on the screen.

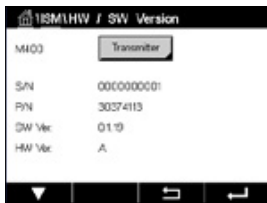

The data of the transmitter is displayed on the screen. Press the input field in the line of **M400**. To select the data of the desired board or the transmitter itself press the corresponding field.

The data S/N (serial number), P/N (product number), SW Ver (software version) and HW Ver (hardware version) of the select board or transmitter are displayed.

9 Custom Key

PATH:  \ Config \ Custom Key Setup



This menu allows the setting of a customize menu to the second left button on the menu screen as a shortcut. The custom key is a convenient option for soft key operation especially when touch-screen is not used.

Options: The "FAV" favorite is the default option. See chapter „Set Favorite“ for favorite setup.

- "Lock screen" can be selected for locking the screen
- "Trend" can be selected for graphic trend display
- "Messages" can be selected for the shortcut to access messages menu.
- "PID" can be selected for manual PID adjustment
- "Data log" can be selected for starting or stopping USB data logging.

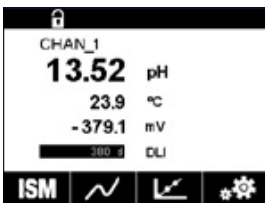

After the custom key setup, the selected custom key will be displayed at the second left button on the menu screen.



NOTE: The option "Data log" will be displayed only if "USB data logging" is selected. The option "PID" will be displayed only if manual PID controller is set.

9.1 Set Favorite

PATH:  \ FAVORITE \ Set Favorite

The M400 Transmitter allows set up of up to 4 favorites to ensure a quick access for frequently used functions.

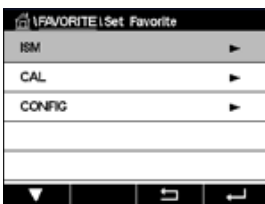

The main menus are displayed. Choose the menu, that contains the function, which should be defined as a favorite, e.g. ISM through pressing the corresponding arrow ► in the same line.

Choose the function, that should be set as a favorite by activating the option. A function, which is set as a favorite shows ★ icon.



NOTE: Deactivate the option by pressing on the icon again. The favorite ★ icon is not shown any more.

Access the menu Set Favorites. The favorites defined are listed on this page. Press the corresponding arrow ► for the function in the same line.

10 Maintenance

10.1 Front panel cleaning

Clean the surfaces with a soft damp cloth and dry the surfaces with a cloth carefully.

11 Software History

Model	Software version	Release date	Software changes
M400 Type1 ISM	V2.0.0	October 2018	–
M400 Type1 ISM	V2.0.0	October 2018	–

12 Troubleshooting

If the equipment is used in a manner not specified by Mettler-Toledo, the protection provided by the equipment may be void.

Review the table below for possible causes of common problems:

Problem	Possible Cause
Display is blank.	<ul style="list-style-type: none"> – No power to M400. – Hardware failure.
Incorrect measurement readings.	<ul style="list-style-type: none"> – Sensor improperly installed. – Incorrect units multiplier entered. – Temperature compensation incorrectly set or disabled. – Sensor or transmitter needs calibration. – Sensor or patch cord defective or exceeds recommended maximum length. – Hardware failure.
Measurement readings not stable.	<ul style="list-style-type: none"> – Sensors or cables installed too close to equipment that generates high level of electrical noise. – Recommended cable length exceeded. – Averaging set too low. – Sensor or patch cord defective.
Alarm symbol is shown.	<ul style="list-style-type: none"> – Setpoint is in alarm condition (setpoint exceeded). – Alarm has been selected (see chapter “7.6 ISM / Sensor Alarm” on page 76) and occurred.
Cannot change menu settings.	<ul style="list-style-type: none"> – User locked out for security reasons.

12.1 Conductivity (resistive) Error messages / Warning- and Alarm list for ISM sensors

Alarms	Description
Watchdog time-out*	SW/System fault
Dry Cond sensor*	Cell running dry (no measurement solution)
Cell deviation*	Multiplier out of tolerance** (depends on sensor model).

* Activate this function in the transmitter settings (see chapter "7.6 ISM / Sensor Alarm" on page 76

PATH: Menu/ISM/Sensor Alarm).

** For further information refer to the sensor documentation

12.2 pH Error messages/Warning- and Alarm list

12.2.1 pH, pH/pNa and Dissolved Carbon Dioxide sensors

Warnings	Description
Warning pH Slope too high	Slope >102%
Warning pH Slope too low	Slope < 90%
Warning pH offset too high	pH ZeroPt > mmmptH
Warning pH offset too low	pH ZeroPt < nnnptH
Warning glass resistance low**	Glass electrode resistance changed by less than factor 0.3
Warning glass resistance high**	Glass electrode resistance changed by more than factor 3
Warning pH reference resistance low**	Reference electrode resistance changed by less than factor 0.3
Warning reference resistance high**	Reference electrode resistance changed by more than factor 3

Alarms	Description
Watchdog time-out	SW/System fault
Error pH Slope too high	Slope >103%
Error pH Slope too low	Slope <80%
Error pH offset too high	pH ZeroPt > xxxpH
Error pH offset too low	pH ZeroPt < yyypH
Error pH reference resistance high*	Reference electrode resistance >150 K Ω (break)
Error pH reference resistance low*	Reference electrode resistance <1000 Ω (short)
Error pH glass resistance high*	Glass electrode resistance > 2000 M Ω (break)
Error pH glass resistance low*	Glass electrode resistance < 5 M Ω (short)

* Activate this function in the transmitter settings (see chapter "7.6 ISM / Sensor Alarm" on page 76 PATH: Menu/ISM/Sensor Alarm).

12.2.2 ORP messages

Warnings	Description
Warning ORP ZeroPt > 30 mV	Zero offset too big
Warning ORP ZeroPt < -30 mV	Zero offset too small

Alarms	Description
Watchdog time-out	SW/System fault
Error ORP ZeroPt > 60 mV	Zero offset too big
Error ORP ZeroPt < -60 mV	Zero offset too small

12.3 Amperometric O₂ Error messages / Warning- and Alarm list

12.3.1 High level oxygen sensors

Warnings	Description
Warning O ₂ Slope < -90 nA	Slope too big
Warning O ₂ Slope > -35 nA	Slope too small
Warning O ₂ ZeroPt > 0.3 nA	Zero offset too big
Warning O ₂ ZeroPt < -0.3 nA	Zero offset too small

Alarms	Description
Watchdog time-out	SW/System fault
Error O ₂ Slope < -110 nA	Slope too big
Error O ₂ Slope > -30 nA	Slope too small
Error O ₂ ZeroPt > 0.6 nA	Zero offset too big
Error O ₂ ZeroPt < -0.6 nA	Zero offset too small
Electrolyte Low	Too low level of electrolyte

12.3.2 Low level oxygen sensors

Warnings	Description
Warning O ₂ Slope < -460 nA	Slope too big
Warning O ₂ Slope > -250 nA	Slope too small
Warning O ₂ ZeroPt > 0.5 nA	Zero offset too big
Warning O ₂ ZeroPt < -0.5 nA	Zero offset too small

Alarms	Description
Watchdog time-out	SW/System fault
Error Install O ₂ Jumper	In case of using Hi Performance Oxygen a jumper has to be installed.
Error O ₂ Slope < -525 nA	Slope too big
Error O ₂ Slope > -220 nA	Slope too small
Error O ₂ ZeroPt > 1.0 nA	Zero offset too big
Error O ₂ ZeroPt < -1.0 nA	Zero offset too small
Electrolyte Low	Too low level of electrolyte

12.3.3 Trace oxygen sensors

Warnings	Description
Warning O ₂ Slope < -5000 nA	Slope too big
Warning O ₂ Slope > -3000 nA	Slope too small
Warning O ₂ ZeroPt > 0.5 nA	Zero offset too big
Warning O ₂ ZeroPt < -0.5 nA	Zero offset too small

Alarms	Description
Watchdog time-out	SW/System fault
Error O ₂ Slope < -6000 nA	Slope too big
Error O ₂ Slope > -2000 nA	Slope too small
Error O ₂ ZeroPt > 1.0 nA	Zero offset too big
Error O ₂ ZeroPt < -1.0 nA	Zero offset too small
Electrolyte Low	Too low level of electrolyte

12.4 Warning- and Alarm Indication

12.4.1 Warning Indication



Warnings are indicated by a warning symbol in the head line of the display. A warning message will be recorded and can be selected through the menu Messages (PATH: $\text{ISM} \setminus \text{Messages}$; see also chapter 8.2 "Messages").

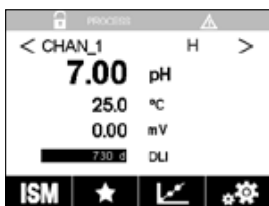

NOTE: If the warning has not been acknowledged, the head line of the display will blink. If the warning has already been acknowledged, the head line will be displayed continuously. See also chapter 8.2 "Messages". In the case of an unacknowledged warning or alarm the transmitter screen will not be dimmed or switched off even if the light time has elapsed (see chapter 7.8 "Display Setup").



NOTE: If at the same time a channel has both an alarm and a warning indicated, the indication of the alarm will have higher priority. The alarm will be indicated (see chapter 12.4 "Warning- and Alarm Indication") on the Menu Screen or Start Screen, while the warning will not be shown.



Pressing the head line on the Menu Screen will lead to the Messages. Refer to chapter 8.2 "Messages" for the description of the functionality for this menu.



NOTE: The detection of some warnings can be activated/deactivated through (de)activating the corresponding alarm. Refer to chapter 7.6 "ISM / Sensor Alarm".

12.4.2 Alarm Indication



Alarms are indicated by an alarm symbol in the head line of the display.

An alarm message will be recorded and can be selected through the menu Messages (PATH: \ISM\Messages; see also chapter 8.2 "Messages").



NOTE: If the alarm has not been acknowledged, the head line of the display will blink. If the alarm has already been acknowledged, the head line will be displayed continuously. See also chapter 8.2 "Messages". In the case of an unacknowledged warning or alarm the transmitter screen will not be dimmed or switched off even if the light time has been elapsed (see chapter 7.8 "Display Setup").



NOTE: If at the same time a channel has born an alarm and a warning indicated, the indication of the alarm will have higher priority. The alarm will be indicated (see chapter 12.4 "Warning- and Alarm Indication") on the Menu Screen or Start Screen, while the warning will not be shown.



Pressing the head line on the Menu Screen will lead to the Messages. Refer to chapter 8.2 "Messages" for the description of the functionality for this menu.



NOTE: The detection of some alarms can be activated/deactivated. Refer therefore to chapter 7.6 "ISM / Sensor Alarm".



NOTE: Alarms which are caused by a violation of the limitation of a setpoint or the range (PATH: \CONFIG\Set Points; see also chapter 7.3 "Set Points") will also be indicated on the display and recorded through the menu Messages (PATH: \ISM\Messages; see also chapter 8.2 "Messages").

13 Ordering Information, Accessories and Spare Parts

Please contact your local Mettler-Toledo sales office or representative for details on additional accessories and spare parts.

Transmitter	Order no.
M400 Type 1 ISM	30 490 171
M400 Type 2 ISM	30 490 172

1) Included: 1 piece M25×1.5 cable gland, 4 pieces M20×1.5 cable glands

Description	Order no.
Pipe mounting kit for ½ DIN for pipe diameter 40 to 60 mm (1.57 to 2.36")	30 300 480
Panel mounting kit for ½ DIN	30 300 481
Wall mounting kit for ½ DIN	30 300 482
Protective hood for ½ DIN	30 073 328

14 Specifications

14.1 General specifications

pH/ORP (incl. pH/pNa)

Measurement parameters	pH, mV and temperature
pH display range	-2.00 to +16.00 pH
pH resolution	Auto/0.001/0.01/0.1/1 (can be selected)
mV range	-1500 to +1500 mV
mV resolution	Auto/0.001/0.01/0.1/1 mV (can be selected)
Temperature measuring range	-30 to +140 °C (-22 to +284 °F)
Temperature resolution	Auto/0.001/0.01/0.1/1 (can be selected)
Temperature compensation	Automatic/Manual
Max. sensor cable length	ISM: 80 m (260 ft)
Calibration	1-point, 2-point or process

Amperometric oxygen

Measurement parameters	Dissolved oxygen (DO): Saturation or concentration and temperature
Measuring current range	Analog: 0 to -7000 nA
Oxygen display ranges	<ul style="list-style-type: none"> Dissolved Oxygen Saturation: 0 to 500 % air, 0 to 200 % O₂-sat Concentration: 0 ppb (µg/L) to 50.00 ppm (mg/L)
DO resolution	Auto/0.001/0.01/0.1/1 (can be selected)
Polarization voltage	<ul style="list-style-type: none"> O₂ High: Cal/Meas: -675 mV (Configurable) O₂ Low: Cal: -675 mV, Meas: -500 mV (Configurable)
Temperature compensation	Automatic
Temperature measuring range	-10 to +80 °C (+14 to +176 °F)
Temperature resolution	Auto/0.001/0.01/0.1/1 °C (°F) (can be selected)
Max. sensor cable length	• ISM: 80 m (260 ft)
Calibration	1-point (slope and offset) or process (slope and offset)

Optical oxygen

Measurement parameters	Dissolved Oxygen (DO): Saturation or concentration and temperature
Oxygen display ranges	<ul style="list-style-type: none"> Dissolved Oxygen Saturation: 0 to 500 % air, 0 to 200 % O₂-sat Concentration: 0 ppb (µg/L) to 50.00 ppm (mg/L)
Oxygen accuracy	± 1 digit
Oxygen resolution	Auto/0.001/0.01/0.1/1 (can be selected)
Temperature compensation	Automatic
Temperature measuring range	-30 to +150 °C (-22 to +302 °F)
Temperature resolution	Auto/0.001/0.01/0.1/1 °C (°F) (can be selected)
Temperature accuracy	± 1 digit
Max. sensor cable length	80 m (260 ft)
Calibration	1-point (depending on sensor model) 2-point or process, process scaling

Dissolved carbon dioxide

Measurement parameters	Dissolved carbon dioxide and temperature
CO ₂ display range	0 to 5000 mg/L 0 to 200% sat 0 to 1500 mm Hg 0 to 2000 mbar 0 to 2000 hPa
CO ₂ accuracy	± 1 digit
CO ₂ resolution	Auto/0.001/0.01/0.1/1 (can be selected)
mV range	-1500 to +1500 mV
mV resolution	Auto/0.01/0.1/1 mV (can be selected)
mV accuracy	± 1 digit
Total pressure range	0 to 4000 mbar
Temperature measuring range	-30 to +150 °C (-22 to +302 °F)
Temperature resolution	Auto/0.001/0.01/0.1/1 °C (°F) (can be selected)
Temperature accuracy	± 1 digit
Max. sensor cable length	80 m (260 ft)
Calibration	1-point (offset), 2-point (slope and offset) or process (offset)

Dissolved ozone

Measurement parameters	Concentration and temperature
Display range for current	Analog: 0 to -7000 nA
Ozone measuring range	0 to 5000 ppb (µg/L) O ₃
Ozone accuracy	± 1 % (or 0.4 ppb) up to 2000 ppb ± 2.5 % (or 50–125 ppb) from 2000 to 5000 ppb
Resolution	± 1 digit
Temperature compensation	Automatic
Temperature measuring range	5 to +50 °C (+41 to +122 °F)
Temperature resolution	Auto/0.001/0.01/0.1/1 (can be selected)
Max. sensor cable length	80 m
Calibration	1-point (offset) or process (slope and offset)

Conductivity 2-e/4-e

Measurement parameters	Conductivity/resistivity and temperature
Conductivity ranges	See sensor specification
Chemical concentration curves (used with 4-e sensors)	NaCl: 0–26% @ 0 °C to 0–28% @ +100 °C NaOH: 0–12% @ 0 °C to 0–16% @ +40 °C to 0–6% @ +100 °C HCl: 0–18% @ -20 °C to 0–18% @ 0 °C to 0–5% @ +50 °C HNO ₃ : 0–30% @ -20 °C to 0–30% @ 0 °C to 0–8% @ +50 °C H ₂ SO ₄ : 0–26% @ -12 °C to 0–26% @ +5 °C to 0–9% @ +100 °C H ₃ PO ₄ : 0–35% @ +5 °C to +80 °C
TDS ranges	NaCl, CaCO ₃
Cond/Res resolution	Auto/0.001/0.01/0.1/1 (can be selected)
Temperature measuring range	-40 to +200 °C (-40 to +392 °F)
Temperature resolution	Auto/0.001/0.01/0.1/1 (can be selected)
Max. sensor cable length	4-e sensors: 80 m (260 ft)
Calibration	1-point, 2-point or process

14.2 Electrical specifications

Supply voltage	<ul style="list-style-type: none"> • 80 to 255 VAC, 50 to 60 Hz, 10 VA • 20 to 30 VDC, 10 VA
Connection terminal	Detachable screw terminals, appropriate for wire cross section 0.2 to 1.5 mm ² (AWG 16–24)
Mains fuse	2.0 A slow blow, type FC
Analog output ¹⁾	4 × 0/4 to 20 mA, 22 mA alarm, galvanically isolated from input and from earth/ground
Measurement error through analog outputs	< ±0.05 mA over 1 to 22 mA range
Analog output configuration	Linear, bi-linear, logarithmic, auto range
Load	Max. 500 Ω
PID process controller	1 × PID with pulse length, pulse frequency or analog control output signal
Cycle time analog output	Ca. 1 s
Hold input/Alarm contact	Yes/Yes
Alarm output delay	0 to 999 s, selectable
Relays	<ul style="list-style-type: none"> • 2 SPDT, mechanical, 250 VAC or 30 VDC, 3 A • 2 SPST, Reed, 250 VAC or 250 VDC, 0.5 A, 10 W
Digital input	2 With switching limits 0.00 VDC to 1.00 VDC inactive, 2.30 VDC to 30.00 VDC active; galvanically isolated up to 60 V from output, analog input and ground/earth
Analog input ²⁾	1 × 0/4 to 20 mA
User interface	<ul style="list-style-type: none"> • TFT touch-screen 4" • Black and white • Resolution: ¼ VGA (320 pixel × 240 pixel)
Keypad	• 4 tactile feedback keys
Languages	10 (English, German, French, Italian, Spanish, Portuguese, Russian, Japanese, Korean and Chinese)
Interfaces	<ul style="list-style-type: none"> • 1 USB Host: Printer connection, data logging, loading configuration from USB stick and saving configuration to USB stick • 1 USB Device: Software update interface

1) For M400 Type1 ISM and M400 Type2 ISM

2) For M400 Type2 ISM

14.3 Environmental specifications

Storage temperature	-40 to +70 °C (-40 to +158 °F)
Ambient temperature ≠ operating range	-20 to +50 °C (-4 to +122 °F)
Relative humidity	0 to 95 % non-condensing
Altitude	Max. 2000 m
EMC	Compliant with EN 61326-1:2013 (Industrial environment) Emission: Class A, Immunity: Class A
UL	Installation (overvoltage) Category II
CE mark	The measuring system is in conformity with the statutory requirements of the EC Directives. METTLER TOLEDO confirms successful testing of the device by affixing to it the CE mark.
Ex Approvals	<ul style="list-style-type: none"> • cCSAus Class I, Division 2, Groups A, B, C, D T4 Class I, Zone 2, AEx nA nC IIC T4 Gc • FM Class I, Division 2, Groups A,B,C,D T4 Class I, Zone 2, Groups IIC T4 • ATEX II 3G Ex nA nC IIC T4 Gc

14.4 Mechanical specifications

Dimensions	Housing – Height × Width × Depth	136 × 136 × 116 mm (5.35 × 5.35 × 4.57")
	Front bezel – Height × Width	150 × 150 mm (5.91 × 5.91")
	Max. depth – panel mounted	116 mm (4.57") (excludes plug-in connectors)
Weight	1.50 kg (3.3 lb)	
Material	Aluminum (ADC12) die cast	
Enclosure rating	IP 66/NEMA 4X	

15 Warranty

METTLER TOLEDO warrants this product to be free from significant deviations in material and workmanship for a period of one year from the date of purchase. If repair is necessary and not the result of abuse or misuse within the warranty period, please return by pre-paid freight and an amendment will be made without any charge. METTLER TOLEDO's Customer Service Dept. will determine if the product problem is due to deviations or customer abuse. Out-of-warranty products will be repaired on an exchange basis at cost.

The above warranty is the only warranty made by METTLER TOLEDO and is in lieu of all other warranties, expressed or implied, including, without limitation, implied warranties of merchantability and fitness for a particular purpose. METTLER TOLEDO shall not be liable for any loss, claim, expense or damage caused by, contributed to or arising out of the acts or omissions of the

Buyer or Third Parties, whether negligent or otherwise. In no event shall METTLER TOLEDO's liability for any cause of action whatsoever exceed the cost of the item giving rise to the claim, whether based in contract, warranty, indemnity, or tort (including negligence).

16 Buffer tables

M400 Transmitters have the ability to do automatic pH buffer recognition. The following tables show different buffers that are automatically recognized.

16.1 Standard pH buffers

16.1.1 Mettler-9

Temp (°C)	pH of buffer solutions			
0	2.03	4.01	7.12	9.52
5	2.02	4.01	7.09	9.45
10	2.01	4.00	7.06	9.38
15	2.00	4.00	7.04	9.32
20	2.00	4.00	7.02	9.26
25	2.00	4.01	7.00	9.21
30	1.99	4.01	6.99	9.16
35	1.99	4.02	6.98	9.11
40	1.98	4.03	6.97	9.06
45	1.98	4.04	6.97	9.03
50	1.98	4.06	6.97	8.99
55	1.98	4.08	6.98	8.96
60	1.98	4.10	6.98	8.93
65	1.98	4.13	6.99	8.90
70	1.99	4.16	7.00	8.88
75	1.99	4.19	7.02	8.85
80	2.00	4.22	7.04	8.83
85	2.00	4.26	7.06	8.81
90	2.00	4.30	7.09	8.79
95	2.00	4.35	7.12	8.77

16.1.2 Mettler-10

Temp (°C)	pH of buffer solutions			
0	2.03	4.01	7.12	10.65
5	2.02	4.01	7.09	10.52
10	2.01	4.00	7.06	10.39
15	2.00	4.00	7.04	10.26
20	2.00	4.00	7.02	10.13
25	2.00	4.01	7.00	10.00
30	1.99	4.01	6.99	9.87
35	1.99	4.02	6.98	9.74
40	1.98	4.03	6.97	9.61
45	1.98	4.04	6.97	9.48
50	1.98	4.06	6.97	9.35
55	1.98	4.08	6.98	
60	1.98	4.10	6.98	
65	1.98	4.13	6.99	
70	1.99	4.16	7.00	
75	1.99	4.19	7.02	
80	2.00	4.22	7.04	
85	2.00	4.26	7.06	
90	2.00	4.30	7.09	
95	2.00	4.35	7.12	

16.1.3 NIST Technical Buffers

Temp (°C)	pH of buffer solutions				
0	1.67	4.00	7.115	10.32	13.42
5	1.67	4.00	7.085	10.25	13.21
10	1.67	4.00	7.06	10.18	13.01
15	1.67	4.00	7.04	10.12	12.80
20	1.675	4.00	7.015	10.07	12.64
25	1.68	4.005	7.00	10.01	12.46
30	1.68	4.015	6.985	9.97	12.30
35	1.69	4.025	6.98	9.93	12.13
40	1.69	4.03	6.975	9.89	11.99
45	1.70	4.045	6.975	9.86	11.84
50	1.705	4.06	6.97	9.83	11.71
55	1.715	4.075	6.97		11.57
60	1.72	4.085	6.97		11.45
65	1.73	4.10	6.98		
70	1.74	4.13	6.99		
75	1.75	4.14	7.01		
80	1.765	4.16	7.03		
85	1.78	4.18	7.05		
90	1.79	4.21	7.08		
95	1.805	4.23	7.11		

16.1.4 NIST standard buffers (DIN and JIS 19266: 2000–01)

Temp (°C)	pH of buffer solutions			
0				
5	1.668	4.004	6.950	9.392
10	1.670	4.001	6.922	9.331
15	1.672	4.001	6.900	9.277
20	1.676	4.003	6.880	9.228
25	1.680	4.008	6.865	9.184
30	1.685	4.015	6.853	9.144
37	1.694	4.028	6.841	9.095
40	1.697	4.036	6.837	9.076
45	1.704	4.049	6.834	9.046
50	1.712	4.064	6.833	9.018
55	1.715	4.075	6.834	8.985
60	1.723	4.091	6.836	8.962
70	1.743	4.126	6.845	8.921
80	1.766	4.164	6.859	8.885
90	1.792	4.205	6.877	8.850
95	1.806	4.227	6.886	8.833



NOTE: The pH(S) values of the individual charges of the secondary reference materials are documented in a certificate of an accredited laboratory. This certificate is supplied with the respective buffer materials. Only these pH(S) values shall be used as standard values for the secondary reference buffer materials. Correspondingly, this standard does not include a table with standard pH values for practical use. The table above only provides examples of pH(PS) values for orientation.

16.1.5 Hach buffers

Buffer values up to 60 °C as specified by Bergmann & Beving Process AB.

Temp (°C)	pH of buffer solutions		
0	4.00	7.14	10.30
5	4.00	60	10.23
10	4.00	7.04	10.11
15	4.00	7.04	10.11
20	4.00	7.02	10.05
25	4.01	7.00	10.00
30	4.01	6.99	9.96
35	4.02	6.98	9.92
40	4.03	6.98	9.88
45	4.05	6.98	9.85
50	4.06	6.98	9.82
55	4.07	6.98	9.79
60	4.09	6.99	9.76

16.1.6 Ciba (94) buffers

Temp (°C)	pH of buffer solutions				
0	2.04	4.00	7.10	10.30	
5	2.09	4.02	7.08	10.21	
10	2.07	4.00	7.05	10.14	
15	2.08	4.00	7.02	10.06	
20	2.09	4.01	6.98	9.99	
25	2.08	4.02	6.98	9.95	
30	2.06	4.00	6.96	9.89	
35	2.06	4.01	6.95	9.85	
40	2.07	4.02	6.94	9.81	
45	2.06	4.03	6.93	9.77	
50	2.06	4.04	6.93	9.73	
55	2.05	4.05	6.91	9.68	
60	2.08	4.10	6.93	9.66	
65	2.07*	4.10*	6.92*	9.61*	
70	2.07	4.11	6.92	9.57	
75	2.04*	4.13*	6.92*	9.54*	
80	2.02	4.15	6.93	9.52	
85	2.03*	4.17*	6.95*	9.47*	
90	2.04	4.20	6.97	9.43	
95	2.05*	4.22*	6.99*	9.38*	

* Extrapolated

16.1.7 Merck Titrisole, Riedel-de-Haën Fixanale

Temp (°C)	pH of buffer solutions				
0	2.01	4.05	7.13	9.24	12.58
5	2.01	4.05	7.07	9.16	12.41
10	2.01	4.02	7.05	9.11	12.26
15	2.00	4.01	7.02	9.05	12.10
20	2.00	4.00	7.00	9.00	12.00
25	2.00	4.01	6.98	8.95	11.88
30	2.00	4.01	6.98	8.91	11.72
35	2.00	4.01	6.96	8.88	11.67
40	2.00	4.01	6.95	8.85	11.54
45	2.00	4.01	6.95	8.82	11.44
50	2.00	4.00	6.95	8.79	11.33
55	2.00	4.00	6.95	8.76	11.19
60	2.00	4.00	6.96	8.73	11.04
65	2.00	4.00	6.96	8.72	10.97
70	2.01	4.00	6.96	8.70	10.90
75	2.01	4.00	6.96	8.68	10.80
80	2.01	4.00	6.97	8.66	10.70
85	2.01	4.00	6.98	8.65	10.59
90	2.01	4.00	7.00	8.64	10.48
95	2.01	4.00	7.02	8.64	10.37

16.1.8 WTW buffers

Temp (°C)	pH of buffer solutions			
0	2.03	4.01	7.12	10.65
5	2.02	4.01	7.09	10.52
10	2.01	4.00	7.06	10.39
15	2.00	4.00	7.04	10.26
20	2.00	4.00	7.02	10.13
25	2.00	4.01	7.00	10.00
30	1.99	4.01	6.99	9.87
35	1.99	4.02	6.98	9.74
40	1.98	4.03	6.97	9.61
45	1.98	4.04	6.97	9.48
50	1.98	4.06	6.97	9.35
55	1.98	4.08	6.98	
60	1.98	4.10	6.98	
65	1.99	4.13	6.99	
70		4.16	7.00	
75		4.19	7.02	
80		4.22	7.04	
85		4.26	7.06	
90		4.30	7.09	
95		4.35	7.12	

16.1.9 JIS Z 8802 buffers

Temp (°C)	pH of buffer solutions			
0	1.666	4.003	6.984	9.464
5	1.668	3.999	6.951	9.395
10	1.670	3.998	6.923	9.332
15	1.672	3.999	6.900	9.276
20	1.675	4.002	6.881	9.225
25	1.679	4.008	6.865	9.180
30	1.683	4.015	6.853	9.139
35	1.688	4.024	6.844	9.102
38	1.691	4.030	6.840	9.081
40	1.694	4.035	6.838	9.068
45	1.700	4.047	6.834	9.038
50	1.707	4.060	6.833	9.011
55	1.715	4.075	6.834	8.985
60	1.723	4.091	6.836	8.962
70	1.743	4.126	6.845	8.921
80	1.766	4.164	6.859	8.885
90	1.792	4.205	6.877	8.850
95	1.806	4.227	6.886	8.833

16.2 Dual membrane pH electrode buffers

16.2.1 Mettler-pH/pNa buffers (Na⁺ 3.9M)

Temp (°C)	pH of buffer solutions			
0	1.98	3.99	7.01	9.51
5	1.98	3.99	7.00	9.43
10	1.99	3.99	7.00	9.36
15	1.99	3.99	6.99	9.30
20	1.99	4.00	7.00	9.25
25	2.00	4.01	7.00	9.21
30	2.00	4.02	7.01	9.18
35	2.01	4.04	7.01	9.15
40	2.01	4.05	7.02	9.12
45	2.02	4.07	7.03	9.11
50	2.02	4.09	7.04	9.10

For addresses of METTLER TOLEDO
Market Organizations please go to:
www.mt.com/contacts

www.mt.com/pro

For more information



Management System
certified according to
ISO 9001/ISO 14001



METTLER TOLEDO Group
Process Analytics
Local contact: www.mt.com/contacts

Subject to technical changes
© 03/2023 METTLER TOLEDO
All rights reserved
Printed in Switzerland. 30 519 416 B

