

Operation Manual

Multi-parameter Transmitter M800 Water PROFINET and M800 Water Ethernet/IP™



Transmitter Multi-parameter M800 Water PROFINET and Ethernet/IP
30530028_DOC_EN Rev B

Operation Manual

Multi-parameter Transmitter M800 Water PROFINET and M800 Water Ethernet/IP™

Content

1	Introduction	9
2	Safety instructions	10
2.1	Definition of equipment and documentation symbols and designations	10
2.2	Correct disposal of the unit	11
3	Unit overview	12
3.1	Overview	12
3.2	Display	12
3.2.1	Start Screen	12
3.2.2	Activation Menu Screen	13
3.3	Graphic Trend Measurement	14
3.3.1	Activation Trend Display Screen	14
3.3.2	Settings for Trend Display Screen	15
3.3.3	Deactivation Trend Display Screen	15
3.4	Control/Navigation	16
3.4.1	Menu Structure	16
3.4.2	Operating Elements	17
3.4.3	Entry of Data	17
3.4.4	Selection Menus	17
3.4.5	"Save changes" Dialog	17
3.4.6	Security Passwords	18
3.4.7	Display	18
4	Installation instruction	19
4.1	Unpacking and inspection of equipment	19
4.2	Mounting	20
4.2.1	Dimensions	20
4.2.2	Mounting Procedure	21
4.2.3	Panel Mounting	22
4.2.4	Wall Mounting	22
4.2.5	Pipe Mounting	23
4.3	Electrical Connection	24
4.4	Terminal Definition	25
4.4.1	M800 Water PROFINET and EtherNet/IP 2-Channel	25
4.4.2	M800 Water PROFINET and EtherNet/IP 2- and 4-Channel: TB2 – Terminal Assignment for Optical Oxygen, UniCond2e, UniCond4e and 6000TOCi ISM Sensors	26
4.4.3	M800 Water PROFINET and EtherNet/IP 2- and 4-Channel: TB2 and TB5 – Terminal Assignment for pH, Amp. Oxygen, Cond 4e and O ₃ ISM Sensors	27
4.4.4	M800 Water PROFINET and EtherNet/IP 2- and 4-Channel: TB3 – Terminal Assignment for Flow Sensors	27
4.4.5	Connecting the Cable	28
4.4.5.1	Connect the M12 Cable	28
4.4.5.2	Connect RJ45 Cable	28
4.5	Connection of Flow Sensor	29
4.5.1	Flow Sensor Input Wiring Kit	29
4.5.2	Kit Contents	29
4.5.3	Flow sensor wiring for Compatible Sensors	29
4.5.4	Wiring for "HIGH" type flow sensors	30
4.5.5	Wiring for "LOW" type flow sensors	32
4.5.6	Wiring for "TYPE 2" flow sensors	32
5	Placing transmitter in, or out, of service	33
5.1	Placing transmitter in service	33
5.2	Placing transmitter out of service	33
6	Guided Setup	34
7	Calibration	35
7.1	Sensor Calibration	35
7.2	Calibration of UniCond2e and UniCond4e Sensors (ISM Sensors only)	35
7.2.1	One-Point Calibration	37
7.2.2	Two-Point Calibration	38
7.2.3	Process Calibration	39
7.2.4	Temperature Calibration of UniCond2e Sensors and UniCond4e Sensors	40
7.2.4.1	One-Point Calibration	40
7.2.4.2	Two-Point Calibration	41

7.3	pH Calibration	43
7.3.1	One-Point Calibration	43
7.3.2	Two-Point Calibration	44
7.3.3	Process Calibration	45
7.4	ORP Calibration of pH Sensors	45
7.5	Calibration of Amperometric Oxygen Sensors	46
7.5.1	One-Point Calibration	46
7.5.2	Process Calibration	47
7.6	Calibration of Optical Oxygen Sensors (ISM Sensors only)	48
7.6.1	One-Point Calibration	48
7.6.2	Two-Point Calibration	49
7.6.3	Process Calibration	49
7.7	Calibration of O ₃ Sensors (ISM Sensors only)	50
7.7.1	One-Point Calibration	51
7.7.2	Process Calibration	52
7.8	UniCond2e Electronics Calibration	53
7.9	Calibration of Flow Sensors (ISM Sensors only)	53
7.9.1	One-Point Calibration	54
7.9.2	Two-Point Calibration	55
7.10	Sensor Verification	56
7.11	Edit Calibration Constants for Flow Sensors	56
7.12	Flow Meter Verification	57
7.13	Analog Input Calibration	57
7.14	Maintenance	58
8	Configuration	59
8.1	Measurement	59
8.1.1	Channel Setup	59
8.1.2	Derived Measurements	60
8.1.2.1	% Rejection measurement	60
8.1.2.2	Calculated pH (Power Plant Applications only)	60
8.1.2.3	Calculated CO ₂ (Power plant applications only)	61
8.1.3	Display Mode	61
8.1.4	Parameter related Settings	62
8.1.4.1	Conductivity Settings	62
8.1.4.2	pH Settings	63
8.1.4.3	Settings for Oxygen Measurement Based on Amperometric Sensors	64
8.1.4.4	Settings for Oxygen Measurement Based on Optical Sensors	65
8.1.4.5	Settings for TOC Measurement	66
8.1.5	Concentration Curve Table	66
8.2	Set Points	67
8.3	ISM Setup (ISM Sensors only)	67
8.3.1	Sensor Monitor	68
8.3.2	CIP Cycle Limit	70
8.3.3	SIP Cycle Limit	71
8.3.4	AutoClave Cycle Limit	72
8.3.5	DLI Stress Adjustment	72
8.3.6	SAN Cycle Parameters	73
8.3.7	Reset Counters for UniCond2e Sensors	73
8.3.8	Set Calibration Interval for UniCond2e Sensors	74
8.4	General Alarm	74
8.5	ISM / Sensor Alarm	74
8.6	Display Setup	75
8.7	Digital Inputs	75
8.8	System	75
8.9	Service	76
8.9.1	Read Digital Inputs	76
8.9.2	Memory	76
8.9.3	Display	76
8.9.4	Calibrate TouchPad	76
8.9.5	Channel Diagnostic	77
8.10	Technical Service	77
8.11	User Management	77
8.12	Reset	78
8.12.1	System Reset	78
8.12.2	Reset Sensor Calibration for Optical DO Sensors	78
8.12.3	Reset Sensor Calibration for UniCond2e Sensors	78

8.13	RS485 Output	79
8.13.1	Printer Output Configuration	79
8.13.2	Data Log Configuration	80
8.14	USB Measurement Interface	80
9	ISM	81
9.1	iMonitor	81
9.2	Messages	82
9.3	ISM Diagnostics	82
9.3.1	pH/ORP, Oxygen, O ₃ and Cond4e Sensors	83
9.3.2	UniCond2e and UniCond4e Sensors	83
9.4	Calibration Data	84
9.4.1	Calibration Data for All ISM Sensors excluding UniCond2e and UniCond4e	84
9.4.2	Calibration Data for UniCond2e and UniCond4e Sensors	85
9.5	Sensor Info	85
9.6	HW / SW Version	86
9.7	Log Book	86
10	Wizards	87
10.1	Set Wizard	87
10.2	Access to Wizards	87
11	Maintenance	87
11.1	Front panel cleaning	87
12	Troubleshooting	88
12.1	pH Error messages/Warning- and Alarm list	88
12.1.1	pH sensors except dual membrane pH electrodes	88
12.1.2	ORP messages	89
12.2	Amperometric O ₂ Error messages/ Warning- and Alarm list	89
12.2.1	Low level oxygen sensors	89
12.3	Warning- and Alarm Indication	90
12.3.1	Warning Indication	90
12.3.2	Alarm Indication	91
13	Ordering Information	92
13.1	Transmitter Overview	92
13.2	Accessories and Spare Parts	92
14	Specifications	93
14.1	General specifications	93
14.2	Electrical specifications	94
14.3	Mechanical specifications	95
14.4	Environmental specifications	95
15	Warranty	96
16	Buffer tables	97
16.1	Standard pH buffers	97
16.1.1	Mettler-9	97
16.1.2	Mettler-10	98
16.1.3	NIST Technical Buffers	98
16.1.4	NIST standard buffers (DIN and JIS 19266: 2000-01)	99
16.1.5	Hach buffers	99
16.1.6	Ciba (94) buffers	100
16.1.7	Merck Titrisole, Riedel-de-Haën Fixanale	100
16.1.8	WTW buffers	101
16.1.9	JIS Z 8802 buffers	101
16.2	Dual membrane pH electrode buffers	102
16.2.1	Mettler-pH/pNa buffers (Na+ 3.9M)	102

1 Introduction

Statement of Intended Use – The M800 Water PROFINET and EtherNet/IP transmitters are online process instruments for measuring various properties of fluids and gases. These include conductivity, dissolved oxygen, dissolved ozone, total organic carbon and pH/ORP.

M800 Water PROFINET and EtherNet/IP parameter fit guide for 2- and 4-channel version

The transmitter is compatible with the following (digital) ISM and flow sensors.

Parameter	Water	
	2-channel	4-channel
pH/ORP	•	•
UniCond 2-e	•	•
Conductivity 4-e	•	•
Amp. Dissolved Oxygen ppm / ppb / trace	– / • / – ¹⁾	– / • / – ¹⁾
Amp. Oxygen gas ppm / ppb / trace	– / • / – ¹⁾	– / • / – ¹⁾
Optical Dissolved Oxygen	• ¹⁾	• ¹⁾
TOC	•	•
Dissolved Ozone	•	•
Flow	•	•

1) THORNTON sensors

A colored touch screen conveys measuring data and setup information. The menu structure allows the operator to modify all operational parameters by using the touch screen. A menu-lock-out feature, with password protection, is available to prevent the unauthorized use of the meter.

The M800 Water PROFINET and EtherNet/IP Multi-parameter transmitter is equipped with a USB communication interface. This interface provides up- and download capabilities of the transmitter configuration via a Personal Computer (PC).

This description corresponds to the firmware release, version 2.3. Changes are taking place constantly, without prior notification.

2 Safety instructions

This manual includes safety information with the following designations and formats.

2.1 Definition of equipment and documentation symbols and designations



WARNING: POTENTIAL FOR PERSONAL INJURY.



CAUTION: Possible instrument damage or malfunction.



NOTE: Important operating information.



On the transmitter or in this manual text indicates: Caution and/or other possible hazard including risk of electric shock (refer to accompanying documents).

The following is a list of general safety instructions and warnings. Failure to adhere to these instructions can result in damage to the equipment and/or personal injury to the operator.

- The M800 Water PROFINET and EtherNet/IP Transmitter should be installed and operated only by personnel familiar with the transmitter and who are qualified for such work.
- The M800 Water PROFINET and EtherNet/IP Transmitter must only be operated under the specified operating conditions (see chapter 14 “Specifications”).
- Repair of the M800 Water PROFINET and EtherNet/IP Transmitter must be performed by authorized, trained personnel only.
- With the exception of routine maintenance, cleaning procedures, as described in this manual, the M800 Water PROFINET and EtherNet/IP Transmitter must not be tampered with or altered in any manner.
- METTLER TOLEDO accepts no responsibility for damage caused by unauthorized modifications to the transmitter.
- Follow all warnings, cautions, and instructions indicated on and supplied with this product.
- Install equipment as specified in this instruction manual. Follow appropriate local and national codes.
- Protective covers must be in place at all times during normal operation.
- If this equipment is used in a manner not specified by the manufacturer, the protection provided by it against hazards may be void.



WARNINGS:

- Installation of cable connections and servicing of this product require access to shock hazard voltage levels.
- Switch or circuit breaker shall be in close proximity to the equipment and within easy reach of the OPERATOR; it shall be marked as the disconnecting device for the equipment.
- Main power must employ a switch or circuit breaker as the disconnecting device for the equipment.
- Electrical installation must be in accordance with the National Electrical Code and/or any other applicable national or local codes.



NOTE: PROCESS UPSETS

Because process and safety conditions may depend on consistent operation of this transmitter, provide appropriate means to maintain operation during sensor cleaning, replacement, or sensor or instrument calibration.

2.2 Correct disposal of the unit

When the transmitter is finally removed from service, observe all local environmental regulations for proper disposal.

3 Unit overview

The M800 Water PROFINET and EtherNet/IP models are available in 1/2 DIN case size in polycarbonate.

The M800 Water PROFINET and EtherNet/IP provide an integral IP66 housing for wall- or pipe mount.

3.1 Overview

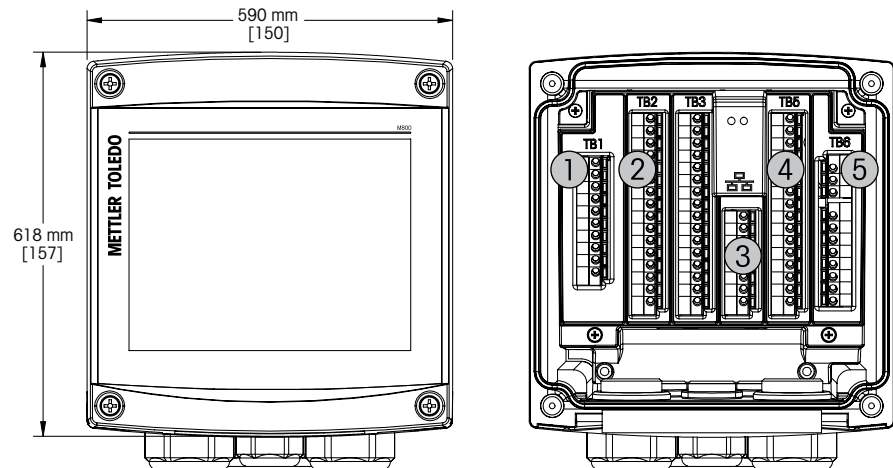

Fig. 1: Overview 2-channel version

- 1 Digital Input Terminal
- 2 Sensor Input Terminal
- 3 Ethernet Port
- 4 Digital Input Terminal
- 5 Power Supply Terminal

3.2 Display

3.2.1 Start Screen

After starting the M800 Water PROFINET and EtherNet/IP, the following Start Screen (logout screen) is shown automatically. To return from the Menu Screen to the Start Screen press . The M800 Water PROFINET and EtherNet/IP will return automatically after 240 seconds from the Menu Screen or any configuration screen to the Start Screen if the user has not pressed the touch screen.



3.2.2 Activation Menu Screen

While the M800 Water PROFINET and EtherNet/IP shows the Start Screen (logout screen) touch the display to activate the Menu Screen. To return to the Menu Screen from other menus press .



3.3 Graphic Trend Measurement

Any single measurement may be displayed as a trend measurement over time. Measurement values will be indicated by a value on the Y-axis and time elapsed on the X-axis of the graph displayed. An actual measurement for the selected value will also be displayed numerically above the graphic trend display. The measurement value is refreshed once per second.

Graphic trending will only display the data within maximum/minimum range. Out of range values or invalid values will not be displayed. The Y-axis will display the maximum value unit with its range; X-axis unit uses "mins" for minutes for measurements less than one hour and "hrs" for one day. 4 scales for X/Y-axis. The maximum value on Y-axis is one decimal place.

3.3.1 Activation Trend Display Screen

While the M800 Water PROFINET and EtherNet/IP displays the Menu Screen, touch any measurement value line of the display screen twice to activate the trend display for that measurement.

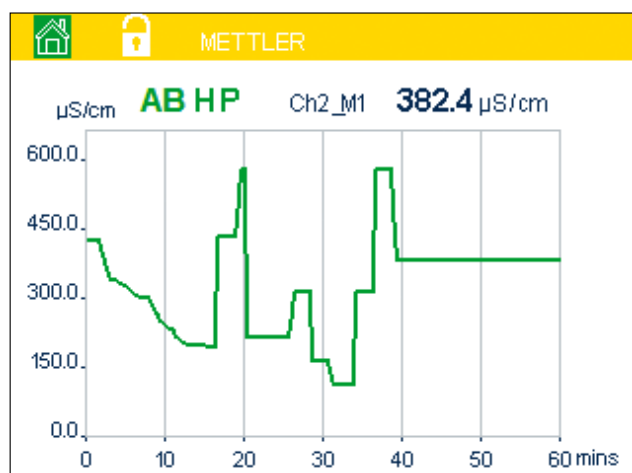

If a sensor is disconnected/connected a pop-up window come up; after closing the window, it will go back to the Menu Screen.

Red/yellow bar on top line will display for any message occurring during trending. 'H', 'P', 'AB' will display when this channel is in hold or process.

3.3.2 Settings for Trend Display Screen

For setting configurations, touch any area of the graphic trend display to go to the pop-up window of this measurement parameter. Settings are at the default values. However, these settings may be changed when options are available, as needed.

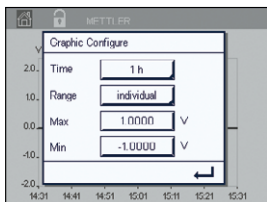

Time: Option button. For graphic display time (X-axis)

1-h (default value)

1-day

NOTE: 1 h means: 1 meas storage/15 seconds, totally 240 measurements for 1h. 1 day means: 1 meas storage/6 minutes, totally 240 measurements for 1 day;

Range: Option button

Default(default value)

Individual

When "Default" modes are set for the maximum or minimum value, this indicates the full measurement range for this unit. A Max or Min button is not displayed. If setting is selectable, the user can set maximum and minimum settings manually.

Max: Edit button.

Maximum value of this unit on Y-axis. xxxxxx, floating decimal point.

Min: Edit button.

Minimum value of this unit on Y-axis. xxxxxx, floating decimal point.

Max Value > Min Value

NOTE: Settings for Y-and Y-axis and the corresponding measurement values are stored the transmitters memory. A power down returns to default settings.



3.3.3 Deactivation Trend Display Screen

Press  in activated graphic trend screen to return to Menu Screen.



NOTE: If a sensor is disconnected/connected a pop-up window come up; after closing the window, it will go back to the Menu Screen.

3.4 Control/Navigation





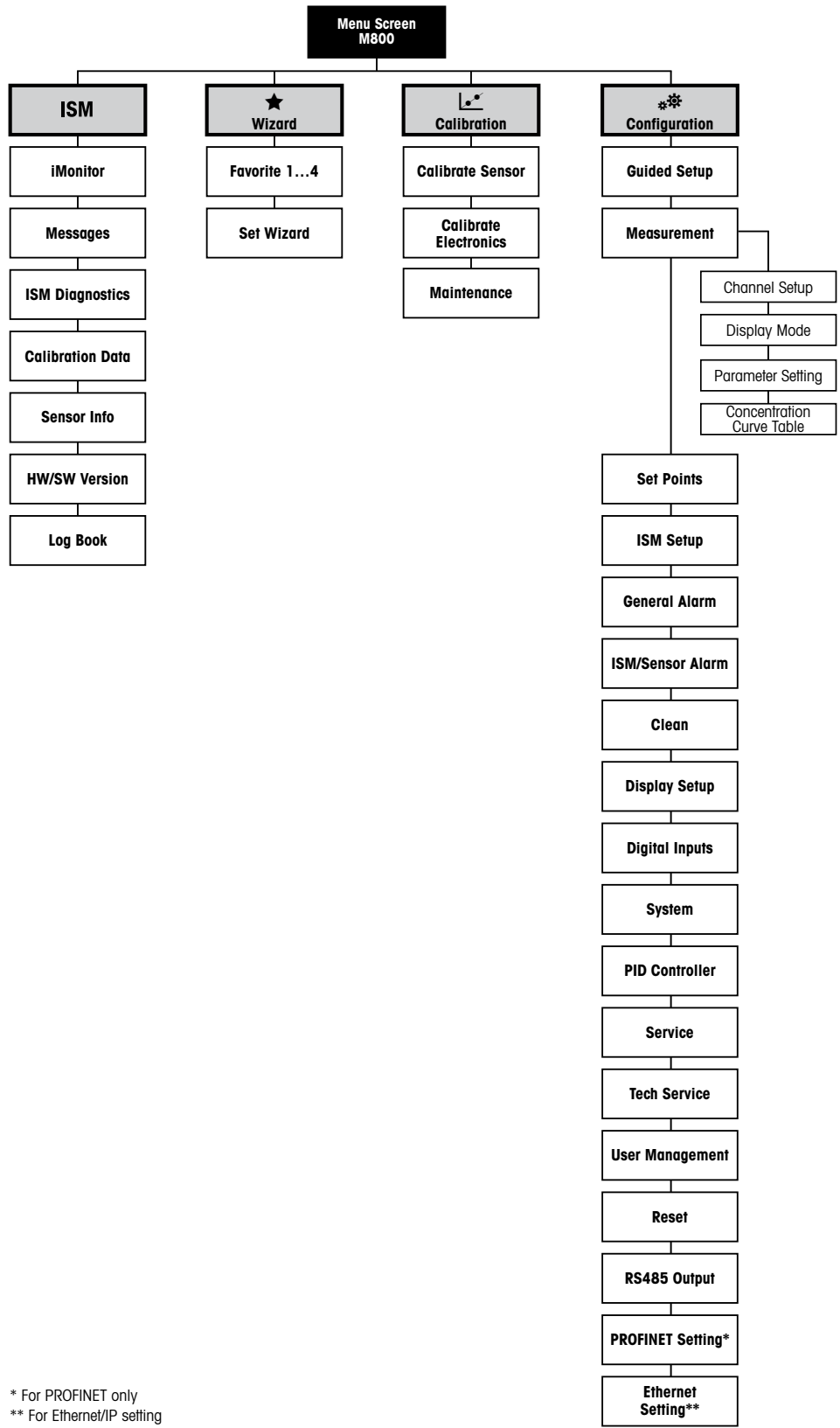





3.4.1 Menu Structure

M800 Water PROFINET and EtherNet/IP



* For PROFINET only
 ** For Ethernet/IP setting

3.4.2 Operating Elements

Operating element	Description
	Enter Menu screen
	Enter Start screen
ISM	Enter ISM menu
	Enter Favorite menu
	Enter Calibration menu
	Enter Configuration menu
	Return to Menu screen (see chapter 3.2.2 "Activation Menu Screen")
	Enter next-lower menu level, here e.g. iMonitor, Messages or ISM Diagnostics
	Return to next-higher menu level
	Change between pages within one menu level Change between the channels
	Confirm values and selected options. Press ESC and the changes are not stored.

3.4.3 Entry of Data

The M800 Water PROFINET and EtherNet/IP displays a keypad for modifying values. Press the  button and the transmitter will store the value. Press the ESC button to exit the keypad without changing data.



NOTE: For some values, the units can be modified. In this case the keypad shows a button with a U. To select another unit for the entered value on the keypad press the U button. To return again press the 0–9 button.



NOTE: For some entries letters and/or numbers can be used. In this case the keypad shows a button 'A,a,0'. Press this button to change between capital letters, small letters and numbers on the keypad.

3.4.4 Selection Menus

Some menus require a selection of a parameter / data. In this case the transmitter displays a pop up window. Press the according field to select the value. The pop-up window will be closed and the selection will be stored.

3.4.5 "Save changes" Dialog

If the M800 Water PROFINET and EtherNet/IP brings up the "Save changes" dialog there are the following options. No will discard the entered values, Yes will save changes made and Cancel will bring you back to continue configuring.

3.4.6 Security Passwords

The M800 Water PROFINET and EtherNet/IP Transmitter allows a security lock-out of various menus. If the security lock-out feature of the transmitter has been enabled, a security password must be entered to allow access to the menu. See chapter 8.1.1 "User Management".

3.4.7 Display



NOTE: In the event of an alarm or other error conditions the M800 Water PROFINET and EtherNet/IP Transmitter will display a flashing bar graph on the display. This bar graph will remain until the condition that caused it has been cleared (see chapter 12.3 "Warning- and Alarm Indication").



NOTE: During calibrations, clean, Digital In/USB in HOLD state, a flashing "H" (HOLD) will appear in the upper right corner of the display for the corresponding channel. This symbol will remain for 20 sec., after end of calibration. This symbol will remain for 20 seconds until after the calibration or clean is completed. This symbol will also disappear when Digital In is deactivated.

4 Installation instruction

4.1 Unpacking and inspection of equipment

Inspect the shipping container. If it is damaged, contact the shipper immediately for instructions. Do not discard the box.

If there is no apparent damage, unpack the container. Be sure all items shown on the packing list are present.

If items are missing, notify METTLER TOLEDO immediately.

4.2 Mounting

4.2.1 Dimensions

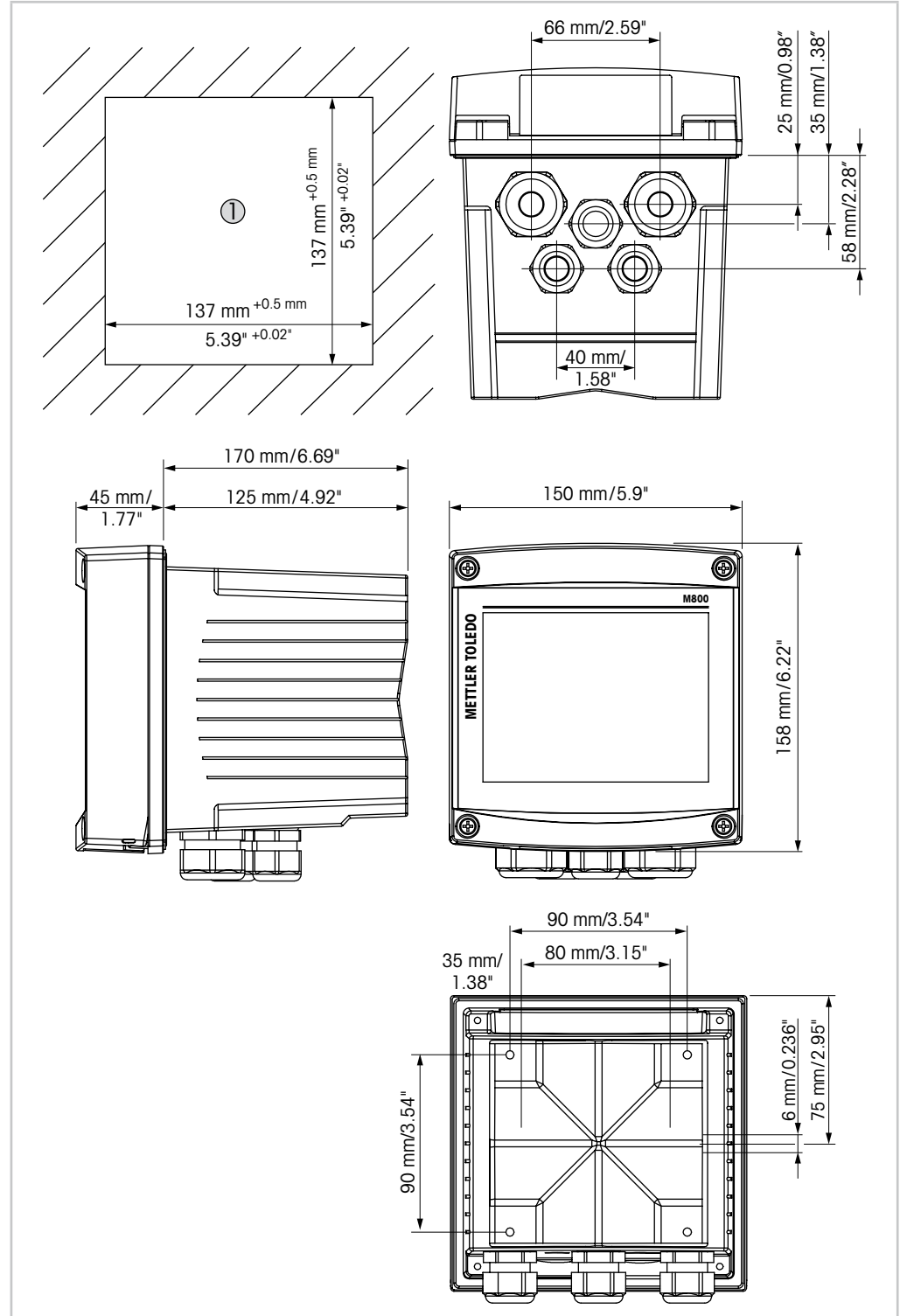

Fig. 2: Dimensions

1 Dimensions for panel cutout

4.2.2 Mounting Procedure

M800 Water PROFINET and EtherNet/IP transmitters are designed for the following mounting versions: panel mount, wall mount or pipe mount. For wall mount the integral rear cover is used.

Optional hardware accessories are available that allow for panel- or pipe-mount. Refer to section „13.2 Accessories and Spare Parts“.

Assembly

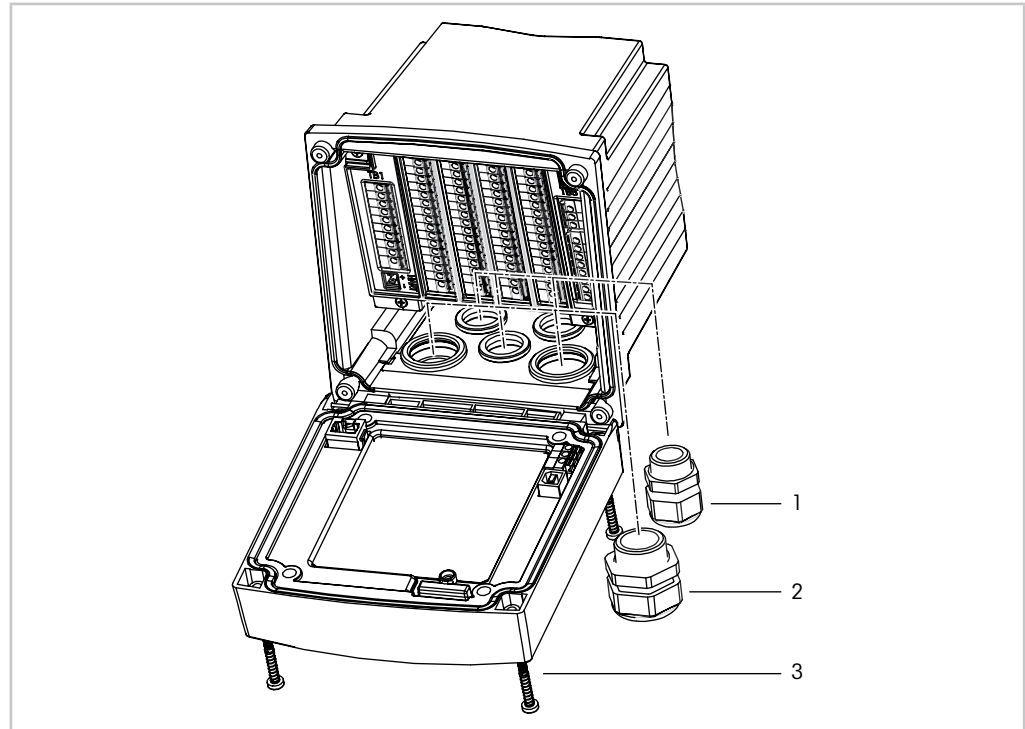

Fig. 3: Assembly

- 1 1 piece M25 x 1.5 cable gland
- 2 4 pieces M20 x 1.5 cable glands
- 3 4 pieces screws

General:

- Orient the transmitter so that the cable grips face downward.
- Wiring routed through the cable grips shall be suitable for use in wet locations.
- In order to provide IP66 enclosure ratings, all cable glands must be in place. Each cable gland must be filled using a UL rated cable marked "wet", "wet location" or "outdoor", measuring 0.36" (6.6 mm) or larger diameter, employed within the specified strain relief clamping range. Do not use metal conduit.
- Tighten the screws of the front panel with a tightening torque of 2 Nm.

4.2.3 Panel Mounting

To insure a good seal, the panel or door must be flat and have a smooth finish. Textured or rough surfaces are not recommended and may limit the effectiveness of the gasket seal provided.

1. Make cutout in panel. For dimensions refer to 4.2.1 "Dimensions".
 - Be sure surface surrounding cutout is clean, smooth and free of burrs.
2. Slide face gasket around transmitter from the back of the unit.
3. Place transmitter into cutout hole. Be sure there are no gaps between the transmitter and panel surface.
4. Place the two mounting brackets on either side of the transmitter as shown.
5. While holding transmitter firmly into the cutout hole, push the mounting brackets toward the backside of panel.
6. Once secure, use a screwdriver to tighten the brackets against the panel. In order to provide IP66 environmental enclosure rating, the two clamps provided shall be securely tightened to create an adequate seal between the panel enclosure and transmitter.
 - Face gasket will compress between transmitter and panel.

4.2.4 Wall Mounting



DANGER! Mortal danger by electric shock or risk of electrical shock: The maximum screw-in depth of the mounting holes in the housing is 12 mm (0.47 inch). Do not exceed maximum screw-in depth.

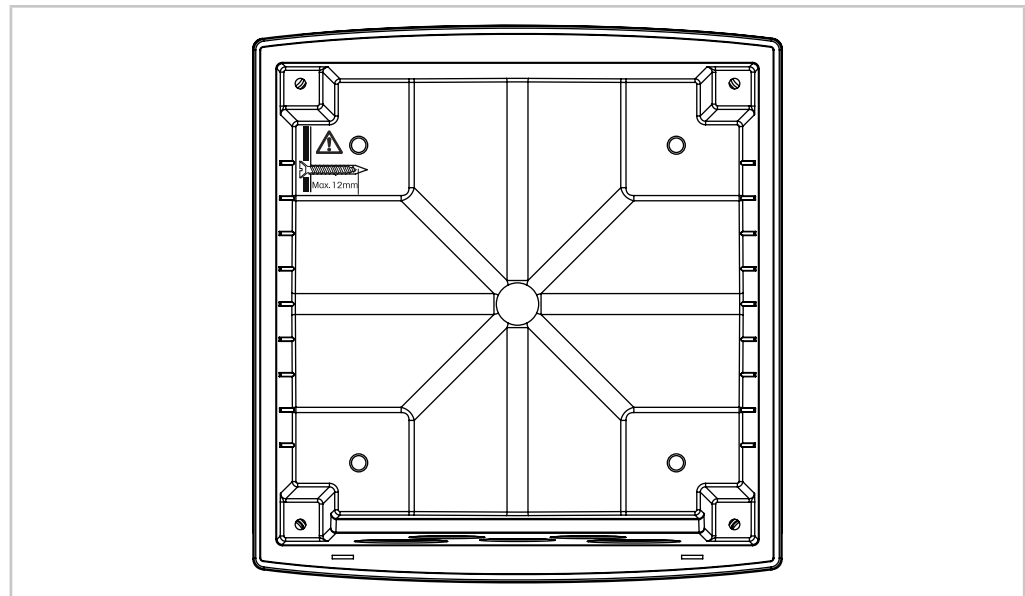

Fig. 4: Maximum screw-in depth

1. Mount wall mounting kit to the housing. Do not exceed maximum screw-in depth.
2. Mount wall mounting kit with the housing to the wall.
Attach to wall using appropriate mounting hardware for wall surface. Be sure it is level and securely fastened and the installation adheres to any and all clearance dimensions required for transmitter service and maintenance. Orient the transmitter so that the cable grips are facing downward.

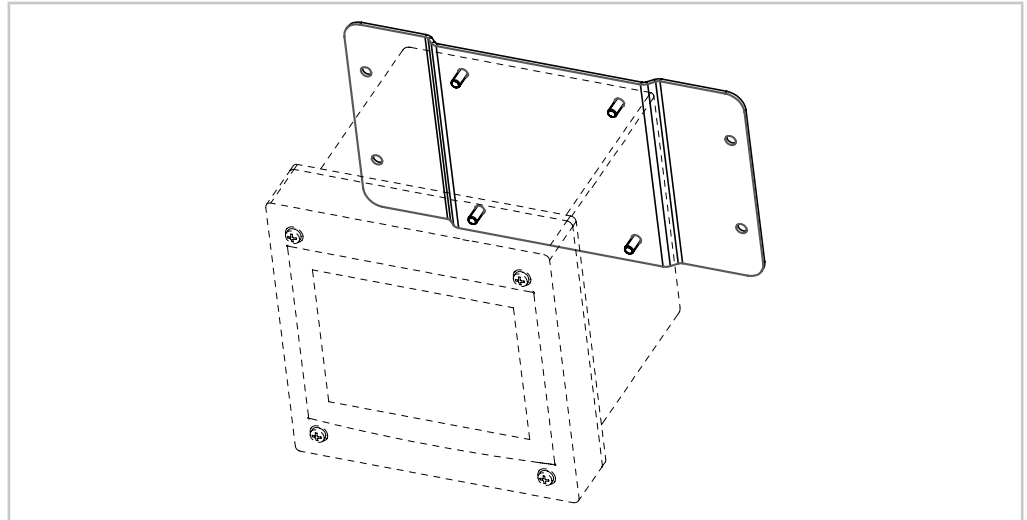

Fig. 5: Wall mounting with wall mounting kit

4.2.5 Pipe Mounting

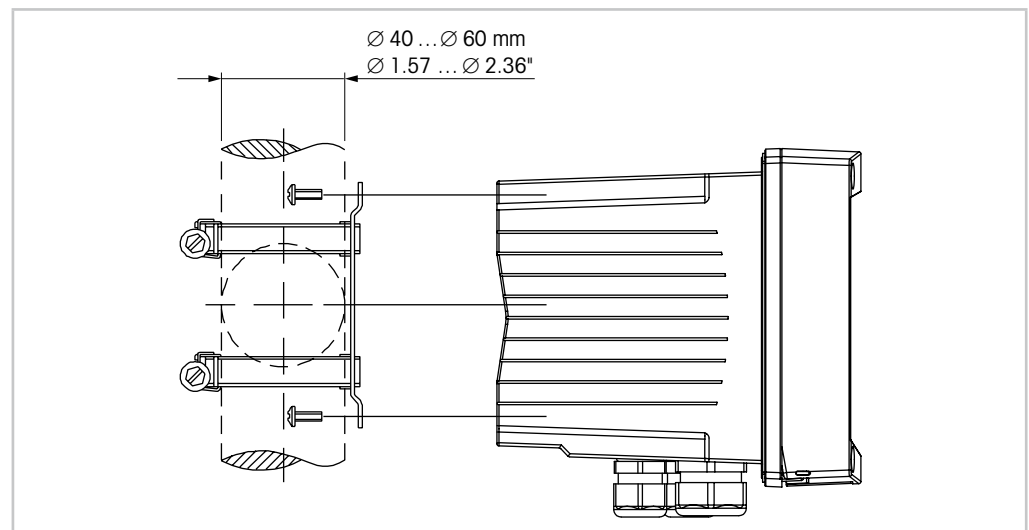

Fig. 6: Pipe mounting

- Use only manufacturer-supplied components for pipe-mounting the M800 Water PROFINET and EtherNet/IP transmitter. See section „13.2 Accessories and Spare Parts“ for ordering information.
- Tighten the fixing screws with a tightening torque of 2 to 3 Nm.

4.3 Electrical Connection



DANGER! Mortal danger by electric shock: Power off instrument during electrical connection.

The terminals are placed inside the housing.

All M800 Water PROFINET and EtherNet/IP transmitters are designed to operate from a 20 to 30 V DC or a 100 to 240 V AC power source. Refer to specifications for power requirements and ratings and size power wiring accordingly.

The terminals are suitable for single wires and flexible leads with a wire cross-section from 0.2 mm² up to 1.5 mm², (16–24 AWG).

1. Switch off supply voltage.
2. Connect mains supply as follows:
 - 20 to 30 V DC: N (–) for Neutral and L (+) for Line
2-channel or 4-channel versions to terminal TB6
 - 100 to 240 V AC: N for Neutral and L for Line
2-channel or 4-channel versions to terminal TB6.
3. Connect sensor, digital input signals according to chapter „4.4 Terminal Definition“.

4.4 Terminal Definition

4.4.1 M800 Water PROFINET and EtherNet/IP 2-Channel

Power connections: **N (-)** for Neutral and **L (+)** for Line for 20 to 30 VDC. **N** for Neutral and **L** for Line for 100 to 240 VAC.

Terminal number	TB1	TB2 (ISM Ch1,2)	TB3 (Flow Ch5,6)	TB4 (Bus board)	TB5 (ISM Ch3,4)	TB6
1	DI1+	DI2+	n. a.	n. a.	DI3+	L (+)
2	DI1-	DI2-	n. a.	n. a.	DI3-	N (-)
3	n. a.	1-Wire_Ch1	n. a.	n. a.	1-Wire_Ch3	Ground
4	n. a.	GND5V_Ch1	n. a.	n. a.	GND5V_Ch3	n. a.
5	n. a.	RS485B_Ch1	n. a.	n. a.	RS485B_Ch3	n. a.
6	n. a.	RS485A_Ch1	n. a.	Ground	RS485A_Ch3	n. a.
7	n. a.	GND5V_Ch1	n. a.	Ground	GND5V_Ch3	n. a.
8	n. a.	5V_Ch1	n. a.	Ground	5V_Ch3	n. a.
9	n. a.	24V_Ch2	Ain_Ch5	n. a.	n. a.	n. a.
10	n. a.	GND24V_Ch2	AJ_Ch5	n. a.	GND24V_Ch4	n. a.
11	n. a.	1-Wire_Ch2	5V_Ch5	n. a.	1-Wire_Ch4	n. a.
12	n. a.	GND5V_Ch2	GND5V_Ch5	n. a.	GND5V_Ch4	n. a.
13	n. a.	RS485B_Ch2	Bin_Ch6	n. a.	RS485B_Ch4	n. a.
14	n. a.	RS485A_Ch2	BJ_Ch6	n. a.	RS485A_Ch4	n. a.
15	n. a.	GND5V_Ch2	5V_Ch6	n. a.	GND5V_Ch4	n. a.
16	n. a.	5V_Ch2	GND5V_Ch6	n. a.	5V_Ch4	n. a.

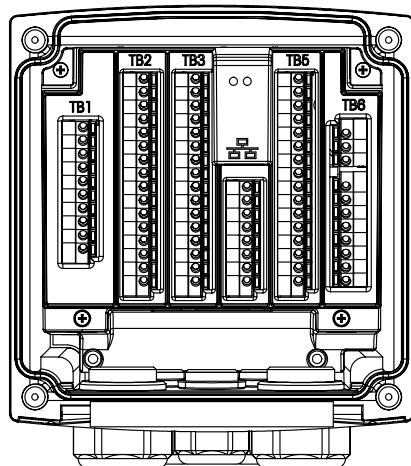

NO: normally open (contact open if un-actuated).
 NC: normally closed (contact closed if un-actuated).
 n.a. not available

4.4.2 M800 Water PROFINET and EtherNet/IP 2- and 4-Channel: TB2 – Terminal Assignment for Optical Oxygen, UniCond2e, UniCond4e and 6000TOCi ISM Sensors

	TB2 (ISM Ch1,2)	Optical Oxygen ¹⁾	UniCond2e ²⁾, UniCond4e ²⁾, 6000TOCi
Terminal	Function	5-pin cables wire color	Cables wire color
1	DI2+	–	–
2	DI2–	–	–
3	1-Wire_Ch1	–	–
4	GND5V_Ch1	–	–
5	RS485B_Ch1	–	black
6	RS485A_Ch1	–	red
7	GND5V_Ch1	–	white
8	5V_Ch1	–	blue
9	24V_Ch2	brown	–
10	GND24V_Ch2	black	–
11	1-Wire_Ch2	–	–
12	GND5V_Ch2	grey	–
13	RS485B_Ch2	blue	black
14	RS485A_Ch2	white	red
15	GND5V_Ch2	yellow	white
16	5V_Ch2	–	blue

1) One O₂ optical sensor can be connected to plug TB2.

2) Transparent wire not connected.

4.4.3 M800 Water PROFINET and EtherNet/IP 2- and 4-Channel: TB2 and TB5 – Terminal Assignment for pH, Amp. Oxygen, Cond 4e and O₃ ISM Sensors

	TB2 (TB5) ISM Ch1,2 (ISM Ch3,4)	pH, Amp. Oxygen, Cond 4e, CO₂ and O₃
Terminal	Function	Cables wire color
1	DI2+	–
2	DI2–	–
3	1-Wire_Ch1 (Ch3)	transparent (cable core)
4	GND5V_Ch1 (Ch3)	red
5	RS485B_Ch1 (Ch3)	–
6	RS485A_Ch1 (Ch3)	–
7	GND5V_Ch1 (Ch3)	–
8	5V_Ch1 (Ch3)	–
9	24V (*TB2 only)	–
10	GND24V	–
11	1-Wire_Ch2 (Ch4)	transparent (cable core)
12	GND5V_Ch2 (Ch4)	red
13	RS485B_Ch2 (Ch4)	–
14	RS485A_Ch2 (Ch4)	–
15	GND5V_Ch2 (Ch4)	–
16	5V_Ch2 (Ch4)	–

4.4.4 M800 Water PROFINET and EtherNet/IP 2- and 4-Channel: TB3 – Terminal Assignment for Flow Sensors

	TB3	Flow hi, Flow lo, Flow Type2
Terminal	Transmitter	Function
1	n. a.	–
2	n. a.	–
3	n. a.	–
4	n. a.	–
5	n. a.	–
6	n. a.	–
7	n. a.	–
8	n. a.	–
9	Ain_Ch3 / Ain_Ch5	Flow Pulse Input
10	AJ_Ch3 / AJ_Ch5	+ 10 VDC
11	5V_Ch3 / 5V_Ch5	+ 5 VDC
12	GND5V_Ch3 / GND5V_Ch5	Ground
13	Ain_Ch4 / Ain_Ch6	Flow Pulse Input
14	AJ_Ch4 / AJ_Ch6	+ 10 VDC
15	5V_Ch4 / 5V_Ch6	+ 5 VDC
16	GND5V_Ch4 / GND5V_Ch6	Ground

4.4.5 Connecting the Cable



NOTE: The sensor, fieldbus and EtherNet cables must be shielded.

4.4.5.1 Connect the M12 Cable

1. Take out the EtherNet cable. Spare part number: 30530035.



2. Route the cable in the housing (through the M20) as per the wiring diagram.

3. Tighten the M12 (1) connector.



4. Attach the RJ45 connector (1) to the socket (2).

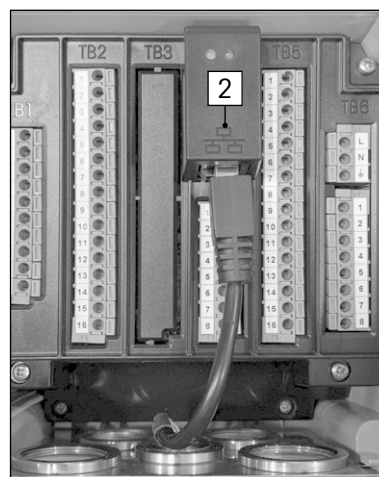
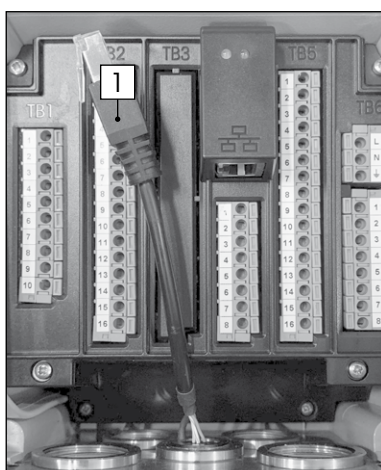

4.4.5.2 Connect RJ45 Cable

1. Release a suitable cable length.
2. Route the cable in the housing through M25 hole.
3. Insert the RJ45 connector to the socket.

4.5 Connection of Flow Sensor

The M800 Transmitter is designed to operate with various types of sensors. These sensors require different wiring configurations. Listed below are instructions for wiring the various types of sensors offered by METTLER TOLEDO Thornton for use with this transmitter. Please consult the factory for assistance if attempting to wire sensors not offered by METTLER TOLEDO Thornton as some sensors may not be compatible.

4.5.1 Flow Sensor Input Wiring Kit

This kit contains components that may be needed at input terminals to condition sensor signals. Refer to the following sections or to the instruction manual for wiring details.

4.5.2 Kit Contents

This kit contains the following items:

- 4x Wire nuts
- 4x 10K ohm resistors for use with Burket 8020 and 8030 type sensors, and GF Signet 2500-series sensors.
- 4x 1K ohm resistors for use with Data Industrial 200-series and Fluidyne insertion type sensors.
- 4x 0.33uF, 50 V capacitors for use with Berket 8020 and 8030 type sensors, Data Industrial 200-series and 4000-series sensors, GF Signet 2500-series sensors, Sanitary Turbine-Type sensors, Fluidyne insertion type sensors and Racine Federated (Formerly Asahi/America) vortex-style sensors.

4.5.3 Flow sensor wiring for Compatible Sensors

The following sections provide wiring information to properly connect various compatible flow sensors to the M800 Transmitter. When using the Configuration menu of the transmitter to setup the flow sensor, the first prompt asks to select the TYPE of flow sensor being connected.

There are three choices as follows:

- High: All flow sensors described in Section 4.4.4
- Low: P515 Signet flow sensors only, described in section 4.4.5
- Type 2: Asahi flow sensors, described in Section 4.4.6

4.5.4 Wiring for "HIGH" type flow sensors

The following wiring information is used when connecting (Burkert 8020 and 8030 type) inline Hall effect 5VDC, flow sensors. **THORNTON models 33901 thru 33935.**

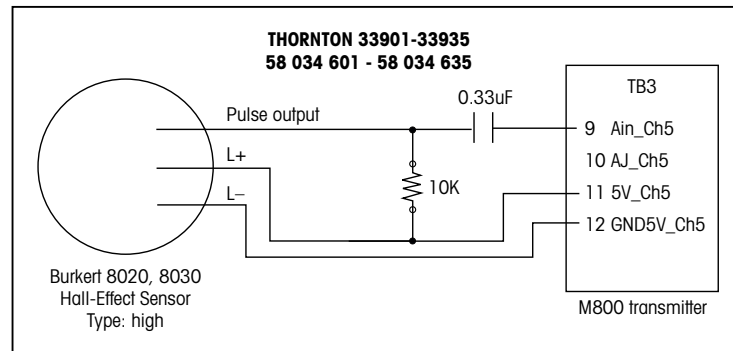

Extension cable not provided. Use 2-conductor twisted pair with shield, 22 AWG (Belden 8451 or equivalent), 1,000 ft (305 m) maximum length.

The following wiring information is used when connecting Badger (formerly Data Industrial 200-Series) forward-swept paddlewheel type flow sensors.

THORNTON models 33142 thru 33145 and 33159 thru 33162 and 33273.

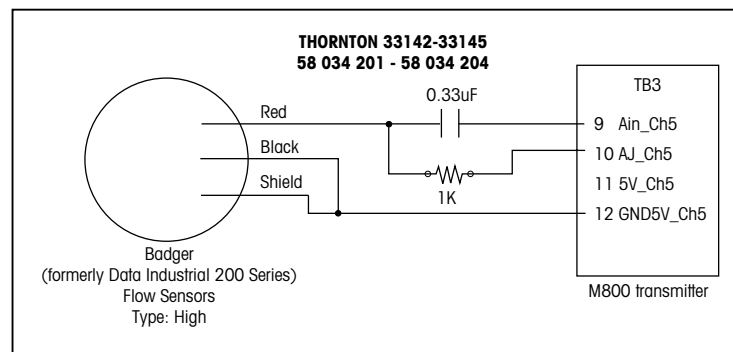

Extension cable provided with sensor. Use 2-conductor twisted pair with shield 20 AWG (Belden 9320 or equivalent) to extend length to 2000 ft (610 m) max.

The following wiring information is used when connecting Badger (formerly Data Industrial 4000-Series) forward-swept paddlewheel type flow sensors.

THORNTON models 33174 thru 33177 and 33171 and 33172.

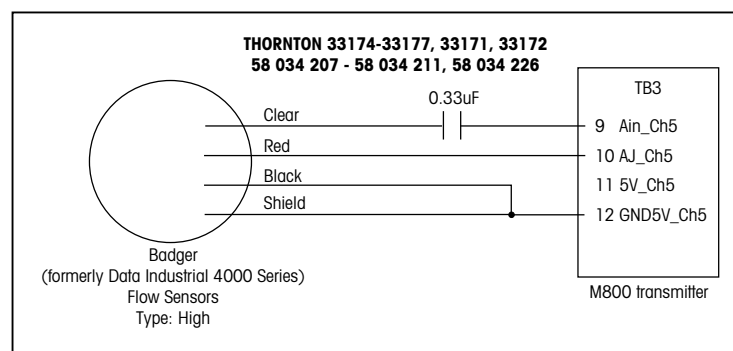

20 ft (6.1 m) extension cable provided with sensor. Use 3-conductor with shield, 20 AWG (Belden 9364 or equivalent) to extend length to 2000 ft (610 m) maximum.

The following wiring information is used when connecting (GF Signet 2500-Series) Hall Effect paddlewheel type flow sensors. **THORNTON models 33282, 33285, 33287, 33298 thru 33305.**

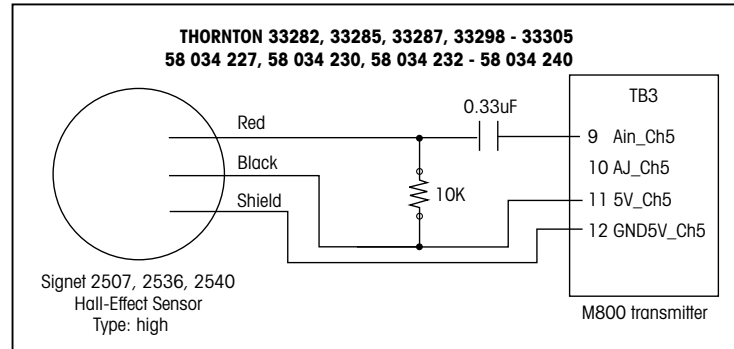

25 ft (7.6 m) extension cable provided with sensor. Use 2-conductor with shield, 22 AWG (Belden 8451 or equivalent) to extend length to 1000 ft (305 m) maximum.

The following wiring information is used when connecting Sanitary Turbine type flow sensors. **THORNTON models 33336 thru 33377 (Hoffer) and 33441 thru 33450 (Sponsler).**

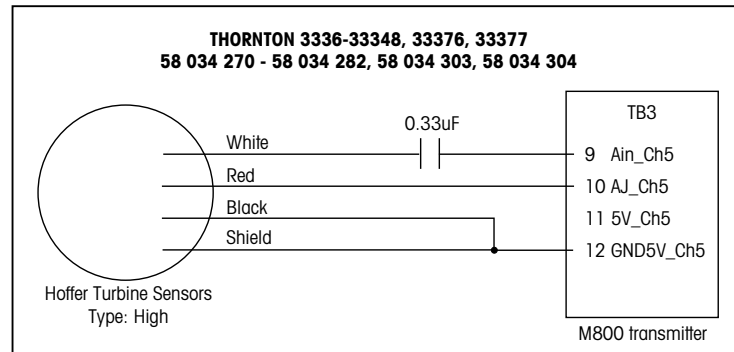

20 ft (6.1 m) extension cable provided with sensor. Use 3-conductor with shield, 20 AWG (Belden 9364 or equivalent) to extend length to 3000 ft (915 m) maximum.

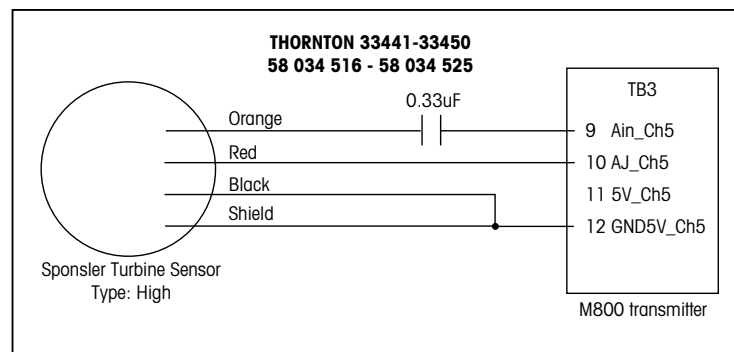

20 ft (6.1 m) extension cable provided with sensor. Use 3-conductor with shield, 20 AWG (Belden 9364 or equivalent) to extend length to 3000 ft (915 m) maximum.

The following wiring information is used when connecting Spirax Sarco/Emco flow (formerly Fluidyne) insertion type flow sensors. **THORNTON models 33358 thru 33375.**

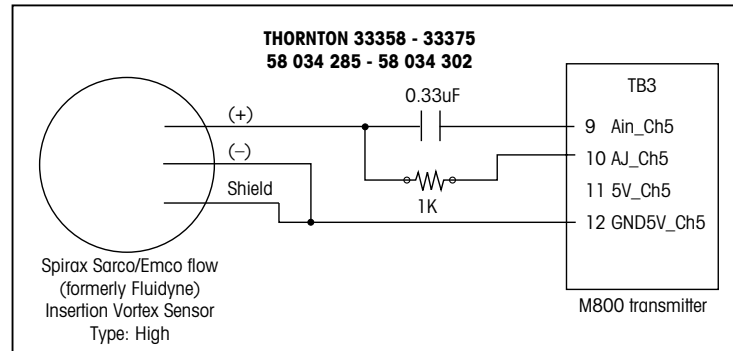

Extension cable not provided. Use 2-conductor twisted pair with shield, 20 AWG (Belden 9320 or equivalent), 2000 ft (610 m) maximum length.

4.5.5 Wiring for "LOW" type flow sensors

The following wiring information is used when connecting (GF Signet 515) type flow sensors. **THORNTON models 33189, 33193, 33195, 33196, and 33229.**

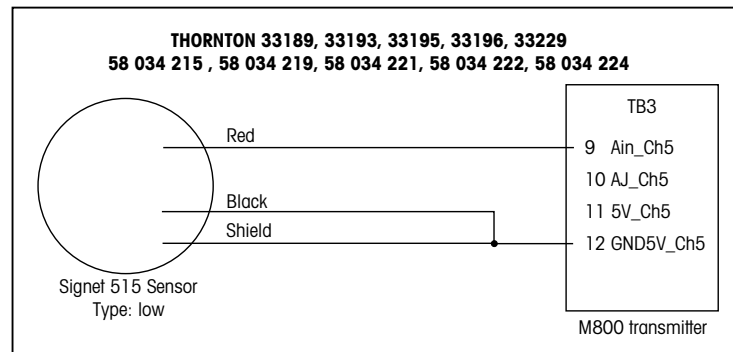

Extension cable not provided. Use 2-conductor twisted pair with shield, 22 AWG (Belden 8451 or equivalent), 200 ft (61 m) maximum length.

4.5.6 Wiring for "TYPE 2" flow sensors

The following wiring information is used when connecting Racine Federated (formerly Asahi/America) vortex flow sensors. **THORNTON models 33308 to 33335.**

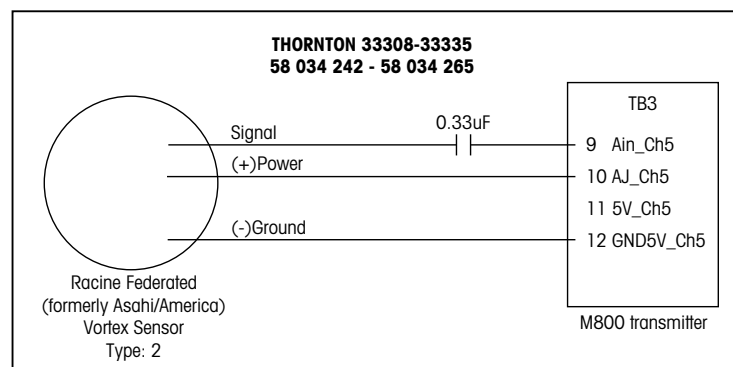

Extension cable not provided. Use 3-conductor with shield, 20 AWG (Belden 9364 or equivalent), 1000 ft (305 m) maximum length.

5 Placing transmitter in, or out, of service

5.1 Placing transmitter in service



After connecting the transmitter to power supply circuit, it will be active as soon as the circuit is powered.

5.2 Placing transmitter out of service

First disconnect the unit from the main power source, then disconnect all remaining electrical connections. Remove the unit from the panel. Use the installations instruction in this manual as reference for dis-assembling mounting hardware.

All transmitter settings stored in memory are non volatile.

6 Guided Setup

PATH:  \ CONFIG \ Guided Setup



NOTE: Please do not use Guided Setup menu after configuration of the transmitter, because some of the settings will be set to default values again.

See the following explanation to get more details about the different settings for the guided setup.



Select the desired **Channel** for the guided setup and in the same line the parameter.

If Auto is selected, M800 Transmitter automatically recognizes the type of sensor. The channel can also be fixed to a certain measurement parameter, depending on the type of transmitter. For detailed information refer to chapter 8.1.1 "Channel Setup".

Press the corresponding button to measurement **M1** to configure the measurement. For detailed information about the configuration options refer to chapter 8.1.1 "Channel Setup".



Assigning the corresponding **Set Point'X'** to the measurement by pressing Yes. For detailed information about the configuration of the set point refer to chapter 8.2 "Set Points".



Select the **Type** for the setpoint.

The type of the setpoint can be High, Low, Between, Outside or Off. An "Outside" setpoint will cause an alarm condition whenever the measurement goes above its high limit or below its low limit. A "Between" setpoint will cause an alarm condition to occur whenever the measurement is between its high and low limits.



NOTE: If the type of set point is not Off additional settings can be done. See the following description.

According to the selected type of set point, value(s) according to the limit(s) can be entered.

To escape the menu of the settings for Guided Setup press . To return to the Menu Screen (see chapter 3.2 "Display") press . The M800 Water PROFINET and EtherNet/IP will bring up the Save Changes dialog.

7 Calibration

For the menu structure refer to chapter 3.4.1 “Menu Structure”.

PATH:  \ Cal



NOTE: During calibration, the outputs for the corresponding channel will default to be held at their current values until 20 seconds after the calibration menu is exited. A flashing H appears in the upper right corner of the display while outputs are held. Refer to chapter 8.2 “Set Points” to change the HOLD output status.



NOTE: ISM sensors: “Adjust” detects deviations and readjusts the sensor. Calibration is performed and calculated values are stored in the sensor. “Calibrate” detects deviations and does not readjust the sensor. Calibration is not performed, but calculated values are stored in the sensor.

7.1 Sensor Calibration

PATH:  \ Cal \ Calibrate Sensor

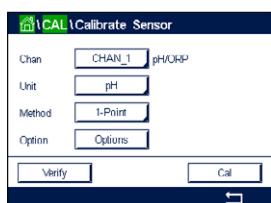

Select the desired channel (**Chan**) for calibration.

See the following explanation to get more details about the calibration options and procedure.

7.2 Calibration of UniCond2e and UniCond4e Sensors (ISM Sensors only)

The M800 Water PROFINET and EtherNet/IP transmitters provide the ability to perform a one-point, two-point or process conductivity or resistivity calibration for 2e-sensors and 4e-sensors.



NOTE: When performing calibration on a conductivity sensor, results will vary depending on the method, calibration apparatus and/or quality of reference standards used to perform the calibration.



NOTE: For measuring tasks the temperature compensation for the application as defined through the parameter settings for conductivity will be considered and not the temperature compensation selected through the calibration procedure (see also chapter 8.1.4.1 “Conductivity Settings”; PATH:  \ CONFIG \ Meas \ Parameter Setting).

Enter the menu Calibrate Sensor (see chapter 7.1 "Sensor Calibration"; PATH:  \ Cal \ Calibrate Sensor) and choose the desired channel for calibration.

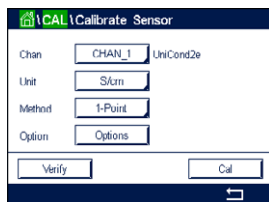

The following menus can be called up:

Unit: Choose between the units for conductivity (S/cm) and resistivity (Ω -cm).

Method: Select the desired calibration procedure. Available are 1-point, 2-point or process calibration.

Options: The desired compensation mode for the calibration process can be selected.

Choices are "None", "Standard", "Light 84", "Std 75 °C", "Linear 25°C", "Linear 20°C", "Glycol.5", "Glycol1", "Cation", "Alcohol" and "Ammonia".

None does not make any compensation of the measured conductivity value. The uncompensated value will be displayed and proceeded.

Standard compensation includes compensation for non-linear high purity effects as well as conventional neutral salt impurities and conforms to ASTM standards D1125 and D5391.

Light 84 compensation matches the high purity water research results of Dr. T.S. Light published in 1984. Use only if your institution has standardized on that work.

Std 75 °C compensation is the Standard compensation algorithm referenced to 75 °C. This compensation may be preferred when measuring Ultrapure Water at an elevated temperature (Resistivity of ultrapure water compensated to 75 °C is 2.4818 Mohm-cm.)

Linear 25 °C compensation adjusts the reading by a coefficient or factor expressed as %/°C (deviation from 25 °C). Use only if the solution has a well-characterized linear temperature coefficient. The factory default setting is 2.0%/°C. (2.4818 Mohm-cm.)

Linear 20 °C compensation adjusts the reading by a coefficient or factor expressed as %/°C (deviation from 20 °C). Use only if the solution has a well-characterized linear temperature coefficient. The factory default setting is 2.0%/°C.

Glycol.5 compensation matches the temperature characteristics of 50% ethylene glycol in water. Compensated measurements using this solution may go above 18 Mohm-cm.

Glycol1 compensation matches the temperature characteristics of 100% ethylene glycol. Compensated measurements may go well above 18 Mohm-cm.

Cation compensation is used in power industry applications measuring the sample after a cation exchanger. It takes into account the effects of temperature on the dissociation of pure water in the presence of acids.

Alcohol compensation provides for the temperature characteristics of a 75% solution of isopropyl alcohol in pure water. Compensated measurements using this solution may go above 18 Mohm-cm.

Ammonia compensation is used in power industry applications for specific conductivity measured on samples using ammonia and/or ETA (ethanolamine) water treatment. It takes into account the effects of temperature on the dissociation of pure water in the presence of these bases.



NOTE: If compensation mode "Linear 25 °C" or "Linear 20 °C" has been chosen, the coefficient for the adjustment of the reading can be modified. In this case an additional input field will be displayed.

The changes are valid until the calibration mode has been escaped. After the values defined in the configuration menu are valid again.

7.2.1 One-Point Calibration

Select calibration procedure 1-Point (see chapter "Conductivity Calibration of UniCond2e and UniCond4e Sensors"). With 2e-sensors or 4e-sensors a one-point calibration is always performed as a slope calibration. The following procedure shows the calibration with a 2e-sensor. The calibration with a 4e-sensor works respectively.

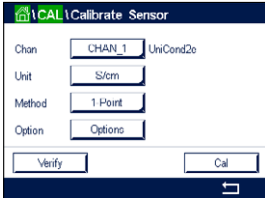

Press the button Cal for starting calibration.

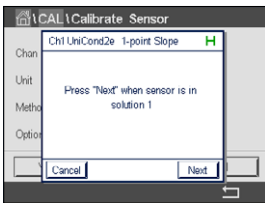

Place the electrode in the reference solution and press Next button.

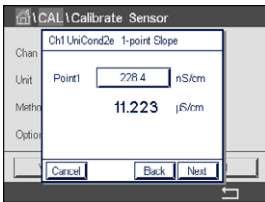

The second value displayed on the screen is the value being measured by the transmitter and sensor in units selected by the user.

Press the input field for **Point1** to enter the value for the calibration point. The M800 displays a keypad for modifying the value. Press the \leftarrow button and the transmitter will take over the value.



NOTE: To select another unit for the entered value on the keypad press the U button. To return again press the 0-9 button.

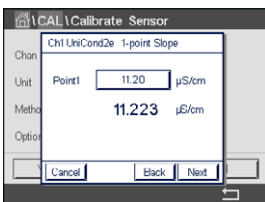

The screen shows the entered value for the reference solution (1st line) and the measured value of the M800 (2nd line).

Press the Next button to start the calculation of the calibration results.

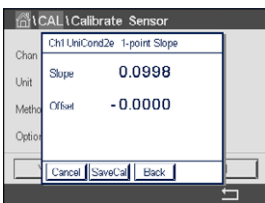

The display shows the value for the slope and the offset as the result of the calibration.

The calibration values are stored in the calibration history and taken over (press button SaveCal) or discarded (press button Cancel).

Use the Back button to go one step back in the calibration procedure.

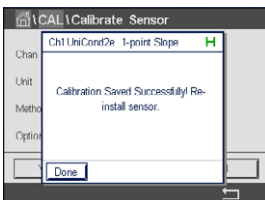

If "SaveCal" is chosen, the message "Calibration Saved Successfully!" is displayed. In either case you will see the message "Please re-install sensor". After pressing the Done button the M800 returns to the calibration menu for the sensor.

7.2.2 Two-Point Calibration

Select calibration procedure 2-Point. With 4e-sensors a two-point calibration is always performed as an offset and slope calibration. The following procedure shows the calibration with a 4e-sensor.

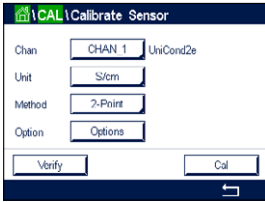

Press the button Cal for starting calibration.



Place the electrode in the first reference solution and press Next button.

CAUTION: Rinse sensors with a high-purity water solution between calibration points to prevent contamination of the reference solutions.

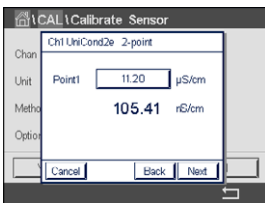

The second value displayed on the screen is the value being measured by the transmitter and sensor in the units selected by the user.

Press the input field for **Point1** to enter the calibration point. The M800 displays a keypad for modifying the value. Press the \leftarrow button to accept the value.



NOTE: To select another unit for the entered value on the keypad press the U button. To return again press the 0-9 button.

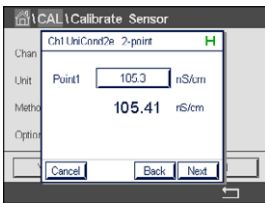

The screen shows the entered value for the first reference solution (1st line) and the measured value of the M800 (2nd line).

Press the Next button to go on with the calibration.

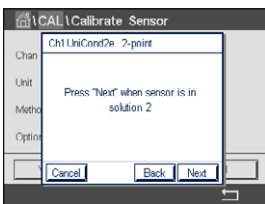

Place the electrode in the second reference solution and press Next button.

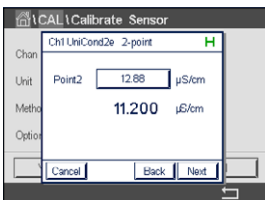

The second value displayed on the screen is the value being measured by the transmitter and sensor in the units selected by the user.

Press the input field for **Point2** to enter the calibration point. The M800 displays a keypad for modifying the value. Press the \leftarrow button to accept the value.



NOTE: To select another unit for the entered value on the keypad press the U button. To return again press the 0-9 button.

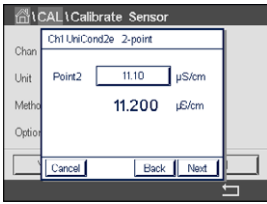

The screen shows the entered value for the second reference solution (1st line) and the measured value of the M800 (2nd line).

Press the Next button to start the calculation of the calibration results.

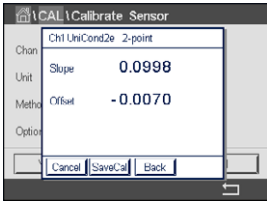

The display shows the value for the slope and the offset as the result of the calibration.

The calibration values are stored in the calibration history. To save (press button SaveCal) or to discard (press button Cancel).

Use the Back button to go one step back in the calibration procedure.

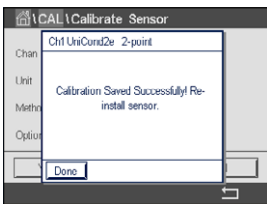

If "SaveCal" is chosen, the message "Calibration Saved Successfully!" is displayed. In either case you will see the message "Please re-install sensor". After pressing the Done button the M800 returns to the calibration menu for the sensor.

7.2.3 Process Calibration

Select calibration procedure Process (see chapter "Conductivity Calibration of UniCond2e and UniCond4e Sensors"). With 2e-sensors or 4e-sensors a process calibration is always performed as a slope calibration. The following procedure shows the calibration with a 2e-sensor. The calibration with a 4e-sensor works respectively.

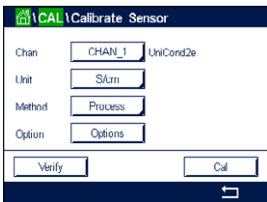

Press the button Cal for starting calibration.

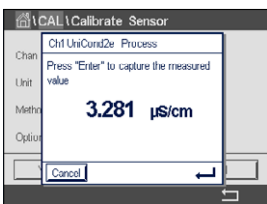

Take a sample and press the \leftarrow button to store the current measuring value. To show the ongoing calibration process, P is blinking in the Start and Menu screen if the related channel is selected in the display.



After determining the conductivity value of the sample, press the calibration icon in the Menu Screen (see chapter 3.4.2 "Operating Elements") again.

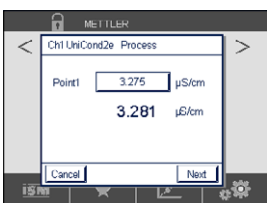

Press the input field for **Point1** and enter the conductivity value of the sample. Press the Next button to start the calculation of the calibration results.

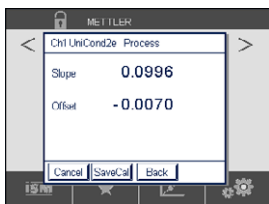

The display shows the value for the slope and the offset as the result of the calibration.

The calibration values are stored in the calibration history. To save (press button SaveCal) or to discard (press button Cancel).

Use the Back button to go one step back in the calibration procedure.

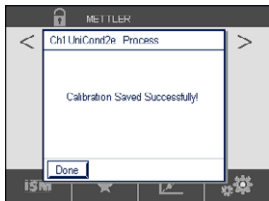

If "SaveCal" is chosen, the message "Calibration Saved Successfully!" is displayed. After pressing the Done button the M800 returns to the Menu Screen.

7.2.4 Temperature Calibration of UniCond2e Sensors and UniCond4e Sensors

The M800 provides the ability to perform a one-point or two-point calibration for the temperature sensor of the UniCond2e and UniCond4e.

Enter the menu Calibrate Sensor (see chapter 7.1 "Sensor Calibration"; PATH: \ Cal \ Calibrate Sensor) and choose the desired channel for calibration.

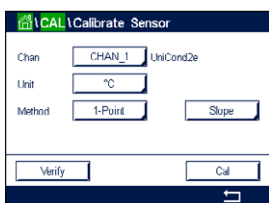

The following menus can be called up:

Unit: Choose between the units °C and °F.

Method: Select the desired calibration procedure. Available are 1-point and 2-point calibration.

7.2.4.1 One-Point Calibration

Select calibration procedure 1-Point. With 2e-sensors or 4e-sensors a one-point temperature calibration can be performed as a slope or offset calibration. The following procedure shows the calibration with a 2e-sensor. The calibration with a 4e-sensor works respectively.

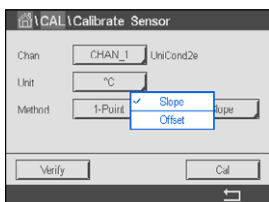

Press the right input field for the parameter **Method**. Choose Slope or Offset calibration through pressing the corresponding field.

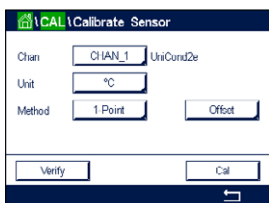

Press the button Cal for starting calibration.

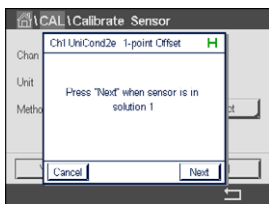

Place the electrode in the reference solution and press Next button.

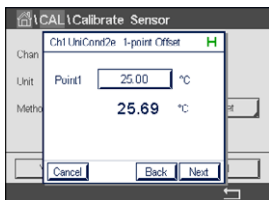

The second value displayed on the screen is the value being measured by the transmitter and sensor.

Press the input field for **Point1** to enter the value for the calibration point. The M800 displays a keypad for modifying the value. Press the \leftarrow button to accept the value.

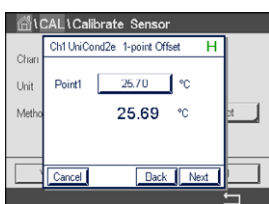

The screen shows the entered value for the reference solution (1st line) and the measured value of the M800 (2nd line).

Press the Next button to start the calculation of the calibration results.

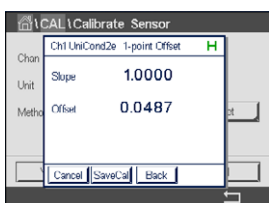

The display shows the value for the slope and the offset as the result of the calibration.

The calibration values are stored in the calibration history. To save (press button SaveCal) or to discard (press button Cancel).

Use the Back button to go one step back in the calibration procedure.

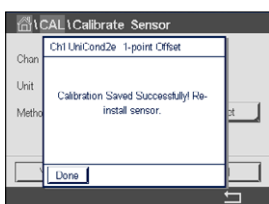

If "SaveCal" is chosen, the message "Calibration Saved Successfully!" is displayed. In either case you will see the message "Please re-install sensor". After pressing the Done button the M800 returns to the calibration menu for the sensor.

7.2.4.2 Two-Point Calibration

Select calibration procedure 2-Point (see chapter 7.2.4 "Temperature Calibration of UniCond2e Sensors and UniCond4e Sensors"). With 2e-sensors or 4e-sensor a two-point calibration is always performed as an offset and slope calibration. The following procedure shows the calibration with a 2e-sensor. The calibration with a 4e-sensor works respectively.

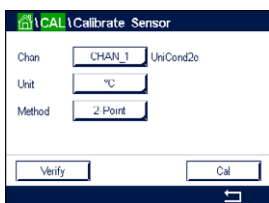

Press the button Cal for starting calibration.

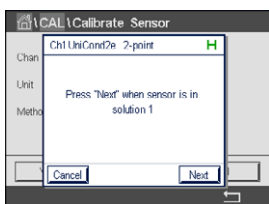

Place the electrode in the first reference solution and press Next button.

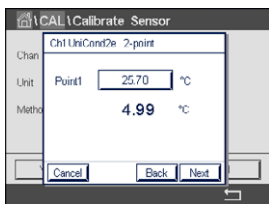

The second value displayed on the screen is the value being measured by the transmitter and sensor in the units selected by the user.

Press the input field for **Point1** to enter the calibration point. The M800 displays a keypad for modifying the value. Press the \leftarrow button and to accept the value.

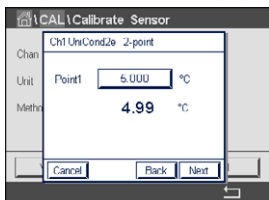

The screen shows the entered value for the first reference solution (1st line) and the measured value of the M800 (2nd line).

Press the Next button to go on with the calibration.

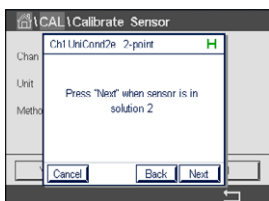

Place the electrode in the second reference solution and press Next button.

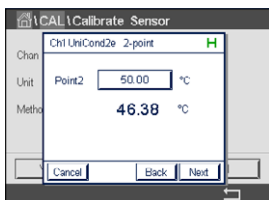

The second value displayed on the screen is the value being measured by the transmitter and sensor in the units selected by the user.

Press the input field for **Point2** to enter the calibration point. The M800 displays a keypad for modifying the value. Press the \leftarrow button and to accept the value.

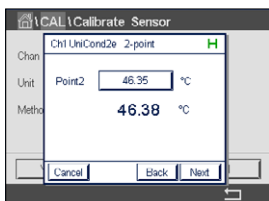

The screen shows the entered value for the second reference solution (1st line) and the measured value of the M800 (2nd line).

Press the Next button to start the calculation of the calibration results.

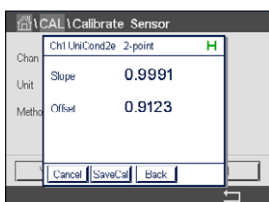

The display shows the value for the slope and the offset as the result of the calibration.

The calibration values are stored in the calibration history. To save (press button SaveCal) or to discard (press button Cancel).

Use the Back button to go one step back in the calibration procedure.

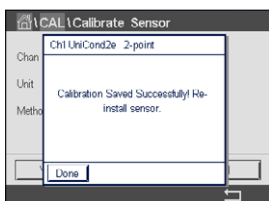

If "SaveCal" is chosen, the message "Calibration Saved Successfully!" is displayed. In either case you will see the message "Please re-install sensor". After pressing the Done button the M800 returns to the calibration menu for the sensor.

7.3 pH Calibration

PATH:  \ Cal \ Calibrate Sensor

For pH sensors, the M800 Transmitter features one-point, two-point or process calibration with 9 preset buffer sets or manual buffer entry. Buffer values refer to 25 °C. To calibrate the instrument with automatic buffer recognition, you need a standard pH buffer solution that matches one of these values. Please select the correct buffer table before using automatic calibration (see chapter 16 "Buffer tables"). The stability of the sensor signal during calibration can be checked by the user or automatically by the transmitter (see chapter 8.1.4.2 "pH Settings").



NOTE: For dual membrane pH electrodes (pH/pNa) only buffer Na+ 3.9M (see chapter 16.2.1 "Mettler-pH/pNa buffers (Na+ 3.9M)") is available.

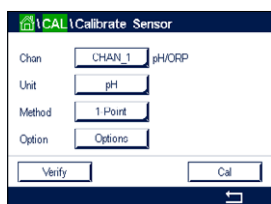

The following menus can be called up:

Unit: Select pH.

Method: Select the desired calibration procedure, 1-point, 2-point or process calibration.

Options: The buffer used for the calibration and the required stability of the sensor signal during the calibration can be selected (see also chapter 8.1.4.2 "pH Settings"). The changes are valid until the calibration mode has been escaped. After the values defined in the configuration menu are valid again.

7.3.1 One-Point Calibration

With pH sensors a one-point calibration is always performed as an offset calibration.

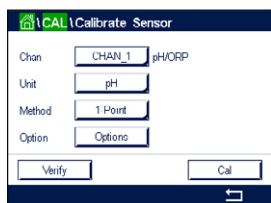

Press the button Cal for starting calibration.

Place the electrode in the buffer solution and press the Next button.

The display shows the buffer the transmitter has recognized **Point 1** and the measured value.

The M800 checks the stability of the measuring signal and proceeds as soon as the signal is sufficiently stable.



NOTE: If **option** Stability is set to Manual press 'Next' after the measuring signal is stable enough to go on with the calibration.

The transmitter shows the value for the slope and the offset as the result of the calibration.

For ISM sensors press the Adjust button to perform the calibration and store the calculated values in the sensor. Press the Calibrate button to store the calculated values in the sensor. Calibration is not performed. Press the Cancel button to terminate the calibration.

If "Adjust", "Calibrate" or "SaveCal" is chosen, the message "Calibration Saved Successfully!" is displayed. In either case you will see the message "Please re-install sensor".

7.3.2 Two-Point Calibration

With pH sensors a two-point calibration is always performed as calibration of slope and offset.

Press the Cal button to start calibration.

Place the electrode in buffer solution 1 and press Next button.

The display shows the buffer the transmitter has recognized **Point 1** and the measured value.

The M800 checks the stability of the measuring signal and proceeds as soon as the signal is sufficiently stable.

NOTE: If **option** Stability is set to Manual press 'Next' after the measuring signal is stable enough to go on with the calibration.

The transmitter prompts you to place the electrode in the second buffer solution.

Press the Next button to proceed with the calibration.

The display shows the buffer the transmitter has recognized **Point 2** and the measured value.

The M800 checks the stability of the measuring signal and proceeds as soon as the signal is sufficiently stable.

NOTE: If **option** Stability is set to Manual press 'Next' after the measuring signal is stable enough to go on with the calibration.

The transmitter shows the value for the slope and the offset as the result of the calibration.

For ISM sensors press the Adjust button to perform the calibration and store the calculated values in the sensor. Press the Calibrate button to store the calculated values in the sensor. Calibration is not performed. Press the Cancel button to terminate the calibration.

If "Adjust", "Calibrate" or "SaveCal" is chosen, the message "Calibration Saved Successfully!" is displayed. In either case you will see the message "Please re-install sensor".

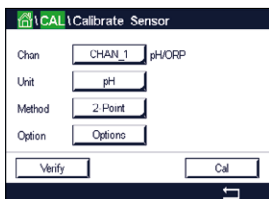

7.3.3 Process Calibration

With pH sensors a process calibration is always performed as an offset calibration.



Press the Cal button to start calibration.

Take a sample and press the \leftarrow button to store the current measuring value. To show the ongoing calibration process, P is blinking in the Start and Menu Screen if the related channel is selected in the display.

After determining the pH value of the sample, press the calibration icon in the Menu Screen again.

Enter the pH value of the sample. Press the Next button to start the calculation of the calibration results.

The display shows the value for the slope and the offset as the result of the calibration.

For ISM sensors press the Adjust button to perform the calibration and store the calculated values in the sensor. Press the Calibrate button to store the calculated values in the sensor. Calibration is not performed. Press the Cancel button to terminate the calibration.

If "Adjust", "Calibrate" or "SaveCal" is chosen, the message "Calibration Saved Successfully!" is displayed. In either case you will see the message "Please re-install sensor".

7.4 ORP Calibration of pH Sensors

PATH: \ Cal \ Calibrate Sensor

For pH sensors with solution ground based on ISM technology the M800 Transmitter gives the option to make, in addition to the pH calibration, an ORP calibration.



NOTE: In case of choosing ORP calibration the parameters defined for pH (see chapter 8.1.4.2 "pH Settings") will not be considered. For pH sensors, the M800 Transmitter features one-point calibration for ORP.

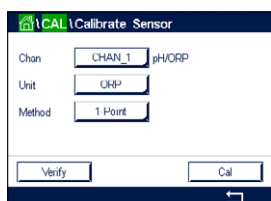

The following menus can be called up:

Unit: Select ORP through pressing the corresponding field.

Method: 1-Point calibration is displayed.

Press the button Cal for starting calibration.

Enter the value for calibration point 1 (**Point1**).

Press the Next button to start the calculation of the calibration results.

The display shows the value for the slope and the offset as the result of the calibration.

For ISM sensors press the Adjust button to perform the calibration and store the calculated values in the sensor. Press the Calibrate button to store the calculated values in the sensor. Calibration is not performed. Press the Cancel button to terminate the calibration.

If "Adjust", "Calibrate" or "SaveCal" is chosen, the message "Calibration Saved Successfully!" is displayed. In either case you will see the message "Please re-install sensor".

7.5 Calibration of Amperometric Oxygen Sensors

PATH:  \ Cal \ Calibrate Sensor

The M800 provides the ability to perform a one-point or process calibration for amperometric oxygen sensors.



NOTE: Before air calibration, for highest accuracy, enter the barometric pressure and relative humidity, as described in chapter 8.1.4.3 "Settings for Oxygen Measurement Based on Amperometric Sensors".

The following menus can be called up:

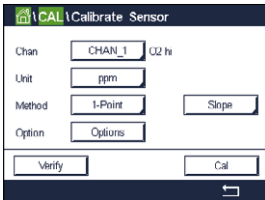

- Unit:** Between several units for DO can be chosen.
- Method:** Select the desired calibration procedure, 1-point or process calibration.
- Options:** In case the method 1-point has been chosen the calibration pressure, relative humidity and - for slope calibration - the stability mode for the sensor signal during the calibration can be selected. For the method Process the values for the process pressure, calibration pressure and the parameter ProcCalPress can be modified. See also chapter 8.1.4.3 "Settings for Oxygen Measurement Based on Amperometric Sensors". The changes are valid until the calibration mode has been escaped. After the values defined in the configuration menu are valid again.

7.5.1 One-Point Calibration

A one-point calibration of oxygen sensors is always either a one-point slope (i.e. with air) or a zero (offset) calibration. A one-point slope calibration is done in air and a one-point offset calibration is done at 0 ppb oxygen. A one-point zero dissolved oxygen calibration is available but not normally recommended since zero oxygen is very hard to achieve. A zero-point calibration is only recommended if high accuracy at low oxygen level (below 5% air) is needed.

Choose Slope or Offset calibration through pressing the corresponding field.

Press the button Cal for starting calibration.

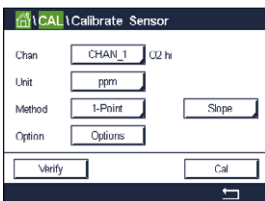

NOTE: If the polarization voltage for the measuring mode and calibration mode is different, the transmitter will wait 120 seconds before starting the calibration. In this case the transmitter will also go after the calibration for 120 seconds to the HOLD Mode, before returning to the measuring mode again.

Place the sensor in air or the calibration gas and press Next button

Enter the value for the calibration point (**Point1**).

The M800 checks the stability of the measuring signal and proceeds as soon as the signal is sufficiently stable.



NOTE: If **option** Stability is set to Manual press 'Next' after the measuring signal is stable enough to go on with the calibration.



NOTE: For an offset calibration the Auto mode is not available. If Auto mode has been chosen and afterwards slope calibration has been changed to offset calibration, the transmitter will perform the calibration in Manual mode.

The transmitter shows the value for the slope and the offset as the result of the calibration.

For ISM sensors press the Adjust button to perform the calibration and store the calculated values in the sensor. Press the Calibrate button to store the calculated values in the sensor. Calibration is not performed. Press the Cancel button to terminate the calibration.

If "Adjust", "Calibrate" or "SaveCal" is chosen, the message "Calibration Saved Successfully!" is displayed. In either case you will see the message "Please re-install sensor".

7.5.2 Process Calibration

A process calibration of oxygen sensors is always either a slope or an offset calibration.

Choose Slope or Offset calibration through pressing the corresponding field.

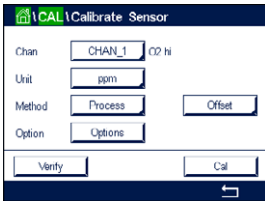

Press the Cal button to start calibration.

Take a sample and press the \leftarrow button to store the current measuring value. To show the ongoing calibration process, P is blinking in the Start and Menu screen if the related channel is selected in the display.

After determining the oxygen value of the sample, press the calibration icon in the Menu Screen again.

Enter the oxygen value of the sample. Press the Next button to start the calculation of the calibration results.

The display shows the value for the slope and the offset as the result of the calibration.

For ISM sensors press the Adjust button to perform the calibration and store the calculated values in the sensor. Press the Calibrate button to store the calculated values in the sensor. Calibration is not performed. Press the Cancel button to terminate the calibration.

If "Adjust", "Calibrate" or "SaveCal" is chosen, the message "Calibration Saved Successfully!" is displayed.

7.6 Calibration of Optical Oxygen Sensors (ISM Sensors only)

PATH:  \ Cal \ Calibrate Sensor

Oxygen calibration for optical sensors can be performed as a two-point, process or, depending on the sensor model connected to the transmitter, also as a one-point calibration.



NOTE: Before air calibration, for highest accuracy, enter the barometric pressure and relative humidity, as described in chapter 8.1.4.4 "Settings for Oxygen Measurement Based on Optical Sensors".

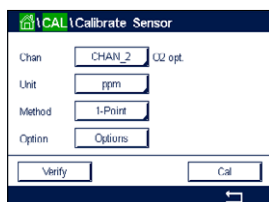

The following menus can be called up:

- Unit:** Between several units can be chosen. The units are displayed during the calibration.
- Method:** Select the desired calibration procedure, 1-point, 2-point or process calibration.
- Options:** In case the method 1-point has been chosen the calibration pressure, relative humidity and the stability mode for the sensor signal during the calibration can be selected. For the method Process the values for the process pressure, calibration pressure, the parameter ProcCalPress and the mode of the process calibration can be modified. See also chapter 8.1.4.4 "Settings for Oxygen Measurement Based on Optical Sensors". The changes are valid until the calibration mode has been escaped. After the values defined in the configuration menu are valid again.

7.6.1 One-Point Calibration

Typically a one-point calibration is done in air. Nevertheless other calibration gases and solutions are possible.

The calibration of an optical sensor is always a calibration of the phase of the fluorescence signal towards the internal reference. During a one-point calibration the phase in this point is measured and extrapolated over the measuring range.

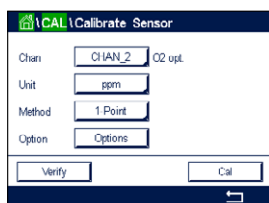

Press the button Cal for starting calibration.

Place the sensor in air or the calibration gas and press Next button

Enter the value for the calibration point (**Point1**).

The M800 checks the stability of the measuring signal and proceeds as soon as the signal is sufficiently stable.



NOTE: If **option** Stability is set to Manual press 'Next' after the measuring signal is stable enough to go on with the calibration.

The transmitter shows the value for the phase of the sensor at 100% air (P100) and at 0% air (P0) as the result of the calibration.

Press the Adjust button to perform the calibration and store the calculated values in the sensor. Press the Calibrate button to store the calculated values in the sensor. Calibration is not performed. Press the Cancel button to terminate the calibration.

If "Adjust" or "Calibrate" are chosen, the message "Calibration Saved Successfully!" is displayed. In either case you will see the message "Please re-install sensor".

7.6.2 Two-Point Calibration

The calibration of an optical sensor is always a calibration of the phase of the fluorescence signal towards the internal reference. A two-point calibration is a combination of first a calibration in air (100%) where a new phase P100 is measured and then a calibration in nitrogen (0%) where a new phase P0 is measured. This calibration routine gives the most accurate calibration curve over the whole measuring range.

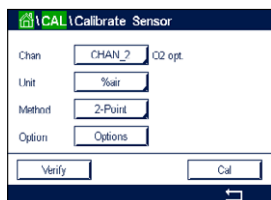

Press the Cal button to start calibration.

Place the sensor in air or the calibration gas and press Next button

Enter the value for the first calibration point (**Point1**).

The M800 checks the stability of the measuring signal and proceeds as soon as the signal is sufficiently stable.



NOTE: If **option** Stability is set to Manual press 'Next' after the measuring signal is stable enough to go on with the calibration.

The transmitter prompts you to change the gas.

Press the Next button to proceed with the calibration.

The M800 checks the stability of the measuring signal and proceeds as soon as the signal is sufficiently stable.



NOTE: If **option** Stability is set to Manual press 'Next' after the measuring signal is stable enough to go on with the calibration.

The transmitter shows the value for the phase of the sensor at 100% air (P100) and at 0% air (P0) as the result of the calibration.

Press the Adjust button to perform the calibration and store the calculated values in the sensor. Press the Calibrate button to store the calculated values in the sensor. Calibration is not performed. Press the Cancel button to terminate the calibration.

If "Adjust" or "Calibrate" are chosen, the message "Calibration Saved Successfully!" is displayed. In either case you will see the message "Please re-install sensor".

7.6.3 Process Calibration

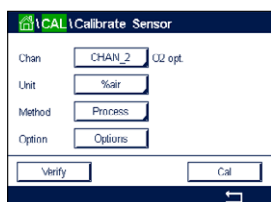

Press the Cal button to start calibration.

Take a sample and press the \leftarrow button to store the current measuring value. To show the ongoing calibration process, P is blinking in the start and Menu Screen if the related channel is selected in the display.

After determining the oxygen value of the sample, press the calibration icon in the Menu Screen.

Enter oxygen value of the sample. Press the Next button to start the calculation of the calibration results.

The display shows now the values for the phase of the sensor at 100% air (P100) and at 0% (P0) air.

Press the Adjust button to perform the calibration and store the calculated values in the sensor. Press the Calibrate button to store the calculated values in the sensor. Calibration is not performed. Press the Cancel button to terminate the calibration.



NOTE: If for process calibration Scaling has been chosen (see chapter 8.1.4.4 “Settings for Oxygen Measurement Based on Optical Sensors”) the calibration values are not stored in the calibration history.

If “Adjust” or “Calibrate” are chosen, the message “Calibration Saved Successfully!” is displayed.

7.7 Calibration of O₃ Sensors (ISM Sensors only)

The M800 provides the ability to perform a 1-Point or process calibration for O₃ sensors. Dissolved Ozone must be performed quickly because O₃ decays rapidly into oxygen, especially at warm temperatures.

Enter the menu Calibrate Sensor (see chapter 7.1 “Sensor Calibration”;

PATH: \Cal\Calibrate Sensor) and choose the desired channel for calibration.

The following menus can be called up:

Unit: Several units for dissolved O₃ can be chosen.

Method: Select the desired calibration procedure, 1-Point or process calibration.

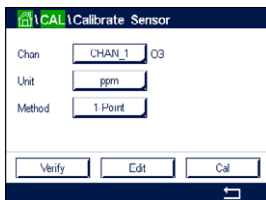

7.7.1 One-Point Calibration

Select the 1-Point calibration method. A one-point calibration of O₃ sensors is always a zero (offset) calibration

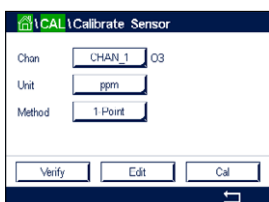

Press the button Cal for starting calibration.

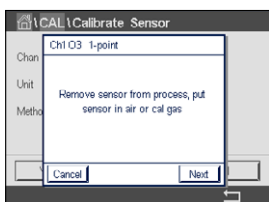

Place the sensor in the calibration gas, such as air, and press the Next button.

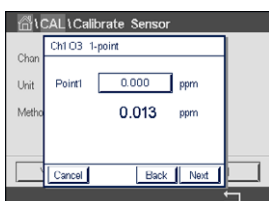

The second value displayed on the screen is the value being measured by the transmitter and sensor in the units selected by the user.

Press the input field for **Point1** to enter the value for the calibration point. The M800 displays a keypad for modifying the value. Press the \leftarrow button to accept the value.

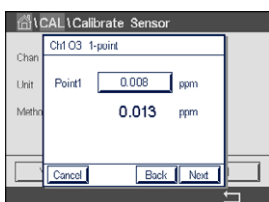

The screen shows the entered value for the reference solution (1st line) and the measured value of the M800 (2nd line).

When the measuring signal is stable, press Next to continue with the calibration

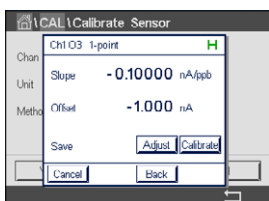

The display shows the value for the slope and the offset as result of the calibration.

Press the Adjust button to perform the calibration and store the calculated values in the sensor. Press the Calibrate button to store the calculated values in the sensor. Calibration is not performed. Press the Cancel button to terminate the calibration.

Use the Back button to go one step back in the calibration procedure

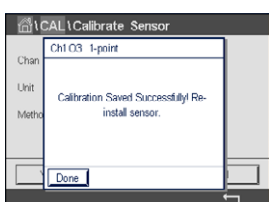

If "Adjust" or "Calibrate" are chosen, the message "Calibration Saved Successfully!" is displayed. In either case you will see the message "Please re-install sensor". After pressing the Done button the M800 returns to the calibration menu.

7.7.2 Process Calibration

Select the Process calibration method. A Process calibration of O₃ sensors can be performed as a slope or offset calibration.

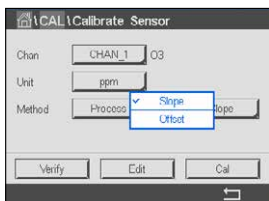

Select the desired calibration **Method**.

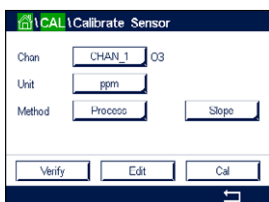

Press Cal to start the calibration.

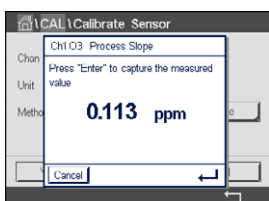

Take a sample and press the \leftarrow button to store the current measuring value. "P" will blink in the measurement screen indicating a Process calibration is active.



After determining the O₃ value of the sample, press the calibration icon to complete the Process calibration.



Press the input field for **Point1** and enter the O₃ value of the sample. Press the \leftarrow button to accept the value.

Press the Next button to start the calculation of the calibration results.



The display shows the value for the slope and the offset as the result of the calibration.

Press the Adjust button to perform the calibration and store the calculated values in the sensor. Press the Calibrate button to store the calculated values in the sensor. Calibration is not performed. Press the Cancel button to terminate the calibration.

Use the Back button to go one step back in the calibration procedure.



If "Adjust" or "Calibrate" are chosen, the message "Calibration Saved Successfully!" is displayed. After pressing the Done button the M800 returns to the Menu Screen

7.8 UniCond2e Electronics Calibration

The M800 provides the ability to calibrate or verify the electronic circuits of Unicond2e conductivity sensors. Unicond2e sensors have 3 resistance range circuits that require individual calibration. These measuring circuits are calibrated using the THORNTON ISM Conductivity Sensor Calibration Module part number 58082305 and supplied Y-connector. Before calibration, remove the sensor from the process, rinse with deionized water and allow to completely dry. Power the transmitter and sensor at least 10 minutes prior to calibration to assure stable operating temperature of the circuitry.

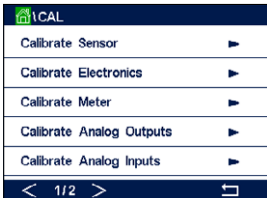

Press the Cal button.

Enter menu Calibrate Electronics.

Press the Chan_x button and select the desired channel for calibration.

Choose **Verify** or **Cal**.

Reference THORNTON ISM Conductivity Sensor Calibration Module (part number 58082305) for detailed calibration and verification instructions.

7.9 Calibration of Flow Sensors (ISM Sensors only)

The M800 Transmitter provides the ability to perform a 1-Point or 2-Point Sensor calibration for flow, Edit of saved calibration constants, and Verify of the flow signal. The most common method of calibration for flow sensors is to enter the calibration constants appropriate for the sensor using the Edit function. Some users may choose to perform an in-line calibration using a 1-point or 2-point Sensor flow calibration. This requires an external reference system. When performing an in-line calibration on a flow sensor, results will vary depending on the methods and calibration apparatus used to perform the calibration.

Enter the menu Calibrate Sensor (see chapter 7.1 "Sensor Calibration"; PATH: \Cal\Calibrate Sensor) and choose the desired channel for calibration.



NOTE: The channel for Flow Type 2 cannot be selected. The M800 Transmitter allows during the Guided Setup (see chapter 6 "Guided Setup") to enter a table of K and F factors

Select the channel (4-channel models only) and the desired calibration option. Choices are GPM, liters/minute meters³/hour, ft/sec, or meters/sec (for a 1-Point or 2-Point flow calibration), Edit and Verify. Press [ENTER].

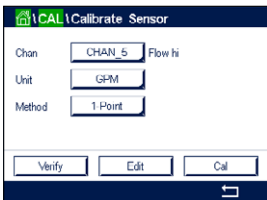

The following menus can be called up:

Unit: Several units for Flow can be chosen.

Method: Select the desired calibration procedure, 1-point or 2-point calibration.

7.9.1 One-Point Calibration

Select calibration method 1-Point . A one-point calibration of a Flow sensor is always a slope calibration.

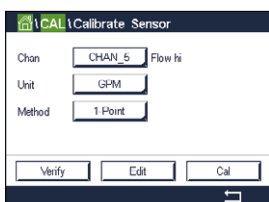

Press Cal to start the calibration.

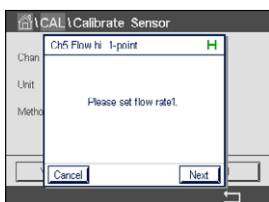

Set the desired flow rate and press Next.

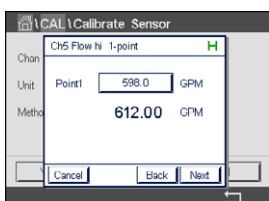

The second value displayed on the screen is the value being measured by the transmitter and sensor in the units selected by the user.

Press the input field for **Point1** to enter the value for the calibration point. The M800 displays a keypad for modifying the value. Press the \leftarrow button to accept the value.

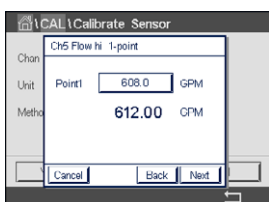

The screen shows the entered value for the reference system (1st line) and the measured value of the M800 (2nd line).

Press the Next button to start the calculation of the calibration results.

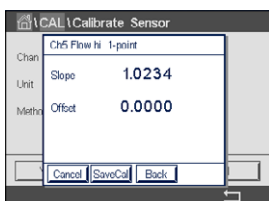

The display shows the value for the slope and the offset as result of the calibration.

Selecting Cancel will discard the entered values and the M800 will return to the calibration menu.

Use the Back button to go one step back in the calibration procedure.

Press SaveCal to save the calibration factors.

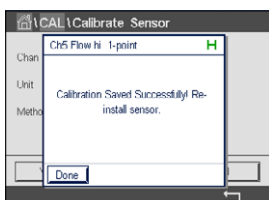

If "SaveCal" is chosen, "Calibration Saved Successfully" and "Please re-install sensor" is displayed. After pressing the Done button the M800 returns to the calibration menu.

7.9.2 Two-Point Calibration

Select calibration method 2-Point . A 2-point calibration of a Flow sensor calculates a new slope and offset.

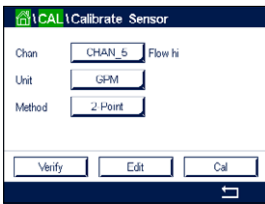

Press Cal to start the calibration

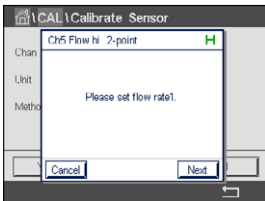

Set the desired flow rate for the first point and press Next.

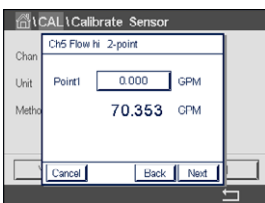

The second value displayed on the screen is the value being measured by the transmitter and sensor in units selected by the user.

Press the input field for **Point1** to enter the value for the calibration point. The M800 displays a keypad for modifying the value. Press the \leftarrow button to accept the value.

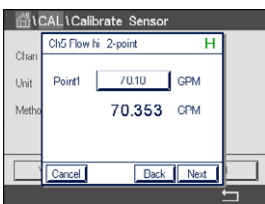

The screen shows the entered value for the reference system (1st line) and the measured value of the M800 (2nd line).

Press Next to continue the calibration.

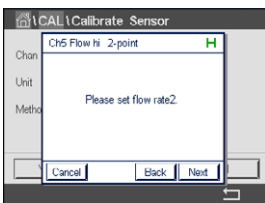

Set the desired flow rate for the second point and press Next.

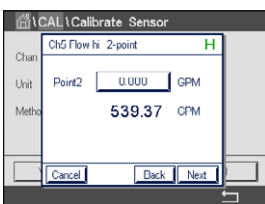

The second value displayed on the screen is the value being measured by the transmitter and sensor in units selected by the user.

Press the input field for **Point2** to enter the value for the calibration point. The M800 displays a keypad for modifying the value. Press the \leftarrow button to accept the value.

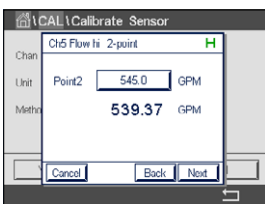

The screen shows the entered value for the reference system (1st line) and the measured value of the M800 (2nd line).

Press the Next button to start the calculation of the calibration results.

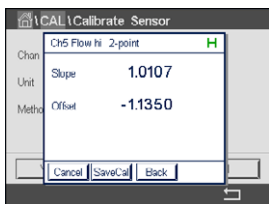

The display shows the value for the slope and the offset as result of the calibration.

Selecting Cancel will discard the entered values and the M800 will return to the calibration menu.

Use the Back button to go one step back in the calibration procedure.

Press SaveCal to save the calibration factors.

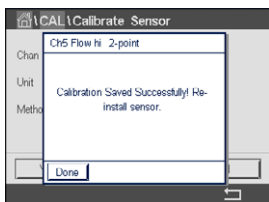

If "SaveCal" is chosen, "Calibration Saved Successfully" and "Please re-install sensor" is displayed. After pressing the Done button the M800 returns to the calibration menu.

7.10 Sensor Verification

Enter the menu Calibrate Sensor (see chapter 7.1 "Sensor Calibration";
 PATH: \ Cal \ Calibrate Sensor) and choose the desired channel for verification

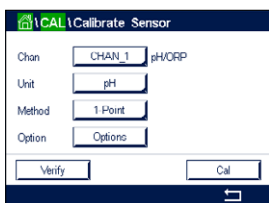

Press the Verify button to start verification.

The measured signal of the primary and the secondary measurement in basic (mostly electrical) units are shown. The meter calibration factors are used when calculating these values.

Press the button and the transmitter returns to the calibration menu.

7.11 Edit Calibration Constants for Flow Sensors

This function is the most commonly used calibration method for flow sensors

Enter the menu Calibrate Sensor (see chapter 7.1 "Sensor Calibration";
 PATH: \ Cal \ Calibrate Sensor) and choose the desired channel.

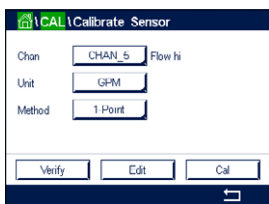

Press the Edit button.

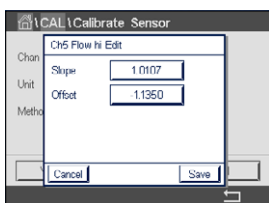

Press the input field for **Slope** to modify the slope value. The M800 displays a keypad for modifying the value. Press the button to accept the value.

Press the input field for **Offset** to modify the offset value. The M800 displays a keypad for modifying the value. Press the button to accept the value.

Selecting Cancel will discard the entered values and the M800 will return to the calibration menu.

Press Save to save the calibration factors.

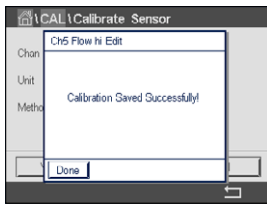

If "Save" is chosen "Calibration Saved Successfully" and "Please re-install sensor" is displayed. After pressing the Done button the M800 returns to the calibration menu.

Exit Menu Calibrate Sensor.

Press . To return to the Menu Screen press .

7.12 Flow Meter Verification

Enter Calibration Mode as described in chapter 7 "Calibration".

Enter menu Calibrate Meter.

Press the Chan_x button and select the desired channel for calibration.

Press Verify to start the verification process.

Connect a frequency generator to xIN and xGND and press Next.

The measured frequency is displayed.

Press to return to the calibration menu.

7.13 Analog Input Calibration

PATH: \ CAL \ Calibrate Analog Inputs



Analog input can be calibrated at 4 and 20 mA. Select the input signal for calibration by pressing the #1 button.

Connect an 4 mA signal to the analog input terminals. Press the Next button.

Enter the right value for the input signal (**Point1**).

Press the Next button to go on with the calibration.

Connect an 20 mA signal to the analog input terminals. Press the Next button.

Enter the right value for the input signal (**Point2**)

Press the Next button to go on with the calibration.

The display shows the calibration slope and zero point as the result of the input signal calibration.

Selecting Cancel will discard the entered values. Pressing SaveCal will making the entered values the current ones.

If "SaveCal" is chosen, "Calibration Saved Successfully" is displayed.

7.14 Maintenance

PATH:  \ CAL \ Maintenance

The different channels of the M800 Transmitter can be switched manually into HOLD state. Furthermore a cleaning cycle can be started / stopped manually.



Select the channel, which should be set to HOLD manually.

Press Start button for **Manual HOLD** to activate the HOLD state for the selected channel. To deactivate the HOLD state again, press the Stop button, which is now displayed instead of the Start button.

8 Configuration

For the menu structure refer to chapter 3.4.1 "Menu Structure".

8.1 Measurement

PATH:  \ CONFIG \ Meas

8.1.1 Channel Setup

PATH:  \ CONFIG \ Meas \ Channel Setup

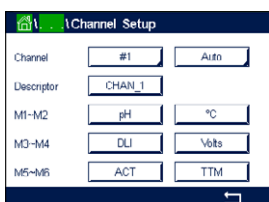

Select the **Channel** for the setup through pressing the button #1 for channel 1, #2 for channel 2 etc.

Press the right input field in the line of the setting for **Channel**. A parameter for the corresponding channel is chosen through pressing the according field.

If Auto is selected, M800 Water PROFINET and EtherNet/IP Transmitter automatically recognizes the type of sensor. The channel can also be fixed to a certain measurement parameter, depending on the type of transmitter.

Measurement parameter 2-channel

Measurement parameter		Type
pH/ORP	= pH and ORP	Water
UniCond2e	= 2 electrode conductivity	Water
UniCond4e	= 4 electrode conductivity	Water
Cond4e	= 4 electrode conductivity	Water
O ₂ lo THORNTON	= Dissolved oxygen	Water
TOC	= Total organic carbon	Water
O ₃	= Dissolved O ₃	Water

Enter the name with a maximum length of 6 characters for the channel through pressing the input field in the line **Descriptor**. The name of the channel will always be displayed, if the channel has to be selected. The name will also be displayed on the Start Screen and Menu Screen if the Display Mode (see chapter 8.1.3 "Display Mode") has been set to 1-channel or 2-channel.

Choose one of the measurements **M1 to M6** (e.g. for measuring value M1 the left button, for measuring M2 the right button in the corresponding line).

Select in the input field for **Measurement** the desired parameter to show.



NOTE: Beside the parameters pH, O₂, T, etc. also the ISM values DLI, TTM and ACT can be linked to the measurements.

Choose **Range factor** of the measuring value. Not all parameters allow a modification of the range.

The menu **Resolution** allows the setting of the resolution for the measurement. The accuracy of the measurement is not effected by this setting. Possible setting are 1, 0.1, 0.01, 0.001.

Selected the menu **Filter**. The averaging method (noise filter) for the measurement can be select-

ed. The options are None (default), Low, Medium, High and Special.

None = no averaging or filtering

Low = equivalent to a 3 point moving average

Medium = equivalent to a 6 point moving average

High = equivalent to a 10 point moving average

Special = averaging depending on signal change (normally High averaging, but Low averaging for large changes in input signal)

8.1.2 Derived Measurements

The M800 Water PROFINET and EtherNet/IP enables the setup of derived measurements (total, difference, ratio) based on two measuring values like pH, conductivity, etc. To get the derived measurements, first set up the two primary measurements, which will be used to calculate the derived measurement. Define the primary measurements as if they were stand-alone readings. Then choose the corresponding unit for the derived measurement for the first channel. The M800 Water PROFINET and EtherNet/IP Transmitter will display an additional menu **Other Channel** to select the second channel with the corresponding measurement.

There are three additional derived measurements available for configuration with two conductivity sensors: %Rej (% Rejection), pH Cal (Calculated pH) and CO₂ Cal (Calculated CO₂).

8.1.2.1 % Rejection measurement

For reverse osmosis (RO) applications, percent rejection is measured with conductivity to determine the ratio of impurities removed from product or permeate water to the total impurities in the incoming feed water. The formula for obtaining Percent Rejection is:

$$[1 - (\text{Product}/\text{Feed})] \times 100 = \% \text{ Rejection}$$

Where Product and Feed are the conductivity values measured by the respective sensors.

Figure a shows a diagram of an RO installation with sensors installed for Percent Rejection.

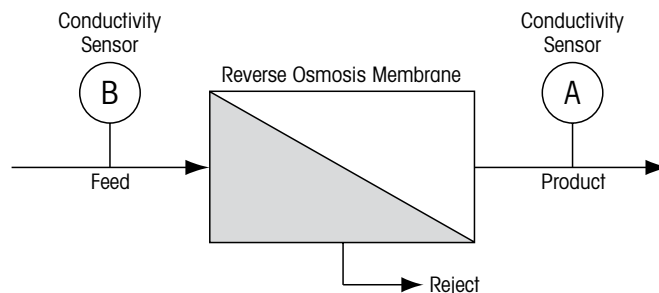

Figure a: % Rejection



NOTE: The product monitoring sensor must be on the channel that will measure percent rejection. If the product conductivity sensor is installed in channel 1, then percent rejection must be measured in channel 1.

8.1.2.2 Calculated pH (Power Plant Applications only)

Calculated pH may be obtained very accurately from specific and cation conductivity values on power plant samples when the pH is between 7.5 and 10.5 due to ammonia or amines and when the specific conductivity is significantly greater than the cation conductivity. This calculation is not suitable where significant levels of phosphates are present. The M800 Water PROFINET and EtherNet/IP uses this algorithm when pH Cal is selected as a measurement.

The calculated pH must be configured on the same channel as specific conductivity. For example, set up measurement M1 on CHAN_1 to be specific conductivity, measurement M1 on CHAN_2 to be cation conductivity, measurement M2 on CHAN_1 to be calculated pH and measurement M3 on CHAN_1 to be temperature. Set the temperature compensation mode to "Ammonia" for measurement M1 on CHAN_1 and to "Cation" for measurement M1 on CHAN_2.



NOTE: If operation goes outside the recommended conditions, a glass electrode pH measurement is needed to obtain an accurate value. On the other hand, when sample conditions are within the ranges noted above, the calculated pH provides an accurate standard for one-point trim calibration of the electrode pH measurement.

8.1.2.3 Calculated CO₂ (Power plant applications only)

Carbon dioxide may be calculated from cation conductivity and degassed cation conductivity measurements on power plant samples using tables from ASTM Standard D4519. The M800 Water PROFINET and EtherNet/IP has these tables stored in memory, which it uses when units of CO₂ CAL are selected.

The calculated CO₂ measurement must be configured to the same channel as cation conductivity. For example, set up measurement M1 on CHAN_1 to be cation conductivity, measurement M1 on CHAN_2 to be degassed cation conductivity, measurement M2 on CHAN_1 to be calculated CO₂ and measurement M2 on CHAN_2 to be temperature. Set the temperature compensation mode to "Cation" for both conductivity measurements.

8.1.3 Display Mode

PATH: \ CONFIG \ Meas \ Display Mode

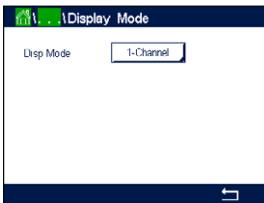

Press the input field in the line of the setting for **Disp Mode** and choose the measuring values, which are displayed on the Start Screen and Menu Screen.

Choose between the display of the measuring values for 1-channel, the measuring values for 2-channel, 4 measuring values (4-meas) or 8 measuring values (8-meas).



NOTE: If 1-channel or 2-channel has been chosen the measuring values, that will be displayed are defined in the menu Channel Setup (see chapter 8.1.1 "Channel Setup"). If 1-channel has been chosen, M1 to M4 of every channel will be displayed. In case of 2-channel M1 and M2 of every channel will be displayed.

Additional settings can be done if 4-meas or 8-meas has been selected.

Select the **Page** of the Start Screen or Menu Screen the measuring value will be displayed.

Choose the **Line** of the according page the measuring value will be displayed.

Select the **Channel** which should be displayed in the according line of the page through pressing the corresponding field.

Choose the measured value of the selected channel which should be displayed through the parameter **Measure**.



NOTE: Beside the measurement values pH, O₂, T, etc. also the ISM values DLI, TTM and ACT can be displayed.

8.1.4 Parameter related Settings

PATH:  \ CONFIG \ Meas \ Parameter Setting

Measuring and calibration parameters can be set for the parameters pH, conductivity and oxygen.

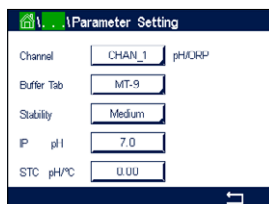

Access the menu **Channel** and select the channel.

Depending on the selected channel and assigned sensor the measuring and calibration parameters are displayed.

See the following explanation to get more details about the different parameter settings.

8.1.4.1 Conductivity Settings

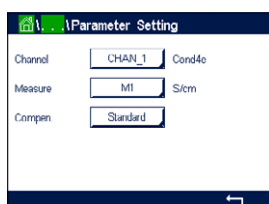

Select measurement (M1-M6). For more information regarding measurements see chapter 8.1.1 "Channel Setup".

If the selected measurement can be temperature compensated, the compensation method may be selected.



NOTE: During calibration, the compensation method must also be selected. (see chapter 7.2 "Calibration of UniCond2e and UniCond4e Sensors (ISM Sensors only)" and chapter "Calibration of Cond2e Sensors or Cond4e Sensors").

Press **Compen.** to select the desired temperature compensation method. Choices are "None", "Standard", "Light 84", "Std 75 °C", "Linear 25°C", "Linear 20°C", "Glycol.5", "Glycol1", "Cation", "Alcohol" and "Ammonia".

None does not make any compensation of the measured conductivity value. The uncompensated value will be displayed and proceeded.

Standard compensation includes compensation for non-linear high purity effects as well as conventional neutral salt impurities and conforms to ASTM standards D1125 and D5391.

Light 84 compensation matches the high purity water research results of Dr. T.S. Light published in 1984. Use only if your institution has standardized on that work.

Std 75 °C compensation is the Standard compensation algorithm referenced to 75 °C. This compensation may be preferred when measuring Ultrapure Water at an elevated temperature (Resistivity of ultrapure water compensated to 75 °C is 2.4818 Mohm-cm.)

Linear 25 °C compensation adjusts the reading by a coefficient or factor expressed as %/°C (deviation from 25 °C). Use only if the solution has a well-characterized linear temperature coefficient. The factory default setting is 2.0%/°C.

Linear 20 °C compensation adjusts the reading by a coefficient or factor expressed as %/°C (deviation from 20 °C). Use only if the solution has a well-characterized linear temperature coefficient. The factory default setting is 2.0%/°C.

Glycol.5 compensation matches the temperature characteristics of 50% ethylene glycol in water. Compensated measurements using this solution may go above 18 Mohm-cm.

Glycol1 compensation matches the temperature characteristics of 100% ethylene glycol. Compensated measurements may go well above 18 Mohm-cm.

Cation compensation is used in power industry applications measuring the sample after a cation exchanger. It takes into account the effects of temperature on the dissociation of pure water in the presence of acids.

Alcohol compensation provides for the temperature characteristics of a 75% solution of isopropyl alcohol in pure water. Compensated measurements using this solution may go above 18 Mohm-cm.

Ammonia compensation is used in power industry applications for specific conductivity measured on samples using ammonia and/or ETA (ethanolamine) water treatment. It takes into account the effects of temperature on the dissociation of pure water in the presence of these bases.



NOTE: If compensation mode “Linear 25 °C” or “Linear 20 °C” has been chosen, the coefficient for the adjustment of the reading can be modified. In this case an additional input field will be displayed.

Press the input field for **Coef.** and adjust the coefficient or factor for the compensation.

8.1.4.2 pH Settings

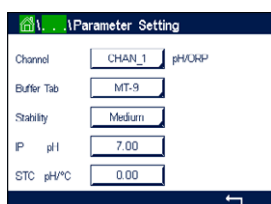

If a pH sensor is connected to the selected channel while during the channel setup (see chapter 8.1.1 “Channel Setup”) Auto has been chosen the parameters Buffer Tab, Stability, IP, STC and calibration temperature as well as the displayed units for slope and/or zero point can be set or adjusted. The same parameters will be displayed if during the channel setup not Auto but pH/ORP has been set.

Select the buffer through the parameter **Buffer Tab**.

For automatic buffer recognition during calibration, select the buffer solution set that will be used: Mettler-9, Mettler-10, NIST Tech, NIST Std = JIS Std, HACH, CIBA, MERCK, WTW, JIS Z 8802 or None. See 16 “Buffer tables” for buffer values. If the auto buffer feature will not be used or if the available buffers are different from those above, select None.



NOTE: For dual membrane pH electrodes (pH/pNa) buffer Na+ 3.9M (see chapter 16.2.1 “Mettler-pH/pNa buffers (Na+ 3.9M)”.

Select the required **Stability** of the measuring signal during the calibration procedure. Choose manual if the user will decide when a signal is stable enough to complete the calibration. Select Low, Medium or Strict if an automatic stability control of the sensor signal during calibration through the transmitter should be done.

If the parameter stability is set to medium (default) the signal deviation has to be less than 0.8 mV over a 20 second interval to be recognized by the transmitter as stable. The calibration is done using the last reading. If the criteria is not met within 300 seconds then the calibration times out and the message “Calibration Not Done” is displayed.

Adjust the parameter **IP pH**.

IP is the isothermal point value (Default = 7.000 for most applications). For specific compensation requirements or non standard inner buffer value, this value can be changed.

Adjust the value of the parameter **STC pH/°C**.

STC is the solution temperature coefficient in units of pH/°C referenced to the defined temperature. (Default = 0.000 pH/°C for most applications). For pure waters, a setting of –0.016 pH/°C should be used. For low conductivity power plant samples near 9 pH, a setting of –0.033 pH/°C should be used.

If the value for STC is \neq 0.000 pH/°C an additional input field for the reference temperature will be displayed.

The value for **pH Ref Temperature** indicates to which temperature the solution temperature compensation is referenced. The displayed value and the output signal is referenced to this temperature. Most common reference temperature is 25°C.

8.1.4.3 Settings for Oxygen Measurement Based on Amperometric Sensors

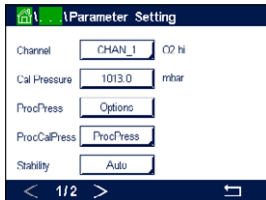

If an amperometric oxygen sensor is connected to the selected channel while during the channel setup (see chapter 8.1.1 "Channel Setup") Auto has been chosen the parameters CalPressure, ProcPressure, ProcCalPress, Stability, Salinity, RelHumidity, UpolMeas and UpolCal can be set or adjusted. The same parameters will be displayed if during the channel setup not Auto but O₂ hi, O₂ lo or O₂ trace has been set.

Enter the value for the calibration pressure through the parameter **CalPressure**.



NOTE: For a modification of the unit for the calibration pressure press U on the displayed keypad.

Press the Option button for the parameter **ProcPressure** and select the how to get applying process pressure through choosing the **Type**.

The applied process pressure can be entered by choosing Edit or measured over the analog input of the M800 by choosing Ain_1.

If Edit has been chosen an input field for entering the value manually is displayed on the screen. In case that Ain_1 has been selected two input fields are displayed to enter the start value (4 mA) and the end value (20 mA) of the range for the 4 to 20 mA input signal.

For the algorithm of the process calibration the applied pressure has to be defined. Select the pressure through the parameter **ProcCalPress**. For the process calibration the value of the process pressure (ProcPress) or the calibration pressure (CalPress) can be used.

Select the required **Stability** of the measuring signal during the calibration procedure. Choose Manual if the user will decide when a signal is stable enough to complete the calibration. Select Auto and an automatic stability control of the sensor signal during calibration through the transmitter will be done.

Additional settings can be done by navigating to the next page of the menu.

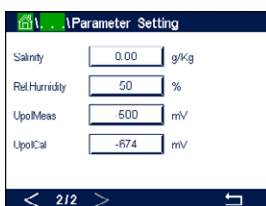

The **Salinity** of the measured solution can be modified.

In addition the relative humidity (button **Rel.Humidity**) of the calibration gas can also be entered. The allowed values for relative humidity are in the range 0% to 100%. When no humidity measurement is available, use 50% (default value).

The polarization voltage of amperometric oxygen sensors in the measuring mode can be modified through the parameter **UpolMeas**. For entered values 0 mV to -550 mV the connected sensor will be set to a polarization voltage of -500mV. If the entered value is less then -550 mV, the connected sensor will set to a polarization voltage of -674 mV.

The polarization voltage of amperometric oxygen sensors for calibration can be modified through the parameter **UpolCal**. For entered values 0 mV to -550 mV the connected sensor will be set to a polarization voltage of -500mV. If the entered value is less then -550mV, the connected sensor will set to a polarization voltage of -674mV.



NOTE: During a process calibration, the polarization voltage UpolMeas, defined **for** the measuring mode, will be used.



NOTE: If a one-point calibration is executed, the transmitter sends the polarization voltage, valid for the calibration, to the sensor. If the polarization voltage for the measuring mode and calibration mode is different, the transmitter will wait 120 seconds before starting the calibration. In this case the transmitter will also go after the calibration for 120 seconds to the HOLD Mode, before returning to the measuring mode again.

8.1.4.4 Settings for Oxygen Measurement Based on Optical Sensors

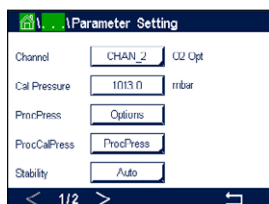

If an optical oxygen sensor is connected to the selected channel while during the channel setup (see chapter 8.1.1 "Channel Setup") Auto has been chosen the parameters CalPressure, ProcPressure, ProcCalPress, Stability, Salinity, RelHumidity, Sample Rate, LED Mode and Toff can be set or adjusted. The same parameters will be displayed if during the channel setup not Auto but Optical O₂ has been set.

Enter the value for the calibration pressure through the parameter **CalPressure**.

Press the button Option for the parameter **ProcPress** and select the how to get applying process pressure through pressing the according button in the line **Type**.

The applied process pressure can be entered by choosing Edit or measured over the analog input of the M800 by choosing AIN_1.

If Edit has been chosen an input field for entering the value manually is displayed on the screen. In case that AIN_1 has been selected two input fields are displayed to enter the start value (4mA) and the end value (20 mA) of the range for the 4 to 20 mA input signal.

For the algorithm of the process calibration the applied pressure has to be defined. Select the pressure through the parameter **ProcCal**. For the process calibration the value of the process pressure (ProcPress) and the value of the calibration pressure (CalPress) can be used. Select between Scaling and Calibration for the process calibration. If Scaling has been chosen, the calibration curve of the sensor will be untouched, but the output signal of the sensor will be scaled. In case of calibration value <1%, the offset of the sensor output signal will be modified during scaling, for value >1% the slope of the sensor output will be adjusted. For further information about scaling refer to the sensor manual.

Selecting the required **Stability** of the measuring signal during the calibration procedure. Choose Manual if the user will decide when a signal is stable enough to complete the calibration. Select Auto and an automatic stability control of the sensor signal during calibration through the transmitter will be done.

Additional settings can be done by navigating to the next page of the menu.

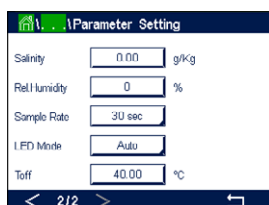

The **Salinity** of the measured solution can be modified.

In addition the relative humidity (button **Rel.Humidity**) of the calibration gas can also be entered. The allowed values for relative humidity are in the range 0% to 100%. When no humidity measurement is available, use 50% (default value).

Adjust the required **Sample Rate** of the optical sensor during measurement. The time interval from one measuring cycle of the sensor to the next can be adjusted i.e. adapted to the application. A higher value will increase the life time of the OptoCap of the sensor.

Select the **LED Mode** of the sensor. There are the following options.

Off: LED is permanently switched off.

On: LED is permanently switched on.

Auto: The LED is switched on as long as the measured media temperature is smaller then Toff (see next value) or switched off through a digital input signal (see chapter 8.7 "Digital Inputs").



NOTE: If the LED is switched off, no oxygen measurement is performed.

Enter the limit for the measuring temperature to switch off the LED of the sensor automatically for the M800 through the parameter **Toff**.

If the media temperature is higher then Toff, the LED will be switched off. The LED will be switched on as soon as the media temperature falls below Toff -3 K. This function give the option to increase the lifetime of the OptoCap by switching off the LED during SIP or CIP cycles.



NOTE: This function is only active if the LED Mode is set to "Auto".

8.1.4.5 Settings for TOC Measurement

For information on how to configure parameter related settings associated with TOC measurement, refer to the 6000TOCi operating manual provided with the 6000TOCi Total Organic Carbon sensor.

8.1.5 Concentration Curve Table

To specify a concentration curve for customer-specific solutions, up to 5 concentration values can be edited in a matrix together with up to 5 temperatures. To do so the desired values are edited under the concentration curve table menu. Beside the temperature values, the conductivity and concentration values for the corresponding temperature are edited. The concentration curve can be selected resp. used in combination with conductivity sensors.

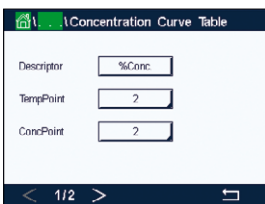

Enter the name with a maximum length of 6 characters for the concentration curve through pressing the input field in the line **Descriptor**.

Enter the amount of desired temperature points (**TempPoint**) and concentration points (**ConcPoint**).

The different values can be entered by navigating to the next page of the menu.

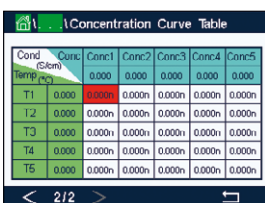

Enter the values for temperature (**T1...T5**), concentration (**Conc1...Conc5**) and the corresponding conductivity through pressing the according input field. The unit for the value of the conductivity can be adjusted as well in the according input field.



NOTE: The values for the temperature have to increase from T1 to T2 to T3, etc. The values for the concentration have to increase from Conc 1 to Conc2 to Conc3, etc.



NOTE: The conductivity values at the different temperatures have to increase or decrease from Conc1 to Conc2 to Conc3, etc. Maxima and/or minima are not permitted. If the conductivity values at T1 are increasing with the different concentrations, they have to increase also at the other temperatures. If the conductivity values at T1 are decreasing with the different concentrations, they have to decrease also at the other temperatures.

8.2 Set Points

PATH:  \ CONFIG \ Set Points

See the following explanation to get more details about the different settings for the set points.

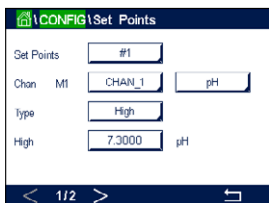

Press the input field in the line of the setting for **Set Point** and select the desired set point for configuration through pressing the button #1 for set point 1, #2 for set point 2 etc..

Press the related button for the assignment of the channel (**Chan**). Select the channel, which has to be linked to the set point.

Press the button for the assignment of the measuring parameter – based on the selected channel – that has to be linked to the set point.

Mx in the display indicates the measurement assigned to the set point. (see chapter 8.1.1 “Channel Setup”).



NOTE: Beside the parameters pH, O₂, T, mS/cm, %EP WFI etc. also the ISM values DLI, TTM and ACT can be linked to the set point.

The **Type** of the setpoint can be High, Low, Between, Outside or Off. An “Outside” setpoint will cause an alarm condition whenever the measurement goes above its high limit or below its low limit. A “Between” setpoint will cause an alarm condition to occur whenever the measurement is between its high and low limits.



NOTE: If the type of set point is not Off additional settings can be done. See the following description.

According to the selected type of setpoint, value(s) regarding the limit(s) can be entered.

Additional settings can be done by navigating to the next page of the menu.

8.3 ISM Setup (ISM Sensors only)

PATH:  \ CONFIG \ ISM Setup

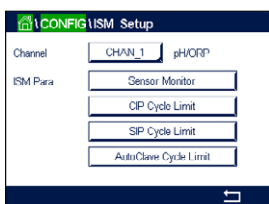

See the following explanation to get more details about the different parameter settings for the ISM Setup.

8.3.1 Sensor Monitor

If a pH/ORP, O₂ lo, O₃ or O₂ optical sensor is connected to the selected channel while during the channel setup (see 8.1.1 "Channel Setup") Auto has been chosen the parameter Sensor Monitor can be set or adjusted. The menu Sensor Monitor will also be displayed if during the channel setup not Auto but one of the mentioned sensors has been set.

Press the button Sensor Monitor.

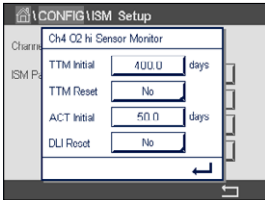

Enter the value for the initial Time To Maintenance interval (**TTM Initial**) in days. The initial value for TTM can be modified according to the application experience.

For pH/ORP sensor the timer estimates when the next cleaning cycle should be performed to keep the best possible measurement performance. The timer is influenced by significant changes on the DLI parameters.

For amperometric oxygen and ozone sensors, the time to maintenance indicates a maintenance cycle for the membrane and electrolyte.

Press the input field for **TTM Reset**. Select Yes if Time To Maintenance (TTM) for the sensor should be reset to the initial value.

Time To Maintenance needs to be reset after the following operations.

pH sensors: manual maintenance cycle on the sensor.
 Oxygen or ozone sensor: manual maintenance cycle on the sensor or exchanging of the membrane of the sensor



NOTE: The menu TTM Initial and TTM Reset is for O₂ optical sensors not available.



NOTE: By connecting a sensor, the actual value for TTM of the sensor is read out from the sensor.

Enter the **ACT Initial** value in days. The new value will be loaded down to the sensor after saving the changes.

The Adaptive Calibration Timer (ACT) estimates when the next calibration should be performed to keep the best possible measurement performance. The timer is influenced by significant changes on the DLI parameters. The ACT will be reset to its initial value after a successful calibration. The initial value for the ACT can be modified according to the application experience and loaded down to the sensor.



NOTE: By connecting a sensor, the actual value for the ACT of the sensor is read out from the sensor.

Press the input field for **DLI Reset**. Select Yes if Dynamic Lifetime Indicator (DLI) for the sensor should be reset to the initial value. The reset will be done after saving the changes.

The DLI allows an estimation, when the pH electrode, the inner body of an amperometric oxygen or ozone sensor or the OptoCap of an optical oxygen sensor is at the end of his lifetime, based on the actual stress he is exposed to. The sensor permanently takes the averaged stress of the past days into consideration and is able to increase/decrease the lifetime accordingly.

The following parameters affect the lifetime indicator:

Dynamic parameters:

- Temperature
- pH or oxygen value
- Glass impedance (only pH)

Static parameters:

- Calibration history
- Zero and Slope
- Phase 0 and phase 100 (only optical DO)

- Reference impedance (only pH)
- Illumination time (only optical DO)
- Sampling rate (only optical DO)
- CIP/SIP/Autoclaving cycles

The sensor keeps the information stored in the built in electronics and can be retrieved via a transmitter or the iSense asset management suite.

For amperometric oxygen sensors, the DLI is related to the inner-body of the sensor. After exchanging the inner-body perform DLI Reset.

For optical DO sensors the lifetime indicator is related to the OptoCap. After exchanging the Opto-Cap perform DLI Reset.



NOTE: By connecting a sensor, the actual values for the DLI of the sensor are read out from the sensor.



NOTE: The menu DLI Reset for pH sensors not available. If the actual value for the DLI of a pH sensor is 0 the sensor has to be replaced.

8.3.2 CIP Cycle Limit

If a pH/ORP, oxygen or conductivity sensor is connected to the selected channel during the channel setup (see chapter 8.1.1 "Channel Setup") Auto has been chosen the parameter CIP Cycle Limit can be set or adjusted. The menu CIP Cycle Limit will also be displayed if during the channel setup not Auto but one of the mentioned sensors has been set.

Press the button CIP Cycle Limit.

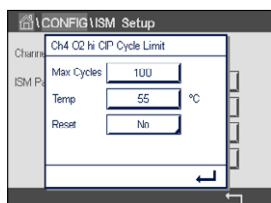

Press the button in the input field for the parameter **Max Cycles** and enter the value for the maximum CIP cycles. The new value will be written to the sensor after saving the changes.

The CIP cycles are counted by the transmitter.

If the Max Cycles setting is on 0, the counter functionality is turned off.

NOTE: In case of an optical oxygen sensor, the value for Max Cycles will also be written to the sensor. The M800 Transmitter uploads the value Max Cycles from an optical oxygen sensor after the connection.

Press the button in the input field for the parameter **Temp** and enter the temperature, which has to be exceeded, that the a CIP cycle will be counted.

CIP Cycles will be automatically recognized by the transmitter. Since CIP cycles will vary in intensity (duration and temperature) for each application the algorithm of the counter recognizes an increase of the measurement temperature above the level defined through the value for Temp. If the temperature does not decrease below the defined temperature level -10 °C within the next 5 minutes after the first temperature was reached, the counter in question will be incremented by one and also locked for the next two hours. In the case the CIP would last longer than two hours the counter would be incremented by one once more.

Press the input field for **Reset**. Select Yes if CIP counter for the sensor should be reset to 0. The reset will be done after saving the changes.

If an oxygen sensor is connected, the reset should be performed after the following operations.
 optical sensor: exchanging of the OptoCap
 amperometric sensor: exchanging of the inner-body of the sensor.

NOTE: For pH/ORP sensor the menu Reset is not available. A pH/ORP sensor should be replaced if the number for Max Cycles has been exceeded.



8.3.3 SIP Cycle Limit

If a pH/ORP, oxygen or conductivity sensor is connected to the selected channel during the channel setup (see chapter 8.1.1 "Channel Setup") Auto has been chosen the parameter SIP Cycle Limit can be set or adjusted. The menu SIP Cycle Limit will also be displayed if during the channel setup not Auto but one of the mentioned sensors has been set.

Press the button SIP Cycle Limit.

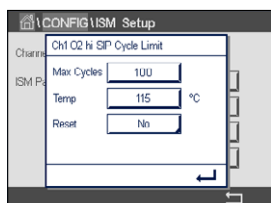

Press the button in the input field for the parameter **Max Cycles** and enter the value for the maximum SIP cycles. The new value will be written to the sensor after saving the changes.

The SIP cycles are counted by the transmitter.

If the Max Cycles setting is on 0, the counter functionality is turned off.



NOTE: In case of an optical oxygen sensor, the value for Max Cycles will also be written to the sensor. The M800 Transmitter uploads the value Max Cycles from an optical oxygen sensor after the connection.

Press the button in the input field for the parameter **Temp** and enter the temperature, which has to be exceeded, that the a SIP cycle will be counted.

SIP Cycles will be automatically recognized by the transmitter. Since SIP cycles will vary in intensity (duration and temperature) for each application the algorithm of the counter recognizes an increase of the measurement temperature above the level defined through the value for Temp. If the temperature does not decrease below the defined temperature level - 10°C within the next 5 minutes after the first temperature was reached, the counter in question will be incremented by one and also locked for the next two hours. In the case the SIP would last longer than two hours the counter would be incremented by one once more.

Press the input field for **Reset**. Select Yes if SIP counter for the sensor should be reset to 0. The reset will be done after saving the changes.

If an oxygen sensor is connected, the reset should be performed after the following operations.
 Optical sensor: exchanging of the OptoCap
 Amperometric sensor: exchanging of the inner-body of the sensor.



NOTE: For pH/ORP sensor the menu Reset is not available. A pH/ORP sensor should be replaced if the number for Max Cycles has been exceeded.

8.3.4 AutoClave Cycle Limit

If a pH/ORP, amperometric oxygen or, depending on the model, optical oxygen sensor is connected to the selected channel during the channel setup (see chapter 8.1.1 “Channel Setup”) Auto has been chosen the parameter AutoClave Cycle Limit can be set or adjusted. The menu AutoClave Cycle Limit will also be displayed if during the channel setup not Auto but one of the mentioned sensors has been set.

Press the button AutoClave Cycle Limit.

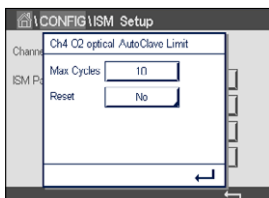

Press the button in the input field for the parameter **Max Cycles** and enter the value for the maximum AutoClave cycles. The new value will be written to the sensor after saving the changes.

If the Max Cycles setting is on 0, the counter functionality is turned off.

Since during the autoclaving cycle the sensor is not connected to the transmitter, you will be asked after every sensor connection, whether the sensor was autoclaved or not. According to your selection, the counter will be incremented or not.



NOTE: In case of an optical oxygen sensor, the value for AutoClave Max will be written to the sensor. The M800 Transmitter uploads the value Max Cycles from an optical oxygen sensor after plugging in.

Press the input field for **Reset**. Select Yes if the AutoClave counter for the sensor should be reset to 0. The reset will be done after saving the changes.

If an oxygen sensor is connected, the reset should be performed after the following operations.
 Optical sensor: exchanging of the OptoCap
 Amperometric sensor: exchanging of the inner-body of the sensor.



NOTE: For pH/ORP sensor the menu Reset is not available. A pH/ORP sensor should be replaced if the number for Max Cycles has been exceeded.

8.3.5 DLI Stress Adjustment

If a pH/ORP is connected to the selected channel during the channel setup (see chapter 8.1.1 “Channel Setup”) Auto has been chosen the parameter DLI Stress Adjustment can be adjusted. With this setting the user can adjust the sensor sensitivity to the stress of his specific application for the DLI calculation.



Browse to page 2 of “ISM Setup”.

Press the button **DLI Stress Adjustment**.

Select between low / medium / high for the **Type** of DLI Stress Adjustment.

- LOW: DLI extended (–30% sensitivity)
- MEDIUM: standard DLI (default)
- HIGH: DLI reduced (+30% sensitivity)

Press ← to accept the setting.

8.3.6 SAN Cycle Parameters

If an ozone sensor is connected, values for the following SAN Cycle Parameters can be set, Max Cycles (the maximum number of sanitization cycles), Conc. Max (the maximum allowed O₃ concentration), Conc. Min (the minimum allowed O₃ concentration), Cycle Time (length of cycle), and Reset.

Press the button SAN Cycle Parameters.

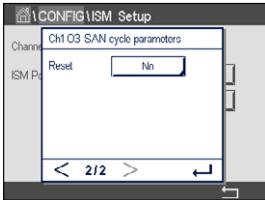

Press the input field next to Max Cycles and enter the value for the maximum SAN cycles. Press \leftarrow to accept the value. The new value will be written to the sensor after saving the changes.

The SAN cycles are counted by the transmitter. If the limit (value for Max Cycles) is reached, an alarm can be configured. If the Max Cycles setting = 0, the counter functionality is turned off.

Press the input field next to Conc. Max and enter the ozone concentration above which a sanitization cycle is to be detected. Press \leftarrow to accept the value.

Press the input field next to Conc. Min. Enter the value for the ozone concentration below which a sanitization cycle is no longer detected. Press \leftarrow to accept the value.

Press the input field next to Cycle Time. Enter the value for the time, the ozone concentration has to be higher than the Conc. Min value after the Conc. Max value has been exceeded to count a sanitization cycle. Press \leftarrow to accept the value.

Press the input field next to Reset. Select Yes to reset the sanitization counter to zero. This is typically performed after sensor replacement. The reset will be done after saving the changes.

Press \leftarrow to exit the menu SAN Cycle Parameters.

8.3.7 Reset Counters for UniCond2e Sensors

For UniCond2e sensors, the following counters can be reset: High Temp and High Conductivity.

Press the button Reset Counters.

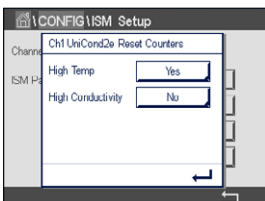

Select Yes for the desired counter to be reset and press enter. The reset will be done after saving the changes.

Press \leftarrow to exit the menu Reset Counters.

8.3.8 Set Calibration Interval for UniCond2e Sensors

For UniCond2e sensor the Cal Interval (calibration interval) can be set.

Press the button Cal Interval.

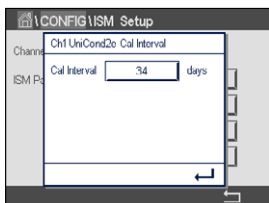

Press the input field next to **Cal Interval** and enter the value for the calibration interval. Based on this value the Time To Calibration (TTCal) will be calculated by the transmitter. Press **↵** to accept the value. The new value will be written to the sensor after saving the changes.

Press **↵** to exit the menu Cal Interval.

8.4 General Alarm

PATH: **🏠** \ CONFIG \ General Alarm

See the following explanation to get more details about the different settings for General Alarm.



Press the button Event in the line of the settings for **Option** and select the events, that should be considered for an alarm.

8.5 ISM / Sensor Alarm

PATH: **🏠** \ CONFIG \ ISM / Sensor Alarm

See the following explanation to get more details about the different settings for ISM / Sensor Alarm.

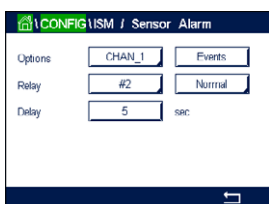

Select the channel by pressing the related button in the line of the settings for **Option**.

Depending on the selected channel or assigned sensor the **Events** that will be considered for generating an alarm can be selected. Some alarms will be considered in any case and not have to be selected or deactivated.

8.6 Display Setup

PATH:  \ CONFIG \ Display Setup

See the following explanation to get more details about the different settings for Display Setup

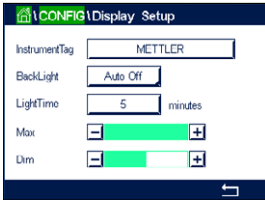

Enter the name for the M800 Transmitter (**Instrument Tag**). The instrument tag will also be displayed on the line at the top of the Start Screen and Menu Screen.

Use **BackLight** to switch off or dim the transmitter screen after a defined time period without interaction. The transmitter screen will automatically come back after pressing the display.

Enter the **Light Time** in minutes. The light time is the time period without interaction before the transmitter screen will be dimmed or switched off.

NOTE: In case of an unacknowledged warning or alarm the transmitter screen will not be dimmed or switched off even if the light time has been elapsed

The parameter **Max** allows the setting of the backlight during operation. With the parameter **Dim** the backlight of the transmitter screen during the dimmed state can be adjusted. Press the + or - buttons in the corresponding line to adjust the parameters.



8.7 Digital Inputs

PATH:  \ CONFIG \ Digital Inputs

See the following explanation to get more details about the different settings for the digital inputs

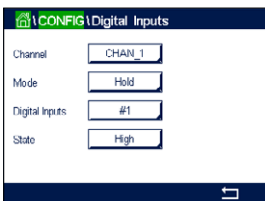

Press the related button for the assignment of the **Channel** (Chan_). Select the channel, which has to be linked to the digital input signal.

Press the input field in the line of the setting for **Mode** and select the impact of an active digital input signal. Choose 'HOLD' to lead the assigned channel in HOLD state. If an optical DO sensor is connected, the digital input signal can be used for LED controlling.

Press the related button for the assignment of the **Digital Inputs** (#1 for DI1, #2 for DI2 etc.) and select the digital input signal, which has to be linked to the channel.

An additional setting can be done, if a digital input signal has been selected.

Press the input field in the line for the setting of the **State** and select if the digital input is active at high or low level of the voltage input signal.

8.8 System

PATH:  \ CONFIG \ System

See the following explanation to get more details about the different settings for the System.

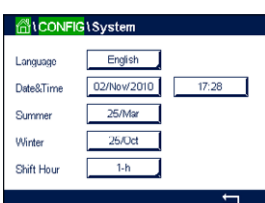

Select the desired **Language**. The following languages are available: English, French, German, Italian, Spanish, Portuguese, Russian, Chinese, Korean or Japanese.

Enter **Date&Time**.

The automatic change-over from summertime to wintertime and vice-versa frees the users from having to correct the time twice a year.

The winter to summer time-change is carried out automatically using the 12-month clock integrated in the transmitter. The date for the time-change can be set with the parameter **Summer**.

Provided it is a Sunday, the time-change would take place on the day that equates with the value, otherwise on the following Sunday. The winter/summer time-change takes place at 02:00 h.

The summer to winter time-change is carried out automatically using the 12-month clock integrated in the transmitter. The date for the time-change can be set through the parameter **Winter**.

Provided it is a Sunday, the time-change would take place on the day that equates with the value, otherwise on the following Sunday. The winter/summer time-change takes place at 03:00 h.

The number of hours, the clock will be shifted through the winter to summer and summer to winter time-change can be chosen. Press the related button for the setting of the **Shift Hour**.

8.9 Service

PATH:  \ CONFIG \ Service

This menu is a valuable tool for troubleshooting and provides diagnostic functionality for the following items: Calibrate TouchPad, Outputs, Read Digital Inputs, Memory, Display and optical DO sensors.



Select through the parameter **System** the desired item for diagnostic by pressing the according field.

Select through **Chan** the channel for diagnostic information of the sensor. This menu is only displayed if a sensor is connected.

The provided diagnostic functionality can now be called up through pressing the button **Diagnostic**.

8.9.1 Read Digital Inputs

The menu shows the state of the digital input signals.

8.9.2 Memory

If Memory is selected the transmitter will perform a memory test of all connected transmitter boards and ISM sensors.

8.9.3 Display

The transmitter shows every 5 seconds red, green, blue, grey and dark grey display and returns afterwards to the menu Service. If within the 5 seconds for every color the screen is pressed the transmitter will go to the next step.

8.9.4 Calibrate TouchPad

During the 4 calibrations steps, always press the center of the circle shown circle in the 4 corners of the display. The transmitter will show the calibration result.

8.9.5 Channel Diagnostic

If an error has occurred with the sensor, the corresponding messages are displayed.

8.10 Technical Service

PATH:  \ CONFIG \ Technical Service

This menu is only intended for METTLER TOLEDO's service and is password-protected.

With this menu the calibration factors for the analog input can be shown.



Select through the parameter **Options** the signal(s), the calibration factors should be displayed for.

8.11 User Management

PATH:  \ CONFIG \ User Management

This menu allows for the configuration of different user and administrator passwords, as well as setting up a list of allowed menus for the different users. The administrator has rights to access all menus. All default passwords for new transmitters are "00000000".

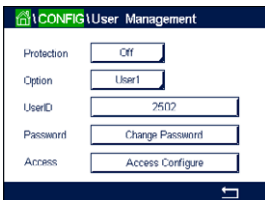

Press the input field in the line of **Protection** and select the desired kind of protection. The following options are available:

Off: No protection

Active: Activation of the Menu Screen (see chapter 3.2.2 "Activation Menu Screen") has to be confirmed

Password: Activation of the Menu Screen is only possible with a password

Press the according button for **Option** to select the profile for the administrator (Admin) or one of the users.

NOTE: The administrator always has the rights to access all menus. For different users the access rights can be defined.

Press the input button for **UserID** to enter the name for the user or administrator. The name for the user or administrator will be displayed if the protection via password is selected for activation of the Menu Screen.

For changing the password of the selected user or administrator press the input field for **Password**. Enter the old password in the field Old PW, the new one in the field New PW and confirm it in the field confirm PW. The default password is "00000000" for the administrator and all users.

If the profile for a user has been selected an additional input field to define the access rights will be displayed.

To assign access rights the according button for the menu has to be pressed. In case of an assignment of the access rights, is displayed in the related button.



8.12 Reset

PATH:  \ CONFIG \ Reset

Depending on the transmitter version and configuration different options for a reset are available.

See the following explanation to get more details about the different option to reset data and / or configurations.

8.12.1 System Reset

This menu option allows the reset of the M800 Water PROFINET and EtherNet/IP Transmitter to the factory default settings (setpoints off, passwords, etc.). Furthermore the calibration factors for analog inputs, meter etc. can be set to the last factory values.

Press the input field for **Options** and select System.

Press the input field for **Items** (Configure button) and select the different parts of the configuration that will be reset.

If an item has been selected the Action menu is displayed. Press the Reset button.

8.12.2 Reset Sensor Calibration for Optical DO Sensors

If an optical oxygen sensor is connected to the transmitter, a menu is available that allows the reset of the calibration data of the sensor to the factory settings.

Press the input field for **Options** and select the channel the optical DO sensor is connected to.

Press the input field for **Items** (Configure button). Select SensorCal to Factory by pressing the according button.

If SensorCal to Factory has been selected the Action menu is displayed. Press the Reset button.



NOTE: Through a reset of the calibration data the Adaptive Calibration Timer (see chapter 9.1 "iMonitor") will set to 0.



NOTE: To ensure best measuring results, a new calibration of the sensor is recommended after a reset of the calibration data to factory settings. Depending on the application and sensor, the calibration should be performed as a one-point calibration or two-point calibration (see chapter 7.6 "Calibration of Optical Oxygen Sensors (ISM Sensors only)").

8.12.3 Reset Sensor Calibration for UniCond2e Sensors

For UniCond2e sensors, the SensorCal (sensor calibration) and ElecCal (sensor electronics calibration) can be restored to factory settings.

Press the input field for **Options** and select the channel the UniCond2e sensor is connected to.

Press the input field for **Item** (Configure button). Select SensorCal to Factory and/or ElecCal to Factory by checking the adjacent box. Press  enter to accept the value.

If an item has been selected the Action menu is displayed. Press the Reset button.

The M800 will bring up the confirmation dialog. Select Yes and the reset will be executed. Press No to go back to menu Reset without performing the reset.

8.13 RS485 Output

PATH:  \ CONFIG \ RS485 Output

This menu option allows measurement values of different channels to be printed or output for data log by external RS485. And the configuration data like printer line, printer interval time and each line's measurement can be set by user.

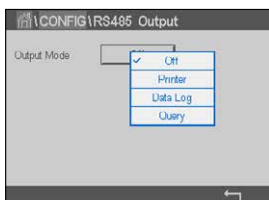

Select the Output Mode, Off, Printer, Data Log or Query.

8.13.1 Printer Output Configuration

The Printer menu option allows configuring the M800 Water PROFINET and EtherNet/IP RS485 output to send data to a suitable printer. The printer output may be configured to print up to 6 configure measurements on separate lines, for each available sensor input. At each print cycle, the output will include a header line with data and time based on the M800 internal clock, and one line for each configured measurement including channel, measurement descriptor, measurement value and unit of measure.

The output will appear as follows:

11/May/2012 15:36

Ch Label Measurement

1 CHAN_1 302 ppbC

2 CHAN_2 0.54 uS/cm

3 CHAN_3 7.15 pH



To configure the printer output, select option Printer for Output Mode. Configure the following options:

Lines to Print will configure the number of measurements that will be printed for each print cycle. Enter the total number of measurements to be configured for output.

Output Time defines the time in minutes between each print cycle. Output time may be set from 1 to 1000 minutes.

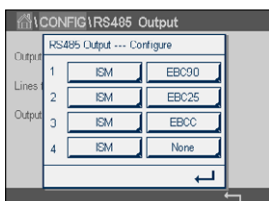

Once the output time and print lines have been established, press the Configure button to format the printer output. The number at the left of the window shows the order in which the lines will appear on the printer output. From the first dropdown, select the channel which the desired sensor is connected. This dropdown will list the labels associated with each channel as configured under Channel Setup. Using the second dropdown, select the unit associated with the measurement to be displayed. Note that if more than 4 lines of output has been selected, use the < and > icons to navigate through the pages to be configured.

8.13.2 Data Log Configuration

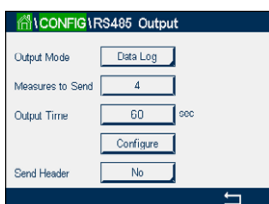

Select option Data Log for Output Mode. Configure the following options:

Measures to Send will configure the number of measurements that will be printed in one line. Enter the total number of measurements to be configured for output.

Output Time defines the interval time in seconds for minutes or outputting a whole line. Maximum time limit is one hour (3600 sec).

If for **Send Header** Yes is chosen, a header will be sent to RS485 port once immediately. Default setting is No.

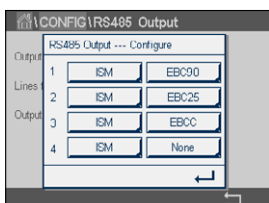

Once the output time and measures to send have been established, press the Configure button to format the output. The number at the left of the window shows the order in which the lines will appear on the output. From the first dropdown, select the channel which the desired sensor is connected. This dropdown will list the labels associated with each channel as configured under Channel Setup. Using the second dropdown, select the unit associated with the measurement to be displayed. Note that if more than 4 lines of output has been selected, use the < and > icons to navigate through the pages to be configured.

8.14 USB Measurement Interface

The user may access measurement values via the USB. The user provides a command and the M800 responds using the following format.

Command: [0x02][0x02]"Dx"(x is the channel index: 1-6)

Response: "XXXXXXXXuuuuuu XXXXXXXXuuuuuu XXXXXXXXuuuuuu XXXXXXXXuuuuuu"<cr>



NOTE: The first instance of 0x02 is the ID for M800, which must be 0x02 only. The second instance of 0x02 is the length, which must be 0x02 only. The response provides M1~M4 only. XXXXXXXX is measurement floating value in ASCII.

uuuuuu is the unit in ASCII, if current unit is less than 6 characters, the format is right aligned, e.g. if unit is pH, response " pH".

<cr> means carriage return (0x0D, 0x0A)

If the sending command is not correct an error message is generated.

Error response format: "ERROR #xx"

xx is the error code

01: Invalid opcode ---- if it is not D.

02: Parameter error ---- if x is not 1-6

07: Length error ---- if length is not 2.

9 ISM

For the menu structure refer to chapter 3.4.1 "Menu Structure".

PATH:  \ ISM

9.1 iMonitor

PATH:  \ ISM \ iMonitor

The iMonitor gives an overview of the current state of the complete loop at a glance.

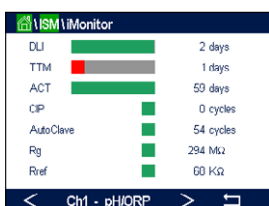

The iMonitor of the first channel is displayed on the screen. To browse through the iMonitor for the different channels press > at the bottom of the display.

The values DLI, TTM and ACT as well as TTCal in combination with UniCond2e sensors are shown as bar graph. If the values falls below 20% of the initial value the bar graph changes from green to yellow color. If the value falls below 10% the color changes to red.

For Cond4e sensors the days in operation of the sensor are displayed.

Furthermore SIP-, CIP-, AutoClave-, SAN-cycles as well as the values for Rg and Rref can be displayed and assigned to a colored button if the values are provided by the sensor.

The color for the related button of SIP-, CIP-, Autoclave- and SAN-cycles will change from green to yellow if less then 20% of the defined maximum quantity for the cycle remain and to red if less then 10% remain. For configuration of the maximum quantity see chapter 8.3 "ISM Setup (ISM Sensors only)".

The buttons for Rg and Rref change to yellow if the conditions for a warning messages are fulfilled and to red if the conditions for a alarm message are fulfilled. The buttons remain grey if the corresponding ISM alarm is not configured (see chapter 8.5 "ISM / Sensor Alarm").

Depending on the measured parameter (connected sensor) the following data are available in the menu iMonitor:

pH:	DLI, TTM, ACT, CIP, AutoClave, SIP*, Rg**, Rref**
Amperometric O ₂ :	DLI, TTM, ACT, CIP, AutoClave, SIP*, Electrolyte****
Optical O ₂ :	DLI, ACT, CIP, AutoClave, SIP*
O ₃ :	DLI, TTM, ACT, SAN
Cond:	Days in operation, TTCal****, CIP, SIP
Turbidity:	Sensor status as humidity, temperature, operating hours, stray light and max. temperature

- * if AutoClave has not been activated (see chapter 8.5 "ISM / Sensor Alarm")
- ** if the alarm for Rg and/or Rref has been activated (see chapter 8.5 "ISM / Sensor Alarm")
- *** if the alarm for Electrolyte Level Error has been activated (see chapter 8.5 "ISM / Sensor Alarm")
- **** if UniCond2e sensor is connected

9.2 Messages

PATH:  \ ISM \ Messages

The messages for occurred warnings and alarms are listed in this menu. Up to 100 entries will be listed.



5 messages per page are listed. If more than 5 messages are available additional pages can be accessed.

Unacknowledged alarms or warning will be listed at the beginning. Then the acknowledged but still existing alarm or warning are listed. At the end of the list the already solved warning and alarms are described. Between these groups the messages are listed chronologically.

The state of the warning or alarm is indicated through the following signs:

Red button blinking	Alarm exists and has not been acknowledged
Red button not blinking	Alarm exists and has been acknowledged
Yellow button blinking	Warning exists and has not been acknowledged
Yellow button not blinking	Warning exists and has been acknowledged
Grey button not blinking	Warning or alarm has been solved

An unacknowledged warning or alarm will be acknowledged by pressing the **Info** button in the corresponding line.

For every message the corresponding **Info** button can be pressed. Message information, date and time the warning or alarm has been occurred and the status of the alarm or message are displayed.

If warning or alarm has already been solved the pull up window for the message shows an additional button to clear the message i.e. to delete it from the message list.

9.3 ISM Diagnostics

PATH:  \ ISM \ ISM Diagnostics

The M800 Water PROFINET and EtherNet/IP Transmitter provides for all ISM sensors a diagnostic menu. Access the menu Channel and select the channel by pressing the related input field.

Depending on the selected channel and assigned sensor different diagnostic menus are displayed. See the following explanation to get more details about the different diagnostic menus.

9.3.1 pH/ORP, Oxygen, O₃ and Cond4e Sensors

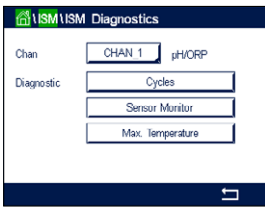

If an pH/ORP, oxygen, O₃ or Cond4e sensor is connected to the selected channel, the diagnostic menu cycles, sensor monitor and max. temperature are available.

Press the **Cycle** button and the information for CIP, SIP and Autoclave cycles of the connected sensor are displayed. The displayed information shows the amount of cycles the sensor has been exposed and the max. limitation for the corresponding cycle as defined in the menu ISM Setup (see chapter 8.3 "ISM Setup (ISM Sensors only)").



NOTE: For Cond4e and optical DO sensors, which are not autoclavable the menu AutoClave Cycles is not displayed.



NOTE: For O₃ sensors the SAN cycles are displayed.

Press the **Sensor Monitor** button and the information for DLI, TTM and ACT of the connected sensor are displayed. The values DLI, TTM and ACT are shown as bar graph. If the values falls below 20% of the initial value the bar graph changes from green to yellow color. If the value falls below 10% the color changes to red.



NOTE: For Optical DO sensors TTM does not exist.



NOTE: For Cond4e sensors the operating hours are displayed.

Press the **Max. Temperature** button and the information about the maximum temperature, that the connected sensor has ever seen, together with a time stamp of this maximum is displayed. This value is stored on the sensor and cannot be changed. During autoclaving the max. temperature is not recorded.



NOTE: For Optical DO sensors the max. temperature of the board and of the spot are displayed.

9.3.2 UniCond2e and UniCond4e Sensors

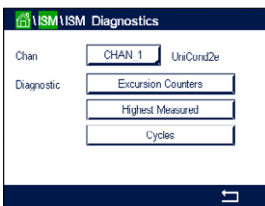

For UniCond2e and UniCond4e sensors, the following diagnostic items can be viewed: Excursion Counters including High Temp and High Conductivity, Highest Measured including Highest Temp and Highest Cond, Cycles including CIP cycles and SIP Cycles.

9.4 Calibration Data

PATH:  \ ISM \ Calibration Data

The M800 Transmitter provides a calibration history for all ISM sensors. Depending on the selected channel and assigned sensor different data is available for the calibration history.

See the following explanation to get more details about the different data available for the calibration history.

9.4.1 Calibration Data for All ISM Sensors excluding UniCond2e and UniCond4e

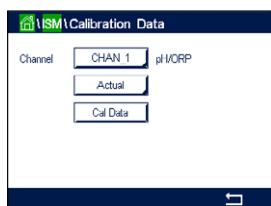

If an ISM sensor – excluding UniCond2e and UniCond2e – is connected to the selected channel between the calibration data set of

Actual (Actual adjustment): This is the actual calibration dataset which is used for the measurement. This dataset moves to Cal1 position after the next adjustment.

Factory (Factory calibration): This is the original dataset, determined in the factory. This dataset remains stored in the sensor for reference and cannot be overwritten.

1.Adjust (First adjustment): This is the first adjustment after the factory calibration. This dataset remains stored in the sensor for reference and cannot be overwritten

Cal1 (last calibration/adjustment): This is the last executed calibration/adjustment data set. This dataset moves to Cal2 and then to Cal3 when a new calibration/adjustment is performed. Afterwards, the dataset is not available anymore. Cal2 and Cal3 acting in the same way as Cal1.

Cal2 and **Cal3** can be chosen. For the selection of the calibration data set press the corresponding field.



NOTE: The amperometric oxygen sensor of THORNTON and the O₃ sensor do not provide the data set Cal1, Cal2, Cal3 and 1.Adjust.

Press the **Cal Data** button and the corresponding calibration data set is displayed. Furthermore the time stamp for the calibration and the User ID is listed.



NOTE: This function requires the correct setting of date and time during calibration and / or adjustment tasks (see chapter 8.8 "System").

9.4.2 Calibration Data for UniCond2e and UniCond4e Sensors

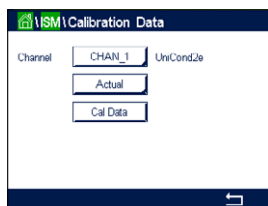

For UniCond2e and UniCond4e sensors the following three sets of calibration data may be selected:

Actual (Actual calibration): This is the actual calibration dataset which is used for the measurement.

Factory (Factory calibration): This is the original dataset, determined in the factory. This dataset remains stored in the sensor for reference and cannot be overwritten.

Cal1 (last calibration/adjustment): This is the last executed calibration/adjustment data set.

Press the Cal Data button and the corresponding calibration data set is displayed.

If the data set of the actual calibration has been chosen, on page 1, the date and time of the calibration, User ID, conductivity calibration constants, and reference conductivity values to calibrate are displayed. On page 2 the As-found conductivity values and the deviation from the reference are shown. On page 3 and 4 the same information for temperature is displayed. On page 5 the calibration cycles applied to the sensor and the next calibration date for conductivity (C) and temperature (T) are displayed.

If the dataset of the factory calibration has been chosen, on page 1, the date and time of the calibration, the conductivity calibration constants, and reference conductivity values used to calibrate are displayed. On page 2, the same values for temperature are shown.

Press ← to exit the menu Cal Data.



NOTE: This function requires the correct setting of date and time during calibration and / or adjustment tasks (see chapter 8.8 "System").

9.5 Sensor Info

PATH: \ ISM \ Sensor Info

The model, hardware and software version, last calibration date as well as the product and serial number of the ISM sensors, that are connected to the M800 Water PROFINET and EtherNet/IP Transmitter can be displayed on the screen.

Enter Sensor Info.

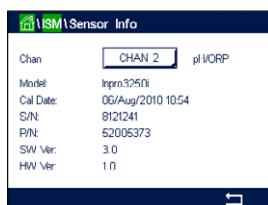

The data of the first channel, a sensor is connected, are displayed on the screen. Press the input field in the line of Chan. To get the data of the desired sensor select the corresponding channel by pressing the according field.

The data Model, Cal Date (date of last adjustment), S/N (serial number), P/N (product number), SW Ver (software version) and HW Ver (hardware version) of the select sensor are displayed.



NOTE: If a UniCond2e sensor is connected the following data is also displayed, Temp Sens. (temperature sensor) Electrode (electrode material), Body/Ins Mat: (body and/or insulator material), Inner: (inner electrode material), Outer (outer electrode material) Fitting: (fitting material), Class VI (FDA Class VI material).

To exit the menu Sensor Info press **←**. To return to the Menu Screen press **🏠**.

9.6 HW / SW Version

PATH: **🏠** \ ISM \ HW/SW Version

The hardware and software version as well as the product number and serial number of the M800 Transmitter itself or the different boards, that are plugged in can be displayed on the screen.



The data of the transmitter is displayed on the screen. Press the input field in the line of **M800**. To select the data of the desired board or the transmitter itself press the corresponding field.

The data S/N (serial number), P/N (product number), SW Ver (software version) and HW Ver (hardware version) of the select board or transmitter are displayed.

9.7 Log Book

PATH: **🏠** \ ISM \ Sensor Info

The M800 Water PROFINET and EtherNet/IP Transmitter provides a log book with 250 entries. The log book is managed as an ring buffer, i.e. entry 251 causes the erasing of entry no. 1 etc.



The entries show time stamp and action.

10 Wizards

PATH:  \ WIZARD

The M800 Water PROFINET and EtherNet/IP Transmitter allows set up of up to 4 wizards / favorites to ensure a quick access for frequently used functions.

10.1 Set Wizard

PATH:  \ WIZARD \ Set Wizard



The main menus are displayed. Choose the menu, that contains the function, which should be defined as a wizard (favorite), e.g. ISM through pressing the corresponding arrow ► in the same line.

Choose the function, that should be set as a wizard by pressing the according button. A function, which is set as a wizard shows ★ icon.

NOTE: To delete the link to wizards, press the according button for the function. The wizard ★ icon is not shown any more.

10.2 Access to Wizards

Access the menu Set Wizards. The wizards defined are listed on this page. Press the corresponding arrow ► for the function in the same line.

11 Maintenance

11.1 Front panel cleaning

Clean the front panel with a damp soft cloth (water only, no solvents). Gently wipe the surface and dry with a soft cloth.

12 Troubleshooting

If the equipment is used in a manner not specified by METTLER TOLEDO, the protection provided by the equipment may be void.

Review the table below for possible causes of common problems:

Problem	Possible Cause
Display is blank.	<ul style="list-style-type: none"> – No power to M800. – Hardware failure.
Incorrect measurement readings.	<ul style="list-style-type: none"> – Sensor improperly installed. – Incorrect units multiplier entered. – Temperature compensation incorrectly set or disabled. – Sensor or transmitter needs calibration. – Sensor or patch cord defective or exceeds recommended maximum length. – Hardware failure.
Measurement readings not stable.	<ul style="list-style-type: none"> – Sensors or cables installed too close to equipment that generates high level of electrical noise. – Recommended cable length exceeded. – Averaging set too low. – Sensor or patch cord defective.
Displayed red or yellow bar graph is flashing.	<ul style="list-style-type: none"> – Setpoint is in alarm condition (setpoint exceeded). – Alarm has been selected (see chapter 8.5 "ISM / Sensor Alarm") and occurred.
Cannot change menu settings.	<ul style="list-style-type: none"> – User locked out for security reasons.

12.1 pH Error messages/Warning- and Alarm list

12.1.1 pH sensors except dual membrane pH electrodes

Warnings	Description
Warning pH Slope >102%	Slope too big
Warning pH Slope <90%	Slope too small
Warning pH Zero \pm 0.5	Out of range
Warning pHGs change <0.3**	Glass electrode resistance changed by more than factor 0.3
Warning pHGs change >3**	Glass electrode resistance changed by more than factor 3
Warning pHRef change <0.3**	Reference electrode resistance changed by more than factor 0.3
Warning pHRef change >3**	Reference electrode resistance changed by more than factor 3

Alarms	Description
Watchdog time-out*	SW/System fault
Error pH Slope >103%	Slope too big
Error pH Slope <80%	Slope too small
Error pH Zero \pm 1	Out of range
Error pH Ref Res >150 K Ω **	Reference electrode resistance too big (break)
Error pH Ref Res <2000 Ω **	Reference electrode resistance too small (short)
Error pH GIs Res >2000 M Ω **	Glass electrode resistance too big (break)
Error pH GIs Res <5 M Ω **	Glass electrode resistance too small (short)

* ISM sensors only

** Activate this function in the transmitter settings (see chapter 8.4 "General Alarm" PATH: Menu / General Alarm).

12.1.2 ORP messages

Warnings*	Description
Warning ORP ZeroPt > 30 mV	Zero offset too big
Warning ORP ZeroPt < -30 mV	Zero offset too small

Alarms*	Description
Watchdog time-out	SW/System fault
Error ORP ZeroPt > 60 mV	Zero offset too big
Error ORP ZeroPt < -60 mV	Zero offset too small

* ISM sensors only

12.2 Amperometric O₂ Error messages/ Warning- and Alarm list

12.2.1 Low level oxygen sensors

Warnings	Description
Warning O ₂ Slope < -460 nA	Slope too big
Warning O ₂ Slope > -250 nA	Slope too small
Warning O ₂ ZeroPt > 0.5 nA	Zero offset too big
Warning O ₂ ZeroPt < -0.5 nA	Zero offset too small

Alarms	Description
Watchdog time-out*	SW/System fault
Error O ₂ Slope < -525 nA	Slope too big
Error O ₂ Slope > -220 nA	Slope too small
Error O ₂ ZeroPt > 1.0 nA	Zero offset too big
Error O ₂ ZeroPt < -1.0 nA	Zero offset too small
Electrolyte Low*	Too low level of electrolyte

* ISM sensors only

12.3 Warning- and Alarm Indication

12.3.1 Warning Indication

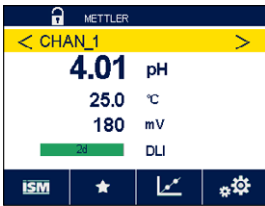

It will be indicated through a yellow bar graph on the display if there are conditions, that have generate a warning. If the corresponding channel is shown on the current Menu Screen or Start Screen (see chapter 3.2 "Display") the yellow bar graph is displayed in the line with the name of the channel. A warning message will be recorded and can be selected through the menu Messages (PATH: \ISM\Messages; see also chapter 9.2 "Messages").



If a channel, that is not shown on the current Menu Screen or Start Screen has generated by a warning, a yellow bar graph is displayed on the head line of the display. A warning message will be recorded and can be selected through the menu Messages (PATH: \ISM\Messages; see also chapter 9.2 "Messages").



NOTE: If the warning has not been acknowledged the bar graph will blink. If the warning has already been acknowledged, the bar graph will be displayed continuously. See also chapter 9.2 "Messages". In the case of an unacknowledged warning or alarm the transmitter screen will not be dimmed or switched off even if the light time has been elapsed (see chapter 8.6 "Display Set-up").



NOTE: If at the same time a channel has born an alarm and a warning indicated, the indication of the alarm will have higher priority. The alarm will be indicated (see chapter 12.3 "Warning- and Alarm Indication") on the Menu Screen or Start Screen, while the warning will not be shown.

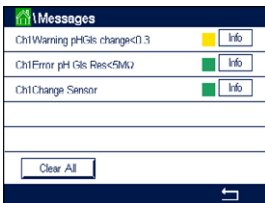

Pressing the yellow bar graph on the Menu Screen will lead to the Messages. Refer to chapter 9.2 "Messages" for the description of the functionality for this menu.



NOTE: The detection of some warnings can be activated/deactivated through (de)activating the corresponding alarm. Refer to chapter 8.5 "ISM / Sensor Alarm".

12.3.2 Alarm Indication

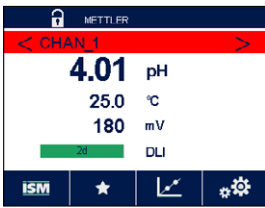

It will be indicated through a red bar graph on the display if there are conditions, that have generated an alarm. If the corresponding channel is shown on the current Menu Screen or Start Screen (see chapter 3.2 "Display") the red bar graph is displayed in the line with the name of the channel. An alarm message will be recorded and can be selected through the menu Messages (PATH: \ISM\Messages; see also chapter 9.2 "Messages").



If a channel, that is not shown on the current Menu Screen or Start Screen has generated by an alarm, a red bar graph is displayed on the head line of the display. An alarm message will be recorded and can be selected through the menu Messages (PATH: \ISM\Messages; see also chapter 9.2 "Messages").



NOTE: If the alarm has not been acknowledged the bar graph will blink. If the alarm has already been acknowledged, the bar graph will be displayed continuously. See also chapter 9.2 "Messages". In the case of an unacknowledged warning or alarm the transmitter screen will not be dimmed or switched off even if the light time has been elapsed (see chapter 8.6 "Display Setup").



NOTE: If at the same time a channel has born an alarm and a warning indicated, the indication of the alarm will have higher priority. The alarm will be indicated (see chapter 12.3 "Warning- and Alarm Indication") on the Menu Screen or Start Screen, while the warning will not be shown.

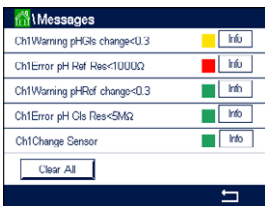

Pressing the red bar graph on the Menu Screen will lead to the Messages. Refer to chapter 9.2 "Messages" for the description of the functionality for this menu.



NOTE: The detection of some alarms can be activated/deactivated. Refer therefore to chapter 8.5 "ISM / Sensor Alarm".



NOTE: Alarms which are caused by a violation of the limitation of a setpoint or the range (PATH: \CONFIG\Set Points; see also chapter 8.2 "Set Points") will also be indicated on the display and recorded through the menu Messages (PATH: \ISM\Messages; see also chapter 9.2 "Messages").

13 Ordering Information

13.1 Transmitter Overview

Transmitter	Order No.
M800 Water 2-CH EIP	30530027
M800 Water 2-CH PN	30530025

13.2 Accessories and Spare Parts

Please contact your local METTLER TOLEDO sales office or representative for details on additional accessories and spare parts.

Description	Order no.
Pipe Mount Kit	52500212
Panel Mount Kit	52500213
Wall Mount Kit	30300482
Protective Hood	30073328

14 Specifications

14.1 General specifications

For sensor specifications of ISM sensors refer to sensor manual.

Conductivity/resistive Specifications for Cond2e/Cond4e Sensors	
Conductivity range	– 2-electrode sensor: 0.02 to 2000 $\mu\text{S/cm}$ (500 Ω 3 cm to 50 M Ω 3 cm) – 4-electrode sensor: 0.01 to 650 mS/cm (1.54 Ω 3 cm to 0.1 M Ω 3 cm)
Display range for 2-e sensor	0 to 40,000 mS/cm (25 Ω \times cm to 100 M Ω \times cm)
Display range for 4-e sensor	0.01 to 650 mS/cm (1.54 Ω \times cm to 0.1 M Ω \times cm)
Chemical concentration curves	NaCl: 0–26% @ 0 °C to 0–28% @ +100 °C NaOH: 0–12% @ 0 °C to 0–16% @ +40 °C to 0–6% @ +100 °C HCl: 0–18% @ –20 °C to 0–18% @ 0 °C to 0–5% @ +50 °C HNO ₃ : 0–30% @ –20 °C to 0–30% @ 0 °C to 0–8% @ +50 °C H ₂ SO ₄ : 0–26% @ –12 °C to 0–26% @ +5 °C to 0–9% @ +100 °C H ₃ PO ₄ : 0–35% @ +5 °C to +80 °C User defined concentration curve table (5x5 matrix)
TDS ranges	NaCl, CaCO ₃
Sensor maximum distance	– ISM: 80 m (260 ft)
Cond/Res resolution	Auto/0.001/0.01/0.1/1, can be selected
Temperature display range	–40 to +200.0 °C (–40 to 392 °F)
Temperature resolution	Auto/0.001/0.01/0.1/1 K (°F), can be selected

pH Specifications	
pH display range	–2.00 to 16.00 pH
Sensor maximum distance	– ISM: 80 m (260 ft)
pH resolution	0.01/0.1/1, can be selected
mV resolution	Auto/0.01/0.1/1 mV
Temperature resolution	Auto/0.001/0.01/0.1/1 K (°F), can be selected

Available Buffer Sets	
Standard buffers	
MT-9 buffers, MT-10 buffers, NIST Technical Buffers, NIST Standard Buffers (DIN 19266:2000–01), JIS Z 8802 buffers, Hach buffers, CIBA (94) buffers, Merck Titrisols-Reidel Fixanals, WTW buffers	
Dual membrane electrodes pH buffers (pH/pNa)	
Mettler-pH/pNa buffers (Na+ 3.9M)	

Specifications for Amperometric Oxygen Sensors	
Max. sensor cable length	– ISM 80 m (260ft)
DO concentration range	0 ppb ($\mu\text{g/l}$) to 10.00 ppm (mg/l)
DO saturation range	0 to 100% air
Resolution	Auto/0.001/0.01/0.1/1, can be selected
Temperature resolution	Auto/0.001/0.01/0.1/1 K ($^{\circ}\text{F}$), can be selected
Temperature compensation	Automatic
Calibration	– 1-point (slope or offset) calibration – Process calibration (slope or offset) calibration

Specifications for Optical Oxygen Sensors	
Sensor maximum distance	50 m (164 ft)
DO concentration range	0 ppb ($\mu\text{g/l}$) to 5.00 ppm (mg/l)
DO saturation range	0 to 100% air, 0 to 100% O_2
Resolution	Auto/0.001/0.01/0.1/1, can be selected
Temperature resolution	Auto/0.001/0.01/0.1/1 K ($^{\circ}\text{F}$), can be selected

14.2 Electrical specifications

Power requirements	100 to 240 V AC or 20 to 30 V DC, 10W, AWG 16–24, 0.2 mm^2 to 1.5 mm^2
Frequency	50/60 Hz
Connection terminals	Spring cage terminals appropriate for AWG 16–24, 0.2 mm^2 to 1.5 mm^2 wires
Digital communication	USB port, Type B connector
Digital inputs	5 with switching limits 0.00 VDC to 1.00 VDC for low level and 2.30 VDC to 30.00 VDC for high level
Mains power fuse	2.0 A slow blow type FC, not replaceable
User interface	Color touch screen 5.7" Resolution 320 \times 240 pixel 256 colors
Max. cable length	80 m (260 ft) for pH, amp. oxygen, Cond4e, ozone 15 m (50 ft) for optical DO, UniCond2e

14.3 Mechanical specifications

Dimensions (housing – H × W × D)*	150 × 158 × 170 mm (5.36" × 6.22" × 6.69")
Front bezel – H × W	150 × 158 mm (5.36" × 6.22")
Max. D – panel mounted	125 mm (4.92")
Weight	1.6 kg (3.5 lb)
Material	Polycarbonate / PC
Ingress rating	IP 66 (when back cover is attached)

* H = Height, W = Width, D = Depth

14.4 Environmental specifications

Storage temperature	–40 to 70 °C (–40 to 158 °F)
Ambient temperature operating range	–20 to 50 °C (–4 to 122 °F)
Relative humidity	0 to 95% non-condensing
Emissions	According to EN 61326 Class A
CE mark	The measuring system is in conformity with the statutory requirements of the EC Directives. METTLER TOLEDO confirms successful testing of the device by affixing to it the CE mark. For CE Declaration of Conformity see supplied CD.
Ratings / Approvals	UL
Altitude, maximum	5,000 m

15 Warranty

METTLER TOLEDO warrants this product to be free from significant deviations in material and workmanship for a period of one year from the date of purchase. If repair is necessary and not the result of abuse or misuse within the warranty period, please return by pre-paid freight and an amendment will be made without any charge. METTLER TOLEDO's Customer Service Dept. will determine if the product problem is due to deviations or customer abuse. Out-of-warranty products will be repaired on an exchange basis at cost.

The above warranty is the only warranty made by METTLER TOLEDO and is in lieu of all other warranties, expressed or implied, including, without limitation, implied warranties of merchantability and fitness for a particular purpose. METTLER TOLEDO shall not be liable for any loss, claim, expense or damage caused by, contributed to or arising out of the acts or omissions of the Buyer or Third Parties, whether negligent or otherwise. In no event shall METTLER TOLEDO's liability for any cause of action whatsoever exceed the cost of the item giving rise to the claim, whether based in contract, warranty, indemnity, or tort (including negligence).

16 Buffer tables

M800 Water PROFINET and EtherNet/IP Transmitters have the ability to do automatic pH buffer recognition. The following tables show different buffers that are automatically recognized.

16.1 Standard pH buffers

16.1.1 Mettler-9

Temp (°C)	pH of buffer solutions			
0	2.03	4.01	7.12	9.52
5	2.02	4.01	7.09	9.45
10	2.01	4.00	7.06	9.38
15	2.00	4.00	7.04	9.32
20	2.00	4.00	7.02	9.26
25	2.00	4.01	7.00	9.21
30	1.99	4.01	6.99	9.16
35	1.99	4.02	6.98	9.11
40	1.98	4.03	6.97	9.06
45	1.98	4.04	6.97	9.03
50	1.98	4.06	6.97	8.99
55	1.98	4.08	6.98	8.96
60	1.98	4.10	6.98	8.93
65	1.98	4.13	6.99	8.90
70	1.99	4.16	7.00	8.88
75	1.99	4.19	7.02	8.85
80	2.00	4.22	7.04	8.83
85	2.00	4.26	7.06	8.81
90	2.00	4.30	7.09	8.79
95	2.00	4.35	7.12	8.77

16.1.2 Mettler-10

Temp (°C)	pH of buffer solutions			
0	2.03	4.01	7.12	10.65
5	2.02	4.01	7.09	10.52
10	2.01	4.00	7.06	10.39
15	2.00	4.00	7.04	10.26
20	2.00	4.00	7.02	10.13
25	2.00	4.01	7.00	10.00
30	1.99	4.01	6.99	9.87
35	1.99	4.02	6.98	9.74
40	1.98	4.03	6.97	9.61
45	1.98	4.04	6.97	9.48
50	1.98	4.06	6.97	9.35
55	1.98	4.08	6.98	
60	1.98	4.10	6.98	
65	1.99	4.13	6.99	
70	1.98	4.16	7.00	
75	1.99	4.19	7.02	
80	2.00	4.22	7.04	
85	2.00	4.26	7.06	
90	2.00	4.30	7.09	
95	2.00	4.35	7.12	

16.1.3 NIST Technical Buffers

Temp (°C)	pH of buffer solutions				
0	1.67	4.00	7.115	10.32	13.42
5	1.67	4.00	7.085	10.25	13.21
10	1.67	4.00	7.06	10.18	13.01
15	1.67	4.00	7.04	10.12	12.80
20	1.675	4.00	7.015	10.07	12.64
25	1.68	4.005	7.00	10.01	12.46
30	1.68	4.015	6.985	9.97	12.30
35	1.69	4.025	6.98	9.93	12.13
40	1.69	4.03	6.975	9.89	11.99
45	1.70	4.045	6.975	9.86	11.84
50	1.705	4.06	6.97	9.83	11.71
55	1.715	4.075	6.97		11.57
60	1.72	4.085	6.97		11.45
65	1.73	4.10	6.98		
70	1.74	4.13	6.99		
75	1.75	4.14	7.01		
80	1.765	4.16	7.03		
85	1.78	4.18	7.05		
90	1.79	4.21	7.08		
95	1.805	4.23	7.11		

16.1.4 NIST standard buffers (DIN and JIS 19266: 2000–01)

Temp (°C)	pH of buffer solutions			
0				
5	1.668	4.004	6.950	9.392
10	1.670	4.001	6.922	9.331
15	1.672	4.001	6.900	9.277
20	1.676	4.003	6.880	9.228
25	1.680	4.008	6.865	9.184
30	1.685	4.015	6.853	9.144
37	1.694	4.028	6.841	9.095
40	1.697	4.036	6.837	9.076
45	1.704	4.049	6.834	9.046
50	1.712	4.064	6.833	9.018
55	1.715	4.075	6.834	8.985
60	1.723	4.091	6.836	8.962
70	1.743	4.126	6.845	8.921
80	1.766	4.164	6.859	8.885
90	1.792	4.205	6.877	8.850
95	1.806	4.227	6.886	8.833



NOTE: The pH(S) values of the individual charges of the secondary reference materials are documented in a certificate of an accredited laboratory. This certificate is supplied with the respective buffer materials. Only these pH(S) values shall be used as standard values for the secondary reference buffer materials. Correspondingly, this standard does not include a table with standard pH values for practical use. The table above only provides examples of pH(PS) values for orientation.

16.1.5 Hach buffers

Buffer values up to 60 °C as specified by Bergmann & Beving Process AB.

Temp (°C)	pH of buffer solutions		
0	4.00	7.14	10.30
5	4.00	60	10.23
10	4.00	7.04	10.11
15	4.00	7.04	10.11
20	4.00	7.02	10.05
25	4.01	7.00	10.00
30	4.01	6.99	9.96
35	4.02	6.98	9.92
40	4.03	6.98	9.88
45	4.05	6.98	9.85
50	4.06	6.98	9.82
55	4.07	6.98	9.79
60	4.09	6.99	9.76

16.1.6 Ciba (94) buffers

Temp (°C)	pH of buffer solutions				
0	2.04	4.00	7.10	10.30	
5	2.09	4.02	7.08	10.21	
10	2.07	4.00	7.05	10.14	
15	2.08	4.00	7.02	10.06	
20	2.09	4.01	6.98	9.99	
25	2.08	4.02	6.98	9.95	
30	2.06	4.00	6.96	9.89	
35	2.06	4.01	6.95	9.85	
40	2.07	4.02	6.94	9.81	
45	2.06	4.03	6.93	9.77	
50	2.06	4.04	6.93	9.73	
55	2.05	4.05	6.91	9.68	
60	2.08	4.10	6.93	9.66	
65	2.07*	4.10*	6.92*	9.61*	
70	2.07	4.11	6.92	9.57	
75	2.04*	4.13*	6.92*	9.54*	
80	2.02	4.15	6.93	9.52	
85	2.03*	4.17*	6.95*	9.47*	
90	2.04	4.20	6.97	9.43	
95	2.05*	4.22*	6.99*	9.38*	

* Extrapolated

16.1.7 Merck Titrisole, Riedel-de-Haën Fixanale

Temp (°C)	pH of buffer solutions				
0	2.01	4.05	7.13	9.24	12.58
5	2.01	4.05	7.07	9.16	12.41
10	2.01	4.02	7.05	9.11	12.26
15	2.00	4.01	7.02	9.05	12.10
20	2.00	4.00	7.00	9.00	12.00
25	2.00	4.01	6.98	8.95	11.88
30	2.00	4.01	6.98	8.91	11.72
35	2.00	4.01	6.96	8.88	11.67
40	2.00	4.01	6.95	8.85	11.54
45	2.00	4.01	6.95	8.82	11.44
50	2.00	4.00	6.95	8.79	11.33
55	2.00	4.00	6.95	8.76	11.19
60	2.00	4.00	6.96	8.73	11.04
65	2.00	4.00	6.96	8.72	10.97
70	2.01	4.00	6.96	8.70	10.90
75	2.01	4.00	6.96	8.68	10.80
80	2.01	4.00	6.97	8.66	10.70
85	2.01	4.00	6.98	8.65	10.59
90	2.01	4.00	7.00	8.64	10.48
95	2.01	4.00	7.02	8.64	10.37

16.1.8 WTW buffers

Temp (°C)	pH of buffer solutions			
0	2.03	4.01	7.12	10.65
5	2.02	4.01	7.09	10.52
10	2.01	4.00	7.06	10.39
15	2.00	4.00	7.04	10.26
20	2.00	4.00	7.02	10.13
25	2.00	4.01	7.00	10.00
30	1.99	4.01	6.99	9.87
35	1.99	4.02	6.98	9.74
40	1.98	4.03	6.97	9.61
45	1.98	4.04	6.97	9.48
50	1.98	4.06	6.97	9.35
55	1.98	4.08	6.98	
60	1.98	4.10	6.98	
65	1.99	4.13	6.99	
70		4.16	7.00	
75		4.19	7.02	
80		4.22	7.04	
85		4.26	7.06	
90		4.30	7.09	
95		4.35	7.12	

16.1.9 JIS Z 8802 buffers

Temp (°C)	pH of buffer solutions			
0	1.666	4.003	6.984	9.464
5	1.668	3.999	6.951	9.395
10	1.670	3.998	6.923	9.332
15	1.672	3.999	6.900	9.276
20	1.675	4.002	6.881	9.225
25	1.679	4.008	6.865	9.180
30	1.683	4.015	6.853	9.139
35	1.688	4.024	6.844	9.102
38	1.691	4.030	6.840	9.081
40	1.694	4.035	6.838	9.068
45	1.700	4.047	6.834	9.038
50	1.707	4.060	6.833	9.011
55	1.715	4.075	6.834	8.985
60	1.723	4.091	6.836	8.962
70	1.743	4.126	6.845	8.921
80	1.766	4.164	6.859	8.885
90	1.792	4.205	6.877	8.850
95	1.806	4.227	6.886	8.833

16.2 Dual membrane pH electrode buffers

16.2.1 Mettler-pH/pNa buffers (Na+ 3.9M)

Temp (°C)	pH of buffer solutions			
0	1.98	3.99	7.01	9.51
5	1.98	3.99	7.00	9.43
10	1.99	3.99	7.00	9.36
15	1.99	3.99	6.99	9.30
20	1.99	4.00	7.00	9.25
25	2.00	4.01	7.00	9.21
30	2.00	4.02	7.01	9.18
35	2.01	4.04	7.01	9.15
40	2.01	4.05	7.02	9.12
45	2.02	4.07	7.03	9.11
50	2.02	4.09	7.04	9.10

For addresses of METTLER TOLEDO Market Organizations please go to:
www.mt.com/pro-MOs



Management System
certified according to
ISO 9001/ISO 14001

METTLER TOLEDO Thornton, Inc.
900 Middlesex Turnpike, Bldg. 8
Tel. +1-781-301-8600
Fax. +1-781-271-0214

Subject to technical changes.
© METTLER TOLEDO Thornton, Inc.
12/2020 Printed in USA. 30530028 DOC EN Rev B

www.mt.com/pro