

# Operation Manual Multi-parameter Transmitter M300





# **Operation Manual Multi-parameter Transmitter M300**



## Content

<b>1</b>	<b>Introduction</b>	<b>9</b>
<b>2</b>	<b>Safety instructions</b>	<b>10</b>
2.1	Definition of equipment and documentation symbols and designations	10
2.2	Correct disposal of the unit	11
<b>3</b>	<b>Unit Overview</b>	<b>12</b>
3.1	M300 1/2 DIN Versions	12
3.2	M300 1/4 DIN Versions	13
3.3	Menu Structure	14
3.4	Display	15
3.5	Operating Elements	16
3.6	Entry of Data	16
3.7	Selection Menus	16
3.8	"Save changes" Dialog	17
3.9	Security Passwords	17
3.10	Graphic Trend Measurement	17
3.10.1	Activation Trend Display Screen	17
3.10.2	Settings for Trend Display Screen	18
3.10.3	Deactivation Trend Display Screen	18
<b>4</b>	<b>Installation instruction</b>	<b>19</b>
4.1	Unpacking and inspection of equipment	19
4.2	Mounting 1/2 DIN Versions	19
4.2.1	Dimensions 1/2 DIN Version	19
4.2.2	Mounting Procedure – 1/2 DIN Version	20
4.2.3	1/2 DIN – Panel Mounting	21
4.2.4	1/2 DIN Version – Wall Mounting	22
4.2.5	1/2 DIN Version – Pipe Mounting	23
4.3	Mounting 1/4 DIN Versions	24
4.3.1	Dimensions 1/4 DIN Versions	24
4.3.2	Mounting Procedure – 1/4 DIN Versions	25
4.4	Electrical Connection	26
4.5	Terminal Definition	27
4.5.1	TB1 terminal definition – all transmitter versions	28
4.5.2	TB2, TB2A and TB2B terminal definition – 2-channel versions	28
4.5.3	TB2, TB2A and TB2B terminal definition – 1-channel versions	29
4.5.4	TB3 and TB4 terminal definition for Conductivity 2-e and Conductivity 4-e – Analog Sensors	29
4.5.5	TB3 and TB4 terminal definition for pH/ORP – Analog Sensors	30
4.5.6	TB3 and TB4 terminal definition for Amperometric Oxygen and Dissolved Ozone – Analog Sensors	31
4.5.7	TB3 and TB4 terminal definition for pH/ORP, Amperometric oxygen, Dissolved Ozone and Conductivity 4-e – ISM Sensors	31
4.5.8	TB3 and TB4 terminal definition for UniCond 2-e and UniCond 4-e – ISM Sensors	32
<b>5</b>	<b>Placing transmitter in, or out, of service</b>	<b>33</b>
5.1	Placing transmitter in service	33
5.2	Placing transmitter out of service	33
<b>6</b>	<b>Calibration</b>	<b>34</b>
6.1	Sensor Calibration	34
6.1.1	Select Channel	34
6.1.2	Select the desired sensor calibration task	34
6.1.3	Terminate Sensor Calibration	35
6.2	Calibration of UniCond 2-e and UniCond 4-e Sensors (ISM Sensors only)	35
6.2.1	Conductivity Calibration of UniCond 2-e and UniCond 4-e Sensors	35
6.2.1.1	One-Point Calibration	37
6.2.1.2	Two-Point Calibration	38
6.2.1.3	Process Calibration	39
6.2.2	Temperature Calibration of UniCond 2-e Sensors and UniCond 4-e Sensors	40
6.2.2.1	One-Point Calibration	40
6.2.2.2	Two-Point Calibration	41
6.3	Calibration of Cond2e Sensors or Cond4e Sensors	43
6.3.1	One-Point Calibration	43
6.3.2	Two-Point Calibration	44
6.3.3	Process Calibration	44

6.4	pH Calibration	45
6.4.1	One-Point Calibration	45
6.4.2	Two-Point Calibration	46
6.4.3	Process Calibration	46
6.5	ORP Calibration of pH Sensors	47
6.6	Calibration of Amperometric Oxygen Sensors	48
6.6.1	One-Point Calibration	48
6.6.2	Process Calibration	49
6.7	Calibration of O <sub>3</sub> Sensors	49
6.7.1	One-Point Calibration	50
6.7.2	Process Calibration	51
6.8	Sensor Verification	52
6.9	UniCond 2-e Electronics Calibration (ISM Sensor only)	52
6.10	Meter Calibration (Analog Sensors only)	53
6.10.1	Resistance (Analog Sensors only)	53
6.10.2	Temperature (Analog Sensors only)	54
6.10.3	Voltage (Analog Sensors only)	55
6.10.4	Current (Analog Sensors only)	56
6.10.5	Rg (Analog Sensors only)	56
6.10.6	Rr (Analog Sensors only)	56
6.11	Analog Output Calibration	57
6.12	Maintenance	57
<b>7</b>	<b>Configuration</b>	<b>58</b>
7.1	Measurement	58
7.1.1	Channel Setup	58
7.1.2	Analog sensor	58
7.1.3	ISM sensor	59
7.1.4	Derived Measurements	60
7.1.4.1	% Rejection measurement	60
7.1.4.2	Calculated pH (Power Plant Applications only)	60
7.1.5	Display Mode	61
7.1.6	Parameter Related Settings	61
7.1.6.1	Conductivity Settings	62
7.1.6.2	pH Settings	63
7.1.6.3	Settings for Oxygen Measurement Based on Amperometric Sensors	64
7.2	Temperature Source (Analog Sensors only)	65
7.3	Analog Outputs	65
7.4	Set Points	66
7.5	ISM Setup (ISM Sensors only)	67
7.5.1	Sensor Monitor	67
7.5.2	CIP Cycle Limit	69
7.5.3	SIP Cycle Limit	69
7.5.4	AutoClave Cycle Limit	70
7.5.5	DLI Stress Adjustment	71
7.5.6	SAN Cycle Parameters	71
7.5.7	Reset Counters for UniCond 2-e Sensors	72
7.5.8	Set Calibration Interval for UniCond 2-e Sensors	72
7.6	General Alarm	72
7.7	ISM / Sensor Alarm	73
7.8	Clean	73
7.9	Display Setup	74
7.10	Digital Inputs	74
7.11	System	75
7.12	PID Controller	76
7.13	Service	80
7.13.1	Set Analog Outputs	80
7.13.2	Read Analog Outputs	80
7.13.3	Set Relay	80
7.13.4	Read Relay	80
7.13.5	Read Digital Inputs	80
7.13.6	Memory	81
7.13.7	Display	81
7.13.8	Calibrate TouchPad	81
7.13.9	Channel Diagnostic	81
7.14	User Management	82

7.15	Reset	82
7.15.1	System Reset	82
7.15.2	Reset Sensor Calibration for UniCond 2-e Sensors	83
7.16	USB Output	83
7.16.1	Printer Output Configuration	84
<b>8</b>	<b>ISM</b>	<b>85</b>
8.1	iMonitor	85
8.2	Messages	86
8.3	ISM Diagnostics	86
8.3.1	pH/ORP, Oxygen, O <sub>3</sub> and Cond4e Sensors	87
8.3.2	UniCond 2-e and UniCond 4-e Sensors	87
8.4	Calibration Data	88
8.4.1	Calibration Data for All ISM Sensors excluding UniCond 2-e and UniCond 4-e	88
8.4.2	Calibration Data for UniCond 2-e and UniCond 4-e Sensors	89
8.5	Sensor Info	89
8.6	HW / SW Version	90
<b>9</b>	<b>Favorites</b>	<b>91</b>
9.1	Set Favorite	91
9.2	Access to Favorites	91
<b>10</b>	<b>Maintenance</b>	<b>92</b>
10.1	Front panel cleaning	92
<b>11</b>	<b>Software History</b>	<b>92</b>
11.1	M300 Process	92
11.2	M300 Water	92
11.3	M300 Water Cond/Res	92
<b>12</b>	<b>Troubleshooting</b>	<b>93</b>
12.1	Conductivity (resistive) Error messages/ Warning- and Alarm list for analog sensors	93
12.2	Conductivity (resistive) Error messages/ Warning- and Alarm list for ISM sensors	94
12.3	pH Error messages/Warning- and Alarm list	94
12.3.1	pH sensors except dual membrane pH electrodes	94
12.3.2	Dual membrane pH electrodes (pH/pNa)	95
12.3.3	ORP messages	95
12.4	Amperometric O <sub>2</sub> Error messages/ Warning- and Alarm list	96
12.4.1	High level oxygen sensors	96
12.4.2	Low level oxygen sensors	96
12.5	Warning- and Alarm Indication	97
12.5.1	Warning Indication	97
12.5.2	Alarm Indication	98
<b>13</b>	<b>Ordering Information, Accessories and Spare Parts</b>	<b>99</b>
<b>14</b>	<b>Specifications</b>	<b>100</b>
14.1	General specifications	100
14.2	Electrical specifications	102
14.3	Environmental specifications	102
14.4	Mechanical specifications	103
<b>15</b>	<b>Warranty</b>	<b>104</b>
<b>16</b>	<b>Buffer tables</b>	<b>105</b>
16.1	Standard pH buffers	105
16.1.1	Mettler-9	105
16.1.2	Mettler-10	106
16.1.3	NIST Technical Buffers	106
16.1.4	NIST standard buffers (DIN and JIS 19266: 2000-01)	107
16.1.5	Hach buffers	107
16.1.6	Ciba (94) buffers	108
16.1.7	Merck Titrisole, Riedel-de-Haën Fixanale	108
16.1.8	WTW buffers	109
16.1.9	JIS Z 8802 buffers	109
16.2	Dual membrane pH electrode buffers	110
16.2.1	Mettler-pH/pNa buffers (Na+ 3.9M)	110





# 1 Introduction

Statement of Intended Use – The M300 is a 4-wire transmitter for analytical measurements with 4 (0) to 20 mA output signal. The M300 is a multi-parameter transmitter for pH/ORP, conductivity, dissolved oxygen and dissolved ozone measurement and available as 1-channel or 2-channel version. It is compatible with analog and ISM sensors.

The M300 transmitter is designed for use in the process industries, in non-hazardous areas.

## M300 parameter fit guide for 1-channel and 2-channel versions

	M300 Process		M300 Water <sup>1)</sup>		M300 Water Cond/Res	
	Analog	ISM	Analog	ISM	Analog	ISM
pH/ORP	•	•	•	•	–	–
pH/pNa	–	•	–	•	–	–
UniCond 2-e	–	•	–	•	–	–
UniCond 4-e	–	•	–	•	–	–
Conductivity 2-e	•	–	•	–	•	–
Conductivity 4-e	•	•	•	•	•	–
Amp. Dissolved oxygen	• / • <sup>2)</sup>	•	– / • <sup>2)</sup>	– / •	–	–
ppm / ppb						
Dissolved Ozone	•	•	•	•	–	–

1) Measured temperatures higher than 100 °C (212 °F) are not displayed.

2) THORNTON High performance dissolved oxygen sensor only

A black & white touch screen conveys measuring data and setup information. The menu structure allows the operator to modify all operational parameters. A menu-lockout feature, with password protection, is available to prevent the unauthorized use of the meter. The M300 Multi-parameter transmitter can be configured to use up to four analog and/or up to four relay outputs for process control.

The M300 Multi-parameter transmitter is equipped with a USB communication interface. This interface provides up- and download capabilities of the transmitter configuration via a Personal Computer (PC).

This description corresponds to the firmware release, version 1.0. Changes are taking place constantly, without prior notification.

## 2 Safety instructions

This manual includes safety information with the following designations and formats.

### 2.1 Definition of equipment and documentation symbols and designations



**WARNING:** POTENTIAL FOR PERSONAL INJURY.



**CAUTION:** Possible instrument damage or malfunction.



**NOTE:** Important operating information.



On the transmitter or in this manual text indicates: Caution and/or other possible hazard including risk of electric shock (refer to accompanying documents).

The following is a list of general safety instructions and warnings. Failure to adhere to these instructions can result in damage to the equipment and/or personal injury to the operator.

- The M300 Transmitter should be installed and operated only by personnel familiar with the transmitter and who are qualified for such work.
- The M300 Transmitter must only be operated under the specified operating conditions (see chapter 14 “Specifications”).
- Repair of the M300 Transmitter must be performed by authorized, trained personnel only.
- With the exception of routine maintenance, cleaning procedures, as described in this manual, the M300 Transmitter must not be tampered with or altered in any manner.
- Mettler-Toledo accepts no responsibility for damage caused by unauthorized modifications to the transmitter.
- Follow all warnings, cautions, and instructions indicated on and supplied with this product.
- Install equipment as specified in this instruction manual. Follow appropriate local and national codes.
- Protective covers must be in place at all times during normal operation.
- If this equipment is used in a manner not specified by the manufacturer, the protection provided by it against hazards may be void.



**WARNINGS:**

- Installation of cable connections and servicing of this product require access to shock hazard voltage levels.
- Main power and relay contacts wired to a separate power source must be disconnected before servicing.
- Switch or circuit breaker shall be in close proximity to the equipment and within easy reach of the OPERATOR; it shall be marked as the disconnecting device for the equipment.
- Main power must employ a switch or circuit breaker as the disconnecting device for the equipment.
- Electrical installation must be in accordance with the National Electrical Code and/or any other applicable national or local codes.

**NOTE: RELAY CONTROL ACTION**

the M300 Transmitter relays will always de-energize on loss of power, equivalent to normal state, regardless of relay state setting for powered operation. Configure any control system using these relays with fail-safe logic accordingly.

**NOTE: PROCESS UPSETS**

Because process and safety conditions may depend on consistent operation of this transmitter, provide appropriate means to maintain operation during sensor cleaning, replacement, or sensor or instrument calibration.

**NOTE:** This is a 4-wire-product with an active 4–20 mA analog output.

Do not supply power to the analog output terminals (TB2: terminal 1 to 8, TB2A: terminal 1 to 4 and TB2B: terminal 1 to 4).

## 2.2 Correct disposal of the unit

When the transmitter is finally removed from service, observe all local environmental regulations for proper disposal.

### 3 Unit Overview

The M300 transmitter is available as 1/2 DIN and 1/4 DIN version.

For dimensions refer to 13 "Ordering Information, Accessories and Spare Parts".

#### 3.1 M300 1/2 DIN Versions

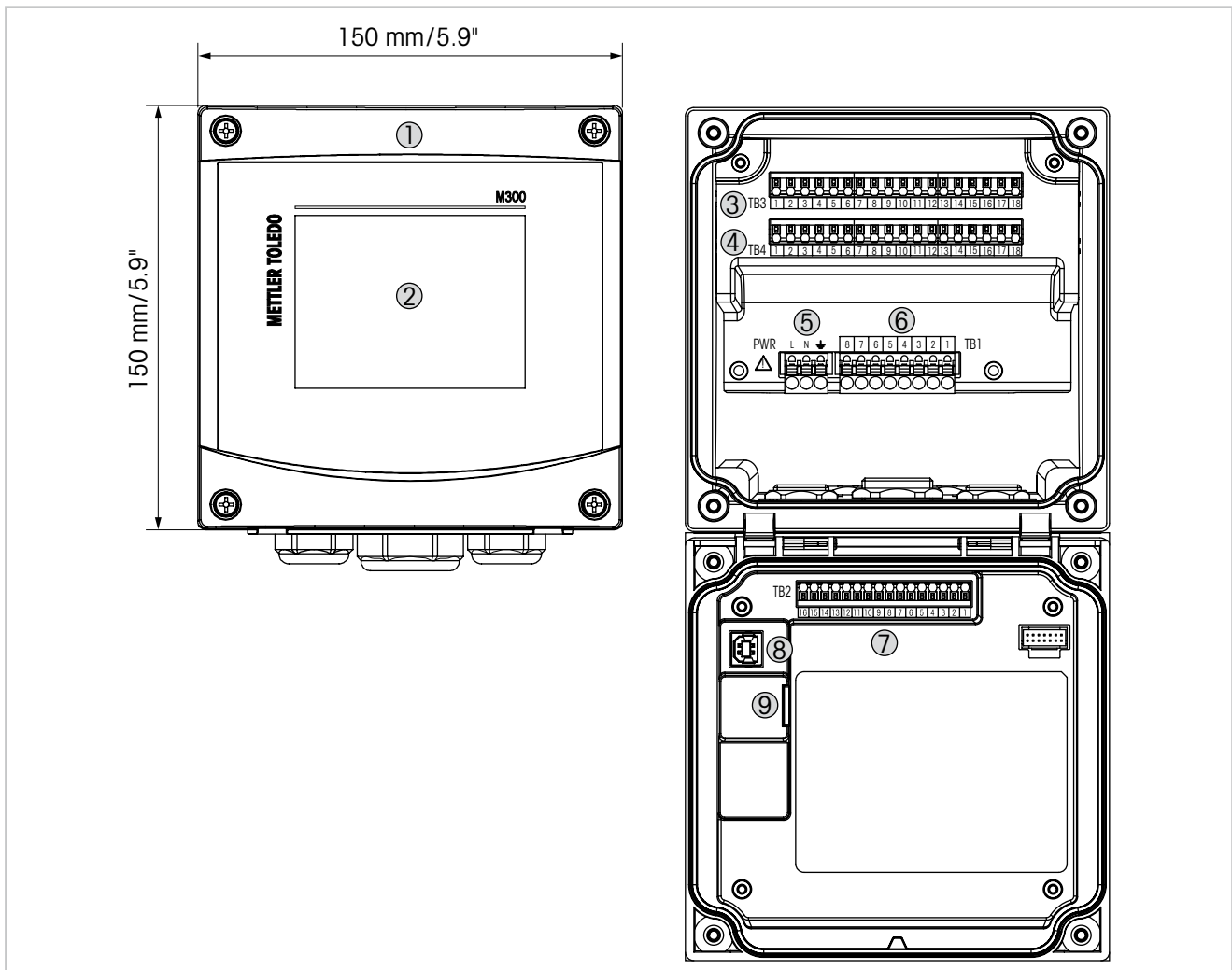

### 3.2 M300 1/4 DIN Versions

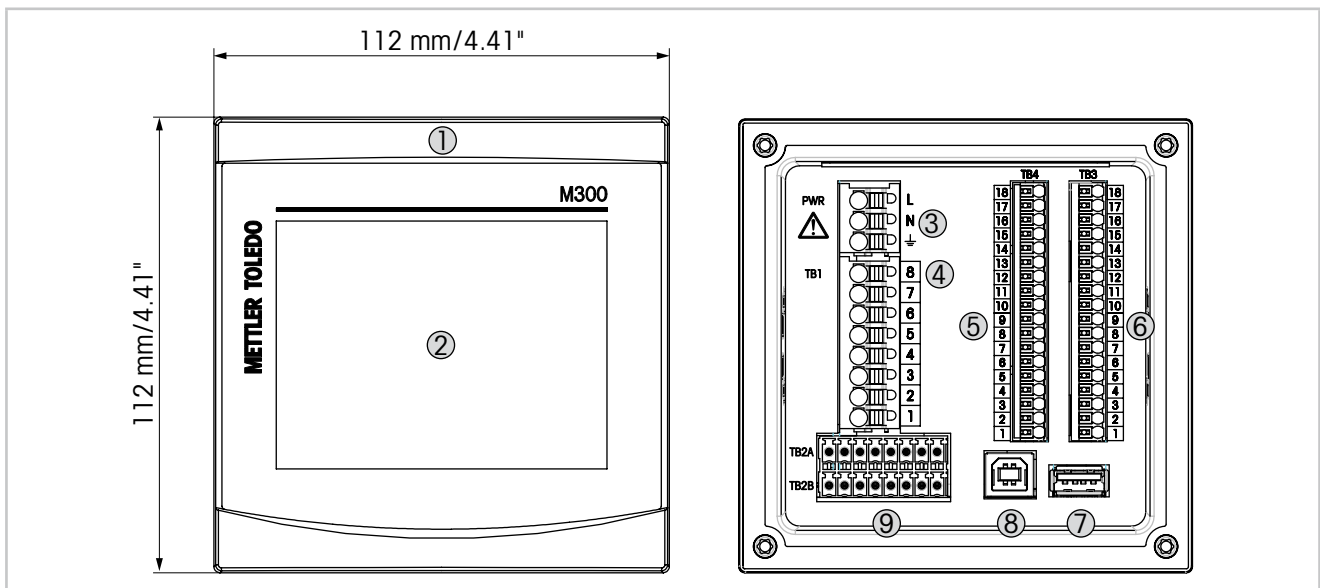

Fig. 2: M300 1/4 DIN versions

- 1 Hard Polycarbonate case
- 2 Black & White touchscreen
- 3 Terminals for supply voltage
- 4 TB1 – Terminal block for relay outputs
- 5 TB4 – Terminal block for sensor connection, for 2-channel versions only
- 6 TB3 – Terminal block for sensor connection
- 7 USB Host – Printer connection, data logging <sup>1)</sup>, loading and saving configuration <sup>1)</sup>
- 8 USB Device – Software update interface
- 9 TB2A, TB2B – Terminal block for analog output and digital input signals

1) In preparation

### 3.3 Menu Structure

Below is the structure of the M300 menu tree:

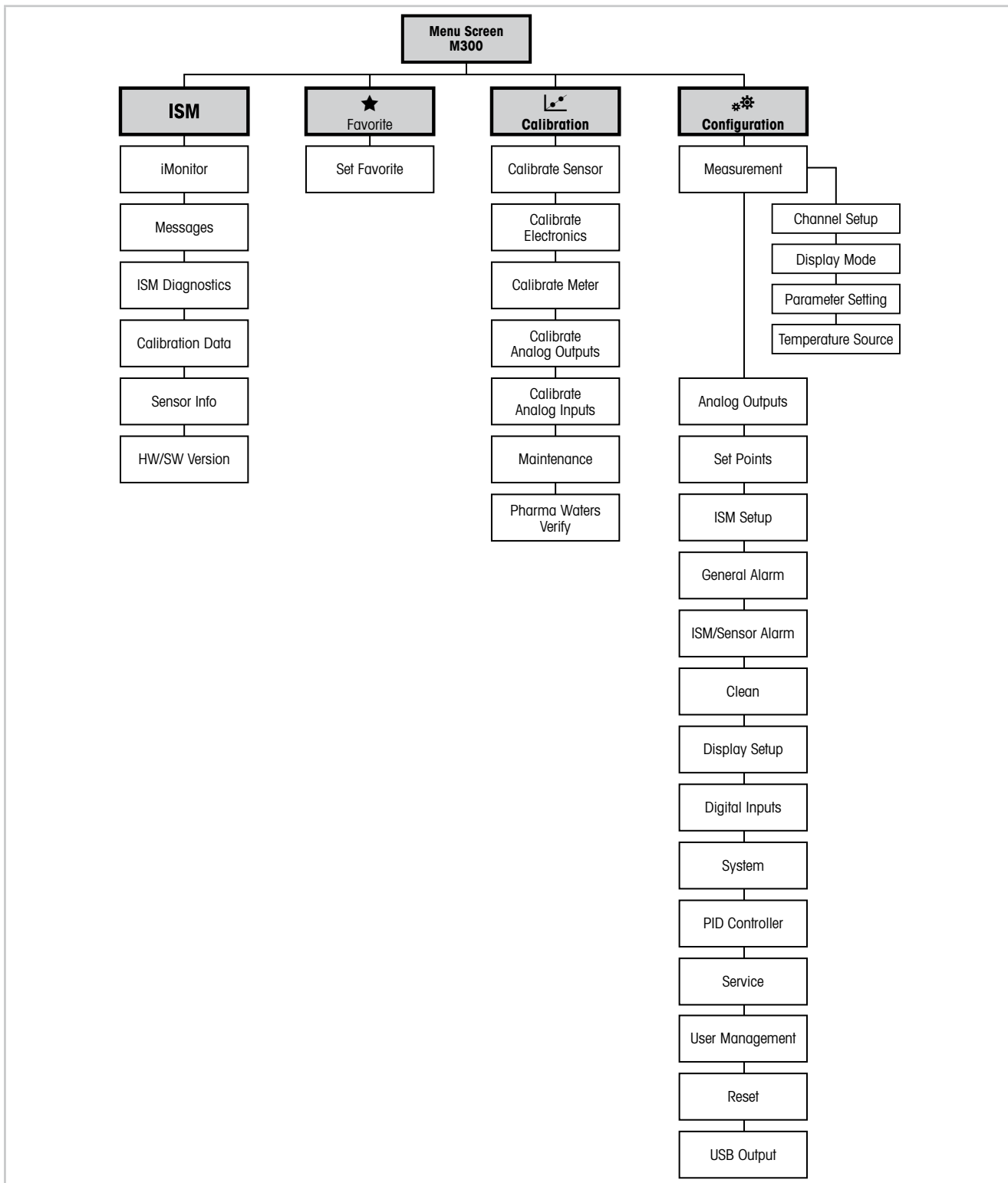

Fig. 3: Menu overview

## 3.4 Display

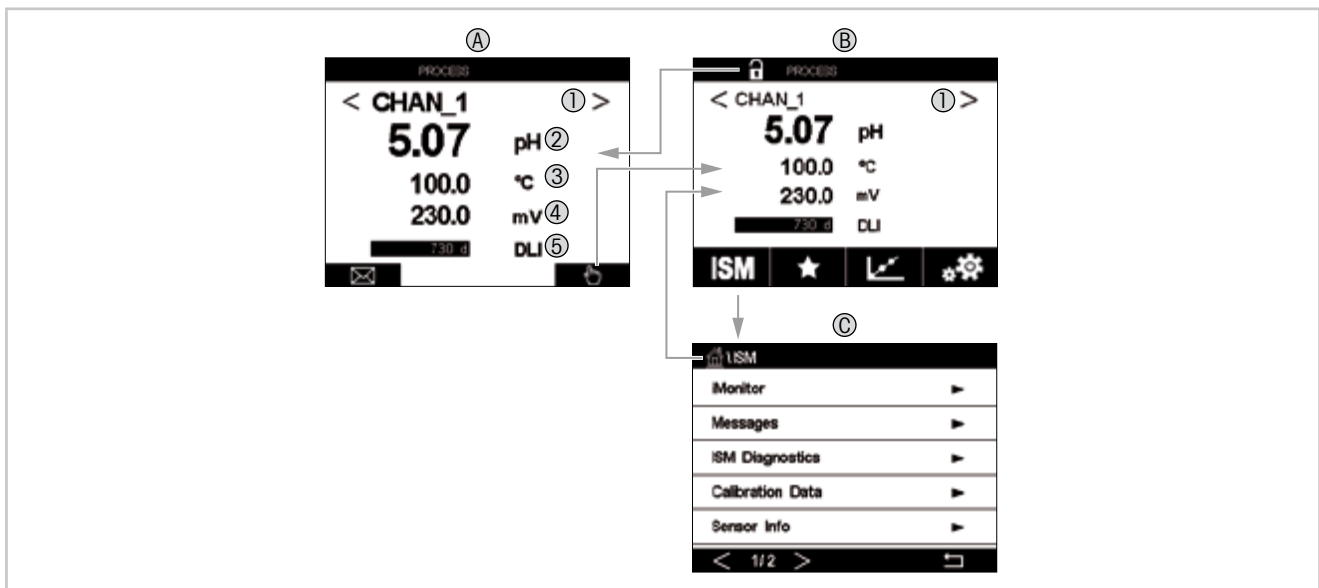

Fig. 4: M300 Display, navigation

### A Start screen (example)

- 1 Changing between channel 1 and channel 2, only 2-channel versions
- 2 1st line, standard configuration
- 3 2nd line, standard configuration
- 4 3rd line, depends on configuration
- 5 4th line, depends on configuration

### B Menu screen (example)

### C ISM Menu screen













**NOTE:** In the event of an alarm or other error conditions the M300 Transmitter will display a symbol in the head line of the display. This head line is blinking until the condition that caused it has been cleared (see chapter 12.5 "Warning- and Alarm Indication").



**NOTE:** During calibrations, clean, Digital In with Analog Output/Relay/USB in HOLD state, a flashing "H" (HOLD) will appear in the upper right corner of the display for the corresponding channel. This symbol will remain for 20 sec., after end of calibration. This symbol will remain for 20 seconds until after the calibration or clean is completed. This symbol will also disappear when Digital In is deactivated.

### 3.5 Operating Elements

Operating element	Description
	Enter Messages menu
	Enter Menu screen
	Enter Start screen
<b>ISM</b>	Enter ISM menu
	Enter Favorite menu
	Enter Calibration menu
	Enter Configuration menu
	Return to Menu screen
	Enter next-lower menu level, here e.g. iMonitor, Messages or ISM Diagnostics
	Return to next-higher menu level
	<ul style="list-style-type: none"> <li>• Change between pages within one menu level</li> <li>• Change between channel 1 and channel 2, only 2-channel versions</li> </ul>
	Confirm values and selected options. Press ESC and the changes are not stored.

### 3.6 Entry of Data

The M300 displays a keypad for modifying values. Press the  button and the transmitter will store the value. Press the ESC button to exit the keypad without changing data.



**NOTE:** For some values, the units can be modified. In this case the keypad shows a button with a U. To select another unit for the entered value on the keypad press the U button. To return again press the 0–9 button.



**NOTE:** For some entries letters and/or numbers can be used. In this case the keypad shows a button 'A,a,0'. Press this button to change between capital letters, small letters and numbers on the keypad.

### 3.7 Selection Menus

Some menus require a selection of a parameter / data. In this case the transmitter displays a pop up window. Press the according field to select the value. The pop-up window will be closed and the selection will be stored.



### 3.8 "Save changes" Dialog

If the M300 brings up the "Save changes" dialog there are the following options. No will discard the entered values, Yes will save changes made and Cancel will bring you back to continue configuring.

### 3.9 Security Passwords

The M300 Transmitter allows a security lock-out of various menus. If the security lock-out feature of the transmitter has been enabled, a security password must be entered to allow access to the menu. See chapter 7.14 "User Management".

### 3.10 Graphic Trend Measurement

Any single measurement may be displayed as a trend measurement over time. Measurement values will be indicated by a value on the Y-axis and time elapsed on the X-axis of the graph displayed. An actual measurement for the selected value will also be displayed numerically above the graphic trend display. The measurement value is refreshed once per second.

Graphic trending will only display the data within maximum/minimum range. Out of range values or invalid values will not be displayed. The Y-axis will display the maximum value unit with its range; X-axis unit uses "mins" for minutes for measurements less than one hour and "hrs" for one day. 4 scales for X/Y-axis. The maximum value on Y-axis is one decimal place.

#### 3.10.1 Activation Trend Display Screen

While the M300 displays the Menu Screen, touch any measurement value line (1-chan, 2-chan, 4-meas) of the display screen once to activate the trend display for that measurement.

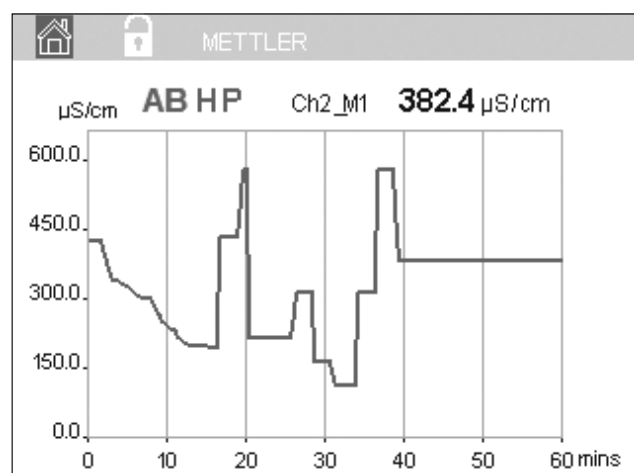

If a sensor is disconnected/connected a pop-up window come up; after closing the window, it will go back to the Menu Screen.

The top line will display for any message occurring during trending. "H", "P", "AB" will display when this channel is in hold or process.

### 3.10.2 Settings for Trend Display Screen

For setting configurations, touch any area of the graphic trend display to go to the pop-up window of this measurement parameter. Settings are at the default values. However, these settings may be changed when options are available, as needed.

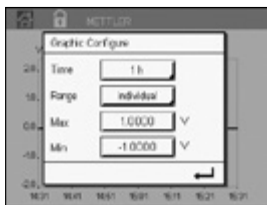

**Time:** Option button. For graphic display time (X-axis)  
1-h (default value)  
1-day

**NOTE:** 1 h means: 1 meas storage/15 seconds, totally 240 measurements for 1 h. 1 day means: 1 meas storage/6 minutes, totally 240 measurements for 1 day;

**Range:** Option button  
Default(default value)  
Individual

When "Default" modes are set for the maximum or minimum value, this indicates the full measurement range for this unit. A Max or Min button is not displayed. If setting is selectable, the user can set maximum and minimum settings manually.

**Max:** Edit button.  
Maximum value of this unit on Y-axis. xxxxxx, floating decimal point.

**Min:** Edit button.  
Minimum value of this unit on Y-axis. xxxxxx, floating decimal point.  
Max Value > Min Value



**NOTE:** Settings for Y-and Y-axis and the corresponding measurement values are stored the transmitters memory. A power down returns to default settings.

### 3.10.3 Deactivation Trend Display Screen

Press  in activated graphic trend screen to return to Menu Screen.



**NOTE:** If a sensor is disconnected/connected a pop-up window come up; after closing the window, it will go back to the Menu Screen.

## 4 Installation instruction

### 4.1 Unpacking and inspection of equipment

Inspect the shipping container. If it is damaged, contact the shipper immediately for instructions. Do not discard the box.

If there is no apparent damage, unpack the container. Be sure all items shown on the packing list are present.

If items are missing, notify Mettler-Toledo immediately.

### 4.2 Mounting 1/2 DIN Versions

#### 4.2.1 Dimensions 1/2 DIN Version

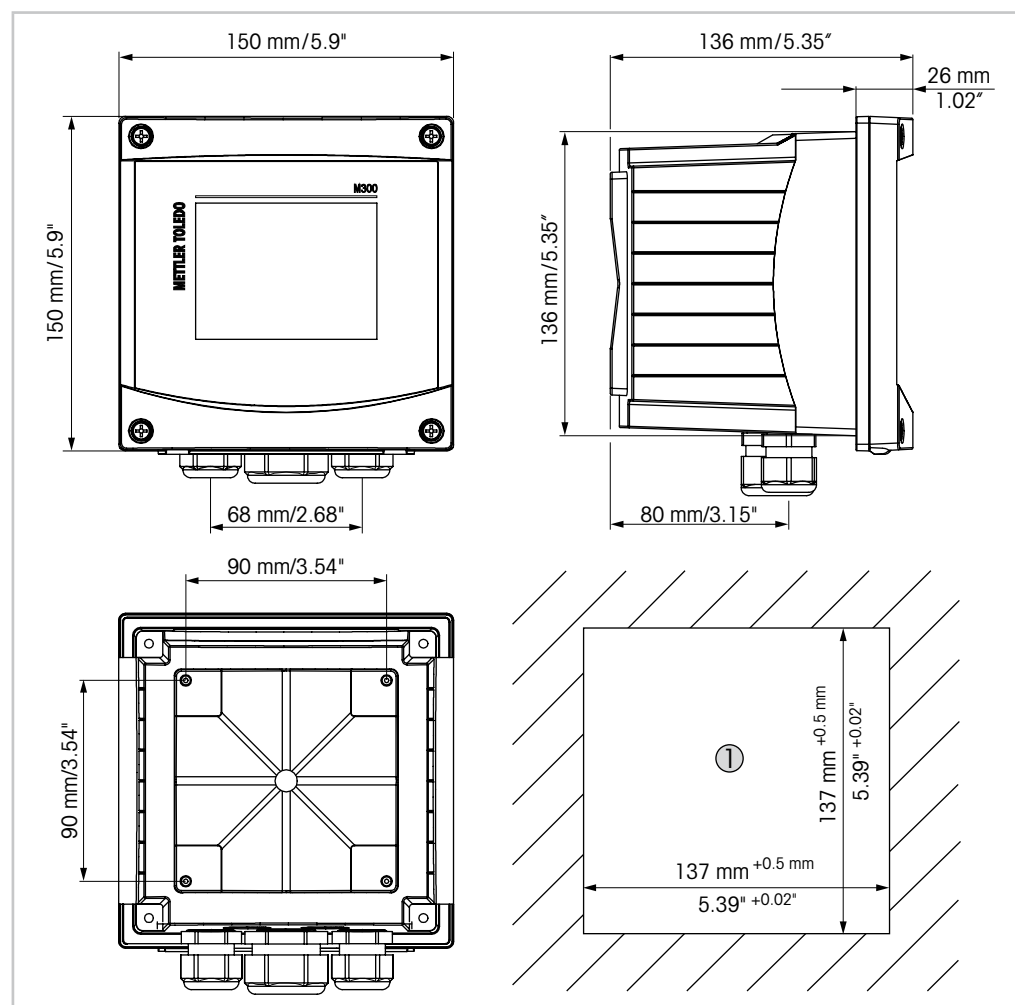

Fig. 5: Dimensions 1/2 DIN version

1 Dimensions for panel cutout

## 4.2.2 Mounting Procedure – 1/2 DIN Version

1/2 DIN versions transmitters are designed for the following mounting versions: panel mount, wall mount or pipe mount. For wall mount the integral rear cover is used.

Optional hardware accessories are available that allow for panel- or pipe-mount. Refer to section 13 "Ordering Information, Accessories and Spare Parts".

### Assembly:

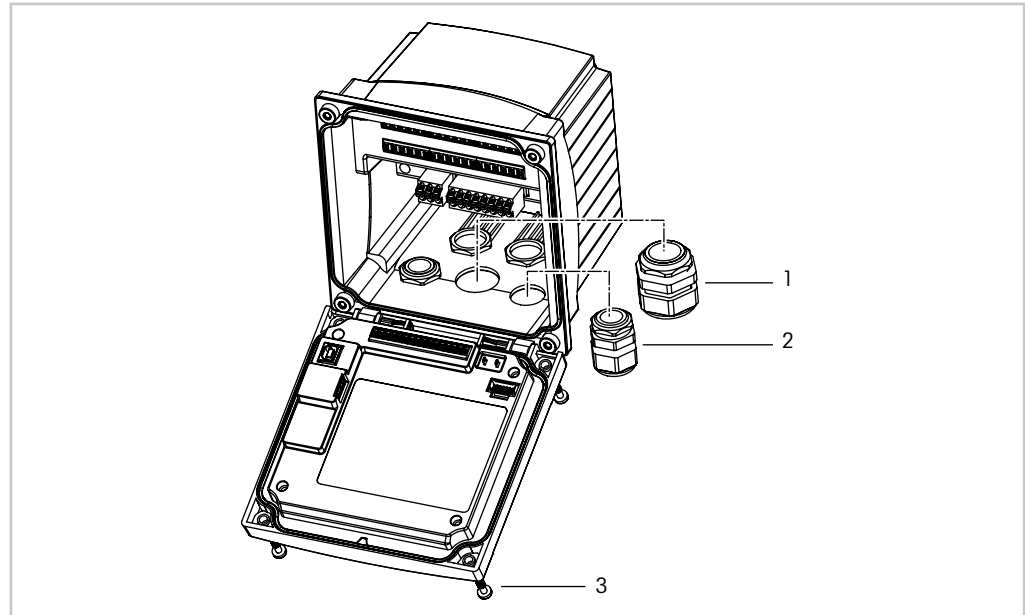

Fig. 6: Assembly

- 1 1 piece M25 x 1.5 cable gland
- 2 4 pieces M20 x 1.5 cable glands
- 3 4 pieces screws

### General:

- Orient the transmitter so that the cable grips face downward.
- Wiring routed through the cable grips shall be suitable for use in wet locations.
- In order to provide IP65 enclosure ratings, all cable glands must be in place. Each cable gland must be filled using a cable.
- Tighten the screws of the front panel with a tightening torque of 1.5 Nm to 2 Nm.

### 4.2.3 1/2 DIN – Panel Mounting

To insure a good seal, the panel or door must be flat and have a smooth finish. Textured or rough surfaces are not recommended and may limit the effectiveness of the gasket seal provided.

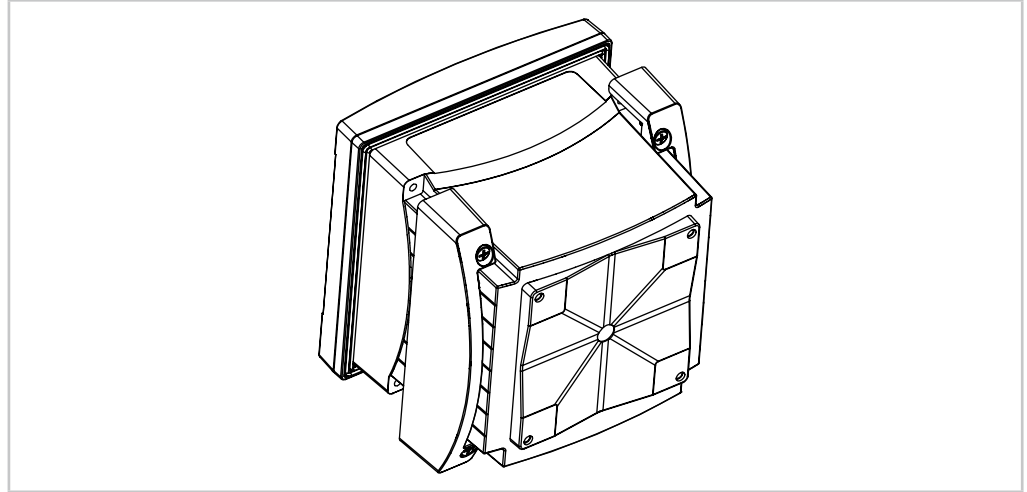

Fig. 7: Panel mounting

1. Make cutout in panel. For dimensions refer to 4.2.1 "Dimensions 1/2 DIN Version".
  - Be sure surface surrounding cutout is clean, smooth and free of burrs.
2. Slide face gasket around transmitter from the back of the unit.
3. Place transmitter into cutout hole. Be sure there are no gaps between the transmitter and panel surface.
4. Place the two mounting brackets on either side of the transmitter as shown.
5. While holding transmitter firmly into the cutout hole, push the mounting brackets toward the backside of panel.
6. Once secure, use a screwdriver to tighten the brackets against the panel. In order to provide IP65 environmental enclosure rating, the two clamps provided shall be securely tightened to create an adequate seal between the panel enclosure and transmitter.
  - Face gasket will compress between transmitter and panel.

#### 4.2.4 1/2 DIN Version – Wall Mounting



**DANGER! Mortal danger by electric shock or risk of electrical shock:** The maximum screw-in depth of the mounting holes in the housing is 12 mm (0.47 inch). Do not exceed maximum screw-in depth.

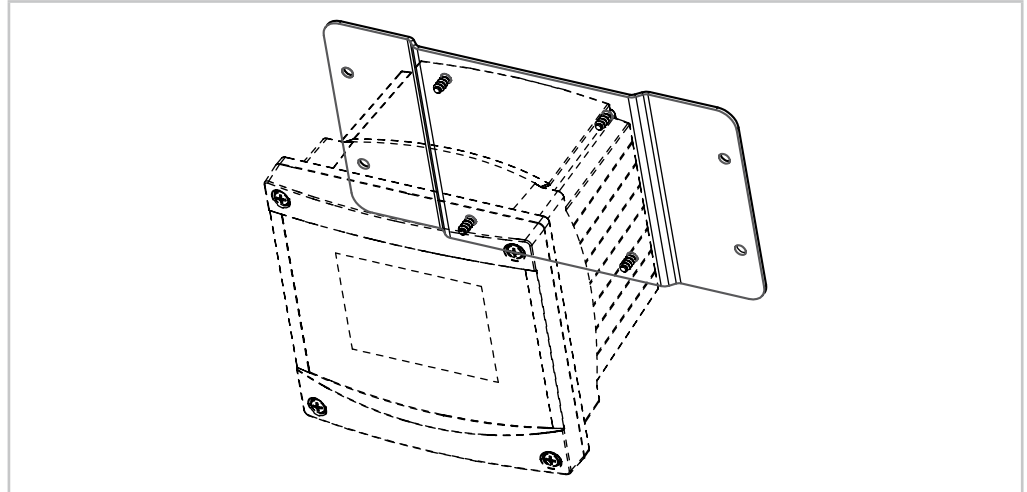

Fig. 8: Wall mounting with wall mounting kit

1. Mount wall mounting kit to the housing. Do not exceed maximum screw-in depth.
2. Mount wall mounting kit with the housing to the wall.  
Attach to wall using appropriate mounting hardware for wall surface. Be sure it is level and securely fastened and the installation adheres to any and all clearance dimensions required for transmitter service and maintenance. Orient the transmitter so that the cable grips are facing downward.

### 4.2.5 1/2 DIN Version – Pipe Mounting

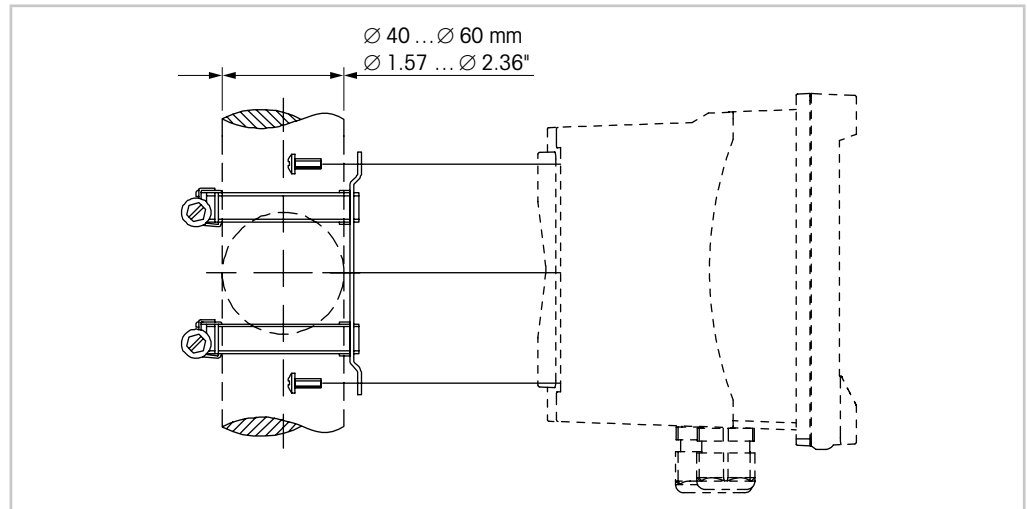

Fig. 9: Pipe mounting 1/2 DIN version

- Use only manufacturer-supplied components for pipe-mounting the M300 transmitter. See section 13 "Ordering Information, Accessories and Spare Parts" for ordering information.
- Tighten the fixing screws with a tightening torque of 2 to 3 Nm.

### 4.3 Mounting 1/4 DIN Versions

#### 4.3.1 Dimensions 1/4 DIN Versions

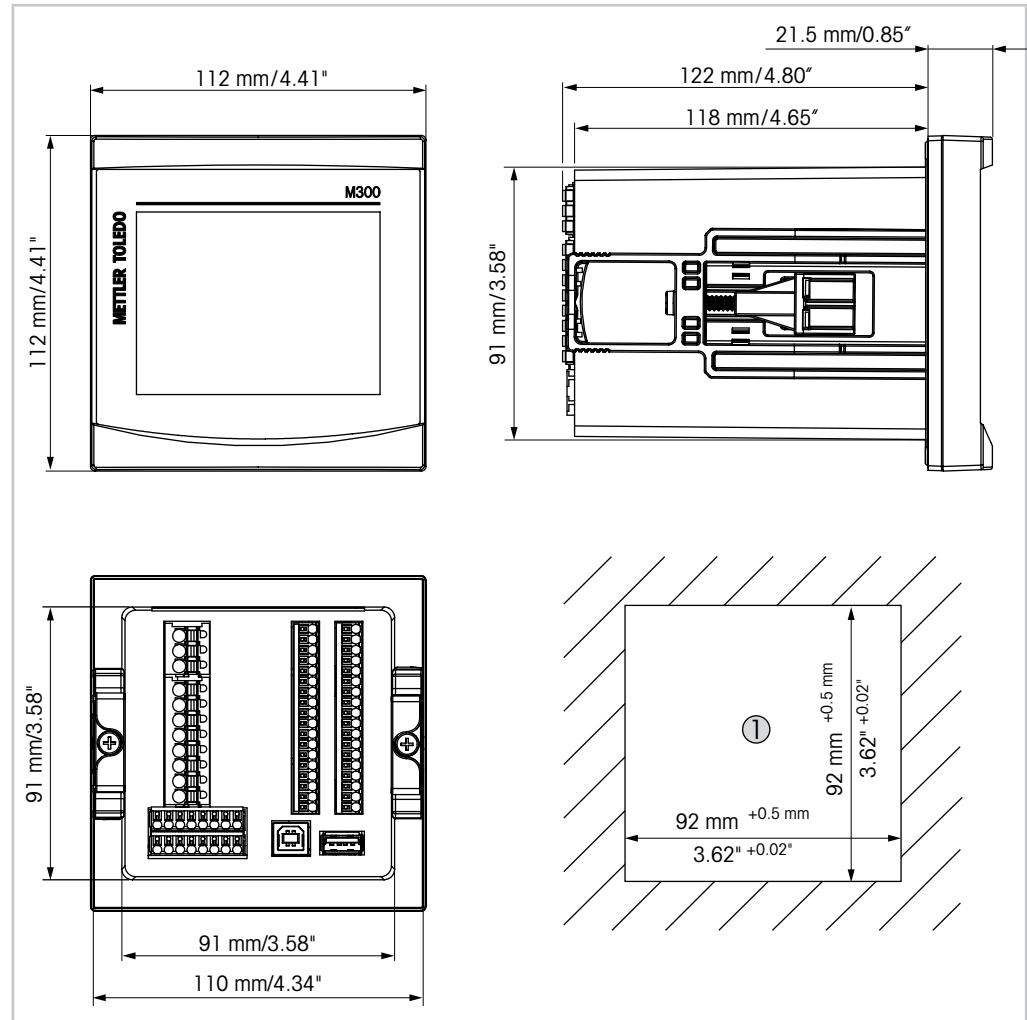

Fig. 10: Dimensions 1/4 DIN version

1 Dimensions for panel cutout



### 4.3.2 Mounting Procedure – 1/4 DIN Versions

1/4 DIN versions are designed for panel-mount installation only. Each transmitter is supplied with mounting hardware to provide fast and simple installation to a flat panel or flat enclosure door. To insure a good seal and maintain IP65 integrity of installation, the panel or door must be flat and have a smooth finish.

The supplied hardware consists of:

- Two pieces snap-on mounting brackets
- One piece mounting gasket seal

1. Make cutout in panel. For dimensions refer to 4.3.1 "Dimensions 1/4 DIN Versions".
  - Be sure surface surrounding cutout is clean, smooth and free of burrs.
2. Slide face gasket around transmitter from the back of the unit.
3. Place transmitter into cutout hole. Be sure there are no gaps between the transmitter and panel surface.
4. Place the two mounting brackets on either side of the transmitter as shown.
5. While holding transmitter firmly into the cutout hole, push the mounting brackets toward the backside of panel.
6. Once secure, use a screwdriver to tighten the brackets against the panel. In order to provide IP65 environmental enclosure rating, the two clamps provided shall be securely tightened to create an adequate seal between the panel enclosure and M300 front face.
  - Face gasket will compress between transmitter and panel.



**CAUTION:** Do not over tighten brackets.

## 4.4 Electrical Connection



**DANGER! Mortal danger by electric shock:** Power off instrument during electrical connection.



**NOTE:** This is a 4-wire-product with an active 4–20 mA analog output.  
Do not supply power to the analog output terminals (TB2: terminal 1 to 8,  
TB2A: terminal 1 to 4 and TB2B: terminal 1 to 4).

The terminals are placed inside the housing.

All M300 transmitters are designed to operate from a 20 to 30 V DC or a 80 to 255 V AC power source. Refer to specifications for power requirements and ratings and size power wiring accordingly.

The terminals are suitable for single wires and flexible leads with a wire cross-section from 0.2 mm<sup>2</sup> up to 1.5 mm<sup>2</sup>, (16–24 AWG).

1. For 80 to 255 V AC supply voltage connect mains supply To terminals L, N, and ↓ (Ground).  
For 20 to 30 V DC supply voltage connect neutral wire (–) to terminal “N” and load (+) to terminal “L”.
2. 1-channel version: Connect sensor to terminal block TB3.  
2-channel version: Connect sensor either to terminal block TB3 or TB4.
3. Connect analog output and digital input signals to terminal block TB2 (TB2A, TB2B).
4. Connect relay output signals to terminal block TB1.

## 4.5 Terminal Definition

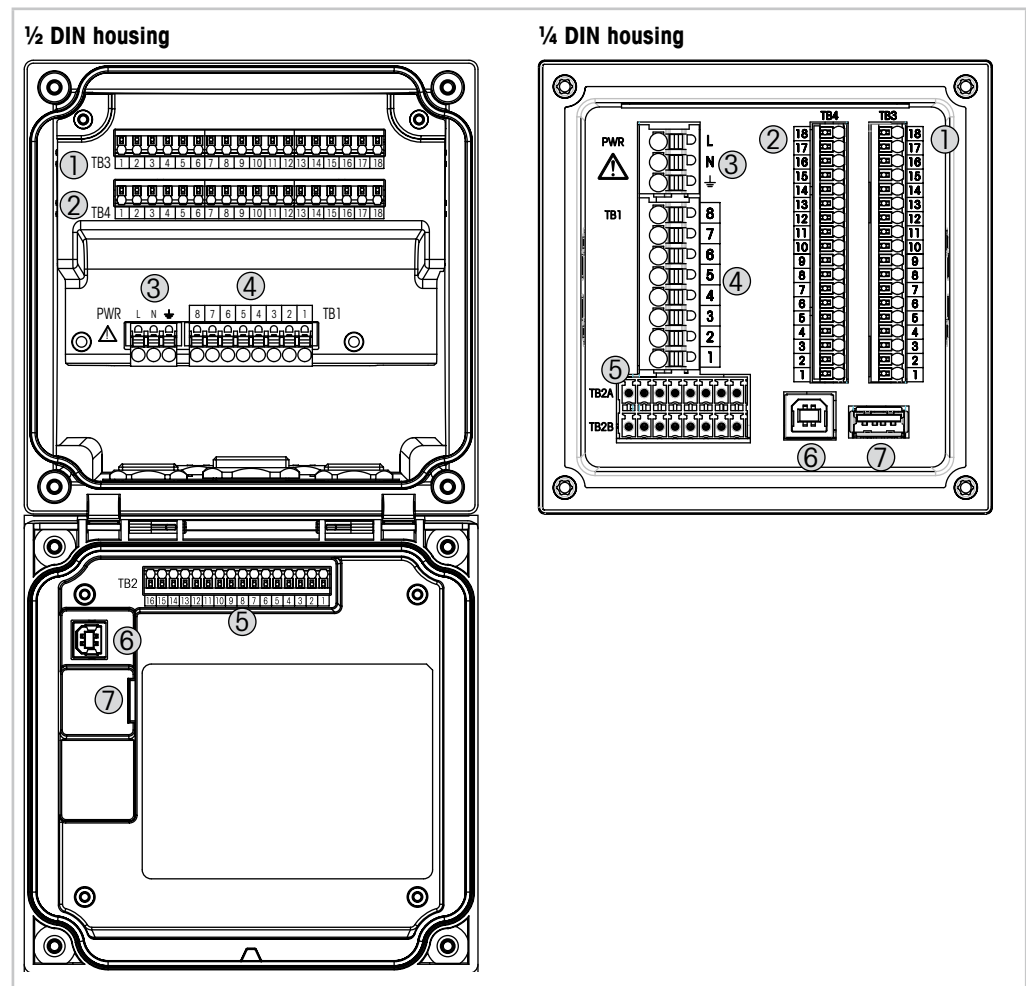

Fig. 11: Terminal block definition

- 1 TB3 – Terminal block for sensor connection
- 2 TB4 – Terminal block for sensor connection, for 2-channel versions only
- 3 Terminals for supply voltage
- 4 TB1 – Terminal block for relay outputs
- 5 TB2 (TB2A, TB2B) – Terminal block for analog output and digital input signals
- 6 USB Device – Software update interface
- 7 USB Host – Printer connection, data logging <sup>1)</sup>, loading and saving configuration <sup>1)</sup>

1) In preparation

### 4.5.1 TB1 terminal definition – all transmitter versions

Terminal TB1	Description	Contact rating
1	NC1	250 V AC or 30 V DC, 3 A
2	COM1	
3	NO2	250 V AC or 30 V DC, 3 A
4	COM2	
5	NO3	250 V AC or DC, 0.5 A, 10 W
6	COM3	
7	NO4	250 V AC or DC, 0.5 A, 10 W
8	COM4	

### 4.5.2 TB2, TB2A and TB2B terminal definition – 2-channel versions



**NOTE:** This is a 4-wire-product with an active 4–20 mA analog output.

Do not supply power to the analog output terminals (TB2: terminal 1 to 8, TB2A: terminal 1 to 4 and TB2B: terminal 1 to 4).

TB2 – ½ DIN housing		TB2A – ¼ DIN housing		TB2B – ¼ DIN housing	
Terminal TB2	Description	Terminal TB2A	Description	Terminal TB2A	Description
1	A01+	1	A01+	1	A01–
2	A01–	2	A02+	2	A02–
3	A02+	3	A03+	3	A03–
4	A02–	4	A04+	4	A04–
5	A03+	5	DI1+	5	DI1–
6	A03–	6	DI2+	6	DI2–
7	A04+	7	–	7	–
8	A04–	8	–	8	–
9	DI1+				
10	DI1–/DI2–				
11	DI2+				
12 to 16	Not used				

### 4.5.3 TB2, TB2A and TB2B terminal definition – 1-channel versions



**NOTE:** This is a 4-wire-product with an active 4–20 mA analog output.  
Do not supply power to the analog output terminals (TB2: terminal 1 to 8, TB2A: terminal 1 to 4 and TB2B: terminal 1 to 4).

TB2 – ½ DIN housing		TB2A – ¼ DIN housing		TB2B – ¼ DIN housing	
Terminal	Description	Terminal	Description	Terminal	Description
<b>TB2</b>		<b>TB2A</b>		<b>TB2A</b>	
1	A01+	1	A01+	1	A01–
2	A01–	2	A02+	2	A02–
3	A02+	3	Not used	3	Not used
4	A02–	4	Not used	4	Not used
5	Not used	5	DI1+	5	DI1–
6	Not used	6	Not used	6	Not used
7	Not used	7	Not used	7	Not used
8	Not used	8	Not used	8	Not used
9	DI1+				
10	DI1–				
11 to 16	Not used				

### 4.5.4 TB3 and TB4 terminal definition for Conductivity 2-e and Conductivity 4-e – Analog Sensors

TB4 terminal for 2-channel version only

Terminal	Function	Color
<b>TB3 / TB4</b>		
1	Cnd inner1 <sup>1)</sup>	White
2	Cnd outer1 <sup>1)</sup>	White/blue
3	Cnd outer1	–
4	Not used	–
5	Cnd outer2	–
6	Cnd inner2 <sup>2)</sup>	Blue
7	Cnd outer2 (GND) <sup>2)</sup>	Black
8	Not used	–
9	RTD ref/GND	Bare shield
10	RTD sense	Red
11	RTD	Green
12 to 18	Not used	–

1) For third party Conductivity 2-e sensors a jumper between 1 and 2 may be required.

2) For third party Conductivity 2-e sensors a jumper between 6 and 7 may be required.

## 4.5.5 TB3 and TB4 terminal definition for pH/ORP – Analog Sensors

TB4 terminal for 2-channel versions only

Terminal TB3 / TB 4	pH		Redox (ORP)	
	Function	Color <sup>1)</sup>	Function	Color
1	Glass	Transparent	Platinum	Transparent
2	Not used	–	–	–
3	Not used	–	–	–
4	Not used	–	–	–
5	Reference	Red	Reference	Red
6	Reference <sup>2)</sup>	–	Reference <sup>2)</sup>	–
7	Solution GND <sup>2)</sup>	Blue <sup>3)</sup>	Solution GND <sup>2)</sup>	–
8	Not used	–	–	–
9	RTD ref/GND	White	–	–
10	RTD sense	–	–	–
11	RTD	Green	–	–
12	Not used	–	–	–
13	Shield (GND)	Green/yellow	Shield (GND)	Green/yellow
14 to 18	Not used	–	–	–

1) Grey wire not used.

2) Install jumper between 6 and 7 for ORP sensors and pH electrodes without SG.

3) Blue wire for electrode with SG.

## 4.5.6 TB3 and TB4 terminal definition for Amperometric Oxygen and Dissolved Ozone – Analog Sensors

TB4 terminal for 2-channel versions only

Terminal	Function	Oxygen		Ozone
		InPro 6800	Hi Performance Oxygen	InPro 6510
		Color	Color	Color
1	Not used	–	–	–
2	Anode	Red	Red	Red
3	Anode	– <sup>1)</sup>	– <sup>1)</sup>	– <sup>1)</sup>
4	Reference	– <sup>1)</sup>	– <sup>1)</sup>	– <sup>1)</sup>
5	Not used	–	–	–
6	Not used	–	–	–
7	Guard	–	–	–
8	Cathode	Transparent	Grey	Grey
9	NTC ref (GND)	White	White	White
10	Not used	–	–	–
11	NTC	Green	Green	Green
12	Not used	–	–	–
13	Shield (GND)	Green/yellow	Green/yellow	Green/yellow
14 to 18	Not used	–	–	–

1) Install jumper between 3 and 4 for Hi Performance Oxygen and InPro 6510.

## 4.5.7 TB3 and TB4 terminal definition for pH/ORP, Amperometric oxygen, Dissolved Ozone and Conductivity 4-e – ISM Sensors

TB4 terminal for 2-channel versions only

Terminal TB3 / TB4	Function	Color
1 to 11	Not used	–
12	1-wire	Transparent (cable core)
13	GND	Red (shield)
14	RS485-B	–
15	RS485-A	–
16	5 V	–
17	GND 24 V	–
18	24 V	–

## 4.5.8 TB3 and TB4 terminal definition for UniCond 2-e and UniCond 4-e – ISM Sensors

TB4 terminal for 2-channel versions only

<b>Terminal TB3 / TB4</b>	<b>Function</b>	<b>Color</b>
1 to 11	Not used	–
12	Not used	–
13	GND	White
14	RS485-B	Black
15	RS485-A	Red
16	5 V	Blue
17 to 18	Not used	–



## **5 Placing transmitter in, or out, of service**

### **5.1 Placing transmitter in service**



After connecting the transmitter to power supply circuit, it will be active as soon as the circuit is powered.

### **5.2 Placing transmitter out of service**

First disconnect the unit from the main power source, then disconnect all remaining electrical connections. Remove the unit from the panel. Use the installations instruction in this manual as reference for dis-assembling mounting hardware.

All transmitter settings stored in memory are non-volatile.

## 6 Calibration

For the menu structure refer to chapter 3.10 "Graphic Trend Measurement".

PATH:  \ Cal



**NOTE:** During calibration, the outputs for the corresponding channel will default to be held at their current values until 20 seconds after the calibration menu is exited. A flashing H appears in the upper right corner of the display while outputs are held. Refer to chapter 7.3 "Analog Outputs" and chapter 7.4 "Set Points" to change the HOLD output status.

### 6.1 Sensor Calibration

PATH:  \ Cal \ Calibrate Sensor

#### 6.1.1 Select Channel

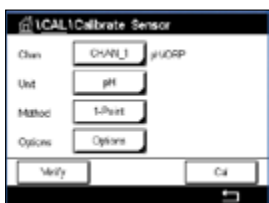

Select the desired channel (**Chan**) for calibration.

**NOTE:** During sensor calibration, the outputs will default their current values until 20 seconds after the calibration menu is exited. A flashing H appears in the upper right corner of the display while outputs are held. Refer to chapter 7.3 "Analog Outputs" and chapter 7.4 "Set Points" to change the HOLD output status.

See the following explanation to get more details about the calibration options and procedure.

#### 6.1.2 Select the desired sensor calibration task

For analog sensors depending on sensor type, the following choices are available:

Analog sensor	Calibration task
pH	pH, mV, Temperature, Edit, Verify
Conductivity	Conductivity, Resistivity, Temperature, Edit, Verify
Amp. Oxygen	Oxygen, Temperature, Edit, Verify
Ozone	Ozone, Temperature, Edit, Verify

For ISM (digital) sensors depending on sensor type, the following choices are available:

ISM sensor	Calibration task
pH	pH, ORP, Verify
Conductivity	Conductivity, Resistivity, Verify
Amp. Oxygen	Oxygen, Verify
Ozone	Ozone, Verify

### 6.1.3 Terminate Sensor Calibration

After every successful calibration different options are available. If "Adjust", "SaveCal" or "Calibrate" is chosen, the message "Calibration saved successfully! Reinstall sensor" is displayed. Press "Done" to return to the measuring mode.

Option	Analog sensors	ISM (digital) sensors
<b>Analog sensors:</b> <b>SaveCal</b>  <b>ISM sensors:</b> <b>Adjust</b>	Calibration values are stored in the transmitter and used for the measurement. Additionally, the calibration values are stored in the calibration data.	Calibration values are stored in the sensor and used for the measurement. Additionally, the calibration values are stored in the calibration history.
<b>Calibrate</b>	The function "Calibrate" is not applicable for analog sensors.	Calibration values are stored in the calibration history for documentation, but not be used for the measurement. The calibration values from the last valid adjustment are further used for the measurement.
<b>Cancel</b>	Calibration values are discarded.	Calibration values are discarded.

## 6.2 Calibration of UniCond 2-e and UniCond 4-e Sensors (ISM Sensors only)

### 6.2.1 Conductivity Calibration of UniCond 2-e and UniCond 4-e Sensors

The M300 provides the ability to perform a one-point, two-point or process conductivity or resistivity calibration for 2-e-sensors and 4-e-sensors.



**NOTE:** When performing calibration on a conductivity sensor, results will vary depending on the method, calibration apparatus and/or quality of reference standards used to perform the calibration.



**NOTE:** For measuring tasks the temperature compensation for the application as defined through the parameter settings for conductivity will be considered and not the temperature compensation selected through the calibration procedure (see also chapter 7.1.6.1 "Conductivity Settings"; PATH: \CONFIG\Meas\Parameter Setting).

Enter the menu Calibrate Sensor (see chapter 6.1 "Sensor Calibration"; PATH: \Cal\ Calibrate Sensor) and choose the desired channel for calibration.

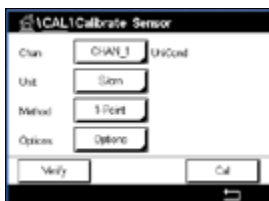

The following menus can be called up:

**Unit:** Choose between the units for conductivity (S/cm) and resistivity ( $\Omega$ -cm).

**Method:** Select the desired calibration procedure. Available are 1-point, 2-point or process calibration.

**Options:** The desired compensation mode for the calibration process can be selected.

Choices are "None", "Standard", "Light 84", "Std 75 °C", "Linear 25°C", "Linear 20°C", "Glycol.5", "Glycol1", "Cation", "Alcohol" and "Ammonia".

None does not make any compensation of the measured conductivity value. The uncompensated value will be displayed and proceeded.

Standard compensation includes compensation for non-linear high purity effects as well as conventional neutral salt impurities and conforms to ASTM standards D1125 and D5391.

Light 84 compensation matches the high purity water research results of Dr. T.S. Light published in 1984. Use only if your institution has standardized on that work.

Std 75 °C compensation is the Standard compensation algorithm referenced to 75 °C. This compensation may be preferred when measuring Ultrapure Water at an elevated temperature (Resistivity of ultrapure water compensated to 75 °C is 2.4818 Mohm-cm.)

Linear 25 °C compensation adjusts the reading by a coefficient or factor expressed as %/°C (deviation from 25 °C). Use only if the solution has a well-characterized linear temperature coefficient. The factory default setting is 2.0%/°C. (2.4818 Mohm-cm.)

Linear 20 °C compensation adjusts the reading by a coefficient or factor expressed as %/°C (deviation from 20 °C). Use only if the solution has a well-characterized linear temperature coefficient. The factory default setting is 2.0%/°C.

Glycol.5 compensation matches the temperature characteristics of 50% ethylene glycol in water. Compensated measurements using this solution may go above 18 Mohm-cm.

Glycol1 compensation matches the temperature characteristics of 100% ethylene glycol. Compensated measurements may go well above 18 Mohm-cm.

Cation compensation is used in power industry applications measuring the sample after a cation exchanger. It takes into account the effects of temperature on the dissociation of pure water in the presence of acids.

Alcohol compensation provides for the temperature characteristics of a 75% solution of isopropyl alcohol in pure water. Compensated measurements using this solution may go above 18 Mohm-cm.

Ammonia compensation is used in power industry applications for specific conductivity measured on samples using ammonia and/or ETA (ethanolamine) water treatment. It takes into account the effects of temperature on the dissociation of pure water in the presence of these bases.



**NOTE:** If compensation mode "Linear 25 °C" or "Linear 20 °C" has been chosen, the coefficient for the adjustment of the reading can be modified. In this case an additional input field will be displayed.

The changes are valid until the calibration mode has been escaped. After the values defined in the configuration menu are valid again.

### 6.2.1.1 One-Point Calibration

Select calibration procedure 1-Point (see chapter 6.2.1 "Conductivity Calibration of UniCond 2-e and UniCond 4-e Sensors"). With 2-e-sensors or 4-e-sensors a one-point calibration is always performed as a slope calibration. The following procedure shows the calibration with a 2-e-sensor. The calibration with a 4-e-sensor works respectively.

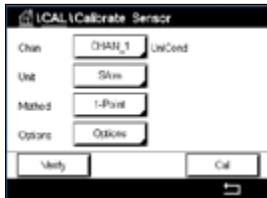

Press the button Cal for starting calibration.

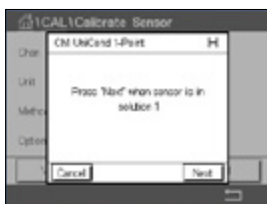

Place the electrode in the reference solution and press Next button.

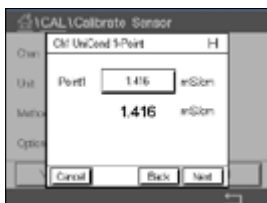

The second value displayed on the screen is the value being measured by the transmitter and sensor in units selected by the user.

Press the input field for **Point1** to enter the value for the calibration point. The M300 displays a keypad for modifying the value. Press the  $\leftarrow$  button and the transmitter will take over the value.



**NOTE:** To select another unit for the entered value on the keypad press the U button. To return again press the 0-9 button.



The screen shows the entered value for the reference solution (1st line) and the measured value of the M300 (2nd line).

Press the Next button to start the calculation of the calibration results.

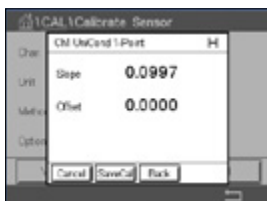

The display shows the value for the slope and the offset as the result of the calibration.

The calibration values are stored in the calibration history and taken over (press button SaveCal) or discarded (press button Cancel).

Use the Back button to go one step back in the calibration procedure.



### 6.2.1.2 Two-Point Calibration

Select calibration procedure 2-Point. With 4-e-sensors a two-point calibration is always performed as an offset and slope calibration. The following procedure shows the calibration with a 4-e-sensor.

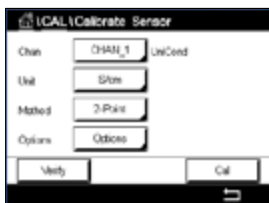

Press the button Cal for starting calibration.



Place the electrode in the first reference solution and press Next button.

**CAUTION:** Rinse sensors with a high-purity water solution between calibration points to prevent contamination of the reference solutions.

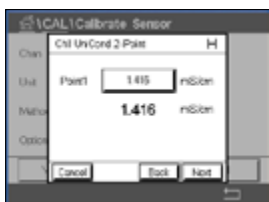

The second value displayed on the screen is the value being measured by the transmitter and sensor in the units selected by the user.

Press the input field for **Point1** to enter the calibration point. The M300 displays a keypad for modifying the value. Press the  $\leftarrow$  button to accept the value.



**NOTE:** To select another unit for the entered value on the keypad press the U button. To return again press the 0-9 button.

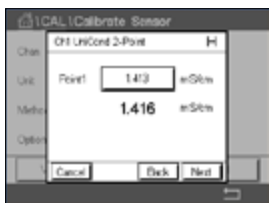

The screen shows the entered value for the first reference solution (1st line) and the measured value of the M300 (2nd line).

Press the Next button to go on with the calibration.

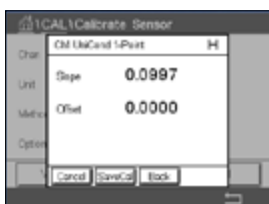

Place the electrode in the second reference solution and press Next button.

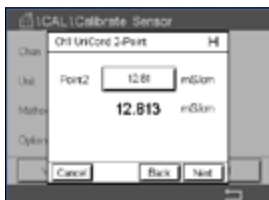

The second value displayed on the screen is the value being measured by the transmitter and sensor in the units selected by the user.

Press the input field for **Point2** to enter the calibration point. The M300 displays a keypad for modifying the value. Press the  $\leftarrow$  button to accept the value.



**NOTE:** To select another unit for the entered value on the keypad press the U button. To return again press the 0-9 button.

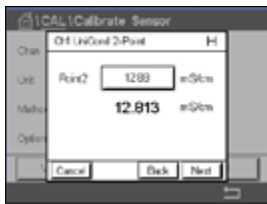

The screen shows the entered value for the second reference solution (1st line) and the measured value of the M300 (2nd line).

Press the Next button to start the calculation of the calibration results.

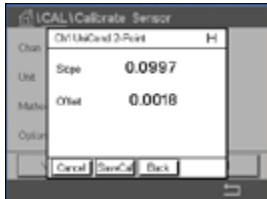

The display shows the value for the slope and the offset as the result of the calibration.

The calibration values are stored in the calibration history. To save (press button SaveCal) or to discard (press button Cancel).

Use the Back button to go one step back in the calibration procedure.



### 6.2.1.3 Process Calibration

Select calibration procedure Process (see chapter 6.2.1 "Conductivity Calibration of UniCond 2-e and UniCond 4-e Sensors"). With 2-e-sensors or 4-e-sensors a process calibration is always performed as a slope calibration. The following procedure shows the calibration with a 2-e-sensor. The calibration with a 4-e-sensor works respectively.

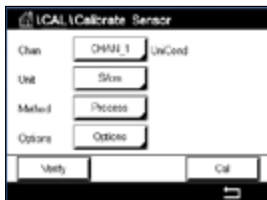

Press the button Cal for starting calibration.

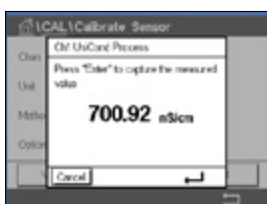

Take a sample and press the  $\leftarrow$  button to store the current measuring value. To show the ongoing calibration process, P is blinking in the Start and Menu screen if the related channel is selected in the display.



After determining the conductivity value of the sample, press the calibration icon in the Menu Screen again.

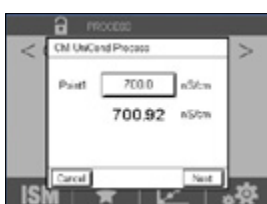

Press the input field for **Point1** and enter the conductivity value of the sample. Press the Next button to start the calculation of the calibration results.

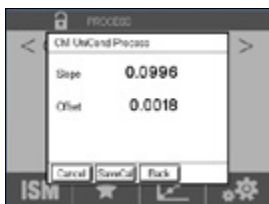

The display shows the value for the slope and the offset as the result of the calibration.

The calibration values are stored in the calibration history. To save (press button SaveCal) or to discard (press button Cancel).

Use the Back button to go one step back in the calibration procedure.



## 6.2.2 Temperature Calibration of UniCond 2-e Sensors and UniCond 4-e Sensors

The M300 provides the ability to perform a one-point or two-point calibration for the temperature sensor of the UniCond 2-e and UniCond 4-e.

Enter the menu Calibrate Sensor (see chapter 6.1 "Sensor Calibration"; PATH: \ Cal \ Calibrate Sensor) and choose the desired channel for calibration.



The following menus can be called up:

**Unit:** Choose between the units °C and °F.

**Method:** Select the desired calibration procedure. Available are 1-point and 2-point calibration.

### 6.2.2.1 One-Point Calibration

Select calibration procedure 1-Point. With 2-e-sensors or 4-e-sensors a one-point temperature calibration can be performed as a slope or offset calibration. The following procedure shows the calibration with a 2-e-sensor. The calibration with a 4-e-sensor works respectively.



Press the right input field for the parameter **Method**. Choose Slope or Offset calibration through pressing the corresponding field.

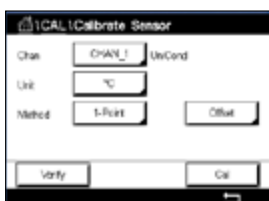

Press the button Cal for starting calibration.



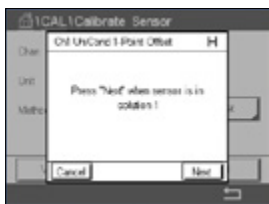

Place the electrode in the reference solution and press Next button.

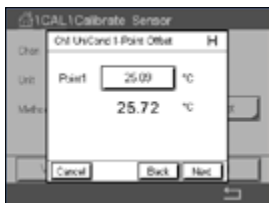

The second value displayed on the screen is the value being measured by the transmitter and sensor.

Press the input field for **Point1** to enter the value for the calibration point. The M300 displays a keypad for modifying the value. Press the  $\leftarrow$  button to accept the value.

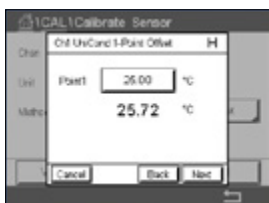

The screen shows the entered value for the reference solution (1st line) and the measured value of the M300 (2nd line).

Press the Next button to start the calculation of the calibration results.

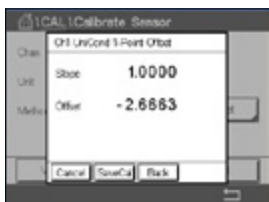

The display shows the value for the slope and the offset as the result of the calibration.

The calibration values are stored in the calibration history. To save (press button SaveCal) or to discard (press button Cancel).

Use the Back button to go one step back in the calibration procedure.



### 6.2.2.2 Two-Point Calibration

Select calibration procedure 2-Point (see chapter 6.2.2 "Temperature Calibration of UniCond 2-e Sensors and UniCond 4-e Sensors"). With 2-e-sensors or 4-e-sensor a two-point calibration is always performed as an offset and slope calibration. The following procedure shows the calibration with a 2-e-sensor. The calibration with a 4-e-sensor works respectively.

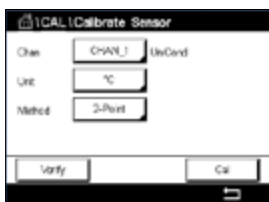

Press the button Cal for starting calibration.



Place the electrode in the first reference solution and press Next button.

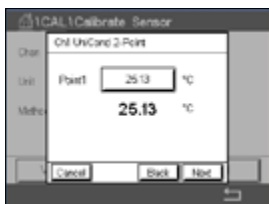

The second value displayed on the screen is the value being measured by the transmitter and sensor in the units selected by the user.

Press the input field for **Point1** to enter the calibration point. The M300 displays a keypad for modifying the value. Press the  $\leftarrow$  button and to accept the value.

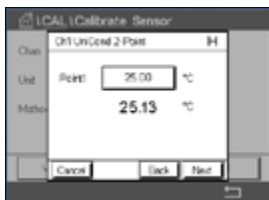

The screen shows the entered value for the first reference solution (1st line) and the measured value of the M300 (2nd line).

Press the Next button to go on with the calibration.



Place the electrode in the second reference solution and press Next button.



The second value displayed on the screen is the value being measured by the transmitter and sensor in the units selected by the user.

Press the input field for **Point2** to enter the calibration point. The M300 displays a keypad for modifying the value. Press the  $\leftarrow$  button and to accept the value.

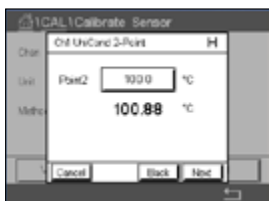

The screen shows the entered value for the second reference solution (1st line) and the measured value of the M300 (2nd line).

Press the Next button to start the calculation of the calibration results.

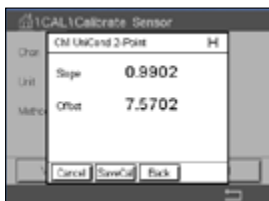

The display shows the value for the slope and the offset as the result of the calibration.

The calibration values are stored in the calibration history. To save (press button SaveCal) or to discard (press button Cancel).

Use the Back button to go one step back in the calibration procedure.



## 6.3 Calibration of Cond2e Sensors or Cond4e Sensors

PATH:  \ Cal \ Calibrate Sensor

The M300 provides the ability to perform a one-point, two-point or process conductivity or resistivity calibration for 2-e-sensors and 4-e-sensors.



**NOTE:** When performing calibration on a conductivity sensor, results will vary depending on the method, calibration apparatus and/or quality of reference standards used to perform the calibration.



**NOTE:** For measuring tasks the temperature compensation for the application as defined through the parameter settings for conductivity will be considered and not the temperature compensation selected through the calibration procedure (see also chapter 7.1.6.1 "Conductivity Settings").

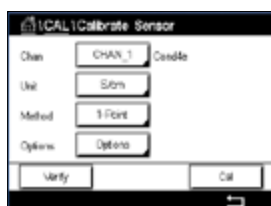

The following menus can be called up:

**Unit:** Between the units for conductivity and resistivity can be chosen.

**Method:** Select the desired calibration procedure, 1-point, 2-point or process calibration.

**Options:** Select the desired temperature compensation mode for the calibration process.



**NOTE:** If compensation mode "Linear 25 °C" or "Linear 20 °C" has been chosen, the coefficient for the adjustment of the reading can be modified.

The changes are valid until the calibration mode has been exited. After the values defined in the configuration menu are valid again.

### 6.3.1 One-Point Calibration

With 2-e-sensors or 4-e-sensors a one-point calibration is always performed as a slope calibration. The following procedure shows the calibration with a 2-e-sensor. The calibration with a 4-e-sensor works respectively.

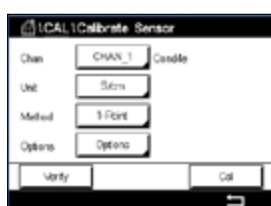

Press the button Cal for starting calibration.

Place the electrode in the reference solution and press Next button.

Enter the value for the calibration point (**Point1**).

Press the Next button to start the calculation of the calibration results.

The display shows the value for the slope and the offset as the result of the calibration.

For ISM (digital) sensors select "Adjust", "Calibrate" or "Cancel" to finish calibration. For Analog sensors select "SaveCal" or "Cancel" to finish calibration. See „6.1.3 Terminate Sensor Calibration“.

## 6.3.2 Two-Point Calibration

With 2-e-sensors or 4-e-sensors a two-point calibration is always performed as an offset and slope calibration. The following procedure shows the calibration with a 2-e-sensor. The calibration with a 4-e-sensor works respectively.

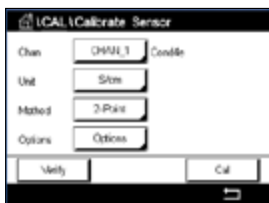

Press the button Cal for starting calibration.

Place the electrode in the first reference solution and press Next button.

**CAUTION:** Rinse sensors with a high-purity water solution between calibration points to prevent contamination of the reference solutions.

Enter the value for the first calibration point (**Point1**).

Press the Next button to go on with the calibration.

Place the electrode in the second reference solution and press Next button.

Enter the value for the second calibration point (**Point2**).

Press the Next button to start the calculation of the calibration results.

The display shows the value for the slope and the offset as the result of the calibration.

For ISM (digital) sensors select "Adjust", "Calibrate" or "Cancel" to finish calibration. For Analog sensors select "SaveCal" or "Cancel" to finish calibration. See „6.1.3 Terminate Sensor Calibration“.

## 6.3.3 Process Calibration

With 2-e-sensors or 4-e-sensors a process calibration is always performed as a slope calibration. The following procedure shows the calibration with a 2-e-sensor. The calibration with a 4-e-sensor works respectively.

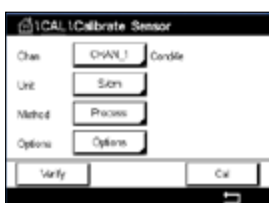

Press the button Cal for starting calibration.

Take a sample and press the  $\leftarrow$  button to store the current measuring value. To show the ongoing calibration process, P is blinking in the Start and Menu screen if the related channel is selected in the display.

After determining the conductivity value of the sample, press the calibration icon in the Menu Screen again.

Enter the conductivity value of the sample. Press the Next button to start the calculation of the calibration results.

The display shows the value for the slope and the offset as the result of the calibration.

For ISM (digital) sensors select "Adjust", "Calibrate" or "Cancel" to finish calibration. For Analog sensors select "SaveCal" or "Cancel" to finish calibration. See „6.1.3 Terminate Sensor Calibration“.

## 6.4 pH Calibration

PATH:  \ Cal \ Calibrate Sensor

For pH sensors, the M300 Transmitter features one-point, two-point or process calibration with 9 preset buffer sets or manual buffer entry. Buffer values refer to 25 °C. To calibrate the instrument with automatic buffer recognition, you need a standard pH buffer solution that matches one of these values. Please select the correct buffer table before using automatic calibration (see chapter 16 "Buffer tables"). The stability of the sensor signal during calibration can be checked by the user or automatically by the transmitter (see chapter 7.1.6.2 "pH Settings").



**NOTE:** For dual membrane pH electrodes (pH/pNa) only buffer Na+ 3.9M (see chapter 16.2.1 "Mettler-pH/pNa buffers (Na+ 3.9M)") is available.

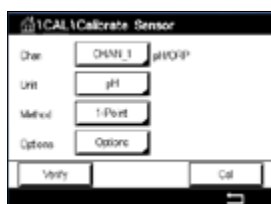

The following menus can be called up:

**Unit:** Select pH.

**Method:** Select the desired calibration procedure, 1-point, 2-point or process calibration.

**Options:** The buffer used for the calibration and the required stability of the sensor signal during the calibration can be selected (see also chapter 7.1.6.2 "pH Settings"). The changes are valid until the calibration mode has been escaped. After the values defined in the configuration menu are valid again.

### 6.4.1 One-Point Calibration

With pH sensors a one-point calibration is always performed as an offset calibration.

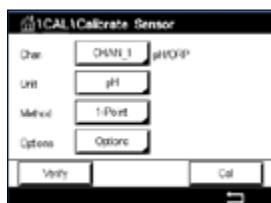

Press the button Cal for starting calibration.

Place the electrode in the buffer solution and press the Next button.

The display shows the buffer the transmitter has recognized **Point 1** and the measured value.

The M300 checks the stability of the measuring signal and proceeds as soon as the signal is sufficiently stable.



**NOTE:** If **option** Stability is set to Manual press 'Next' after the measuring signal is stable enough to go on with the calibration.

The transmitter shows the value for the slope and the offset as the result of the calibration.

For ISM (digital) sensors select "Adjust", "Calibrate" or "Cancel" to finish calibration. For Analog sensors select "SaveCal" or "Cancel" to finish calibration. See „6.1.3 Terminate Sensor Calibration“.

## 6.4.2 Two-Point Calibration

With pH sensors a two-point calibration is always performed as calibration of slope and offset.



Press the Cal button to start calibration.

Place the electrode in buffer solution 1 and press Next button.

The display shows the buffer the transmitter has recognized **Point 1** and the measured value.

The M300 checks the stability of the measuring signal and proceeds as soon as the signal is sufficiently stable.



**NOTE:** If **option** Stability is set to Manual press 'Next' after the measuring signal is stable enough to go on with the calibration.

The transmitter prompts you to place the electrode in the second buffer solution.

Press the Next button to proceed with the calibration.

The display shows the buffer the transmitter has recognized **Point 2** and the measured value.

The M300 checks the stability of the measuring signal and proceeds as soon as the signal is sufficiently stable.



**NOTE:** If **option** Stability is set to Manual press 'Next' after the measuring signal is stable enough to go on with the calibration.

The transmitter shows the value for the slope and the offset as the result of the calibration.

For ISM (digital) sensors select "Adjust", "Calibrate" or "Cancel" to finish calibration. For Analog sensors select "SaveCal" or "Cancel" to finish calibration. See „6.1.3 Terminate Sensor Calibration“.

## 6.4.3 Process Calibration

With pH sensors a process calibration is always performed as an offset calibration.

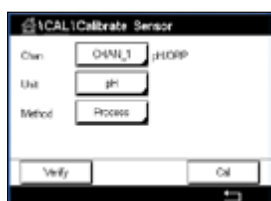

Press the Cal button to start calibration.

Take a sample and press the  $\leftarrow$  button to store the current measuring value. To show the ongoing calibration process, P is blinking in the Start and Menu Screen if the related channel is selected in the display.

After determining the pH value of the sample, press the calibration icon in the Menu Screen again.

Enter the pH value of the sample. Press the Next button to start the calculation of the calibration results.

The display shows the value for the slope and the offset as the result of the calibration.

For ISM (digital) sensors select "Adjust", "Calibrate" or "Cancel" to finish calibration. For Analog sensors select "SaveCal" or "Cancel" to finish calibration. See „6.1.3 Terminate Sensor Calibration“.

## 6.5 ORP Calibration of pH Sensors

PATH:  \ Cal \ Calibrate Sensor

For pH sensors with solution ground based on ISM technology the M300 Transmitter gives the option to make, in addition to the pH calibration, an ORP calibration.



**NOTE:** In case of choosing ORP calibration the parameters defined for pH (see chapter 7.1.6.2 "pH Settings") will not be considered. For pH sensors, the M300 Transmitter features one-point calibration for ORP.

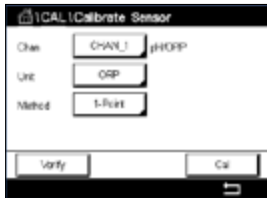

The following menus can be called up:

**Unit:** Select ORP through pressing the corresponding field.

**Method:** 1-Point calibration is displayed.

Press the button Cal for starting calibration.

Enter the value for calibration point 1 (**Point1**).

Press the Next button to start the calculation of the calibration results.

The display shows the value for the slope and the offset as the result of the calibration.

For ISM (digital) sensors select "Adjust", "Calibrate" or "Cancel" to finish calibration. For Analog sensors select "SaveCal" or "Cancel" to finish calibration. See „6.1.3 Terminate Sensor Calibration“.

## 6.6 Calibration of Amperometric Oxygen Sensors

PATH:  \ Cal \ Calibrate Sensor

The M300 provides the ability to perform a one-point or process calibration for amperometric oxygen sensors.



**NOTE:** Before air calibration, for highest accuracy, enter the barometric pressure and relative humidity, as described in chapter 7.1.6.3 "Settings for Oxygen Measurement Based on Amperometric Sensors".

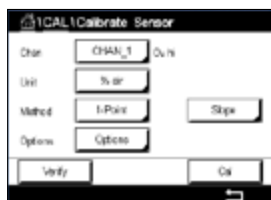

The following menus can be called up:

**Unit:** Between several units for Dissolved Oxygen can be chosen.

**Method:** Select the desired calibration procedure, 1-point or process calibration.

**Options:** In case the method 1-point has been chosen the calibration pressure, relative humidity and - for slope calibration - the stability mode for the sensor signal during the calibration can be selected. For the method Process the values for the process pressure, calibration pressure and the parameter ProcCalPress can be modified. See also chapter 7.1.6.3 "Settings for Oxygen Measurement Based on Amperometric Sensors". The changes are valid until the calibration mode has been escaped. After the values defined in the configuration menu are valid again.

### 6.6.1 One-Point Calibration

A one-point calibration of oxygen sensors is always either a one-point slope (i.e. with air) or a zero (offset) calibration. A one-point slope calibration is done in air and a one-point offset calibration is done at 0 ppb oxygen. A one-point zero dissolved oxygen calibration is available but not normally recommended since zero oxygen is very hard to achieve. A zero-point calibration is only recommended if high accuracy at low oxygen level (below 5% air) is needed.

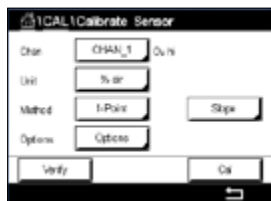

Choose Slope or Offset calibration through pressing the corresponding field.

Press the button Cal for starting calibration.



**NOTE:** If the polarization voltage for the measuring mode and calibration mode is different, the transmitter will wait 120 seconds before starting the calibration. In this case the transmitter will also go after the calibration for 120 seconds to the HOLD Mode, before returning to the measuring mode again.

Place the sensor in air or the calibration gas and press Next button

Enter the value for the calibration point (**Point1**).

The M300 checks the stability of the measuring signal and proceeds as soon as the signal is sufficiently stable.



**NOTE:** If **option** Stability is set to Manual press 'Next' after the measuring signal is stable enough to go on with the calibration.



**NOTE:** For an offset calibration the Auto mode is not available. If Auto mode has been chosen and afterwards slope calibration has been changed to offset calibration, the transmitter will perform the calibration in Manual mode.



The transmitter shows the value for the slope and the offset as the result of the calibration.

For ISM (digital) sensors select "Adjust", "Calibrate" or "Cancel" to finish calibration. For Analog sensors select "SaveCal" or "Cancel" to finish calibration. See „6.1.3 Terminate Sensor Calibration“.

## 6.6.2 Process Calibration

A process calibration of oxygen sensors is always either a slope or an offset calibration.

Choose Slope or Offset calibration through pressing the corresponding field.

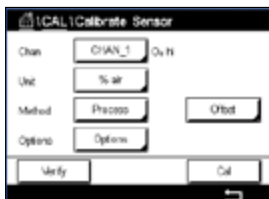

Press the Cal button to start calibration.

Take a sample and press the  $\leftarrow$  button to store the current measuring value. To show the ongoing calibration process, P is blinking in the Start and Menu screen if the related channel is selected in the display.

After determining the oxygen value of the sample, press the calibration icon in the Menu Screen again.

Enter the oxygen value of the sample. Press the Next button to start the calculation of the calibration results.

The display shows the value for the slope and the offset as the result of the calibration.

For ISM (digital) sensors select "Adjust", "Calibrate" or "Cancel" to finish calibration. For Analog sensors select "SaveCal" or "Cancel" to finish calibration. See „6.1.3 Terminate Sensor Calibration“.

## 6.7 Calibration of O<sub>3</sub> Sensors

The M300 provides the ability to perform a 1-Point or process calibration for O<sub>3</sub> sensors. Dissolved Ozone must be performed quickly because O<sub>3</sub> decays rapidly into oxygen, especially at warm temperatures.

Enter the menu Calibrate Sensor (see chapter 6.1 "Sensor Calibration";  
PATH:  $\leftarrow$ Cal\Calibrate Sensor) and choose the desired channel for calibration.

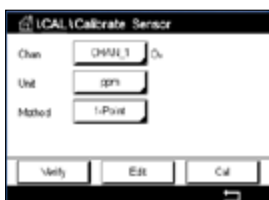

The following menus can be called up:

**Unit:** Several units for dissolved O<sub>3</sub> can be chosen.

**Method:** Select the desired calibration procedure, 1-Point or process calibration.

## 6.7.1 One-Point Calibration

Select the 1-Point calibration method. A one-point calibration of O<sub>3</sub> sensors is always a zero (offset) calibration

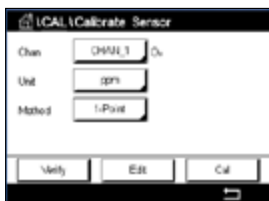

Press the button Cal for starting calibration.



Place the sensor in the calibration gas, such as air, and press the Next button.

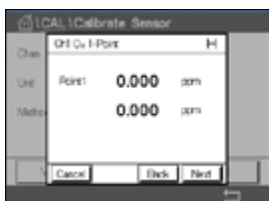

The second value displayed on the screen is the value being measured by the transmitter and sensor in the units selected by the user.

Press the input field for **Point1** to enter the value for the calibration point. The M300 displays a keypad for modifying the value. Press the  $\leftarrow$  button to accept the value.

When the measuring signal is stable, press Next to continue with the calibration

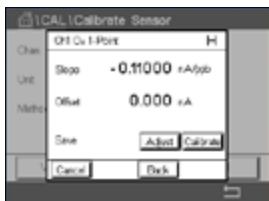

The display shows the value for the slope and the offset as result of the calibration.

For ISM (digital) sensors select "Adjust", "Calibrate" or "Cancel" to finish calibration. For Analog sensors select "SaveCal" or "Cancel" to finish calibration. See „6.1.3 Terminate Sensor Calibration“.

Use the Back button to go one step back in the calibration procedure



## 6.7.2 Process Calibration

Select the Process calibration method. A Process calibration of O<sub>3</sub> sensors can be performed as a slope or offset calibration.



Select the desired calibration **Method**.

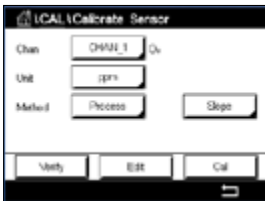

Press Cal to start the calibration.

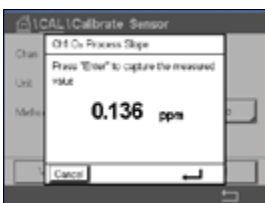

Take a sample and press the  $\leftarrow$  button to store the current measuring value. "P" will blink in the measurement screen indicating a Process calibration is active.



After determining the O<sub>3</sub> value of the sample, press the calibration icon to complete the Process calibration.



Press the input field for **Point1** and enter the O<sub>3</sub> value of the sample. Press the  $\leftarrow$  button to accept the value.

Press the Next button to start the calculation of the calibration results.



The display shows the value for the slope and the offset as the result of the calibration.

For ISM (digital) sensors select "Adjust", "Calibrate" or "Cancel" to finish calibration. For Analog sensors select "SaveCal" or "Cancel" to finish calibration. See „6.1.3 Terminate Sensor Calibration”.

Use the Back button to go one step back in the calibration procedure.



## 6.8 Sensor Verification

Enter the menu Calibrate Sensor (see chapter 6.1 "Sensor Calibration";  
PATH:  \ Cal \ Calibrate Sensor) and choose the desired channel for verification

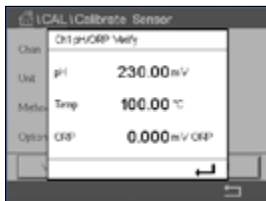

Press the Verify button to start verification.

The measured signal of the primary and the secondary measurement in basic (mostly electrical) units are shown. The meter calibration factors are used when calculating these values.

Press the  button and the transmitter returns to the calibration menu.

## 6.9 UniCond 2-e Electronics Calibration (ISM Sensor only)

The M300 provides the ability to calibrate or verify the electronic circuits of UniCond 2-e conductivity sensors. UniCond 2-e sensors have 3 resistance range circuits that require individual calibration. These measuring circuits are calibrated using the THORNTON ISM Conductivity Sensor Calibration Module part number 58 082 305 and supplied Y-connector. Before calibration, remove the sensor from the process, rinse with deionized water and allow to completely dry. Power the transmitter and sensor at least 10 minutes prior to calibration to assure stable operating temperature of the circuitry.

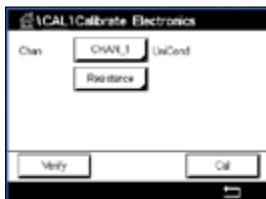

Press the Cal button.

Enter menu Calibrate Electronics.

Press the Chan\_x button and select the desired channel for calibration.

Choose **Verify** or **Cal**.

Reference THORNTON ISM Conductivity Sensor Calibration Module (part number 58 082 305) for detailed calibration and verification instructions.

## 6.10 Meter Calibration (Analog Sensors only)

Although it is not normally necessary to perform meter re-calibration unless extreme conditions cause an out of spec operation shown by Calibration Verification, periodic verification/re-calibration may be necessary to meet Q.A. requirements. The frequency calibration requires a two-point calibration. It is recommended that point one be at the low end of the frequency range and point two at the high end.

Press the Cal button.

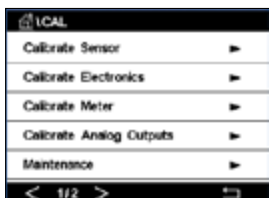

Enter menu Calibrate Meter.

### 6.10.1 Resistance (Analog Sensors only)

The meter is equipped with five (5) internal ranges of measurement. Each resistance range and temperature is calibrated separately, with each resistance range consisting of a two-point calibration.

Below is a table showing the resistance values for all calibration ranges.

Range	Point 1	Point 2	Point 4
Resistivity 1	1.0 Mohms	10.0 Mohms	–
Resistivity 2	100.0 Kohms	1.0 Mohms	–
Resistivity 3	10.0 Kohms	100.0 Kohms	–
Resistivity 4	1.0 Kohms	10.0 Kohms	–
Resistivity 5	100 Ohms	1.0 Kohms	–
Temperature	1000 Ohms	3.0 Kohms	66 Kohms



Press the input field in the second line to select Resistance.

Press the Cal button.

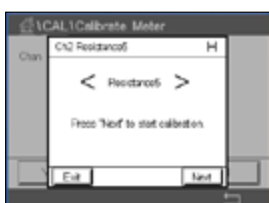

Press the Next button to start the calibration process.



Connect source 1 to input terminals. Each resistance range consists of a two-point calibration.

Press the Next button to continue.

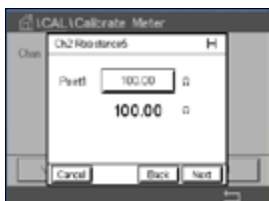

Press input field for Point1 to enter the calibration point. The M300 displays a keypad for modifying the value. Press the  $\leftarrow$  button and the transmitter will take over the value.

The second line shows the current value.

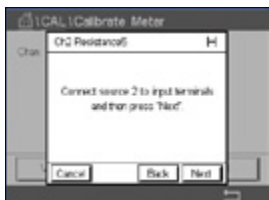

Connect source 2 to input terminals.

Press the Next button to continue.



Press input field for Point2 to enter the calibration point. The M300 displays a keypad for modifying the value. Press the  $\leftarrow$  button to accept the value.

The second line shows the current value.

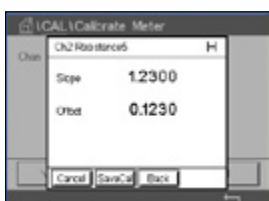

The display shows the value for the slope and the offset as the result of the calibration.

Select "SaveCal" or "Cancel" to finish calibration. See „6.1.3 Terminate Sensor Calibration“.

Use the Back button to go one step back in the calibration procedure.



### 6.10.2 Temperature (Analog Sensors only)

Temperature is performed as a three point calibration. The table in section 7.17.1 shows the resistance values of these three points.



Press the input field in the second line to select Temperature.

Press the Cal button.

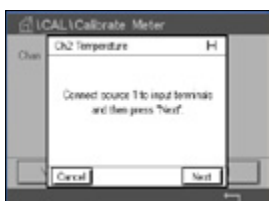

Connect source 1 to input terminals. Press the Next button to start the calibration process.



Press input field for Point1 to enter the calibration point. The M300 displays a keypad for modifying the value. Press the  $\leftarrow$  button and the transmitter will take over the value.

The second line shows the current value.



Connect source 2 to input terminals.

Press the Next button to continue.

Repeat the calibration procedure for Point2 and Point3 as for Point1 .

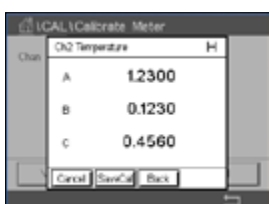

The display shows the result of the calibration.

Select "SaveCal" or "Cancel" to finish calibration. See „6.1.3 Terminate Sensor Calibration“.

Use the Back button to go one step back in the calibration procedure.

### 6.10.3 Voltage (Analog Sensors only)

Voltage calibration is performed as a two-point calibration.



Press the input field in the second line to select Temperature.

Press the Cal button.



Connect source 1 to input terminals. Press the Next button to start the calibration process.

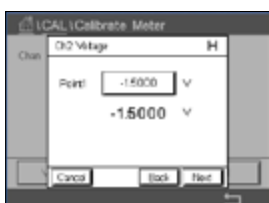

Press input field for Point1 to enter the calibration point. The M300 displays a keypad for modifying the value. Press the  $\leftarrow$  button to accept the value.

The second line shows the current value.



Connect source 2 to input terminals.

Press the Next button to continue.

Repeat the calibration procedure for Point2 and Point3 as for Point1 .

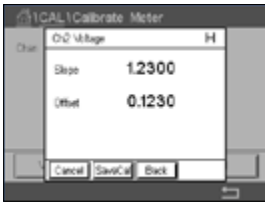

The display shows the result of the calibration.

For Analog sensors select "SaveCal" or "Cancel" to finish calibration. See „6.1.3 Terminate Sensor Calibration“.

Use the Back button to go one step back in the calibration procedure.

### 6.10.4 Current (Analog Sensors only)

Current calibration is performed as a two-point calibration.

Perform current calibration according to section 6.10.3 "Voltage (Analog Sensors only)".

### 6.10.5 Rg (Analog Sensors only)

Rg Diagnostic calibration is performed as a two-point calibration.

Perform current calibration according to section 6.10.3 "Voltage (Analog Sensors only)".

### 6.10.6 Rr (Analog Sensors only)

Rr Diagnostic calibration is performed as a two-point calibration.

Perform current calibration according to section 6.10.3 "Voltage (Analog Sensors only)".



## 6.11 Analog Output Calibration

PATH:  \ CAL \ Calibrate Analog Outputs

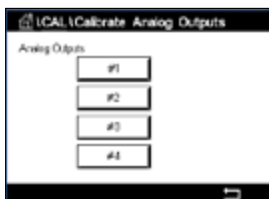

Each analog output can be calibrated at 4 and 20 mA. Select the desired output signal for calibration by pressing the #1 button for output signal 1, #2 for output signal 2, etc.

Connect an accurate milliamp meter to the analog output terminals and then adjust the 5-digit number in the display until the milliamp meter reads 4.00 mA and repeat for 20.00 mA.

As the 5-digit number is increased the output current increases and as the number is decreased the output current decreases. Thus coarse changes in the output current can be made by changing the thousands or hundreds digits and fine changes can be made by changing the tens or ones digits.

After adjusting both values press the Next button to start the calculation of the calibration results.

The display shows the calibration slope and zero point as the result of the output signal calibration.

Select "SaveCal" or "Cancel" to finish calibration. See „6.1.3 Terminate Sensor Calibration“.

## 6.12 Maintenance

PATH:  \ CAL \ Maintenance

The different channels of the M300 Transmitter can be switched manually into HOLD state. Furthermore a cleaning cycle can be started / stopped manually.

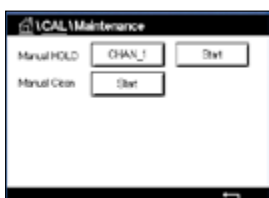

Select the channel, which should be set to HOLD manually.

Press Start button for **Manual HOLD** to activate the HOLD state for the selected channel. To deactivate the HOLD state again, press the Stop button, which is now displayed instead of the Start button.

Press the Start button for **Manual Clean** to switch the cleaning relay to the state for starting a cleaning cycle. To switch back the relay press the Stop button, which is now displayed instead of the Start button.

## 7 Configuration

For the menu structure refer to chapter 3.3 "Menu Structure".

### 7.1 Measurement

PATH:  \ CONFIG \ Meas

#### 7.1.1 Channel Setup

PATH:  \ CONFIG \ Meas \ Channel Setup

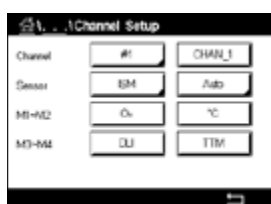

Select the **Channel** for the setup through pressing the button #1 for channel 1, #2 for channel 2.

Press the right input field in the line of the setting for **Channel**. A parameter for the corresponding channel is chosen through pressing the according field.

If Auto is selected, M300 Transmitter automatically recognizes the ISM sensor type. The channel can also be fixed to a certain measurement parameter, depending on the type of transmitter.

#### 7.1.2 Analog sensor

Select sensor type Analog.

Available measurement types are (depends on transmitter type):

Measurement parameter	Description	Transmitter		
		M300 Process	M300 Water	M300 Water Cond/Res
pH/ORP	pH or ORP	•	•	–
Cond2e	2 electrode conductivity	•	•	•
Cond4e	4 electrode conductivity	•	•	•
O <sub>2</sub> Hi	Amp. Dissolved oxygen (ppm)	•	–	–
O <sub>2</sub> Lo	Amp. Dissolved oxygen (ppb)	•	•	–
O <sub>3</sub>	Ozone	•	•	–

### 7.1.3 ISM sensor

Select sensor type ISM.

If an ISM sensor is connected, the transmitter automatically (Parameter = Auto) Recognizes the type of sensor. You can also fix the transmitter to a certain measurement parameter e.g. "pH", depending on the type of transmitter you have.

Measurement parameter	Description	Transmitter		
		M300 Process	M300 Water	M300 Water Cond/Res
pH/ORP	pH or ORP	•	•	–
pH/pNa	pH and ORP (with pH/pNa electrode)	•	•	–
UniCond 2e/4e	Conductivity UniCond	•	•	–
Cond2e	2 electrode conductivity	•	•	–
Cond4e	4 electrode conductivity	•	•	–
O <sub>2</sub> Hi	Amp. Dissolved oxygen (ppm)	•	–	–
O <sub>2</sub> Lo	Amp. Dissolved oxygen (ppb)	•	•	–
O <sub>3</sub>	Ozone	•	•	–

Enter the name with a maximum length of 6 characters for the channel through pressing the input field in the line **Descriptor**. The name of the channel will always be displayed, if the channel has to be selected. The name will also be displayed on the Start Screen and Menu Screen if the Display Mode (see chapter 7.1.5 "Display Mode") has been set to 1-Channel or 2-Channel.

Choose one of the measurements **M1 to M4** (e.g. for measuring value M1 the left button, for measuring M2 the right button in the corresponding line).

Select in the input field for **Measurement** the desired parameter to show.



**NOTE:** Beside the parameters pH, O<sub>2</sub>, T, etc. also the ISM values DLI, TTM and ACT can be linked to the measurements.

Choose **Range factor** of the measuring value. Not all parameters allow a modification of the range.

The menu **Resolution** allows the setting of the resolution for the measurement. The accuracy of the measurement is not affected by this setting. Possible settings are 1, 0.1, 0.01, 0.001.

Selected the menu **Filter**. The averaging method (noise filter) for the measurement can be selected. The options are None (default), Low, Medium, High, Special and Custom.

Option	Description
None	No averaging or filtering
Low	Equivalent to a 3 point moving average
Medium	Equivalent to a 6 point moving average
High	equivalent to a 10 point moving average
Special	Averaging depending on signal change (normally High averaging, but Low averaging for large changes in input signal)
Custom	1 point to 15 points moving average selection

## 7.1.4 Derived Measurements

The M300 enables the setup of derived measurements (total, difference, ratio) based on two measuring values like pH, conductivity, etc. To get the derived measurements, first set up the two primary measurements, which will be used to calculate the derived measurement. Define the primary measurements as if they were stand-alone readings. Then choose the corresponding unit for the derived measurement for the first channel. The M300 Transmitter will display an additional menu **Other Channel** to select the second channel with the corresponding measurement.

There are three additional derived measurements available for configuration with two conductivity sensors: %Rej (% Rejection) and pH Cal (Calculated pH).

### 7.1.4.1 % Rejection measurement

For reverse osmosis (RO) applications, percent rejection is measured with conductivity to determine the ratio of impurities removed from product or permeate water to the total impurities in the incoming feed water. The formula for obtaining Percent Rejection is:

$$[1 - (\text{Product}/\text{Feed})] \times 100 = \% \text{ Rejection}$$

Where Product and Feed are the conductivity values measured by the respective sensors.

Figure a shows a diagram of an RO installation with sensors installed for Percent Rejection.

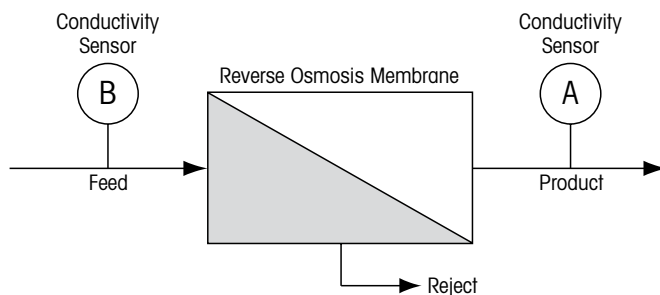

Figure a: % Rejection



**NOTE:** The product monitoring sensor must be on the channel that will measure percent rejection. If the product conductivity sensor is installed in channel 1, then percent rejection must be measured in channel 1.

### 7.1.4.2 Calculated pH (Power Plant Applications only)

Calculated pH may be obtained very accurately from specific and cation conductivity values on power plant samples when the pH is between 7.5 and 10.5 due to ammonia or amines and when the specific conductivity is significantly greater than the cation conductivity. This calculation is not suitable where significant levels of phosphates are present. The M300 uses this algorithm when pH Cal is selected as a measurement.

The calculated pH must be configured on the same channel as specific conductivity. For example, set up measurement M1 on CHAN\_1 to be specific conductivity, measurement M1 on CHAN\_2 to be cation conductivity, measurement M2 on CHAN\_1 to be calculated pH and measurement M3 on CHAN\_1 to be temperature. Set the temperature compensation mode to "Ammonia" for measurement M1 on CHAN\_1 and to "Cation" for measurement M1 on CHAN\_2.



**NOTE:** If operation goes outside the recommended conditions, a glass electrode pH measurement is needed to obtain an accurate value. On the other hand, when sample conditions are within the ranges noted above, the calculated pH provides an accurate standard for one-point trim calibration of the electrode pH measurement.

## 7.1.5 Display Mode

PATH:  \ CONFIG \ Meas \ Display Mode

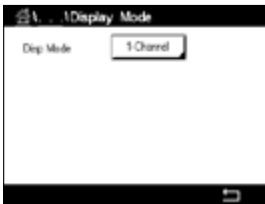

Press the input field in the line of the setting for **Disp Mode** and choose the measuring values, which are displayed on the Start Screen and Menu Screen.

Choose between the display of the measuring values for one channel and measuring values for two channels.



**NOTE:** If 1-Channel or 2-Channel has been chosen the measuring values, that will be displayed are defined in the menu Channel Setup (see chapter 7.1.1 "Channel Setup"). If 1-Channel has been chosen, M1 to M4 of every channel will be displayed. In case of 2-Channel M1 and M2 of every channel will be displayed.



**NOTE:** Beside the measurement values pH, O<sub>2</sub>, T, etc. also the ISM values DLI, TTM and ACT can be displayed.

## 7.1.6 Parameter Related Settings

PATH:  \ CONFIG \ Meas \ Parameter Setting

Measuring and calibration parameters can be set for the parameters pH, conductivity and oxygen.

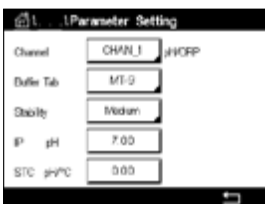

Access the menu **Channel** and select the channel.

Depending on the selected channel and assigned sensor the measuring and calibration parameters are displayed.

See the following explanation to get more details about the different parameter settings.

### 7.1.6.1 Conductivity Settings

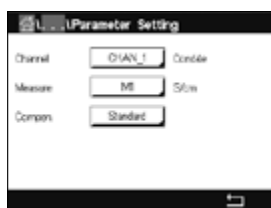

Select measurement (M1-M4). For more information regarding measurements see chapter 7.1.1 "Channel Setup".

If the selected measurement can be temperature compensated, the compensation method may be selected.

**NOTE:** During calibration, the compensation method must also be selected. (see chapter 6.2 "Calibration of UniCond 2-e and UniCond 4-e Sensors (ISM Sensors only)" and chapter 6.3 "Calibration of Cond2e Sensors or Cond4e Sensors").

Press **Compens.** to select the desired temperature compensation method. Choices are "None", "Standard", "Light 84", "Std 75 °C", "Linear 25°C", "Linear 20°C", "Glycol.5", "Glycol1", "Cation", "Alcohol" and "Ammonia".

None does not make any compensation of the measured conductivity value. The uncompensated value will be displayed and proceeded.

Standard compensation includes compensation for non-linear high purity effects as well as conventional neutral salt impurities and conforms to ASTM standards D1125 and D5391.

Light 84 compensation matches the high purity water research results of Dr. T.S. Light published in 1984. Use only if your institution has standardized on that work.

Std 75 °C compensation is the Standard compensation algorithm referenced to 75 °C. This compensation may be preferred when measuring Ultrapure Water at an elevated temperature (Resistivity of ultrapure water compensated to 75 °C is 2.4818 Mohm-cm.)

Linear 25 °C compensation adjusts the reading by a coefficient or factor expressed as %/°C (deviation from 25 °C). Use only if the solution has a well-characterized linear temperature coefficient. The factory default setting is 2.0%/°C.

Linear 20 °C compensation adjusts the reading by a coefficient or factor expressed as %/°C (deviation from 20 °C). Use only if the solution has a well-characterized linear temperature coefficient. The factory default setting is 2.0%/°C.

Glycol.5 compensation matches the temperature characteristics of 50% ethylene glycol in water. Compensated measurements using this solution may go above 18 Mohm-cm.

Glycol1 compensation matches the temperature characteristics of 100% ethylene glycol. Compensated measurements may go well above 18 Mohm-cm.

Cation compensation is used in power industry applications measuring the sample after a cation exchanger. It takes into account the effects of temperature on the dissociation of pure water in the presence of acids.

Alcohol compensation provides for the temperature characteristics of a 75% solution of isopropyl alcohol in pure water. Compensated measurements using this solution may go above 18 Mohm-cm.

Ammonia compensation is used in power industry applications for specific conductivity measured on samples using ammonia and/or ETA (ethanolamine) water treatment. It takes into account the effects of temperature on the dissociation of pure water in the presence of these bases.

**NOTE:** If compensation mode "Linear 25 °C" or "Linear 20 °C" has been chosen, the coefficient for the adjustment of the reading can be modified. In this case an additional input field will be displayed.

Press the input field for **Coef.** and adjust the coefficient or factor for the compensation.

## 7.1.6.2 pH Settings

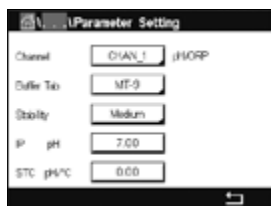

If a pH sensor is connected to the selected channel while during the channel setup (see chapter 7.1.1 "Channel Setup") Auto has been chosen the parameters Buffer Tab, Stability, IP, STC and calibration temperature as well as the displayed units for slope and/or zero point can be set or adjusted. The same parameters will be displayed if during the channel setup not Auto but pH/ORP has been set.

Select the buffer through the parameter **Buffer Tab**.

For automatic buffer recognition during calibration, select the buffer solution set that will be used: Mettler-9, Mettler-10, NIST Tech, NIST Std = JIS Std, HACH, CIBA, MERCK, WTW, JIS Z 8802 or None. See 16 "Buffer tables" for buffer values. If the auto buffer feature will not be used or if the available buffers are different from those above, select None.



**NOTE:** For dual membrane pH electrodes (pH/pNa) buffer Na+ 3.9M (see chapter 16.2.1 "Mettler-pH/pNa buffers (Na+ 3.9M)").

Select the required **Stability** of the measuring signal during the calibration procedure. Choose manual if the user will decide when a signal is stable enough to complete the calibration. Select Low, Medium or Strict if an automatic stability control of the sensor signal during calibration through the transmitter should be done.

If the parameter stability is set to medium (default) the signal deviation has to be less than 0.8 mV over a 20 second interval to be recognized by the transmitter as stable. The calibration is done using the last reading. If the criteria is not met within 300 seconds then the calibration times out and the message "Calibration Not Done" is displayed.

Adjust the parameter **IP pH**.

**IP** is the isothermal point value (Default = 7.000 for most applications). For specific compensation requirements or non standard inner buffer value, this value can be changed.

Adjust the value of the parameter **STC pH/°C**.

STC is the solution temperature coefficient in units of pH/°C referenced to the defined temperature. (Default = 0.000 pH/°C for most applications). For pure waters, a setting of -0.016 pH/°C should be used. For low conductivity power plant samples near 9 pH, a setting of -0.033 pH/°C should be used.

If the value for STC is  $\neq$  0.000 pH/°C an additional input field for the reference temperature will be displayed.

The value for **pH Ref Temperature** indicates to which temperature the solution temperature compensation is referenced. The displayed value and the output signal is referenced to this temperature. Most common reference temperature is 25°C.

### 7.1.6.3 Settings for Oxygen Measurement Based on Amperometric Sensors

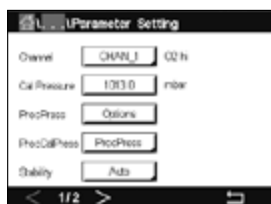

If an amperometric oxygen sensor is connected to the selected channel while during the channel setup (see chapter 7.1.1 "Channel Setup") Auto has been chosen the parameters CalPressure, ProcPressure, ProcCalPress, Stability, Salinity, RelHumidity, UpolMeas and UpolCal can be set or adjusted. The same parameters will be displayed if during the channel setup not Auto but O<sub>2</sub> hi, or O<sub>2</sub> lo has been set.

Enter the value for the calibration pressure through the parameter **CalPressure**.

**NOTE:** For a modification of the unit for the calibration pressure press U on the displayed keypad.

Press the Option button for the parameter **ProcPressure** and select the how to get applying process pressure through choosing the **Type**.

The applied process pressure can be entered by choosing Edit or measured over the analog input of the M300 by choosing Ain\_1.

If Edit has been chosen an input field for entering the value manually is displayed on the screen. In case that Ain\_1 has been selected two input fields are displayed to enter the start value (4 mA) and the end value (20 mA) of the range for the 4 to 20 mA input signal.

For the algorithm of the process calibration the applied pressure has to be defined. Select the pressure through the parameter **ProcCalPress**. For the process calibration the value of the process pressure (ProcPress) or the calibration pressure (CalPress) can be used.

Select the required **Stability** of the measuring signal during the calibration procedure. Choose Manual if the user will decide when a signal is stable enough to complete the calibration. Select Auto and an automatic stability control of the sensor signal during calibration through the transmitter will be done.

Additional settings can be done by navigating to the next page of the menu.

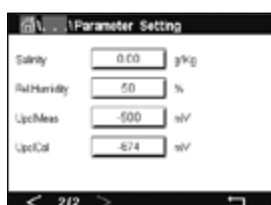

The **Salinity** of the measured solution can be modified.

In addition the relative humidity (button **Rel.Humidity**) of the calibration gas can also be entered. The allowed values for relative humidity are in the range 0% to 100%. When no humidity measurement is available, use 50% (default value).

The polarization voltage of amperometric oxygen sensors in the measuring mode can be modified through the parameter **UpolMeas**. For entered values 0 mV to -550 mV the connected sensor will be set to a polarization voltage of -500mV. If the entered value is less than -550 mV, the connected sensor will set to a polarization voltage of -674 mV.

The polarization voltage of amperometric oxygen sensors for calibration can be modified through the parameter **UpolCal**. For entered values 0 mV to -550 mV the connected sensor will be set to a polarization voltage of -500mV. If the entered value is less than -550mV, the connected sensor will set to a polarization voltage of -674mV.

**NOTE:** During a process calibration, the polarization voltage UpolMeas, defined for the measuring mode, will be used.

**NOTE:** If a one-point calibration is executed, the transmitter sends the polarization voltage, valid for the calibration, to the sensor. If the polarization voltage for the measuring mode and calibration mode is different, the transmitter will wait 120 seconds before starting the calibration. In this case the transmitter will also go after the calibration for 120 seconds to the HOLD Mode, before returning to the measuring mode again.



## 7.2 Temperature Source (Analog Sensors only)

PATH:  \ CONFIG \ Meas \ Temperature Source

Source: Auto(default), Pt100, Pt1000, NTC22k, Fixed

The third line shows the related temperature setting. Range: -40 to 200 °C, Default: 25 °C

## 7.3 Analog Outputs

PATH:  \ CONFIG \ Analog Outputs

See the following explanation to get more details about the different settings for the analog outputs.



Press the input field in the line of the setting for **Aout** and select the desired output signal for configuration by pressing button #1 for output signal 1, #2 for output signal 2 etc. Press the related button for the assignment of the channel (**Chan**). Select the channel, which has to be linked to the output signal.

Press the button for the assignment of the measuring parameter – based on the selected channel – that has to be linked to the output signal.



**NOTE:** Besides the measurement values pH, O<sub>2</sub>, T, etc. also the ISM values DLI, TTM and ACT can be linked to the output signal.

Select the **Range** for the output signal.

To adjust the value for the analog output signal if an alarm occurs, press the input field in the line for the setting of **Alarm**. Off means, that an alarm has now influence on the output signal.



**NOTE:** Not only the alarms occurred on the assigned channel will be considered, but every alarm coming up on the transmitter.

The value for the output signal if the transmitter goes into HOLD mode can be defined. It can be chosen between the last value (i.e. the value before the transmitter switched to the HOLD mode) or an fixed value.

Press the input field in the line for the setting of the **HOLD Mode** and select the value. If a fixed value is chosen, the transmitter shows an additional input field.

Additional settings can be done by navigating to the next page of the menu.

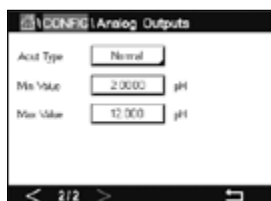

The **Aout Type** can be Normal, Bi-Linear, Auto-Range or Logarithmic. The range can be 4–20 mA or 0–20 mA. Normal provides linear scaling between the minimum and maximum scaling limits and is the default setting. Bi-Linear will also prompt for a scaling value for the mid-point of the signal and allows two different linear segments between the minimum and maximum scaling limits.

Press the button for the **Min Value**, that corresponds with start point of the analog output range.

Press the button for the **Max Value**, that corresponds with end point of the analog output signal.

Depending on the chosen Aout type additional values can be entered.

**Bi-Linear** will also prompt for a scaling value for the Mid Value of the signal and allows two different linear segments between the defined Min and Max Values.

**Auto-Range** scaling provides two ranges of output. It is designed to work with a PLC to provide a wide measurement range at the high end of the scale, and a narrower range with high resolution at the low end. Two separate settings are used, one for the maximum limit of the high range and one for the maximum limit of the low range, for the single 0/4-20 mA signal.

Max1 is the maximum limit of the low range on auto-range. The maximum value for the high range on auto-range is set with the Max Value. Both ranges have the same minimum value that is set through Min Value. If the input value is higher then value of Max1, the transmitter switches automatically to the second range. To indicate the currently valid range a relay can be assigned. The relay will be switched if the transmitter changes from on range to the other.

If **Logarithmic** Range was selected, it will prompt for the Max Value and also for the number of decades.

## 7.4 Set Points

PATH:  \ CONFIG \ Set Points

See the following explanation to get more details about the different settings for the set points.

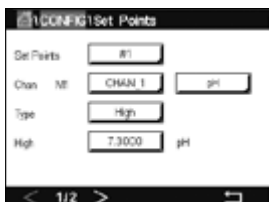

Press the input field in the line of the setting for **Set Point** and select the desired set point for configuration through pressing the button #1 for set point 1, #2 for set point 2 etc..

Press the related button for the assignment of the channel (**Chan**). Select the channel, which has to be linked to the set point.

Press the button for the assignment of the measuring parameter – based on the selected channel – that has to be linked to the set point.

Mx in the display indicates the measurement assigned to the set point. (see chapter 7.1.1 “Channel Setup”).



**NOTE:** Beside the parameters pH, O<sub>2</sub>, T, mS/cm, %EP WFI etc. also the ISM values DLI, TTM and ACT can be linked to the set point.

The **Type** of the setpoint can be High, Low, Between, Outside or Off. An “Outside” setpoint will cause an alarm condition whenever the measurement goes above its high limit or below its low limit. A “Between” setpoint will cause an alarm condition to occur whenever the measurement is between its high and low limits.



**NOTE:** If the type of set point is not Off additional settings can be done. See the following description.

According to the selected type of setpoint, value(s) regarding the limit(s) can be entered.

Additional settings can be done by navigating to the next page of the menu.

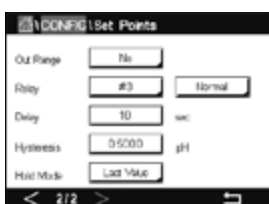

Once configured a relay could be activated if a sensor **Out of Range** condition is detected on the assigned input channel.

To select the desired relay that will be activated if the defined conditions are reached press the input field in the line for the setting of **SP Relay**. If the chosen relay is used for another task, the transmitter shows the message on the screen that there is a Relay Conflict.

The operation mode of the relay can be defined.

Relay contacts are in normal mode until the associated setpoint is exceeded, then the relay is activated and the contact states change. Select Inverted to reverse the normal operating state of the relay (i.e. normally open contacts are in a closed state, and normally closed contacts are in an open state, until the setpoint is exceeded).

Enter the **Delay** time in seconds. A time delay requires the setpoint to be exceeded continuously for the specified length of time before activating the relay. If the condition disappears before the delay period is over, the relay will not be activated.

Enter the value for the **Hysteresis**. A hysteresis value requires the measurement to return within the setpoint value by a specified percentage before the relay is deactivated.

For a high setpoint, the measurement must decrease more than the indicated percentage below the setpoint value before the relay is deactivated. With a low setpoint, the measurement must rise at least this percentage above the setpoint value before the relay is deactivated. For example, with a high setpoint of 100, when this value is exceeded, the measurement must fall below 90 before the relay is deactivated.

Enter the relay **HOLD Mode** of "Off", "Last Value" or "On". This is the state of the relay during HOLD status.

## 7.5 ISM Setup (ISM Sensors only)

PATH:  \ CONFIG \ ISM Setup

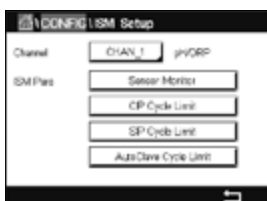

See the following explanation to get more details about the different parameter settings for the ISM Setup.

### 7.5.1 Sensor Monitor

If a pH/ORP, O<sub>2</sub> hi, O<sub>2</sub> lo, or O<sub>3</sub> sensor is connected to the selected channel while during the channel setup (see 7.1.1 "Channel Setup") Auto has been chosen the parameter Sensor Monitor can be set or adjusted. The menu Sensor Monitor will also be displayed if during the channel setup not Auto but one of the mentioned sensors has been set.

Press the button Sensor Monitor.

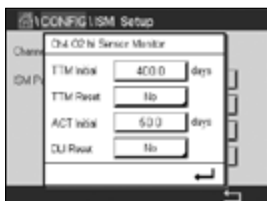

Enter the value for the initial Time To Maintenance interval (**TTM Initial**) in days. The initial value for TTM can be modified according to the application experience.

For pH/ORP sensor the timer estimates when the next cleaning cycle should be performed to keep the best possible measurement performance. The timer is influenced by significant changes on the DLI parameters.

For amperometric oxygen and ozone sensors, the time to maintenance indicates a maintenance cycle for the membrane and electrolyte.

Press the input field for **TTM Reset**. Select Yes if Time To Maintenance (TTM) for the sensor should be reset to the initial value.

Time To Maintenance needs to be reset after the following operations.

pH sensors: manual maintenance cycle on the sensor.

Oxygen or ozone sensor: manual maintenance cycle on the sensor or exchanging of the membrane of the sensor



**NOTE:** By connecting a sensor, the actual value for TTM of the sensor is read out from the sensor.

Enter the **ACT Initial** value in days. The new value will be loaded down to the sensor after saving the changes.

The Adaptive Calibration Timer (ACT) estimates when the next calibration should be performed to keep the best possible measurement performance. The timer is influenced by significant changes on the DLI parameters. The ACT will be reset to its initial value after a successful calibration. The initial value for the ACT can be modified according to the application experience and loaded down to the sensor.



**NOTE:** By connecting a sensor, the actual value for the ACT of the sensor is read out from the sensor.

Press the input field for **DLI Reset**. Select Yes if Dynamic Lifetime Indicator (DLI) for the sensor should be reset to the initial value. The reset will be done after saving the changes.

The DLI allows an estimation, when the pH electrode, the inner body of an amperometric oxygen or ozone sensor is at the end of his lifetime, based on the actual stress he is exposed to. The sensor permanently takes the averaged stress of the past days into consideration and is able to increase/decrease the lifetime accordingly.

The following parameters affect the lifetime indicator:

#### Dynamic parameter

- Temperature
- pH or oxygen value
- Glass impedance (only pH)
- Reference impedance (only pH)

#### Static parameters

- Calibration history
- Zero and Slope
- CIP/SIP/Autoclaving cycles

The sensor keeps the information stored in the built in electronics and can be retrieved via a transmitter or the iSense asset management suite.

For amperometric oxygen sensors, the DLI is related to the inner-body of the sensor. After exchanging the inner-body perform DLI Reset.



**NOTE:** By connecting a sensor, the actual values for the DLI of the sensor are read out from the sensor.



**NOTE:** The menu DLI Reset for pH sensors not available. If the actual value for the DLI of a pH sensor is 0 the sensor has to be replaced.

## 7.5.2 CIP Cycle Limit

If a pH/ORP, oxygen or conductivity sensor is connected to the selected channel during the channel setup (see chapter 7.1.1 "Channel Setup") Auto has been chosen the parameter CIP Cycle Limit can be set or adjusted. The menu CIP Cycle Limit will also be displayed if during the channel setup not Auto but one of the mentioned sensors has been set.

Press the button CIP Cycle Limit.

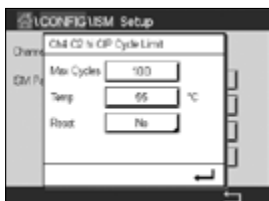

Press the button in the input field for the parameter **Max Cycles** and enter the value for the maximum CIP cycles. The new value will be written to the sensor after saving the changes.

The CIP cycles are counted by the transmitter. If the limit (value for Max Cycles) is reached, an alarm can be indicated and set to a certain output relays.

If the Max Cycles setting is on 0, the counter functionality is turned off.

Press the button in the input field for the parameter **Temp** and enter the temperature, which has to be exceeded, that the a CIP cycle will be counted.

CIP Cycles will be automatically recognized by the transmitter. Since CIP cycles will vary in intensity (duration and temperature) for each application the algorithm of the counter recognizes an increase of the measurement temperature above the level defined through the value for Temp. If the temperature does not decrease below the defined temperature level  $-10\text{ °C}$  within the next 5 minutes after the first temperature was reached, the counter in question will be incremented by one and also locked for the next two hours. In the case the CIP would last longer than two hours the counter would be incremented by one once more.

Press the input field for **Reset**. Select Yes if CIP counter for the sensor should be reset to 0. The reset will be done after saving the changes.

If an oxygen sensor is connected, the reset should be performed after the following operations.  
amperometric sensor: exchanging of the inner-body of the sensor.



**NOTE:** For pH/ORP sensor the menu Reset is not available. A pH/ORP sensor should be replaced if the number for Max Cycles has been exceeded.

## 7.5.3 SIP Cycle Limit

If a pH/ORP, oxygen or conductivity sensor is connected to the selected channel during the channel setup (see chapter 7.1.1 "Channel Setup") Auto has been chosen the parameter SIP Cycle Limit can be set or adjusted. The menu SIP Cycle Limit will also be displayed if during the channel setup not Auto but one of the mentioned sensors has been set.

Press the button SIP Cycle Limit.

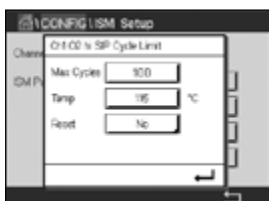

Press the button in the input field for the parameter **Max Cycles** and enter the value for the maximum SIP cycles. The new value will be written to the sensor after saving the changes.

The SIP cycles are counted by the transmitter. If the limit (value for Max Cycles) is reached, an alarm can be indicated and set to a certain output relays.

If the Max Cycles setting is on 0, the counter functionality is turned off.

Press the button in the input field for the parameter **Temp** and enter the temperature, which has to be exceeded, that the a SIP cycle will be counted.

SIP Cycles will be automatically recognized by the transmitter. Since SIP cycles will vary in intensity (duration and temperature) for each application the algorithm of the counter recognizes an increase of the measurement temperature above the level defined through the value for Temp. If the temperature does not decrease below the defined temperature level - 10°C within the next 5 minutes after the first temperature was reached, the counter in question will be incremented by one and also locked for the next two hours. In the case the SIP would last longer than two hours the counter would be incremented by one once more.

Press the input field for **Reset**. Select Yes if SIP counter for the sensor should be reset to 0. The reset will be done after saving the changes.

If an oxygen sensor is connected, the reset should be performed after the following operations.  
Amperometric sensor: exchanging of the inner-body of the sensor.



**NOTE:** For pH/ORP sensor the menu Reset is not available. A pH/ORP sensor should be replaced if the number for Max Cycles has been exceeded.

## 7.5.4 AutoClave Cycle Limit

If a pH/ORP, amperometric oxygen is connected to the selected channel during the channel set-up (see chapter 7.1.1 "Channel Setup") Auto has been chosen the parameter AutoClave Cycle Limit can be set or adjusted. The menu AutoClave Cycle Limit will also be displayed if during the channel setup not Auto but one of the mentioned sensors has been set.

Press the button AutoClave Cycle Limit.



Press the button in the input field for the parameter **Max Cycles** and enter the value for the maximum AutoClave cycles. The new value will be written to the sensor after saving the changes.

If the Max Cycles setting is on 0, the counter functionality is turned off.

Since during the autoclaving cycle the sensor is not connected to the transmitter, you will be asked after every sensor connection, whether the sensor was autoclaved or not. According to your selection, the counter will be incremented or not. If the limit (value for Max Cycles) is reached, an alarm can be indicated and set to a certain output relay. Press the input field for **Reset**. Select Yes if the AutoClave counter for the sensor should be reset to 0. The reset will be done after saving the changes.

If an oxygen sensor is connected, the reset should be performed after the following operations.  
Amperometric sensor: exchanging of the inner-body of the sensor.



**NOTE:** For pH/ORP sensor the menu Reset is not available. A pH/ORP sensor should be replaced if the number for Max Cycles has been exceeded.

## 7.5.5 DLI Stress Adjustment

If a pH/ORP is connected to the selected channel during the channel setup (see chapter 7.1.1 "Channel Setup") Auto has been chosen the parameter DLI Stress Adjustment can be adjusted. With this setting the user can adjust the sensor sensitivity to the stress of his specific application for the DLI calculation.



Browse to page 2 of "ISM Setup".

Press the button **DLI Stress Adjustment**.

Select between low / medium / high for the **Type** of DLI Stress Adjustment.

LOW: DLI extended (-30% sensitivity)

MEDIUM: standard DLI (default)

HIGH: DLI reduced (+30% sensitivity)

Press  $\leftarrow$  to accept the setting.

## 7.5.6 SAN Cycle Parameters

If an ozone sensor is connected, values for the following SAN Cycle Parameters can be set, Max Cycles (the maximum number of sanitization cycles), Conc. Max (the maximum allowed  $O_3$  concentration), Conc. Min (the minimum allowed  $O_3$  concentration), Cycle Time (length of cycle), and Reset.

Press the button SAN Cycle Parameters.



Press the input field next to Max Cycles and enter the value for the maximum SAN cycles. Press  $\leftarrow$  to accept the value. The new value will be written to the sensor after saving the changes.

The SAN cycles are counted by the transmitter. If the limit (value for Max Cycles) is reached, an alarm can be configured. If the Max Cycles setting = 0, the counter functionality is turned off.

Press the input field next to Conc. Max and enter the ozone concentration above which a sanitization cycle is to be detected. Press  $\leftarrow$  to accept the value.

Press the input field next to Conc. Min. Enter the value for the ozone concentration below which a sanitization cycle is no longer detected. Press  $\leftarrow$  to accept the value

Press the input field next to Cycle Time. Enter the value for the time, the ozone concentration has to be higher than the Conc. Min value after the Conc. Max value has been exceeded to count a sanitization cycle. Press  $\leftarrow$  to accept the value.

Press the input field next to Reset. Select Yes to reset the sanitization counter to zero. This is typically performed after sensor replacement. The reset will be done after saving the changes

Press  $\leftarrow$  to exit the menu SAN Cycle Parameters.

## 7.5.7 Reset Counters for UniCond 2-e Sensors

For UniCond 2-e sensors, the following counters can be reset: High Temp and High Conductivity.

Press the button Reset Counters.

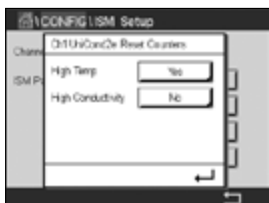

Select Yes for the desired counter to be reset and press enter. The reset will be done after saving the changes.

Press  $\leftarrow$  to exit the menu Reset Counters.

## 7.5.8 Set Calibration Interval for UniCond 2-e Sensors

For UniCond 2-e sensor the Cal Interval (calibration interval) can be set.

Press the button Cal Interval.



Press the input field next to **Cal Interval** and enter the value for the calibration interval. Based on this value the Time To Calibration (TTCal) will be calculated by the transmitter. Press  $\leftarrow$  to accept the value. The new value will be written to the sensor after saving the changes.

Press  $\leftarrow$  to exit the menu Cal Interval.

## 7.6 General Alarm

PATH:  $\leftarrow$  \ CONFIG \ General Alarm

See the following explanation to get more details about the different settings for General Alarm.



Press the button Event in the line of the settings for **Option** and select the events, that should be considered for an alarm.

To activate a relay if the defined conditions are reached press the input field in the line for the settings of **Relay**. Only relay 1 can be assigned to general alarm. For general alarms the operation mode of the assigned relay is always inverted.

Enter the **Delay** time in seconds. A time delay requires the setpoint to be exceeded continuously for the specified length of time before activating the relay. If the condition disappears before the delay period is over, the relay will not be activated.



## 7.7 ISM / Sensor Alarm

PATH:  \ CONFIG \ ISM / Sensor Alarm

See the following explanation to get more details about the different settings for ISM / Sensor Alarm.

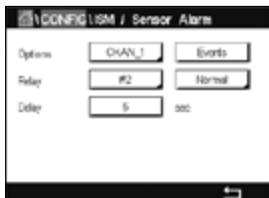

Select the channel by pressing the related button in the line of the settings for **Option**.

Depending on the selected channel or assigned sensor the **Events** that will be considered for generating an alarm can be selected. Some alarms will be considered in any case and not have to be selected or deactivated.

To select the desired relay that will be activated if an event has taken place press the input field in the line for the settings for **Relay**.

The operation mode of the relay can be defined.

Relay contacts are in normal mode until one of the selected events has taken place. Then the relay is activated and the contact states change. Select Inverted to reverse the normal operating state of the relay (i.e. normally open contacts are in a open state, and normally closed contacts are in a closed state if an event has taken place).

Enter the **Delay** time in seconds. A time delay requires the event to be occurred continuously for the specified length of time before activating the relay. If the condition disappears before the delay period is over, the relay will not be activated.

## 7.8 Clean

PATH:  \ CONFIG \ Clean

See the following explanation to get more details about the different settings for Clean



Enter the cleaning **Interval** time in hours. The cleaning interval can be set from 0.000 to 99999 hours. Setting it to 0 turns the clean cycle off.

Enter the **Clean Time** in seconds. The clean time can be 0 to 9999 seconds and must be smaller than the cleaning interval.

**Assign** the channel(s) for cleaning cycles. The assigned channels will be in HOLD state during the cleaning cycle.

Choose a **Relay**. Relay contacts are in normal mode until the cleaning cycle starts, then the relay is activated and the contact states change. Select Inverted to reverse the normal operating state of the relay (i.e. normally open contacts are in a open state, and normally closed contacts are in a closed state when the cleaning cycle starts).

## 7.9 Display Setup

PATH:  \ CONFIG \ Display Setup

See the following explanation to get more details about the different settings for Display Setup



Enter the name for the M300 Transmitter (**Instrument Tag**). The instrument tag will also be displayed on the line at the top of the Start Screen and Menu Screen.

Use **BackLight** to switch off or dim the transmitter screen after a defined time period without interaction. The transmitter screen will automatically come back after pressing the display.

Enter the **Light Time** in minutes. The light time is the time period without interaction before the transmitter screen will be dimmed or switched off.

**NOTE:** In case of an unacknowledged warning or alarm the transmitter screen will not be dimmed or switched off even if the light time has been elapsed

The parameter **Max** allows the setting of the backlight during operation. With the parameter **Dim** the backlight of the transmitter screen during the dimmed state can be adjusted. Press the + or - buttons in the corresponding line to adjust the parameters.



## 7.10 Digital Inputs

PATH:  \ CONFIG \ Digital Inputs

See the following explanation to get more details about the different settings for the digital inputs



Press the related button for the assignment of the **Channel** (Chan\_). Select the channel, which has to be linked to the digital input signal.

Press the input field in the line of the setting for **Mode** and select the impact of an active digital input signal. Choose 'HOLD' to lead the assigned channel in HOLD state.

Press the related button for the assignment of the **Digital Inputs** and select the digital input signal, which has to be linked to the channel.

An additional setting can be done, if a digital input signal has been selected.

Press the input field in the line for the setting of the **State** and select if the digital input is active at high or low level of the voltage input signal.

## 7.11 System

PATH:  \ CONFIG \ System

See the following explanation to get more details about the different settings for the System.

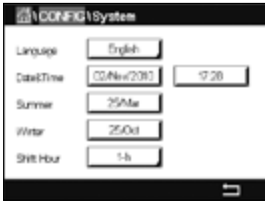

Select the desired **Language**. The following languages are available: English, French, German, Italian, Spanish, Portuguese, Russian, Chinese, Korean or Japanese.

Enter **Date&Time**.

The automatic change-over from summertime to wintertime and vice-versa frees the users from having to correct the time twice a year.

The winter to summer time-change is carried out automatically using the 12-month clock integrated in the transmitter. The date for the time-change can be set with the parameter **Summer**.

Provided it is a Sunday, the time-change would take place on the day that equates with the value, otherwise on the following Sunday. The winter/summer time-change takes place at 02:00 h.

The summer to winter time-change is carried out automatically using the 12-month clock integrated in the transmitter. The date for the time-change can be set through the parameter **Winter**.

Provided it is a Sunday, the time-change would take place on the day that equates with the value, otherwise on the following Sunday. The winter/summer time-change takes place at 03:00 h.

The number of hours, the clock will be shifted through the winter to summer and summer to winter time-change can be chosen. Press the related button for the setting of the **Shift Hour**.

## 7.12 PID Controller

PATH:  \ CONFIG \ PID Controller

PID control is proportional, integral and derivative control action that can provide smooth regulation of a process. Before configuring the transmitter, the following process characteristics must be identified.

Identify the **control direction** of the process

– **Conductivity:**

Dilution – direct acting where increasing measurement produces increasing control output such as controlling the feed of low conductivity diluting water to rinse tanks, cooling towers or boilers

Concentrating – reverse acting where increasing measurement produces decreasing control output, such as controlling chemical feed to attain a desired concentration

– **Dissolved Oxygen:**

Deaeration – direct acting where increasing Dissolved Oxygen concentration produces increasing control output such as controlling the feed of a reducing agent to remove oxygen from boiler feedwater

Aeration – reverse acting where increasing Dissolved Oxygen concentration produces decreasing control output, such as controlling an aerator blower speed to maintain a desired Dissolved Oxygen concentration in fermentation or wastewater treatment

– **pH/ORP:**

Acid feed only – direct acting where increasing pH produces increasing control output, also for ORP reducing reagent feed

Base feed only – reverse acting where increasing pH produces decreasing control output, also for ORP oxidizing reagent feed

Both acid and base feed – direct and reverse acting

Identify the **control output type** based on the control device to be used:

Pulse frequency – used with pulse input metering pump

Pulse length – used with solenoid valve

Analog – used with current input device such as electric drive unit, analog input metering pump or current-to-pneumatic (I/P) converter for pneumatic control valve

Default control settings provide linear control, which is appropriate for conductivity, dissolved oxygen. Therefore, when configuring PID for these parameters (or simple pH control) ignore settings of deadband and corner points in the tuning parameter section below. The non-linear control settings are used for more difficult pH/ORP control situations.

If desired, identify the non-linearity of the pH/ORP process. Improved control can be obtained if the non-linearity is accommodated with an opposing non-linearity in the controller. A titration curve (graph of pH or ORP vs. reagent volume) made on a process sample provides the best information. There is often a very high process gain or sensitivity near the setpoint and decreasing gain further away from the setpoint. To counteract this, the instrument allows for adjustable non-linear control with settings of a deadband around the setpoint, corner points further out and proportional limits at the ends of control as shown in the figure below.

Determine the appropriate settings for each of these control parameters based on the shape of the pH process titration curve.

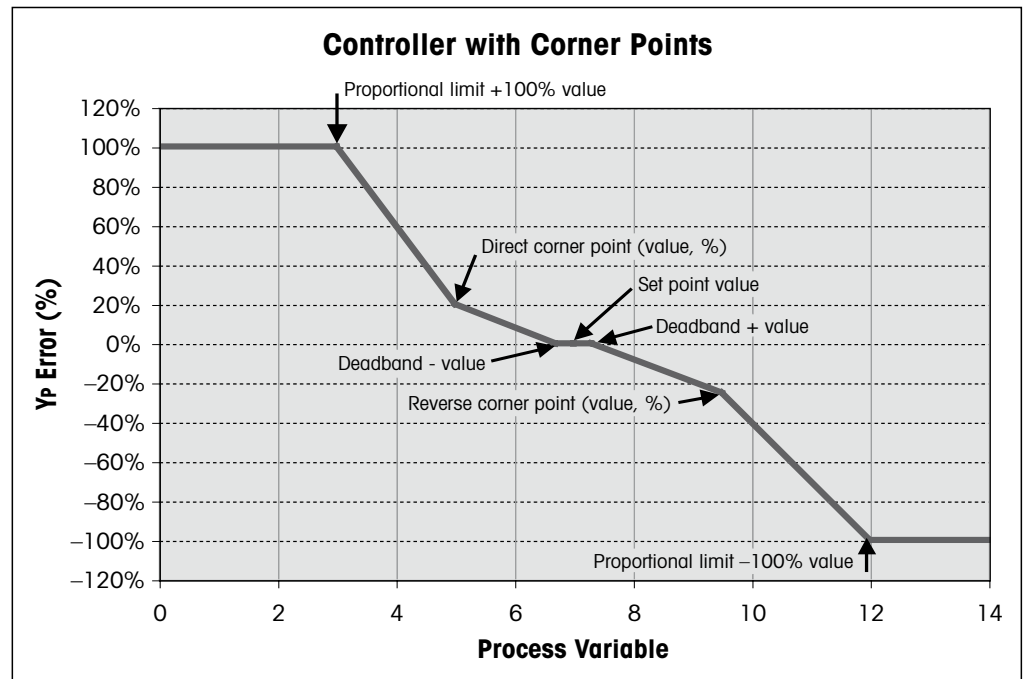

See the following explanation to get more details about the different settings for PID Controller.

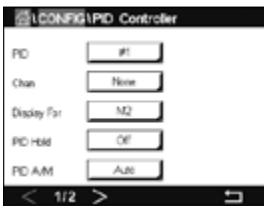

The M300 provides one PID controller. Press the input field in the line of the setting for **PID**.

Press the related button for the assignment of the channel (**Chan**). Select the channel, which has to be linked to the PID Controller. To deactivate the PID controller press None.

Press the button for the assignment of the measuring parameter – based on the selected channel – that has been linked to the PID controller. Choose the measuring parameter by pressing the according field. Mx in the display indicates the measurement assigned to the PID Controller. (see chapter 7.1.1 “Channel Setup”).

The M300 offers the display of control output (%PID) of the PID controller in the Start Screen and Menu Screen. Press the related button for **Display For** and select the line, the control output should be displayed by pressing the corresponding field.



**NOTE:** The control output of the PID controller will be displayed instead of the measurement, that has been defined to be shown in the corresponding line (see chapter 7.1.1 “Channel Setup”).

Select with the parameter **PID HOLD** the state of the control output for the PID controller if the M300 Transmitter is in HOLD mode. Off means that the control output will be 0%PID if the transmitter is in HOLD mode. If Last Value has been chosen, the value for the control output signal before the transmitter went into HOLD mode will be used.

The parameter **PID A/M** allows selection of auto or manual operation for the PID controller. If auto has been chosen, the transmitter calculates the output signal based on the measured value and the settings of the parameters for the PID controller. In the case of manual operation, the transmitter shows in the Menu Screen at the line where the output signal is displayed two additional arrow buttons. Press the arrows buttons to increase or decrease the PID output signal.



**NOTE:** If Manual has been chosen the values for the time constants, gain, corner points, proportional limits, setpoint and deadband do not have any influence on the output signal.

Additional settings can be done by navigating to the next page of the menu.

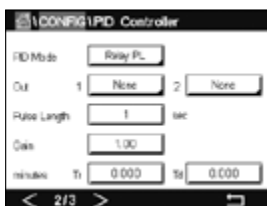

The **PID Mode** assigns a relay or analog output for PID control action. Based on the control device being used, select one of the three options Relay PL, Relay PF and Aout through pressing the corresponding field

Relay PL: If using a solenoid valve, select Relays PL (Pulse Length).

Relay PF: If using a pulse input metering pump, select Relays PF (Pulse Frequency)

Aout: For using an analog control select Aout.

Link the output signal **Out1,2** of the PID controller to the desired output of the transmitter. Press the related button for Out 1 and Out 2 and select the corresponding number for the output through pressing the according field. #1 means relay 1 or Aout 1, #2 means relay 2 our Aout 2 etc.



**NOTE:** Take care if reed type relays are linked to the controlling function. The reed type relays could be used for pulse frequency control devices and light duty applications. The current is limited to 0.5 amps and 10 watts (see also chapter 14.2 "Electrical specifications"). Do not connect to this relays higher current devices.

If the PID Mode is set to Relay PL, the Puls Length for the output signal of the transmitter can be adjusted. Press the button for **Pulse Length** and the M300 displays a keypad for modifying the value. Enter the new value in the unit seconds according to the table below and press  $\leftarrow$ .



**NOTE:** A longer pulse length will reduce wear on the solenoid valve. The % "on" time in the cycle is proportional to the control output.

	1 <sup>st</sup> Relay Position (Out 1)	2 <sup>nd</sup> Relay Position (Out 2)	Pulse Length (PL)
Conductivity	Controlling concentrating reagent feed	Controlling dilution water	Short (PL) provides more uniform feed. Suggested start point = 30 sec
pH/ORP	Feeding base	Feeding acid	Reagent addition cycle: short PL provides more uniform addition of reagent. Suggested start point = 10 sec
Dissolved Oxygen	Reverse control action	Direct acting control action	Feed cycle time: short PL provides more uniform feed. Suggested start point = 30 sec

If the PID Mode is set to Relay PF, the Pulse Frequency for the output signal of the transmitter can be adjusted. Press the button for **Pulse Freq** and enter the new value in the unit pulse / minute according to the table below.



**NOTE:** Set the pulse frequency to the maximum frequency allowed for the particular pump being used, typically 60 to 100 pulses/minute. Control action will produce this frequency at 100% output.



**CAUTION:** Setting the pulse frequency too high may cause the pump to overheat.

	1 <sup>st</sup> Relay Position = #3	2 <sup>nd</sup> Relay Position = #4	Pulse Frequency (PF)
Conductivity	Controlling concentrating chemical feed	Controlling dilution water	Max allowed for the pump used (typically 60–100 pulses/minute)
pH/ORP	Feeding base	Feeding acid	Max allowed for the pump used (typically 60–100 pulses/minute)
Dissolved Oxygen	Reverse control action	Direct acting control action	Max allowed for the pump used (typically 60–100 pulses/minute)

If the PID Mode is set to **Aout**, the type for the analog output signal of the transmitter can be selected. Press the corresponding button and choose between 4 to 20 mA and 0 to 20 mA for the output signal by pressing the according field.

For the assignment of the analog output signal consider the table below.

	1 <sup>st</sup> Analogout Position = Out 1	2 <sup>nd</sup> Analogout Position = Out 2
Conductivity	Controlling concentrating chemical feed	Controlling dilution water
pH/ORP	Feeding base	Feeding acid
Dissolved Oxygen	Reverse control action	Direct acting control action

Press the input field for the parameter **Gain** to enter the gain of the PID controller as a unitless value. Gain represents the maximum value of the output signal of the PID controller in per cent (value 1 corresponds to 100%).

Press the corresponding input field in the line of **min** to adjust the Parameter integral or reset time **Tr** (left button) and/or rate of derivate time **Td** (right button).



**NOTE:** Gain, integral and derivate time are usually adjusted later by trial and error on process response. It is recommended to start with the value  $Td = 0$ .

Further settings can be done by navigating to the next page of the menu.

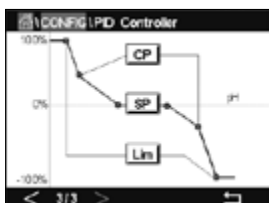

The display shows PID controller curve with input buttons for the corner points, setpoint and proportional limit for 100%.

Press the button **CP** to enter the menu for adjusting the corner points.

Page 1 shows the Corner Limit Low settings. Press the corresponding button to modify the value for the process parameter and the related output signal in %.

Browse to page 2 and the Corner Limit High settings are displayed. Press the corresponding button to modify the value for the process parameter and the related output signal in %.

Press the button **SP** to enter the menu for adjusting the setpoint and the dead band.

Press the button **Lim** to enter the menu for adjusting the proportional limit high and the proportional limit low, the range over which control action is required.

## 7.13 Service

PATH:  \ CONFIG \ Service

This menu is a valuable tool for troubleshooting and provides diagnostic functionality for the following items: Calibrate TouchPad, Set Analog Outputs, Read Analog Outputs, Read Analog Inputs, Set Relays, Read Relays, Read Digital Inputs, Memory and Display.



Select through the parameter **System** the desired item for diagnostic by pressing the according field.

Select through **Chan** the channel for diagnostic information of the sensor. This menu is only displayed if a sensor is connected.

The provided diagnostic functionality can now be called up through pressing the button **Diagnostic**.

### 7.13.1 Set Analog Outputs

The menu enables the user to set all analog outputs to any mA value within the 0–22 mA range. Use the + and – button to adjust the mA output signal. The transmitter will adjust the output signals according to the measurement and configuration of the analog output signals.

### 7.13.2 Read Analog Outputs

The menu shows the mA value of the analog outputs.

### 7.13.3 Set Relay

The menu allows the user to open or close each relay manually. If the menu is exited, the transmitter will switch the relay according to configuration.

### 7.13.4 Read Relay

The menu shows the state of every relay. On indicates the relay is closed, Off indicates that the relay is open.

### 7.13.5 Read Digital Inputs

The menu shows the state of the digital input signals.



### **7.13.6 Memory**

If Memory is selected the transmitter will perform a memory test of all connected transmitter boards and ISM sensors.

### **7.13.7 Display**

The transmitter shows every 5 seconds red, green, blue, grey and dark grey display and returns afterwards to the menu Service. If within the 5 seconds for every color the screen is pressed the transmitter will go to the next step.

### **7.13.8 Calibrate TouchPad**

During the 4 calibrations steps, always press the center of the circle shown circle in the 4 corners of the display. The transmitter will show the calibration result.

### **7.13.9 Channel Diagnostic**

If an error has occurred with the sensor, the corresponding messages are displayed.

## 7.14 User Management

PATH:  \ CONFIG \ User Management

This menu allows for the configuration of different user and administrator passwords, as well as setting up a list of allowed menus for the different users. The administrator has rights to access all menus. All default passwords for new transmitters are "00000000".

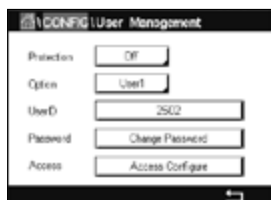

Press the input field in the line of **Protection** and select the desired kind of protection. The following options are available:

**Off:** No protection

**Active:** Activation of the Menu Screen (see chapter 3.4 "Display") has to be confirmed

**Password:** Activation of the Menu Screen is only possible with a password

Press the according button for **Option** to select the profile for the administrator (Admin) or one of the users.



**NOTE:** The administrator always has the rights to access all menus. For different users the access rights can be defined.

Press the input button for **UserID** to enter the name for the user or administrator. The name for the user or administrator will be displayed if the protection via password is selected for activation of the Menu Screen.

For changing the password of the selected user or administrator press the input field for **Password**. Enter the old password in the field Old PW, the new one in the field New PW and confirm it in the field confirm PW. The default password is "00000000" for the administrator and all users.

If the profile for a user has been selected an additional input field to define the access rights will be displayed.

To assign access rights the according button for the menu has to be pressed. In case of an assignment of the access rights,  is displayed in the related button.

## 7.15 Reset

PATH:  \ CONFIG \ Reset

Depending on the transmitter version and configuration different options for a reset are available.

See the following explanation to get more details about the different option to reset data and / or configurations.

### 7.15.1 System Reset

This menu option allows the reset of the M300 Transmitter to the factory default settings (set-points off, analog outputs off, passwords, etc.). Furthermore the calibration factors for analog in- and outputs, meter etc. can be set to the last factory values.

Press the input field for **Options** and select System.

Press the input field for **Items** (Configure button) and select the different parts of the configuration that will be reset.

If an item has been selected the Action menu is displayed. Press the Reset button.

## 7.15.2 Reset Sensor Calibration for UniCond 2-e Sensors

For UniCond 2-e sensors, the SensorCal (sensor calibration) and ElecCal (sensor electronics calibration) can be restored to factory settings.

Press the input field for **Options** and select the channel the UniCond 2-e sensor is connected to.

Press the input field for **Item** (Configure button). Select SensorCal to Factory and/or ElecCal to Factory by checking the adjacent box. Press  $\leftarrow$  enter to accept the value.

If an item has been selected the Action menu is displayed. Press the Reset button.

The M300 will bring up the confirmation dialog. Select Yes and the reset will be executed. Press No to go back to menu Reset without performing the reset.

## 7.16 USB Output

PATH:  \ CONFIG \ USB Output

This menu allows to print measurement values of different channels by a printer or to output measurement values for data log by USB communication. The configuration data like printer line, printer interval time and each line's measurement can be set by user.



Select the Output Mode, Off or Printer.

## 7.16.1 Printer Output Configuration

The Printer menu option allows configuring the M300 USB output to send data to a suitable printer. The printer output may be configured to print up to 6 configure measurements on separate lines, for each available sensor input, including pulsed input channels. At each print cycle, the output will include a header line with data and time based on the M300 internal clock, and one line for each configured measurement including channel, measurement descriptor, measurement value and unit of measure.

The output will appear as follows:

11/May/2012 15:36

Ch Label Measurement

1 CHAN\_1 302 ppbO2

2 CHAN\_2 0.54 uS/cm

3 CHAN\_3 7.15 pH

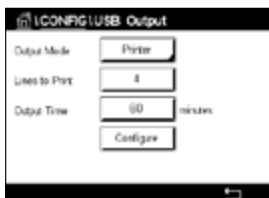

To configure the printer output, select option Printer for Output Mode. Configure the following options:

**Lines to Print** will configure the number of measurements that will be printed for each print cycle. Enter the total number of measurements to be configured for output. Lines to Print may be set from 1 to 8.

**Output Time** defines the time in minutes between each print cycle. Output time may be set from 1 to 1000 minutes.

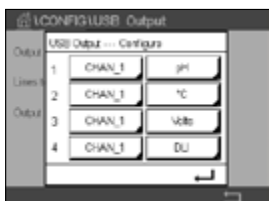

Once the output time and print lines have been established, press the Configure button to format the printer output. The number at the left of the window shows the order in which the lines will appear on the printer output. From the first dropdown, select the channel which the desired sensor is connected. This dropdown will list the labels associated with each channel as configured under Channel Setup. Using the second dropdown, select the unit associated with the measurement to be displayed. Note that if more than 4 lines of output has been selected, use the < and > icons to navigate through the pages to be configured.

## 8 ISM

For the menu structure refer to chapter 3.10 "Graphic Trend Measurement".

PATH:  \ ISM

### 8.1 iMonitor

PATH:  \ ISM \ iMonitor

The iMonitor gives an overview of the current state of the complete loop at a glance.



The iMonitor of the first channel is displayed on the screen. To browse through the iMonitor for the different channels press > at the bottom of the display.

The values DLI, TTM and ACT as well as TTCal in combination with UniCond 2-e sensors are shown as bar graph. If the values falls below 20% of the initial value the bar graph changes from green to yellow color. If the value falls below 10% the color changes to red.

For Cond4e sensors the days in operation of the sensor are displayed.

Furthermore SIP-, CIP-, AutoClave-, SAN-cycles as well as the values for Rg and Rref can be displayed and assigned to a colored button if the values are provided by the sensor.

The color for the related button of SIP-, CIP-, Autoclave- and SAN-cycles will change from green to yellow if less than 20% of the defined maximum quantity for the cycle remain and to red if less than 10% remain. For configuration of the maximum quantity see chapter 7.5 "ISM Setup (ISM Sensors only)".

The buttons for Rg and Rref change to yellow if the conditions for a warning messages are fulfilled and to red if the conditions for a alarm message are fulfilled. The buttons remain grey if the corresponding ISM alarm is not configured (see chapter 7.7 "ISM / Sensor Alarm").

Depending on the measured parameter (connected sensor) the following data are available in the menu iMonitor:

pH: DLI, TTM, ACT, CIP, AutoClave, SIP\*, Rg\*\*, Rref\*\*  
 Amperometric O<sub>2</sub>: DLI, TTM, ACT, CIP, AutoClave, SIP\*, Electrolyte\*\*\*  
 O<sub>3</sub>: DLI, TTM, ACT, SAN  
 Conductivity: Days in operation, TTCal\*\*\*\*, CIP, SIP

- \* if AutoClave has not been activated (see chapter 7.7 "ISM / Sensor Alarm")
- \*\* if the alarm for Rg and/or Rref has been activated (see chapter 7.7 "ISM / Sensor Alarm")
- \*\*\* if the alarm for Electrolyte Level Error has been activated (see chapter 7.7 "ISM / Sensor Alarm")
- \*\*\*\* if UniCond 2-e sensor is connected

## 8.2 Messages

PATH:  \ ISM \ Messages



The messages for occurred warnings and alarms are listed in this menu. Up to 100 entries will be listed.



5 messages per page are listed. If more than 5 messages are available additional pages can be accessed.

Unacknowledged alarms or warnings will be listed at the beginning. Then the acknowledged but still existing alarm or warnings are listed. At the end of the list the already solved warning and alarms are described. Between these groups the messages are listed chronologically.

The state of the warning or alarm is indicated through the following signs:

Symbol	Description	Meaning
	Alarm symbol is blinking	Alarm exists and has not been acknowledged
	Alarm symbol is not blinking	Alarm exists and has been acknowledged
	Warning symbol blinking	Warning exists and has not been acknowledged
	Warning symbol is not blinking	Warning exists and has been acknowledged
	OK symbol is not blinking	Warning or alarm has been solved

An unacknowledged warning or alarm will be acknowledged by pressing the **Info** button in the corresponding line.

For every message the corresponding **Info** button can be pressed. Message information, date and time the warning or alarm has been occurred and the status of the alarm or message are displayed.

If warning or alarm has already been solved the pull up window for the message shows an additional button to clear the message i.e. to delete it from the message list.

## 8.3 ISM Diagnostics

PATH:  \ ISM \ ISM Diagnostics

The M300 Transmitter provides for all ISM sensors a diagnostic menu. Access the menu Channel and select the channel by pressing the related input field.

Depending on the selected channel and assigned sensor different diagnostic menus are displayed. See the following explanation to get more details about the different diagnostic menus.

### 8.3.1 pH/ORP, Oxygen, O<sub>3</sub> and Cond4e Sensors

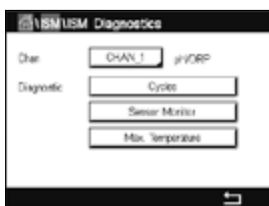

If an pH/ORP, oxygen, O<sub>3</sub> or Cond4e sensor is connected to the selected channel, the diagnostic menus cycles, sensor monitor and max. temperature are available.

Press the **Cycle** button and the information for CIP, SIP and Autoclave cycles of the connected sensor are displayed. The displayed information shows the amount of cycles the sensor has been exposed and the max. limitation for the corresponding cycle as defined in the menu ISM Setup (see chapter 7.5 "ISM Setup (ISM Sensors only)").



**NOTE:** For Cond4e, which are not autoclavable the menu AutoClave Cycles is not displayed.



**NOTE:** For O<sub>3</sub> sensors the SAN cycles are displayed.

Press the **Sensor Monitor** button and the information for DLI, TTM and ACT of the connected sensor are displayed. The values DLI, TTM and ACT are shown as bar graph. If the values falls below 20% of the initial value the bar graph changes from green to yellow color. If the value falls below 10% the color changes to red.



**NOTE:** For Cond4e sensors the operating hours are displayed.

Press the **Max. Temperature** button and the information about the maximum temperature, that the connected sensor has ever seen, together with a time stamp of this maximum is displayed. This value is stored on the sensor and cannot be changed. During autoclaving the max. temperature is not recorded.

### 8.3.2 UniCond 2-e and UniCond 4-e Sensors

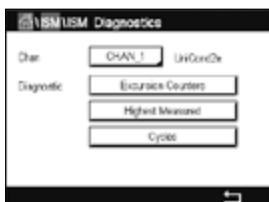

For UniCond 2-e and UniCond 4-e sensors, the following diagnostic items can be viewed: Excursion Counters including High Temp and High Conductivity, Highest Measured including Highest Temp and Highest Cond, Cycles including CIP cycles and SIP Cycles.

## 8.4 Calibration Data

PATH:  \ ISM \ Calibration Data

The M300 Transmitter provides a calibration history for all ISM sensors. Depending on the selected channel and assigned sensor different data is available for the calibration history.

See the following explanation to get more details about the different data available for the calibration history.

### 8.4.1 Calibration Data for All ISM Sensors excluding UniCond 2-e and UniCond 4-e

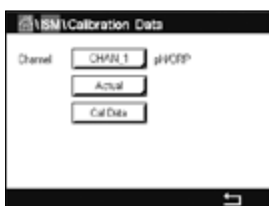

If an ISM sensor – excluding UniCond 2-e and UniCond 2-e – is connected to the selected channel between the calibration data set of

**Actual** (Actual adjustment): This is the actual calibration dataset which is used for the measurement. This dataset moves to Cal1 position after the next adjustment.

**Factory** (Factory calibration): This is the original dataset, determined in the factory. This dataset remains stored in the sensor for reference and cannot be overwritten.

**1.Adjust** (First adjustment): This is the first adjustment after the factory calibration. This dataset remains stored in the sensor for reference and cannot be overwritten

**Cal1** (last calibration/adjustment): This is the last executed calibration/adjustment data set. This dataset moves to Cal2 and then to Cal3 when a new calibration/adjustment is performed. Afterwards, the dataset is not available anymore. Cal2 and Cal3 acting in the same way as Cal1.

**Cal2** and **Cal3** can be chosen. For the selection of the calibration data set press the corresponding field.



**NOTE:** The amperometric oxygen sensor of THORNTON and the O<sub>3</sub> sensor do not provide the data set Cal1, Cal2, Cal3 and 1.Adjust.

Press the **Cal Data** button and the corresponding calibration data set is displayed. Furthermore the time stamp for the calibration and the User ID is listed.



**NOTE:** This function requires the correct setting of date and time during calibration and / or adjustment tasks (see chapter 7.11 "System").



## 8.4.2 Calibration Data for UniCond 2-e and UniCond 4-e Sensors



For UniCond 2-e and UniCond 4-e sensors the following three sets of calibration data may be selected:

**Actual (Actual calibration):** This is the actual calibration dataset which is used for the measurement.

**Factory (Factory calibration):** This is the original dataset, determined in the factory. This dataset remains stored in the sensor for reference and cannot be overwritten.

**Cal1 (last calibration/adjustment):** This is the last executed calibration/adjustment data set.

Press the Cal Data button and the corresponding calibration data set is displayed.

If the data set of the actual calibration has been chosen, on page 1, the date and time of the calibration, User ID, conductivity calibration constants, and reference conductivity values to calibrate are displayed. On page 2 the As-found conductivity values and the deviation from the reference are shown. On page 3 and 4 the same information for temperature is displayed. On page 5 the calibration cycles applied to the sensor and the next calibration date for conductivity (C) and temperature (T) are displayed.

If the dataset of the factory calibration has been chosen, on page 1, the date and time of the calibration, the conductivity calibration constants, and reference conductivity values used to calibrate are displayed. On page 2, the same values for temperature are shown.

Press  $\leftarrow$  to exit the menu Cal Data.



**NOTE:** This function requires the correct setting of date and time during calibration and / or adjustment tasks (see chapter 7.11 "System").

## 8.5 Sensor Info

PATH:  $\leftarrow$  \ ISM \ Sensor Info

The model, hardware and software version, last calibration date as well as the product and serial number of the ISM sensors, that are connected to the M300 Transmitter can be displayed on the screen.

Enter Sensor Info.

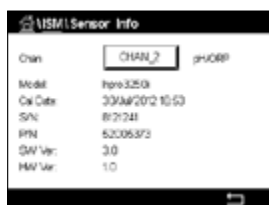

The data of the first channel, a sensor is connected, are displayed on the screen. Press the input field in the line of Chan. To get the data of the desired sensor select the corresponding channel by pressing the according field.

The data Model, Cal Date (date of last adjustment), S/N (serial number), P/N (product number), SW Ver (software version) and HW Ver (hardware version) of the select sensor are displayed.



**NOTE:** If a UniCond 2-e sensor is connected the following data is also displayed, Temp Sens. (temperature sensor) Electrode (electrode material), Body/Ins Mat: (body and/or insulator material), Inner: (inner electrode material), Outer (outer electrode material) Fitting: (fitting material), Class VI (FDA Class VI material).

To exit the menu Sensor Info press  $\leftarrow$ . To return to the Menu Screen press  $\text{Home}$ .

## 8.6 HW / SW Version

PATH:  $\text{Home}$  \ ISM \ HW/SW Version

The hardware and software version as well as the product number and serial number of the M300 Transmitter itself or the different boards, that are plugged in can be displayed on the screen.



The data of the transmitter is displayed on the screen. Press the input field in the line of **M300**. To select the data of the desired board or the transmitter itself press the corresponding field.

The data S/N (serial number), P/N (product number), SW Ver (software version) and HW Ver (hardware version) of the select board or transmitter are displayed.

## 9 Favorites

PATH:  \ FAVORITE

The M300 Transmitter allows set up of up to 4 favorites to ensure a quick access for frequently used functions.

### 9.1 Set Favorite

PATH:  \ FAVORITE \ Set Favorite

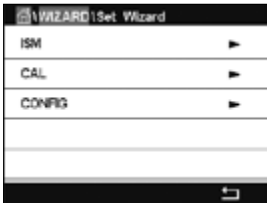

The main menus are displayed. Choose the menu, that contains the function, which should be defined as a favorite, e.g. ISM through pressing the corresponding arrow ► in the same line.

Choose the function, that should be set as a favorite by activating the option. A function, which is set as a favorite shows ★ icon.



**NOTE:** Deactivate the option by pressing on the icon again. The favorite ★ icon is not shown any more.

### 9.2 Access to Favorites

Access the menu Set Favorites. The favorites defined are listed on this page. Press the corresponding arrow ► for the function in the same line.

## 10 Maintenance

### 10.1 Front panel cleaning

Clean the surfaces with a soft damp cloth and dry the surfaces with a cloth carefully.

## 11 Software History

### 11.1 M300 Process

Software version	Release date	Software changes	Documentation / Issue
V1.0.0	February 2016	–	30 216 266 M300 Transmitter 02/2017

### 11.2 M300 Water

Software version	Release date	Software changes	Documentation / Issue
V1.0.0	February 2016	–	30 216 266 M300 Transmitter 02/2017

### 11.3 M300 Water Cond/Res

Software version	Release date	Software changes	Documentation / Issue
V1.0.0	February 2016	–	30 216 266 M300 Transmitter 02/2017

## 12 Troubleshooting

If the equipment is used in a manner not specified by Mettler-Toledo, the protection provided by the equipment may be void.

Review the table below for possible causes of common problems:

Problem	Possible Cause
Display is blank.	<ul style="list-style-type: none"> <li>– No power to M300.</li> <li>– Hardware failure.</li> </ul>
Incorrect measurement readings.	<ul style="list-style-type: none"> <li>– Sensor improperly installed.</li> <li>– Incorrect units multiplier entered.</li> <li>– Temperature compensation incorrectly set or disabled.</li> <li>– Sensor or transmitter needs calibration.</li> <li>– Sensor or patch cord defective or exceeds recommended maximum length.</li> <li>– Hardware failure.</li> </ul>
Measurement readings not stable.	<ul style="list-style-type: none"> <li>– Sensors or cables installed too close to equipment that generates high level of electrical noise.</li> <li>– Recommended cable length exceeded.</li> <li>– Averaging set too low.</li> <li>– Sensor or patch cord defective.</li> </ul>
Alarm symbol is shown.	<ul style="list-style-type: none"> <li>– Setpoint is in alarm condition (setpoint exceeded).</li> <li>– Alarm has been selected (see chapter 7.7 "ISM / Sensor Alarm") and occurred.</li> </ul>
Cannot change menu settings.	<ul style="list-style-type: none"> <li>– User locked out for security reasons.</li> </ul>

### 12.1 Conductivity (resistive) Error messages/ Warning- and Alarm list for analog sensors

Alarms	Description
Watchdog time-out*	SW/System fault
Cond Cell open*	Cell running dry (no measurement solution) or wires are broken
Cond Cell shorted*	Short circuit caused by sensor or cable

\* Activate this function in the transmitter settings (see chapter 7.6 "General Alarm"  
PATH: Menu / General Alarm).

## 12.2 Conductivity (resistive) Error messages/ Warning- and Alarm list for ISM sensors

Alarms	Description
Watchdog time-out*	SW/System fault
Dry Cond sensor*	Cell running dry (no measurement solution)
Cell deviation*	Multiplier out of tolerance** (depends on sensor model).

\* Activate this function in the transmitter settings (see chapter 7.7 "ISM / Sensor Alarm" PATH: Menu/ISM/Sensor Alarm).

\*\* For further information refer to the sensor documentation

## 12.3 pH Error messages/Warning- and Alarm list

### 12.3.1 pH sensors except dual membrane pH electrodes

Warnings	Description
Warning pH Slope >102%	Slope too big
Warning pH Slope <90%	Slope too small
Warning pH Zero $\pm$ 0.5 pH	Out of range
Warning pHGs change <0.3**	Glass electrode resistance changed by more than factor 0.3
Warning pHGs change >3**	Glass electrode resistance changed by more than factor 3
Warning pHRef change <0.3**	Reference electrode resistance changed by more than factor 0.3
Warning pHRef change >3**	Reference electrode resistance changed by more than factor 3

Alarms	Description
Watchdog time-out*	SW/System fault
Error pH Slope >103%	Slope too big
Error pH Slope <80%	Slope too small
Error pH Zero $\pm$ 1.0 pH	Out of range
Error pH Ref Res >150 K $\Omega$ **	Reference electrode resistance too big (break)
Error pH Ref Res <1000 $\Omega$ **	Reference electrode resistance too small (short)
Error pH Gls Res >2000 M $\Omega$ **	Glass electrode resistance too big (break)
Error pH Gls Res <5 M $\Omega$ **	Glass electrode resistance too small (short)

\* ISM sensors only

\*\* Activate this function in the transmitter settings (see chapter 7.7 "ISM / Sensor Alarm" PATH: Menu/ISM/Sensor Alarm).

### 12.3.2 Dual membrane pH electrodes (pH/pNa)

Warnings	Description
Warning pH slope >102%	Slope too big
Warning pH Slope < 90%	Slope too small
Warning pH Zero $\pm$ 1.3 pH	Out of range
Warning pHGs change < 0.3*	Glass electrode resistance changed by more than factor 0.3
Warning pHGs change > 3*	Glass electrode resistance changed by more than factor 3
Warning pNaGs change < 0.3*	Glass electrode resistance changed by more than factor 0.3
Warning pNaGs change > 3*	Reference electrode resistance changed by more than factor 3

Alarms	Description
Watchdog time-out	SW/System fault
Error pH Slope >103%	Slope too big
Error pH Slope < 80%	Slope too small
Error pH Zero $\pm$ 2 pH	Out of range
Error pNa Gls Res > 2000 M $\Omega$ *	Glass electrode resistance too big (break)
Error pNa Gls Res < 5 M $\Omega$ *	Glass electrode resistance too small (short)
Error pH Gls Res > 2000 M $\Omega$ *	Glass electrode resistance too big (break)
Error pH Gls Res < 5 M $\Omega$ *	Glass electrode resistance too small (short)

\* Activate this function in the transmitter settings (see chapter 7.7 "ISM / Sensor Alarm" PATH: Menu/ISM/Sensor Alarm).

### 12.3.3 ORP messages

Warnings*	Description
Warning ORP ZeroPt > 30 mV	Zero offset too big
Warning ORP ZeroPt < -30 mV	Zero offset too small

Alarms*	Description
Watchdog time-out	SW/System fault
Error ORP ZeroPt > 60 mV	Zero offset too big
Error ORP ZeroPt < -60 mV	Zero offset too small

\* ISM sensors only

## 12.4 Amperometric O<sub>2</sub> Error messages/ Warning- and Alarm list

### 12.4.1 High level oxygen sensors

Warnings	Description
Warning O <sub>2</sub> Slope < -90 nA	Slope too big
Warning O <sub>2</sub> Slope > -35 nA	Slope too small
Warning O <sub>2</sub> ZeroPt > 0.3 nA	Zero offset too big
Warning O <sub>2</sub> ZeroPt < -0.3 nA	Zero offset too small

Alarms	Description
Watchdog time-out*	SW/System fault
Error O <sub>2</sub> Slope < -110 nA	Slope too big
Error O <sub>2</sub> Slope > -30 nA	Slope too small
Error O <sub>2</sub> ZeroPt > 0.6 nA	Zero offset too big
Error O <sub>2</sub> ZeroPt < -0.6 nA	Zero offset too small
Electrolyte Low*	Too low level of electrolyte

\* ISM sensors only

### 12.4.2 Low level oxygen sensors

Warnings	Description
Warning O <sub>2</sub> Slope < -460 nA	Slope too big
Warning O <sub>2</sub> Slope > -250 nA	Slope too small
Warning O <sub>2</sub> ZeroPt > 0.5 nA	Zero offset too big
Warning O <sub>2</sub> ZeroPt < -0.5 nA	Zero offset too small

Alarms	Description
Watchdog time-out*	SW/System fault
Error Install O <sub>2</sub> Jumper	In case of using Hi Performance Oxygen a jumper has to be installed. See chapter 4.5.6 "TB3 and TB4 terminal definition for Amperometric Oxygen and Dissolved Ozone – Analog Sensors".
Error O <sub>2</sub> Slope < -525 nA	Slope too big
Error O <sub>2</sub> Slope > -220 nA	Slope too small
Error O <sub>2</sub> ZeroPt > 1.0 nA	Zero offset too big
Error O <sub>2</sub> ZeroPt < -1.0 nA	Zero offset too small
Electrolyte Low*	Too low level of electrolyte

\* ISM sensors only



## 12.5 Warning- and Alarm Indication

### 12.5.1 Warning Indication



Warnings are indicated by a warning symbol in the head line of the display. A warning message will be recorded and can be selected through the menu Messages (PATH:  $\text{ISM}\backslash\text{Messages}$ ; see also chapter 8.2 "Messages").



**NOTE:** If the warning has not been acknowledged, the head line of the display will blink. If the warning has already been acknowledged, the head line will be displayed continuously. See also chapter 8.2 "Messages". In the case of an unacknowledged warning or alarm the transmitter screen will not be dimmed or switched off even if the light time has been elapsed (see chapter 7.9 "Display Setup").



**NOTE:** If at the same time a channel has both an alarm and a warning indicated, the indication of the alarm will have higher priority. The alarm will be indicated (see chapter 12.5 "Warning- and Alarm Indication") on the Menu Screen or Start Screen, while the warning will not be shown.



Pressing the head line on the Menu Screen will lead to the Messages. Refer to chapter 8.2 "Messages" for the description of the functionality for this menu.



**NOTE:** The detection of some warnings can be activated/deactivated through (de)activating the corresponding alarm. Refer to chapter 7.7 "ISM / Sensor Alarm".

## 12.5.2 Alarm Indication



Alarms are indicated by an alarm symbol in the head line of the display. An alarm message will be recorded and can be selected through the menu Messages (PATH:  $\text{HOME} \setminus \text{ISM} \setminus \text{Messages}$ ; see also chapter 8.2 "Messages").



**NOTE:** If the alarm has not been acknowledged, the head line of the display will blink. If the alarm has already been acknowledged, the head line will be displayed continuously. See also chapter 8.2 "Messages". In the case of an unacknowledged warning or alarm the transmitter screen will not be dimmed or switched off even if the light time has been elapsed (see chapter 7.9 "Display Setup").



**NOTE:** If at the same time a channel has born an alarm and a warning indicated, the indication of the alarm will have higher priority. The alarm will be indicated (see chapter 12.5 "Warning- and Alarm Indication") on the Menu Screen or Start Screen, while the warning will not be shown.



Pressing the head line on the Menu Screen will lead to the Messages. Refer to chapter 8.2 "Messages" for the description of the functionality for this menu.



**NOTE:** The detection of some alarms can be activated/deactivated. Refer therefore to chapter 7.7 "ISM / Sensor Alarm".



**NOTE:** Alarms which are caused by a violation of the limitation of a setpoint or the range (PATH:  $\text{HOME} \setminus \text{CONFIG} \setminus \text{Set Points}$ ; see also chapter 7.4 "Set Points") will also be indicated on the display and recorded through the menu Messages (PATH:  $\text{HOME} \setminus \text{ISM} \setminus \text{Messages}$ ; see also chapter 8.2 "Messages").

## 13 Ordering Information, Accessories and Spare Parts

Please contact your local Mettler-Toledo sales office or representative for details on additional accessories and spare parts.

<b>Transmitter</b>	<b>Order no.</b>
M300 Process mixed 1-CH 1/4 DIN	30 280 770
M300 Process mixed 1-CH 1/2 DIN	30 280 771
M300 Process mixed 2-CH 1/4 DIN	30 280 772
M300 Process mixed 2-CH 1/2 DIN	30 280 773
M300 Water mixed 1-CH 1/4 DIN	30 280 776
M300 Water mixed 1-CH 1/2 DIN	30 280 777
M300 Water mixed 2-CH 1/4 DIN	30 280 778
M300 Water mixed 2-CH 1/2 DIN	30 280 779
M300 Water Cond/Res 2-CH 1/4 DIN	30 280 774
M300 Water Cond/Res 2-CH 1/2 DIN	30 280 775

<b>Description</b>	<b>Order no.</b>
Pipe mounting kit for 1/2 DIN	30 300 480
Panel mounting kit for 1/2 DIN for pipe diameter 40 to 60 mm (1.57" to 2.36")	30 300 481
Wall mounting kit for 1/2 DIN	30 300 482
Protective hood	30 073 328

## 14 Specifications

### 14.1 General specifications

#### pH/ORP (incl. pH/pNa)

Measurement parameters	pH, mV and temperature
pH display range	-2.00 to +16.00 pH
pH resolution	Auto/0.001/0.01/0.1/1 (can be selected)
pH accuracy <sup>1)</sup>	Analog: $\pm 0.02$ pH
mV range	-1500 to +1500 mV
mV resolution	Auto/0.001/0.01/0.1/1 mV (can be selected)
mV accuracy <sup>1)</sup>	Analog: $\pm 1$ mV
Temperature input <sup>2)</sup>	Pt1000/Pt100/NTC22k
Temperature measuring range	-30 to +130 °C (-22 to +266 °F)
Temperature resolution	Auto/0.001/0.01/0.1/1 (can be selected)
Temperature accuracy <sup>1)</sup>	Analog: $\pm 0.25$ °C ( $\pm 0.45$ °F)
Temperature compensation	Automatic/Manual
Max. sensor cable length	<ul style="list-style-type: none"> <li>• Analog: 10 to 20 m (33 to 65 ft) depending on sensor</li> <li>• ISM: 80 m (260 ft)</li> </ul>
Calibration	1-point, 2-point or process

1) ISM input signal causes no additional error.

2) Not required on ISM sensors

#### Amperometric oxygen

Measurement parameters	Dissolved oxygen (DO): Saturation or concentration and temperature
Measuring current range	Analog: 0 to -7000 nA
DO display ranges	<ul style="list-style-type: none"> <li>• Saturation: 0 to 500 % air, 0 to 200 % O<sub>2</sub> sat</li> <li>• Concentration: 0 ppb (<math>\mu\text{g/L}</math>) to 50.00 ppm (mg/L)</li> </ul>
DO accuracy <sup>1)</sup>	<ul style="list-style-type: none"> <li>• Saturation: <math>\pm 0.5</math> % of the measured value or <math>\pm 0.5</math> %, depending on which is larger</li> <li>• Concentration at high values: <math>\pm 0.5</math> % of the measured value or <math>\pm 0.050</math> ppm/<math>\pm 0.050</math> mg/L, depending on which is larger</li> <li>• Concentration at low values: <math>\pm 0.5</math> % of the measured value or <math>\pm 0.001</math> ppm/<math>\pm 0.001</math> mg/L, depending on which is larger</li> <li>• Concentration at traces values: <math>\pm 0.5</math> % of the measured value or <math>\pm 0.100</math> ppb/<math>\pm 0.1</math> <math>\mu\text{g/L}</math>, depending on which is larger</li> </ul>
DO resolution	Auto/0.001/0.01/0.1/1 (can be selected)
Polarization voltage	<ul style="list-style-type: none"> <li>• Analog O<sub>2</sub> High: Cal/Meas: -675 mV (not configurable)</li> <li>• Analog O<sub>2</sub> Low: Cal: -675 mV, Meas: -500 mV (not configurable)</li> </ul>
Temperature input	Pt1000/Pt100/NTC22k
Temperature compensation	Automatic
Temperature measuring range	-10 to +80 °C (+14 to +176 °F)
Temperature resolution	Auto/0.001/0.01/0.1/1 °C (°F) (can be selected)
Temperature accuracy <sup>1)</sup>	$\pm 0.25$ °C ( $\pm 0.45$ °F)
Max. sensor cable length	<ul style="list-style-type: none"> <li>• Analog: 20 m (65 ft)</li> <li>• ISM: 80 m (260 ft)</li> </ul>
Calibration	1-point (slope and offset) or process (slope and offset)

1) ISM input signal causes no additional error.

**Dissolved ozone**

Measurement parameters	Concentration and temperature
Display range for current	Analog: 0 to –7000 nA
Ozone measuring range	<ul style="list-style-type: none"> <li>• Short term: 0 to 5.00 ppm (mg/L) O<sub>3</sub></li> <li>• Continuous: 0 to 500 ppb (µg/L) O<sub>3</sub></li> </ul>
Ozone accuracy <sup>1)</sup>	Analog: ±0.5 % of reading or ±5 ppb
Resolution	± 1 digit
Temperature compensation	Automatic
Temperature measuring range	0 to +50 °C (+32 to +122 °F)
Temperature resolution	Auto/0.001/0.01/0.1/1 (can be selected)
Temperature accuracy <sup>1)</sup>	Analog: ±0.25 °C (±0.45 °F)
Max. sensor cable length	80 m
Calibration	1-point (offset) or process (slope and offset)

1) ISM input signal causes no additional error.

**Conductivity 2-e/4-e**

Measurement parameters	Conductivity/resistivity and temperature
Conductivity ranges	See sensor specification
Chemical concentration curves (used with 4-e sensors)	NaCl: 0–26% @ 0 °C to 0–28% @ +100 °C NaOH: 0–12% @ 0 °C to 0–16% @ +40 °C to 0–6% @ +100 °C HCl: 0–18% @ –20 °C to 0–18% @ 0 °C to 0–5% @ +50 °C HNO <sub>3</sub> : 0–30% @ –20 °C to 0–30% @ 0 °C to 0–8% @ +50 °C H <sub>2</sub> SO <sub>4</sub> : 0–26% @ –12 °C to 0–26% @ +5 °C to 0–9% @ +100 °C H <sub>3</sub> PO <sub>4</sub> : 0–35% @ +5 °C to +80 °C
TDS ranges	NaCl, CaCO <sub>3</sub>
Cond./Res accuracy <sup>1)</sup>	Analog: ±0.5 % of reading or 0.25 Ω
Cond./Res repeatability <sup>1)</sup>	Analog: ±0.25% of reading or 0.25 Ω
Cond./Res resolution	Auto/0.001/0.01/0.1/1 (can be selected)
Temperature input	Pt1000
Temperature measuring range	–40 to +200 °C (–40 to +392 °F)
Temperature resolution	Auto/0.001/0.01/0.1/1 (can be selected)
Temperature accuracy	Analog: ±0.25 °C (±0.45 °F) within –30 to +150 °C (–22 to +302 °F); ±0.50 °C (±0.90 °F) outside
Max. sensor cable length	<ul style="list-style-type: none"> <li>• Analog: 2-e sensors: 61 m (200 ft); 4-e sensors: 15 m (50 ft)</li> <li>• ISM: 2-e sensors: 90 m (300 ft); 4-e sensors: 80 m (260 ft)</li> </ul>
Calibration	1-point, 2-point or process

1) ISM input signal causes no additional error.

## 14.2 Electrical specifications

Supply voltage	<ul style="list-style-type: none"> <li>• 80 to 255 V AC, 50 to 60 Hz, 10 VA</li> <li>• 20 to 30 V DC, 10 VA</li> </ul>
Connection terminal	Detachable screw terminals, appropriate for wire cross section 0.2 to 1.5 mm <sup>2</sup> (AWG 16 – 24)
Mains fuse	2.0 A slow blow, type FC
Analog outputs	<ul style="list-style-type: none"> <li>• 4 for 2-channel versions</li> <li>• 2 for 1-channel versions</li> </ul>
Analog output signals	0/4 to 20 mA, 22 mA alarm, galvanically isolated from input and from earth / ground
Measurement error through analog outputs	< ±0.05 mA over 1 to 22 mA range
Analog output configuration	Linear, Bi-linear, Logarithmic, Auto range
Load	Max. 500 Ω
PID process controller	1 x PID with pulse length, pulse frequency or analog control output signal
Cycle time analog output	Ca. 1 s
Hold input/Alarm contact	Yes/Yes
Alarm output delay	0 to 999 s, selectable
Relays	<ul style="list-style-type: none"> <li>• 2 SPST, mechanical, 250 V AC or 30 V DC, 3 A</li> <li>• 2 SPST, Reed, 250 V AC or 250 V DC, 0.5 A, 10 W</li> </ul>
Digital input	<ul style="list-style-type: none"> <li>• 2 for 2-channel versions</li> <li>• 1 for 1-channel versions</li> </ul> With switching limits 0.00 V DC to 1.00 V DC inactive, 2.30 V DC to 30.00 V DC active; galvanically isolated up to 60 V from output, analog input and ground/ earth
User interface	<ul style="list-style-type: none"> <li>• TFT touch-screen 4"</li> <li>• Black and white</li> <li>• Resolution: ¼ VGA (320 pixel x 240 pixel)</li> </ul>
Languages	10 (English, German, French, Italian, Spanish, Portuguese, Russian, Japanese, Korean and Chinese)
Interfaces	<ul style="list-style-type: none"> <li>• 1 USB Host: Printer connection, data logging <sup>1)</sup>, loading configuration from USB stick and saving configuration to USB stick <sup>1)</sup></li> <li>• 1 USB Device: Software update interface</li> </ul>

1) In preparation

## 14.3 Environmental specifications

Storage temperature	–40 to +70 °C (–40 to +158 °F)
Ambient temperature operating range	–10 to +50 °C (–14 to +122 °F)
Relative humidity	0 to 95 % non-condensing
Altitude	Max. 2000 m
EMC	Compliant with EN 61326-1:2013 (Industrial environment) Emission: Class A, Immunity: Class A
UL	Installation (overvoltage) Category II
CE mark	The measuring system is in conformity with the statutory requirements of the EC Directives. METTLER TOLEDO confirms successful testing of the device by affixing to it the CE mark.

## 14.4 Mechanical specifications

### ½ DIN version

Dimensions	Housing –	136 x 136 x 116 mm
	Height x Width x Depth	(5.35 x 5.35 x 4.57 inch)
	Front bezel –	150 x 150 mm
	Height x Width	(5.91 x 5.91 inch)
	Max. depth – panel mounted	116 mm (4.57 inch) (excludes plug-in connectors)
Weight		0.95 kg (2 lb)
Material		ABS / Polycarbonate
Enclosure rating		IP 65

### ¼ DIN version

Dimensions	Housing –	91 x 91 x 122 mm
	Height x Width x Depth	(3.58 x 3.58 x 4.80)
	Front bezel –	112 x 112 mm
	Height x Width	(4.41 x 4.41 inch)
	Max. depth – panel mounted	122 mm (4.80 inch) (excludes plug-in connectors)
Weight		0.6 kg (1.5 lb)
Material		ABS / Polycarbonate
Enclosure rating		IP 65 (front) / IP 20 (rear)

## 15 Warranty

METTLER TOLEDO warrants this product to be free from significant deviations in material and workmanship for a period of one year from the date of purchase. If repair is necessary and not the result of abuse or misuse within the warranty period, please return by pre-paid freight and an amendment will be made without any charge. METTLER TOLEDO's Customer Service Dept. will determine if the product problem is due to deviations or customer abuse. Out-of-warranty products will be repaired on an exchange basis at cost.

The above warranty is the only warranty made by METTLER TOLEDO and is in lieu of all other warranties, expressed or implied, including, without limitation, implied warranties of merchantability and fitness for a particular purpose. METTLER TOLEDO shall not be liable for any loss, claim, expense or damage caused by, contributed to or arising out of the acts or omissions of the

Buyer or Third Parties, whether negligent or otherwise. In no event shall METTLER TOLEDO's liability for any cause of action whatsoever exceed the cost of the item giving rise to the claim, whether based in contract, warranty, indemnity, or tort (including negligence).



## 16 Buffer tables

M300 Transmitters have the ability to do automatic pH buffer recognition. The following tables show different buffers that are automatically recognized.

### 16.1 Standard pH buffers

#### 16.1.1 Mettler-9

Temp (°C)	pH of buffer solutions			
0	2.03	4.01	7.12	9.52
5	2.02	4.01	7.09	9.45
10	2.01	4.00	7.06	9.38
15	2.00	4.00	7.04	9.32
20	2.00	4.00	7.02	9.26
25	2.00	4.01	7.00	9.21
30	1.99	4.01	6.99	9.16
35	1.99	4.02	6.98	9.11
40	1.98	4.03	6.97	9.06
45	1.98	4.04	6.97	9.03
50	1.98	4.06	6.97	8.99
55	1.98	4.08	6.98	8.96
60	1.98	4.10	6.98	8.93
65	1.98	4.13	6.99	8.90
70	1.99	4.16	7.00	8.88
75	1.99	4.19	7.02	8.85
80	2.00	4.22	7.04	8.83
85	2.00	4.26	7.06	8.81
90	2.00	4.30	7.09	8.79
95	2.00	4.35	7.12	8.77

## 16.1.2 Mettler-10

Temp (°C)	pH of buffer solutions				
0	2.03	4.01	7.12	10.65	
5	2.02	4.01	7.09	10.52	
10	2.01	4.00	7.06	10.39	
15	2.00	4.00	7.04	10.26	
20	2.00	4.00	7.02	10.13	
25	2.00	4.01	7.00	10.00	
30	1.99	4.01	6.99	9.87	
35	1.99	4.02	6.98	9.74	
40	1.98	4.03	6.97	9.61	
45	1.98	4.04	6.97	9.48	
50	1.98	4.06	6.97	9.35	
55	1.98	4.08	6.98		
60	1.98	4.10	6.98		
65	1.99	4.13	6.99		
70	1.98	4.16	7.00		
75	1.99	4.19	7.02		
80	2.00	4.22	7.04		
85	2.00	4.26	7.06		
90	2.00	4.30	7.09		
95	2.00	4.35	7.12		

## 16.1.3 NIST Technical Buffers

Temp (°C)	pH of buffer solutions				
0	1.67	4.00	7.115	10.32	13.42
5	1.67	4.00	7.085	10.25	13.21
10	1.67	4.00	7.06	10.18	13.01
15	1.67	4.00	7.04	10.12	12.80
20	1.675	4.00	7.015	10.07	12.64
25	1.68	4.005	7.00	10.01	12.46
30	1.68	4.015	6.985	9.97	12.30
35	1.69	4.025	6.98	9.93	12.13
40	1.69	4.03	6.975	9.89	11.99
45	1.70	4.045	6.975	9.86	11.84
50	1.705	4.06	6.97	9.83	11.71
55	1.715	4.075	6.97		11.57
60	1.72	4.085	6.97		11.45
65	1.73	4.10	6.98		
70	1.74	4.13	6.99		
75	1.75	4.14	7.01		
80	1.765	4.16	7.03		
85	1.78	4.18	7.05		
90	1.79	4.21	7.08		
95	1.805	4.23	7.11		

### 16.1.4 NIST standard buffers (DIN and JIS 19266: 2000–01)

Temp (°C)	pH of buffer solutions			
0				
5	1.668	4.004	6.950	9.392
10	1.670	4.001	6.922	9.331
15	1.672	4.001	6.900	9.277
20	1.676	4.003	6.880	9.228
25	1.680	4.008	6.865	9.184
30	1.685	4.015	6.853	9.144
37	1.694	4.028	6.841	9.095
40	1.697	4.036	6.837	9.076
45	1.704	4.049	6.834	9.046
50	1.712	4.064	6.833	9.018
55	1.715	4.075	6.834	8.985
60	1.723	4.091	6.836	8.962
70	1.743	4.126	6.845	8.921
80	1.766	4.164	6.859	8.885
90	1.792	4.205	6.877	8.850
95	1.806	4.227	6.886	8.833



**NOTE:** The pH(S) values of the individual charges of the secondary reference materials are documented in a certificate of an accredited laboratory. This certificate is supplied with the respective buffer materials. Only these pH(S) values shall be used as standard values for the secondary reference buffer materials. Correspondingly, this standard does not include a table with standard pH values for practical use. The table above only provides examples of pH(PS) values for orientation.

### 16.1.5 Hach buffers

Buffer values up to 60 °C as specified by Bergmann & Beving Process AB.

Temp (°C)	pH of buffer solutions		
0	4.00	7.14	10.30
5	4.00	60	10.23
10	4.00	7.04	10.11
15	4.00	7.04	10.11
20	4.00	7.02	10.05
25	4.01	7.00	10.00
30	4.01	6.99	9.96
35	4.02	6.98	9.92
40	4.03	6.98	9.88
45	4.05	6.98	9.85
50	4.06	6.98	9.82
55	4.07	6.98	9.79
60	4.09	6.99	9.76

### 16.1.6 Ciba (94) buffers

Temp (°C)	pH of buffer solutions				
0	2.04	4.00	7.10	10.30	
5	2.09	4.02	7.08	10.21	
10	2.07	4.00	7.05	10.14	
15	2.08	4.00	7.02	10.06	
20	2.09	4.01	6.98	9.99	
25	2.08	4.02	6.98	9.95	
30	2.06	4.00	6.96	9.89	
35	2.06	4.01	6.95	9.85	
40	2.07	4.02	6.94	9.81	
45	2.06	4.03	6.93	9.77	
50	2.06	4.04	6.93	9.73	
55	2.05	4.05	6.91	9.68	
60	2.08	4.10	6.93	9.66	
65	2.07*	4.10*	6.92*	9.61*	
70	2.07	4.11	6.92	9.57	
75	2.04*	4.13*	6.92*	9.54*	
80	2.02	4.15	6.93	9.52	
85	2.03*	4.17*	6.95*	9.47*	
90	2.04	4.20	6.97	9.43	
95	2.05*	4.22*	6.99*	9.38*	

\* Extrapolated

### 16.1.7 Merck Titrisole, Riedel-de-Haën Fixanale

Temp (°C)	pH of buffer solutions				
0	2.01	4.05	7.13	9.24	12.58
5	2.01	4.05	7.07	9.16	12.41
10	2.01	4.02	7.05	9.11	12.26
15	2.00	4.01	7.02	9.05	12.10
20	2.00	4.00	7.00	9.00	12.00
25	2.00	4.01	6.98	8.95	11.88
30	2.00	4.01	6.98	8.91	11.72
35	2.00	4.01	6.96	8.88	11.67
40	2.00	4.01	6.95	8.85	11.54
45	2.00	4.01	6.95	8.82	11.44
50	2.00	4.00	6.95	8.79	11.33
55	2.00	4.00	6.95	8.76	11.19
60	2.00	4.00	6.96	8.73	11.04
65	2.00	4.00	6.96	8.72	10.97
70	2.01	4.00	6.96	8.70	10.90
75	2.01	4.00	6.96	8.68	10.80
80	2.01	4.00	6.97	8.66	10.70
85	2.01	4.00	6.98	8.65	10.59
90	2.01	4.00	7.00	8.64	10.48
95	2.01	4.00	7.02	8.64	10.37

## 16.1.8 WTW buffers

Temp (°C)	pH of buffer solutions			
0	2.03	4.01	7.12	10.65
5	2.02	4.01	7.09	10.52
10	2.01	4.00	7.06	10.39
15	2.00	4.00	7.04	10.26
20	2.00	4.00	7.02	10.13
25	2.00	4.01	7.00	10.00
30	1.99	4.01	6.99	9.87
35	1.99	4.02	6.98	9.74
40	1.98	4.03	6.97	9.61
45	1.98	4.04	6.97	9.48
50	1.98	4.06	6.97	9.35
55	1.98	4.08	6.98	
60	1.98	4.10	6.98	
65	1.99	4.13	6.99	
70		4.16	7.00	
75		4.19	7.02	
80		4.22	7.04	
85		4.26	7.06	
90		4.30	7.09	
95		4.35	7.12	

## 16.1.9 JIS Z 8802 buffers

Temp (°C)	pH of buffer solutions			
0	1.666	4.003	6.984	9.464
5	1.668	3.999	6.951	9.395
10	1.670	3.998	6.923	9.332
15	1.672	3.999	6.900	9.276
20	1.675	4.002	6.881	9.225
25	1.679	4.008	6.865	9.180
30	1.683	4.015	6.853	9.139
35	1.688	4.024	6.844	9.102
38	1.691	4.030	6.840	9.081
40	1.694	4.035	6.838	9.068
45	1.700	4.047	6.834	9.038
50	1.707	4.060	6.833	9.011
55	1.715	4.075	6.834	8.985
60	1.723	4.091	6.836	8.962
70	1.743	4.126	6.845	8.921
80	1.766	4.164	6.859	8.885
90	1.792	4.205	6.877	8.850
95	1.806	4.227	6.886	8.833

## 16.2 Dual membrane pH electrode buffers

### 16.2.1 Mettler-pH/pNa buffers (Na+ 3.9M)

Temp (°C)	pH of buffer solutions			
0	1.98	3.99	7.01	9.51
5	1.98	3.99	7.00	9.43
10	1.99	3.99	7.00	9.36
15	1.99	3.99	6.99	9.30
20	1.99	4.00	7.00	9.25
25	2.00	4.01	7.00	9.21
30	2.00	4.02	7.01	9.18
35	2.01	4.04	7.01	9.15
40	2.01	4.05	7.02	9.12
45	2.02	4.07	7.03	9.11
50	2.02	4.09	7.04	9.10

## Sales and Service:

### Australia

Mettler-Toledo Limited  
220 Turner Street  
Port Melbourne, VIC 3207  
Australia  
Phone +61 1300 659 761  
e-mail info.mtaus@mt.com

### Austria

Mettler-Toledo Ges.m.b.H.  
Laxenburger Str. 252/2  
AT-1230 Wien  
Phone +43 1 607 4356  
e-mail prozess@mtf.com

### Brazil

Mettler-Toledo Ind. e Com. Ltda.  
Avenida Tamboré, 418  
Tamboré  
BR-06460-000 Barueri/SP  
Phone +55 11 4166 7400  
e-mail mtbr@mt.com

### Canada

Mettler-Toledo Inc.  
2915 Argentia Rd #6  
CA-ON L5N 8G6 Mississauga  
Phone +1 800 638 8537  
e-mail ProlnsideSalesCA@mtf.com

### China

Mettler-Toledo International Trading  
(Shanghai) Co. Ltd.  
589 Gui Ping Road  
Cao He Jing  
CN-200233 Shanghai  
Phone +86 21 64 85 04 35  
e-mail ad@mtf.com

### Croatia

Mettler-Toledo d.o.o.  
Mandlova 3  
HR-10000 Zagreb  
Phone +385 1 292 06 33  
e-mail mt.zagreb@mtf.com

### Czech Republic

Mettler-Toledo s.r.o.  
Trebohosticka 2283/2  
CZ-100 00 Praha 10  
Phone +420 2 72 123 150  
e-mail sales.mtcz@mtf.com

### Denmark

Mettler-Toledo A/S  
Naverland 8  
DK-2600 Glostrup  
Phone +45 43 27 08 00  
e-mail info.mtdk@mtf.com

### France

Mettler-Toledo  
Analyse Industrielle S.A.S.  
30, Boulevard de Douaumont  
FR-75017 Paris  
Phone +33 1 47 37 06 00  
e-mail mtpro-f@mtf.com

### Germany

Mettler-Toledo GmbH  
Prozeßanalytik  
Ockerweg 3  
DE-35396 Gießen  
Phone +49 641 507 444  
e-mail prozess@mtf.com

### Great Britain

Mettler-Toledo LTD  
64 Boston Road, Beaumont Leys  
GB-Leicester LE4 1AW  
Phone +44 116 235 7070  
e-mail enquire.mtuk@mtf.com

### Hungary

Mettler-Toledo Kereskedelmi KFT  
Teve u. 41  
HU-1139 Budapest  
Phone +36 1 288 40 40  
e-mail mthu@axelero.hu

### India

Mettler-Toledo India Private Limited  
Amar Hill, Saki Vihar Road  
Powai  
IN-400 072 Mumbai  
Phone +91 22 2857 0808  
e-mail sales.mtin@mtf.com

### Indonesia

PT. Mettler-Toledo Indonesia  
GRHA PERSADA 3rd Floor  
Jl. KH. Noer Ali No.3A,  
Kayuringin Jaya  
Kalimalang, Bekasi 17144, ID  
Phone +62 21 294 53919  
e-mail  
mt-id.customersupport@mtf.com

### Italy

Mettler-Toledo S.p.A.  
Via Vialba 42  
IT-20026 Novate Milanese  
Phone +39 02 333 321  
e-mail  
customercare.italia@mtf.com

### Japan

Mettler-Toledo K.K.  
Process Division  
6F Ikenohata Nisshoku Bldg.  
2-9-7, Ikenohata  
Tai-to-ku  
JP-110-0008 Tokyo  
Phone +81 3 5815 5606  
e-mail helpdesk.ing.jp@mtf.com

### Malaysia

Mettler-Toledo (M) Sdn Bhd  
Bangunan Electrocon Holding, U 1-01  
Lot 8 Jalan Astaka U8/84  
Seksyen U8, Bukit Jelutong  
MY-40150 Shah Alam Selangor  
Phone +60 3 78 44 58 88  
e-mail  
MT-MY.CustomerSupport@mtf.com

### Mexico

Mettler-Toledo S.A. de C.V.  
Ejército Nacional #340  
Polanco V Sección  
C.P. 11560  
MX-México D.F.  
Phone +52 55 1946 0900  
e-mail mt.mexico@mtf.com

### Norway

Mettler-Toledo AS  
Ulvenveien 92B  
NO-0581 Oslo Norway  
Phone +47 22 30 44 90  
e-mail info.mtn@mtf.com

### Poland

Mettler-Toledo (Poland) Sp.z.o.o.  
ul. Poleczki 21  
PL-02-822 Warszawa  
Phone +48 22 545 06 80  
e-mail polska@mtf.com

### Russia

Mettler-Toledo Vostok ZAO  
Sretenskij Bulvar 6/1  
Office 6  
RU-101000 Moscow  
Phone +7 495 621 56 66  
e-mail inforus@mtf.com

### Singapore

Mettler-Toledo (S) Pte. Ltd.  
Block 28  
Ayer Rajah Crescent #05-01  
SG-139959 Singapore  
Phone +65 6890 00 11  
e-mail  
mt.sg.customersupport@mtf.com

### Slovakia

Mettler-Toledo s.r.o.  
Hattalova 12/A  
SK-831 03 Bratislava  
Phone +421 2 4444 12 20-2  
e-mail predaj@mtf.com

### Slovenia

Mettler-Toledo d.o.o.  
Pot heroja Trtnika 26  
SI-1261 Ljubljana-Dobrunje  
Phone +386 1 530 80 50  
e-mail keith.racman@mtf.com

### South Korea

Mettler-Toledo (Korea) Ltd.  
1 & 4 F, Yeil Building 21  
Yangjaecheon-ro 19-gil  
Seocho-Gu  
Seoul 06753 Korea  
Phone +82 2 3498 3500  
e-mail Sales\_MTKR@mtf.com

### Spain

Mettler-Toledo S.A.E.  
C/Miguel Hernández, 69-71  
ES-08908 L'Hospitalet de Llobregat  
(Barcelona)  
Phone +34 902 32 00 23  
e-mail mtemkt@mtf.com

### Sweden

Mettler-Toledo AB  
Virkesvägen 10  
Box 92161  
SE-12008 Stockholm  
Phone +46 8 702 50 00  
e-mail sales.mts@mtf.com

### Switzerland

Mettler-Toledo (Schweiz) GmbH  
Im Langacher, Postfach  
CH-8606 Greifensee  
Phone +41 44 944 47 60  
e-mail ProSupport.ch@mtf.com

### Thailand

Mettler-Toledo (Thailand) Ltd.  
272 Soi Soonvijai 4  
Rama 9 Rd., Bangkapi  
Huay Kwang  
TH-10320 Bangkok  
Phone +66 2 723 03 00  
e-mail  
MT-TH.CustomerSupport@mtf.com

### Turkey

Mettler-Toledo Türkiye  
Haluk Türksöy Sokak No: 6 Zemin ve 1.  
Bodrum Kat 34662 Üsküdar-Istanbul, TR  
Phone +90 216 400 20 20  
e-mail sales.mttr@mtf.com

### USA

METTLER TOLEDO  
Process Analytics  
900 Middlesex Turnpike, Bld. 8  
Billerica, MA 01821, USA  
Phone +1 781 301 8800  
FreePhone +1 800 352 8763  
e-mail mtprous@mtf.com

### Vietnam

Mettler-Toledo (Vietnam) LLC  
29A Hoang Hoa Tham Street, Ward 6  
Binh Thanh District  
Ho Chi Minh City, Vietnam  
Phone +84 8 35515924  
e-mail  
MT-VN.CustomerSupport@mtf.com



Management System  
certified according to  
ISO 9001 / ISO 14001



Subject to technical changes.  
© Mettler-Toledo GmbH, Process Analytics  
02/2017 Printed in Switzerland. 30 216 266



Mettler-Toledo GmbH, Process Analytics  
Im Hackacker 15, CH-8902 Urdorf, Switzerland  
Tel. +41 44 729 62 11, Fax +41 44 729 66 36