

IND360

Fill/Dose Application Software



© METTLER TOLEDO 2023

No part of this manual may be reproduced or transmitted in any form or by any means, electronic or mechanical, including photocopying and recording, for any purpose without the express written permission of METTLER TOLEDO.

U.S. Government Restricted Rights: This documentation is furnished with Restricted Rights.

Copyright 2023 METTLER TOLEDO. This documentation contains proprietary information of METTLER TOLEDO. It may not be copied in whole or in part without the express written consent of METTLER TOLEDO.

COPYRIGHT

METTLER TOLEDO® is a registered trademark of Mettler-Toledo, LLC. All other brand or product names are trademarks or registered trademarks of their respective companies.

METTLER TOLEDO RESERVES THE RIGHT TO MAKE REFINEMENTS OR CHANGES WITHOUT NOTICE.

FCC Notice















This device complies with Part 15 of the FCC Rules and the Radio Interference Requirements of the Canadian Department of Communications. Operation is subject to the following conditions: (1) this device may not cause harmful interference, and (2) this device must accept any interference received, including interference that may cause undesired operation.

This equipment has been tested and found to comply with the limits for a Class A digital device, pursuant to Part 15 of FCC Rules. These limits are designed to provide reasonable protection against harmful interference when the equipment is operated in a commercial environment. This equipment generates, uses, and can radiate radio frequency energy and, if not installed and used in accordance with the instruction manual, may cause harmful interference to radio communications. Operation of this equipment in a residential area is likely to cause harmful interference in which case the user will be required to correct the interference at his or her expense.

- Declaration of Conformity is available at <http://glo.mt.com/global/en/home/search/compliance.html/compliance/>.

Warnings and Cautions

- READ this manual BEFORE operating or servicing this equipment and FOLLOW these instructions carefully.
- SAVE this manual for future reference.

	<p style="text-align: center;"> WARNING</p> <p>FOR CONTINUED PROTECTION AGAINST SHOCK HAZARD CONNECT THE TERMINAL TO PROPERLY GROUNDED OUTLET ONLY. DO NOT REMOVE THE GROUND PRONG</p>
	<p style="text-align: center;"> WARNING</p> <p>WHEN THIS EQUIPMENT IS INCLUDED AS A COMPONENT PART OF A SYSTEM, THE RESULTING DESIGN MUST BE REVIEWED BY QUALIFIED PERSONNEL WHO ARE FAMILAR WITH THE CONSTRUCTION AND OPERATION OF ALL COMPONENTS IN THE SYSTEM AND THE POTENTIAL HAZARDS INVOLVED. FAILURE TO OBSERVE THIS PRECAUTION COULD RESULT IN BODILY HARM AND/OR PROPERTY DAMAGE.</p>
	<p style="text-align: center;"> CAUTION</p> <p>THIS EQUIPMENT IS NOT INTRINSICALLY SAFE! IT MAY NOT BE USED IN AREAS THAT ARE CLASSIFIED AS POTENTIALLY EXPLOSIVE DUE TO COMBUSTIBLE OR EXPLOSIVE ENVIRONMENTS.</p>
	<p style="text-align: center;"> CAUTION</p> <p>ONLY THE COMPONENTS SPECIFIED ON THE IND360 DOCUMENTATION CAN BE USED IN THIS INDICATOR. ALL EQUIPMENT MUST BE INSTALLED IN ACCORDANCE WITH THE INSTALLATION INSTRUCTIONS DETAILED IN THE INSTALLATION MANUAL. INCORRECT OR SUBSTITUTE COMPONENTS AND/OR DEVIATION FROM THESE INSTRUCTIONS CAN IMPAIR THE SAFETY OF THE INDICATOR AND COULD RESULT IN BODILY HARM AND/OR PROPERTY DAMAGE.</p>
	<p style="text-align: center;"> CAUTION</p> <p>ONLY PERMIT QUALIFIED PERSONNEL TO SERVICE THE INDICATOR. EXERCISE CARE WHEN MAKING CHECKS, TESTS AND ADJUSTMENTS THAT MUST BE MADE WITH POWER ON. FAILING TO OBSERVE THESE PRECAUTIONS CAN RESULT IN BODILY HARM AND/OR PROPERTY DAMAGE.</p>
	<p style="text-align: center;"> CAUTION</p> <p>BEFORE CONNECTING/DISCONNECTING ANY INTERNAL ELECTRONIC COMPONENTS OR INTERCONNECTING WIRING BETWEEN ELECTRONIC EQUIPMENT ALWAYS REMOVE POWER AND WAIT AT LEAST THIRTY (30) SECONDS BEFORE ANY CONNECTIONS OR DISCONNECTIONS ARE MADE. FAILING TO OBSERVE THESE PRECAUTIONS CAN RESULT IN BODILY HARM AND/OR PROPERTY DAMAGE.</p>
	<p style="text-align: center;"> CAUTION</p> <p>THE INDICATOR FOR HARSH ENVIRONMENTS MUST BE INSTALLED NEAR AN ELECTRICAL OUTLET (WITHIN THE LENGTH OF THE INTEGRAL LINE CORD) AND THE OUTLET MUST BE EASILY ACCESIBLE.</p>
	<p style="text-align: center;">NOTICE</p> <p>OBSERVE PRECAUTIONS FOR HANDLING ELECTROSTATIC SENSITIVE DEVICES.</p>

Disposal of Electrical and Electronic Equipment

In conformance with the European Directive 2012/19/EC on Waste Electrical and Electronic Equipment (WEEE) this device may not be disposed of in domestic waste. This also applies to countries outside the EU, per their specific requirements.



Please dispose of this product in accordance with local regulations at the collecting point specified for electrical and electronic equipment.

If you have any questions, please contact the responsible authority or the distributor from which you purchased this device.

Should this device be passed on to other parties (for private or professional use), the content of this regulation must also be related.

Thank you for your contribution to environmental protection.

Contents

1	Introduction.....	1-1
1.1.	Enabling Fill/dose Application	1-1
1.2.	Features.....	1-2
1.3.	Display and Keypad	1-2
1.4.	Further Information	1-8
2	Installation.....	2-1
2.1.	Wiring	2-2
3	Filling System Design.....	3-1
3.1.	Basic Concepts	3-1
3.2.	Operating Modes	3-5
3.3.	Filling vs. Dosing	3-10
3.4.	Automatic Optimization	3-10
3.5.	Managing Products and Filling Targets	3-12
3.6.	Legal for Trade	3-13
4	Operation.....	4-1
4.1.	Examples of IND360fill/dose Operation	4-1
4.2.	Application State Machine	4-3
4.3.	Five Modes of Operation.....	4-5
4.4.	Jog Function	4-21
4.5.	Starting and Stopping the Fill/dose Application	4-24
4.6.	User Management	4-25
4.7.	Data Record.....	4-25
4.8.	ePrint Function	4-26
4.9.	Statistics.....	4-26
4.10.	Smart5 Alarms.....	4-27
4.11.	Error Codes	4-28
4.12.	Parameter ID List.....	4-31
5	Configuration	5-1
5.1.	Configuration Interface Access	5-1
5.2.	Application Configuration	5-5
5.3.	Filter Settings.....	5-14
6	Communication Protocol	6-1
6.1.	PLC Sample Code.....	6-1
6.2.	Parameter Verification	6-1

6.3.	Getting Started.....	6-1
6.4.	Modbus RTU/TCP Protocol.....	6-2
6.5.	SAI Protocol	6-4
6.6.	Acyclic Commands.....	6-9
7	Frequently Asked Questions.....	7-1
7.1.	Can the fill/dose operation be controlled using the web interface?	7-1
7.2.	Can application settings be modified during a filling operation?	7-1
7.3.	What factors strongly influence filling performance?	7-1
7.4.	Can the spill value be negative?.....	7-2
7.5.	Is there a difference in the results when using a POWERCELL scale, or a Precision Scale, instead of Analog (Strain Gauge)?	7-3
7.6.	Why do I get an alarm every time I enable Auto Tare?	7-3
7.7.	Wouldn't it be a better idea to control everything from the PLC / DCS?	7-3

1 Introduction

IND360fill/dose comes with a ready-to-use filling and dosing application. The application directly controls the entire filling cycle through digital inputs/outputs or using the PLC interface. This means, given a filling target, IND360fill/dose handles the filling cycle by itself. The application accounts for in-flight material, executes automatic tare operations, makes tolerance checks, and provides many more functions. Between filling cycles, the fill/dose application can optimize the cut-off point settings autonomously, accounting for changing environmental and material conditions.





The fill/dose application supports two main operating modes, described in the table below. The application can control additional operations such as dump or refill. There is an additional mode called absolute (legacy) that uses the absolute value of the change in weight to determine when the process has completed.

Table 1-1: IND360 Fill-Dose Cycle Descriptions

Cycle	Descriptions
Fill	Also referred to as: weigh-in, gain-in-weight (GIW) A fill cycle is defined as dispensing one material into a container or bag placed on the scale – the target weight is captured.
Dose	Also referred to as: weigh-out, loss-in-weight (LIW) A dose cycle is defined as dispensing one material into a container or bag, whereas the source material is on the scale –the weight lost by the source is captured.

1.1. Enabling Fill/dose Application

Before configuration and operation, please ensure that the fill-dose application is enabled. Follow the instructions below to enable the application on the IND360 indicator:

1. Long press the ePrint/Setup key . If the indicator is password protected, a login screen will display. Enter a valid username and password. If no password is set, simply login by pressing the Enter key .
2. The indicator will display the Setup screen with Scale selected and highlighted in blue.
3. Navigate to **Application > PAC > PAC Management**.
4. Select **Fill dose** from the selection list and confirm selection by pressing the Enter key .
5. To exit the menu structure, press the Zero key  several times until the screen displays "Save all Settings before existing?"
6. Select **YES** and press the Enter key  to accept all changes. The device will restart automatically.

The application is started either through a digital input, the local display (Panel and Harsh versions) or remotely by a PLC/DCS.

1.2. Features

- Five operating modes: fill, fill/dump, dose, refill/dose, absolute (legacy)
- Precise cut-off point control with up to 480Hz processing speed (analog scales)
- One-speed and two-speed filling/dosing
- Automatic spill and cut-off point optimization for optimal filling results
- Automatic tare with thresholds
- State machine inspired by ISA-88 and PackML industry standard for easy integration and machine control
- Easy configuration through web interface and 4.3" color display
- PLC / DCS interface for parametrization and process monitoring
- Target table to easily store and load settings for up to 10 products
- Flow Rate value calculated and reported to automation system
- PROFINET, Profibus DP, EtherNet/IP, EtherCAT, Modbus RTU/TCP, CC-Link IE Field Basic, and 4-20mA analog output
- Cyclical and Acyclical PLC / DCS communication
- Supports Analog, POWERCELL® and Precision scales

1.3. Display and Keypad

1.3.1. IND360 DIN Rail-Mount Version

The IND360 DIN rail-mount version includes a keypad (including four push buttons) and a 1.04 inch OLED display. The keypad is used for Zero, Tare, Clear and ePrint operations and cannot be used to edit application parameters. The display shows the weight value only. Application parameters are edited through the web interface.

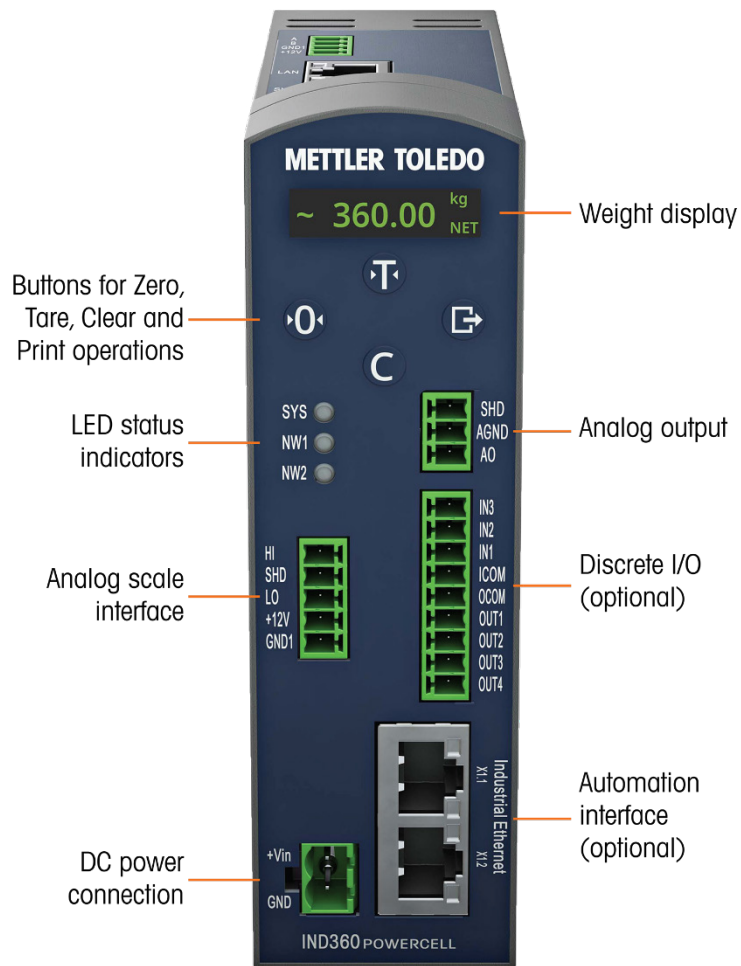

Figure 1-1: IND360 DIN Rail-Mount Version HMI for Fill/dose Application

Table 1-2: Keypad – IND360 DIN Rail-Mount Version

Key	Name	Function
	Tare	Tare
	Zero	Zero
	Clear	Clear
	ePrint/Setup	ePrint (short press) Enter setup (long press)

1.3.2. IND360 Panel and Harsh Version

The IND360 Panel and Harsh version offer a 4.3" TFT color display for visualization and configuration of device and application data.

1.3.2.1. Filling

Figure 1-2 shows the Human Machine Interface (HMI) of a Panel version in fill mode.



Figure 1-2: IND360 Panel-Mount Version HMI for Fill/dose Application

1	IP address	IP address of the IND360 indicator service interface (web interface)
2	Feed speeds	Blue arrows indicate which feeds are currently running; size of outlet corresponds to feed speed.
3	Application status	Fill/dose application status information (e.g. running, dumping). (Refer to Table 1-5: Application Status Icons.)
4	Softkeys	Quick access to device information, application statistics, Start/Stop control, configuration and SMART5™ alarms. (Refer to Table 1-4: Softkeys.)
5	Target weight	Target weight for filling.
6	Keypad	Scale function keys; refer to Figure 1-3.
7	Current weight	Current weight on scale holding target container
8	Metrological information	Information about weighing range, resolution.
9	Date & time	Displays the current date and time.

1.3.2.2.

Dosing

The following figure shows the Human Machine Interface (HMI) of a Panel version in dose mode



Figure 1-3: IND360 Panel-Mount Version HMI for Fill/dose Application

1	IP address	IP address of the IND360 indicator service interface (web interface).
2	Feed speeds	Blue arrows indicate which feeds are currently running; size of outlet corresponds to feed speed.
3	Weighing status	Application status information (e.g. running, dumping). (Refer to Table 1-5: Application Status Icons.)
4	Softkeys	Quick access to device information, application statistics, Start/Stop control, configuration and SMART5™ alarms. (Refer to Table 1-4: Softkeys.)
5	Source container weight	Current weight of the material inside the source container from which material is being dispensed.
6	Keypad	Scale function keys; refer to Figure 1-3.
7	Target weight	Target weight for dosing process.
8	Net delivered	Amount of material dispensed into target container.
9	Metrological information	Information about weighing range, resolution.
10	Date & time	Displays the current date and time.

1.3.2.3.

Softkeys and Symbols

This subsection contains a detailed description on the softkeys and the symbols used throughout the fill/dose application.

Table 1-3: Keypad – IND360 Panel-Mount Version for Fill/dose Application















Key	Name	Normal Operation	Setup Menu	Numerical Values	List Selection
	Tare	Tare	Up	Increase value	Previous item up
	Zero	Zero	Back / Exit	Select left digit	Exit parameter selection
	Clear	Clear	Down	Decrease value	Next item down
	ePrint/Setup	ePrint (short press) Enter setup (long press)	(No function)	Select right digit	(No function)
	Enter	Confirm selection	Enter to parameter selection / setup	Accept	Accept

Table 1-4: Softkeys

Softkey	Name	Function
	Information Recall	Shows information of the indicator: model, serial number, software version, approval, PLC type, node address, DIO type, etc.
	Preset Configuration	Quickly view and change most pertinent filling/dosing parameters currently in use. Can also be used to switch products from the preset target table.
	Start	Start a filling or dosing cycle if a cycle is not currently running
	Start/Stop	Stop the currently running filling or dosing cycle
	Expand Readability	Increase weight readability on display for 5 seconds. This functionality is typically used during verification in legal-for-trade setup.
	Normal Condition	Device/application is operating normally.
	Predictive Alarm	Routine test, calibration or preventative maintenance recommended.
	Out of Specification	Wrong operator action or device/application is operating out of specification.
	Imminent Failure	Wrong weight or equipment failure expected. The alarm can be reset but will reoccur every day. Please contact METTLER TOLEDO service.













Softkey	Name	Function
	Failure	Equipment failure or incorrect weight. Clearing the alarm will not reset the condition. The device must be repaired to eliminate the alarm. Please contact METTLER TOLEDO service.

Table 1-5: Application Status Icons

Icon	Name	Function
	Run	Filling or dosing operation in progress.
	Stop	The filling application is not in operation.
	Pause	Filling or dosing operation is paused in the middle of the operation
	Stopped	Application is in the stopped state. Application can either be moved to the idle state (to adjust settings) or to the run state (to begin a new cycle)
	Complete	Application is in the complete state. Application can either be moved to the idle state (to adjust settings) or to the run state (to begin a new cycle)
	Speed	Indicates the current filling speed (is application in fast feed or feed)
	Overfill	Filling cycle completed above tolerance level (target container overfilled)
	Underfill	Filling cycle completed below tolerance level (target container underfilled)
	Upper Limit	(Refill/dose mode only) The material has met its high threshold weight and refilling is stopped.
	Lower Limit	(Refill/dose mode only) The material has met its low threshold weight and refilling is started.
	Loss in Weight	The weight value is expected to decrease during this portion of the process. This is seen during a dose cycle or the dump portion of a fill/dump.
	Gain in Weight	The weight value is expected to increase during this portion of the process. This is seen during a fill cycle or the refill portion of a refill/dose.

1.4. Further Information

For more information, please refer to the following documentation available online on www.mt.com/ind-ind360-downloads:

- Fill/dose application information
 - IND360fill-dose data sheet
- Device information and drawings
 - IND360base data sheet
 - **IND360base Indicator and Transmitter User's Guide**
- PLC sample code for applications (refer to section 6.1, **PLC Sample Code**)

2 Installation

To install and ground the indicator, refer to Appendix A, **Installation**, in the **IND360base Indicator and Transmitter User's Guide**.



Grounding performance of the equipment must be maintained in a good condition. Equipment grounding must be completed by a professional electrician. The METTLER TOLEDO Service Center offers supervision and consultation only.

- Complete the grounding of all equipment (power supply unit, weighing display, and scale, etc.), in reference to wiring diagrams of equipment and based on relevant national or local regulation requirements. In this process, it is essential to make sure that:

All equipment enclosures are connected at the same earth potential through grounding indicators.

No current flows circulating through the cable shield of any conductors such as the load cell or scale.

The neutral grounding point shall be as close to the weighing system as possible.

2.1. Wiring

Refer to the wiring charts shown below to connect the indicator with a fill/dose system. The example illustrates a filling system, the dosing system is analogous.

2.1.1. Wiring a Fill-Dump Application System

Figure 2-1 shows a typical system layout with an IND360 DIN/Panel mount version and a fill/dose system.

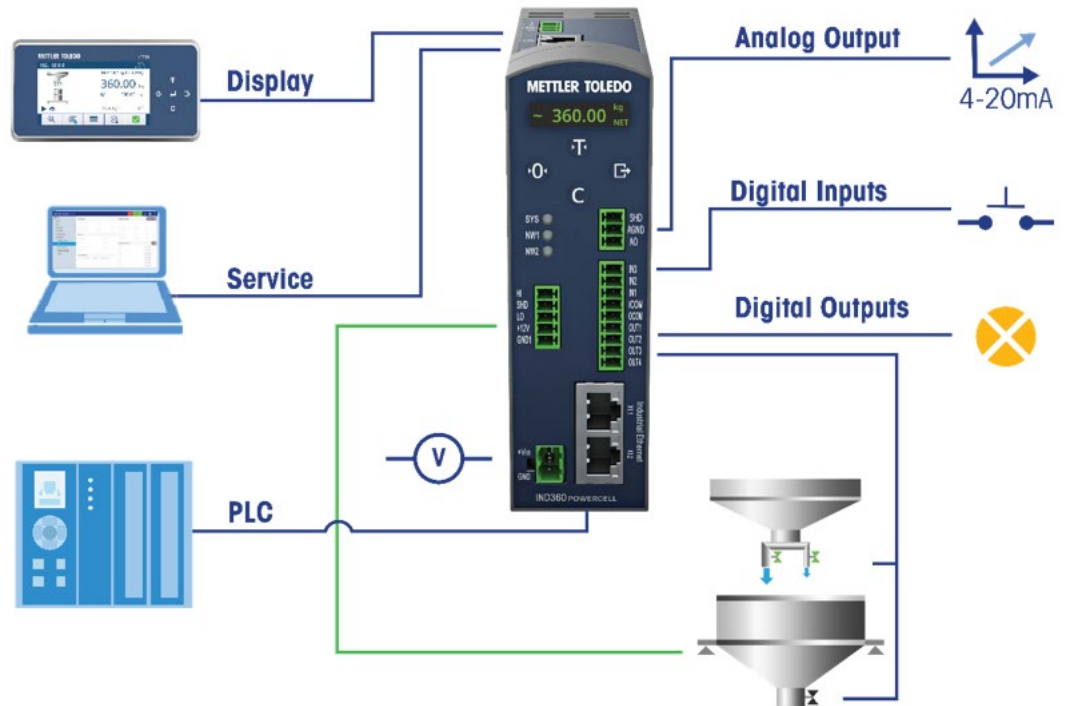

Figure 2-1: Wiring Chart for a Fill Application System

- Figure 2-1 shows a setup for filling and an associated dump. For a dosing setup, the digital outputs are wired to the feeds and the refill signal.

2.1.2. Digital I/O Connection

The digital I/O block must be attached to a common ground or voltage source+ to be operated. A typical setup is shown in Figure 2-2, other combinations of sinking or sourcing input/output are possible as well. Please refer to Appendix A, **Installation**, in the **IND360base Indicator and Transmitter User's Guide** for additional information about the digital I/O.

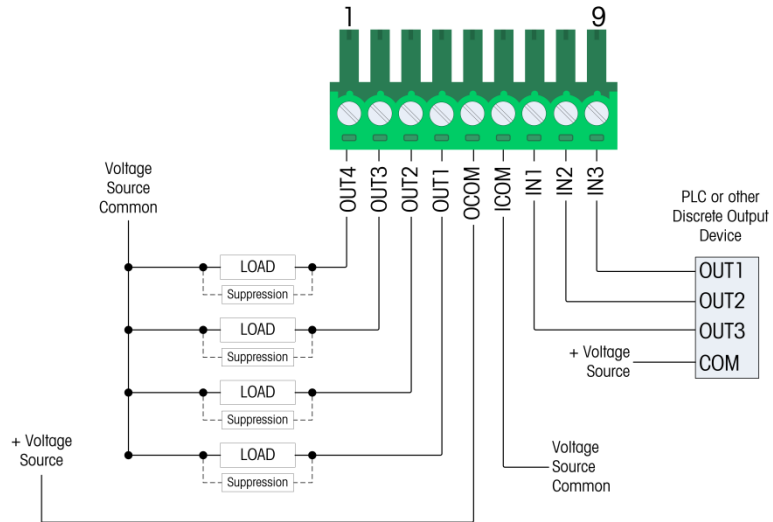

Figure 2-2: Sinking input and Sourcing Output

3 Filling System Design

This section provides a high-level overview describing filling and the device operating modes. For a more detailed description about the “state machine”, flow charts and device parameters please refer to the subsequent chapters.

3.1. Basic Concepts

3.1.1. Spill

The spill value denotes the amount of material that is still in flight, between the end of the feeder and the sensor after all feed actuators are turned off. This includes:

- Signal transfer time from IND360 to actuator. This is relevant when the signal is passed through a PLC with long program cycle time because it will delay the signal due to the extra processing time within the PLC.
- Time the actuator takes to turn off the feeding device.
- The response time of the feeding device.
- The quantity of in-flight material once the feeder stops feeding.

Steady flow, uniformly sized product (material to be fed) and repeatable spill are key for achieving high filling accuracy. Less signal delay, smaller spill and more uniform product permit more precise filling operation control by the IND360fill/dose, producing better filling results. Variations in timing caused by signal transfer, actuator reaction time, and inconsistent material flow will have a severe negative impact on filling accuracy and repeatability.

Spill may also change over time due to changing material and environmental conditions. The IND360fill/dose includes built-in mechanisms to adjust for these factors – refer to section 3.4, **Automatic Optimization**.

3.1.2. Feed Levels

IND360 supports up to two filling speeds (Figure 3-1). The amount of material to feed in each step is configured by two variables: spill and feed.

For two-speed filling, it is necessary to configure feed and spill. For one-speed filling, it is necessary to configure spill.

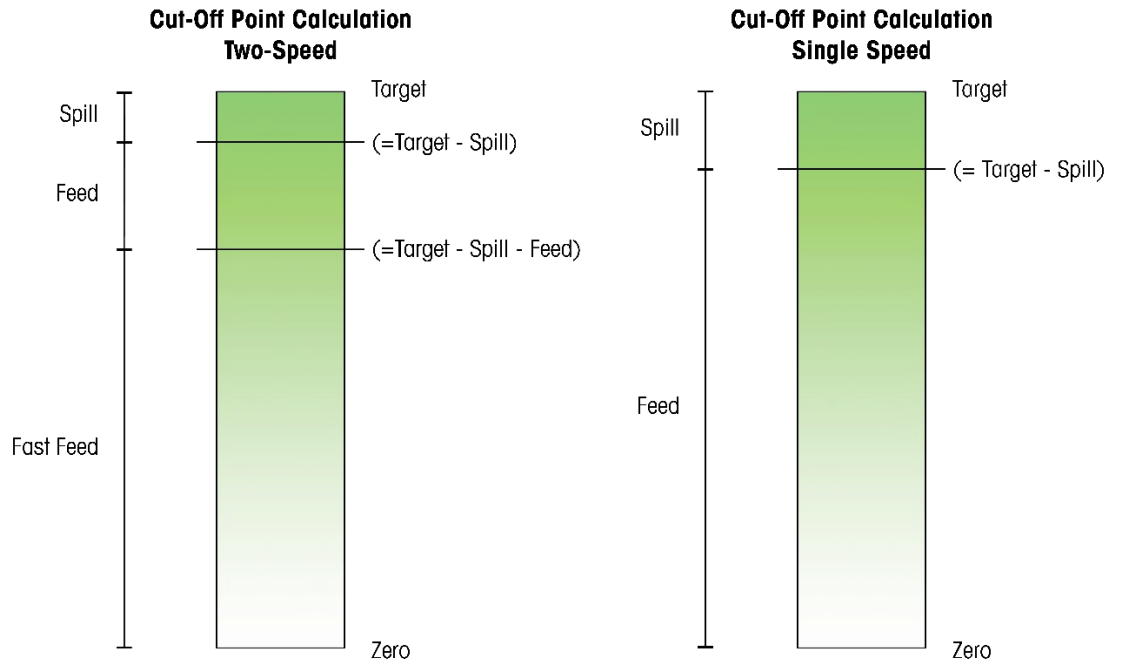

Figure 3-1: Filling Process Variables, Cut-Off Points and Steps

Cut-off points are calculated relative to the filling target – refer to the example, immediately below. The advantage of this approach is that the target weight can be modified without requiring an adjustment to the material feeds.

3.1.2.1. Example

Typical two-speed filling setup:

- Filling target: 10 kg
- Spill: 0.5 kg
- Feed: 2 kg

Step	Step Start	Step End (cut-off)	Amount dispensed
Fast Feed	0 kg	7.5 kg (Target - Spill - Feed, or 10 kg - 0.5 kg - 2 kg)	7.5 kg
Feed	7.5 kg	9.5 kg (Target - Spill, or 10 kg - 0.5 kg)	2.0 kg
Spill	9.5 kg	10.0 kg (Target)	0.5 kg

For each filling step, the IND360 drives the corresponding actuator signals, which are feed and fast feed. The signals can either be active concurrently (actuators driven simultaneously, as in Figure 3-2); or sequentially (actuators driven one-by-one, as in Figure 3-3).

Figure 3-2 shows a filling operation with both feeds active at the on start and turned off one by one as the process approaches the target weight.

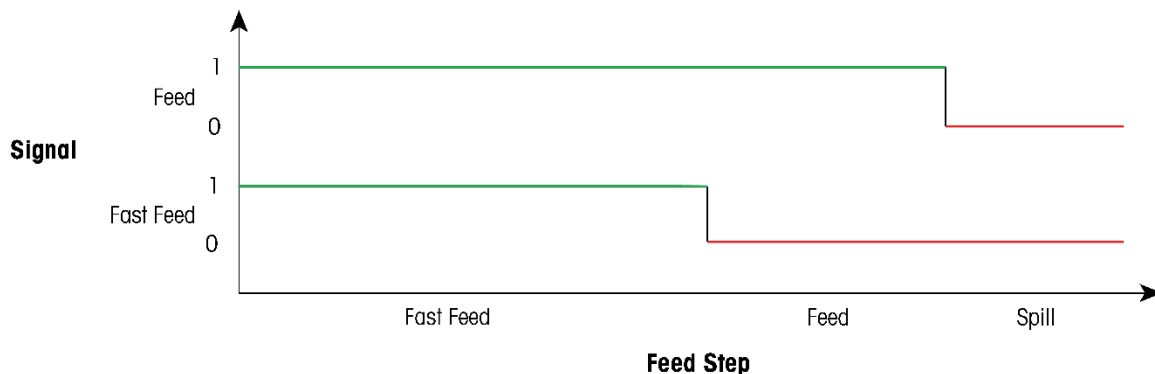

Figure 3-2: Filling with Concurrent Material Output

Figure 3-3 shows a filling operation with independent material outputs, so that only one feed is active at any point in the process.

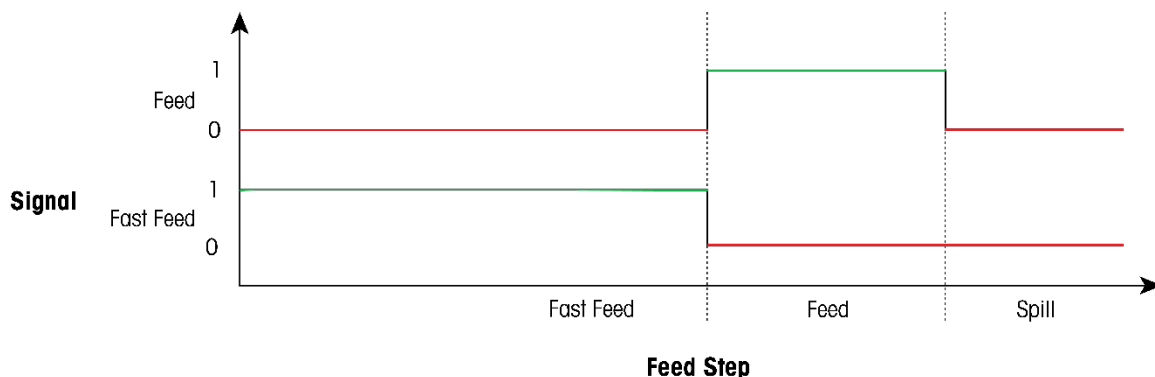

Figure 3-3: Filling with Sequential Material Output

- Single-Speed Filling: due to the IND360 indicator's very high speed, cut-off points are reached with high accuracy. This makes it possible to use one-speed filling instead of two-speed filling, eliminating one filling component thus saving cost and improving throughput.

3.1.3. Jog Function

When the programmed spill value is too large, or the properties of the material have substantially changed, the feed output will turn off too soon and the resulting weight will be below the target's tolerance. In this case, the jog function is used to feed additional material by pulsing the feeder, pump, or gate to reach the target value. Note: a large spill value occurs infrequently thus requiring few activations of this Jog function.

- With spill optimization enabled (section 3.4.1), when a jog cycle occurs, the IND360 will adjust the spill to correct its value for future filling or dosing cycles.

3.1.4. Inhibit time

Turning a feed on or off may cause spikes in the weight signal due to head pressure and the material hitting the surface of the receiving container. The inhibit function prevents this short peak in weight signal from prematurely triggering the termination of a fill cycle.

Inhibit time is defined as the period during which the comparison of the weight to the cut-off points is disabled. As Figure 3-4 illustrates, the inhibit timer starts when a cut-off point is reached and lasts for a fixed duration. During this time, the comparators are disabled. The example shown here uses the sequential mode (see Figure 3-3).

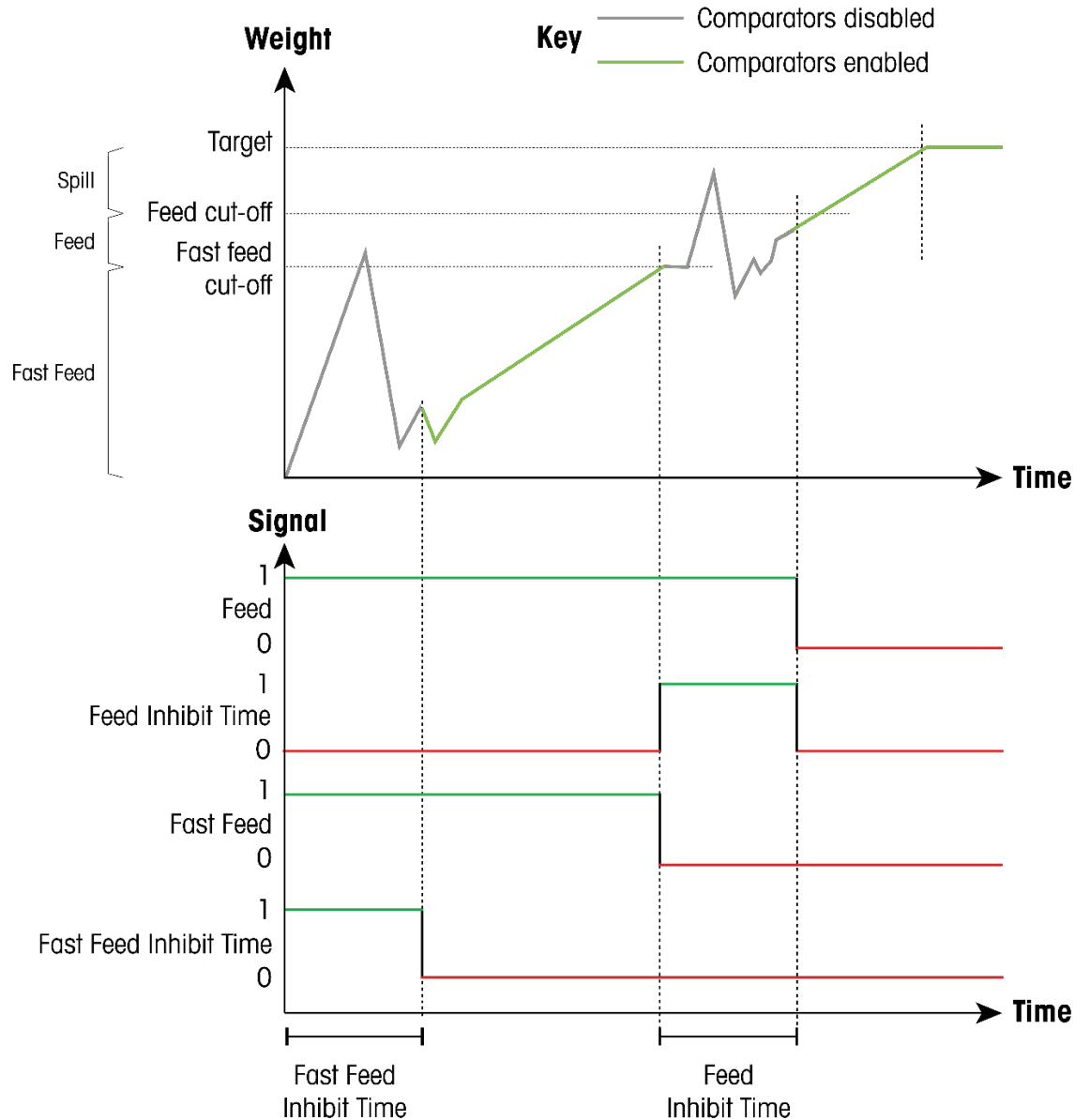

Figure 3-4: Visualization of Inhibit Time

- In combination with cut-off optimization: The inhibit time is active when switching from fast feed, to feed, and indirectly enforces a minimum amount of feed time. In other words, the feed time cannot be shorter than the inhibit time.

3.2. Operating Modes

IND360 offers five different operating modes. The related configuration parameters are available based on the selection.

This section introduces the five operation modes, their related settings, and additional considerations to keep in mind. For details on the execution flow, I/O signals and configuration parameters please refer to section 4.2, **Five Modes of Operation**.

3.2.1. Filling

In filling mode (also referred to as weighing-in or gain in weight), the target container is placed on the scale (Figure 3-5).

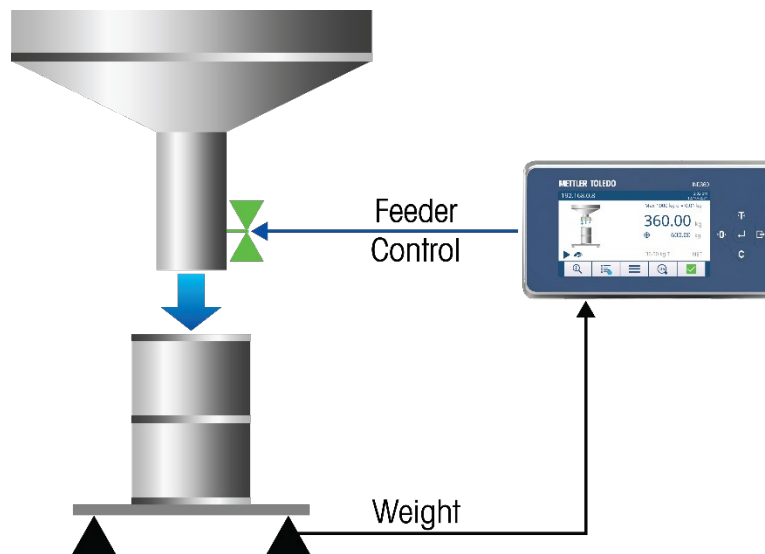

Figure 3-5: Filling System Setup

3.2.1.1. Tare Operation

Tare eliminates weight of the container to be filled to facilitate “Net” weight filling. In other words, the container is added to the scale and then “tared” off causing the weight display to indicate zero net weight so that the filling algorithm will not include the weight of the container. A display indicator and a status bit in the PLC communication will indicate that the unit is operating based on a net value.

- **Note:** Zero is never used to remove container weight because the zero value cannot be cleared at the end of a filling cycle, whereas the tare value is easily cleared.

When filling there are four different tare options that cover a broad set of use-cases. These options are described in the following sections.

3.2.1.1.1. Auto tare

When auto tare is enabled, the IND360 executes an automatic tare operation before starting the filling process. The procedure is as follows:

1. An empty container is placed on scale.
2. IND360 executes tare operation, setting the weight value (net-weight) to zero.
3. IND360 executes the filling process, dispensing the actual configured amount of material into the container.

With this method, the configured amount of material (target) is added to the container, independent of the weight of the empty container. To prevent spillage of material due to improperly executed workflows, it is recommended to limit the container tare min and max through the corresponding settings. This practice will avoid situations where: no container placed (detected as a lower tolerance violation), or full container not yet removed (detected as an upper tolerance violation).

- **Note:** Scale must be in gross mode before auto tare is taken. If already in net mode, "auto tare failed" alarm will be generated. Since it is unknown if the operator intended for an auto tare or a manual tare, a safety issue could occur if the auto tare were to proceed.

3.2.1.1.2. Manual Tare

When auto tare is disabled, the tare operation can also be triggered through a third-party control system via an automation network, or digital input signal, or by an operator using the keypad. The manual tare method gives full control and responsibility to the third party. In conjunction with a PLC, this is a powerful way to customize and optimize the filling process.

3.2.1.1.3. Pre-set tare

The automation network features a command that sets a specific numeric value as tare value. Two typical use-cases are:

- The weight of the empty container is known. This known value increases machine throughput by reducing the time taken to tare the system.
- More material is added to a pre-filled container where the weight is known. In this case, IND360
 - Sets the weight of an empty container as a pre-set tare
 - Adds as much material as needed to achieve the configured target

3.2.1.1.4. No tare

Filling without a tare is referred to as gross weight filling. When the filling process starts, the IND360 takes whatever weight is already on the scale and adds material until the target weight is reached (which is a combination of the empty container weight plus the material inside the container).

3.2.2. Fill-Dump

First, an intermediate buffer container is filled. Once the buffer container holds the desired amount of material (target weight), the IND360fill/dose issues a dump signal to dispense all the material from the buffer container into the target container (Figure 3-6).

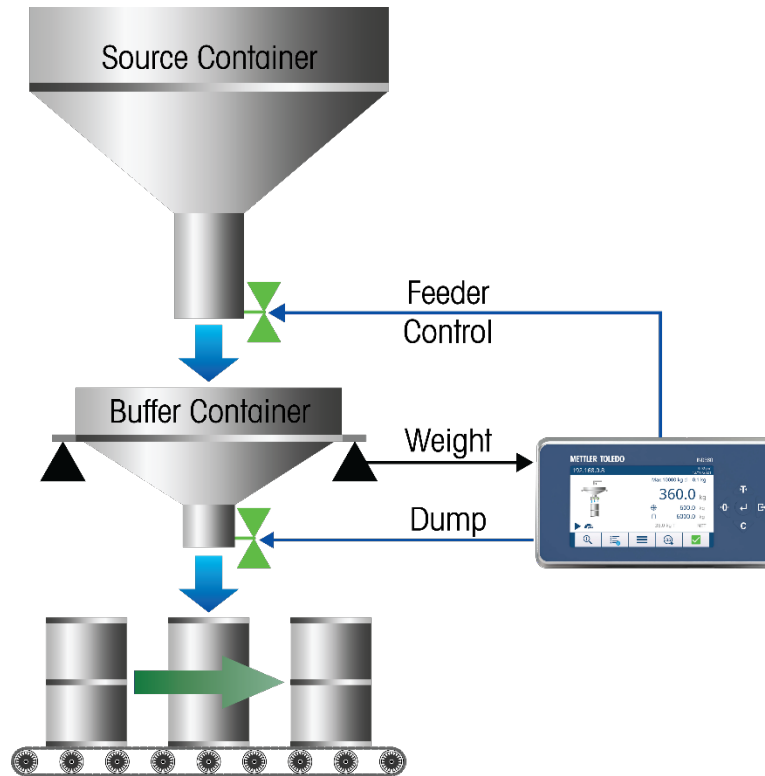

Figure 3-6: Fill-Dump Process Controlled by IND360fill/dose

There are two typical use-cases for this setup:

- To increase throughput, the buffer container is filled while the next target container is moved into position.
- In a more complex scenario: additional material processing steps (for example, mixing) are interposed before the material is dumped (Figure 3-7).

The steps in the scenario with additional intermediate processing are:

1. IND360 fills buffer container.
2. PLC reads dump signal (filling of buffer container completed) through the automation network.
3. PLC manages intermediate steps and triggers the dump when ready.
4. IND360 measures remaining weight, and as soon as the weight signal drops below the configured heel weight, it signals that the buffer container is empty.

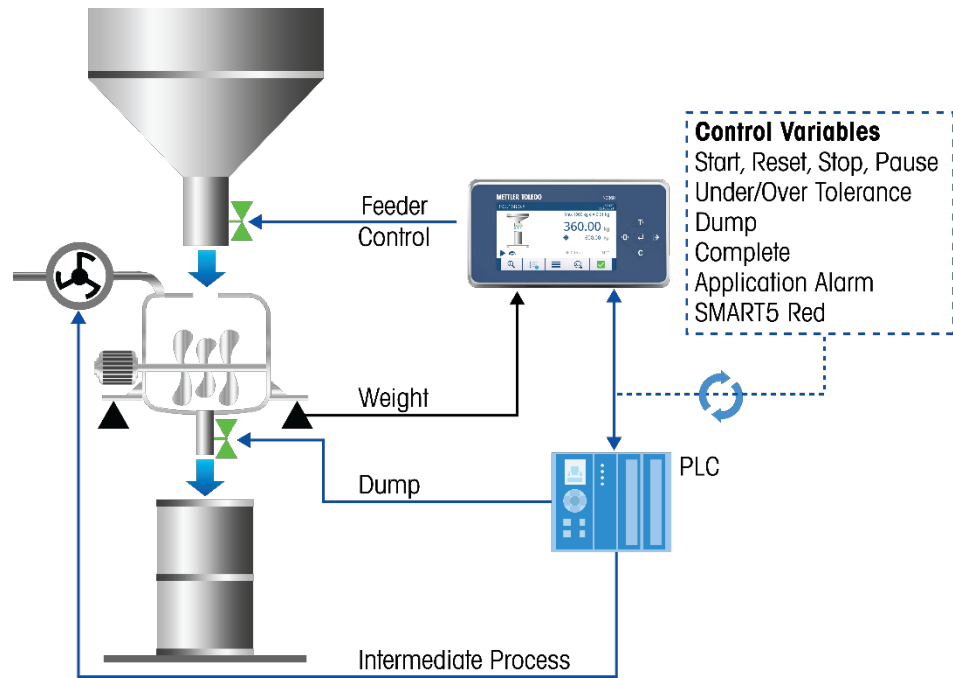

Figure 3-7: Fill-Dump Setup with Intermediate Process Managed by PLC

3.2.2.1. Detecting Dump Complete

Depending on the process, the IND360 includes two options to detect that the dump has been completed

- **Heel weight:** The remaining weight in the intermediate container falls below a defined threshold.
- **Time:** The dump is considered complete after a certain amount of time.

If the discharge gate does not open, the system will run into a dump timeout.

3.2.3. Dosing

In contrast to filling, dosing is a weighing-out operation. In this case, the source container is placed on the scale (Figure 3-8).

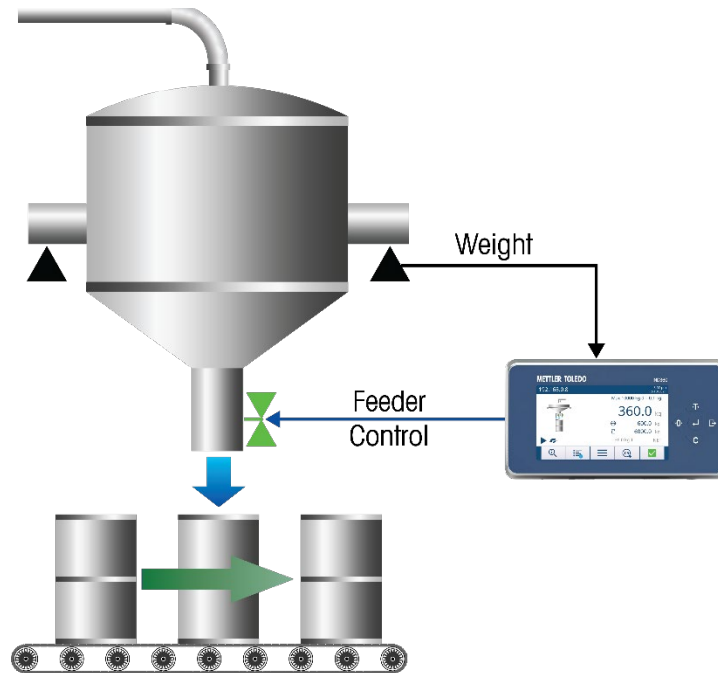

Figure 3-8: Dosing System Setup

3.2.3.1. Commissioning for Permanent Systems

For permanent dosing systems, it is recommended to perform the following setup procedure, to ensure a proper weight reading for the material in the source container:

1. Deploy, set up and adjust the weighing system – refer to sections 3 (**Configuration**) and 6 (**Installation**) in the **IND360base Indicator and Transmitter User's Guide**. Once this step has been executed, the weight will be captured properly.
2. Once the empty source container and all attached parts are in place, execute a zero adjustment (refer to section 2.5.1. **Zero** in the **IND360base Indicator and Transmitter User's Guide**). This operation zeros the scale and stores the zero point permanently.
3. The source container is ready to be filled. Because the scale's zero accounts for the weight of the empty container, only the material inside the source container is now being weighed. This data point is key when checking whether there is enough material for the next dosing cycle, and whether it is necessary to trigger a refill.

3.2.4. Refill/dose

In dosing mode, IND360 supports automatic replenishment of the source container, which is often a buffer container fed by a larger storage unit. The refill signal is available through a digital output and via the automation network.

3.2.5. Absolute (legacy)

In Absolute (legacy) mode, IND360 compares the absolute value of the change in weight to the target. There is no distinction between gain-in-weight and loss-in-weight. This mode functions similarly to the fill mode.

- **Note:** Because there is no distinction between positive and negative changes to the weight value, IND360 will not be able to detect weight changing in the opposite direction of what was intended. Logic should be added to the automation system to make sure a loss in weight occurs when a gain in weight was expected for example.

3.3. Filling vs. Dosing

In many cases, the decision for filling vs. dosing is driven by the machine design and previous processing steps. The differences in material dispensing behavior between these two operating modes are indicated in Table 3-1.

Table 3-1: Filling vs. Dosing

	Filling	Dosing
Material type	Liquids and solids	Liquids and solids
Scale weighing range	Scale optimized for target weight, ideal weighing range.	Higher capacity needed because buffer container holds material for multiple dispensing cycles
Material Disturbance	Impact of material on surface causes instability, negatively influencing filling and stabilization time.	Impact on stability is minor when dispensing material.
Target container	Accounted for by tare functionality.	Not relevant.
Quality Assurance and Traceability	Tolerance check of target container provides best assurance.	Tolerance check of source container, but cannot detect spillage

3.4. Automatic Optimization

IND360's built-in algorithms automatically adjust the spill and the cut-off point. This saves time during commissioning or when switching to a different material; furthermore, the material flow behavior may vary over time. Common reasons are changing material properties, and environmental conditions (e.g. temperature), clogged valves or wear and tear on the filling system. To cope with these changes and maintain high performance and accuracy, the IND360fill/dose continuously monitors the filling operation and automatically adjusts the cut-off points.

3.4.1. Spill

Spill optimization affects filling accuracy. It is recommended to use the Automatic optimization method, as this requires no configuration and adapts itself depending on the filling machine behavior.

3.4.1.1. Automatic Mode (recommended)

In automatic mode, the IND360 executes the following steps for optimizing the spill:

1. Uses the configured spill value as starting point; the closer this setting matches the actual spill value, the faster filling cycles will be within tolerances.
2. During the first several filling cycles, the algorithm characterizes the system and simultaneously begins to optimize the spill.
3. As filling cycles proceed, IND360fill/dose continues to optimize spill to adjust for changing conditions.

■ Note: The spill optimization algorithm is reset once a new spill value is set.

3.4.1.2. Manual Mode

Under special circumstances, or for additional control, the fill/dose firmware offers a manual optimization mode. In this mode, IND360 offers detailed configuration options to influence the spill optimization. These options define how sensitive the algorithm is in reacting to detected spill changes, and how many samples should be taken into account to prevent the algorithm from responding to single outlying values. Based on these settings, the spill value will be continuously monitored and optimized for highest accuracy.

3.4.1.3. Unknown Initial Spill Value

If the initial spill value is unknown, the following approach is recommended:

- Set the initial spill to a high value based on knowledge of the filling apparatus. This will result in an underfill during the first several filling cycles until the optimization algorithm determines the correct spill.
- Enable the jog function to correct initial underfill (caused by the high initial spill setting) by topping-up the missing material to reach the target.

3.4.2. Cut-off Optimization (Two-Speed Filling)

To increase the overall filling speed, the automatic cut-off optimization algorithm increases the fast feed time and reduces the feed time. Cut-off optimization is only applicable for two speed filling.

3.4.2.1. Automatic mode (Recommended)

IND360 determines the best settings for cut off optimization automatically. No additional configuration is needed. This is the recommended operating mode.

3.4.2.2. Manual mode

The manual mode offers additional configuration parameters for cut-off optimization. The manual mode is only required in special cases where the automatic mode does not deliver the desired result.

These configuration options influence how aggressively the algorithm optimizes for speed and how much averaging is done to filter fluctuations in system behavior. For more details, please refer to section 5, **Configuration**.

3.5. Managing Products and Filling Targets

Different products and the associated filling targets are often managed by higher-level systems (e.g. PLC/DCS, MES or other systems). IND360fill/dose offers a comprehensive automation interface to integrate with the PLC/DCS to accomplish this task. This empowers the PLC to reconfigure the IND360 depending on the selected product. To simplify and speed-up data exchange between the PLC/DCS and IND360, the Automation Interface - SAI 8-block format is recommended, because it allows the concurrent transmission of multiple variables. The 8-block SAI format is selected in the IND360 Configuration.

IND360fill/dose also offers a target table to store filling parameters for up to 10 products. Each product in the target table can be given a name and will automatically be assigned an ID number (1-10). Different products can be selected from the target table via the local IND360 display, the IND360 web interface or the PLC interface. Note that while the local display can be used to load preset values from the target table, it cannot be used to save changes to the target table.

3.5.1. Selecting Alternate Filling Targets

When the same product is filled, but with different filling targets, only the target value needs to be modified. The cut-off points remain valid because they have previously been set relative to the target. If the new target value is set too low compared to the cut-off points, IND360 generates a SMART5 yellow alert to indicate this logic error.

3.5.2. Switching Alternate Products

When changing to a new product, the new product's characteristics will differ from its predecessor's; therefore, multiple data points need to be adjusted to account for these differences. This can easily be done by enabling the filling target preset feature to save and load settings for up to 10 different products. Relevant data items are:

- Filling targets and associated tolerance information
- Cut-off points for feed levels and spill value
- Monitoring values like timeouts and weight thresholds for auto tare or heel weight

To switch to a new product via the automation system, select the ID of the product to be loaded. At this point, all relevant filling parameters are changed within IND360. The filling cycle can be started if there is confidence that the preset product parameters have not been changed. It is a good idea to have the automation system confirm the settings loaded match what was expected in case some parameters have been changed by a user.

When switching to a new product, the optimization is re-initialized with the presets provided by the PLC. The algorithm itself also begins recalculating spill and feed values. This way, the latest machine and environment conditions are accounted for.

3.6. Legal for Trade

A Legal for Trade approval is required for a gravimetric filling instrument that fills packages of the same nominal filling quantity for commercial trade. The IND360 weight indicator is approved according to the following regulations (EU-type examination certificate, issued by NMI Certin B.V.):

- MID 2014/32/EU, Automatic Weighing Instrument (AWI)
 - Following international recommendation OIML R61 (Automatic gravimetric filling instruments)
- MID 2014/31/EU, Non-Automatic Weighing Instrument (NAWI)
 - Following international recommendation OIML R76 (Non-automatic weighing instruments)

In addition each Automatic Gravimetric Filling Instrument is approved according to the country-specific regulations. When engineering such a device, please refer to the WELMEC 2.4 guidelines for additional recommendations. Important aspects building up the entire scale for approval are:

- IND360 weight indicator including the fill/dose application
- Load cells, weigh modules or scale
- Force transmission

These are key factors in passing the local conformity assessment. Please consult your METTLER TOLEDO representative for support and calibration services.

3.6.1. IND360fill/dose Configuration

For general IND360 Legal for Trade configuration options please refer to the IND360 Indicator User's Guide. The fill/dose application features an optional "startup delay" setting. During this delay time, normal operation of the indicator is suspended (except for setup access), enforcing the scale warm-up time sometimes demanded by regulations.

- When legal for trade mode is enabled, any tare (including auto tare) taken at or below 0 will fail.

4 Operation

This chapter provides detailed information about the operation of the IND360fill/dose automation indicator. It assumes that the user of this manual has reviewed and understood the operation of the IND360base. Refer to the **IND360base Indicator and Transmitter User's Guide** for details.

4.1. Examples of IND360fill/dose Operation

Typical use cases ranging from full PLC/DCS control to stand-alone operation are described in the following four sub-sections. Any combination thereof is possible as well, depending on the project need.

- For the purposes of simplicity, the filling example is used throughout this chapter. The same applies to dosing as well.

4.1.1. Automation Network Integration

In this scenario, the PLC manages the overall system, for example placing the containers (Figure 4-1). IND360 is connected to a PLC by means of an automation network supporting both cyclic and acyclic data exchange. The core filling operation is handled directly by IND360 through its digital output signals connected to the valve or pump.

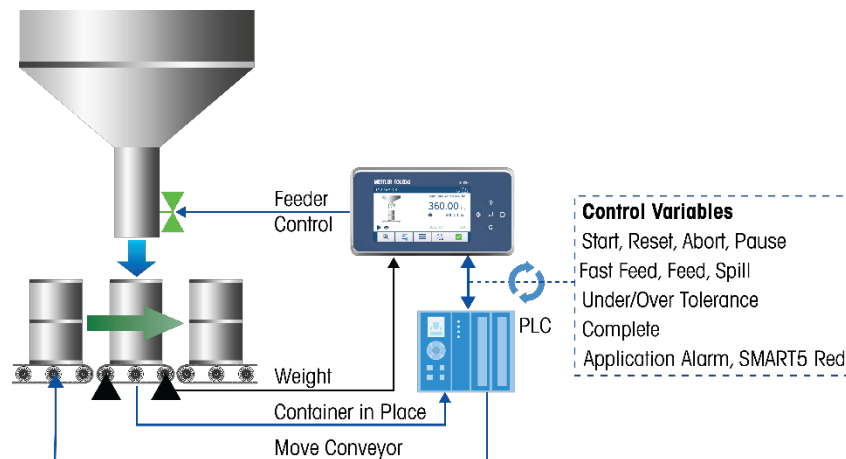

Figure 4-1: Example of Filling Line with IND360fill/dose Integrated into Automation Network

This distributed control approach combines two desired properties:

1. Direct, fast control of the filling valves or pumps, increasing filling accuracy by reducing the dead time. The PLC/DCS cycle time does not affect the filling performance.

2. Extensive possibilities to control and monitor the filling process through the PLC. IND360 provides read/write access to most configuration parameters and live monitoring of the filling process.

4.1.2. Digital Input/Output Connectivity with PLC

Compared to the previous scenario, the interaction between PLC and IND360fill/dose is by means of digital inputs and outputs (Figure 4-2). This setup is recommended when no automation bus is available or only a few control points shall be monitored.

The I/O assignment is configurable on IND360fill/dose. With the digital inputs, the state of the fill/dose operation is controlled (run, pause, stop, etc.) whereas the digital outputs provide status information and drive the valves. The filling target and cut-off points are configured through display or web interface.

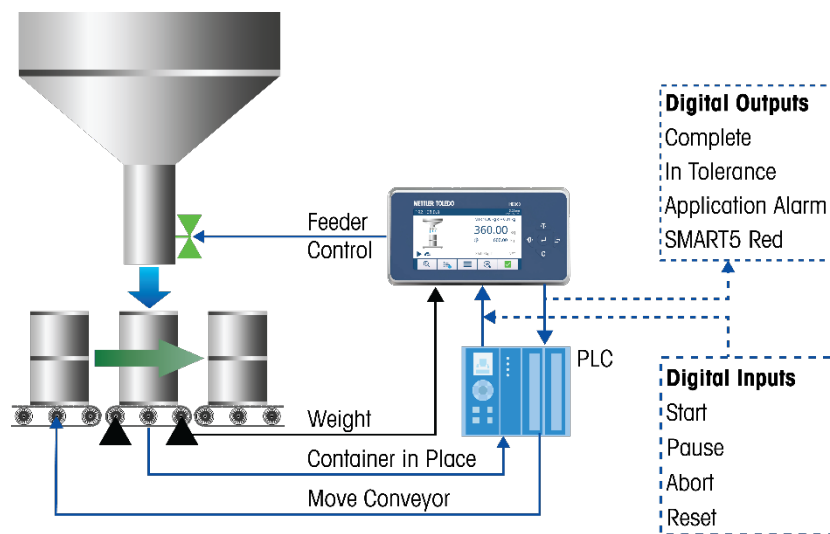

Figure 4-2: IND360fill/dose Connected to PLC Using Digital I/O

4.1.3. Semi-Automatic Without PLC

IND360fill/dose can cover basic, semi-automatic use-cases. For instance, this could be a filling machine where an operator places a bag and presses a button to execute one filling cycle (Figure 4-3). In this setup, there is no PLC present. The user controls the filling operation through switches connected to the digital input of the IND360 (e.g. sending the start signal). The digital outputs drive the filling process and indicate the status through connected status lights. The web interface or the display serves as configuration interface.

- In case the IND360 is equipped with an Industrial Ethernet port, disable the **Supervisor** function in the setup menu at **Communication > Industrial Ethernet** to avoid a red alarm indicating that a PLC is not connected.

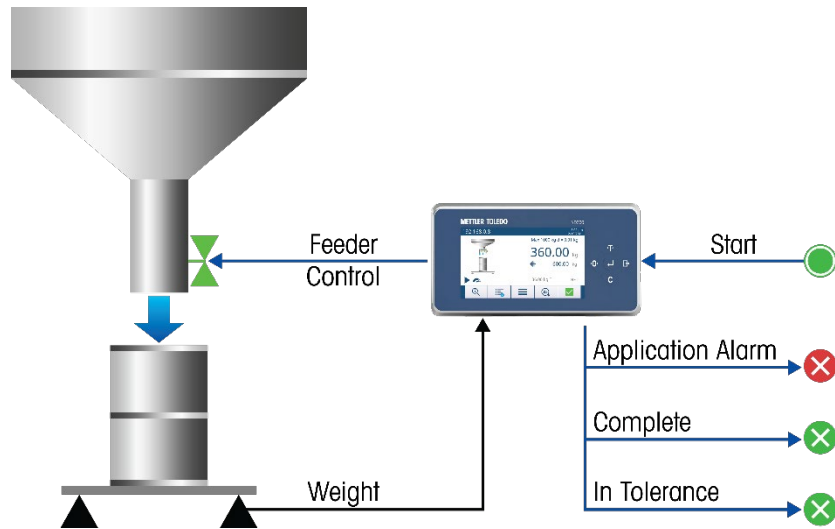

Figure 4-3: IND360fill/dose Stand-Alone Operation for Basic, Semi-Automatic Filling

4.2. Application State Machine

The operational behavior of the filling application is defined by its state machine (Figure 4-4). The application is always in one of the five states and the transition between the states is either automatic or by a command.

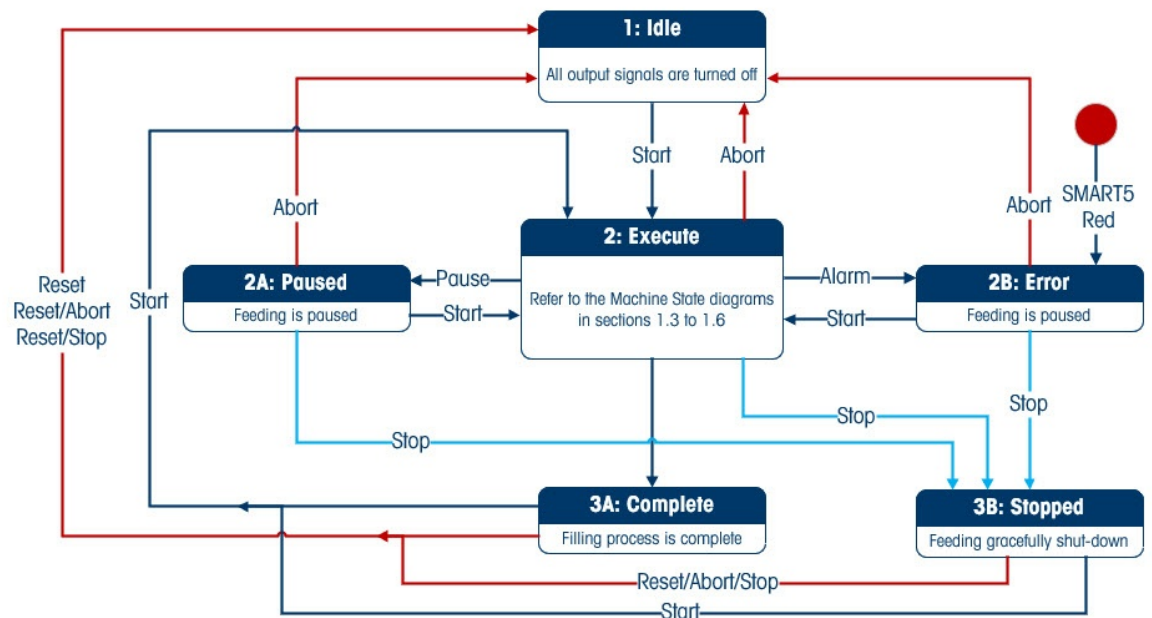

Figure 4-4: IND360fill/dose State Machine

Table 4-1: Machine States

State	Description	Exit from State
Idle	Initial state at startup. In this state all digital outputs are turned off (safe state). When in Idle , the process can either remain there or transition to Execute . The device must be in its Idle state to permit changes application to the application parameters	Start -> Execute
Execute	The filling or dosing process is currently running. If an alarm affecting the application is detected, the process will automatically transition to Error . The process can be paused manually, aborted or stopped at any time before completion. Upon completion, the system transitions to Complete .	Pause -> Paused Abort -> Idle Alarm -> Error Completion -> Complete Stop -> Stopped
Paused	The feeding process has been paused. When ready, the process can resume from where it left off by transitioning back to Execute . If the abort signal is sent, the process is aborted and transitions back to Idle. If the stop signal is sent, the process is stopped	Start -> Execute Abort -> Idle Stop -> Stopped
Error	An error has occurred, and the application has been paused for safety reasons. Once the error is no longer present, issuing the start command can transition the process back to Execute . If the error is still present when the start command is issued, the process will return to Error . If desired, the process can be aborted to transition to Idle using the abort command. The process can also be moved to the Stopped state using the stop command.	Start -> Execute Abort -> Idle Stop -> Stopped
Complete	Filling or dosing process has completed. There are two options: start another cycle immediately from this state or we can reset to Idle if necessary to transition to the safe state and change parameters.	Start -> Execute Reset -> Idle
Stopped	Filling or dosing has been stopped. This differs slightly from the abort process to return to an idle state. In the stopped state, the device will take action to return to a good starting point (e.g. If fill/dump process is stopped in the middle of a fill, vessel will be dumped to empty in order to start the next cycle with an empty vessel). When using the abort process to return to idle state, no additional actions are taken. If Start command is used while in Stopped state, a new cycle will begin. The previous cycle will not resume.	Reset -> Idle Start ->Execute

4.3. Five Modes of Operation

The IND360fill/dose Application offers five modes:

- Fill: fill material into target container, which is placed on the scale
- Fill/Dump: fill material into an intermediate buffer container and once the target has been reached, dump into target container.
- Dose: loss-in-weight, dispense from source container on scale into target container
- Refill/Dose: same as dose with automatic refill
- Absolute: compare the absolute value of the net weight to the target. This mode can be used for both gain-in-weight and loss-in-weight applications

This subsection explains the details of the execution state for each of the operating modes. The overall state machine still applies so for example in case we hit pause we transition to the Paused state.

4.3.1.

Fill

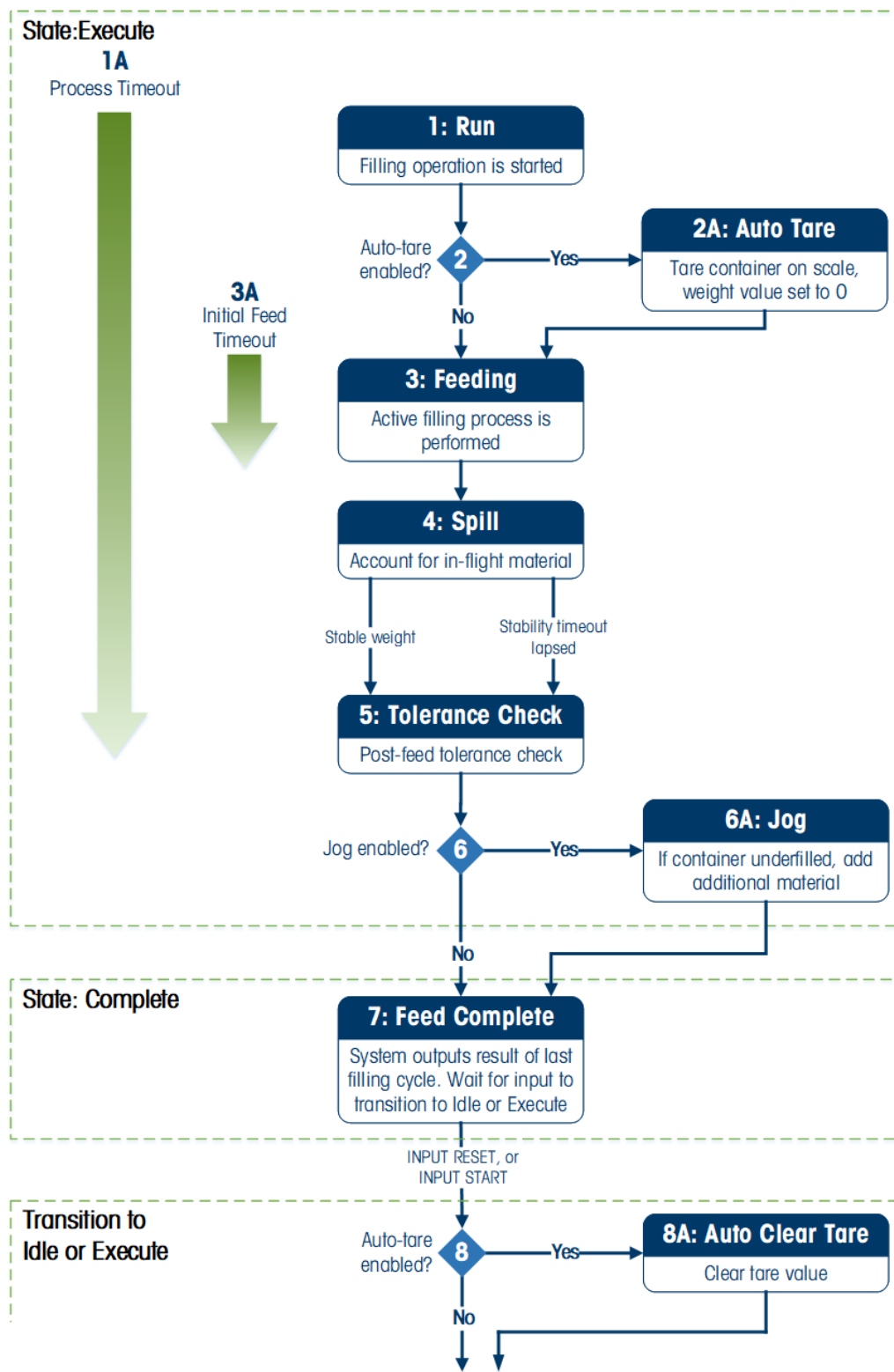

Figure 4-5: Filling Operation Flow Chart

Table 4-2: Filling Process States

State	Step	Description
Run	1	When the process transitions from Idle to Execute , it enters its Run state.
Error		If an error affecting the fill occurs, the application will quit the Execute -flow and transition to its Error state
Auto Tare	2/2A	If enabled, Auto Tare checks if the starting weight value is within the configured Auto Tare tolerances. If so, a tare is automatically taken, and the filling process begins with a net weight of 0.
Feeding	3	Active filling occurs. The Feeding state includes most of the filling process. Material is added until $\text{Gain in Weight} = \text{Target} - \text{Spill}$
Spill	4	Spill refers to the amount of material expected to dispense after the command to stop filling is issued. Known spill values can be entered manually, or the IND360 can use optimization algorithms to improve the spill value over time for more accurate filling.
Tolerance Check	5	Once the weight value is stable, the process will evaluate whether the added weight was within acceptable tolerance values configured by the user. If so, the process will continue to Feed Complete. If not, the optional Jog function can be used to correct for an under-fill. <ul style="list-style-type: none">■ A maximum time to wait for stability can be set by the "stability timeout" parameter. Once this time elapsed, the system will perform the tolerance check based on the unstable weight.
Jog	6/6A	This optional feature corrects for an under-filled condition. If an under-fill occurs, material will be added using one or more Jog cycles until weight value reaches the target
Feed Complete	7	The process is complete. Results of the fill cycle are available and can be fetched using digital I/O or through the automation network.
Auto Clear Tare	8/8A	If Auto Tare is enabled, the tare value used in filling is cleared and the process transitions to Idle or Execute .

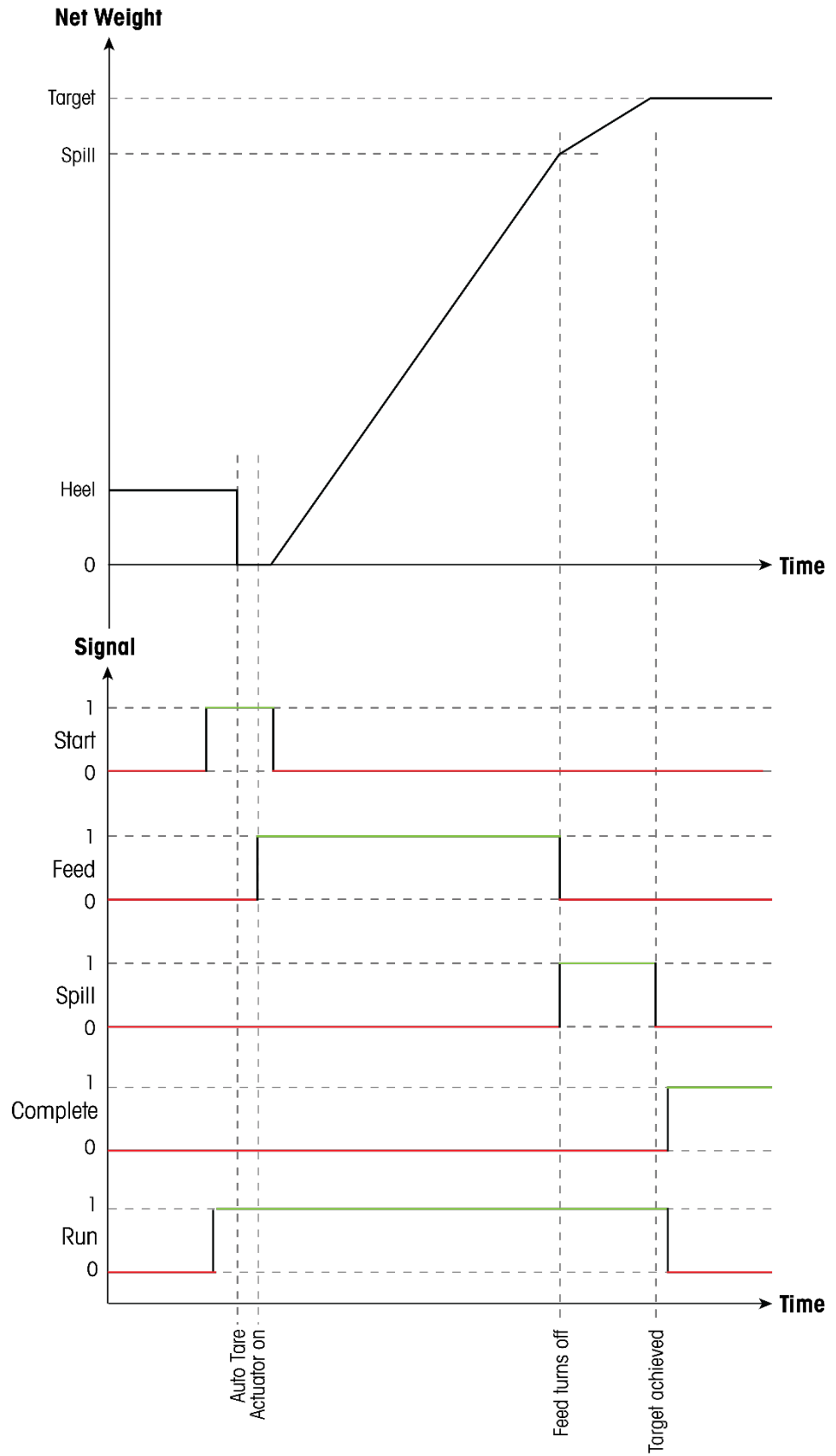

Figure 4-6: Filling Process Timing Diagram

4.3.2. Fill/Dump

Fill/dump is very similar to fill except for the additional dump step.

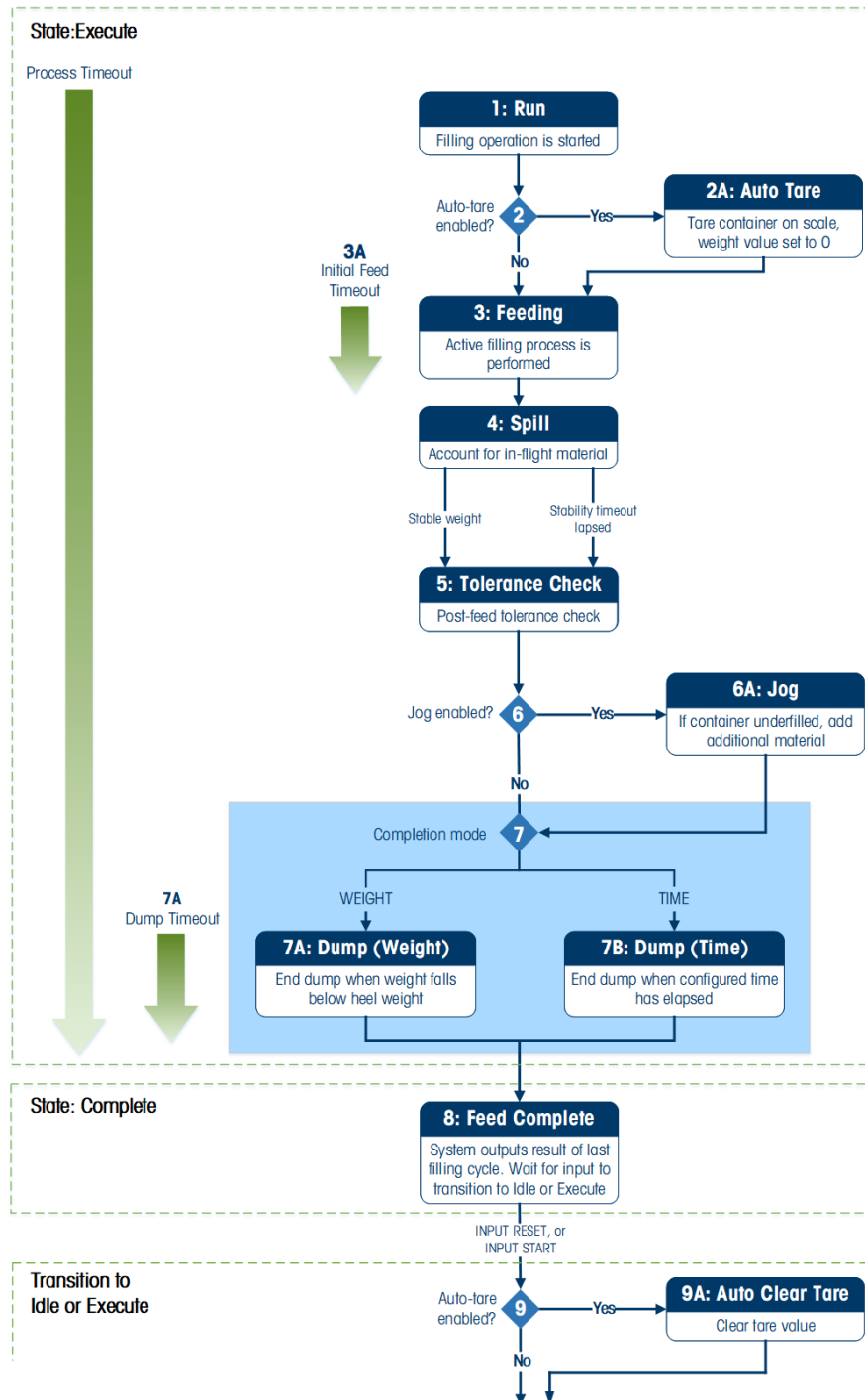

Figure 4-7: Fill/Dump Operation Flow Chart

Table 4-3: Fill/Dump Process States

State	Step	Description
Run	1	When the process transitions from Idle to Execute , it enters its Run state.
Error		If an error affecting the fill occurs, the application will quit the Execute-flow and transition to the Error state.
Auto Tare	2/2A	If enabled, Auto Tare checks if the starting weight value is within the configured Auto Tare tolerances. If so, a tare is automatically taken, and the filling process begins with a net weight of 0.
Feeding	3	Active filling occurs. The Feeding state includes most of the filling process. Material is added until $\text{Gain in Weight} = \text{Target} - \text{Spill}$
Spill	3	Spill refers to the amount of material expected to dispense after the command to stop filling is issued. Known spill values can be entered manually, or the IND360 can use optimization algorithms to improve the spill value over time for more accurate filling.
Tolerance Check	5	Once the weight value is stable, the process will evaluate whether the added weight was within acceptable tolerance values configured by the user. If so, the process will continue to Feed Complete. If not, the optional Jog function can be used to correct for an under-fill. <ul style="list-style-type: none">■ A maximum time to wait for stability can be set by the "stability timeout" parameter. Once this time elapsed, the system will perform the tolerance check based on the unstable weight.
Jog	6/6A	Optional feature to correct for an under-filled condition. If under-filled, additional material will be added until weight value reaches the target
Dump (Weight)	7/7A	If the process is configured for dump completion based on weight, the dump valve is opened until the tank is empty, minus an acceptable amount of remaining material known as the heel.
Dump (Time)	7/7B	If the process is configured for dump completion based on time, the dump valve is opened for a pre-configured amount of time. The dump valve closes at the end of that time regardless of the weight of the tank.
Feed Complete	8	The process is complete. Results of the fill cycle are available and can be fetched using digital I/O or through the automation network.
Auto Clear Tare	9/9A	If Auto Tare is enabled, tare value used in filling is cleared and the process can move to Idle or Execute

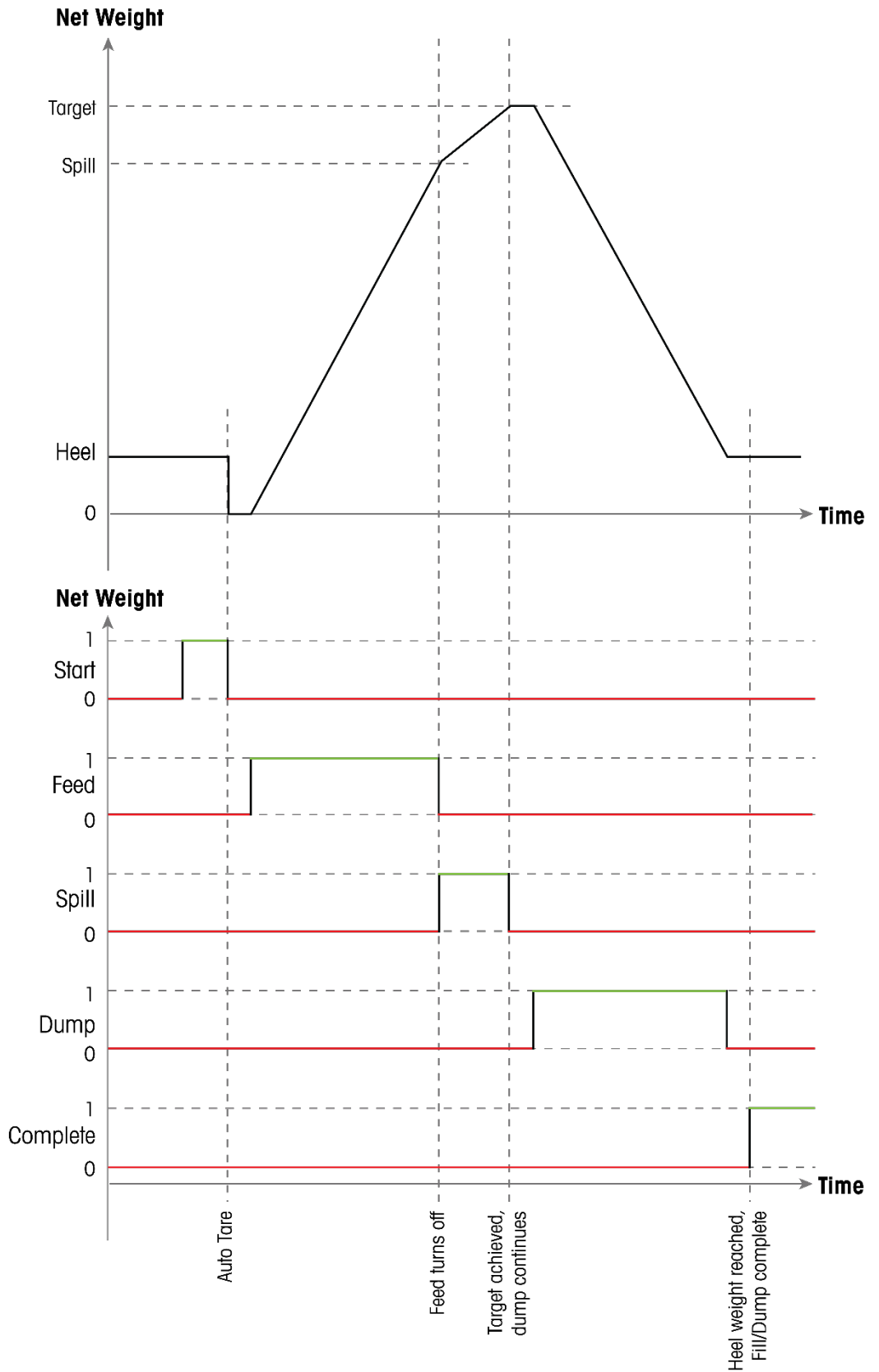

Figure 4-8: Fill-Dump Process Timing Diagram

4.3.3.

Dosing

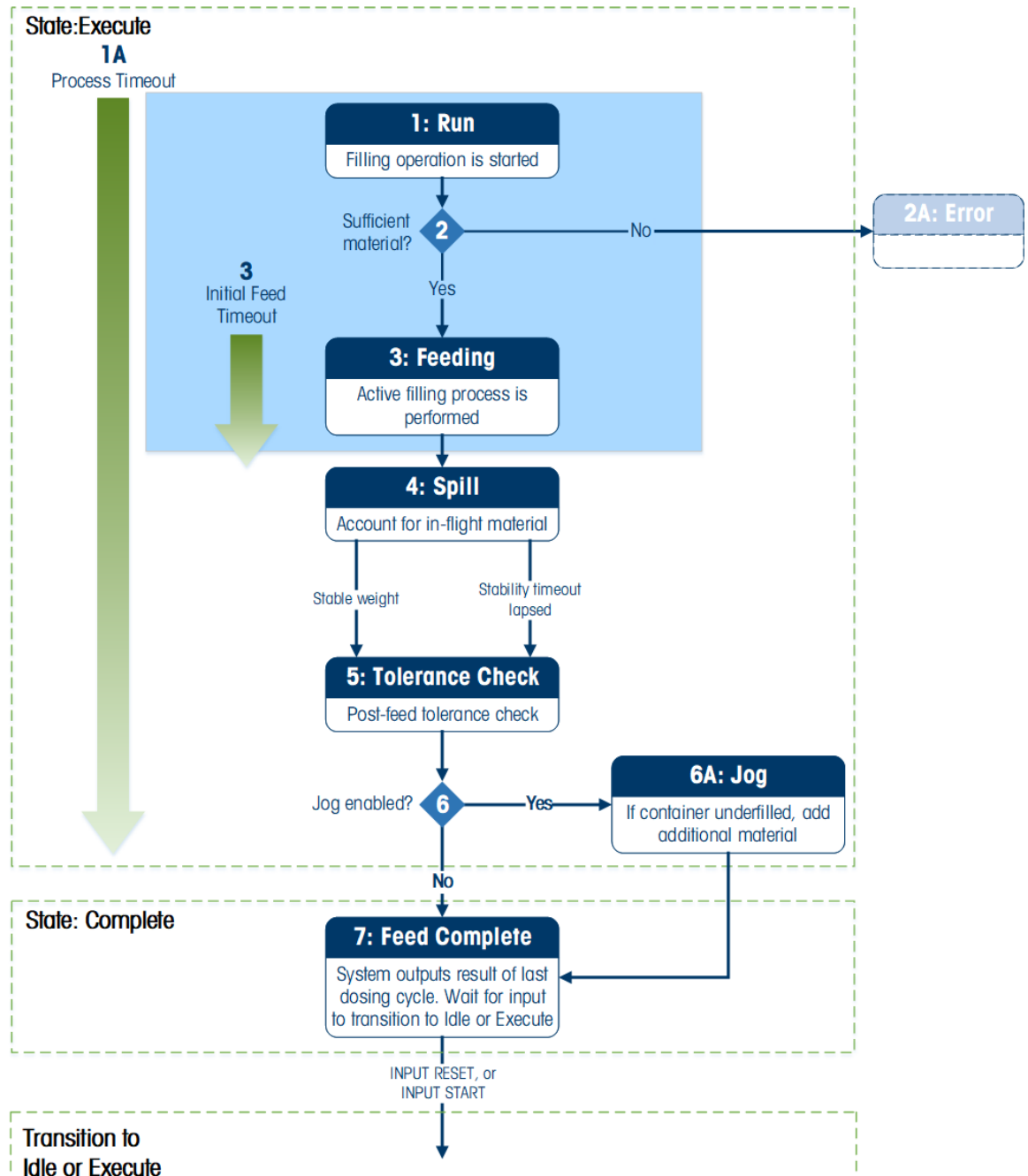

Figure 4-9: Dosing Operation Without Automatic Refill

Table 4-4: Dosing Without Automatic Refill Process States

State	Step	Description
Run	1	When the process transitions from Idle to Execute , it enters its Run state.
	2	Check weight to ensure that sufficient material is present to complete the dosing cycle.
Error	2A	If there is insufficient material to perform the dose, or if an error affecting the dose operation occurs, the process will transition to Error .
Feeding	3	Active filling occurs. The Feeding state includes most of the filling process. Material is dispensed until $\text{Loss in Weight} = \text{Target} - \text{Spill}$
Spill	4	Spill refers to the amount of material expected to dispense after the command to stop dosing is issued. Known spill values can be entered manually or the IND360 can use optimization algorithms to improve the spill value over time for more accurate dosing.
Tolerance Check	5	Once the weight value is stable, the process will evaluate whether the dispensed weight was within acceptable tolerance values configured by the user. If so, the process will continue to 7: Feed Complete . If not, the optional Jog function can be used to correct for an under-fill. <ul style="list-style-type: none"> ■ A maximum time to wait for stability can be set by the "stability timeout" parameter. Once this time elapsed, the system will perform the tolerance check based on the unstable weight.
Jog	6/6A	Jog is an optional feature used to correct for an under-dosed condition. If an under-dose occurs, additional material will be dispensed until dose value is within configured tolerances
Feed Complete	7	The process is complete. Results of the dose cycle are available.

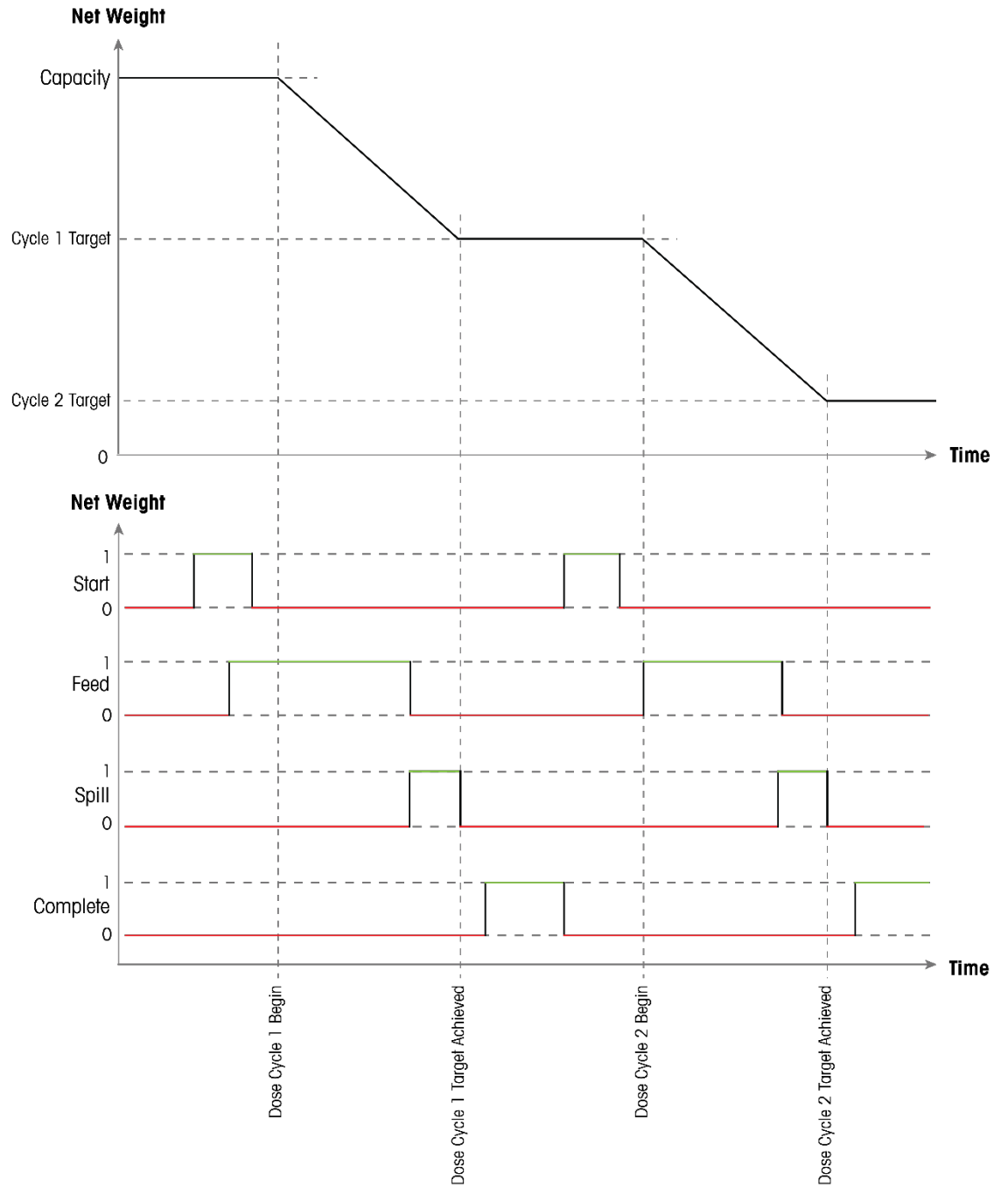

Figure 4-10: Dosing Without Automatic Refill Process Timing Diagram

4.3.4.

Refill/Dose

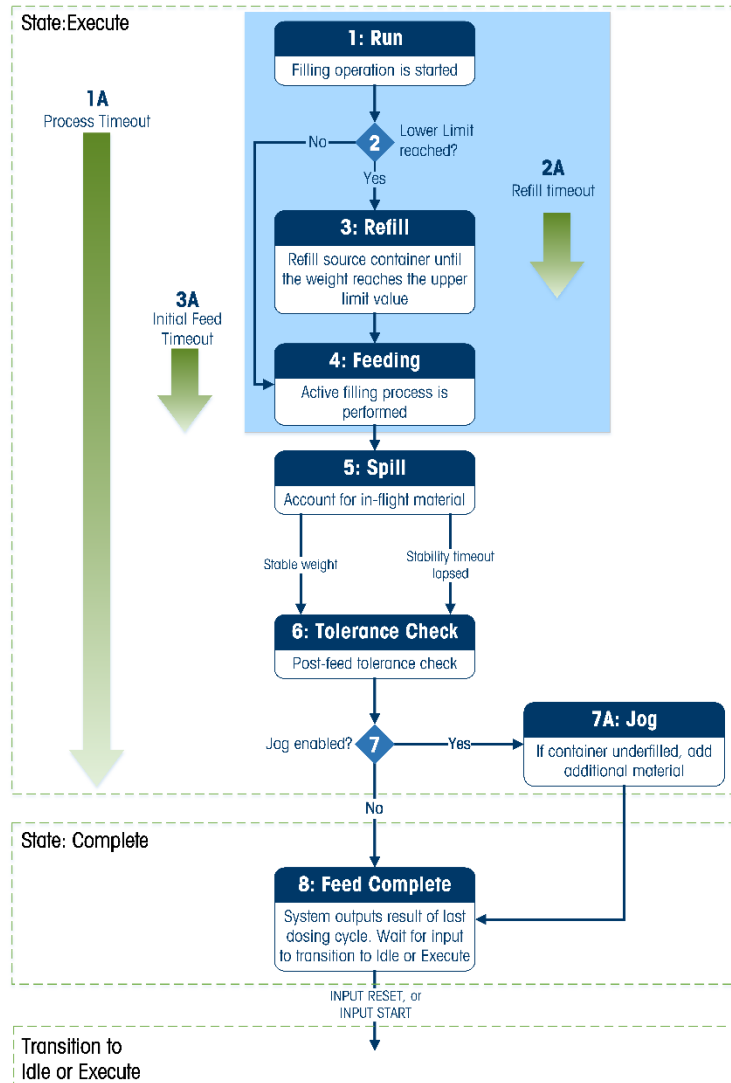

Figure 4-11: Refill/Dose Process Flow Chart

Table 4-5: Refill/Dose Process States

State	Step	Description
Run	1	When the process transitions from Idle to Execute , it enters its Run state.
	2	Check weight to ensure that sufficient material is present to complete the dosing cycle.
Refill	3	If the process detects insufficient material to perform the dose, Refill is initiated. The tank will be refilled until its weight reaches the configured upper limit or the refill timeout is reached, whichever occurs first.
Feeding	4	Active filling occurs. The Feeding state includes most of the filling process. Material is dispensed until $\text{Loss in Weight} = \text{Target} - \text{Spill}$

State	Step	Description
Spill	5	Spill refers to the amount of material expected to dispense after the command to stop dosing is issued. Known spill values can be entered manually or the IND360 can use optimization algorithms to improve the spill value over time for more accurate dosing.
Tolerance Check	6	Once the weight value is stable, the process will evaluate whether the dispensed weight was within acceptable tolerance values configured by the user. If so, the process will continue to Feed Complete . If not, the optional Jog function can be used to correct for an under-fill. <ul style="list-style-type: none"> ■ A maximum time to wait for stability can be set by the “stability timeout” parameter. Once this time elapsed, the system will perform the tolerance check based on the unstable weight.
Jog	7/7A	Jog is an optional feature used to correct for an under-dosed condition. If an under-dose occurs, additional material will be dispensed until dose value is within configured tolerances
Feed Complete	8	The process is complete. Results of the dose cycle are available.

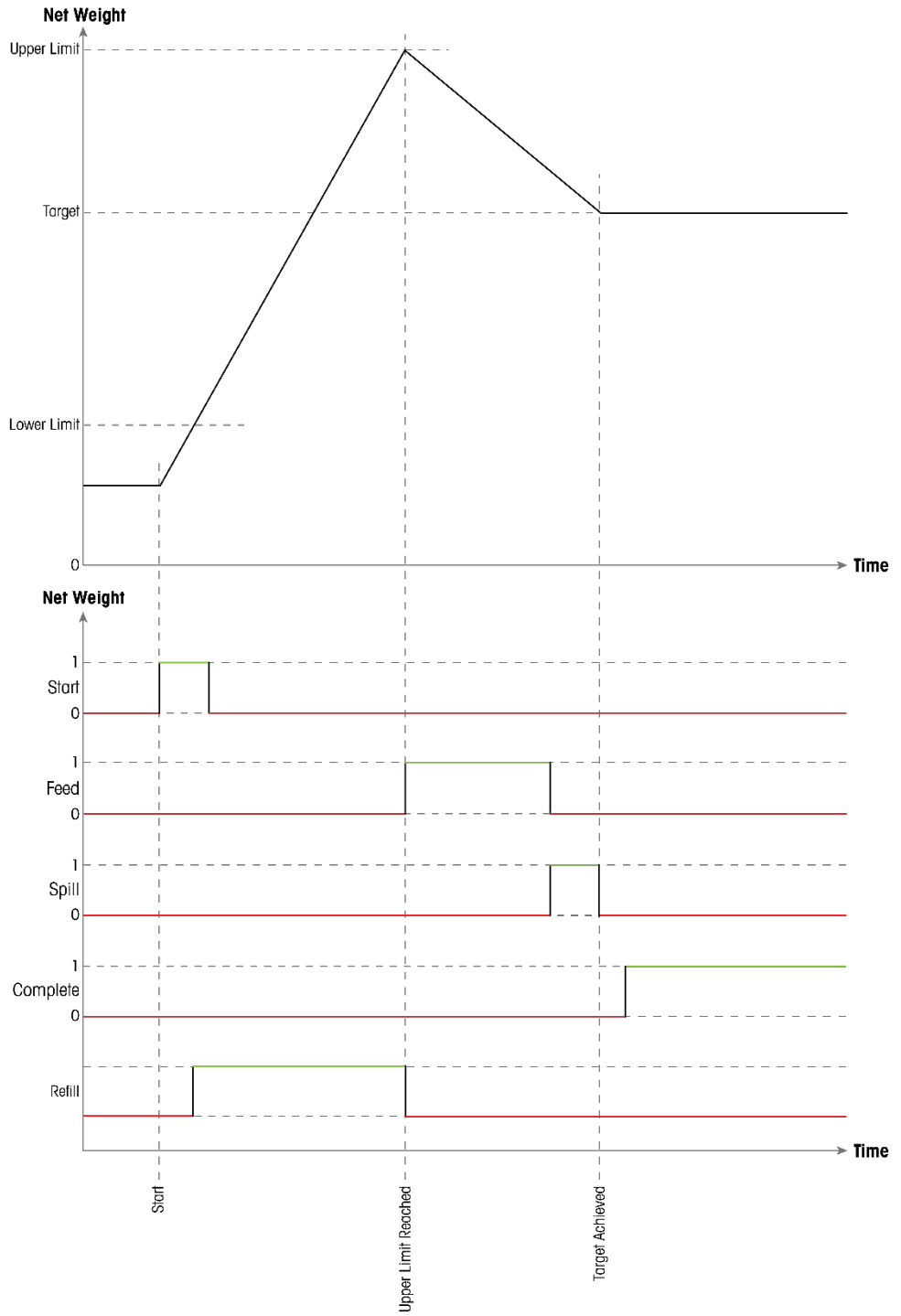

Figure 4-12: Refill/Dose Process Timing Diagram

4.3.5. Absolute (legacy)

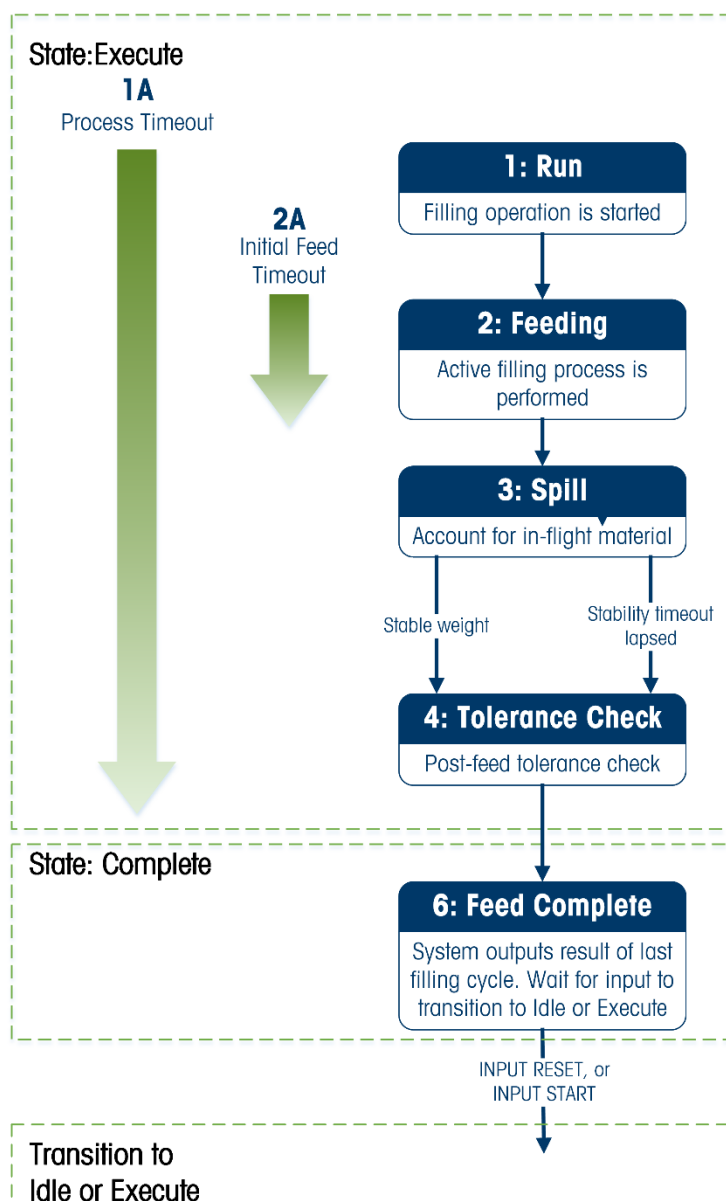

Figure 4-13: Absolute Operation Flow Chart

Table 4-6: Absolute Process States

State	Step	Description
Run	1	When the process transitions from Idle to Execute , it enters its Run state.
Error		If an error affecting the fill occurs, the application will quit the Execute -flow and transition to its Error state
Feeding	2	Active filling occurs. The Feeding state includes most of the filling process. Material is added until $ \text{Change in weight} = \text{Target} - \text{Spill}$

State	Step	Description
Spill	3	<p>Spill refers to the amount of material expected to dispense after the command to stop filling is issued. Known spill values can be entered manually, or the IND360 can use optimization algorithms to improve the spill value over time for more accurate filling.</p>
Tolerance Check	4	<p>Once the weight value is stable, the process will evaluate whether the added weight was within acceptable tolerance values configured by the user. If so, the process will continue to Feed Complete. If not, the optional Jog function can be used to correct for an under-fill.</p> <ul style="list-style-type: none"> ■ A maximum time to wait for stability can be set by the “stability timeout” parameter. Once this time elapsed, the system will perform the tolerance check based on the unstable weight.
Feed Complete	6	<p>The process is complete. Results of the fill cycle are available and can be fetched using digital I/O or through the automation network.</p>

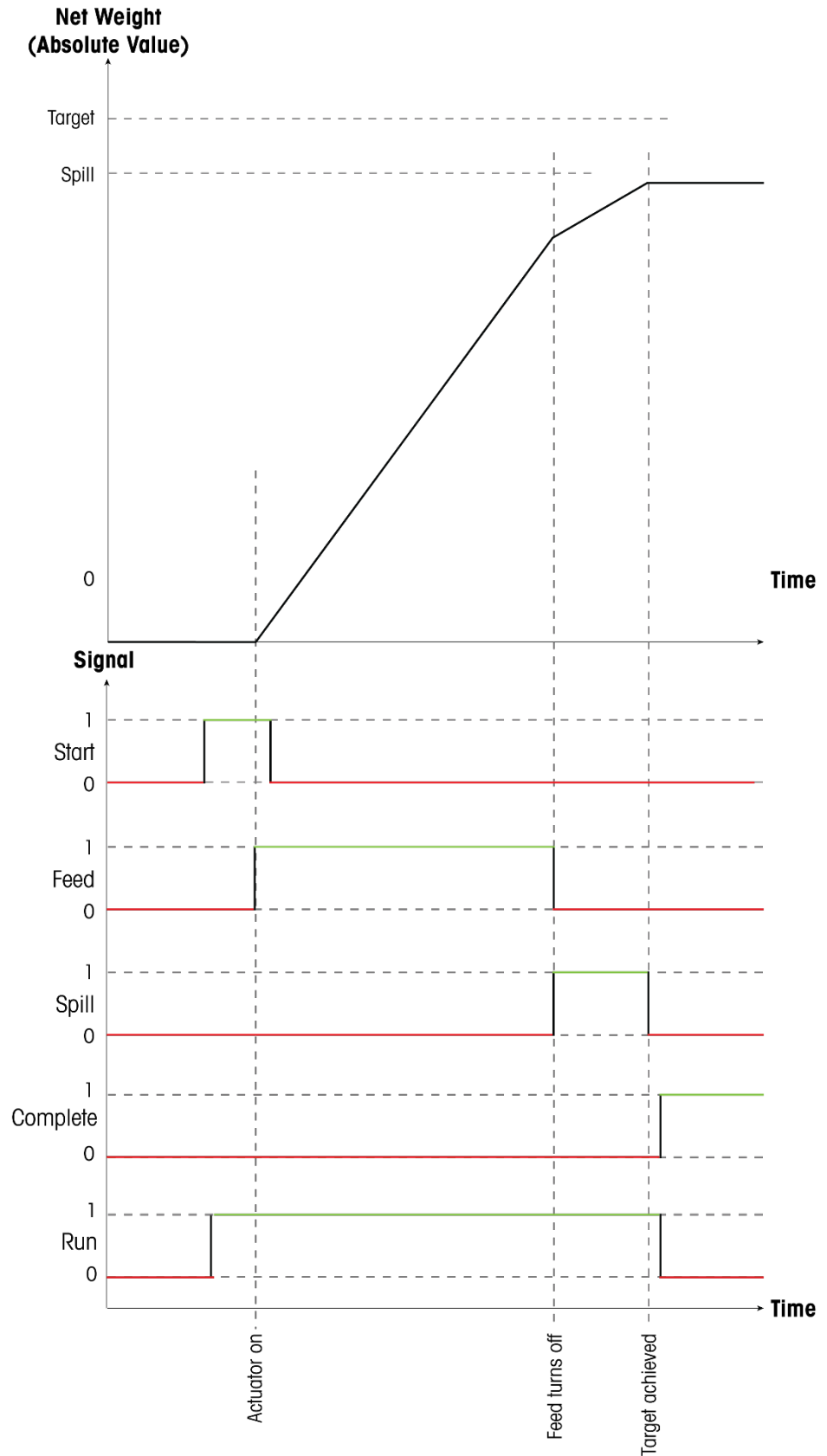

Figure 4-14: Absolute Process Timing Diagram

4.4. Jog Function

When IND360 detects an underfill at the end of a filling cycle, it moves into its jog state. Once the target weight is reached or exceeded, the IND360 exits the jog state and transitions to complete. The following jog modes are available.

4.4.1. Automatic

In case of an underfill, IND360 autonomously executes the jog operation and transitions to complete when done. Limiting the maximum number of jog cycles prevents potential filling equipment damage caused by many jog cycles due to missing material. This is the most convenient method and recommended for automation systems.

Configuration parameters: Pulse duration, Maximum number of jogs, Pause duration.

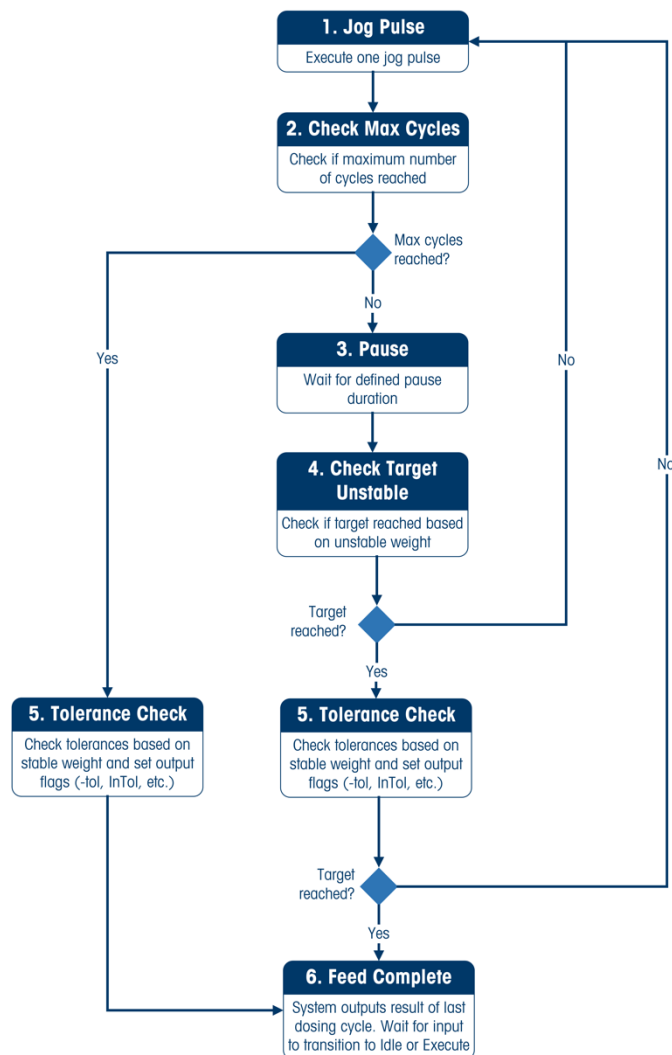

Figure 4-15: Automatic Jog Function Sequence

The automatic jog cycle proceeds as follows:

1. On entering the jog state, the system executes one jog pulse of set duration.
2. After the pulse, a Max Cycles check is performed.
 - a. If the maximum allowed number of cycles has been reached, the system performs a tolerance check and proceeds to its Feed Complete state.
3. If the maximum number of cycles has not been reached, the system pauses for a set period to allow the weighing system to settle.
4. IND360 executes a tolerance check using current weight reading, not waiting for stability
 - a. If the target has not been reached yet, execute another jog pulse
5. Once target reached based on tolerance check in step 4, IND360 waits for a stable weight reading and executes a tolerance check.
 - a. If the target has not been reached yet, execute another jog pulse
6. The system enters the Feed Complete state under two conditions: Target reached or maximum number of jogs was met.

4.4.2. Single Pulse

When an under-fill is indicated either an operator presses a physical button, or a PLC issues a command, and the IND360 executes a single jog cycle of set duration. This action is repeated until the target weight is met. The jog cycle can be stopped at any point using the stop command. This method allows the PLC or operator to control when to execute the jog pulse. The feed pulse itself is controlled by IND360.

Configured parameter: Pulse duration.

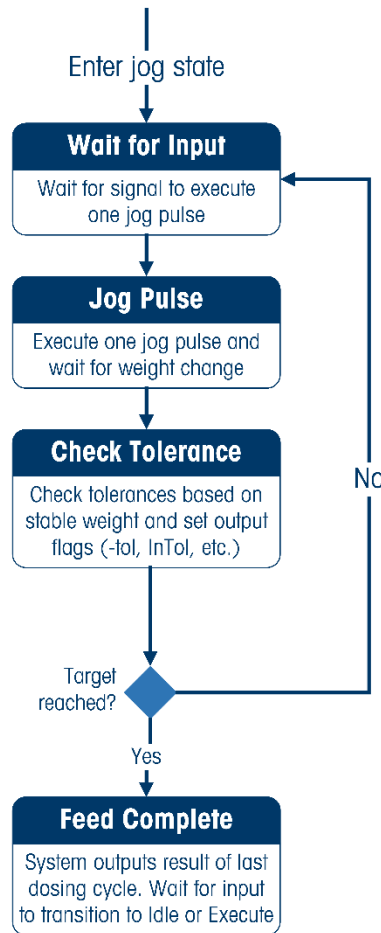

Figure 4-16: Single Jog Function Sequence

4.4.3. Manual

The PLC or operator executes the jog function and directly controls the actuators. Afterwards, the IND360 is signaled that the jog has been completed and IND360 executes a tolerance check to assess whether another round of jog is required.

This mode is ideal when the jog is executed externally. This could either be a PLC implementing a jog algorithm or an operator performing the jog manually.

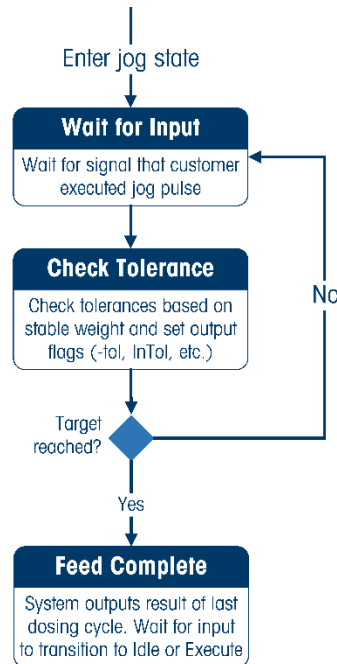

Figure 4-17: Manual Jog Function Sequence

4.5. Starting and Stopping the Fill/dose Application

Starting or stopping the fill/dose application is controlled through a discrete input, local display or via PLC/DCS communication. The application cannot be started through the web interface.

4.6. User Management

IND360 supports three levels of user security that rely on appropriate username / password entry for access to Setup menu and fill/dose functions. When the application is running, the Setup menu can only be accessed in read-only mode, whatever level of user security is authenticated. Refer to Section 2.2, **User Security**, in the **IND360base Indicator and Transmitter User's Guide** for detailed information on user security.

Table 4-7: Setup Menu Access Levels

Setup Menus	Administrator	Supervisor	Operator
Scale	Read & Write	Read	Read
Application	Read & Write	Read & Write	Read
Terminal	Read & Write	Read	Read
Communication	Read & Write	Read	Read
Maintenance	Read & Write	Read & Write	Read

4.7. Data Record

The Data Record is available when using the indicator in combination with the Fill/dose application. After a successful fill or dosing cycle, IND360 automatically writes a Data record if the Data Record has been enabled.

The entire Data Record can be exported to a .csv file by navigating to Maintenance->Configure/View->Data Record in the IND360 web interface. Individual records can be viewed using the local IND360 TFT display (panel and harsh mount only) or via PLC command.

Transaction	Start Time	Finish Time	Target	Net delivered	Tolerance	Status	Gross	Net	Tare	Unit	Tare Mode
1	10/13/2023 11:15:46 AM	10/13/2023 11:16:03 AM	10	9.66	Under	1	9.64	9.66	-0.02	kg	T
2	10/13/2023 11:16:15 AM	10/13/2023 11:16:32 AM	10	10.28	Over	1	20.29	10.28	10.01	kg	T
3	10/13/2023 11:16:41 AM	10/13/2023 11:16:58 AM	10	9.98	In	1	30.06	9.98	20.06	kg	T
4	10/13/2023 11:17:11 AM	10/13/2023 11:17:28 AM	10	10	In	1	40.04	10	30.06	kg	T

Figure 4-18 Data Record .CSV Example

4.7.1. Elements of Data Record

Transaction	ID number for the transaction. When reading individual elements from the data record via the local display or PLC, the transaction number is used to identify the transaction to read
Start Time	IND360 system time when the fill or does cycle started
Finish Time	IND360 system time when the fill or dose cycle ended
Target	Target weight for the fill or dose cycle
Net Delivered	Weight of material delivered during the fill or dose cycle

Tolerance	Indicates whether the Net Delivered during the cycle was in or out of the tolerance values set in the application parameters
Status	Indicates whether the cycle completed normally, was stopped, paused, etc.
Gross	Gross weight on the scale when the cycle completed
Net	Net weight on the scale when the cycle completed
Tare	Tare weight taken during the cycle
Unit	Weighing unit. All weight values in a single Data Record transaction use this weighing unit.
Tare Mode	Indicates that a tare was taken

4.8. ePrint Function

When ePrint function is enabled, IND360 automatically sends an ePrint to the configured output port upon completion of a fill cycle. The output contains time information, target-setting and the amount of material dispensed (Figure 4-18).

For more information on how to use the ePrint function, please refer to the **IND360base Indicator and Transmitter User's Guide**.

```

Fill cycle:                               9
Start:                                00:03:17 2010/01/01
Finish:                               00:03:35 2010/01/01
Target:                                10.00 kg
Net delivered:                          10.01 kg
Deviation:                              0.01 kg
Tolerance:                              In
Status:                                 1
Tare Mode:                              T
Gross:                                  10.01 kg
Net:                                    10.01 kg
Tare:                                   0.00 kg
*****
    
```

Figure 4-19: ePrint Template of Fill/dose Application

4.9. Statistics

The statistics area stores statistical data for the fill/dose application:

Name	Description
Min. cycle weight	Smallest amount of material dispensed among all completed filling or dosing cycles. Value range: [0 , 99999999.9999]
Max. cycle weight	Largest amount of material dispensed among all completed filling or dosing cycles

Name	Description
	Value range: [0 , 99999999.9999]
Total cycle weight	Total amount filled or dosed since last statistics reset (accumulated weight) Value range: [0 , 99999999.9999]
Total buckets	Total number of filling or dosing cycles executed since last statistics reset Value range: [0 , 4000000000]
Valid buckets	Number of valid filling or dosing cycles executed since last statistics reset Value range: [0 , 4000000000]

To reset the statistics information, use the **clear statistics** function within the application settings.

4.10. Smart5 Alarms

IND360fill/dose follows the SMART5™ alarm management. For more information on alarm management, please refer to the **IND360 Indicator and Transmitter User's Guide**.

Table 4-8: Smart5 Alarm List

ID	Alarm	Mode	Description	Action
6200	Auto tare failed	Fill	Auto tare failed because weight value out of range. Potential causes: no container placed, full container not removed, spilled material on platform, etc.	Inspect weighing platform and remove excessive material.
6203	Process timeout	Fill, Dose	The filling or dosing process exceeded its configured time limit. Potential causes: unstable environment, clogged valve, insufficient material, etc.	Inspect material quantity and feeding system. Increase process timeout if conditions are valid.
6204	Parameter invalid	Fill, Dose	Application parameter value invalid (value out of bounds)	Check application parameter settings, refer to ID to pinpoint the issue (refer to Table 4-9).
6205	Parameter logic invalid	Fill, Dose	Incorrect combination of application parameters	Check application parameter settings, refer to ID to pinpoint the issue (refer to Table 4-9).
6206	Refill timeout	Dose	The refill operation of the source container timed out. Potential causes: refill pump broken, storage tank out of material, etc.	Inspect refill infrastructure. Increase refill timeout in case this is a valid condition.
6209	Initial feed timeout	Fill, Dose	After starting the filling process, the device did not detect a weight change within the given time. Potential causes: clogged valve, insufficient material, material	Inspect filling infrastructure. Increase initial feed timeout if this is a valid condition.

ID	Alarm	Mode	Description	Action
6210	Dump timeout	Fill/Dump	The dump operation exceeded its time limit. Potential causes: valve not opening, sticky material, etc.	Inspect filling infrastructure. Increase dump timeout if this is a valid condition.
6211	Start weight invalid	Fill	The current starting weight for the filling operation exceeds the filling target.	Remove excessive weight from scale and restart the filling operation.
6212	Insufficient material	Dose	Not enough material in the source container to start the dosing operation.	Refill the dosing container or activate automatic refill functionality.
6213	Maximum jog cycles	Fill, Dose	Maximum number of automatic jog cycles reached	Ensure that sufficient material is present and that the actuator is not blocked.

4.11. Error Codes

If the filling process is started with an invalid configuration, IND360fill/dose reports a SMART5™ yellow alarm. To pinpoint the incorrect setting, the alarm message is accompanied by a code. Table 4-9 provides an interpretation of the codes.

Table 4-9: Error Code List

Category	Code	Parameter
System setup	101	Work mode setting invalid
	102	Feed speeds setting invalid
	103	Output type setting invalid
	104	Cycle result mode invalid
	105	Power outage handling mode invalid
Target configuration	111	Target greater than scale capacity
	112	Spill less than negative scale capacity
	113	Spill greater than target
	114	Feed amount less than zero
	115	Feed amount greater than capacity
	116	Fast feed amount less than zero
	117	Fast feed amount greater than capacity
	118	Inhibit time less than zero
	119	Inhibit time greater than maximum value
Automatic refill	131	Refill upper limit greater than scale capacity
Automatic tare	141	Auto tare mode selection invalid
	142	Auto tare upper limit less than negative scale capacity
	143	Auto tare upper limit greater than scale capacity
	144	Auto tare lower limit greater than auto tare upper limit

Category	Code	Parameter
	145	Auto tare lower limit less than negative scale capacity
	146	Auto tare and power-up tare both enabled
Tolerance check	151	Stability timeout less than zero
	152	Stability timeout maximum value exceeded
	153	Upper limit less than zero
	154	Upper limit greater than capacity
	155	Upper limit greater than target
	156	Lower limit greater than zero
	157	Lower limit less than negative scale capacity
	158	Lower limit less than negative target value
Dump complete	161	Mode invalid
	162	Heel weight less than zero
	163	Heel weight greater than scale capacity
	164	Complete time less than zero
	165	Complete time maximum value exceeded
Spill Optimization	171	Mode configuration invalid
	172	Adjust period below lower limit
	173	Adjust period maximum value exceeded
	174	Adjust factor below lower limit
	175	Adjust factor maximum value exceeded
	176	Adjust range less than zero
	177	Adjust range greater than capacity
	178	Adjust mode invalid
Cut-off optimization	181	Robustness setting out of range
	182	Adjust period out of range
	183	Adjust factor below lower limit
	184	Adjust factor exceeds upper limit
Events and Alarms	191	Refill timeout less than zero
	192	Refill timeout exceeds upper limit
	193	Initial feed timeout less than zero
	194	Initial feed timeout exceeds upper limit
	195	Dump timeout less than zero
	196	Dump timeout exceeds upper limit
	197	Process timeout less than zero
	198	Process timeout exceeds upper limit
Jog Function	201	Jog mode configuration invalid
	202	Pulse duration below lower limit
	203	Pulse duration maximum value exceeded

Category	Code	Parameter
	204	Pause duration below lower limit
	205	Pause duration maximum value exceeded
	206	Max cycles below lower limit
	207	Max cycles maximum value exceeded
Fast Resume	221	Factor less than minimum
	222	Factor greater than maximum
	223	Fast feed less than minimum
	224	Fast feed greater than maximum
	225	Fast feed time less than minimum
	226	Fast feed time greater than maximum
	227	Mode invalid
Target Table	241	Target table function switch invalid
	242	Activated group index invalid
	243	Activated group file invalid
Legacy (Absolute) Work Mode	251	Dump function switch invalid
	252	Refill function switch invalid
	253	Tolerance check function switch invalid
Parameter logic errors (combination of parameters is incorrect)	301	Feed plus spill greater than target
	303	Automatic refill lower limit greater than upper limit
	304	Automatic refill lower limit less than target
Miscellaneous	501	Stabilization time less than minimum
	502	Stabilization time greater than maximum
	503	OK to feed invalid

4.12. Parameter ID List

Parameter ID	Parameter Name
General	
V10371	Startup Delay
System setup	
V10901	Work mode
V10902	Feed speeds
V10904	Output type
Target Value	
V10701	Target
V10702	Spill
V10703	Feed
V10704	Fast Feed
V10721	Inhibit time
Auto Tare	
V10911	Auto Tare
V10709	Container Tare Max
V10710	Container Tare Min
Refill	
V10711	Upper limit
V10712	Lower limit
Cutoff optimization	
V10912	Mode
V10908	Robustness
V10822	Adjust period
V10728	Adjust factor
Tolerance check	
V10724	Stability timeout
V10706	+Tolerance
V10707	-Tolerance
Jog	
V10915	Mode
V10735	Pulse Duration
V10736	Pause Duration
V10824	Max Cycles

Parameter ID	Parameter Name
Dump complete	
V10905	Complete mode
V10705	Heel weight
V10725	Complete time
Spill Optimization	
V10914	Mode
V10729	Adjust range
V10913	Adjust samples
V10730	Adjust factor
Events and alarms	
V10732	Refill Timeout
V10733	Initial Feed Timeout
V10734	Dump Timeout
V10731	Process Timeout
Statistics	
[Not logged]	Clear statistics
Discrete input	
V11201	Input 1
V11202	Input 2
V11203	Input 3
V11204	Input 4
V11205	Input 5
Discrete output	
V11301	Output 1
V11302	Output 2
V11303	Output 3
V11304	Output 4
V11305	Output 5
V11306	Output 6
V11307	Output 7
V11308	Output 8

5 Configuration

This chapter provides information on configuring the Fill/Dose application. It describes access to the setup mode, where functions can be enabled, disabled, or defined by entering parameter values in a specific setup screen. All configuration is performed while the device is in Idle state – i.e. while the application is not running.

5.1. Configuration Interface Access

5.1.1. Web Interface

It is strongly recommended that the indicator's parameters be configured through the web interface. The IND360 web interface is intuitive and easy to use. It requires less time and effort to set up the indicator than using the keypad on the indicator front panel.

- If the IND360 indicator is a DIN rail-mount version, the Fill/Dose application **must** be configured using the web interface. The application settings are not available on the OLED display.

Refer to Section 3.1 of the **IND360base Indicator and Transmitter User's Guide** to log on to the web interface. The default IP address is 192.168.0.8. The Fill/Dose configuration page of the web interface is shown below:

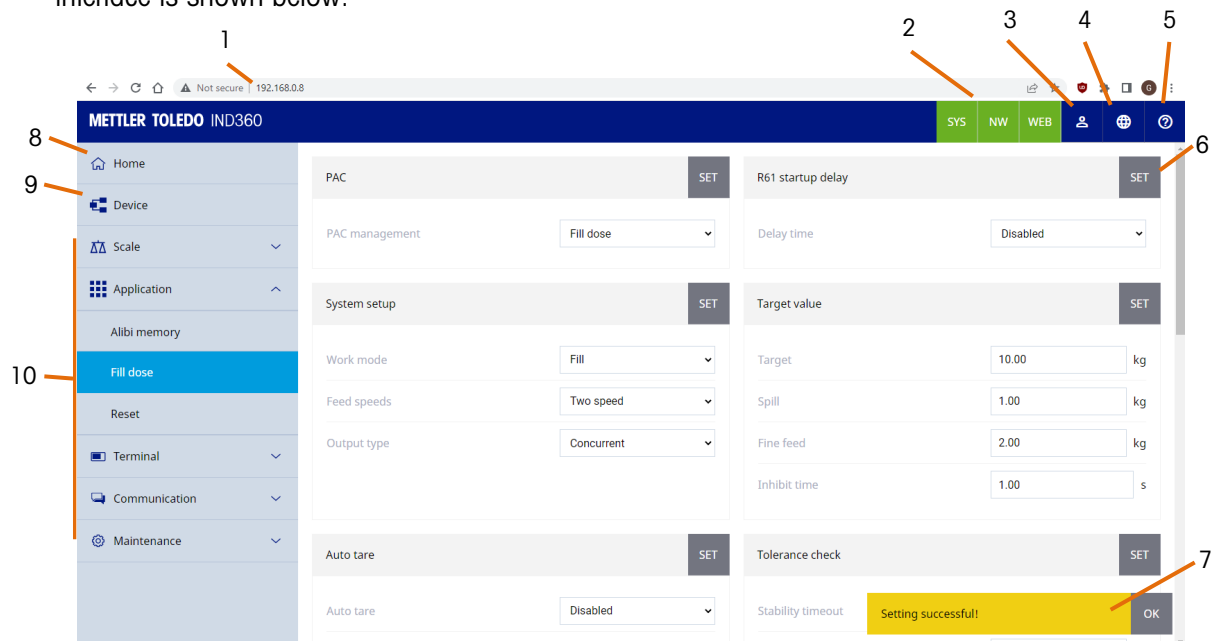



Figure 5-1: Elements of the Web Interface

1	IP address	Service IP address of the IND360 indicator.
2	Status indicators	Status information concerning System , Network and Web Access . Refer to Section 4.12.1.1 Diagnostic LEDs in the IND360base Indicator and Transmitter User's Guide for more information on their indication pattern and explanations.
3	Users	Switch to user management to setup password protection.
4	Language	Select language, available languages include English [default], Chinese, German, French, Spanish and Italian.
5	Help	Navigate to the help page.
6	Set button	Press the Set button after any parameter change.
7	Message	Appears after pressing the set button. Press OK to close.
8	Home	Shows the weight and filling information and the status of discrete inputs and outputs.
9	Device	Shows read-only information for load cells, PLC / DCS communication and the IND360 service network configuration.
10	Setup Menu	Menu used to navigate configuration screens.



5.1.2. Display

To enter or exit the setup menu using the front panel keypad of the panel and harsh versions, follow the instructions below.

5.1.2.1. Enter Setup Menu

1. Long press the ePrint/Setup key . The login screen will display:
 - a. If the indicator is password protected, enter the login information.
 - b. Otherwise, simply press Enter key  twice.

5.1.2.2. Exit Setup Menu

1. Press the Zero key  several times (leaving all submenus) until the screen displays "Save all Settings before exiting?"
2. Select **YES** to accept all setting changes; select **NO** to discard all setting changes; select **Cancel** to stay in the setup mode.
3. Press the Enter key  to confirm.

5.1.2.3. Fill/Dose Application Setup Menu Tree

Table 5-1 gives an overview of the parameters and options available in the Application setup menus. Further details are provided in section 5.2. Default parameter values are given in **bold** with an asterisk (*).

Table 5-1: Fill/Dose Application Setup Menu Tree Overview

Levels					
1	2	3	4	Options	Dependency on Other Setting
Application	PAC	PAC Management		Fill dose	None
		General	Startup Delay	Disabled* , 5 minutes, 15 minutes, 30 minutes	None
			Power Outage Recovery State	Idle* , Pause	None
		System setup	Work mode	Dose, Fill Dump, Refill Dose, Absolute(legacy), Fill*	None
			Feed speeds	One Speed, Two-speed*	None
			Output type	Concurrent* , Independent	None
		Target value	Target	[Numeric entry]	None
			Spill	[Numeric entry]	None
			Feed	[Numeric entry]	Two-speed
			Feed Inhibit time (s)	1.00*	None
			Fast Feed Inhibit Time	[Numeric entry]	Two -Speed
		Auto Tare	Auto tare	Enabled, Disabled*	Fill/dump or Fill only
			Container Tare Max	[Numeric entry]	Auto tare enabled
			Container Tare Min	[Numeric entry]	Auto tare enabled
		Tolerance check	Delay Before Check	[Numeric entry]	None
			Stability Timeout	[Numeric entry]	None
			+Tolerance (kg)	[Numeric entry]	None
			-Tolerance (kg)	[Numeric entry]	None
		Spill optimization	Mode	Disabled* , Automatic, Manual	None
			Adjust samples	[Numeric entry]	Manual optimization
			Adjust factor	[Numeric entry]	Manual optimization
			Adjust range	[Numeric entry]	Manual optimization
		Cut-off optimization	Mode	Disabled* , Automatic, Manual	None
			Robustness	[Numeric entry]	Manual optimization
			Adjust period	[Numeric entry]	Manual optimization
			Adjust factor	[Numeric entry]	Manual optimization
		Cycle Result Confirmation	Result Confirmation	Disabled* , Every Cycle, Out of Tolerance	None
		Fast Resume on Pause	Mode	Automatic* , Static, Disabled	None
		Jog	Mode	Disabled* , Automatic, Single Pulse, Manual	None
			Pulse Duration	[Numeric entry]	Jog automatic or Single Pulse
			Pause Duration	[Numeric entry]	Jog automatic

Levels					
1	2	3	4	Options	Dependency on Other Setting
			Max Cycles	[Numeric entry]	Jog automatic
		Refill	Upper Limit	[Numeric entry]	Refill/Dose Only
			Lower Limit	[Numeric entry]	Refill/Dose Only
		Dump Complete	Complete Mode	Heel Weight* , Complete Time	Fill/Dump only
			Heel Weight	[Numeric entry]	Heel Weight Complete Mode
			Complete Time	[Numeric entry]	Complete Time Complete Mode
		Advanced	Interlock	Disabled* , Enabled	None
		Events and alarms	Initial Feed Timeout	[Numeric entry]	
			Dump Timeout	[Numeric entry]	Fill/Dump only
			Refill Timeout	[Numeric entry]	Refill/Dose Only
			Process timeout(s)	[Numeric entry]	
		Statistics	Clear statistics	Reset	None
		Discrete inputs	Input 1	None* , Start, Pause, Abort, Stop, Reset, Clear Statistics, Tare, Zero, Clear tare, Stop/Reset, Abort/Reset, Interlock	Input selections limited by work mode selection
			Input 2		
			Input 3		
			Input 4		
			Input 5		
		Discrete outputs	Output 1	None* , Fast Feed, Feed, Spill, Run, Complete, Dump, Refill, Pause, Over +tol, Under – Tol, In tolerance, Smart5 Orange, Smart5 Red, Application alarm, Center of zero, Over capacity, Under Zero, Motion, Net, Remote, Stopped, Confirm	Output selections limited by work mode selection
			Output 2		
			Output 3		
			Output 4		
			Output 5		
			Output 6		
			Output 7		
			Output 8		
		Filling Target Presets	Preset Storage	Disabled* , Enabled	None
			Preset 1-10	Product Name;Save;Load	Preset Storage

5.2. Application Configuration

Parameters related to the Fill/Dose application are found under the **Application** menu; after entering the **Setup** screen, navigate to Application using the Clear key .

5.2.1. PAC Management

In the **Application > PAC Management** menu, Fill/Dose is selected and enabled by default.

Fill dose [default]	This option is selected by default.
Disable	This option disables the Fill/Dose application and turns the indicator into an IND360base.

5.2.2. General

5.2.2.1. Startup Delay

The fill/dose application features an optional **Startup delay** setting. During this delay time, normal operation of the indicator is suspended (except for setup access), enforcing the scale warm-up time sometimes demanded by regulations. It is strongly recommended to leave Startup Delay **disabled** unless required for legal for trade approval.

Disabled [default]	Recommended setting. Operation of the indicator will not be delayed after the indicator is powered on.
Enabled	Operation of the indicator will be prohibited (except for setup access) for 5, 15 or 30 minutes after the indicator is powered on.

5.2.2.2. Power Outage Recovery State

Select what happens if a power outage occurs in the middle of a fill or dose cycle. Choose whether the application should be paused or idle once recovered from the power outage.

Idle [default]	When power returns, application will be in idle state. This means a new cycle can start, but the previous cycle cannot be resumed. If any material remains in the container from the previous cycle, additional steps may need to be taken to empty container before beginning a new cycle.
Pause	When power returns, application will be in paused state. This means the cycle that was running during the power outage can potentially be resumed. If it is not desired to resume the cycle after the power outage, the Stop or Abort commands should be used.

5.2.3. System Setup

5.2.3.1. Work Mode

In the **Application > Work** mode menu, select the working mode appropriate to the system setup. Choices include:

Fill Dump	Select this option if the system is used for a fill and dump application.
-----------	---

- Refill Dose Select this option if the system is used for a dose application that includes automatic refill.
- Fill** [default] Select this option if the system is used for a fill application.
- Dose Select this option if the system is used for a dose application.
- Absolute (legacy) Select this option if wanting to measure the absolute value of the change in weight. Can be used for both gain-in-weight and loss-in-weight

5.2.3.2. Feed Speeds

Feed Speeds sets the number of speeds to control the material output. Options include:

- One Speed Select this option if the system feeds material in one speed (Feed).
- Two-Speed** [default] Select this option if the system feeds material in two speeds (Feed and Fast Feed).

5.2.3.3. Output Type

Output Type determines whether the feeders will be turned on simultaneously or separately. Options include:

- Concurrent** [default] The feeders will be turned on simultaneously.
- Independent The feeders will be turned on separately, one at a time, Fast Feed, then Feed.

5.2.4. Target Value

5.2.4.1. Target

This is the fill/dosing target weight. Target must be less than scale capacity.

5.2.4.2. Spill

Spill sets the amount of material which will be dispensed after all feeds are turned off.

- Spill 0 ... **1.0** [default] ... scale capacity

5.2.4.3. Feed

Feed sets the weight of material that will be fed in at a "slow" speed rate. When output type is set to **Independent**, the Feed output will be active when

$$(target - feed - spill) < current\ weight < (target - spill)$$

When output type is set to **Concurrent**, the Feed output will turn on as soon as the application is running until

$$current\ weight < (target - spill)$$

5.2.4.4. Feed Inhibit Time(s)

Feed Inhibit Time sets the amount of time that the comparator must wait before it is allowed to resume comparing weight to target value when in feed mode. This avoids invalid comparative values by allowing the Fill/Dose system to settle after a change in state of a valve, pump, mixer, or other physical equipment.

Feed Inhibit Time 0 s ... **1.00 s** [default] ... 9.99 s

5.2.4.5. Fast Feed Inhibit Time

Fast Feed Inhibit Time sets the amount of time that the comparator must wait before it is allowed to resume comparing weight to target value when in fast feed mode. This avoids invalid comparative values by allowing the Fill/Dose system to settle after a change in state of a valve, pump, mixer, or other physical equipment.

Feed Inhibit Time 0 s ... **1.00 s** [default] ... 9.99 s

5.2.5. Auto Tare (Filling only)

The **Auto Tare** menu is only shown when Fill-Dump or Fill is selected as the working mode.

5.2.5.1. Auto Tare

Disabled [default] Automatic Tare does not occur at start of process.

Enabled Automatic Tare occurs once process begins if the current weight is between the container tare max and min values

5.2.5.1.1. Container Tare Max

Maximum weight value for an auto tare to execute. If weight value is above Container Tare Max at the beginning of the process, the process will pause, and the system will generate a SMART5™ yellow alarm.

5.2.5.1.2. Container Tare Min

This is the minimum weight value at which auto tare will execute. If the weight value is below Container Tare Min at the beginning of the process, the process will pause, and the system will generate an alarm.

5.2.6. Refill (for Refill/Dose only)

5.2.6.1. Upper Limit (for Refill/Dose only)

Defines the upper limit for the automatic refill to stop. The refill signal will stay high until the upper limit is reached.

5.2.6.2. Lower Limit (for Refill/Dose only)

If a Dose is started and the material in the tank weighs less than **Lower Limit**, the refill signal will be triggered and stay high until the weight of material in the tank reaches the **Upper Limit**.

5.2.7. Tolerance Check

The tolerance configuration is executed as follows:

$$\text{Target} - [-\text{Tolerance}] \leq \text{Final Weight} \leq \text{Target} + [+Tolerance]$$

5.2.7.1. Delay Before Check

Length in seconds of the delay after the cycle completes before performing the tolerance check.

5.2.7.2. Stability Timeout

Stability Timeout is the maximum length of time the program will wait for a stable weight reading after material dispensing has stopped. A value of 0 disables the timeout and will allow the IND360 to wait indefinitely until stability is achieved.

Stable Time 0 s ... **0.00 s** [default] ... 9.99 s

5.2.7.3. +Tolerance (kg)

+ Tolerance sets the maximum permissible amount above the target weight for the fill/dosing cycle to still be marked as **In Tolerance**. If the positive deviation from the target is higher, the filling result is marked as **Above Tolerance**.

+ Tolerance 0 ... **0.01** [default] ... scale capacity

5.2.7.4. -Tolerance (kg)

-Tolerance sets the minimum permissible amount below the target weight for the filling/dosing cycle still being marked as In Tolerance. If the negative deviation from the target is higher, the filling result is marked as Below Tolerance.

-Tolerance 0 ... **0.01** [default] ... scale capacity

5.2.8. Dump Complete (Fill-Dump Only)

5.2.8.1. Complete Mode (for Fill-Dump Mode Only)

Complete Mode is available for the Fill-Dump application only. It decides whether the complete signal is triggered by the heel weight or by a set time.

Heel Weight [default] The complete signal is triggered by the heel weight.

Complete Time The complete signal is triggered by a set time.

5.2.8.2. Complete Time

The **Complete Time** sets the duration of the dump process.

Complete Time 0 s ... **1.00 s** [default] ... 9.99 s

5.2.8.3. Heel Weight (for Fill-Dump Mode Only)

Heel Weight indicates the amount of material that might remain in the weigh vessel when it is considered empty – for example, material stuck to the sides of a hopper.

Heel Weight 0 ... **0.1** [default] ... scale capacity

5.2.9. Spill Optimization

The **Spill Optimization** automatically adjusts the feed cut-off point to match the actual amount of inflight material. For more details and background information please refer to section 3.4, **Automatic Optimization**, in Chapter 3, **Filling System Design**.

5.2.9.1. Mode

5.2.9.1.1. **Disabled** [default]

Spill optimization not active. The system will use the configured spill and will not adjust automatically

5.2.9.1.2. Automatic

IND360fill/dose automatically configures the internal settings for spill optimization. In the background the environment is characterized to define the optimal settings. No more configuration is needed, the parameters are just shown for reference.

5.2.9.1.3. Manual

Expert mode, only for use under special conditions. Allows the manual configuration of internal settings for spill optimization.

5.2.9.2. Adjust Range (manual mode only)

Adjust Range defines which data points are marked as outliers. The configured value defines a band around the target value; all measurements outside this band or marked as outliers (Figure 5-2). Such outliers can occur, for example, when an operator accidentally stands on the scale or touches the scale while filling is in progress.

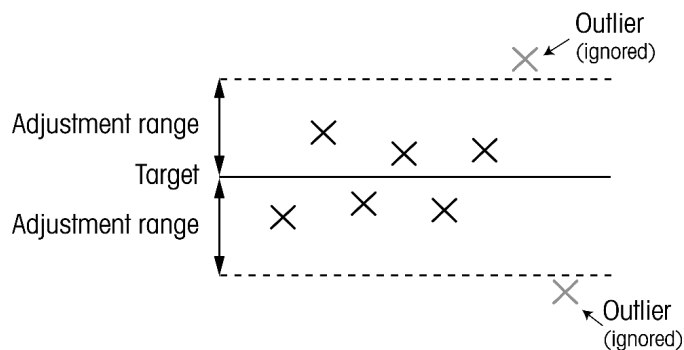

Figure 5-2: Range Adjustment

Adjust Range 0 ... **0.10 kg** [default] ... scale capacity

5.2.9.3. Adjust Samples (manual mode only)

This parameter defines how many historical data points are considered to calculate the new spill value. As more values are taken, the system will take longer to adapt to a new spill value, but fluctuations in spill are more accurately evened out.

Adjust Samples 0 ... **6** [default] ... 9

5.2.9.4. Adjust Factor (manual mode only)

The **Adjust Factor** determines how quickly the algorithm optimizes. A high value will cause the system to react more quickly to changes in spill. However, when the spill fluctuates a lot between filling cycles, a smaller Adjust Factor will produce a smoother adaptation.

Adjust Factor 0.1 ... **0.5** [default] ... 0.9

5.2.10. Cut-off Optimization

Cut-off Optimization adjusts the feed-to-feed cut-off point (i.e., it changes the feed time) and optimizes the system for maximum filling speed. This setting is only applicable in two speed filling.

5.2.10.1. Mode

5.2.10.1.1. **Disabled** [default]

Cut-off optimization not active. The system will use the configured spill and will not adjust automatically.

5.2.10.1.2. Automatic

IND360fill/dose will configure the internal settings for cut-off optimization automatically. In the background the environment is characterized to define the optimal settings. No more configuration is needed, and parameters are shown only for reference.

5.2.10.1.3. Manual

Expert mode, for use only under special conditions. Allows the manual configuration of **Cut-off Optimization** internal settings.

5.2.10.2. Robustness (manual mode only)

Robustness influences how resilient the optimized system will be against external disturbances and variations in the system. The lower this value, the more aggressively the algorithm optimizes for speed and the less margin there is to compensate for other influences. A high value causes the algorithm to optimize less, but leaves more buffer for variations.

Robustness 3.0 ... **5.0** [default] ... 10.0

5.2.10.3. Adjust Period (manual mode only)

This parameter defines how many historical data points are considered when calculating the new cut-off points. As more values are taken, the system will take longer to adapt, but fluctuations in the environment will be evened out more accurately.

Adjust Period 6 ... **8** [default] ... 15

5.2.10.4. Adjust Factor (manual mode only)

The **Adjust Factor** determines how quickly the algorithm optimizes. A high value will cause the system to adapt in bigger steps. However, quicker adaption may lead to inaccurate filling results.

Adjust Factor 0.1 ... **0.4** [default] ... 0.9

5.2.11. Jog Function Setup

The following sections describe the parameters used when the IND360 enters its jog state, indicating which parameters are used for each type of sequence. Default values are indicated with an asterisk in **bold***.

5.2.11.1. Pulse Duration

Pulse Duration sets the duration of the jog pulse, and thus the quantity of material delivered per jog. Because the jog cycle will be required only rarely, it is best to set this value quite low so that the system feeds small incremental amounts, ensuring an accurate fill.

Pulse Duration **0.1 seconds*** [default]

5.2.11.2. Pause Duration

This value sets the system's wait time between executing two consecutive pulses. The pause allows the weighing system to settle, preventing spurious weight readings from occurring during the post-pulse tolerance check.

Pause duration **0 seconds*** [default]
0 to 99.99 seconds
A value of 0 means that there will be no pause between the cycle check and tolerance check after each jog.

5.2.11.3. Maximum number of Jog Cycles

This parameter sets the maximum number of jogs permissible in each automatic jog cycle.

This constraint ensures that the system will not continue pulsing when there is no further material to feed, or when no material is being delivered due to some other condition. This can prevent damage to equipment.

Maximum number of Jog Cycles **3 cycles*** [default]
0 to 99 cycles
A value of 0 means that the system will continue jogging until reaching the target or interrupted by the stop signal.

5.2.12. Cycle Result Confirmation

This parameter establishes how often the operator must confirm the cycle result. A digital output can be configured to confirm the cycle result.

Disabled* [default]	No confirmation is required after the cycle
Every cycle	Confirmation is required after every cycle
Out of Tolerance	Confirmation is only required when result is out of tolerance

5.2.13. Fast Resume on Pause

When the application pauses or transitions to the error state in the middle of the cycle, it is possible to select at what speed the application uses when returning to the running state.

For example, if filling using two speeds and the process is paused while still utilizing the fast feed, disabling Fast Resume on Pause means the application will use the slower feed signal when returning to the running state. This can cause a much slower filling cycle. If the automatic setting is used instead, the application will return to the running state using the fast feed signal when reasonable (e.g. if cycle resumes just before transition to slower feed signal, fast feed will not be turned on). If the Static setting is used, the operator can set up to what weight value fast feed can be used when resuming from pause.

Disabled* [default]	When resuming from pause, application will always use slower feed signal for rest of the cycle
Automatic	When resuming from pause, application will use the fast feed when reasonable
Static	When resuming from pause, application will use the fast feed until the cutoff parameter from the operator is reached

5.2.14. Advanced

It is possible to incorporate a safety interlock into the system. This might be a light barrier to make sure people are away from the machine when a cycle is running. It is possible to configure a digital input to be the safety interlock.

- The interlock signal is a level signal as opposed to an edge triggered signal. The interlock input must be at a logic-high level in order for a fill or dose cycle to run.

Disabled* [default]	No safety interlock will be used
Enabled	Safety interlock will be used in process

5.2.15. Events and Alarms

5.2.15.1. Initial Feed Timeout

The **Initial Feed Timeout** determines the time allowed from when the process begins until the weight value begins to change. If the weight does not begin to change before the timeout ends, the system generates an alarm and transitions to the error state (e.g. due to actuator not reacting).

Initial Feed Timeout 0 s ... 10 s [default] ... 99.99 s

5.2.15.2. Dump Timeout (Fill-Dump Only)

The **Dump Timeout** determines the maximum acceptable amount of time for the dump to complete. If the dump exceeds Dump Timeout, the system generates an alarm and transitions to the error state.

Dump Timeout 0 ... **10** [default] ... 99.99 s

5.2.15.3. Refill Timeout (Refill/Dose Only)

The **Refill Timeout** determines the maximum acceptable amount of time for the refill to complete. If the refill exceeds Refill Timeout, the system generates an alarm and transitions to the error state.

Refill Timeout 0 ... **10** [default] ... 99.99 s

5.2.15.4. Process Timeout

The **Process Timeout** determines the time allowed for a weigh-in or weigh-out cycle. If a weigh-in or weigh-out cycle is still going on when the process timeout ends, the system generates an alarm and transitions to the error state.

Process Timeout 0 s ... 30 s [default] ... 99,999,999 s

5.2.16. Statistics

5.2.16.1. Clear Statistics

Clear Statistics clears all application statistical data.

Enabled	Clear all application statistics. Setting will change to Disabled automatically once the statistics have been cleared.
Disabled [default]	Abort the clearing process.

5.2.17. Discrete Inputs

The IND360 indicator with the Fill/Dose application enabled provides three or five discrete inputs. The following functions may be assigned to a discrete input:

Start	Pause	Stop	Reset	Clear Statistics	Tare
Zero	Clear Tare	Jog	Jog complete	None	Abort
Stop/Reset	Abort/Reset	Interlock			

5.2.18. Discrete Outputs

The IND360 indicator with Fill/Dose application enabled provides four or eight discrete outputs, depending on the installed options. The following functions can be assigned to a discrete output:

Fast Feed	Feed	Spill
Complete	Refill	Dump
Run	Pause	Over +Tolerance

Under -Tolerance	In Tolerance	Application Alarm
Smart5™ Red	Smart5™ Orange	Center of Zero
Over Capacity	Under Zero	Motion
Net	Jog	None
Remote	Confirm	Stopped

- Multiple outputs can be assigned to the same function.

5.2.19. Reset

Reset restores all application settings to their default values. The default work mode is **Fill**. Reset also clears application statistics.

- Yes Reset the application configuration.
- No* Do not reset the application configuration.

After a reset, a status message “Reset Successful” or “Reset Failed” will be shown, indicating the status of the reset. In case the reset operation fails, please execute a master reset (refer to section A.4.1, **Main PCB Switches** in the **IND360base Indicator and Transmitter Users Guide**). Press the ePrint/Setup key to clear the message and return to the Reset menu branch.

5.3. Filter Settings

Filter settings for IND360 can be found in setup at **Scale > Filter and Stability**. The filter settings heavily influence the performance of the system. The correct setting depends on the environment and system setup.

5.3.1. General Recommendations

A good point to start with is 10 Hz. If the system is very stable and there is no low frequency noise, a higher value can be set to improve the system reaction time further. In case of issues with unstable weight, step by step decrease the limit frequency until the right balance of stable weight and low latency has been found.

METTLER TOLEDO does not recommend setting the low pass filter lower than 2 Hz because it starts filtering out the actual weight transition at these lower frequencies, causing significant delays called latency. The system will miss the right moment to close the valve because the change in weight has been filtered out to the point that the weight is correct but it was too late to close the valve at the right time.

6 Communication Protocol

6.1. PLC Sample Code

PLC sample code demonstrating the IND360fill/dose application is available for download at www.mt.com/ind-ind360-downloads. Packages are available for Siemens TIA Portal and Rockwell Studio 5000, and each includes an Engineering Note.

6.2. Parameter Verification

The IND360fill/dose application checks the parameters once the application is started. To help find configuration issues, the application offers two status bits to the PLC/DCS.

Parameter Invalid	The parameter is set to an invalid value Example: Lower limit = -1
Parameter Logic	The parameter setting conflicts with the configuration of related parameters Example: Lower limit > Upper Limit

The IND360 performs the same checks when entering the configuration through the web interface or display. In this case, feedback to the operator is provided immediately.

6.3. Getting Started

IND360 offers a comprehensive set of data points to configure, control and monitor the filling process. Given that (part of) the configuration is done directly on the device, the following data points are among the most relevant ones:

Operation	Data Point
Setting target and tolerances	Target, +Tolerance, -Tolerance
Start/Stop filling process and monitor device operation	Control Command Status block command 12
Read amount of material filled	Filling Dosing Weight (Net delivered)

6.4. Modbus RTU/TCP Protocol

Table 6-1: Modbus RTU/TCP Protocol

Parameter	Option/Range	MODBUS Address	Read/Write	Data Type
Work Mode	0 – Fill Dump 1 – Refill Dose 2 – Fill 3 - Dose 4 - Absolute (Legacy)	43001	R/W	Float 32
Feed Speeds	0 - One Speed; 1 - Two-Speed	43002	R/W	Float 32
Output Type	0 - Concurrent; 1 - Independent	43003	R/W	Float 32
Complete Mode	0 - Weight Mode; 1 - Time Mode	43004	R/W	Float 32
Clear Statistics	0 - Disable; 1 - Enable	43006	W	Float 32
Auto Tare	0-Disable 1-Enable	43007	RW	Short
Target	[0~Capacity]	43008	R/W	Float 32
Spill	[-Capacity ~Capacity]	43010	R/W	Float 32
Feed	[0~Capacity]	43012	R/W	Float 32
Fast Feed	[0~Capacity]	43014	R/W	Float 32
Heel Weight	[0~Capacity]	43016	R/W	Float 32
+Tolerance	[0~Capacity]	43018	R/W	Float 32
-Tolerance	[- Capacity~+Tolerance]	43020	R/W	Float 32
Upper Limit	[0~Capacity]	43026	R/W	Float 32
Lower Limit	[Target~Upper Limit]	43028	R/W	Float 32
Container Tare Max.	[-Capacity~Capacity]	43022	R/W	Float 32
Container Tare Min.	[-Capacity~Container Tare Max]	43024	R/W	Float 32
Inhibit Time	[0~9.99]s	43030	R/W	Float 32
Stability Timeout	[0~9.99]s	43032	R/W	Float 32
Complete Time	[0~9.99]s	43034	R/W	Float 32
Refill Timeout	[0~99.99]s	43036	R/W	Float 32
Process Timeout	[0~99,999]s	43038	R/W	Float 32
Spill Optimization Mode	0-Disable; 1-Automatic; 2-Manual	43040	R/W	Float 32
Spill Adjust Period	[1 ~9]	43041	R/W	Float 32

Parameter	Option/Range	MODBUS Address	Read/Write	Data Type
Spill Adjust Factor	[0.1~0.9]	43042	R/W	Float 32
Spill Adjust Range	[0~Capacity]	43044	R/W	Float 32
Cut-Off Optimization Mode	0-Disable; 1-Automatic; 2-Manual	43046	RW	Short
Cut-Off Optimization Control Robustness	[3-10]	43047	RW	Short
Cutoff Optimization Period	[6~15]	43049	RW	Short
Cutoff Adjust Factor	[0.1~0.9]	43050	RW	Float 32
Filling Dosing Weight (net delivered)		43052	R	Float 32
Min. Cycle Weight		43054	R	Float 32
Max. Cycle Weight		43056	R	Float 32
Total Cycle Weight		43058	R	Float 32
Total Buckets		43060	R	Float 32
Valid Buckets		43062	R	Float 32
Control Command	0-Abort; 1-Run; 2-Pause 3-Reset 4-Jog 5-Jog Complete 6-Stop 7-Stop/Reset 8-Abort/Reset	43066	W	Float 32
Dump Timeout	[0~99.99]s	43070	R/W	Float 32
Initial Feed Timeout	[0~99.99]s	43072	R/W	Float 32
Jog mode	0. Disabled 1. Automatic 2. Single Pulse 3. Manual	43074	W	Short
Jog pulse duration	[0.01~99.99]	43075	W	Short
Jog pause duration	[0~99.99]	43077	W	Float 32
Jog max cycles	[0~99]	43079	W	Short
Inhibit Time for Fast Feed	[0~9.99]s	43081	R/W	Float 32
Delay Before Check	[0~99.9]s	43083	R/W	Float 32
Power Outage Handling Mode	0 - Idle 1 - Pause	43085	R/W	Short
Cycle Result Confirm Mode	0 - Disabled 1 - Every Cycle 2 - Under Tolerance	43087	R/W	Short

Parameter	Option/Range	MODBUS Address	Read/Write	Data Type
Target Table ID	Read: 0 - Function is disabled [1-10] Function is enabled, activated ID is selected Write: 0 - Disable the function [1-10] Enable the function and load preset using ID	43089	RW	Short

6.5. SAI Protocol

6.5.1. Cyclic Commands

Table 6-2: Cyclic Commands – Measuring Block

Parameter	Option/Range	SAI		Data Type
		Read Command	Write Command	
Work Mode	0 – Fill Dump 1 – Refill Dose 2 – Fill 3 - Dose 4 - Absolute (Legacy)	101	301	Float 32
Feed Speeds	0 - One Speed; 1 - Two-Speed	102	302	Float 32
Output Type	0 - Concurrent; 1 - Independent	103	303	Float 32
Complete Mode	0 - Weight Mode; 1 - Time Mode	104	304	Float 32
Clear Statistics	0 - Disable; 1 - Enable	N/A	306	Float 32
Auto Tare	0 – Disable 1 – Enable	107	307	Float 32
Target	[0~Capacity]	108	308	Float 32
Spill	[-Capacity~Capacity]	109	309	Float 32
Feed	[0~Capacity]	110	310	Float 32
Fast Feed	[0~Capacity]	111	311	Float 32
Heel Weight	[0~Capacity]	112	312	Float 32

Parameter	Option/Range	SAI		Data Type
		Read Command	Write Command	
+Tolerance	[0~Capacity]	113	313	Float 32
-Tolerance	[-Capacity~+Tolerance]	114	314	Float 32
Upper Limit	[0~Capacity]	115	315	Float 32
Lower Limit	[Target~Upper Limit]	116	316	Float 32
Container Tare Max.	[-Capacity~Capacity]	117	317	Float 32
Container Tare Min.	[-Capacity~Container Tare Max]	118	318	Float 32
Inhibit Time	[0~9.99]s	119	319	Float 32
Stability Timeout	[0~9.99]s	120	320	Float 32
Complete Time	[0~9.99]s	121	321	Float 32
Refill Timeout	[0~99.99]s	122	322	Float 32
Process Timeout	[0~99,999]s	123	323	Float 32
Spill Optimization Mode	0. Disabled 1. Automatic 2. Manual	124	324	Float 32
Spill Adjust Period	[1~9]	125	325	Float 32
Spill Adjust Factor	[0.1~0.9]	126	326	Float 32
Spill Adjust Range	[0~Capacity]	127	327	Float 32
Cutoff Optimization Mode	0 – Disabled 1 – Automatic 2 – Manual	128	328	Float 32
Cutoff Control Robustness	[3~10]	129	329	Float 32
Cutoff Learning Period	[6~15]	130	330	Float 32
Cutoff Adjust Factor	[0.1~0.9]	131	331	Float 32
Filling Dosing Weight (net delivered)		132	N/A	Float 32
Min. Cycle Weight		133	N/A	Float 32
Max. Cycle Weight		134	N/A	Float 32
Total Cycle Weight		135	N/A	Float 32
Total Buckets		136	N/A	Float 32
Valid Buckets		137	N/A	Float 32

Parameter	Option/Range	SAI		Data Type
		Read Command	Write Command	
Control Command	0 - Abort; 1 - Run; 2 - Pause 3 - Reset 4 - Jog 5 - Jog Complete 6 - Stop 7 - Stop/Reset 8 - Abort/Reset	N/A	338	Float 32
Dump Timeout	[0~99.99]s	140	340	Float 32
Initial Feed Timeout	[0~99.99]s	141	341	Float 32
Jog Mode	0 - Disabled 1 - Automatic 2 - Single Pulse 3 - Manual	142	342	Float 32
Jog Pulse Duration	[0.01~99.99]s	143	343	Float 32
Jog Pause Duration	[0~99.99]s	144	344	Float 32
Jog Max Cycles	[0~99] cycles	145	345	Float 32
Inhibit Time for Fast Feed	[0~9.99]s	146	346	Float 32
Delay Before Check	[0~99.9]s	147	347	Float 32
Power Outage Handling Mode	0 - Idle 1 - Pause	148	348	Float 32
Cycle Result Confirm Mode	0 - Disabled 1 - Every Cycle 2 - Under Tolerance	149	349	Float 32
Target Table ID	Read: 0 - Function is disabled [1-10] Function is enabled, activated ID is selected Write: 0 - Disable the function [1-10] Enable the function and load preset using ID	150	350	Float 32

6.5.1.1. Cyclic Commands – Status Block

Table 6-3: Cyclic Commands – Status Block

Status Command	Description		Note
0	RedAlert Alarm, Scale Group 2, I/O Group 1		Refer to the SAI Reference Guide for Transmitters for additional details
1	RedAlert Alarm, Scale Group 2, I/O Group 1		Refer to the SAI Reference Guide for Transmitters for additional details
12	Word 0	Custom group 1	Refer to Table 6-4, Table 6-5 and Table 6-6 for additional information
	Word 1	Custom group 2	
	Word 2	I/O group 1	

6.5.1.2. Custom Group 1 (for fill/dose) – Run Status

Table 6-4: Custom Group 1

Bit	Description
0	Run
1	Complete
2	Pause
3	Dump
4	Refill
5	Application Alarm
6	Feed
7	Fast Feed
8	Reserved
9	Spill
10	Refill Upper Limit
11	Refill Lower Limit
12	Over +Tolerance
13	Under -Tolerance
14	Jog
15	Reserved

6.5.1.3. Custom Group 2 (for fill/dose) – Alarm Status

Table 6-5: Custom Group 2

Bit	Description
0	Starting Weight Invalid
1	Autotare Fault

Bit	Description
2	Process Timeout
3	Initial Feed Timeout
4	Refill Timeout
5	Dump Timeout
6	Parameter Invalid
7	Parameter Logic Error
8	Not Enough Material
9	Maximum Jog Cycles Reached
10	OK to Feed Not Ready
11	Reserved
12	Reserved
13	Reserved
14	Reserved
15	Reserved

6.5.1.4. I/O Group 1

Table 6-6: I/O Group

Bit	I/O Group 1	Bit	I/O Group 1
0	Input 1	8	Output 1
1	Input 2	9	Output 2
2	Input 3	10	Output 3
3	Input 4	11	Output 4
4	Input 5	12	Output 5
5	Reserved	13	Output 6
6	Reserved	14	Output 7
7	Reserved	15	Output 8

6.6. Acyclic Commands

Table 6-7: Acyclic Commands

Parameter	Option/Range	PROFIBUS Slot	PROFIBUS Index	EIP Class Code	EIP Instance Values	EIP Attribute #	PROFINET slot + subslot	PROFINET / EtherCAT Index	CC-Link IE	Read / Write	Data Type
Work Mode	0 – Fill Dump 1 – Refill Dose 2 – Fill 3 - Dose 4 - Absolute (Legacy)	3	0xA0	0x41B	0x01	0x01	0, 1	0x10000	0x001000	R/W	Float 32
Feed Speeds	0 - One Speed; 1 - Two-Speed	3	0xA1	0x41B	0x01	0x02	0, 1	0x10002	0x001002	R/W	Float 32
Output Type	0 - Concurrent; 1 - Independent	3	0xA2	0x41B	0x01	0x03	0, 1	0x10004	0x001004	R/W	Float 32
Complete Mode	0 - Weight Mode; 1 - Time Mode	3	0xA3	0x41B	0x01	0x04	0, 1	0x10006	0x001006	R/W	Float 32
Clear Statistics	0 - Disable; 1 - Enable	3	0xA5	0x41B	0x01	0x06	0, 1	0x1000A	0x001008	R/W	Float 32
Auto Tare	0 – Disable 1 - Enable	3	0xA6	0x41B	0x01	0x07	0, 1	0x1000C	0x00100A	R/W	Float 32
Target	[0~Capacity]	3	0xA7	0x41B	0x01	0x08	0, 1	0x1000E	0x00100C	R/W	Float 32
Spill	[-Capacity~Capacity]	3	0xA8	0x41B	0x01	0x09	0, 1	0x10010	0x00100E	R/W	Float 32
Feed	[0~Capacity]	3	0xA9	0x41B	0x01	0x0A	0, 1	0x10012	0x001010	R/W	Float 32
Fast Feed	[0~Capacity]	3	0xAA	0x41B	0x01	0x0B	0, 1	0x10014	0x001030	R/W	Float 32
Heel Weight	[0~Capacity]	3	0xAB	0x41B	0x01	0x0C	0, 1	0x10016	0x001050	R/W	Float 32
+Tolerance	[0~Capacity]	3	0xAC	0x41B	0x01	0x0D	0, 1	0x10018	0x002000	R/W	Float 32
-Tolerance	[-Capacity~+Tolerance]	3	0xAD	0x41B	0x01	0x0E	0, 1	0x1001A	0x002002	R/W	Float 32
Upper Limit	[0~Capacity]	3	0xAE	0x41B	0x01	0x0F	0, 1	0x1001C	0x002003	R/W	Float 32
Lower Limit	[Target~Upper Limit]	3	0xAF	0x41B	0x01	0x10	0, 1	0x1001E	0x002004	R/W	Float 32
Container Tare Max.	[-Capacity~Capacity]	3	0xB0	0x41B	0x01	0x11	0, 1	0x4711	0x10020	R/W	Float 32

Parameter	Option/Range	PROFIBUS Slot	PROFIBUS Index	EIP Class Code	EIP Instance Values	EIP Attribute #	PROFINET slot + subslot	PROFINET / EtherCAT Index	CC-Link IE	Read / Write	Data Type
Container Tare Min.	[-Capacity~Container Tare Max]	3	0xB1	0x41B	0x01	0x12	0, 1	0x4712	0x10022	R/W	Float 32
Inhibit Time	[0~9.99]s	3	0xB2	0x41B	0x01	0x13	0, 1	0x4713	0x10024	R/W	Float 32
Stability Timeout	[0~9.99]s	3	0xB3	0x41B	0x01	0x14	0, 1	0x4714	0x10026	R/W	Float 32
Complete Time	[0~9.99]s	3	0xB4	0x41B	0x01	0x15	0, 1	0x4715	0x10028	R/W	Float 32
Refill Timeout	[0~99.99]s	3	0xB5	0x41B	0x01	0x16	0, 1	0x4716	0x1002A	R/W	Float 32
Process Timeout	[0~99,999]s	3	0xB6	0x41B	0x01	0x17	0, 1	0x4717	0x1002C	R/W	Float 32
Spill Optimization Mode	0. Disabled 1. Automatic 2. Manual	3	0xB7	0x41B	0x01	0x18	0, 1	0x4718	0x1002E	R/W	Float 32
Spill Adjust Period	[1~9]	3	0xB8	0x41B	0x01	0x19	0, 1	0x4719	0x10030	R/W	Float 32
Spill Adjust Factor	[0.1~0.9]	3	0xB9	0x41B	0x01	0x1A	0, 1	0x471A	0x10032	R/W	Float 32
Spill Adjust Range	[0~Capacity]	3	0xBA	0x41B	0x01	0x1B	0, 1	0x471B	0x10034	R/W	Float 32
Cutoff Optimization Mode	0 – Disable 1 – Automatic 2 – Manual	3	0xBB	0x41B	0x01	0x1C	0, 1	0x471C	0x10036	R/W	Float 32
Cutoff Control Robustness	[3~10]	3	0xBC	0x41B	0x01	0x1D	0, 1	0x471D	0x10038	R/W	Float 32
Cutoff Learning Period	[6~15]	3	0xBD	0x41B	0x01	0x1E	0, 1	0x471E	0x1003A	R/W	Float 32
Cutoff Adjust Factor	[0.1~0.9]	3	0xBE	0x41B	0x01	0x1F	0, 1	0x471F	0x1003C	R/W	Float 32
Filling Dosing Weight (net delivered)		3	0xBF	0x41B	0x01	0x20	0, 1	0x4720	0x1003E	R	Float 32
Min. Cycle Weight		3	0xC0	0x41B	0x01	0x21	0, 1	0x4721	0x10040	R	Float 32
Max. Cycle Weight		3	0xC1	0x41B	0x01	0x22	0, 1	0x4722	0x10042	R	Float 32
Total Cycle Weight		3	0xC2	0x41B	0x01	0x23	0, 1	0x4723	0x10044	R	Float 32
Total Buckets		3	0xC3	0x41B	0x01	0x24	0, 1	0x4724	0x10046	R	Float 32
Valid Buckets		3	0xC4	0x41B	0x01	0x25	0, 1	0x4725	0x10048	R	Float 32

Parameter	Option/Range	PROFIBUS Slot	PROFIBUS Index	EIP Class Code	EIP Instance Values	EIP Attribute #	PROFINET slot + subslot	PROFINET / EtherCAT Index	CC-Link IE	Read / Write	Data Type
Control Command	0-Abort; 1-Run; 2-Pause 3-Reset 4-Jog 5-Jog Complete 6-Stop 7-Stop/Reset 8-Abort/Reset	3	0xC5	0x41B	0x01	0x26	0, 1	0x4726	0x1004A	W	Float 32
Dump Timeout	[0~99.99]s	3	0xC7	0x41B	0x01	0x28	0, 1	0x4728	0x1004C	R/W	Float 32
Initial Feed Timeout	[0~99.99]s	3	0xC8	0x41B	0x01	0x29	0, 1	0x4729	0x1004E	R/W	Float 32
Jog mode	0 – Disabled 1 – Automatic 2 – Single Pulse 3 - Manual	3	0xC9	0x41B	0x01	0x2A	0, 1	0x472A	0x10050	R/W	Float 32
Jog pulse duration	[0.01~99.99]s	3	0xCA	0x41B	0x01	0x2B	0, 1	0x472B	0x10052	R/W	Float 32
Jog pause duration	[0~99.99]s	3	0xCB	0x41B	0x01	0x2C	0, 1	0x472C	0x10054	R/W	Float 32
Jog max cycles	[0~99] cycles	3	0xCC	0x41B	0x01	0x2D	0, 1	0x472D	0x10056	R/W	Float 32
Inhibit Time for Fast feed	[0~9.99]s	3	0xCD	0x41B	0x01	0x2E	0, 1	0x472E	0x1005A	R/W	Float 32
Delay before check	[0~99.9]s	3	0xCE	0x41B	0x01	0x2F	0, 1	0x472F	0x1005C	R/W	Float 32
Power Outage Handling Mode	0 - Idle 1 - Pause	3	0xCF	0x41B	0x01	0x30	0, 1	0x4730	0x1005E	R/W	Short
Cycle Result Confirm Mode	0 - Disabled 1 - Every Cycle 2 - Under Tolerance	3	0xD0	0x41B	0x01	0x31	0, 1	0x4731	0x10060	R/W	Short

Parameter	Option/Range	PROFIBUS Slot	PROFIBUS Index	EIP Class Code	EIP Instance Values	EIP Attribute #	PROFINET slot + subslot	PROFINET / EtherCAT Index	CC-Link IE	Read / Write	Data Type
Target Table ID	Read: 0 - Function is disabled [1-10] - Function is enabled and activated ID is read Write: 0 - Disable Function [1-10] - Enable function and load preset using ID	3	0xD1	0x41B	0x01	0x32	0, 1	0x4732	0x10062	R/W	Short
Input1 Assignment	0-None	2	0x11	0x418	0x01	0x02	0, 1	0x4402	0x10058	R/W	Byte 1
Input2 Assignment	1-Tare	2	0x14	0x418	0x01	0x05	0,1	0x4405	0x009002	R/W	Byte 1
Input3 Assignment	2-Zero	2	0x17	0x418	0x01	0x08	0,1	0x4408	0x009004	R/W	Byte 1
Input4 Assignment	4-Clear Tare	3	0x21	0x418	0x01	0x42	0,1	0x4602	0x009006	R/W	Byte 1
Input5 Assignment	6-Silence Alarm 22 - Pause 23 - Clear Statistics 24 - Start 25 - Abort 26 - Reset 27 - Jog 28 - Jog Complete 29 - Stop/Reset 30 - Abort/Reset 31 - Ok to Feed 32 - Stop	3	0x24	0x418	0x01	0x45	0,1	0x4605	0x009008	R/W	Byte 1
Output1 Assignment	0-None	2	0x1D	0x418	0x01	0x0E	0,1	0x440E	0x00900A	R/W	Byte 1
Output2 Assignment	1 - Center of Zero 2 - Over Capacity 3 - Under Zero	2	0x24	0x418	0x01	0x15	0, 1	0x4415	0x009020	R/W	Byte 1
Output3 Assignment	4 - Motion	2	0x2B	0x418	0x01	0x1C	0, 1	0x441C	0x009021	R/W	Byte 1

Parameter	Option/Range	PROFIBUS Slot	PROFIBUS Index	EIP Class Code	EIP Instance Values	EIP Attribute #	PROFINET slot + subslot	PROFINET / EtherCAT Index	CC-Link IE	Read / Write	Data Type
Output4 Assignment	5 - Net 14 - Smart5 Red	2	0x32	0x418	0x01	0x23	0, 1	0x4423	0x009022	R/W	Byte 1
Output5 Assignment	15 - Smart5 Orange 21 - Fast Feed	2	0x39	0x418	0x01	0x2A	0, 1	0x442A	0x009023	R/W	Byte 1
Output6 Assignment	22 - Feed 23 - Spill	3	0x27	0x418	0x01	0x48	0,1	0x4608	0x009024	R/W	Byte 1
Output7 Assignment	24 - Complete 25 - Dump	3	0x2E	0x418	0x01	0x4F	0,1	0x460F	0x009025	R/W	Byte 1
Output8 Assignment	26 - Refill 27 - Run 28 - Pause 29 - Over +Tol 30 - Under -Tol 31 - In Tolerance 32 - App Alarm 34 - Jog 35 - Confirm 36 - Stopped 16-Remote	3	0x35	0x418	0x01	0x56	0,1	0x4616	0x009027	R/W	Byte 1

7 Frequently Asked Questions

7.1. Can the fill/dose operation be controlled using the web interface?

No, this is not possible. As an automation product, the IND360fill/dose focuses on its integration with external components such as PLC/DCS and digital I/O. The web interface is used mainly for configuration purposes and to provide status information. The ability to start and stop the operation is available using the local display.

7.2. Can application settings be modified during a filling operation?

For safety reasons, the modification of application parameters such as cut-off points, or filling targets, is prohibited while a filling operation is in progress. That is, the application must be in idle mode before parameters can be modified. This allows IND360 to perform consistency checks on the entire application configuration before the process begins again.

The PLC can modify application settings during a filling operation, but the new settings only take effect for the next cycle in the current sequence.

7.3. What factors strongly influence filling performance?

When engineering a filling machine, there are several aspects to consider:

- Ensure a solid and stable weighing environment. Avoid vibrations and deformations.
- Minimize the fluctuations in the spill value caused by
 - Avoiding non-repeatable feeding systems that have inconsistent reaction time
 - Routing the actuator close signal through slow intermediate devices (for example PLC with high cycle time that increases the system latency)
- Adjust for changing environmental conditions and changes in material properties which may occur over time
 - Leverage the IND360fill/dose optimization functionality
 - Enable the IND360s digital filtering to minimize the effects of vibration.

- Do not set the cut-off points too close together, because:
 - Each transition between feed levels causes turbulence and waves within the material and causes shocks to the filling infrastructure. If transitions (cut-off points) occur in rapid sequence, the filling infrastructure doesn't have time to restore stability, which will affect accuracy.
 - Take advantage of the integrated cut-off optimization algorithm to let the device find the optimal switching points by itself.

7.4. Can the spill value be negative?

Yes, the spill value can become negative if the device is in dosing mode and the valve is mounted at the end of a long feeding nozzle (Figure xx). When the valve closes, the in-flight material (which is not on the scale anymore) cannot leave the nozzle and the material backs up inside the nozzle. **The additional weight of the nozzle is counted as negative spill because the source material tank is gaining weight instead of losing weight.**

The amount of in-flight material inside the nozzle may vary. This leads to an inconsistent spill causing inaccurate filling results. To improve filling results, it is recommended to move the valve as close as possible to the outlet of the tank.

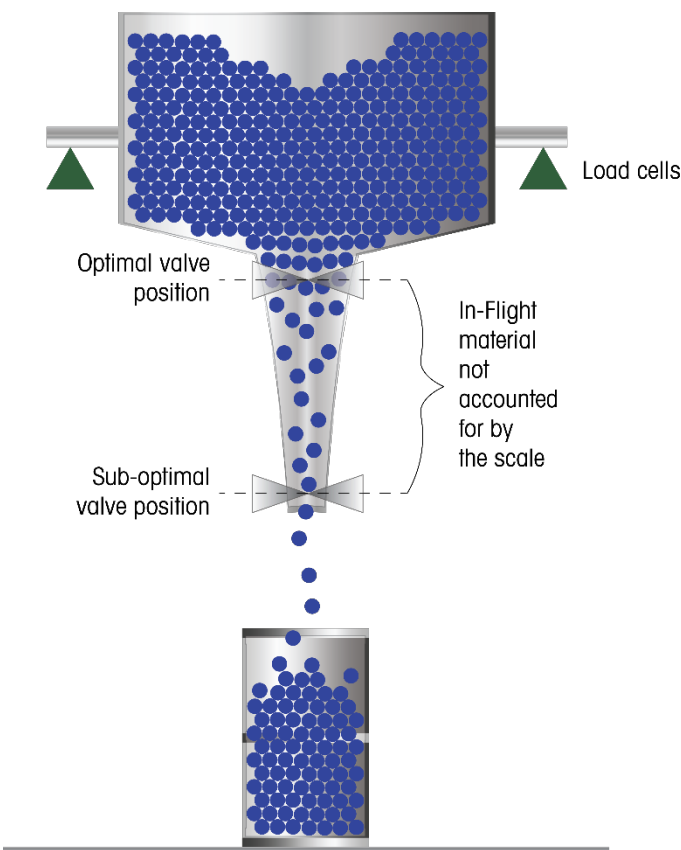

Figure 7-1: In-Flight material During Filling

7.5. Is there a difference in the results when using a POWERCELL scale, or a Precision Scale, instead of Analog (Strain Gauge)?

Naturally, an analog scale will give the best speed because it is updating a lot faster and provides more options for filter tuning. The POWERCELL and Precision scales offer higher static accuracy and more condition-monitoring features.

7.6. Why do I get an alarm every time I enable Auto Tare?

When parameters entered for IND360fill/dose are invalid (e.g. parameter values are outside of limits or multiple parameters contradict each other), a SMART5™ yellow alarm is generated. This alarm will provide an error code that can be looked up in Section 4.11 Error Codes of this document.

An error code that can be generated when auto tare is enabled is error 146. This indicates auto tare and power up tare are both enabled. To use auto tare, power up tare must be disabled in the Zero and Tare settings of IND360. The alarm will automatically clear once power up tare is disabled.

7.7. Wouldn't it be a better idea to control everything from the PLC / DCS?

Decentralized control with a purpose-dedicated device like the IND360 will deliver the fastest most repeatable results for the following reasons:

- When a PLC, or DCS reads the weight from a transmitter there is some time delay; this is called latency. Moreover, the processing algorithm also takes some time. In IND360 this combined latency is extremely low, giving customers the fastest, most repeatable fills. Some PLC manufacturers offer plug-in modules claiming high speed; however, the internal buses of the PLCs are not fast enough for many filling applications.
- The PLC, or DCS will have other tasks that borrow valuable time from the filling process and in many cases create inconsistent behavior when a significant job must be executed. When the process is located in the IND360 the PLC is freed of this task, while the IND360 delivers very fast fills because it is completely dedicated to filling control.
- IND360fill/dose offers ready-to-go algorithms and functionality to control and optimize the filling process, saving valuable engineering time.

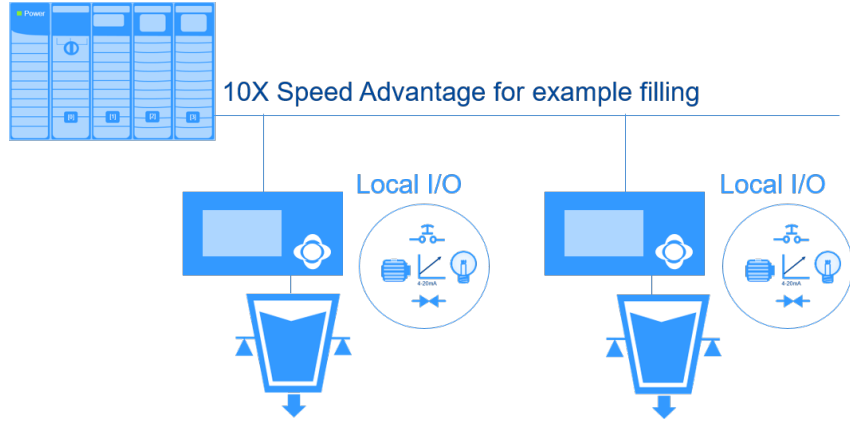

METTLER TOLEDO Service

To protect your product's future:

Congratulations on choosing the quality and precision of METTLER TOLEDO. Proper use according to these instructions and regular calibration and maintenance by our factory-trained service team ensure dependable and accurate operation, protecting your investment. Contact us about a service agreement tailored to your needs and budget.

We invite you to register your product at www.mt.com/productregistration so we can contact you about enhancements, updates and important notifications concerning your product.

www.mt.com/IND360

For more information

Mettler-Toledo, LLC
1900 Polaris Parkway
Columbus, OH 43240

© 2023 Mettler-Toledo, LLC
30777097 Rev. 01, 10/2023



30777097