

IND360

Tank Vessel Application



IND360 Terminal and Transmitter

METTLER TOLEDO Service

Essential Services for Dependable Performance of Your IND360 Terminal and Transmitter

Congratulations on choosing the quality and precision of METTLER TOLEDO. Proper use of your new equipment according to this Manual and regular calibration and maintenance by our factory-trained service team ensures dependable and accurate operation, protecting your investment. Contact us about a service agreement tailored to your needs and budget. Further information is available at www.mt.com/service.

There are several important ways to ensure you maximize the performance of your investment:

1. **Register your product:** We invite you to register your product at www.mt.com/productregistration so we can contact you about enhancements, updates and important notifications concerning your product.
2. **Contact METTLER TOLEDO for service:** The value of a measurement is proportional to its accuracy – an out of specification scale can diminish quality, reduce profits and increase liability. Timely service from METTLER TOLEDO will ensure accuracy and optimize uptime and equipment life.
 - a. **Installation, Configuration, Integration and Training:** Our service representatives are factory-trained, weighing equipment experts. We make certain that your weighing equipment is ready for production in a cost effective and timely fashion and that personnel are trained for success.
 - b. **Initial Calibration Documentation:** The installation environment and application requirements are unique for every industrial scale so performance must be tested and certified. Our calibration services and certificates document accuracy to ensure production quality and provide a quality system record of performance.
 - c. **Periodic Calibration Maintenance:** A Calibration Service Agreement provides on-going confidence in your weighing process and documentation of compliance with requirements. We offer a variety of service plans that are scheduled to meet your needs and designed to fit your budget.
 - d. **GWP® Verification:** A risk-based approach for managing weighing equipment allows for control and improvement of the entire measuring process, which ensures reproducible product quality and minimizes process costs. GWP (Good Weighing Practice), the science-based standard for efficient life-cycle management of weighing equipment, gives clear answers about how to specify, calibrate and ensure accuracy of weighing equipment, independent of make or brand.

© METTLER TOLEDO 2023

No part of this manual may be reproduced or transmitted in any form or by any means, electronic or mechanical, including photocopying and recording, for any purpose without the express written permission of METTLER TOLEDO.

U.S. Government Restricted Rights: This documentation is furnished with Restricted Rights.

Copyright 2023 METTLER TOLEDO. This documentation contains proprietary information of METTLER TOLEDO. It may not be copied in whole or in part without the express written consent of METTLER TOLEDO.

COPYRIGHT

METTLER TOLEDO® is a registered trademark of Mettler-Toledo, LLC. All other brand or product names are trademarks or registered trademarks of their respective companies.

METTLER TOLEDO RESERVES THE RIGHT TO MAKE REFINEMENTS OR CHANGES WITHOUT NOTICE.

FCC Notice















This device complies with Part 15 of the FCC Rules and the Radio Interference Requirements of the Canadian Department of Communications. Operation is subject to the following conditions: (1) this device may not cause harmful interference, and (2) this device must accept any interference received, including interference that may cause undesired operation.

This equipment has been tested and found to comply with the limits for a Class A digital device, pursuant to Part 15 of FCC Rules. These limits are designed to provide reasonable protection against harmful interference when the equipment is operated in a commercial environment. This equipment generates, uses, and can radiate radio frequency energy and, if not installed and used in accordance with the instruction manual, may cause harmful interference to radio communications. Operation of this equipment in a residential area is likely to cause harmful interference in which case the user will be required to correct the interference at his or her expense.

- Declaration of Conformity is available at <http://glo.mt.com/global/en/home/search/compliance.html/compliance/>.

Warnings and Cautions

- READ this manual BEFORE operating or servicing this equipment and FOLLOW these instructions carefully.
- SAVE this manual for future reference.

	 WARNING
	FOR CONTINUED PROTECTION AGAINST SHOCK HAZARD CONNECT THE TERMINAL TO PROPERLY GROUNDED OUTLET ONLY. DO NOT REMOVE THE GROUND PRONG
	 WARNING
	WHEN THIS EQUIPMENT IS INCLUDED AS A COMPONENT PART OF A SYSTEM, THE RESULTING DESIGN MUST BE REVIEWED BY QUALIFIED PERSONNEL WHO ARE FAMILAR WITH THE CONSTRUCTION AND OPERATION OF ALL COMPONENTS IN THE SYSTEM AND THE POTENTIAL HAZARDS INVOLVED. FAILURE TO OBSERVE THIS PRECAUTION COULD RESULT IN BODILY HARM AND/OR PROPERTY DAMAGE.
	 CAUTION
	THIS EQUIPMENT IS NOT INTRINSICALLY SAFE! IT MAY NOT BE USED IN AREAS THAT ARE CLASSIFIED AS POTENTIALLY EXPLOSIVE DUE TO COMBUSTIBLE OR EXPLOSIVE ENVIRONMENTS.
	 CAUTION
	ONLY THE COMPONENTS SPECIFIED ON THE IND360 DOCUMENTATION CAN BE USED IN THIS TERMINAL. ALL EQUIPMENT MUST BE INSTALLED IN ACCORDANCE WITH THE INSTALLATION INSTRUCTIONS DETAILED IN THE INSTALLATION MANUAL. INCORRECT OR SUBSTITUTE COMPONENTS AND/OR DEVIATION FROM THESE INSTRUCTIONS CAN IMPAIR THE SAFETY OF THE TERMINAL AND COULD RESULT IN BODILY HARM AND/OR PROPERTY DAMAGE.
	 CAUTION
	ONLY PERMIT QUALIFIED PERSONNEL TO SERVICE THE TERMINAL. EXERCISE CARE WHEN MAKING CHECKS, TESTS AND ADJUSTMENTS THAT MUST BE MADE WITH POWER ON. FAILING TO OBSERVE THESE PRECAUTIONS CAN RESULT IN BODILY HARM AND/OR PROPERTY DAMAGE.
	 CAUTION
	BEFORE CONNECTING/DISCONNECTING ANY INTERNAL ELECTRONIC COMPONENTS OR INTERCONNECTING WIRING BETWEEN ELECTRONIC EQUIPMENT ALWAYS REMOVE POWER AND WAIT AT LEAST THIRTY (30) SECONDS BEFORE ANY CONNECTIONS OR DISCONNECTIONS ARE MADE. FAILING TO OBSERVE THESE PRECAUTIONS CAN RESULT IN BODILY HARM AND/OR PROPERTY DAMAGE.
	 CAUTION
	THE HARSH TERMINAL MUST BE INSTALLED NEAR AN ELECTRICAL OUTLET (WITHIN THE LENGTH OF THE INTEGRAL LINE CORD) AND THE OUTLET MUST BE EASILY ACCESIBLE.
	NOTICE
	OBSERVE PRECAUTIONS FOR HANDLING ELECTROSTATIC SENSITIVE DEVICES.

Disposal of Electrical and Electronic Equipment

In conformance with the European Directive 2012/19/EC on Waste Electrical and Electronic Equipment (WEEE) this device may not be disposed of in domestic waste. This also applies to countries outside the EU, per their specific requirements.



Please dispose of this product in accordance with local regulations at the collecting point specified for electrical and electronic equipment.

If you have any questions, please contact the responsible authority or the distributor from which you purchased this device.

Should this device be passed on to other parties (for private or professional use), the content of this regulation must also be related.

Thank you for your contribution to environmental protection.

Contents





1	Introduction.....	1-1
1.1.	Enabling Tank Vessel Application.....	1-1
1.2.	Features.....	1-1
1.3.	Display and Keypad	1-2
1.4.	Further Information	1-7
2	Installation.....	2-1
2.1.	Wiring	2-2
2.2.	Tank Vessel Application Setup Checklist.....	2-4
3	Operation.....	3-1
3.1.	Operating Principle	3-1
3.2.	Typical Use Cases	3-4
3.3.	Starting and Stopping the Tank Vessel Application	3-5
3.4.	User Management	3-6
3.5.	Alibi Memory.....	3-6
3.6.	ePrint Function	3-6
3.7.	Statistics	3-7
4	Configuration	4-1
4.1.	Configuration Interface Access	4-1
4.2.	Application Configuration	4-3
4.3.	LoadAdvisor™	4-6
4.4.	Zero Settings	4-10
5	Communication Protocol	5-1
5.1.	PLC Sample Code.....	5-1
5.2.	Parameter Verification	5-1
5.3.	Modbus RTU Protocol	5-1
5.4.	PLC Protocol.....	5-2
5.5.	Acyclic Commands.....	5-5

1 Introduction

Weighing is a very accurate method for measuring tank and silo inventory. The IND360 tank vessel application offers monitoring and control functionality to avoid overfilling and unnecessary downtime by detecting the level of material in the silo or container through weight and control signals when the material is outside customer-defined limits. If material reaches critical levels, the IND360 Tank Vessel application will generate an alarm both on the digital output and via the automation network to the PLC, or DCS. The IND360 automates your process by controlling the tank refill material to ensure that it is always available for your production needs.

1.1. Enabling Tank Vessel Application

Before configuration and operation, please ensure that the application is enabled. Follow the instructions below to enable the application on the IND360 terminal:

1. Long press the ePrint/Setup key . Enter a valid username and password on the login page. If no password is set, just login by pressing the Enter key .
2. Go to **Application > PAC > PAC Management**.
3. Select "Tank Vessel" from the selection list and confirm selection by pressing the Enter key .
4. To exit the menu structure, press the Zero key  several times until the screen displays "Save all Settings before existing?"
5. Select "YES" and press the Enter key  to accept all changes. The device will restart automatically.

The application is started either through a digital input or remotely by a PLC/DCS.

1.2. Features

- High and low target/alarm level control
- Clear visibility of system status and fill level
- Refill control
- Flexible I/O assignment
- Easy configuration through web interface and 4.3" color display
- PLC / DCS interface for parametrization
- PROFINET, Profibus DP, EtherNet/IP, Modbus RTU and 4-20mA analog output
- Cyclical and Acyclical PLC / DCS communication
- Supports Analog, POWERCELL® and Precision scales
- Calfree™, Calfree+™, plus automatic PLC driven calibration of precision scales.

1.3. Display and Keypad

1.3.1. IND360 DIN Rail-Mount Version

The IND360 DIN rail-mount version includes a keypad (including four push buttons) and a 1.04 inch OLED display. The keypad is used for Zero, Tare, Clear and ePrint operations and cannot be used to edit application parameters. Application parameters can be edited through the web interface.

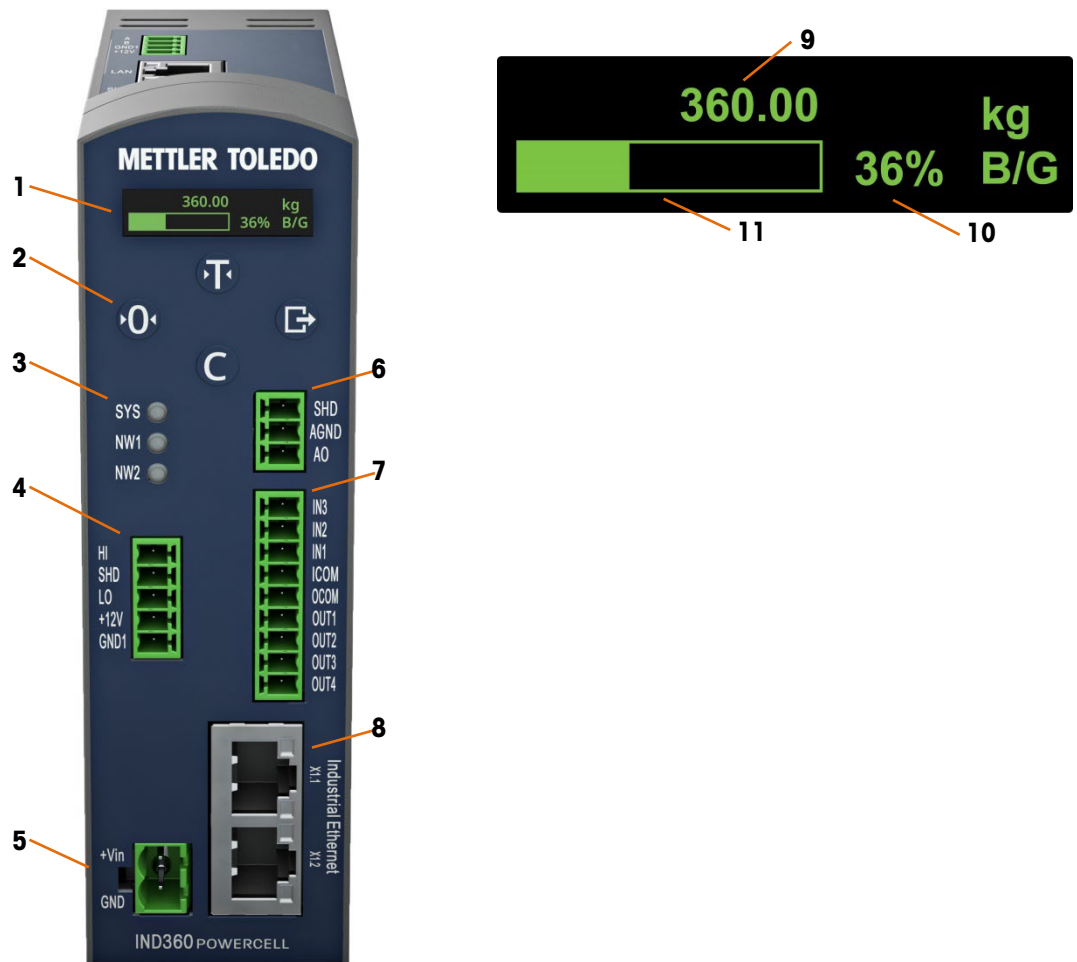





Figure 1-1: IND360 DIN Rail-Mount Version HMI for Tank Vessel Application

- | | | |
|---|----------------------------|--|
| 1 | 1.04" OLED | Displays inventory, weight value and other status information. |
| 2 | Keypad | (Refer to Figure 1-1.) |
| 3 | Status indicators | SYS indicates the operation status of the system; NW1 and NW2 indicate the status of the network. (Refer to section 4.12.1.1, Diagnostic LEDs , in the IND360 Terminal and Transmitter Technical Manual .) |
| 4 | Load cell interface | Varies depending on the actual configuration. Connectivity to Analog (strain gauge), POWERCELL or Precision weighing devices. (Refer to section A.3.6 Main Board Wiring Connections , in the IND360 Terminal and Transmitter Technical Manual for more information.) |

- | | | |
|----|--|--|
| 5 | Power input | 24VDC power input. (Refer to section A.3.5, Power Connection , in the IND360 Terminal and Transmitter Technical Manual , for more information.) |
| 6 | 4-20mA analog output | Optional 4-20mA analog output module. (Refer to section A.3.7.1, Analog Output and DIO Option , in the IND360 Terminal and Transmitter Technical Manual , for more information.) |
| 7 | Discrete I/O | Available with 3 inputs / 4 outputs or 5 inputs / 8 outputs. (Refer to sections 3.6.3.1, Discrete Input 1-5 and 3.6.3.2, Discrete Output , in the IND360 Terminal and Transmitter Technical Manual , for detailed information on assignable functions to discrete inputs and outputs in a tank vessel application.) |
| 8 | Automation Bus Connector | Varies depending on the configuration. |
| 9 | Current material level in weight | Shows the real-time material level in the weigh vessel as weight. |
| 10 | Current material level in percentage | Shows the real-time material level in the weigh vessel in percentage. The percentage progress bar will not update if the tank vessel application has not started. |
| 11 | Graphic display of current material level | Shows the real-time material level in the weigh vessel as a bar graph. |

Table 1-1: Keypad – IND360 DIN Rail-Mount Version

Key	Name	Normal Operation	Setup Menu	Numerical Values	List Selection
	Tare	Tare	Up	Increase value	Previous item up
	Zero	Zero	Back / Exit	Select left digit	Exit parameter selection
	Clear	Clear	Down	Decrease value	Next item down
	ePrint/Setup	ePrint (short press) Enter setup (long press)	Confirm selection or enter parameter selection	Select right digit	(No function)

1.3.2. IND360 Panel and Harsh Version

The IND360 Panel and Harsh version offer a 4.3" TFT color display that supports parameter configuration using the tactile push buttons. The following figure shows the Human Machine Interface (HMI) of a Panel version.



Figure 1-2: IND360 Panel-Mount Version HMI for Tank Vessel Application

1	IP address	IP address of the IND360 terminal service interface (web interface)
2	Application status	Tank/Vessel application status information (e.g. running, refilling). (Refer to Table 1-4: Application Status Icons .)
3	Softkeys	Quick access to device information, application statistics, configuration and SMART5™ alarms. (Refer to Table 1-3: Softkeys .)
4	Lower limit	Lower threshold setting. Refer to section (4.2.2.4, Lower Limit , for more information.)
5	Upper limit	Shows the higher threshold of the material level in the weigh vessel. (Refer to section 4.2.2.3, Upper Limit , for more information.)
6	Keypad	Keys for navigation and configuration. (Refer to Table 1-2: Keypad – IND360 Panel-Mount Version .)
7	Current material level in percentage	Shows the real-time material level in the weigh vessel in percentage. The percentage progress bar will not update if the Tank Vessel application is stopped.
8	Current material level in weight	Shows the real-time material level in the weigh vessel as weight value.
9	Date & time	Displays the current date and time.

Table 1-2: Keypad – IND360 Panel-Mount Version





Key	Name	Normal Operation	Setup Menu	Numerical Values	List Selection
	Tare	Tare	Up	Increase value	Previous item up
	Zero	Zero	Back / Exit	Select left digit	Exit parameter selection
	Clear	Clear	Down	Decrease value	Next item down
	ePrint/Setup	ePrint (short press) Enter setup (long press)	(No function)	Select right digit	(No function)
	Enter	Confirm selection	Enter to parameter selection / setup	Accept	Accept

Table 1-3: Softkeys















Softkey	Name	Function
	Information Recall	Shows information of the terminal: model, serial number, software version, approval, PLC type, node address, DIO type, etc.
	Application Recall Information	Shows statistical data of the application. For Tank Vessel application, statistical data include Lower Limit Counts, Upper Limit Counts, and Refill Counts.
	Shortcut	Quick access to frequently used parameters, which include Target Source, Tank Capacity, Upper Limit, Lower Limit.
	Normal Condition	Device/application is operating normally.
	Predictive Alarm	Routine test, calibration or preventative maintenance recommended.
	Out of Specification	Wrong operator action or device/application is operating out of specification.
	Imminent Failure	Wrong weight or equipment failure expected. The alarm can be reset but will reoccur every day. Please contact METTLER TOLEDO service.
	Failure	Equipment failure or incorrect weight. Clearing the alarm will not reset the condition. The device must be repaired to eliminate the alarm. Please contact METTLER TOLEDO service.

Table 1-4: Application Status Icons

Icon	Name	Function
	Run	The tank vessel application is in operation.
	Stop	The tank vessel application is not in operation.

Icon	Name	Function
	Weigh In	The tank vessel is refilling.
	Weigh Out	The tank vessel is discharging.
	Upper Limit	The material has met its high threshold weight and refilling is stopped.
	Lower Limit	The material has met its low threshold weight and refilling is started.

1.4. Further Information

For more information, please refer to the following documentation available online on www.mt.com/ind-ind360-downloads:

- Tank/vessel application information
 - IND360tank/vessel data sheet
- Device information and drawings
 - IND360base data sheet
 - IND360base manual
- PLC sample code for applications (refer to section 5.1, **PLC Sample Code**)

2 Installation

To install and ground the terminal, refer to Appendix A, **Installation**, in the **IND360 Terminal and Transmitter Technical Manual**.



Grounding performance of the equipment must be maintained in a good condition. Equipment grounding must be completed by a professional electrician. The METTLER TOLEDO Service Center offers supervision and consultation only.

- Complete the grounding of all equipment (power supply unit, weighing display, and scale, etc.), in reference to wiring diagrams of equipment and based on relevant national or local regulation requirements. In this process, it is essential to make sure that:

All equipment enclosures are connected at the same earth potential through grounding terminals.

No current flows circulating through the cable shield of any conductors such as the load cell or scale.

The neutral grounding point shall be as close to the weighing system as possible.

2.1. Wiring

Refer to the wiring charts shown below to connect the terminal with a tank vessel system. METTLER TOLEDO recommends the addition of an externally-controlled safety mechanism for refill.

2.1.1. DIN Rail-Mount and Panel Version

Figure 2-1 shows a typical system layout with an IND360 DIN/Panel mount version and a tank vessel.

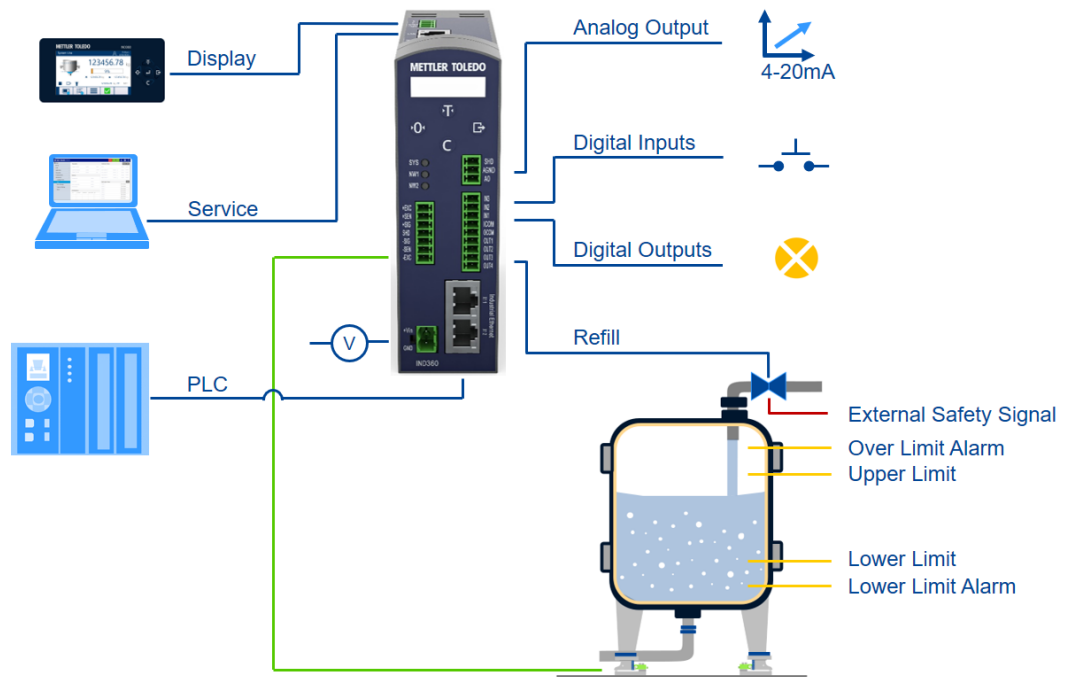

Figure 2-1: IND360 Tank Vessel System Wiring Chart

The digital I/O block must be attached to a common ground or voltage source+ to be operated. A typical setup is shown in Figure 2-2, other combinations of sinking or sourcing input/output are possible as well. Please refer to Appendix A, **Installation**, in the **IND360 Terminal and Transmitter Technical Manual** for additional information about the digital I/O.

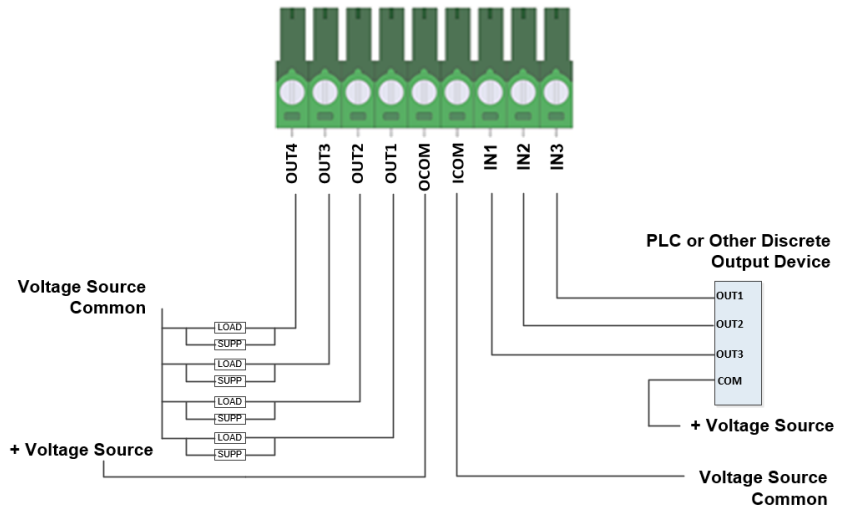

Figure 2-2: Sinking input and Sourcing Output

2.1.2. Harsh Version

Figure 2-3 shows a typical installation of the IND360 harsh environment version.

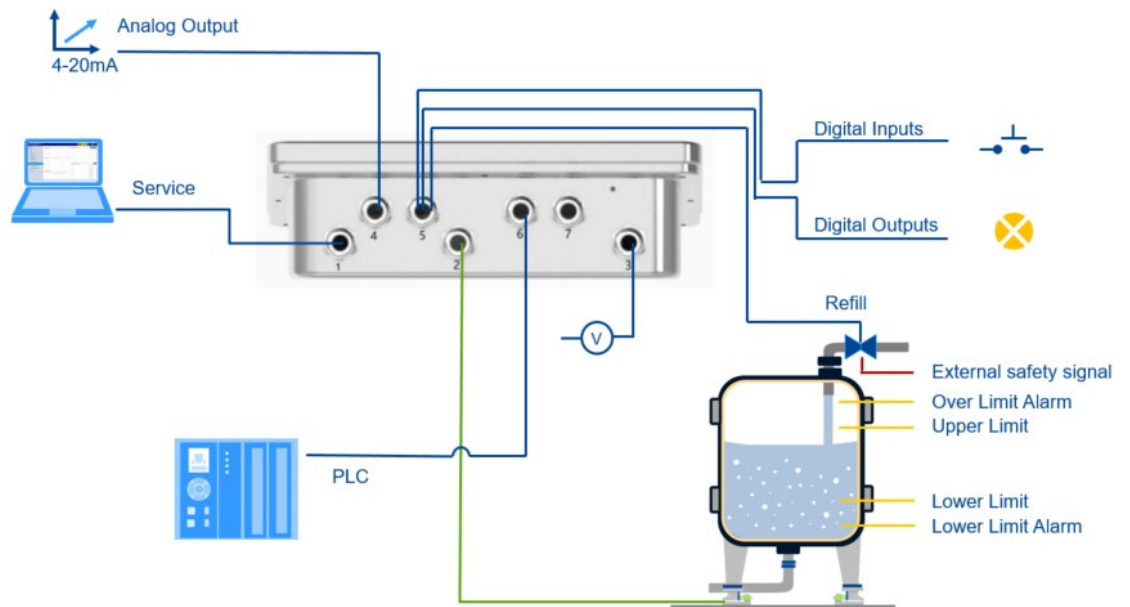

Figure 2-3: Harsh Enclosure Installation

Table 2-1: Harsh Enclosure Opening Cable Assignments

Opening	Use	Cable Gland Size, mm
1	Service Ethernet TCP/IP, M12 connector	16
2	Load cell or Weigh Module Connection	16
3	AC Power	16
4	4~20mA	16
5	DI/O	16
6/7	PLC options(PROFINET, PROFIBUS DP, EtherNet/IP or Modbus RTU)	16

2.2. Tank Vessel Application Setup Checklist

Site Location				
IND360 Serial Number				
Load Cell Serial Numbers				
IP Addresses		Service port "LAN" (default: 192.168.0.8):		
		Industrial Ethernet Port "X1.1" (optional):		
		Industrial Ethernet Port "X1.2" (optional):		
Configuration Information				
1. IND360 terminal	Physical Connection	<input type="checkbox"/>	Connectivity of scale/load cells/junction box to IND360 terminal	
		<input type="checkbox"/>	24 VDC power supply connected (DIN, Panel)	
		<input type="checkbox"/>	Display connected (panel units), connector is marked "A, B, GND1, +12V"	
		<input type="checkbox"/>	PLC network option connected	
		<input type="checkbox"/>	Discrete input/output option connected	
		<input type="checkbox"/>	4-20 mA analog output option connected	
				Technical Manual Reference
	Scale Parameters	<input type="checkbox"/>	Scale type configured Setup > Scale > Type	3.5.1.1 Type
		<input type="checkbox"/>	Capacity and increment configured Setup > Scale > Capacity & Increment	3.5.1.2 Capacity & Increment
	Scale Adjustment	<input type="checkbox"/>	Calibration settings (technology dependent) Setup > Scale > Calibration	3.5.1.3 Calibration
<input type="checkbox"/>		Zero adjustment: set gross weight of empty tank to zero Setup > Scale > Calibration	3.5.1.3.2 Zero Adjust	
<input type="checkbox"/>		Span/Step (sensitivity) adjustment (technology dependent) Setup > Scale > Calibration	3.5.1.3.3 Span Adjust	
<input type="checkbox"/>		Disable pushbutton tare and disable/configure pushbutton zero Setup > Scale > Zero & Tare	3.5.1.4. Zero & Tare	
Communication	<input type="checkbox"/>	PC communication and ePrint configured or deactivated (depending on use case) Setup > Communication > Service	3.8.1 Service	
	<input type="checkbox"/>	(Optional) Analog output and PLC interface configured Setup > Communication > Analog output	3.8.2 Analog Output	
2. Application Configuration	Application Parameter Setup	<input type="checkbox"/>	Tank Vessel application activated Setup > Application > PAC > PAC Management	3.6.4 PAC (Application Pack) Management
		<input type="checkbox"/>	Target and alarm values defined Setup > Application > Tank Vessel	4.2.2 and 4.2.3 of this manual
		<input type="checkbox"/>	Discrete inputs assigned. Note: application can be started by digital input or PLC command Setup > Application > Tank Vessel	4.2.5 of this manual
		<input type="checkbox"/>	Discrete outputs assigned Setup > Application > Tank Vessel	4.2.6 of this manual
3. Hardware Switches	Locking Function	<input type="checkbox"/>	SW1 (legal for trade) set if device used in metrological approved setup	A.4.1 Main PCB Switches
		<input type="checkbox"/>	SW2 (master reset) disabled	A.4.1 Main PCB Switches

Setup completed by

Name:

Date:

Signature:

3 Operation

This chapter provides information about the tank vessel application implemented on an IND360 terminal. It assumes that the user of this manual has reviewed and understood the operation of the standard IND360. Refer to the **IND360 Terminal and Transmitter Technical Manual** for details.

Operation of the terminal depends on the enabled functionality and application setup parameters. The application configuration can be modified as necessary by users with appropriate access levels.

3.1. Operating Principle

The tank vessel application provides tank inventory control by measuring the weight of the tank and its inventory. The fill level is indicated by the weight value of the content and percentage of the total tank capacity.

The main functionality of the tank vessel application is defined by four configurable set points:

- **Over Limit Alarm** When this limit is exceeded, an alarm is triggered that notifies the user about a dangerous overfilling condition, e.g. a blocked refill valve.
- **Upper Limit** When the current fill level reaches the upper limit, the refill signal is turned off.
- **Lower Limit** When the current fill level falls below the lower limit, the refill signal is turned on.
- **Lower Limit Alarm** Falling below this limit triggers an alarm notifying the user that the material level is critically low. This could be caused for example by a broken refill pump.

The IND360 has the capability to indicate when the defined set points have been reached both via the automation interface and as a digital output signal (depending on output configuration).

- As a safety precaution, equip the refill control with logic that prohibits refilling under unsafe conditions.

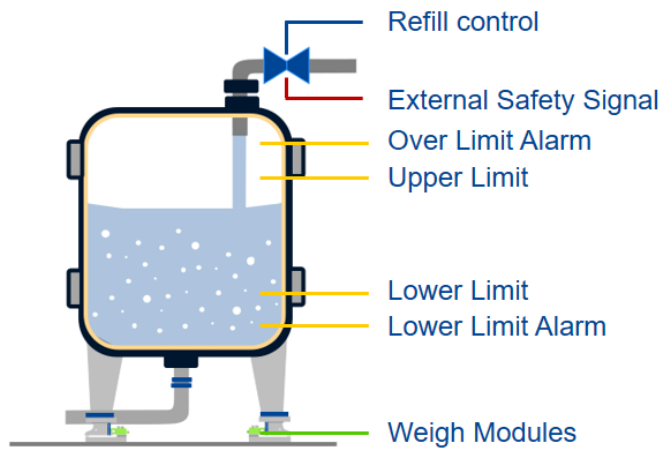

Figure 3-1: IND360 operating principle demonstrating the relevant set points and refill control.

3.1.1. Example Sequence

Figure 3-2 shows an IND360 tank/vessel sequence. In the first cycle, the weight reaches the upper limit, the refill turns off and the weight drops again as the material is consumed.

The second cycle demonstrates a case where the refill pump malfunctions and an alarm is triggered.

Input and output signals are enabled once the run signal is switched on. Depending on the filling level, the various output signals are set.

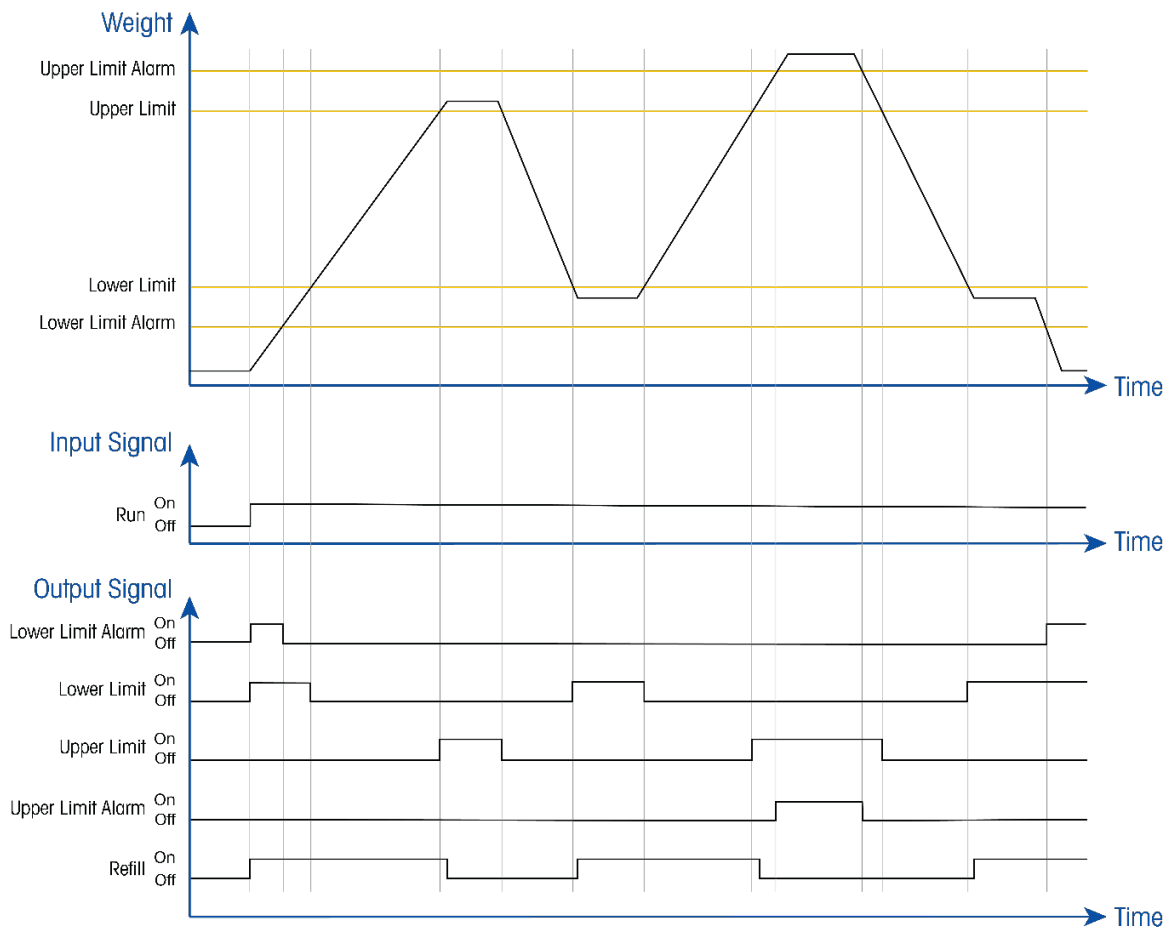

Figure 3-2: IND360tank/vessel Sequence Diagram.

3.2. Typical Use Cases

Typical use cases ranging from full PLC /DCS control to stand-alone operation are described in the following four sections. Any combination thereof is possible as well, depending on the project need.

3.2.1. Automation Network with Direct Refill Control

The IND360 controls the refill valve while providing visualization on the HMI. The PLC interface has cyclic and acyclic access to application status information and read/write of configuration. PROFINET and EtherNet/IP support redundant ring topology.

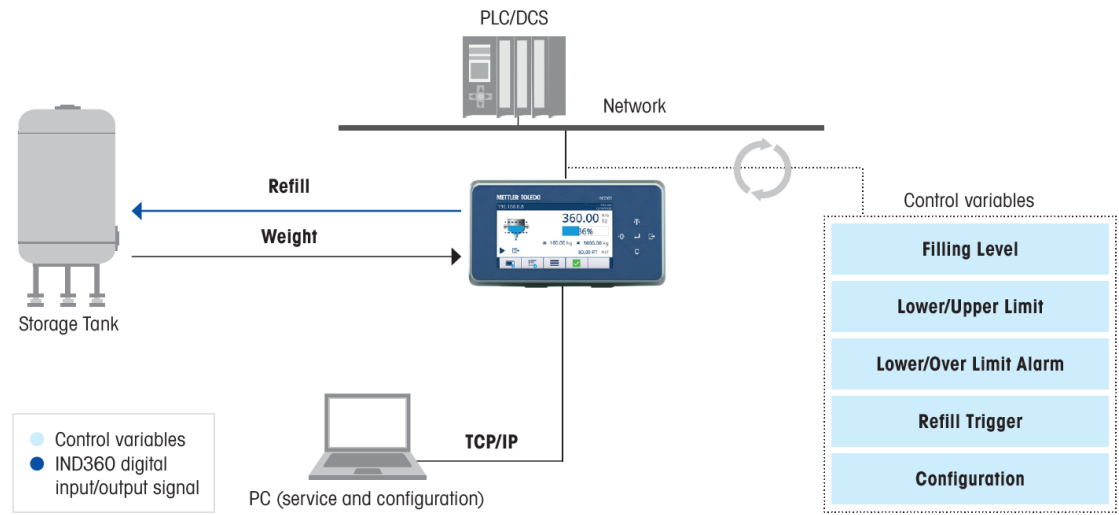

Figure 3-3: IND360 Connected to Automation Bus

3.2.2. Automation Network with Indirect Refill Control

Figure 3-4 shows an example in which the PLC controls the refill valve based on IND360 refill signal and other control information. The IND360 provides tank filling level monitoring and visualization on its HMI. The PLC interface has cyclic and acyclic access to application status information and read/write of configuration. PROFINET and EtherNet/IP support redundant ring topology.

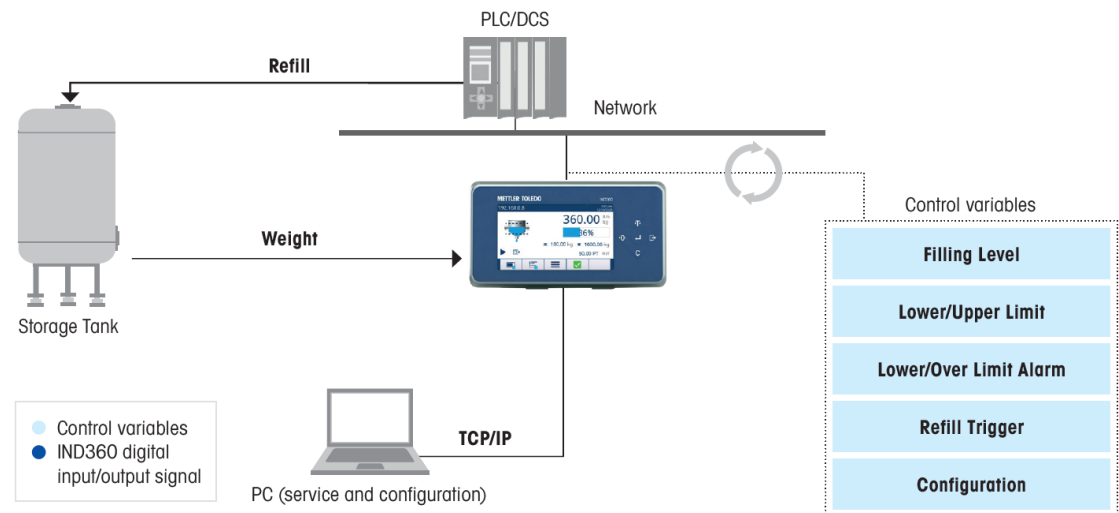

Figure 3-4: IND360 Connected to Automation Bus

3.2.3. Digital Input/Output Connectivity with PLC/DCS

Figure 3-5 shows an example in which the IND360 controls the refill valve and provides visualization on its HMI. PLC access to status information and control functionality using digital I/O. Optional 4-20 mA weight output available configured via the web interface or display.

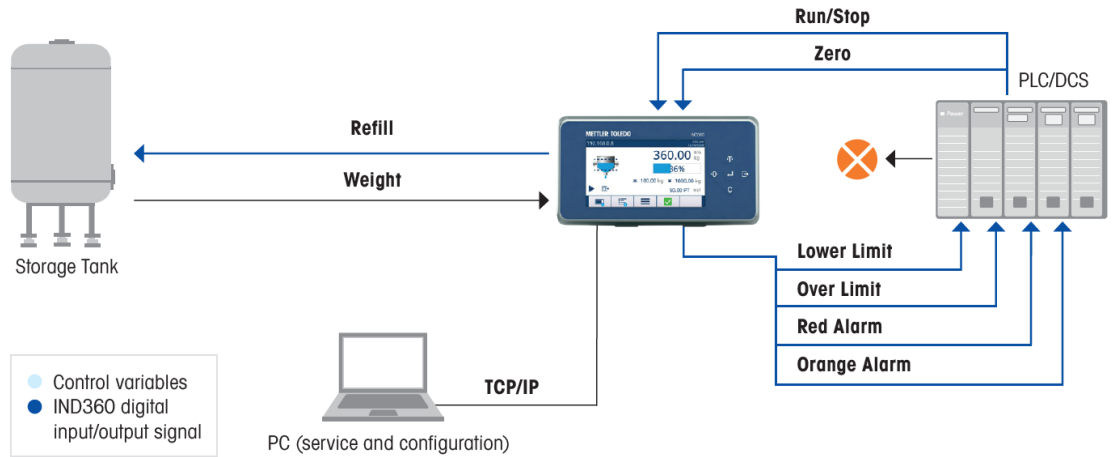

Figure 3-5: IND360 Connected to PLC/DCS Using Digital Input/Output

3.2.4. Stand-Alone Without PLC/DCS

Figure 3-6 shows an example of an IND360 stand-alone setup without PLC connection, in which the IND360 controls the refill valve and provides visualization on its HMI. The application is started by a physical momentary contact switch attached to a digital input of IND360. The "Over Limit Alarm" signal must be connected to a safety switch acting as an emergency stop for the refill function. Lights connected to physical outputs of IND360 show alarm status. Configuration is facilitated through the web interface or display.

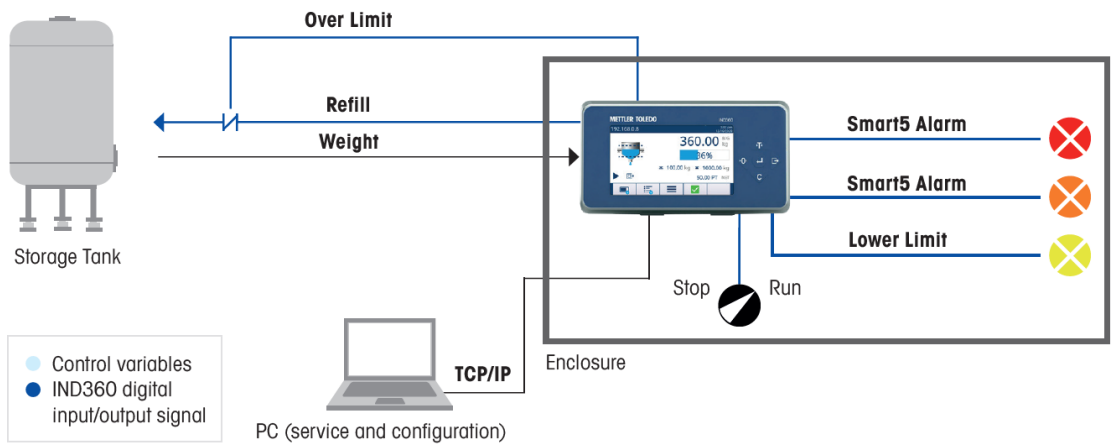

Figure 3-6: IND360 stand-alone operation

3.3. Starting and Stopping the Tank Vessel Application

Starting or stopping the tank vessel application is controlled through a discrete input or via PLC/DCS communication. The application cannot be started through the display, web interface or buttons.

3.4. User Management

IND360 supports three levels of user security that rely on appropriate username / password entry for access to Setup menu and Tank Vessel functions accessible from the home screen. When the application is running, the Setup menu can only be accessed as Operator and therefore read-only mode. Refer to Section 2.2, **User Security**, in the **IND360 Terminal and Transmitter Technical Manual** for detailed information on user security.

Table 3-1: Setup Menu Access Levels

Setup Menus	Administrator	Supervisor	Operator
Scale	Write & Read	Read	Read
Application	Write & Read	Write & Read	Read
Terminal	Write & Read	Read	Read
Communication	Write & Read	Read	Read
Maintenance	Write & Read	Write & Read	Read

3.5. Alibi Memory

The Alibi Memory is available when using the terminal in combination with the Tank Vessel application. Refer to Section 4.8, **Alibi Log**, in the **IND360 Terminal and Transmitter Technical Manual** for detailed information on the Alibi Memory and instructions on how to receive the data records.

3.6. ePrint Function

For Tank Vessel application, the ePrint template contains date and time, gross, tare, net and material level in percentage (Figure 3-7). The ePrint template is not user configurable.

For more information on how to use the ePrint function, please refer to Section 2.5.4, **ePrint**, in the **IND360 Terminal and Transmitter Technical Manual**.

Tank Vessel		
Date Time:	09:08:05	15/Dec/2019
Gross:		123456.78kg
Tare:		123456.78kg
Net:		123456.78kg
Percentage:		100%

Figure 3-7: ePrint Template of Tank Vessel Application

3.7. Statistics

Statistics stores statistical data for the Tank Vessel application:

- Lower Limit Counts: Incremented by one when the tank weight falls below the lower limit.
- Upper Limit Counts: Incremented by one when the tank weight exceeds the upper limit.
- Refill Counts: Incremented by one if refill signal is triggered.

To view the statistical data, press  on the home screen of a Panel or Harsh version terminal, or access **Device > LC Info Recall** on the web interface.

4 Configuration

This chapter provides information on configuring the Tank Vessel application. All configuration is performed in Setup mode – i.e. while the application is not running.

4.1. Configuration Interface Access

4.1.1. Web Interface

It is strongly recommended that the terminal parameters be configured through the web interface. The IND360 terminal web interface is intuitive and easy to use, and requires less time and effort to setup the terminal than using the keypad on the terminal front panel.

- If the IND360 terminal is a DIN rail-mount version, the Tank Vessel application **must** be configured using the web interface.

Refer to Section 3.1 of the **IND360 Terminal and Transmitter Technical Manual** to log on to the web interface. The Tank Vessel configuration page of the web interface is shown below:

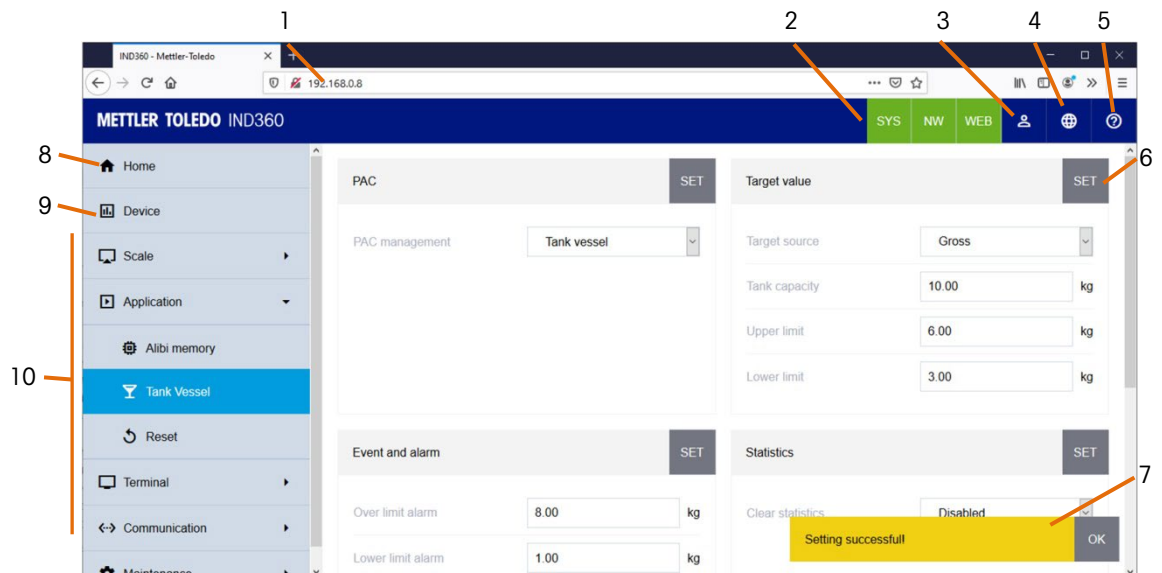

Figure 4-1: Elements of the Web Interface

- | | | |
|---|--------------------------|---|
| 1 | IP address | Service IP address of the IND360 terminal. |
| 2 | Status indicators | Same indication pattern as the LEDs on the terminal. Refer to Section 4.12.1.1 Diagnostic LEDs in the IND360 Terminal and Transmitter Technical Manual for more information on their indication pattern and explanations. |
| 3 | Users | Switch to user management to setup password protection |
| 4 | Language | Select language, available languages include English [default], Chinese, German, French, Spanish and Italian. |

- 5 **Help** Navigate to the help page.
- 6 **Set button** Press the Set button after any parameter change.
- 7 **Message** Appears if any parameter is changed. Press OK to close.
- 8 **Home** Shows the weight information (gross, net, tare, preset tare) and status of discrete inputs and outputs.
- 9 **Device** Shows read-only information for load cells, PLC / DCS communication and the IND360 service network configuration.
- 10 **Setup Menu** Navigation menu.



4.1.2. Display

To enter or exit the setup menu in the panel and harsh versions, follow the instructions below.

4.1.2.1. Enter Setup Menu

1. Long press the ePrint/Setup key . If the terminal is password protected, a login screen will be displayed where the operator must enter a valid user name and password.

4.1.2.2. Exit Setup Menu

1. Press the Zero key  several times (leaving all submenus) until the screen display **“Save all Settings before existing?”**
2. Select “YES” to accept all setting changes; select “NO” to discard all setting changes; select “Cancel” to stay in the setup mode.
3. Press the Enter key  to confirm.

4.1.2.3. Tank Vessel Application Setup Menu Tree

Table 4-1: Tank Vessel Application Setup Menu Tree

Level 1	Level 2	Level 3	Level 4	Default Value	
Application	PAC	PAC Management		Tank Vessel	
		Target Value	Target Source		Gross
			Tank Capacity		Scale capacity
			Upper Limit		80% of tank capacity
			Lower Limit		10% of tank capacity
		Event and Alarm	Over Limit Alarm		90% of tank capacity
			Lower Limit Alarm		5% of tank capacity
		Statistics	Clear Statistics		Disable
		Discrete Input	IN 1	IN 1	Run / Stop
			IN 2	IN 2	Clear Statistics
			IN 3	IN 3	Silence Alarm
			/	IN 4	(None)
			/	IN 5	(None)

Level 1	Level 2	Level 3	Level 4		Default Value
		Discrete Output	OUT 1	OUT 1	Upper Limit
			OUT 2	OUT 2	Lower Limit
			OUT 3	OUT 3	Refill
			OUT 4	OUT 4	Application Alarm
			/	OUT 5	(None)
			/	OUT 6	(None)
			/	OUT 7	(None)
			/	OUT 8	(None)
	Reset				

4.2. Application Configuration

Parameters related to the Tank Vessel application are found under the Application menu; after entering the **Setup** screen, navigate to Application using the Clear key .

4.2.1. PAC Management

In the **Application > PAC Management** menu, **Tank Vessel** is selected and enabled by default.

Tank Vessel [default] This option is selected by default.

Disable This option disables the tank vessel application and turns the terminal to an IND360 base.

4.2.2. Target Value

Target values must be set up in such a way that:

Lower Limit Alarm < Lower Limit < Upper Limit < Upper Limit Alarm < Tank Capacity

If these conditions are not met, the application may not work, or work in unexpected ways.

4.2.2.1. Target Source

For Tank Vessel applications, the target source is always configured as gross weight. This setting cannot be changed for safety reasons, as taring would affect the fill level limits and alarms. For safety reasons, the permitted zero range should be restricted (subsection 4.4.3) to tightly match the needs of the application (e.g. allow zeroing of the empty tank if there is snow on the tank). If the zero range tolerance is too wide, it could be possible to overfill the tank (e.g. zeroing a half-full tank and then running the application).

Default value (fixed): gross

Target Source Gross

4.2.2.2. Tank Capacity

Tank Capacity refers to the weight of the tank when it is completely filled with the material. This does not include the weight of the tank (container) as this will be accounted for by the zero adjustment. Note that the weight unit of Tank Capacity is the same as the primary unit, which is found under **Setup > Scale > Capacity & Increments**.

Default: **Scale Capacity**

Tank Capacity [0 ... scale capacity]

4.2.2.3. Upper Limit

Upper threshold value for the fill level. The IND360 indicates when the material level reaches this point through the automation interface and a digital output (configurable).

Default: **80%** of tank capacity.

Upper Limit [0 ... tank capacity]

4.2.2.4. Lower Limit

Lower Limit is the low threshold of the material level. The IND360 indicates when the material level reaches this point through the automation interface and a digital output (configurable).

Default value: 10% of tank capacity

Lower Limit [0 ... tank capacity]

4.2.3. Event and Alarm

4.2.3.1. Over Limit Alarm

Configure the upper fill level threshold to trigger an over limit alarm when reached. A typical use case is to detect if the refill mechanism did not turn off or if the device it was connected to failed to respond.

Default: **90%** of scale capacity

Over Limit Alarm [0 ... tank capacity]

4.2.3.2. Lower Limit Alarm

Configure the lower limit level threshold to trigger a lower limit alarm when reached. A typical use case is to detect if the refill mechanism did not turn on.

Default: **5%** of tank capacity

Lower Limit Alarm [0 ... Lower Limit]

4.2.4. Statistics

4.2.4.1. Clear Statistics

Clear Statistics clears all application statistical data.

Default: **Disabled**

Enable	Clear all application statistics. Setting will change to Disable automatically once the statistics have been cleared.
Disable	Abort the clearing process.

4.2.5. Discrete Input

The IND360 terminal with activated tank vessel application provides three or five discrete inputs, depending on the options installed. The following functionalities may be assigned to a discrete input:

None Run/Stop Clear Statistics Silence Alarm* Print
Tare Zero Clear Tare

(* A Silence Alarm input turns the alarm output off.)

Default assignments of these discrete inputs are:

3 Discrete Inputs	5 Discrete Inputs	Assignment [Default]
IN 1	IN 1	Run / Stop
IN 2	IN 2	Clear Statistics
IN 3	IN 3	Silence Alarm
/	IN 4	(None)
/	IN 5	(None)

4.2.6. Discrete Output

The IND360 terminal with active tank vessel application provides four or eight discrete outputs, depending on the installed options. The following functionalities can be assigned to a discrete output:

- None
- Smart5 red
- Over capacity
- Smart5 orange
- Upper limit
- Application alarm*
- Under zero
- Center of zero
- Lower limit
- Over limit alarm
- Motion
- Refill
- Lower limit alarm
- Net

* An **Application alarm** can occur when there is a logical error in a parameter setting; when there is a parameter setting range error; and when an over/under limit alarm occurs.

4 Discrete Outputs	8 Discrete Outputs	Assignment [Default]
OUT 1	OUT 1	Upper limit
OUT 2	OUT 2	Lower limit
OUT 3	OUT 3	Refill
OUT 4	OUT 4	Application alarm

4 Discrete Outputs	8 Discrete Outputs	Assignment [Default]
/	OUT 5	(None)
/	OUT 6	(None)
/	OUT 7	(None)
/	OUT 8	(None)

4.2.7. Reset

Reset application settings to default values.

- Yes** Reset the application configuration.
- No *** Do not reset the application configuration.

After a reset, a status message "Reset Successful" or "Reset Failed" will be shown indicating the status of the reset. In case the reset operation fails, please execute a master reset (refer to section A.4.1, **Main PCB Switches** in the **IND360 Terminal and Transmitter Technical Manual**). Press the ePrint/Setup key to clear the message and return to the Reset menu branch.

4.3. LoadAdvisor™

4.3.1. Overview

"LoadAdvisor™" simplifies the setup of a tank scale, silo or storage container by providing step-by-step guidance and offering advanced condition monitoring.



Figure 4-2 Accessing LoadAdvisor

Click the LoadAdvisor™ soffkey  to access the guided setup.

4.3.2. Elements of the LoadAdvisor Interface



Figure 4-3: LoadAdvisor Interface

- | | | |
|---|-----------------------------------|---|
| 1 | Individual load and status | Shows load percentage and load status (overloaded) of single weigh module. |
| 2 | Instructions | Indicates the progress of the guided setup. Finished steps are marked with a solid circle. |
| 3 | Guided commissioning | Softkeys to access the five-step tank setup. After this commissioning procedure, the tank system is adjusted and ready to use. |
| 4 | Diagnostic information | Shows information about the highlighted weigh module. Information includes node ID, output, serial number, and the temperature of the load cell. |
| 5 | Initial center of gravity | After tank setup is complete, the initial center of gravity will be displayed and fixed on the screen. If the tank setup is changed, the initial center of gravity will be updated. |
| 6 | Live center of gravity | The live point is updated in real time. E.g., abnormal change of center of gravity may be caused by material build-up one side or mechanical interference of pipes as the load changes. |

Table 4-2: Softkeys for Guided Commissioning Functions

Softkey	Name	Function
	Basic settings	Configure number of weigh modules, execute addressing procedure and specify the tank layout.
	Mapping	Map weigh module position on screen to match physical layout by serial number or placing loads.
	Shimming	Guided shimming indicates where to place the shims.
	Electronic shift adjustment	Eliminate repeatability errors by adjusting the output of every individual load cell.
	Adjustment	The adjustment using RapidCal™, test weights or other method account for the mechanical structure of the tank and attached piping.

4.3.3. Access Permissions

- Administrator: full access
- Other access levels: read-only access, view visualization

4.3.4. Basic settings

The basic settings include the following steps:

- Load cell addressing
- Configuration of unit, capacity and increment
- Configuration of tank and weigh module layout for the graphical visualization

For more information on load cell addressing, please refer to section **Load Cell Address**, in the **IND360 Terminal and Transmitter Technical Manual**.

4.3.5. Mapping

Map weigh module positions on screen to match the scale's physical layout. LoadAdvisor™ offers two procedures:

1. **Serial number mapping:** Select a weigh module using the up and down keys. Press **Enter** to open a drop-down menu and select a physical weigh module by its serial number. Press **Enter** to confirm, then use the up and down keys to select the next weigh module. Repeat this process until all the weigh modules are identified by their respective serial numbers.

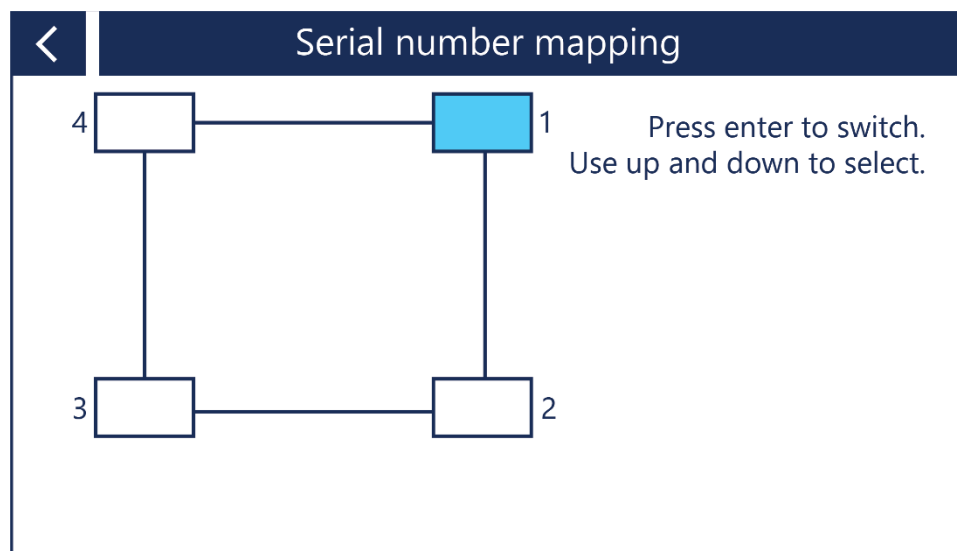

Figure 4-4: Weigh Module Mapping Interface

2. **Load mapping:** This method identifies the position by loading each weigh module individually. Apply a load on the highlighted weigh module to match its physical position. Repeat this step until all weigh modules are assigned.

4.3.6. Shimming

The purpose of shimming is to level the system. This prevents the weigh modules from being unevenly loaded, and improves load distribution. The guided shimming mode indicates where to place shims.

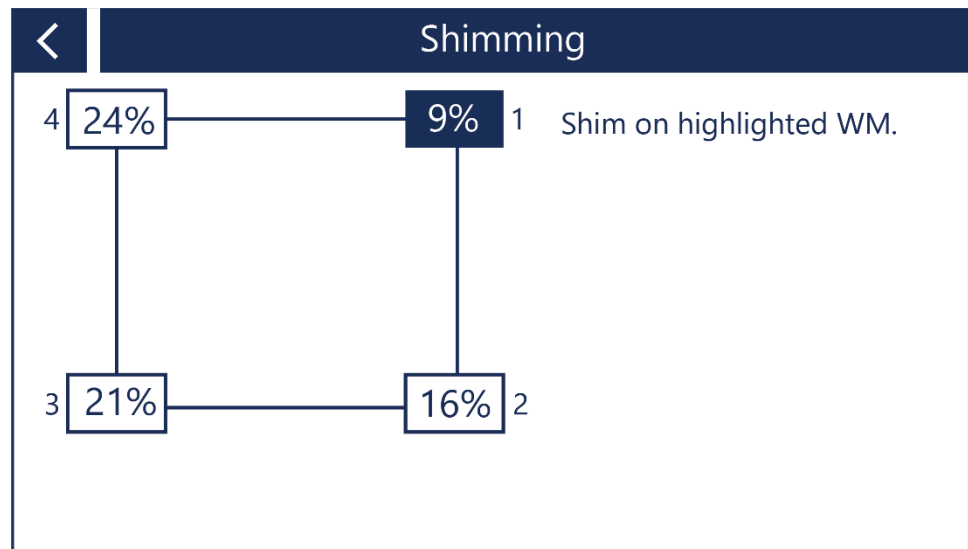

Figure 4-5: Shimming interface

Once the scale is shimmed, the initial center of gravity point will update.

4.3.7. Electronic shift adjustment

Once shimming is complete, eliminate repeatability problems by performing an electronic shift adjustment. This procedure prompts to load each load cell individually to determine the internal adjustment values. Please refer to the **Shift Adjust** section in the **IND360 Terminal and Transmitter Technical Manual**.

4.3.8. Adjustment

Adjustment using RapidCal™, test weights or other method is performed to account for the mechanical structure of the tank and attached piping.

Please refer to **Calibration** section, in the **IND360 Terminal and Transmitter Technical Manual**.

4.4. Zero Settings

This section describes how to configure the scale zeroing functionality for tank vessel applications. For additional details, please refer to section 3.5.1.4, **Zero & Tare**, in the **IND360 Terminal and Transmitter Technical Manual**.

Parameters related to the Zero functionality are placed under menu item **Scale > Zero > Ranges**.

- **Note:** When this device is used in weights and measures "approved mode" (for sale to the public), set all the zero configuration values before activating the approved mode hardware switch. After activating the hardware switch, the settings are read-only as required by law.

4.4.1. Power up zero

After a power outage, the device uses the previously captured zero (default configuration).

- Capturing a new zero point (capture new zero) is discouraged because the tank is not necessarily empty when power is restored.

Use last zero	Select last captured zero point (recommended option for most use cases)
Use calibrated zero	Use zero point captured during initial zero adjustment
Capture new zero	Zero scale on power-up (discouraged)

4.4.2. Pushbutton zero

Pushbutton zero functionality in a Tank Vessel application is use case dependent. If the zero push button shall not be used, it is a good practice to disable it to avoid accidental zeroing of the tank by an operator.

Default value: Enabled

Enable	Zero push button functionality activated.
Disable	Zero push button disabled

4.4.3. Pushbutton Zero Range

When the tank is emptied, there may be some residual material in the tank (e.g. due to material adhering to the structure). The zero pushbutton adjusts for this sort of relatively small deviations from zero.

To ensure that an operator does not accidentally execute a zero operation on a non-empty tank, the range of the pushbutton zero operation should be limited using this parameter, based on the material in use and operating procedures. This mitigates the risk of overfilling the tank.

Pushbutton zero +range	[0 ... 100%]
Pushbutton zero -range	[0 ... 100%]

5 Communication Protocol

5.1. PLC Sample Code

The PLC sample code demonstrating the IND360 tank vessel application is available on www.mt.com/ind-ind360-downloads for download. A package is available both for Siemens TIA Portal and Rockwell Studio 5000 and includes an Engineering Note.

5.2. Parameter Verification

The IND360 tank vessel application checks the parameters once the application is started. To assist finding configuration issues, the application offers two status bits to the PLC/DCS.

Parameter Invalid The parameter is set to an invalid value
Example: Lower limit = -1

Parameter Logic The parameter setting conflicts with the configuration of related parameters
Example: Lower limit > tank capacity

The IND360 performs the same checks when entering the configuration through the web interface or display. In this case, feedback to the operator is provided immediately.

5.3. Modbus RTU Protocol

Table 5-1: Modbus RTU Protocol

Parameter	Option/Range	MODBUS	Read/Write	Data Type
Tank Capacity	[0 ~ Scale capacity]	41002	R/W	double
Upper Limit	[0 ~ Tank capacity]	41004	R/W	double
Lower Limit	[0 ~ Upper Limit]	41006	R/W	double
Lower Limit Alarm	[0 ~ 9.99]s	41008	R/W	float
Over Limit Alarm	[0 ~ Tank capacity]	41010	R/W	double
Current Weight		41012	R	double
Percentage		41014	R	float
Clear Statistics	0: Disable / 1: Enable	41016	W	unsigned char
Lower Limit Counts	[0 ~ 99,999,999]	41017	R	long
Upper Limit Counts	[0 ~ 99,999,999]	41019	R	long

Parameter	Option/Range	MODBUS	Read/Write	Data Type
Refill Counts	[0 ~ 99,999,999]	41021	R	long
Alarm Status	bit0: Lower Limit Alarm bit1: Over Limit Alarm bit2: Parameter Invalid bit3: Parameter Logic Error	41023	R	unsigned short
Run Status	bit0 : Run bit1 : Refill bit2: Upper Limit bit3: Lower Limit bit4: Alarm	41024	R	unsigned short
Control Command	0:Stop 1:Run	41025	W	unsigned char

5.4. PLC Protocol

5.4.1. Cyclic Commands

Table 5-2: Cyclic Commands

Parameter	Option/Range	SAI Command		Read/Write	Data Type	Block
		Read	Write			
Tank Capacity	[0 ~ Scale capacity]	102	302	RW	Float 32	Tank Capacity
Upper Limit	[0 ~ Tank capacity]	103	303	RW	Float 32	Upper Limit
Lower Limit	[0 ~ Upper Limit]	104	304	RW	Float 32	Lower Limit
Lower Limit Alarm	[0 ~ Lower Limit]	105	305	RW	Float 32	Lower Limit Alarm
Over Limit Alarm	[0 ~ Tank capacity]	106	306	RW	Float 32	Over Limit Alarm
Current Weight	Current gross weight in primary unit	107	N/A	R	Float 32	Current Weight
Percentage	% of tank filled based on capacity	108	N/A	R	Float 32	Percentage
Clear Statistics	0: Disable / 1: Enable	N/A	309	W	Float 32	Clear Statistics
Lower Limit Counts	[0 ~ 99,999,999]	110	N/A	R	Float 32	Lower Limit Counts
Upper Limit Counts	[0 ~ 99,999,999]	111	N/A	R	Float 32	Upper Limit Counts
Refill Counts	[0 ~ 99,999,999]	112	N/A	R	Float 32	Refill Counts
Control Command	0: Stop / 1: Run	N/A	313	W	Float 32	Control Command

5.4.1.1. Cyclic Commands – Status Block

Table 5-3: Cyclic Commands – Status Block

Status Command	Description		Note
0	RedAlert Alarm, Scale Group 2, I/O Group 1		Refer to the SAI Reference Guide for Transmitters for additional details
1	RedAlert Alarm, Scale Group 2, I/O Group 1		See SAI Reference Guide for Transmitters for additional details
12	Word 0	Custom group 1	Refer to Table 5-4, Table 5-5 and Table 5-6 for additional information
	Word 1	Custom group 2	
	Word 2	I/O group 1	

5.4.1.2. Custom Group 1 (for Tank/Vessel) – Run Status

Table 5-4: Custom Group 1

Bit	Description
0	Run
1	Refill
2	Upper Limit
3	Lower Limit
4	Alarm

5.4.1.3. Custom Group 2 (for Tank/Vessel) – Alarm Status

Table 5-5: Custom Group 2

Bit	Description
0	Lower Limit Timeout
1	Over Limit Alarm
2	Parameter Invalid
3	Parameter Logic Error

5.4.1.4. I/O Group 1

Table 5-6: I/O Group

Bit	I/O Group 1	Bit	I/O Group 1
0	Input 1	9	Output 2
1	Input 2	10	Output 3
2	Input 3	11	Output 4
3	Input 4	12	Output 5
4	Input 5	13	Output 6
5	Not used	14	Output 7
6	Not used	15	Output 8

Bit	I/O Group 1
7	Not used
8	Output 1

Bit	I/O Group 1
9	Output 2
10	Output 3

5.5. Acyclic Commands

Table 5-7: Acyclic Commands

Parameter	Option/Range	PROFIBUS Slot	PROFIBUS Index	EIP Class Code	EIP Instance Values	EIP Attribute #	PROFINET slot + subslot	PROFINET / EtherCAT Index	Read / Write	Data Type
Tank Capacity	[0 ~ Scale capacity]	3	0xA1	0x41B	0x01	0x02	0, 1	0x4702	R/W	Float 32
Upper Limit	[0 ~ Tank capacity]	3	0xA2	0x41B	0x01	0x03	0, 1	0x4703	R/W	Float 32
Lower Limit	[0 ~ Upper Limit]	3	0xA3	0x41B	0x01	0x04	0, 1	0x4704	R/W	Float 32
Lower Limit Alarm	[0 ~ Lower Limit]	3	0xA4	0x41B	0x01	0x05	0, 1	0x4705	R/W	Float 32
Over Limit Alarm	[0 ~ Tank capacity]	3	0xA5	0x41B	0x01	0x06	0, 1	0x4706	R/W	Float 32
Input1 Assignment	0: None	2	0x11	0x418	0x01	0x02	0, 1	0x4402	R/W	Byte 1
Input2 Assignment	1: Tare	2	0x14	0x418	0x01	0x05	0,1	0x4405	R/W	Byte 1
Input3 Assignment	2: Zero	2	0x17	0x418	0x01	0x08	0,1	0x4408	R/W	Byte 1
Input4 Assignment	3: Print	2	0x17	0x418	0x01	0x08	0,1	0x4408	R/W	Byte 1
Input5 Assignment	4: Clear Tare 6: Silence Alarm 7: Run/Stop 8: Clear Statistics	3	0x24	0x418	0x01	0x45	0,1	0x4605	R/W	Byte 1
Output1 Assignment	0: None	2	0x1D	0x418	0x01	0x0E	0,1	0x440E	R/W	Byte 1
Output2 Assignment	1: Center of Zero	2	0x24	0x418	0x01	0x15	0, 1	0x4415	R/W	Byte 1
Output3 Assignment	2: Over Capacity	2	0x2B	0x418	0x01	0x1C	0, 1	0x441C	R/W	Byte 1
Output4 Assignment	3: Under Zero	2	0x2B	0x418	0x01	0x1C	0, 1	0x441C	R/W	Byte 1
Output5 Assignment	4: Motion	2	0x32	0x418	0x01	0x23	0, 1	0x4423	R/W	Byte 1
Output6 Assignment	5: Net	2	0x39	0x418	0x01	0x2A	0, 1	0x442A	R/W	Byte 1
Output7 Assignment	15: Upper Limit 16: Lower Limit 17: Refill	3	0x27	0x418	0x01	0x48	0,1	0x4608	R/W	Byte 1
		3	0x2E	0x418	0x01	0x4F	0,1	0x460F	R/W	Byte 1

Parameter	Option/Range	PROFIBUS Slot	PROFIBUS Index	EIP Class Code	EIP Instance Values	EIP Attribute #	PROFINET slot + subslot	PROFINET / EtherCAT Index	Read / Write	Data Type
Output8 Assignment	18: Alarm	3	0x35	0x418	0x01	0x56	0,1	0x4616	R/W	Byte 1
Current Weight	Current gross weight in primary unit	3	0xA6	0x41B	0x01	0x07	0, 1	0x4707	R	Float 32
Percentage	% of tank filled based on capacity	3	0xA7	0x41B	0x01	0x08	0, 1	0x4708	R	Float 32
Clear Statistics	0: Disable / 1: Enable	3	0xA8	0x41B	0x01	0x09	0, 1	0x4709	W	Float 32
Lower Limit Counts	[0 ~ 99,999,999]	3	0xA9	0x41B	0x01	0x0A	0, 1	0x470A	R	Float 32
Upper Limit Counts	[0 ~ 99,999,999]	3	0xAA	0x41B	0x01	0x0B	0, 1	0x470B	R	Float 32
Refill Counts	[0 ~ 99,999,999]	3	0xAB	0x41B	0x01	0x0C	0, 1	0x470C	R	Float 32
Control Command	0:Stop / 1:Run	3	0xAC	0x41B	0x01	0x0D	0, 1	0x470D	W	Float 32

METTLER TOLEDO Service

To protect your product's future:

Congratulations on choosing the quality and precision of METTLER TOLEDO. Proper use according to these instructions and regular calibration and maintenance by our factory-trained service team ensure dependable and accurate operation, protecting your investment. Contact us about a service agreement tailored to your needs and budget.

We invite you to register your product at www.mt.com/productregistration so we can contact you about enhancements, updates and important notifications concerning your product.

www.mt.com/IND360

For more information

Mettler-Toledo, LLC
1900 Polaris Parkway
Columbus, OH 43240

© 2023 Mettler-Toledo, LLC
30654704 Rev. 01, 09/2023



30654704