

IND9D57/Dyn-570

Dynamic Weighing System



METTLER TOLEDO

IND9D57/Dyn-570

Dynamic Weighing System

METTLER TOLEDO Service

Essential Services for Dependable Performance of Your IND9D57/Dyn-570 Dynamic Weighing System

Congratulations on choosing the quality and precision of METTLER TOLEDO. Proper use of your new equipment according to this Manual and regular calibration and maintenance by our factory-trained service team ensures dependable and accurate operation, protecting your investment. Contact us about a service agreement tailored to your needs and budget. Further information is available at www.mt.com/service.

There are several important ways to ensure you maximize the performance of your investment:

1. **Register your product:** We invite you to register your product at www.mt.com/productregistration so we can contact you about enhancements, updates and important notifications concerning your product.
2. **Contact METTLER TOLEDO for service:** The value of a measurement is proportional to its accuracy – an out of specification scale can diminish quality, reduce profits and increase liability. Timely service from METTLER TOLEDO will ensure accuracy and optimize uptime and equipment life.
 - a. **Installation, Configuration, Integration and Training:** Our service representatives are factory-trained, weighing equipment experts. We make certain that your weighing equipment is ready for production in a cost effective and timely fashion and that personnel are trained for success.
 - b. **Initial Calibration Documentation:** The installation environment and application requirements are unique for every industrial scale so performance must be tested and certified. Our calibration services and certificates document accuracy to ensure production quality and provide a quality system record of performance.
 - c. **Periodic Calibration Maintenance:** A Calibration Service Agreement provides on-going confidence in your weighing process and documentation of compliance with requirements. We offer a variety of service plans that are scheduled to meet your needs and designed to fit your budget.
 - d. **GWP® Verification:** A risk-based approach for managing weighing equipment allows for control and improvement of the entire measuring process, which ensures reproducible product quality and minimizes process costs. GWP (Good Weighing Practice), the science-based standard for efficient life-cycle management of weighing equipment, gives clear answers about how to specify, calibrate and ensure accuracy of weighing equipment, independent of make or brand.

© METTLER TOLEDO 2018

No part of this manual may be reproduced or transmitted in any form or by any means, electronic or mechanical, including photocopying and recording, for any purpose without the express written permission of METTLER TOLEDO.

U.S. Government Restricted Rights: This documentation is furnished with Restricted Rights.

Copyright 2018 METTLER TOLEDO. This documentation contains proprietary information of METTLER TOLEDO. It may not be copied in whole or in part without the express written consent of METTLER TOLEDO.

METTLER TOLEDO reserves the right to make refinements or changes to the product or manual without notice.

COPYRIGHT

METTLER TOLEDO® is a registered trademark of Mettler-Toledo, LLC. All other brand or product names are trademarks or registered trademarks of their respective companies.

METTLER TOLEDO RESERVES THE RIGHT TO MAKE REFINEMENTS OR CHANGES WITHOUT NOTICE.

FCC Notice





This device complies with Part 15 of the FCC Rules and the Radio Interference Requirements of the Canadian Department of Communications. Operation is subject to the following conditions: (1) this device may not cause harmful interference, and (2) this device must accept any interference received, including interference that may cause undesired operation.

This equipment has been tested and found to comply with the limits for a Class A digital device, pursuant to Part 15 of FCC Rules. These limits are designed to provide reasonable protection against harmful interference when the equipment is operated in a commercial environment. This equipment generates, uses, and can radiate radio frequency energy and, if not installed and used in accordance with the instruction manual, may cause harmful interference to radio communications. Operation of this equipment in a residential area is likely to cause harmful interference in which case the user will be required to correct the interference at his or her expense.

- Declaration of Conformity is available at <http://glo.mt.com/global/en/home/search/compliance.html/compliance/> .

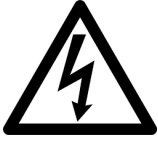
Warnings and Cautions

- READ this manual BEFORE operating or servicing this equipment and FOLLOW these instructions carefully.
- SAVE this manual for future reference.

	 WARNING
	THE IND570 IS NOT DESIGNED FOR USE IN HAZARDOUS (EXPLOSIVE) AREAS.
	 CAUTION
	BEFORE CONNECTING/DISCONNECTING ANY INTERNAL ELECTRONIC COMPONENTS OR INTERCONNECTING WIRING BETWEEN ELECTRONIC EQUIPMENT ALWAYS REMOVE POWER AND WAIT AT LEAST THIRTY (30) SECONDS BEFORE ANY CONNECTIONS OR DISCONNECTIONS ARE MADE. FAILURE TO OBSERVE THESE PRECAUTIONS COULD RESULT IN DAMAGE TO OR DESTRUCTION OF THE EQUIPMENT AND/OR BODILY HARM.
	NOTICE
	OBSERVE PRECAUTIONS FOR HANDLING ELECTROSTATIC SENSITIVE DEVICES.

Disposal of Electrical and Electronic Equipment

In conformance with the European Directive 2002/96/EC on Waste Electrical and Electronic Equipment (WEEE) this device may not be disposed of in domestic waste. This also applies to countries outside the EU, per their specific requirements.



Please dispose of this product in accordance with local regulations at the collecting point specified for electrical and electronic equipment.

If you have any questions, please contact the responsible authority or the distributor from which you purchased this device.

Should this device be passed on to other parties (for private or professional use), the content of this regulation must also be related.

Thank you for your contribution to environmental protection.

Contents

1	Introduction	1-1
1.1.	Overview: IND9D57 Versions	1-1
1.2.	Model Identification	1-2
1.3.	Internal Components	1-3
1.4.	Software Features.....	1-3
1.4.1.	Dyn-570 Features	1-3
1.4.1.1.	Dedicated inputs for photo-eyes	1-3
1.4.1.2.	Additional filtering capabilities.....	1-4
1.4.1.3.	Enhanced ID processing	1-4
1.4.1.4.	Enhanced Transaction Recording	1-4
1.4.1.5.	Checkweighing	1-4
1.4.2.	IND570 Features Unavailable or Changed in Dyn-570	1-4
1.4.2.1.	Scale > Capacity & Increment.....	1-4
1.4.2.2.	Tare functions changed.....	1-4
2	Operation	2-1
2.1.	Introduction	2-1
2.2.	Security	2-1
2.2.1.	Passwords	2-1
2.3.	Soffkeys and Icons	2-2
2.4.	Starting the Dyn-570 Application	2-2
2.4.1.	Manual Start	2-2
2.4.2.	Auto Start.....	2-2
2.5.	Basic (ExpressWeigh [®]) Operation.....	2-3
2.5.1.	Random Weighing using Photo-eyes.....	2-3
2.5.1.1.	Sequence of Operation	2-3
2.6.	Advanced (ExpressCheck [®]) Operation	2-3
2.6.1.	Check Weighing Mode	2-3
2.6.1.1.	Dyn Target Table ID Input	2-4
2.6.1.2.	Reject Output	2-6
2.6.1.3.	Checkweigh Application Running	2-6
2.6.2.	Photo Eye 3 Configurations	2-6
2.6.2.1.	Using PE3 to Count Fatal Errors	2-6
2.6.2.2.	Using PE3 as a Trigger to Transmit Data	2-7
2.6.3.	Transmit Delay.....	2-7
2.7.	Using the Tare Functions.....	2-7
2.8.	Using the ID Prompt Feature	2-7
2.9.	Clearing Fatal Errors	2-8
2.10.	Packaged I/O and Indicator Lights.....	2-8
2.10.1.	User Inputs	2-9
2.11.	Tables and Logs	2-9

2.11.1.	Transaction Table	2-9
2.11.1.1.	File Conversion Utility.....	2-9
2.11.2.	Error Log	2-10
2.11.3.	Dynamic Target Table	2-10
3	Configuration	3-1
3.1.	Overview.....	3-1
3.2.	Entering and Exiting Setup Mode.....	3-1
3.2.1.	Entering Setup Mode.....	3-1
3.2.2.	Exiting Setup Mode.....	3-1
3.2.3.	IND570dyn Setup Menu Tree	3-1
3.3.	Configuration Options	3-3
3.3.1.	General Setup	3-3
3.3.1.1.	Scale > Capacity & Increment.....	3-3
3.3.1.2.	Terminal > Display.....	3-3
3.3.1.3.	Terminal > Softkeys.....	3-3
3.3.1.4.	Application > Memory > Alibi.....	3-3
3.3.1.5.	Application > Memory > Target Table	3-3
3.3.1.6.	Application > Operation > Target.....	3-3
3.3.1.7.	Application > Discrete I/O.....	3-3
3.3.2.	Application > PAC: Basic Functionality.....	3-5
3.3.2.1.	System	3-5
3.3.2.2.	Display.....	3-6
3.3.2.3.	Photo-eyes.....	3-6
3.3.2.4.	Weigh Time & AutoTune.....	3-7
3.3.2.5.	Dynamic Adjust	3-7
3.3.2.6.	Error Config.....	3-8
3.3.2.7.	ID1 and ID2 Inputs.....	3-8
3.3.2.8.	Alarm Outputs.....	3-9
3.3.2.9.	DYN TARGET SEARCH.....	3-10
3.3.2.10.	Assign I/O	3-10
3.3.3.	Application > PAC: ExpressCheck® (Advanced) Functionality	3-11
3.3.3.1.	System	3-11
3.3.3.2.	Display.....	3-12
3.3.3.3.	ID1 Input.....	3-12
3.3.3.4.	Dynamic Target Table.....	3-12
3.3.4.	Communication	3-13
3.3.4.1.	PLC Options	3-13
3.3.4.2.	Connections	3-13
4	Service and Maintenance	4-1
4.1.	Error Codes and Error Messages.....	4-1
4.1.1.	Error Codes and Responses.....	4-1
4.1.2.	Error Messages	4-2
4.1.3.	Pop Up Message Box Errors	4-2
5	Parts and Accessories	5-1
5.1.1.	ARM100 Remote I/O Relay Module.....	5-1
5.1.2.	Ethernet TCP/IP Interface	5-2

5.1.3.	EtherNet/IP – Modbus TCP PLC Interface	5-2
5.1.4.	PROFIBUS, Harsh Enclosure	5-2
5.1.5.	PROFIBUS, Panel Enclosure.....	5-3
5.1.6.	PROFINET PLC Interface	5-3
5.1.7.	DIO, Relay, 5 Inputs, 8 Outputs	5-3
5.1.8.	COM2/COM3/DIO, Relay, 2 Inputs, 5 Outputs.....	5-4
A.	Installation.....	A-1
A.1.	Special Software Requirements	A-1
A.1.1.	Firmware Version	A-1
A.2.	Installation Notes	A-1
A.2.1.	Installation Method	A-1
A.2.1.1.	Loading via USB	A-1
A.2.1.2.	Loading via FTP or Serial File Transfer.....	A-2
A.3.	Mounting the Packaged Enclosure	A-2
A.4.	Installing Cables and Connectors	A-2
A.4.1.	Provided Cable Glands	A-2
A.4.2.	Wiring Connections for Instrument Power	A-2
A.4.3.	Wiring Connections for Digital I/O Options.....	A-3
A.4.3.1.	24 VDC Inputs and Outputs	A-3
A.4.3.2.	Line Voltage Outputs.....	A-3
A.4.3.3.	ARM100 Connections	A-3
A.5.	Closing the Enclosure	A-3
B	Default Settings.....	B-1
B.1.	Setup Parameters.....	B-1
C	Communications.....	C-1
C.1.	Demand Output Mode.....	C-1
C.1.1.	Trigger	C-1
C.1.2.	Output Templates	C-1
C.2.	Remote Discrete I/O (ARM100).....	C-2
C.3.	PLC Options	C-2
C.4.	ASCII Input	C-2
C.5.	Shared Data Variables	C-3
C.5.1.	Standard Dyn Application	C-3

1 Introduction

1.1. Overview: IND9D57 Versions

The IND570dyn and IND9D57 terminals are specialized application solutions used for in-motion weighing of conveyor-borne packages. They can be used with up to four 350 Ω load cells, and are compatible with the METTLER TOLEDO 9477 weighing conveyor. The IND570dyn is a stand-alone unit; when packaged with a variety of I/O options, it is known as the IND9D57. Both types are equipped with Dyn-570 software, which can be specified in either ExpressWeigh[®] or ExpressCheck[®] form.

The basic **ExpressWeigh** firmware provides accurate in-motion package weighing with ID and additional data input. **ExpressCheck** (advanced firmware) includes an enhanced version of ExpressWeigh, and adds the ability to perform three-zone over/under checkweighing, using comparisons with a Target Table.

Detailed information on the basic features, functions, operation and configuration of the base IND570 terminal may be found in the IND570 **User's Guide**, available for download at www.mt.com/IND570. This manual includes information on those features specific to the IND570dyn and IND9D57.

1.2. Model Identification

The model number and serial number are located on the data plate on the back of the terminal. Refer to Figure 1-1 to verify the IND9D57 that was ordered.

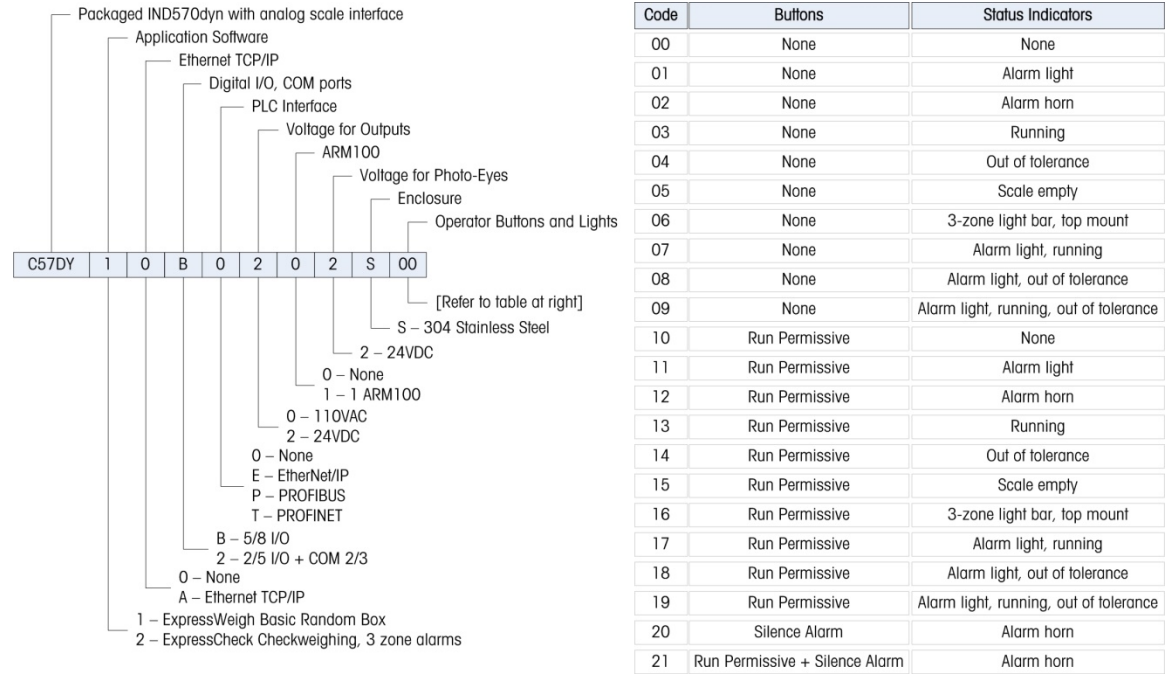

Code	Buttons	Status Indicators
00	None	None
01	None	Alarm light
02	None	Alarm horn
03	None	Running
04	None	Out of tolerance
05	None	Scale empty
06	None	3-zone light bar, top mount
07	None	Alarm light, running
08	None	Alarm light, out of tolerance
09	None	Alarm light, running, out of tolerance
10	Run Permissive	None
11	Run Permissive	Alarm light
12	Run Permissive	Alarm horn
13	Run Permissive	Running
14	Run Permissive	Out of tolerance
15	Run Permissive	Scale empty
16	Run Permissive	3-zone light bar, top mount
17	Run Permissive	Alarm light, running
18	Run Permissive	Alarm light, out of tolerance
19	Run Permissive	Alarm light, running, out of tolerance
20	Silence Alarm	Alarm horn
21	Run Permissive + Silence Alarm	Alarm horn

Figure 1-1: IND9D57 Model Identification Numbers

1.3. Internal Components

Figure 1-3 indicates the layout of the main components inside a typical IND9D57 enclosure.

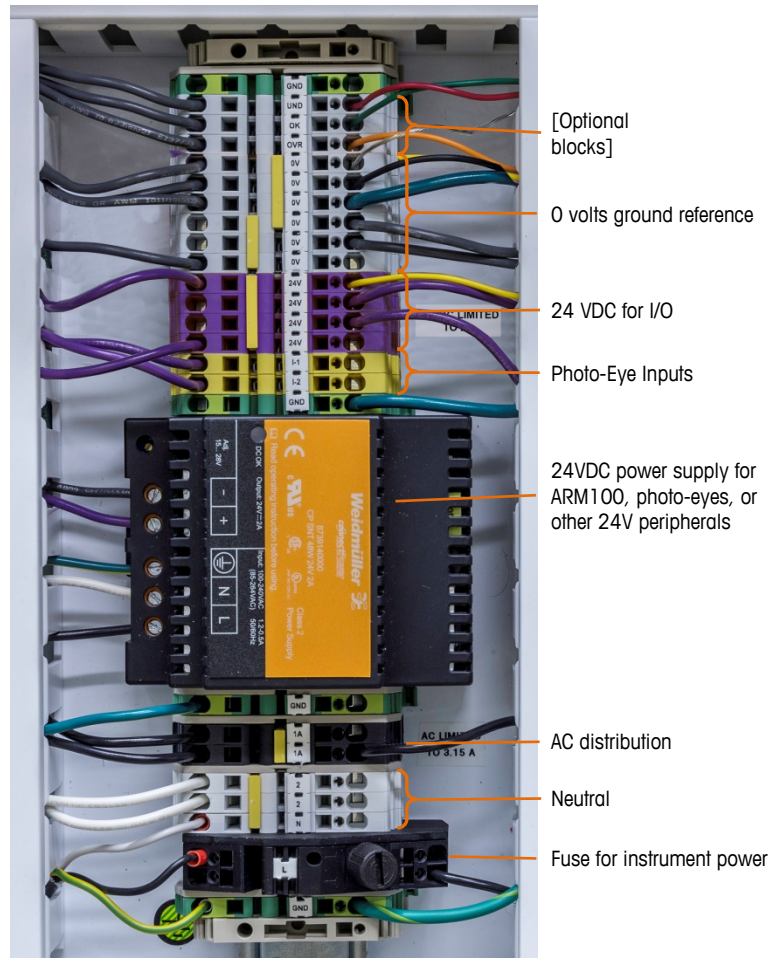

Figure 1-2: IND9D57 Internal Layout

1.4. Software Features

The sections below summarize the main functional differences between the base model IND570 and the Dyn-570 application.

1.4.1. Dyn-570 Features

1.4.1.1. Dedicated inputs for photo-eyes

- Automated triggering of weighment
- Adjustable threshold settings to prevent unintentional triggering of photo eyes
- Ability to accurately weigh packages in motion, even if more than one package is on the scale at one time. (Timing requirements still apply)

- Available buffering and deferred transmission of weighment data, triggered by down-stream photo-eye

1.4.1.2. Additional filtering capabilities

- Tunable notch filter –eliminates natural resonances from conveyor equipment
- AutoTune feature – calculates weighing filtering parameters based on worst-case package sample
- Dynamic Adjust feature – compensates for high-speed conveyor operation. Calculates offsets based on sample weighments of the longest and shortest package sizes

1.4.1.3. Enhanced ID processing

- Two independent input sources to store barcode and dimensional data with the transaction record
- IDs can be added to the printed or stored transaction record

1.4.1.4. Enhanced Transaction Recording

- 100,000-record transaction table, including package data captured during weighment
- Easy export via FTP for off-line analysis and archiving

1.4.1.5. Checkweighing

- 500 stored targets
- Adjustable reject output delay and duration timer for each target ID

1.4.2. IND570 Features Unavailable or Changed in Dyn-570

1.4.2.1. Scale > Capacity & Increment

- Note that multiple range and multi-interval operation are not supported in Dyn-570.

1.4.2.2. Tare functions changed

The tare table, keyboard and pushbutton tare are not available while the Dyn application is running. However, a tare may be entered on the keypad, or a pushbutton tare performed, from the home screen while the Dyn-570 application is not running. If a tare is set, Dyn-570 will use that tare for all transactions until the application is stopped and the tare cleared. When operating with a tare, the Net symbol "N" will be displayed above the weight unit on the terminal display.

Auto-tare cannot be used in Dyn mode.

2 Operation

2.1. Introduction

This chapter provides information about general operation of the IND570dyn and IND9D57 terminals. It is assumed that the user of this manual has reviewed and understands the operation of the standard IND570.

Operation of the terminal depends on enabled function and setup parameters. Functionality and configuration parameters are programmed in Setup mode and can be modified as necessary by users with appropriate access levels.

2.2. Security

The IND570dyn/IND9D57 support multiple users/passwords for setup security. The terminal is pre-configured at the factory with two user names, "admin" and "anonymous." The factory default passwords are null (no password). The terminal, as configured at the factory, requires no login or password entry to enter the setup mode. The pre-configured user (admin) cannot be changed, except to add or change a password.

2.2.1. Passwords

Once a password is set, be sure to remember it. If the password is changed or forgotten, access to the setup menu will not be available. Also, keep the password from unauthorized personnel – it provides access to the entire setup menu, unless the metrology switch is placed in the approved position. If the switch is set to approved, access to the scale and other metrologically significant areas is not permitted. Please refer to the **IND570 User's Guide** for additional information concerning Security and the multiple classes of users available with the IND570.

2.3. Softkeys and Icons

The IND570dyn/IND9D57 use the flexible softkey concept of the standard IND570 terminal, to provide softkeys specific to the Dyn-570 application. Table 2-1 explains these softkeys.

Table 2-1: Dyn-570 Softkeys

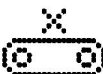
Icon	Function	Explanation
	START DYN-570	Runs the Dyn-570 application. Can be assigned in setup at Terminal > Softkeys .
	EXIT DYN-570	Exits Dyn-570 application and returns to standard IND570 mode. Displayed in the center softkey position, only when the Dyn-570 application is running.

2.4. Starting the Dyn-570 Application

The application can begin operation in two different ways – Manual or Auto Start. By default, the IND570dyn application is set up for Auto Start operation.

- To access the Menu Tree, the Dyn-570 application must be stopped so that home screen softkeys become available. If the terminal is in Manual Start mode, the application must be restarted once the operator exits setup and returns to the home display.

Once the Dyn-570 application is started, the EXIT DYN-570 softkey  displayed in the center softkey position.

Once the application has loaded, it waits for the scale to zero before entering its run state. The display will show zero weight.

After the scale is zeroed, the application starts to run, in the mode configured in setup. The display will show "Running."

2.4.1. Manual Start

Manual Start requires an operator to start the Dyn-570 application from the Home display with a softkey press.

The softkey method requires the START DYN-570 softkey  to be added to the terminal's home screen, at **Setup > Terminal > Softkeys**.

2.4.2. Auto Start

Setting the application for Auto Start (in Setup at **Application > TaskExpert > Start > Edit**) automatically initiates the Dyn-570 application when the system is turned on, and when the user exits the setup Menu Tree.

2.5. Basic (ExpressWeigh[®]) Operation

Operation of the IND570dyn/IND9D57 typically requires very little operator input or intervention. Where input is required, the Dyn-570 application provides specific prompts in order to assure consistent processing.

2.5.1. Random Weighing using Photo-eyes

2.5.1.1. Sequence of Operation

This mode requires no external interaction. With the Dyn-570 application running and the conveyor in motion:

1. A package breaks the beam of (entrance) Photo-eye 1, for more than the minimum time and less than the maximum time configured in setup at **Application > PAC > Photo-eyes**. The application interprets this as the entry of a package onto the scale.
2. The beam of Photo-eye 1 is restored as the package passes onto the scale.
3. The weighing process starts.
4. When the package breaks the beam of (exit) Photo-eye 2 for more than the minimum configured time, or another package breaks the upstream photo eye beam the weighing procedure ends.
5. Depending on how the system is configured, information is displayed and/or output through a communication port.

2.6. Advanced (ExpressCheck[®]) Operation

Advanced operation includes all the features of Basic operation, and adds an optional third Photo-eye, downstream of the scale, to trigger delayed transmission of weight information or count the number of packages that cross the scale in a fatal error condition. This mode also permits simple three zone check weighing.

2.6.1. Check Weighing Mode

For check weighing mode, a target – with associated over and under tolerances – is selected from the DYN target table before starting the Dyn-570 application.

A comparison mode must be selected – Target Deviation or % of Target – at **Application > Memory > Target Table**.

- Do not change the tolerance type parameter if there are records in the dyn target table.

All targets should be entered into the DYN Target Table to allow for accumulative functions and reject operation. This is accomplished through the menu item **Application > PAC > DYN Target Table**. It is possible to configure a target by using the TARGET softkey and entering a target weight and deviation specifications; however, accumulation statistics and reject operation will not work as expected.

- **Important:** It is strongly recommended that targets be modified in the Dynamic Target Table, and *not* by accessing a target record from the TARGET softkey, for the following reasons:
 - The procedure creates a one-time target for which no statistics are accumulated.
 - Unless the description field is changed, the original target's name will display on-screen, even though target and tolerance values may have been changed.
 - The reject parameters set for the original target will be used, and cannot be modified.
- You can configure the DYN Target Table only when the system type is set for checkweigh in **Application > PAC > System**.
- To simplify target selection before checkweighing is started, the TARGET TABLE softkey should be assigned to the home screen. Targets can also be selected while the Dyn-570 application is running by using an input device providing data to ID1, with ID1 mapped to Target ID. Refer to the ID1 and ID2 section in Chapter 3, **Configuration**.
- The operator can also clear accumulated target totals by exiting the Dyn-570 application and entering setup, to access **Application > PAC > DYN Target Table**.

Another method of selecting the active record from the Dyn Target Table is to use a communication connection to an external data source such as a bar code scanner reading an ID on the package being weighed. The connection can be configured to make all or part of the input the Dyn Target Table ID. Note that the DYN target table ID must be 8 or fewer numeric characters only. This configuration is accomplished in the **Application > Pac > ID1** branch, and by setting up a connection at **Communication > Connections**. To set up the compare mode, the user must access **Application > Memory > Target Table**. The mode should be set to Over/Under, and tolerance type to either target deviation or % target.

- When exiting the configuration menu for the first time after setting the mode to checkweigh, an “Invalid Parameter” message may appear in the print line of the display. This is because no active target is selected. It is important to select a target prior to the first transaction using any of the methods outlined below.

2.6.1.1. Dyn Target Table ID Input

There are two ways to set the DYN Target Record in the IND570dyn, after stopping the in-motion software:

- Keypad entry of the ID followed by pressing the TARGET TABLE softkey.
- Via a communication connection to another source of the ID.

2.6.1.1.1. Entry by Keypad

To enter an ID from the keypad, a TARGET TABLE softkey must be configured in setup at **Terminal > Softkeys**. For details, refer to Chapter 3, **Configuration**, of the **IND570 User's Guide**. Simply key in the numeric DYN Target ID and press the TARGET TABLE softkey, or search the Dyn Target Table, selecting the required ID and pressing **OK**. The record with the matching ID will be loaded into the active record.

2.6.1.1.2. Entry Via a Communication Connection

Another way to select a Target is to use a communication connection. Two items must be configured to make this method work:

- The Dyn Target ID input must be set up.
- A connection must be configured.
- A Dyn Target Table must be configured. Refer to Chapter 3, **Configuration**.

These settings are described in the next two sections.

Dyn Target ID Input Setup

First, **Application > PAC > ID1 > Data Type** must be set for DYN Target ID. When this option is selected, other parameters will appear on the screen that will help to parse the ID string from the communication string.

- **Note:** When a communication connection is used to input an ID, the system **must be** configured so that at least 3 seconds elapses between the receipt of the final character and the completion of the weighment. If this requirement is not observed, the ID input may not be parsed in time to be included in the weighment. The delay is especially important if the ID input is being used as the Dyn Target Table ID, since this requires additional time to look up the target.

The **first character** parameter is used to strip header information from the input. For example, when a string "***101<CR>" is received, the first digit's position is 3.

Length defines how long the ID is supposed to be. If the length is set to 2, the ID read from the previous example would be "10."

Mode defines how the ID is to be updated during operation. Three different modes can be selected: Required/Fill, Delete/Fill and Use Last.

When **Required/Fill** is selected, the communication connection must provide a valid ID before the termination of the weighment. If no ID is provided, a non-fatal error (-9912) will be displayed and transmitted with the transaction data. If an ID is received, but does not match an entry in the Dynamic Target Table, a non-fatal error (-9913) will be displayed and transmitted with the transaction data. An application of this mode would be for check weighing various different products simultaneously on one line. One package may be a 5 lb. bag of cat food and the next a 25 lb. bag of dog food. In this application, it is important to know which target value is to be used for comparison in each transaction.

The **Delete/Fill** mode deletes the ID information from the previous weigh cycle and fills the ID with the fill character set by the user. If a new ID is not provided before the end of the current weighment, the ID is shown as a repeating string of the fill character, and the comparison is based upon the last active record used. This would be useful in a situation where products with the same weight are being checked simultaneously, but an error (and unchecked) package should not be allowed to move through. For instance, you are checkweighing 5 lb. bags of dog and cat food, it may be useful to keep statistics on how much dog food vs cat food was checkweighed. Both packages have the same check weight targets, just different statistics. If an ID is missed for some reason, the package can still be accurately checkweighed, even though the statistic may be recorded in the wrong table.

The **Use Last** mode is useful on a line that check weighs one weight per lot or batch. This is the mode that would be best suited for manually selecting the ID from the Dynamic Target Table. Once an active record is selected, that record will be used either until a new ID is input on the communication connection or until the operator stops the control, selects a new active record for the target softkey, and restarts the control.

2.6.1.1.3. Connection Configuration

A connection must be made to the ID input source. The connection is set up at **Communication > Connections**. Create a new connection to the port, and select Input ID1 as the connection's assignment. For further details on creating connections, refer to Chapter 3, **Configuration**, in the **IND570 User's Guide**.

2.6.1.2. Reject Output

The checkweigh mode also supports a reject device that can be activated if a weighment is out of tolerance. To configure the reject output, first enable reject in setup at **Application > Pac > System > Reject enable**. Next, assign a discrete output in **Application > Discrete I/O > Outputs**. In order to use the reject output, the delay and duration must be set up in the Dyn Target Table. The reject output will **not** work when the target is entered using a keypad. Reject values are **0.1** to **9.9**, and cannot be **0**.

Once configured, the reject output will cycle when a weighment is classified as Over or Under, or if a weighing error occurred during the transaction.

2.6.1.3. Checkweigh Application Running

Once the Dyn-570 application is running, each weighment will be accompanied by an on-screen display of its relationship to the target – over, OK and under, as shown at the left of the screens.

Press the Dyn-570 CLOSE softkey  to exit the application.

2.6.2. Photo Eye 3 Configurations

With the Advanced ExpressCheck® firmware, a third photo eye can be configured to perform fatal error counting or provide a delay of data transmission until the package arrives at a point downstream from the scale.

■ Using PE3 will disable the Auto Clear Alarms feature.

2.6.2.1. Using PE3 to Count Fatal Errors

When a fatal error occurs, package weighing is stopped and remains stopped until the problem is resolved. The conveyor system will continue to run and may allow additional packages to pass the scale without being weighed. If PE3 is configured to count errors, every time its beam is broken the IND570dyn increments the fatal error count in the error log. Once the problem that caused the error is cleared, the operator can refer to the error log to see how many downstream packages must be reprocessed.

To enable fatal error package counting, first enable the error log located in setup at **Application > PAC > Error Config**. Next, set **Transmit PE3** in **Application > PAC > System** to 'Errors'.

2.6.2.2. Using PE3 as a Trigger to Transmit Data

There are applications where a package is weighed, but this information isn't needed until the package reaches another station downstream. The IND570dyn will queue up to 99 records in a FIFO fashion, recalling each one in turn as PE3's beam is broken.

To configure the IND570dyn for Transmit PE, first be sure that a communication connection is established. Refer to **Chapter 3, Configuration**, of the **IND570 User's Guide** for details on communication connections. The **Transmit PE3** parameter (at **Application > PAC > System**) must be set to **Transmit**.

The number of packages that can be recorded in the queue depends on the size of each record. The maximum number is 99 divided by the number of demand outputs. With a single demand output, the maximum is 99 packages, but if multiple demand outputs are configured each record will be larger, and fewer packages can be queued. If the limit is exceeded, a fatal error **-9906** will be issued. To avoid this, be sure to limit the number of packages that can accumulate between the scale and PE3.

2.6.3. Transmit Delay

The Advanced ExpressCheck[®] firmware also allows the use of a timed transmit delay. This feature is beneficial in applications that require a delay in the transmission of weight data without the addition of a third photo eye downstream.

To configure Transmit Delay, enter the appropriate delay must be entered in the Transmit Delay field in **Application > PAC > System**. The transmit delay may be set from 0 to 9.9 seconds. A setting of 0 seconds disables the feature.

When enabled, after a package is weighed, any demand outputs are put into a buffer and a timer is set to the configured Transmit Delay Value. When the timer expires, all demand outputs for that transaction are transmitted. The starting trigger for the timer is the completion of the weighment. If another package is weighed before the previous package is transmitted, its associated demand outputs will be queued. Depending on the number of demand outputs, the queue size can be as large as 20.

2.7. Using the Tare Functions

With the exception of Auto Tare, Tare functions are available for use with the Dyn application, but can only be changed or cleared while the IND570 home screen is displaying. When a tare is set, the Dyn-570 will use that tare for all transactions until the application is stopped and the tare is changed or cleared. When operating with a tare, the Net symbol "N" will be displayed above the weight unit on the terminal display.

2.8. Using the ID Prompt Feature

ID Prompts are still available, but can be accessed only by softkey while in the IND570 home screen, or by shared data variable access. ID prompts allow operators to enter information such as lot number, operator name/number, and shift information.

2.9. Clearing Fatal Errors

Both the ExpressWeigh® and ExpressCheck® firmware have an Auto Clear Alarms function. If the downstream photo eye (PE3) is not present, Auto Clear Alarms can be enabled (in setup at **Application > PAC > Alarm Outputs**) to recover from a fatal error automatically.

- **Note:** This option is **not** selectable in ExpressCheck if **Application > PAC > System > Transmit PE** is set to anything but none, or if **Application > PAC > System > Transmit Delay** is not set to zero.

If Auto Clear Alarms is not configured, the Fatal Error must be cleared either by cycling the run permissive, or by exiting and restarting the dynamic application.

Another method to Auto Clear Alarms is to set an unused discrete input to negative true with the assignment set to "Clear Fatal Alarms."

2.10. Packaged I/O and Indicator Lights

The IND9D57 may be ordered with a number of task-specific indicator lights and alarms. The following is a brief explanation of the most common options:

Status	Explanation
Unit Running	This indicator shows that the terminal is actively running the dynamic software and that a run permissive (if configured) is present. If the terminal is in a non-running state such – for example, run permissive is false or a fatal error has occurred – the indicator will be extinguished.
Alarm	This indicator can be configured either as an indicator light or as an audible alarm. It is used to draw attention to a fatal error situation that requires operator intervention. The alarm may be silenced without clearing the fault, if the terminal is equipped with an optional Silence Alarm operator. The alarm will reset once the fault condition has been cleared by one of the following conditions: <ul style="list-style-type: none"> • Auto Clear Alarms is enabled. • The optional run permissive input has been turned off and on. • The dynamic software has been stopped and restarted using the soffkeys.
Scale Empty	This optional indicator is used to monitor when the photoeye logic declares the scale platform empty of packages.
Out of Tolerance [ExpressCheck Only]	This indicator is used to show that a package does not conform to the target established in the active record. The indicator will remain on until the start of the next weighment. Note: This Indicator is a logical 'or' of the over and under outputs.
Over [ExpressCheck Only]	This indicator shows when a weighment exceeds the tolerance defined in the active record for that weighment. The indicator will remain on until the start of the next weighment or until the display timer (set at Application > PAC > Display) expires.

Status	Explanation
Under [ExpressCheck Only]	This indicator shows when a weighment is less than the tolerance defined in the active record for that weighment. The indicator will remain on until the start of the next weighment or until the display timer (set at Application > PAC > Display) expires.
Three Zone Indicator [ExpressCheck Only]	This optional indicator provides Under/OK/Over indication in one package. The light bar mounts horizontally on top of the ExpressCheck terminal enclosure. The appropriate indicator will remain on until the start of the next weighment or until the display timer (set at Application > PAC > Display) expires.

2.10.1. User Inputs

The IND9D57 also allows for two standard user inputs and one custom input:

Input	Explanation
Run Permissive	This is a two-position selector switch. In its ON position, it puts the dynamic software in the running mode. Moving the selector switch to OFF will put the dynamic software into a standby mode. The run permissive is also used to clear fatal alarms.
Silence Alarm	This pushbutton operator will cancel the alarm output to silence an audible alarm. It does not, however, clear the alarm condition.
Clear Fatal Alarm	This pushbutton operator will perform the same task as the Silence Alarm input, but additionally will clear the fault condition and resume running mode without having to clear the scale and wait for a zero weight on the scale platform.

2.11. Tables and Logs

2.11.1. Transaction Table

The transaction table can contain 100,000 records. Because of its size, the transaction table must be saved as a binary file, and cannot be converted to a .csv file prior to FTPing. Once the binary file has been retrieved via FTP, an external utility can be used to convert it into a .csv file. Once exported and converted, the table can be viewed, analyzed and archived. Export requires installation of the IND570 Ethernet/Serial option board – refer to Chapter 5, **Parts and Accessories**.

The transaction log can also be viewed on the terminal or printed, by using the REPORTS softkey.

The transaction table includes the following information for each weighment: date and time, transaction number, package weight, and weight units. In ExpressCheck systems, the target ID and the package weight's relationship to it (under/ok/over) are also recorded.

2.11.1.1. File Conversion Utility

A utility named **convert_log.exe** is provided to convert the exported binary file into a .csv (comma separated values) file, which can be formatted for use in spreadsheet or database programs.

2.11.2. Error Log

If enabled, the error log saves up to 500 errors, assigning each one a sequential number. Each record also includes the transaction counter of the last good weighment, number of errors, error code and time and date.

The transaction counter is incremented only after a successful weighment has occurred, so it is possible for there to be multiple error log entries with the same transaction number if they occurred back to back.

The number of errors is the number of packages that crossed the scale for that particular error. This feature requires the ExpressCheck® application, and a third photoeye must be added to the system and the appropriate parameter set in the configuration. Non-fatal errors are always a count of 1. If a fatal error occurs, the log will update the current record in the error log with the number of packages that break the optional third photoeye.

For instance, if a package hangs up on the scale and causes a long weigh time error (-9905), then breaks free and allows n subsequent packages to cross, the system will remain in an error state with the entry and exit photoeyes disabled. No valid transaction data will be captured until the error is cleared. However, the third photoeye will count the n additional packages. The record in the error log would show $n+1$ as the number of errors in that particular error record, indicating that a total of $n+1$ packages must be reprocessed once the error is cleared.

Note that, due to the nature of fatal errors, an exact count of faulted packages is sometimes not possible. This count should be used as a reference only.

For a complete account of error codes, refer to Chapter 4, **Service and Maintenance**. Once 500 errors have been recorded, the log begins to over-write the oldest records. The log can be downloaded from the terminal via an ftp connection, which requires the installation of an optional Ethernet/Serial board – refer to Chapter 5, **Parts and Accessories**.

2.11.3. Dynamic Target Table

The Dynamic Target Table is used only in ExpressCheck weighing mode. It is accessible from the home page if the TARGET TABLE softkey  is assigned, and through setup at **Application > PAC > Dyn Target Table**. Once accessed, the table can be modified and printed – refer to Chapter 3, **Configuration**. For general information about table searches and reports, refer to Appendix B, **Table and Log File Structure**, of the **IND570 User's Guide**.

The Dyn Target Table contains the weighment information, and also allows the user to accumulate basic statistics. When the Table is accessed by pressing the REPORTS softkey , the following information is available for each record:

- Dyn Target Table ID
- Accumulated weight of all in-tolerance weighments
- Target description
- Reject output delay
- Target weight
- Reject output duration
- Maximum weight recorded for this ID
- Positive tolerance
- Minimum weight recorded for this ID
- Negative tolerance
- Number of weighments below tolerance
- Number of weighments within tolerance

- Target weight units
- Number of weighments above tolerance

To clear the statistics, press the C* softkey under the reports softkey. A dialog box will appear, asking for confirmation before clearing numbers and totals. To clear all numbers, totals, max, min, under counts and over counts from all records in the Dyn Target Table, select OK; otherwise, press the exit key  to leave the reports screen.



3 Configuration

3.1. Overview

This chapter provides information about how to configure the Dyn-570 application. It describes access to the setup mode, where functions can be enabled, disabled, or defined by entering parameter values in specific setup screens.

3.2. Entering and Exiting Setup Mode

3.2.1. Entering Setup Mode

Terminal configuration is accessed by the SETUP softkey . If security has not been enabled, pressing this softkey will provide direct access to the setup menu tree. If password security has been enabled, pressing the softkey displays a login screen where the operator must enter a valid user name and password in order to access setup. (Refer to the Security section in Chapter 2 of the **IND570 User's Guide** for further information about password setup and security.) When the login screen is shown, it is possible to exit back to the home screen without entering any login information by pressing the ESCAPE softkey .

3.2.2. Exiting Setup Mode

To exit the setup mode, select Home from the setup menu tree and press ENTER. The default IND570 home screen displays.

As an alternative, press the first (left-most) softkey any time the menu tree is displayed to exit the menu tree.

3.2.3. IND570dyn Setup Menu Tree

The terminal's setup menu includes all the elements and functionality of the default configuration (detailed in Chapter 3 of the **IND570 User's Guide, Configuration**), together with some additional or modified screens. Figure 3-1 shows the tree with new or modified leaf nodes (in the Application, Terminal and Communication branches of the tree) expanded and colored red. The Dyn Target Table, indicated in bold, is accessible only with the ExpressCheck version of the Dyn-570 application. Unchanged branches are not expanded. The functions and parameters of each of the affected screens are detailed in the Configuration Options section, immediately below.

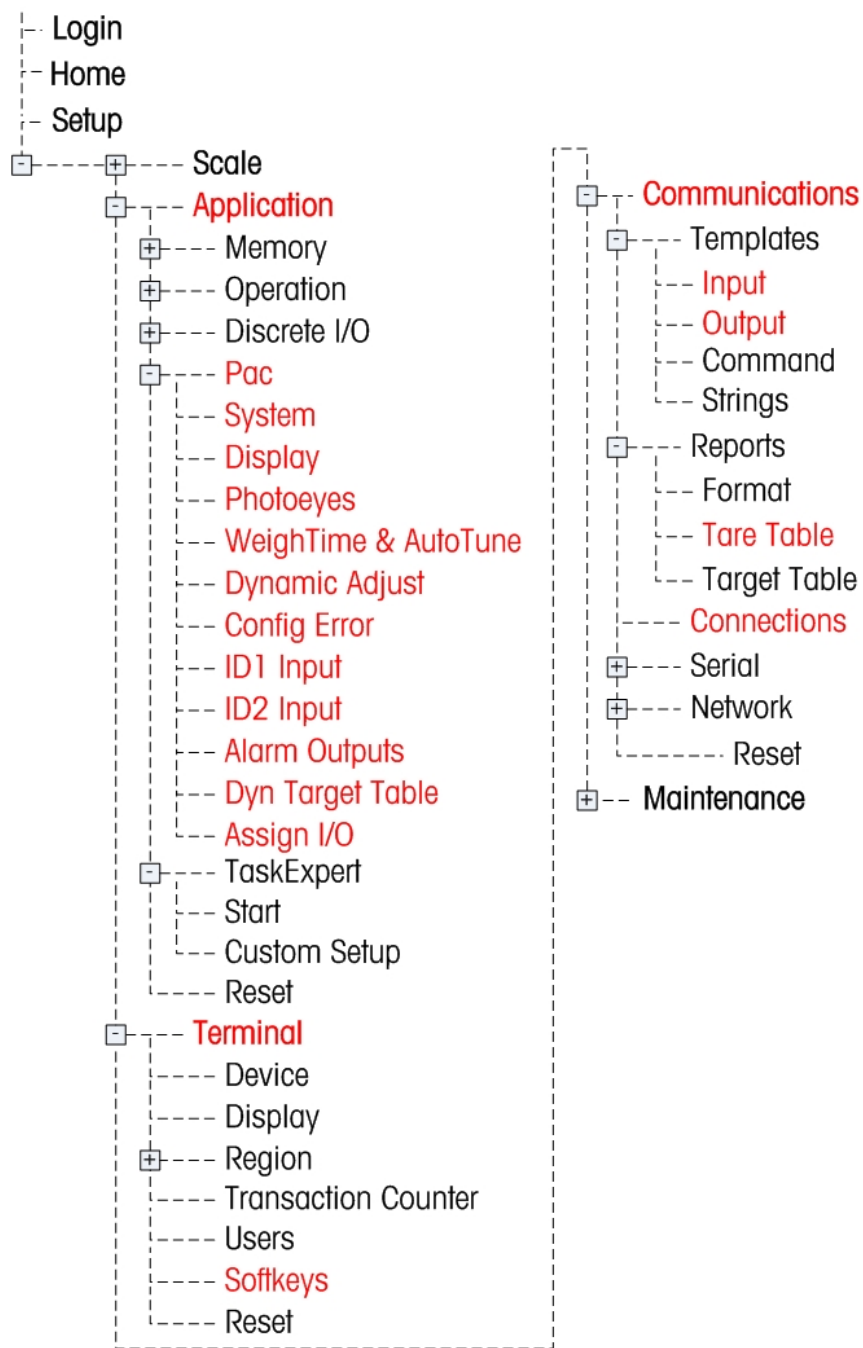

Figure 3-1: IND570 Menu Tree: Branches and Pages Specific to Dyn-570

3.3. Configuration Options

■ In the sections below, default values are indicated with an asterisk (*).

3.3.1. General Setup

3.3.1.1. Scale > Capacity & Increment

■ Note that multiple range and multi-interval operation are not supported in Dyn-570.

3.3.1.2. Terminal > Display

It is recommended that a screen saver be configured here.

3.3.1.3. Terminal > Softkeys

In order to start the Dyn-570 software from the front panel, a softkey must be assigned. Add a softkey to any of the home screen softkey locations, selecting **Dynamic Start** as its assignment.

3.3.1.4. Application > Memory > Alibi

If a transaction log is required, it must be enabled from this screen. Select **Transaction Log** from the pull down list for Alibi Memory.

■ **Important:** By default, the Transaction Log and the Error Log (**Application > PAC > Error Config**) are **disabled**. If either type of record is required, they **must** be enabled in setup.

■ The Alibi Memory selection cannot be used when running the IND570Dyn software.

3.3.1.5. Application > Memory > Target Table

When using the IND570Dyn as a checkweigher, Over/Under mode must be selected. This parameter is automatically changed to Over/Under when the system is configured as a checkweigher in **Application > PAC > System**. With Over/Under mode selected, the tolerance type can be set to Target Deviation or % of Target.

■ Do not change the tolerance type if there are records in the Dyn Target Table, as the contents of the table will not be converted from deviation to percentage, or vice versa.

3.3.1.6. Application > Operation > Target

If the IND570Dyn is configured as a checkweigher, the Source must be AVG WT. This parameter is automatically changed to AVG WT when the system is configured as a checkweigher in **Application > PAC > System**. It is also important to ensure that motion check is disabled, because the firmware is designed to weigh items using an unstable scale base.

3.3.1.7. Application > Discrete I/O

This menu branch is where discrete inputs and outputs are assigned.

3.3.1.7.1. Inputs

The following table shows the default inputs configuration for the IND570Dyn:

Address	Polarity	Assignment
0.1.3	+	Run Permissive
0.1.4	+	Silence Alarm

Inputs 1 and 2 are dedicated photo eye inputs, and are not configurable.

Run Permissive is used to allow the Dyn application to switch between running and standby states. If run permissive is configured, there must be a logical true input to allow the Dyn application to get from standby to running. This can be accomplished by assigning the polarity of the input to "+". If there is no need for run permissive in the system, the input can be deleted from the list.

Silence Alarm is used to cancel the Alarm outputs and thus quiet an audible alarm. The input silences the output, but does not cause the control to clear the fault.

Other inputs provided by the Dyn Pac

- Clear Fatal Alarm** This input will cause an error condition to be cleared immediately without the need for the run permissive to be cycled or the Dyn application stopped. In addition, it does not require the scale to be empty or the photo eyes to be clear.
- Photo eye 3** This is the third photo eye, available in the Advanced Pac. It can be configured for remote transmission of data, or to count the number of packages that cross the scale during a fatal error.

For other available input options, refer to the **IND570 User's Guide**.

3.3.1.7.2. Outputs

The following table shows the default output configuration for the IND570dyn:

Address	Assignment
0.1.1	Running
0.1.2	Scale Empty
0.1.3	Weigh Complete
0.1.4	Alarm: Fatal
0.1.5	Alarm: Non-Fatal
0.1.6	Unassigned

The assignments function as follows:

- Running** Indicates that the Dynamic application is running, the run permissive is true, and the scale was zeroed at least once.
- Scale Empty** Indicates that the photo eye logic declares the scale platform free of packages. This does not indicate that the scale is at zero.
- Weigh Complete** A momentary toggle that can be used to notify a PLC that new weighment data is available. This output is asserted whether the transaction was good or in error.
- Alarm : Fatal** An indication that a fatal error has occurred. This output will remain on until one of the following has occurred:

1. The run permissive has been turned off.
2. The Dyn application has been stopped
3. The Silence Alarm input has been asserted
4. The Clear Fatal Error input has been asserted
5. AutoClear errors has been enabled, the scale is at zero weight and the photo eyes are clear of packages

Alarm : Non-Fatal A momentary output that is turned on when a non-fatal error occurs during a weighment. The timing is based on the duration set at **Application > PAC > Display > Display Time**.

■ **Note:** If the Display time is set to 0, the alarm: non-fatal output will be asserted until the next weighment ends.

Other Outputs provided by Dyn-570:

Dynamic OK A momentary output that indicates that the last weighment was within the tolerance defined by the active record. The duration of this output is controlled by the Display Time parameter at **Application > PAC > Display**. This output is only used by the advanced PAC in checkweigh mode, or another package weighment is complete.

Dynamic Over A momentary output that indicates that the last weighment was over the tolerance defined by the active record. The duration of this output is controlled by the Display Time parameter at **Application > PAC > Display**. This output is only used in the advanced PAC in checkweigh mode or another package weighment is complete.

Dynamic Under A momentary output that indicates that the last weighment was under the tolerance defined by the active record. The duration of this output is controlled by the Display Time parameter at **Application > PAC > Display**. This output is only used in the advanced PAC in checkweigh mode or another package weighment is complete.

ID1 Updated A momentary output that indicates that ID1 received new data from its configured communication connection. The timing is not associated with the Display Time parameter.

ID2 Updated A momentary output that indicates that ID2 received new data from its configured communication connection. The timing is not associated with the Display Time parameter.

Reject Output With the Advanced version of the application in checkweigh mode, this output is activated when a weighment is out of the tolerance. The delay from the end of the weighment and duration are configured at **Application > PAC > Dyn Target Table** menu branch.

For other output options that come standard with the IND570, refer to the **IND570 User's Guide**.

3.3.2. Application > PAC: Basic Functionality

3.3.2.1. System

Settings available in this screen are:

System Type Checkweigh, Random – PE*
 Checkweigh – Uses photo-eyes for three-zone checkweighing mode.
 Random – PE – Uses photo-eyes in random package weighing mode.

Transmit PE3	Disabled*, Errors, Transmit If Random – PE or Checkweigh type, choose option for transmit when using PE3 (Photoeye 3)
Transmit Delay	0* seconds Sets a time delay before the terminal will transmit weight data
Reject If Type = Checkweigh	Disabled*, Enabled Only for Checkweigh type, enable if using a reject ram.
Port [If Type = Random - PE]	Permits selection of an available serial port to which the source of the ASCII input is connected.

3.3.2.2.

Display

Settings and functions available in this screen are:

Display Time	0* - 9.9 secs. Time for which processed weight is displayed on the IND570dyn terminal after weighment is completed. Once Display Time elapses, current live weight is displayed. If set to 0, processed weight will be displayed until next weighment is complete, and live weight display is suppressed.
Display Info	ID1, ID2, Literal*, Target Desc, target value., Transaction Sets the information that is displayed in the bottom line of the display once a weighment is completed. ID1/ID2 – Terminal’s first and second ID inputs. Only available if System Type = Random PE . Literal – The string entered in Display Literal , below. Target Desc – The description associated with the current target Target Value – The weight value associated with the current target Transaction – The IND570dyn assigns a transaction number to each weighment.
Display Literal [If Display Info = Literal]	“Processed Weight”* 20 character alphanumeric string entered by operator, to be displayed when Literal is selected from Display Info .

3.3.2.3.

Photo-eyes

This branch of the setup tree is available only when **Random PE** or **Checkweigh** is selected in **System I Type**. Settings available in this screen are:

PE 1 Timer	150 mS* Sets the time during which the first Photo-eye’s beam must be broken to establish that a package has entered the scale. Ensures that brief interruptions are not misinterpreted as packages. Range is 25-999 mS.
PE 2 Timer	50 mS* Sets the time during which the second Photo-eye’s beam must remain broken to establish that the package has begun to leave the scale. Ensures that brief interruptions are not misinterpreted as packages. Range is 25-999 mS.

PE1 to PE2 Timer	3 Sec*	Sets the maximum amount of time a package is allowed to be on the scale, measured from when PE1's beam is unbroken after entry to when PE2's beam is broken. This measurement is used to detect packages that may be stalled on the scale. Range is 0.0-9.9 seconds. A setting of 0.0 seconds will disable this check.
PE1 and PE2 Maximum	5 Sec*	Sets the maximum amount of time either Photo-eye's beam can remain broken (i.e. interrupted by a package) before an error is generated. Range is 0.0-9.9 seconds. A setting of 0.0 seconds will disable this check.

3.3.2.4. Weigh Time & AutoTune

Weigh Time & AutoTune permit the establishment of optimum data acquisition time as packages pass over the scale.

Settings and functions available in this screen are:

Weigh Time	300 mS*, 100-999 mS Field for manual entry of time value. ■ For NTEP approval, this value must be 300 mS or above.
START 	On-screen message reads "Press START to Begin AutoTune Sequence" – a sequence of prompts defining the procedure to set the Weigh Time parameter automatically.

The AutoTune sequence requires the operator to run the longest package to be weighed across the scale. The Dyn-570 application calculates the optimum weighing time and updates the **Weigh Time** parameter accordingly. If the test package produces a value below 150 mS, an error is displayed and the existing value is kept.

- **Tip:** When running AutoTune, it is advisable to subtract 50mS from the indicated time from the test. This will take into account timing errors caused by situations such as packages that are not perfectly parallel to the conveyor. A -9910 error could result from a weigh time specification that is too tight.

3.3.2.5. Dynamic Adjust

Dynamic Adjust is another self-tuning feature. It is designed to compensate for weight offsets caused by rapid conveyor operation. Its use is not recommended for conveyor speeds below 200 fpm (feet per minute).

Settings and functions available in this screen are:

Dynamic Adjust	Disabled*, Enabled If Enabled, on-screen message appears: "Press START to Begin Dynamic Adjustment"
START 	Starts the Dynamic Adjust process.

The Dynamic Adjust sequence requires the operator to the longest and the shortest package sizes across the scale five times. Time statistics are gathered during this process, after which corrections factors are calculated for the range of package sizes.

When the START  softkey is pressed, the operator is prompted to run the longest package 5 times, then the shortest package 5 times, then to stop the conveyor and weigh the longest and shortest packages in turn. Once this process is complete, the Dyn-570 application displays the Dynamic Adjust calculations and statistics that it will use to calculate the correction factor.

3.3.2.6. Error Config

This screen controls the way errors appear in the transmitted output of the transaction – either in the form of an error code, or as a customized string.

Log Errors	<p>Disabled*, Enabled</p> <p>If Enabled, the IND570dyn will store the most recent 500 errors in an ftp-accessible (FIFO) error log.</p>
Send Error Code	<p>Disabled*, Enabled</p> <p>If Enabled, when an error occurs during a transaction the error code is transmitted in place of the processed weight data. For detailed information about error codes, refer to Chapter 4.0, Service and Maintenance. Note that when an error code is transmitted, the placement of the decimal point will be preserved – e.g., error -9910 will be sent as -99.10 lb. The addition of the minus sign indicates that the transmission is an error code and not a weighment.</p> <p>If Disabled, when an error occurs during a transaction the text defined in Error String is transmitted in place of the processed weight data.</p>
Error String [When Send Error Code = Disabled]	<p><Empty>*</p> <p>Defines the text (maximum 8 characters) to be sent in place of processed weight data when an error occurs.</p> <p>If Send Error Codes is disabled, it is recommended that an Error String be defined, to make it clear that an error has occurred. Otherwise, only a blank string is sent in the event of an error.</p>

3.3.2.7. ID1 and ID2 Inputs

The ID1 and ID2 input options are identical. For convenience, the functions and parameters described here refer to ID1. For ID inputs from bar code scanners, package dimensioners, and other external equipment, the Ethernet/Serial option board must be installed – refer to Chapter 5, **Parts and Accessories**.

These inputs are used by the Display options (above, on page 3-6) and in output templates – refer to the **Templates** section of Appendix B, **Default Settings**.

Data Type	<p>None*, ID1 <i>or</i> ID2, DYN Target ID [if ID2]</p> <p>None – ID1 not used.</p> <p>ID1 – the ID1 input will be used as a label available for output templates and display options. For external ID input, a connection must be configured in setup at Communication > Connections.</p> <p>DYN Target ID – The ID of the current target</p>
------------------	--

1st Character [If Data Type ≠ None]	<p>1*. Numeric string</p> <p>Defines the position in the input string that defines the beginning of the ID1 string. e.g. In “*Hello World*”, if 1st Character = 1, then ID1 begins with “*”. If 1st Character = 2, then ID1 begins with “H”.</p> <p>The first character must be between 1 and 40 characters from the start of the input string.</p>
Length [If Data Type ≠ None]	<p>1-40 characters. 20*</p> <p>Defines maximum length of ID1 captured from the input string.</p> <p>For example, if the string “*The hounds of spring are on winter’s traces*” is input, 1st Character = 2 and Length = 20, then ID1 would be captured as “The hounds of spring”.</p>
Mode [If Data Type ≠ None]	<p>Use Last*, Delete/Fill, Required/Fill</p> <p>Use Last – All transactions after the first input string will use the same ID1, until a new input string is received.</p> <p>Delete/Fill – If no new string is input before the end of the transaction, the ID1 string is filled with a Fill Character, defined below.</p> <p>Required/Fill – If no new string is input before the end of the transaction, the ID1 string is filled with a Fill Character, defined below. In this case, a non-fatal error is reported for the transaction.</p>
Termination Character	<p><CR>*, other standard control characters</p> <p>If the termination character is received in the input string, the ID1 capture is terminated before the configured Length (see above).</p>
Fill Character [If Mode ≠ Use Last]	<p>This character is repeated 1 to 40 times, as defined in Length, and entered as the default ID1, if Mode is not None, and no string is input before the end of the transaction.</p>

3.3.2.8. Alarm Outputs

The Alarm Output settings control the IND570dyn’s behavior when alarms are generated. These options are available only once the system is correctly configured to output alarms, in setup at **Application > Discrete I/O > Outputs**.

Refer to the Alarms section of Chapter 4, **Service and Maintenance**, for an interpretation of fatal and non-fatal alarms.

Fatal Alarm Output	<p>Disabled*, Enabled</p> <p>Enabled – Permits the occurrence of a fatal alarm to turn on a digital output (e.g. to an indicator light). A digital output must be assigned to this function in setup at Application > Discrete I/O > Outputs.</p>
Non-Fatal Alarm Output	<p>Disabled*, Enabled</p> <p>Enabled – Permits the occurrence of a non-fatal alarm to turn on a digital output (e.g. to an indicator light). A digital output must be assigned to this function in setup at Application > Discrete I/O > Outputs.</p>
Auto-clear Alarms	<p>Disabled*, Enabled</p> <p>Enabled – Alarms will be cleared automatically when the scale returns to zero and both photo-eyes are clear.</p>

3.3.2.9. DYN TARGET SEARCH

This screen opens a standard search dialog which can be used to search the Dyn Target Table by Field, Operator (=, >=, >, <>, < <=) and a data string.

3.3.2.10. Assign I/O

This screen displays a message:

WARNING! All I/O mapped to Dynamic Functions
Continue?

Touch the OK  softkey to reset the Discrete I/O assignments to their Dyn-570 defaults, or touch the ESC softkey to return to the menu tree without performing the reset. Note that this function resets only local IND570 ports; ARM100 ports must be reset separately.

- The Assign I/O feature automatically assigns the **NonFatal** and **Fatal Error** outputs to LOCAL OUT4 and LOCAL OUT5.

Assign I/O only works when a 5/8 I/O card is installed. If your system uses a 2/5 I/O card with an ARM100, I/O must be set up with the assignments noted in Table 3-1.

Table 3-1: Discrete I/O Default Values for 5/8 I/O Card

Input/Output	IND570 controller I/O
Photo eye 1 (entrance)	LOCAL IN 1
Photo eye 2 (exit)	LOCAL IN 2
Run Permissive	LOCAL IN 3
Silence Alarm	LOCAL IN 4
Local INS	Not assigned
Running Output	LOCAL OUT 1
Scale Empty	LOCAL OUT 2
Weighment Complete	LOCAL OUT 3
Alarm: Fatal Output	LOCAL OUT4
Alarm: Non-Fatal Output	LOCAL OUT5
Available for Reject Output (user selected)	LOCAL OUT 6
	LOCAL OUT 7
	LOCAL OUT 8

Table 3-2: Discrete I/O Default Values for 2/5 I/O Card with ARM100

Input/Output	IND570 controller I/O
PE1	LOCAL IN 1
PE2	LOCAL IN2
Running	LOCAL OUT 1

Input/Output	IND570 controller I/O
Scale Empty	LOCAL OUT 2
Weighment Complete	LOCAL OUT 3
Alarm Fatal Output	LOCAL OUT 4
Alarm Non-Fatal Output	LOCAL OUT 5
In/Out	ARM100
Run Permissive	REMOTE IN 1
Silence Alarm	REMOTE IN 2
User-assigned	REMOTE IN 3
User-assigned	REMOTE IN 4
Reject Out	REMOTE OUT 1
User selectable	REMOTE OUT 2
User selectable	REMOTE OUT 3
User selectable	REMOTE OUT 4
User selectable	REMOTE OUT 5
User selectable	REMOTE OUT 6

3.3.3. Application > PAC: ExpressCheck® (Advanced) Functionality

This section details configuration options available only in the advanced (ExpressCheck®) version of the IND570dyn. Only ExpressCheck-specific options are included here; for basic (ExpressWeigh®) functionality, refer to the section beginning on page 3-3.

3.3.3.1. System

Advanced settings available in this screen are:

System Type	Random PE*, Checkweigh Random PE – Uses photo-eyes in random package weighing mode. Checkweigh – Selects CheckWeigh™ mode, using photo-eyes, targets and tolerances.
PE3 [If Type = Random PE]	None*, Error, Transmit Error – The terminal will count the number of times the photo eye is broken to produce a record of the number of packages that crossed the scale during the fatal error condition. Transmit – Information from the transaction is not transmitted until Photo-eye 3, downstream, is broken. Up to 99 transactions are stored in a temporary table, to be retrieved (FIFO) when Photo-eye 3 is broken. Exceeding 99 entries in the temporary table will generate a fatal error.
Transmit Delay	0*-9.9 secs. Sets time delay between end of transaction and transmission of output. 0 sets no delay.

3.3.3.2. Display

The following additional options are available in the advanced version:

Display Info	ID1, ID2, Literal*, Target Desc, Target Value, Transaction Sets the information that is displayed in the bottom line of the display once a weighment is completed. ID1/ID2 – Terminal's first and second ID inputs. Only available if System Type = Random PE . Literal – The string entered in Display Literal , below. Target Desc – The string assigned to the current active records description field in the Dyn Target Table Target Value – This is the target weight value of the transaction's active record Transaction – the IND570dyn assigns a transaction number to each weighment. Only available if System Type = Random PE or Checkweigh .
---------------------	---

3.3.3.3. ID1 Input

Advanced settings available in this screen are:

Data Type	None*, ID1, Dyn Target ID Target ID – If System Type = Checkweigh , and the Dyn Target Table is being used, the input ID1 can be used as a look-up for the target record of the current transaction. In this case, the ID string must be numeric and limited to 8 digits.
------------------	---

3.3.3.4. Dynamic Target Table

This table is only available in the ExpressCheck Dyn-570. It stores up to 500 records of target data used by the Checkweighing function.

The initial setup screen offers the usual table search parameters, and a VIEW TABLE softkey . Pressing this softkey opens the DYN TABLE VIEW screen, from which it is possible to edit, add and delete target records, and to print the view – either the entire table, or the sub-set of it defined by the search parameters.

The table includes columns for ID, Description, Target value, Target units, positive and negative Tolerances, n (number of times the target has been used), Total (sum of weighments made using this target), Reject Delay and Reject Duration.

- The units used in the Dyn Target Table must match the units configured at **Scale > Capacity & Increment > Primary Units**, and **Scale > Units > Second Unit and Third Unit**. If they do not match, a pop-up box stating "Unit Mismatch" will be displayed and the record will not be selected from the Dynamic Target Table.
- Any changes to the Dyn Target Table must be configured on an active ID by choosing the ID again with the Target Table softkey.

3.3.3.4.1. Reject Timer

Reject Delay and Reject Duration set the delay before the Reject Output (over or under) is activated on the configured discrete output, and the duration of the activated output, respectively. For the

Reject output to work, the delay and duration must both be non-zero. Also, be sure to set a discrete output as "Reject Output."

3.3.4. Communication

3.3.4.1. PLC Options

The IND570dyn and IND9D57 terminals can be equipped with one of an array of PLC interfaces, to facilitate communication with the application. These include:

A-B RIO PROFIBUS L2 DP DeviceNet

Refer to the **IND570 PLC Interface Manual** for details about these options and their installation and configuration.

3.3.4.2. Connections

- | | |
|----------------------------|---|
| Demand Output | Demand output is the same as in the IND570, except for a new trigger selection: Avg. Wt. (Average Weight). This allows the scale to output the information using the selected output template when an in-motion weighment is complete. Avg. Wt. must be selected to trigger the demand output based on the Dyn-570 application. |
| Reports | Configuring the IND570dyn/IND9D57 to print reports is the same as in the IND570. The Dyn Target Table, Error Log, Tare Table, and Transaction Log may be viewed and/or printed. The Target Table are shown as options, but are not used in the Dyn-570 application. |
| ASCII Input | This connection can be used to capture ASCII characters from a communication channel for use as a command. Refer to the IND570 Technical Manual for a more complete account of this function. |
| Input ID1/Input ID2 | This allows a communication channel to provide a string that can be parsed into the ID string (1 or 2 respectively) used by the Dyn-570 software. |
| Input ID1 & ID2 | This allows a single communication channel to allow information for both ID1 and ID2 to come in one a single communication channel at one time. ID1 and ID2 are configured in setup at Application > PAC > ID1 / ID2. |

4 Service and Maintenance

This chapter provides troubleshooting procedures and detailed information about error codes and messages for the Dyn-570 application.

4.1. Error Codes and Error Messages

4.1.1. Error Codes and Responses

- Note that the -99xx error codes listed below are displayed/transmitted only, and are not added to the terminal's Error Log.

Code	Type	Interpretation	Cause	Response
-9901	Fatal	Max weigh time exceeded	The PE1 to PE2 time exceeds value set at Application > PAC > Photoeyes > PE1 to PE2 Timer	Input a 'clear fatal alarm' to reset, and clear package to return scale to zero
-9902	Fatal	Spacing error	Terminal detects that more than one packages is on the scale	Input a 'clear fatal alarm' to reset, and clear package to return scale to zero
-9903	Fatal	Weight of package less than zero	Problem with scale base	Check scale and scale connection
-9904	Fatal	New weightment print requested before previous print request completed	Printer not keeping up with data stream	Increase time between weightments
-9905	Fatal	PE1 or PE2 blocked longer than values set at Application > PAC > Photoeyes > PE1 and PE2 Maximum	Indicates a package is stuck on entrance or exit photo eye	Clear package
-9906	Fatal	PE3 Transmit Queue Overflow	More than 99 weightments are queued	PE3 failure, Length of conveyor between scale and PE3 allows too many packages
-9910	Non-fatal	Short weigh time	Package is too long to acquire an accurate measurement at the current belt speed	Reduce belt speed. Ensure packages conform to maximum length. Run Dynamic Adjust utility again
-9911	Non-fatal	Scale overload	Package too heavy	Ensure package weights are within scale capacity
-9912	Non-fatal	No ID when in required/fill ID mode	No ID entry made	Ensure data source for ID is connected and working properly

Code	Type	Interpretation	Cause	Response
-9913	Non-fatal	Invalid ID when in Required/Fill ID mode	ID received prior to or during weighment does not match an entry in the Dynamic Target Table	Ensure that the Dynamic Target Table contains the ID of the item being checkweighed

4.1.2. Error Messages

Message	Interpretation
Invalid parameter	This can occur when in checkweigher mode and there is no current record loaded.
No Demand Output	A demand print connection has been created, but the trigger is set for something other than Avg. Wt.

4.1.3. Pop Up Message Box Errors

Message	Interpretation
ID>0	An attempt was made to save a record with a null (blank) ID into the Dyn Target Table. Make sure the ID for the target record has at least one unique character.
Record Already exists	An attempt was made to save a record with a duplicate ID into the Dyn Target Table. Make sure target has a unique ID.
Application Key Fault	iButton has been removed, changed or damaged
Line 0: Application failed to start	TE program has been corrupted or deleted from flash memory. Consult customer service.

5 Parts and Accessories

This chapter lists parts and accessories that may be ordered from METTLER TOLEDO for the IND570dyn and IND9D57 terminals.

Part Description	Part Number
Spare Parts KOP, IND9D57	30394504
24VDC DIN rail mount power supply, 2A	64066179
Pack of 5 fuses, 3A, 250V	64084737

5.1.1. ARM100 Remote I/O Relay Module



Part Description	Part Number
ARM100 Module	71209352

5.1.2. Ethernet TCP/IP Interface

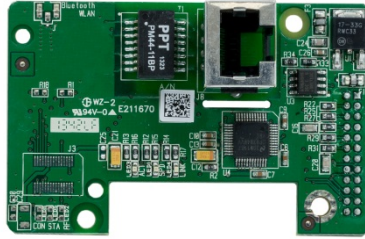

Part Description	Part No.
Ethernet TCP/IP option	30113538

5.1.3. EtherNet/IP – Modbus TCP PLC Interface

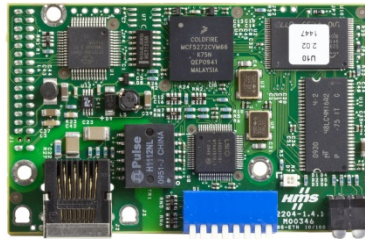

Part Description	Part No.
EtherNet/IP – Modbus TCP option	30116112

5.1.4. PROFIBUS, Harsh Enclosure

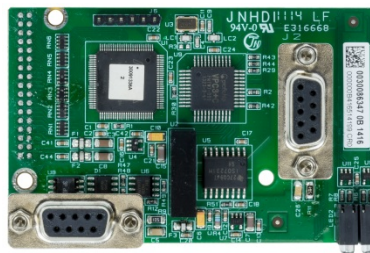

Part Description	Part No.
PROFIBUS, harsh enclosure option	30113590

5.1.5. PROFIBUS, Panel Enclosure

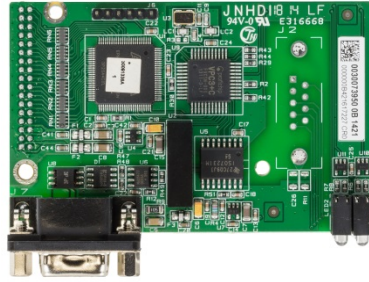

Part Description	Part No.
PROFIBUS, panel-mount enclosure option	30113589

5.1.6. PROFINET PLC Interface

This option is not available for the IND570xx.

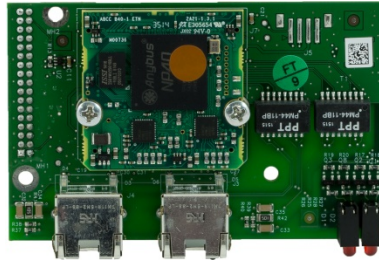

Part Description	Part No.
PROFINET option	30260484

5.1.7. DIO, Relay, 5 Inputs, 8 Outputs

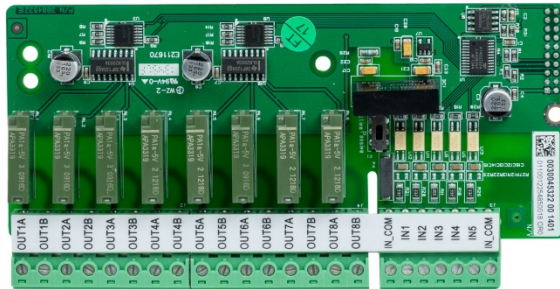

Part Description	Part No.
DIO - 5 inputs, 8 outputs, relay option	30113540

5.1.8. COM2/COM3/DIO, Relay, 2 Inputs, 5 Outputs

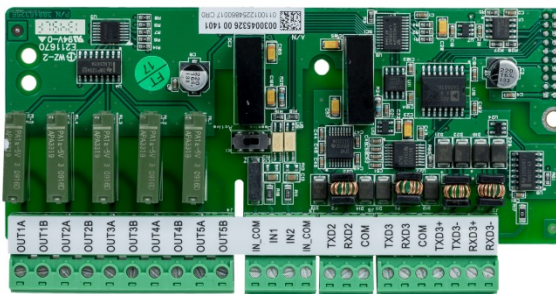

Part Description	Part No.
COM2/COM3/DIO (2 inputs, 5 outputs, relay) option	30113542

A. Installation

A.1. Special Software Requirements

A.1.1. Firmware Version

The Dyn-570 application was created using TaskExpert™. To run a TaskExpert application, the IND570 **must** have version 2.00.0036 firmware or higher installed.

A.2. Installation Notes

If a complete IND570dyn terminal is ordered, all files required to run the Dyn application will be loaded during production and this chapter can be skipped. If the Dyn-570 application is ordered as a separate kit, the Dyn-570 application files must be loaded to the terminal before the application can run.

The required files can be downloaded from www.mt.com/IND570.

A.2.1. Installation Method

The following procedure outlines installation of the Dyn-570 application files.

A.2.1.1. Loading via USB

1. Make certain that the USB port has been enabled for both read and write functions in setup at **Communication > Access/Security > USB**.
2. Transfer the files downloaded from www.mt.com/IND570 to a USB flash drive in a TaskExpert folder with the following path. The folders **must** be named exactly as shown:
(USB drive) \ IND570 \ (SN of terminal) \ TaskExpert
3. Insert the USB flash drive into the IND570 USB port.
4. Enter setup and navigate to **Maintenance > Run > Restore from USB**.
5. Select TaskExpert from the Restore selection box.
6. Press the START softkey  to begin the loading process.
7. When all files have been loaded, a message will be shown indicating a successful restore.
8. Exit setup and remove the USB flash drive.
9. The application is now ready for programming.

A.2.1.2. Loading via FTP or Serial File Transfer

The application files can also be loaded via FTP through the optional Ethernet port, or by serial file transfer through the COM1 serial port. Refer to Appendix C, **Communication**, in the **IND570 User's Guide** for details on transferring files to the IND570 via FTP or serial file transfer.

A.3. Mounting the Packaged Enclosure

The IND9D57 is designed to mount on a flat surface, either vertically or horizontally. The hardware to mount the terminal to its mounting surface is not included with the terminal and must be supplied locally. Ensure that the mounting hardware is capable of supporting the weight of the terminal which is approximately 40 lb (18 kg).

Use the enclosure assembly as a template to mark the position of the mounting holes on the mounting surface. Once the hole positions are established, drill holes in the mounting surface that are suitable for the type of mounting hardware involved in the application. Then, using the locally supplied mounting hardware, secure the enclosure to the mounting surface.

A.4. Installing Cables and Connectors

A.4.1. Provided Cable Glands

Figure A-1 shows a typical arrangement of cable glands for a packaged IND570dyn, and the intended purpose of each.

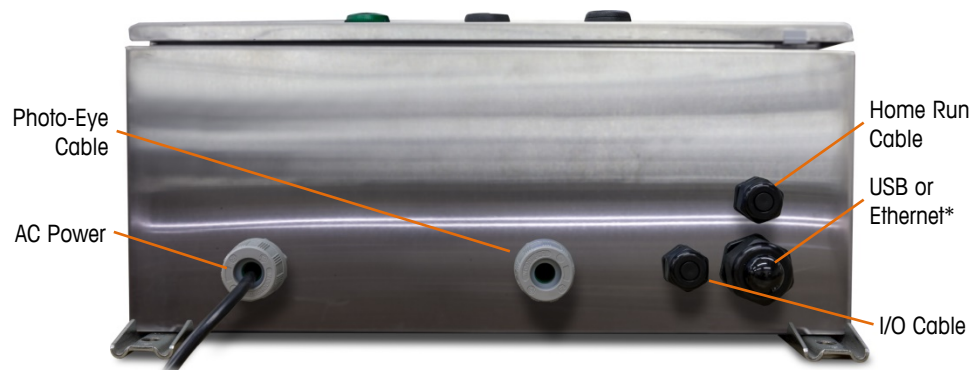

Figure A-1: IND570dyn Cable Glands

* Note that the split grommet needed for the USB or Ethernet cable gland will be included with the documentation package shipped with the unit.

A.4.2. Wiring Connections for Instrument Power

All IND9D57 configurations come with provisions to provide power to the IND570 terminal and the 24 VDC power supply. Wire terminals for the unit's power power will always be labeled L, N and GND.

- L is for line, live or hot

- N is for neutral
- GND is for the equipment grounding conductor or the protective earth (PE) connection

For best system performance, instrument power must be connected to a clean, dedicated AC branch circuit. Avoid running power lines in a conduit that also carries lines to “noisy” AC equipment such as motors, welders and solenoids.

L is fused with a 3.15 A, 250 VAC slow blow fuse. Once L has been fused, the label is changed to 1A to denote that the circuit is protected.

For best performance, do not add any other AC loads to the Instrument Power.

A.4.3. Wiring Connections for Digital I/O Options

A.4.3.1. 24 VDC Inputs and Outputs

The unit is supplied with 4 wire terminals allowing for the attachment of the input photoeyes. These wire terminals are labeled 24V, 0V, I-1, and I-2. The 24V and 0V connections allow for providing 24 VDC power to the photoeyes, and the I-1 and I-2 connections are the input signal lines.

For units that have the ExpressCheck or Dynamic Advanced software, a wire terminal is provided to connect the output for a reject mechanism. This wire terminal will always be labeled REJ.

A.4.3.2. Line Voltage Outputs

As with units using 24 VDC outputs, units using line voltage outputs that also have the ExpressCheck or Dynamic Advanced software will be provided with a wire terminal labeled REJ for connecting the output to control a reject mechanism.

A.4.3.3. ARM100 Connections

When an optional ARM100 is ordered with the unit, the I/O points will connect directly at the ARM100 terminals. Refer to the **ARM100 Technical Manual** for further details.

A.5. Closing the Enclosure

To ensure that the IND9D57 provides continuous protection against the ingress of moisture and dust, be sure the following steps are taken:

1. Ensure cord grips are appropriate for the outer diameter of the cable used. If there is too much gap, replace the cord grip with an appropriate grip range.
2. If a cord grip is not being used, be sure to install a plug to prevent debris from entering the enclosure.
3. When adding cable entrances, avoid placing them in the top surface of the enclosure. Whenever possible, the bottom of the enclosure is the preferred location for cable entrances. Sides are the next best choice.
4. Be sure that the quarter-turn latch is completely engaged when the enclosure door is closed. Watch for field-installed cabling getting caught in the door gasket. This can cause damage to

the wire and will also produce gaps in the seal that allow moisture and debris into the enclosure.

B Default Settings

B.1. Setup Parameters

Table B-1 lists default values for all settings that are specific to the IND560dyn, or that differ from those for the standard IND570. Default settings for IND560 basic functionality are listed in Appendix A, **Default Settings**, of the **IND570 User's Guide**. As noted in the table below, some settings are available only in the advanced (ExpressCheck[®]) version of the application.

Table B-1: Dyn-560 Default Settings

Setup Feature	Default Value
Application – Pac – System	
System Type	Random PE
Port [If Type = Random ASCII]	COM1
Transmit PE3 [If Type = Checkweigh]	Disabled
Transmit Delay [If Type = Checkweigh]	0
Application – Pac – Display	
Display Time	0
Display Info	Literal
Display Literal [If Display Info = Literal]	Processed Weight
Application – Pac – Photo-eyes	
PE 1 Timer	150 mS
PE 2 Timer	50 mS
PE 1 to PE 2 Timer	3 Sec
PE 1 and PE 2 Maximum	5 Sec
Application – Pac – Weigh Time & AutoTune	
Weigh Time	300 mS
Application – Pac – Dynamic Adjust	
Dynamic Adjust	Disabled

Setup Feature	Default Value
Application – Pac – Error config	
Log Errors	Disabled
Send Error Code	Disabled
Error String [If Send Error Code = Disabled]	<Empty string>
Application – Pac – ID1 Inputs	
Data Type	None
1 st Character [If Data Type ≠ None]	1
Length [If Data Type ≠ None]	20
Mode [If Data Type ≠ None]	Use Last
Termination Character	<CR>
Fill Character [If Mode ≠ Use Last]	Any alphanumeric character
Application – Pac – Alarm Outputs [Only if Discrete Outputs configured for alarms]	
Fatal Alarm Output	Disabled
Non-Fatal Alarm Output	Disabled
Auto Clear Alarms	Disabled
Application – Pac – Dyn Target Table	
Dynamic Target Table	<empty table>

C Communications

C.1. Demand Output Mode

C.1.1. Trigger

In order for the IND570dyn software to work properly, a demand output must be configured with Avg. Wt. as the trigger. The demand output must be configured, but does not need to be physically connected to a communication device as long as flow control is turned off.

■ **Note:** Any additional demand outputs should be configured with “Avg. Weight” as their trigger.

C.1.2. Output Templates

Output Templates 1, 2 and 5 are configured as for the basic functionality version of the IND570. Output Template 3 is set up for ExpressWeigh functions, and Output Template 4 for the ExpressCheck application. These templates are described below.

For more detailed information on creating and modifying Output Templates, please refer to Appendix C, **Communications**, of the **IND570 User’s Guide**.

C.1.2.1.1. Output Template 3

Output Template 3 is set up to produce a record for transactions for the Dyn-570 ExpressWeigh application. Table C-1 details the elements present in this Template.

Table C-1: Output Template 3 Definition

Element	Explanation
lw0104	Processed Average Weight
Wt0103	Displayed Units
CR/LF	Carriage return/line feed

C.1.2.1.2. Output Template 4

Output Template 4 is set up to produce a record for transactions using the advanced (ExpressCheck) application. Table C-2 details the elements present in the Output Template 4.

Table C-2: Output Template 4 Definition

Element	Explanation
IW0104	Processed Average Weight
Wt0103	Displayed Units
"<SP>"	1 Space
Ak0118	Weighment Classification

Element	Explanation
CR/LF	Carriage return/line feed

C.2. Remote Discrete I/O (ARM100)

In order to configure an ARM100 in the system, create a connection with an assignment of "Remote Discrete I/O". Note that, in order to support RS-485, the COM port selected must be either COM1 or optional COM 3. Next, select the number of nodes that are to be connected. Up to three ARM100s are supported. To complete the connection, be sure to set the address dip switches on the ARM100 appropriately. Refer to the **ARM100 Technical Manual** for further details.

C.3. PLC Options

To configure a PLC connection, refer to the **IND570 PLC Interface Manual** for details.

C.4. ASCII Input

The following ASCII commands are used by the IND570dyn.

<S> Status request – Returns current terminal error

Table of errors:

- 00 No error condition
- 03 Gross weight less than zero
- 10 Cannot process command due to insufficient weight data (typically indicates that weigh time is too short)
- 11 Scale is in overload condition
- 20 A/D Faulted (Internal failure)
- 21 Unrecognized command (typically caused by a communication fault)

<W> Send Weight Data – Returns the current instantaneous weight

Response format:

```

Wsdddddduu  s = Scale status      <space> - Stable, non-zero weight
                                   <Z> - Center of Zero
                                   <M> - Scale is in motion

ddddddd      Right-justified weight, including decimal point

uu           Units                  "lb"
                                   "kg"
  
```

**** Begin dynamic weight measurement – returns <ACK> (0x06)

<E> End dynamic weight measurement – returns the processed weight initiated by the last command

Response format – No Error:

Es s = Scale status <space>
ddddd Right justified processed weight, including decimal point
uu Units "lb"
 "kg"

Response format – Error Condition:

Esxx xx = Error code
 00 – No error condition
 03 – Gross weight less than zero
 10 – Cannot process command due to insufficient weight data
 11 – Scale is in overload condition
 20 – A/D Faulted (Internal failure)
 21 – Unrecognized command

<Z> Set Zero – Zeros scale and returns an <ACK>

C.5. Shared Data Variables

C.5.1. Standard Dyn Application

Table C-3 lists the shared data variables used by the Dyn-570 application. Note that some of these variables are used only by the advanced (ExpressCheck®) version of the dyn-570 application.

Table C-3: Shared Data Variables for Standard Dyn Application

Function	Shared Data Name	Function	Shared Data Name
System Type	ax0101	Adjustment Maximum Time	ax0130
Transmit PE3	ax0111	Adjustment Minimum Time	ax0131
Transmit Delay	ay0103	Adjustment Maximum Dev	ay0108
Reject	ax0109	Adjustment Minimum Dev	ay0109
Port	ax0132	Log Errors	ax0105
Display Time	ay0104	Send Error Code	ax0106
Display Info	ax0112	Error String	az0101
Display Literal	az0102	ID1 Data Type	ax0113
PE1 Timer	ax0107	ID1 First Character	ax0117
PE2 Timer	ax0108	ID1 Length	ax0119
PE1 to PE2 Timer	ay0102	ID1 Mode	ax0121
PE1 & PE2 Maximum	ay0105	ID1 Fill Character	ax0123
Weigh Time	ax0110	ID1 Termination Character	ax0125
Filter Pole	ax0129	ID2 Data Type	ax0114
Filter Frequency	ay0106	ID2 First Character	ax0118
Dynamic Adjustment	ax0128	ID2 Length	ax0120

Function	Shared Data Name
ID2 Mode	ax0122
ID2 Fill Character	ax0124
ID2 Termination Character	ax0126
Fatal Alarm Output	ax0103
Non-Fatal Alarm Output	ax0104
Auto Clear Alarms	ax0102
Discrete input	
Run Permissive	ac0101
Silence Alarm	ac0102
Photo Eye 3	ac0103
Clear Alarm	ac0104
PE3 Clear Queue	ac0111
Discrete output	
Running	as0101
Alarm Fatal	as0102
Scale Empty	as0103
Reject Output	as0104
Weighment Complete	as0105

Function	Shared Data Name
Alarm Non-Fatal	as0106
ID1 Update	as0107
ID2 Update	as0108
Dynamic Over	as0109
Dynamic OK	as0110
Dynamic Under	as0111
Miscellaneous	
Complete Output Delay	ay0110
ID output Delay	ay0111
ID1 Response	ak0110
ID2 Response	ak0111
ID1 Data Received	ak0115
ID2 Data Received	ak0116
Processed Weight	iw0104
Special Format Processed Weight (5 position string leading zeros, no decimal point)	ak0117
Weighment Classification (String)	ak0118

METTLER TOLEDO Service

To protect your product's future:

Congratulations on choosing the quality and precision of METTLER TOLEDO. Proper use according to these instructions and regular calibration and maintenance by our factory-trained service team ensure dependable and accurate operation, protecting your investment. Contact us about a service agreement tailored to your needs and budget.

We invite you to register your product at www.mt.com/productregistration so we can contact you about enhancements, updates and important notifications concerning your product.

www.mt.com/IND570

For more information

Mettler-Toledo, LLC
1900 Polaris Parkway
Columbus, OH 43240

© 2018 Mettler-Toledo, LLC
30413989 Rev. 02, 12/2018



30413989