

ADT645

Explosion-Safe Display Unit

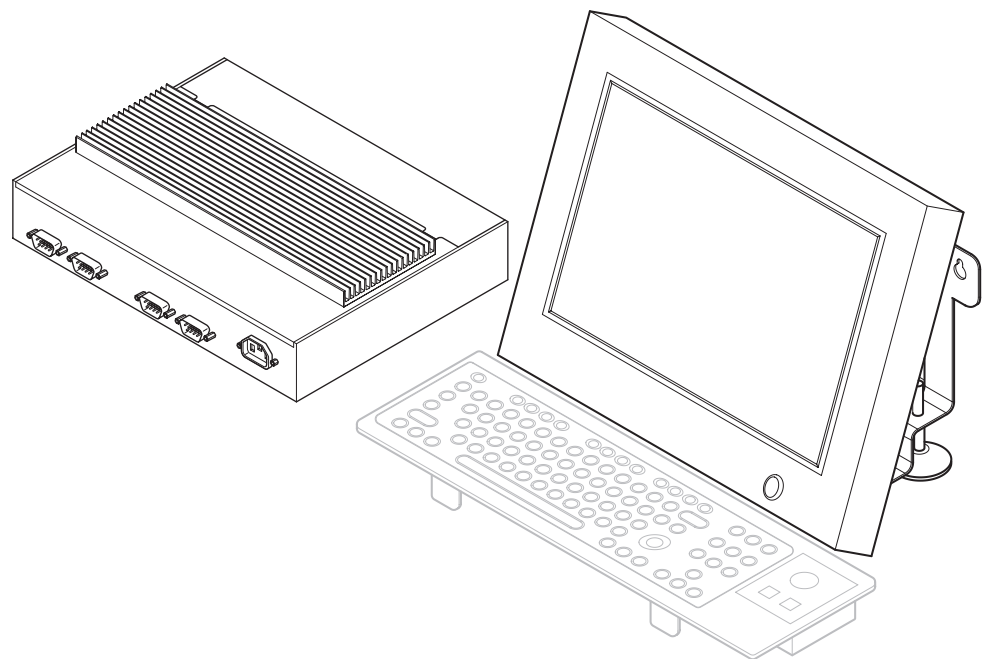

ServiceXXL

Tailored Services

Congratulations on choosing the quality and precision of METTLER TOLEDO. Proper use according to these instructions and regular calibration and maintenance by our factory-trained service team ensure dependable and accurate operation, protecting your investment. Contact us about a ServiceXXL agreement tailored to your needs and budget.

We invite you to register your product at

www.mt.com/productregistration

so we can contact you about enhancements, updates and important notifications concerning your METTLER TOLEDO product.

Contents

1	Safety precautions.....	4
2	System overview	6
2.1	Using the ADT645 Display	6
2.2	Supplied equipment	6
2.3	System configuration.....	6
2.4	Description of the components	7
3	Hardware installation	8
3.1	Notes on installing the ADT645 system	8
3.2	Wall mounting of ADT645 Display and ADT645 Keyboard	9
3.3	Connections at the ADT645 Display.....	10
3.4	Connections at the ADT645 Interface.....	11
3.5	Switching on and off	12
4	Software installation	13
4.1	Installing the Touchscreen Software.....	13
4.2	Software settings	16
5	Cleaning and inspection	22
5.1	Cleaning	22
5.2	Inspection	22
6	Troubleshooting.....	23
7	Technical data	24
7.1	ADT645 Display and ADT645 Keyboard.....	24
7.2	ADT645 Interface.....	25
8	Declarations of conformity	26
8.1	ADT645 Display Declaration of Conformity	26
8.2	ADT645 Interface Declaration of Conformity	28
9	Annex	30
9.1	Disposal	30
9.2	FCC notice	30

1 Safety precautions



- ▲ The ADT645 Display is approved for operation in Zone 0 hazardous areas.
- ▲ Particular care is required when using weighing systems with the ADT645 Display in hazardous areas. The code of practice is oriented to the "Safe Distribution" concept drawn up by METTLER TOLEDO.

Competence ▲ The ADT645 Display may only be installed, maintained and repaired by authorized METTLER TOLEDO service personnel.

- Ex approval** ▲ No modifications may be made to the device and no repair work may be performed on the modules. Any scale or system modules that are used must comply with the specifications contained in the installation instructions. Non-compliant equipment jeopardises the intrinsic safety of the system, cancels the "Ex" approval and renders any warranty or product liability claims null and void.
- ▲ The safety of the weighing system is only guaranteed when the weighing system is operated, installed and maintained in accordance with the respective instructions.
 - ▲ Also comply with the following:
 - the instructions for the system modules and scales,
 - the regulations and standards in the respective country,
 - the statutory requirement for electrical equipment installed in hazardous areas in the respective country,
 - all instructions related to safety issued by the owner.
 - ▲ The explosion-protected weighing system must be checked to ensure compliance with the requirements for safety before being put into service for the first time, following any service work and every 3 years, at least.

- Operation** ▲ Prevent the build-up of static electricity. Always wear suitable working clothes when operating or performing service work in a hazardous area.
- ▲ Do not use protective covers for the devices.
 - ▲ Avoid damage to the system components.

- Installation**
- ▲ Only install or perform maintenance work on the weighing system in the hazardous areas if the following conditions are fulfilled:
 - the intrinsically safe characteristic values and zone approval for individual components are in accordance with one other,
 - the owner has issued a permit ("spark permit" or "fire permit"),
 - the area has been rendered safe and the owner's safety co-ordinator has confirmed that there is no danger,
 - the necessary tools and any required protective clothing are provided (danger of build-up of static electricity)
 - ▲ The certification documents (certificates, manufacturer's declarations) must be present.
 - ▲ Route the cables so that they cannot move. Protect the cables against possible damage.
 - ▲ Only route the cables into the housing of the system modules via a suitable cable gland.

2 System overview

2.1 Using the ADT645 Display

The ADT645 Display is a TouchScreen display used for remote operation of a PC. The ADT645 Display, scale and optional keyboard and mouse are placed in the hazardous area and are connected via a ADT645 cable to the ADT645 Interface and to the PC. Interface and PC are placed in the safe area.

2.2 Supplied equipment

- ADT645 Display with ADT645 cable and ADT645 keyboard (trackball optional)
- ADT645 Interface
- 1 x 1.8 m VGA cable
- 3 x 1.8 m serial cables
- 1 x 1.8 m mains cable (regional options)
- 1 x 10 m / 20 m cable (optional)
- TouchScreen software (optional)

Note

Contact your METTLER TOLEDO representative for accessories and options available.

2.3 System configuration

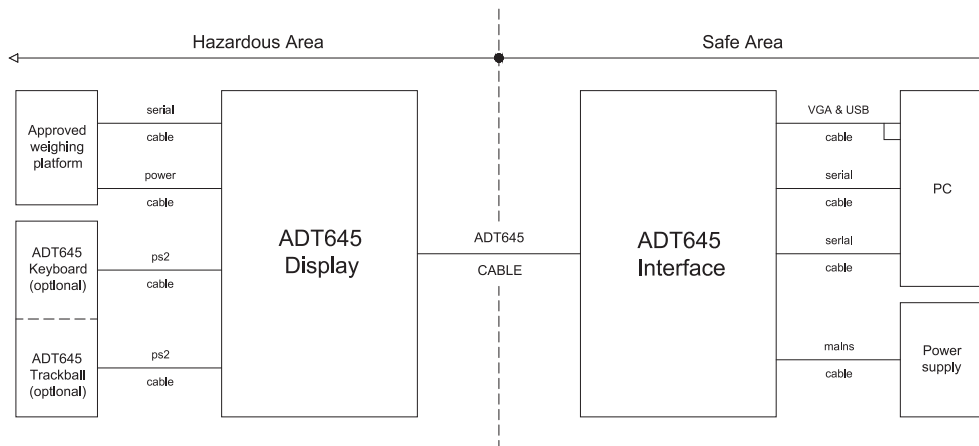

2.4 Description of the components

ADT645 Display The ADT645 Display and ADT645 Keyboard are Intrinsically Safe Apparatus of Category 1.
ADT645 Keyboard They are suitable for use in Zone 0 hazardous areas.

Approvals	IECEX BAS 08.0051X	Ga Ex ma ia IIB T5
	Baseefa08ATEX167X	II 1G Ga Ex ma ia IIB T5
	FM	Class I, Division 1, Groups C, D, T5
Temperature range	0 °C to + 40 °C	

Connections

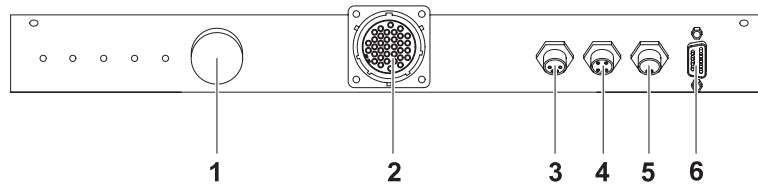

- 1 On/off switch
- 2 ADT645 Interface
- 3 ADT645 Keyboard
- 4 ADT645 Mouse
- 5 Scale power
- 6 Scale serial interface

ADT645 Interface The ADT645 Interface is an Associated Intrinsically Safe Apparatus of Category 1. It is suitable for supplying Zone 0 equipment.

Approvals	IECEX BAS 08.0052	(Ga) [Ex ia] IIB
	Baseefa08ATEX168	II (1) G (Ga) [Ex ia] IIB
	FM	Class I, Division 1, Groups C, D

Connections

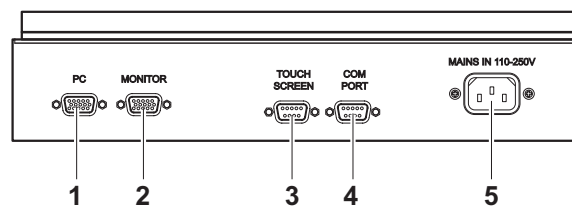

- 1 PC (to connect to the VGA port and one USB port on the PC)
- 2 Monitor (to connect a monitor in the safe area)
- 3 TouchScreen (to connect to COM2 on the PC)
- 4 Com Port (to connect to COM1 on the PC)
- 5 Mains

3 Hardware installation

3.1 Notes on installing the ADT645 system



WARNING!

Electric shock hazard!

- ▲ Connect the units with certified cables approved by METTLER TOLEDO only.
- ▲ Before operating the equipment make sure that the mains power cable to the ADT645 Interface case contains an earth, that is connected to the safe-area power-supply earth. The cable must comply with the national requirements.



CAUTION!

Damage to the units!

- ▲ **Before connecting the equipment to the power supply, connect all cables to the ADT645 Interface and the ADT645 Display.**
- ▲ Do not connect the equipment if the required voltage value is different to the local voltage.
- ▲ Allow only trained personnel to install and operate the equipment.

3.1.1

Routing principles

- Route the cables in a way that, i.e., sharp/rough edges or extreme heat cannot damage them.
- Make sure that the cables are long enough to prevent tensions on wires, terminals, connections, junctions and supports.
- Put grommets on the cables that pass through metal enclosures.
- Cable and connectors are identical, compatible with both interface and display ports allowing the cable to be installed either way round.

3.1.2

Installation order

1. Position the ADT645 Display and the ADT645 Keyboard.
2. Connect the scale to the ADT645 Display.
3. Connect ADT645 Display and ADT645 Interface.
4. Connect the PC and peripherals to the ADT645 Interface.
5. Connect the ADT645 Interface to the power supply.
6. Switch on the ADT645 Display.

3.1.3

Storage

- Store packaged units in a cool, dry area at a temperature of $-20\text{ }^{\circ}\text{C}$ to $50\text{ }^{\circ}\text{C}$.
- Keep units away from any heat source or direct sunlight.
- Make sure that the units are not exposed to vibrations or shocks.

3.2

Wall mounting of ADT645 Display and ADT645 Keyboard



CAUTION!

Display and keyboard weigh approx. 10 kg. When mounting display and keyboard to the wall pay attention to the following:

- ▲ Work must be undertaken by competent personnel.
- ▲ Adequate fixings must be ensured.

Drilling template

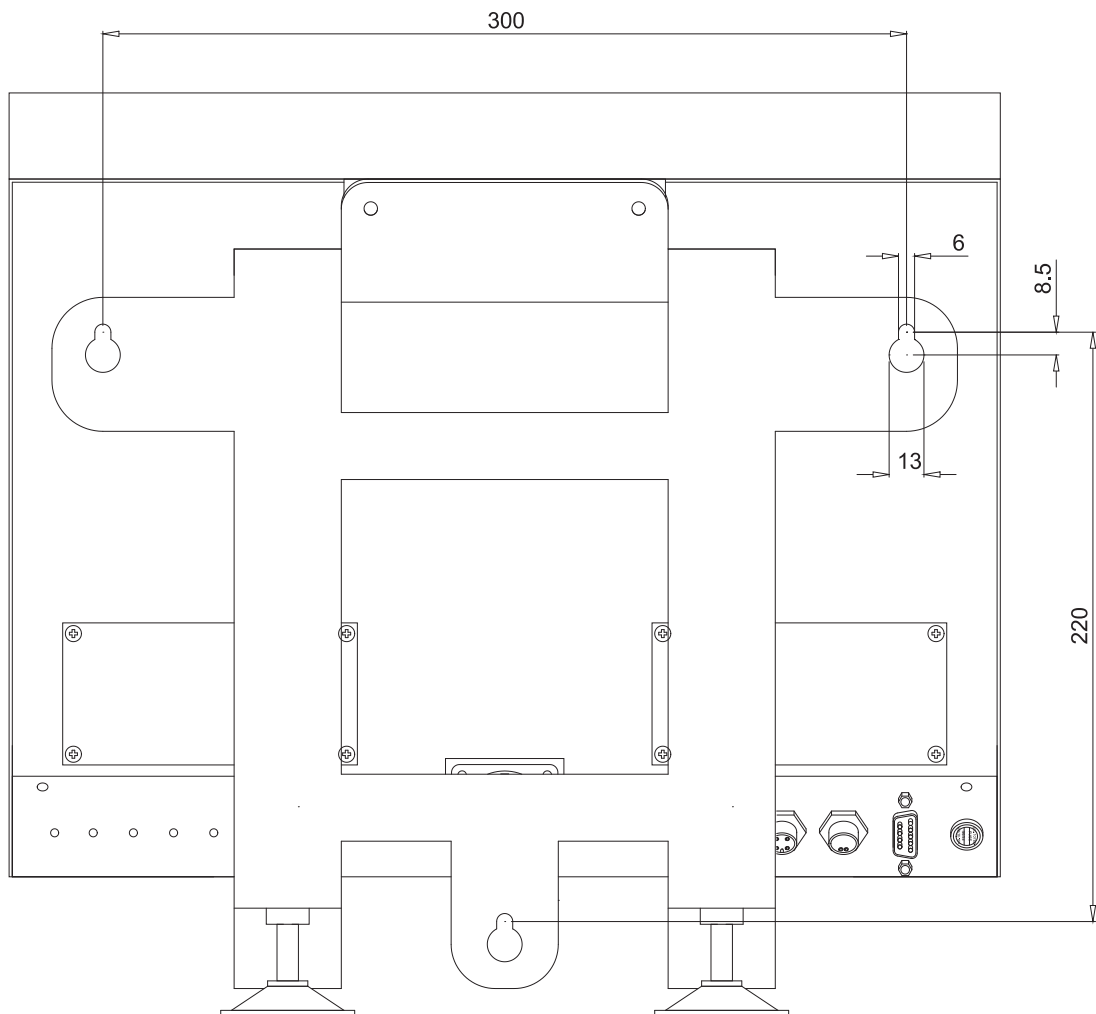

3.3 Connections at the ADT645 Display

3.3.1 Connecting the scale

1. Mount the scale in the hazardous area as described in the scale's Installation Information.
2. Route the scale cables to the ADT645 display.

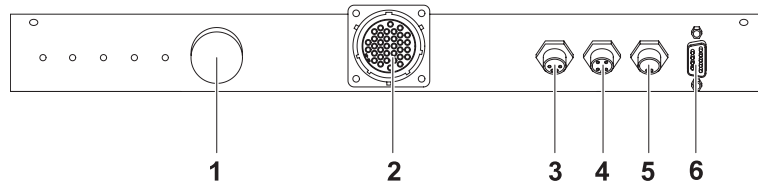

3. Connect the power and signal cables of the scale to the connectors (5, 6) on the rear of the ADT645 Display.
4. In case a stand is mounted, adjust the mounting feet on the back of the stand until the display is stable and the display level as well as the viewing angle are correct.

3.3.2 Connecting the interface cable

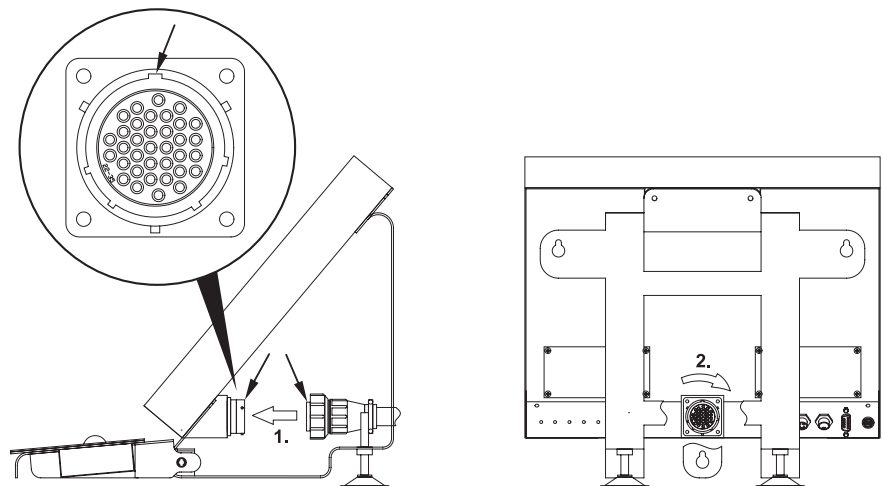

1. Align cable plug and socket: the lugs on the plug must match the lugs on the socket, with the big lug at top.
2. Insert and twist locking ring.

3.4 Connections at the ADT645 Interface

3.4.1 Connecting the ADT645 Display to the ADT645 Interface



CAUTION

Damages to the unit

- ▲ The ADT645 Interface must only be installed in the safe area.
- ▲ Do not connect the interface safe area connections to the PC and peripheral equipment if the voltage supply is higher than 253 V r.m.s.

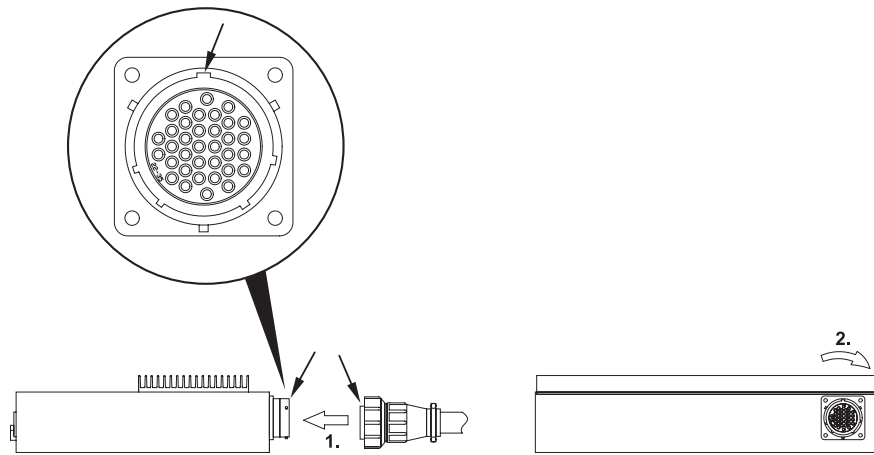

1. Align cable plug and socket: the lugs on the plug must match the lugs on the socket, with the big lug at top.
2. Insert and twist locking ring.

3.4.2 Connecting the PC and peripherals to the ADT645 Interface

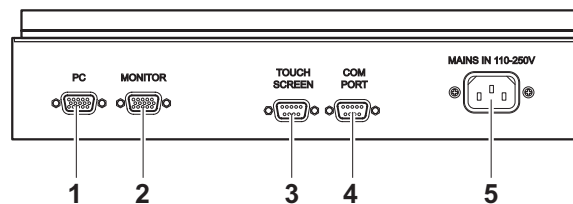

1. Connect the VGA cable from the VGA port and a USB port on the PC to the PC socket (1) of the ADT645 Interface.
2. Connect COM1 from the PC to the Com Port socket (4) and COM2 to the TouchScreen socket (3).

3.4.3 Connecting the power supply

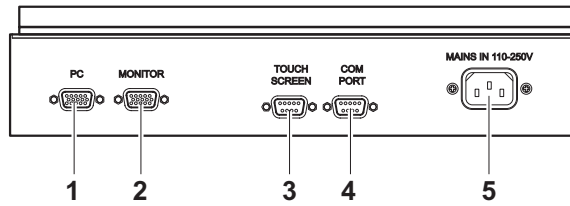

1. Connect the power cord to the ADT645 Interface (5) and a mains outlet.
2. Connect the PC to a mains outlet.

3.5 Switching on and off

Prerequisite

ADT645 Interface and PC are connected to the mains.

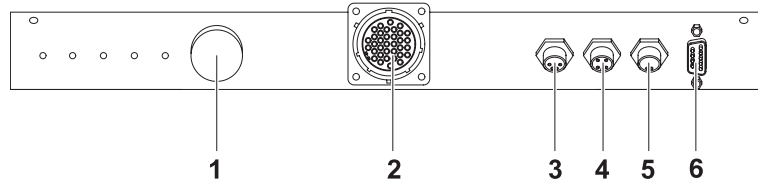

- Press the on/off switch (1) on the back of the display.

Notes

- Switch the system off if you do not use it for a longer period of time.
- Power settings on the PC should be set to switch off the monitor after 1 hour.
Damage caused to the display backlight by failure to do this may invalidate warranty.

4 Software installation

4.1 Installing the Touchscreen Software

1. Browse to the drive containing the ADT645 CD, e.g. D:.
2. Run the file **Setup.exe**.

- The folder **C:\Program Files\Touchscreen Software** will be created.

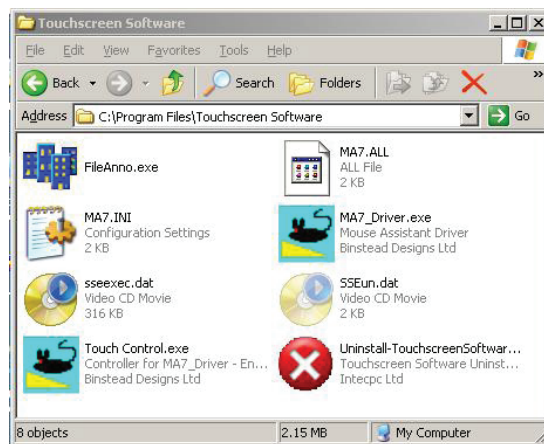

- The icon **Touchscreen Software 1.0** will be placed on the desktop.

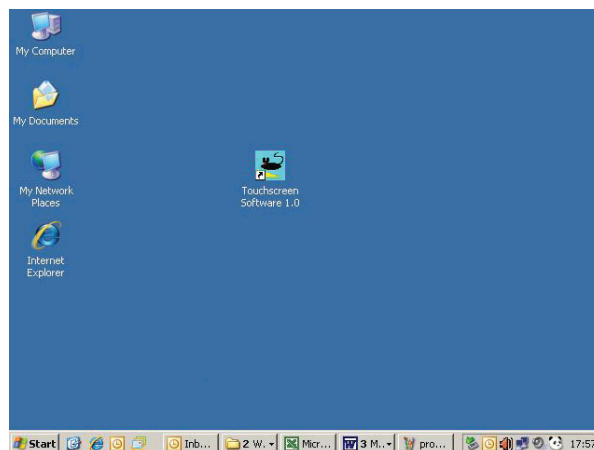

- The shortcut **MA7_Driver** will be placed in the startup folder of the Start menu and in the folder **Touchscreen Software 1.0** in the Start menu.

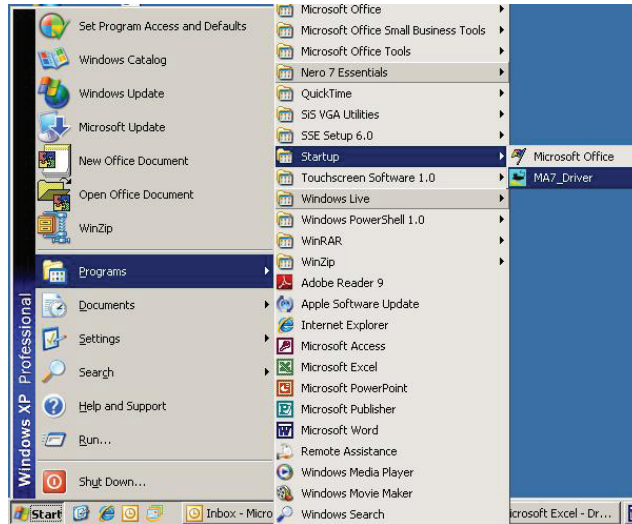

Note

- If the software fails to install correctly it will be necessary to manually install the desktop icon and start menu shortcuts, see sections 4.1.1 and 4.1.2.
- If the software is installed correctly, proceed with section 4.1.3.

4.1.1

Creating a desktop shortcut for the Touchscreen Software

1. Open the **Program Files\Touchscreen Software** folder.
2. Move the cursor over the **MA7_Control_En** icon.
3. Click the right mouse button and select **Create Shortcut**.

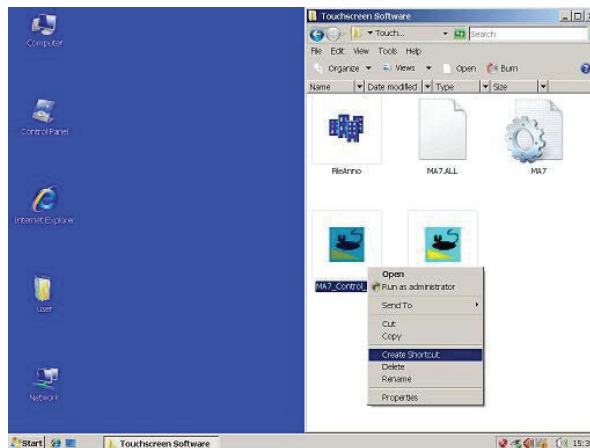

- When using Windows Vista this shortcut will be automatically copied to the desktop.
- When using Windows XP, Windows 2000 or Windows 98 copy the shortcut "Touchscreen Control" to the desktop.

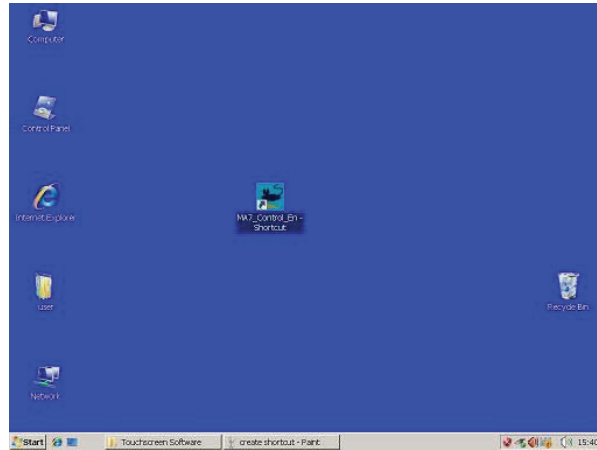

4.1.2 Adding the driver to the "Startup" folder

1. Close "C:\Program Files".
2. Go to the start menu and find "Programs/Startup".
3. Click the right mouse button and select "Open".

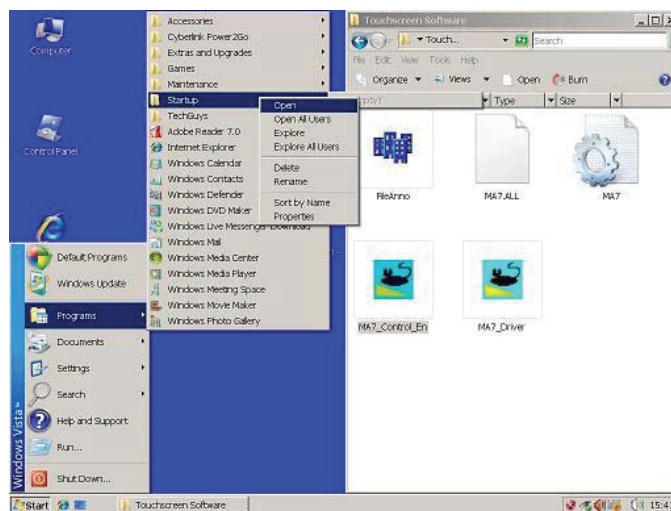

The **Startup** folder will be opened in a new window.

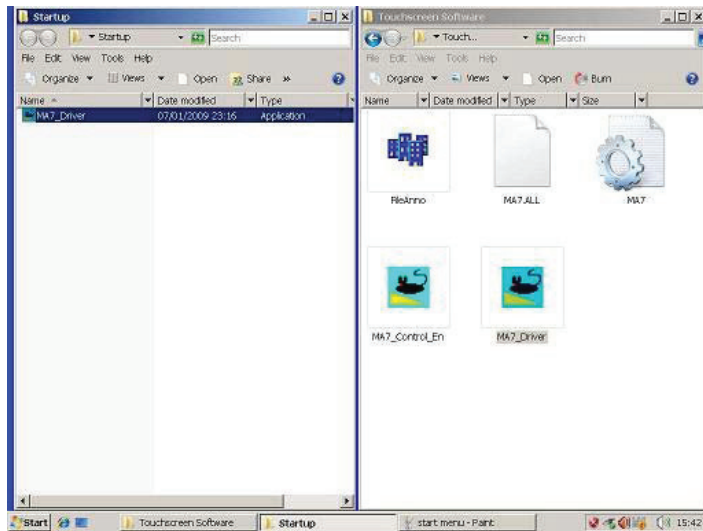

4. Create a shortcut to the file **MA7_Driver**.
5. Copy the shortcut to the **Startup** folder.

4.1.3 Finishing installation

1. Close all open folders and remove the CD from the CD drive.
2. Restart the PC.

4.2 Software settings

4.2.1 Opening the Touchscreen Control Panel

1. Close down all other programs until you return to the Windows Desktop.
2. Open the Touchscreen Control Panel by selecting the **MA7_Control_En** icon on the desktop.

The following screen will appear.



4.2.2

Selecting the Com Port

1. Select the **Comms** tab.
2. Select the **Port** that the touchscreen is connected to.
3. Set the baud rate to **9600**.
4. Check **Open** in the **Status** section.

The screen should appear as it does in the picture below.

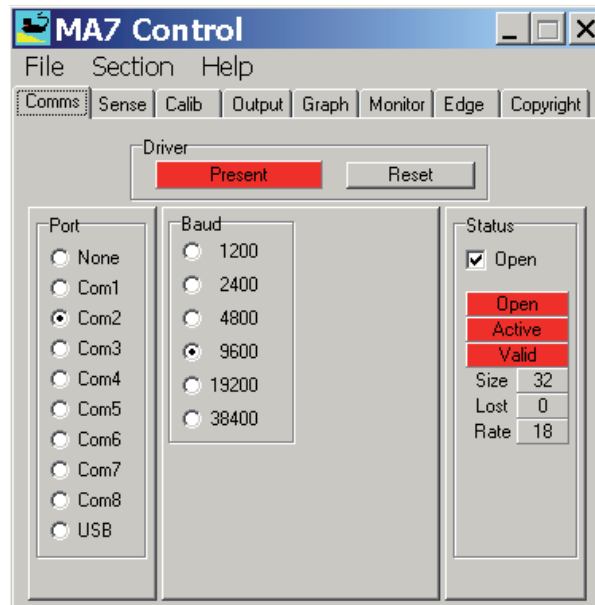

4.2.3

Altering the Sensitivity

- Select the **Sense** tab.

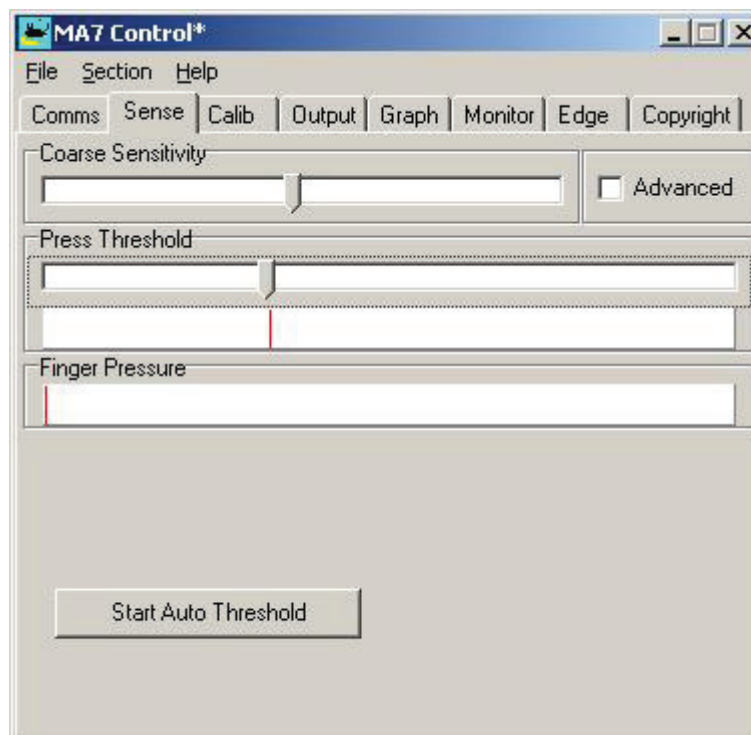

- Coarse Sensitivity** ... is used to set the sensitivity of an applied touch. If the slider is set to the right, the touchscreen is more sensitive to an applied touch to the surface.
- Press Threshold** ... is used to set the activation point of an applied touch.
- Finger Pressure** illustrates the strength of signal the touchscreen is receiving from an applied touch. The signal strength must pass the **Press Threshold** to register a touch. When there is no touch applied, the **Finger Pressure** will show a slight jitter.

Setting the sensitivity and activation threshold of the Touchscreen

1. Lightly touch the touchscreen.
2. Adjust the **Coarse Sensitivity** slider so that the **Finger Pressure** indicator always passes the **Press Threshold**.
3. Touch the screen in several places to check that the **Finger Pressure** always passes the **Press Threshold**.
4. If the background level is above the **Finger Pressure**, adjust the **Press Threshold** slider and repeat the process of adjusting the **Coarse Sensitivity**.
The positions shown in the picture above should give a reasonable response from the touchscreen.

4.2.4

Calibration

1. Select the **Calibration** tab.

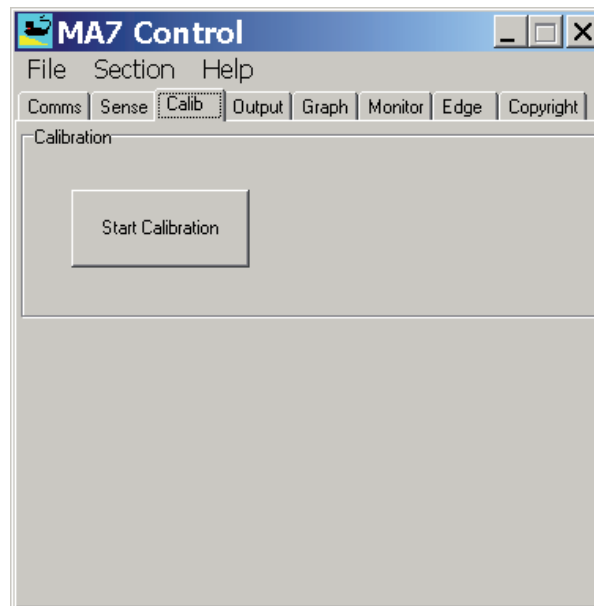

2. Select the **Start Calibration** button.
3. Touch the centre of each target in turn **and hold your finger steady in place**.
4. **Remove your finger only when the next target appears.**
5. Once all three targets have disappeared the calibration is complete.

Note

The calibration sequence of three targets can be exited at any time by either holding your finger on the red box in the centre of the screen or by pressing the Esc key on the keyboard.

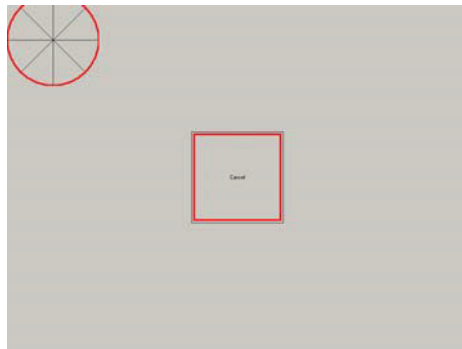

Step 1

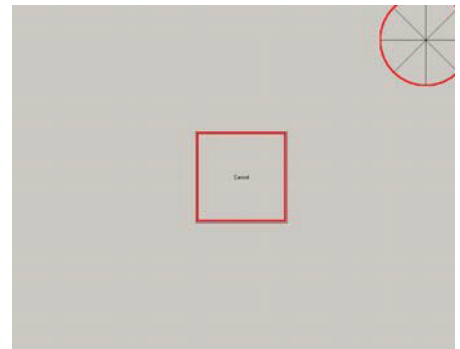

Step 2

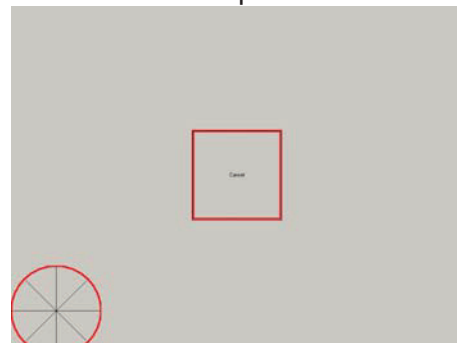

Step 3

4.2.5

Setting the Mouse Mode

1. Select the **Output** tab.
2. Select the **Touch screen's mouse control** from the list.
For standard mouse operation select **Select/Move/Release**.
3. Check **Enable selected control** to enable the mouse operation.

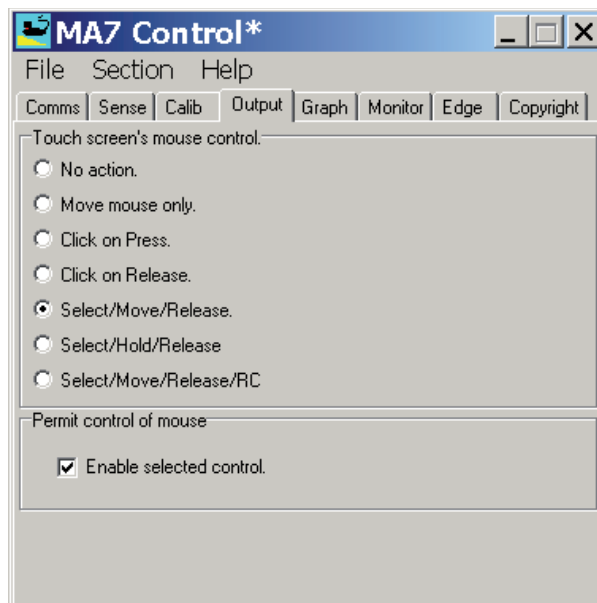

4.2.6

Checking the Touchscreen Operation

1. Select the **Graph** tab.

The lines show the **Finger Pressure** measured on the horizontal and vertical edges of the screen.

The position of the lines will move as your finger moves around the screen.

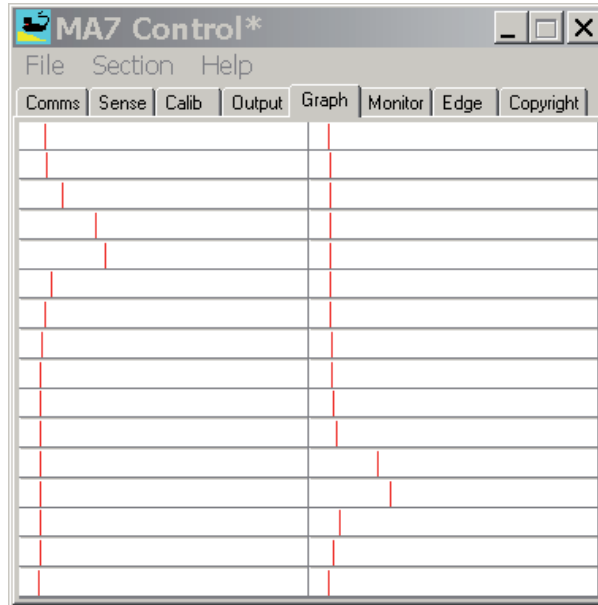

2. Select the **Monitor** tab

Moving your finger round the screen will result in a red line showing the movement round the screen.

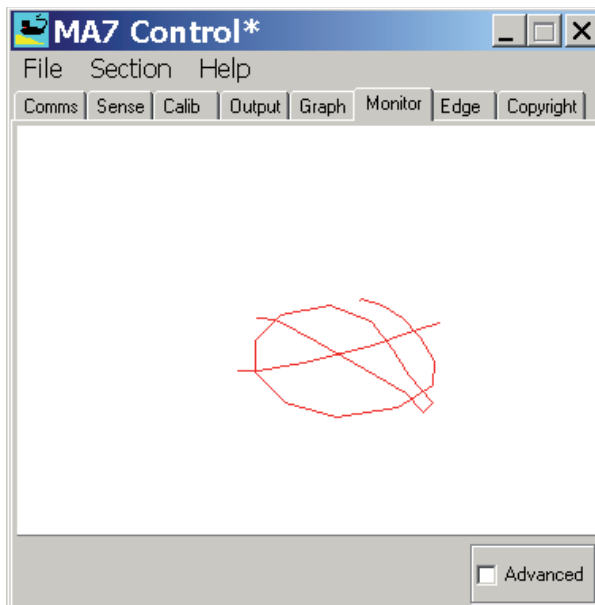

4.2.7

Setting the Edge Gain

- If, after calibration, the cursor will not reach the edges of the touchscreen, a small amount of edge gain can be set.
 - This can be done by moving the sliders away from the centre: the further the sliders are moved, the higher the gain.
 - Moving the sliders by 2~3mm is usually sufficient.
1. Select the **Edge** tab.
 2. Move the sliders.

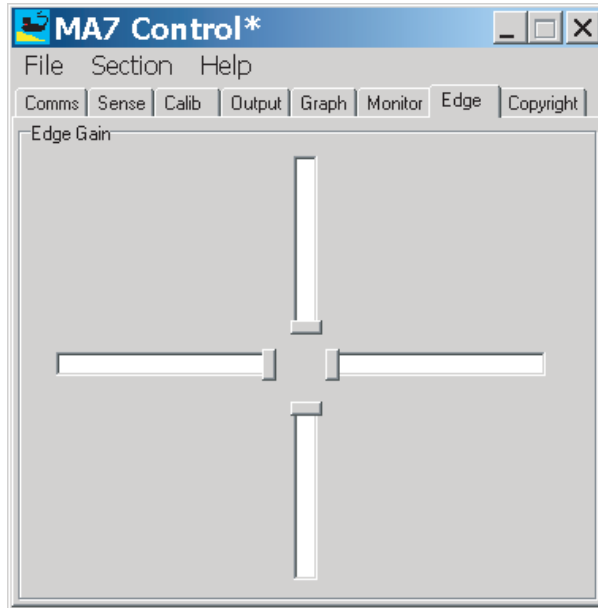

4.2.8

Saving the Touchscreen Control Settings

Note

- The **Touchscreen Control program** does NOT automatically save the settings on Exit.
- The settings must be manually saved before exit.

1. Select **File** from the **Menu**.
2. Select **Save**.
3. Select **Exit**.

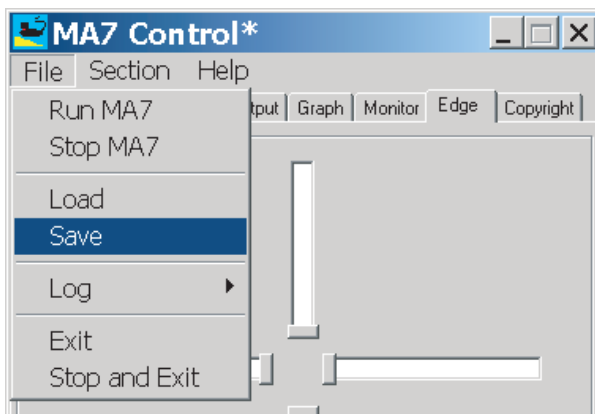

5 Cleaning and inspection

5.1 Cleaning



DANGER!

Electric shock hazard due to ingress of moisture!

- ▲ Before cleaning:
 - shutdown the PC via the ADT645 Display
 - pull out the power plug to disconnect the system from the power supply

Further notes on cleaning

- Use a damp cloth and only non solvent based cleaners.
- Do not use any acids, alkalis or solvent based cleaners.
- Do not clean the unit using a high-pressure cleaning unit or under running water.
- Follow all the relevant instructions regarding cleaning intervals and permissible cleaning agents.

5.2 Inspection

The ADT645 parts are not serviceable and cannot be repaired by the user.

- Contact your supplier if damage and/or malfunction are discovered during installation or operation of the system.

5.2.1 Inspection intervals

- Inspections are to be carried out annually, as a minimum, to ensure the continued safe operation of the unit.

5.2.2 Inspection procedure

- Let a METTLER TOLEDO trained technician carry out the inspection.
- If damage and/or malfunction of the unit are discovered during the inspection, contact your METTLER TOLEDO representative.

6 Troubleshooting

Problem	Possible cause	Remedy
Display is blank	<ul style="list-style-type: none"> • Cables are not correctly connected • Cable is damaged • Units are not switched on • Cause is not known 	<ul style="list-style-type: none"> → Check if all cables are correctly connected → Check all cables for physical damage → Ensure that all cables are correctly connected before powering on → Check that both the ADT645 Interface and the PC are powered on → Contact your METTLER TOLEDO representative
Display is dim or distorted	<ul style="list-style-type: none"> • Cause is not known 	<ul style="list-style-type: none"> → Contact your METTLER TOLEDO representative
Touchscreen does not work	<ul style="list-style-type: none"> • Cables are not correctly connected • Cable is damaged • Software not installed correctly • Cause is not known 	<ul style="list-style-type: none"> → Check if all cables are correctly connected to the ADT645 → Check all cables for physical damage → Check that the software has been installed and configured according to the instruction manual → Contact your METTLER TOLEDO representative
Scale does not work	<ul style="list-style-type: none"> • Cables are not correctly connected • Cable is damaged • Port settings are not correctly set • Cause is not known 	<ul style="list-style-type: none"> → Check if all cables are correctly connected to the ADT645 → Check all cables for physical damage → Check that the port settings are correctly set on the peripheral and the computer (the serial interface does not support handshaking) → Contact your METTLER TOLEDO representative
Keyboard does not work	<ul style="list-style-type: none"> • Cables are not correctly connected • Cable is damaged • Cause is not known 	<ul style="list-style-type: none"> → Check if all cables are correctly connected to the ADT645 → Check all cables for physical damage → Contact your METTLER TOLEDO representative
Some keys on the keyboard do not work	<ul style="list-style-type: none"> • Keyboard is damaged 	<ul style="list-style-type: none"> → Replace the keyboard
Software does not work correctly	<ul style="list-style-type: none"> • Cause is not known 	<ul style="list-style-type: none"> → Contact supplier of PC and/or software
Physical damage	<ul style="list-style-type: none"> • Cause is not known 	<ul style="list-style-type: none"> → Contact supplier of PC and/or software
Trackball (if fitted) does not work	<ul style="list-style-type: none"> • Cables are not correctly connected 	<ul style="list-style-type: none"> → Check if all cables are correctly connected to the ADT645
	<ul style="list-style-type: none"> • Cable is damaged 	<ul style="list-style-type: none"> → Check all cables for physical damage
	<ul style="list-style-type: none"> • Cause is not known 	<ul style="list-style-type: none"> → Contact your METTLER TOLEDO representative

7 Technical data

7.1 ADT645 Display and ADT645 Keyboard

Ignition protection type	IECEX BAS 08.0051X	Ga Ex ma ia IIB T5
	Baseefa08ATEX167X	II 1G Ga Ex ma ia IIB T5
	FM	Cl. I, Div. 1, Groups C, D, T5
Temperature range	Operation	0 °C to +40 °C
	Storage	-20°C to +50°C
Preinstalled cable	10 m	
Serial port output parameters	$U_o = 11.7 \text{ V}$ $I_o = 0.092 \text{ A}$ $P_o = 0.266 \text{ W}$	
Scale power supply output parameters	$U_o = 12.6 \text{ V}$ $I_o = 0.34 \text{ A}$ $P_o = 3.74 \text{ W}$	
Weight	ADT645 Display	8.0 kg
	ADT645 Keyboard	1.5 kg

Dimensional drawings

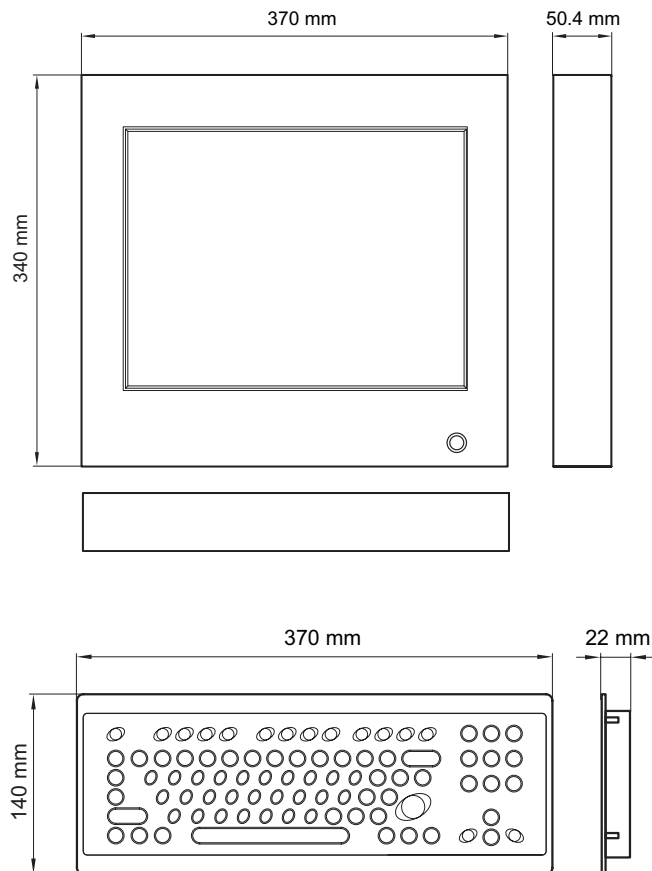

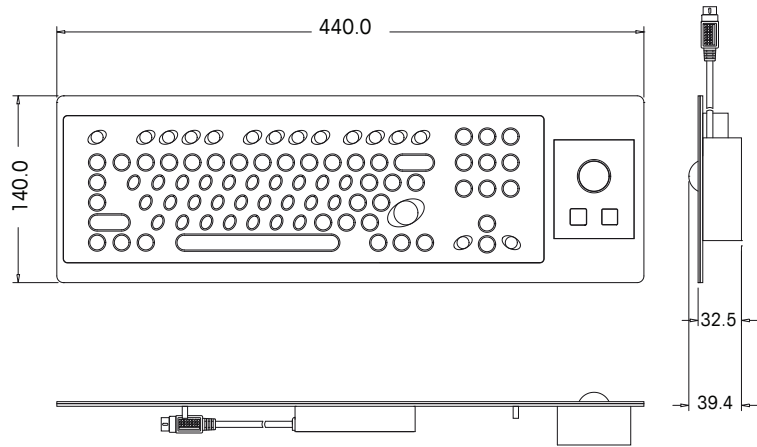

7.2 ADT645 Interface

Ignition protection type	IECEx BAS 08.0052	(Ga) [Ex ia] IIB
	Baseefa08ATEX168	II (1) G (Ga) [Ex ia] IIB
	FM	Cl. I, Div. 1, Groups C, D
Temperature range	Operation	0 °C to +40 °C
	Storage	-20°C to +50°C
Supply voltage	90-264 V AC, 50-60Hz	
Power consumption	25 W typ.	
Weight	3.5 kg	

Dimensional drawing

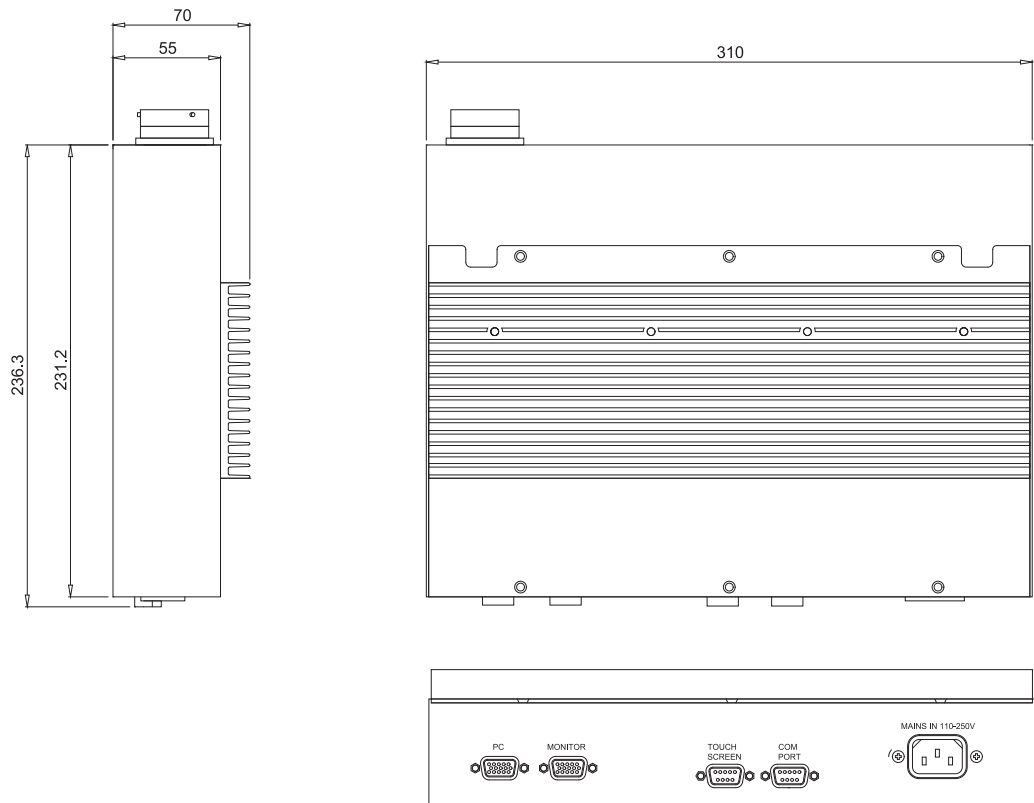

8 Declarations of conformity

8.1 ADT645 Display Declaration of Conformity

The ADT645 Display is an Intrinsically Safe Apparatus, Category 1, suitable for use in Zone 0 hazardous areas.

The manufacturer hereby declares with sole responsibility that the ADT645 Display and ADT645 Keyboard (with trackball option) comply with the following international and EU directives and standards:

89/336EEC EMC	Emissions EN 61000-6-4 2007	Industrial Environment
	Immunity EN 61000-6-1 2007	Residential, commercial and light industrial
	Immunity EN 61000-6-2 2005	Industrial Environment
	EN60529: 1992	Ingress Protection: IP54
FCC/CFR 47:15	FCC/CFR 47:Part 15:2009	Unintentional radiators
	EN60529:1992	Ingress Protection: IP54
94/9/EEC ATEX	EN 60079-0:2006	Electrical apparatus for explosive gas atmospheres – Part 0: General requirements
	EN 60079-11:2007	Electrical apparatus for explosive gas atmospheres – Part 11: Intrinsic safety 'i'
	EN 60079-18:2004	Electrical apparatus for explosive gas atmospheres – Part 18: Encapsulation 'm'
	EN60079-26:2007	Explosive atmospheres. Equipment with equipment protection level (EPL) Ga
IECEX	IEC 60079-0:2004 Ed: 4	Electrical apparatus for explosive gas atmospheres – Part 0: General requirements
	IEC 60079-11:2006 Ed: 5.0	Electrical apparatus for explosive gas atmospheres – Part 11: Intrinsic safety 'i'
	IEC 60079-18: 2004 Ed: 2.0	Electrical apparatus for explosive gas atmospheres – Part 18: Encapsulation 'm'
	IEC60079-26:2006 Ed: 2	Explosive atmospheres. Equipment with equipment protection level (EPL) Ga
Notified Body		Baseefa Ltd. Ref No: - 1180
FM	FM3600: 11/98	Approval Standard for Electric Equipment for use in Hazardous (Classified) Locations – General Requirements
	FM3610: 10/99	Approval Standard for Intrinsically Safe Apparatus and Associated Apparatus for Use in Class I, II, & III, Division 1, and Class I, Zone 0 & 1 Hazardous (Classified) Locations
	ANSI/ISA-60079-18 (12.23.01)-2005	Electrical Apparatus for Use in Class I, Zone 1 Hazardous (Classified) Locations Type of Protection – Encapsulation
Notified Body		FM Approvals Ltd.
Special Conditions		Ambient Temperature 0 °C to +40 °C

The serial port available to the user in the hazardous area has the following output parameters:

U_o	11.7 V
I_o	0.092 A
P_o	0.266 W

ADT645 Display Serial No.



 CL I, DIV 1, GP C, D T5 (0°C ≤ Ta ≤ 40°C)
Control Drawing 213-703

Manufactured by:- INTECPC LTD, POYNTON, SK12 1PQ, UK

KEYBOARD MOUSE SCALE SCALE
POWER

ADT645 Display Serial No.

Ga Ex ma ia IIB T5 (0°C ≤ Ta ≤ 40°C)
IECEX BAS 08.0051X

 II 1G Ga Ex ma ia IIB T5 (0°C ≤ Ta ≤ 40°C)
Baseefa08ATEX0167X
Manufactured by:- INTECPC LTD, POYNTON, SK12 1PQ, UK 

FOR ENGINEER ON/OFF
USE ONLY

ADT645 Keyboard

Serial No.

Part of IECEX BAS 08.0051X

Part of Baseefa08ATEX0167X

 AIS CL I, DIV 1, GP C, D T5
(0°C ≤ Ta ≤ 40°C)

Manufactured by:- INTECPC LTD, POYNTON, SK12 1PQ, UK



ADT645 Keyboard
(Trackball Version)

Serial No.

Part of IECEX BAS 08.0051X

Part of Baseefa08ATEX0167X

 AIS CL I, DIV 1, GP C, D T5
(0°C ≤ Ta ≤ 40°C)

Manufactured by:- INTECPC LTD, POYNTON, SK12 1PQ, UK

Intecpc Ltd, Rupert House, London Rd Sth, Poynton, Cheshire, SK12 1PQ,
United Kingdom

22/07/2010

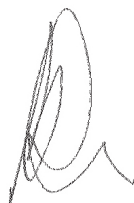

Mark Russell
Managing Director





Andy Griffin
Technical Director

8.2 ADT645 Interface Declaration of Conformity

The ADT645 Interface is Associated Intrinsically Safe Apparatus, Category 1, suitable for supplying Zone 0 equipment.

The manufacturer hereby declares with sole responsibility that the ADT645 Interface complies with the following international and EU directives and standards:

89/336EEC EMC	Emissions EN 61000-6-4 2007	Industrial environment
	Immunity EN 61000-6-1 2007	Residential, commercial and light industrial
	Immunity EN 61000-6-2 2005	Industrial Environment
FCC/CFR 47:15	FCC/CFR 47:Part 15:2009	Unintentional radiators
94/9/EEC ATEX	EN 60079-0:2006	Electrical apparatus for explosive gas atmospheres – Part 0: General requirements
	EN 60079-11:2007	Electrical apparatus for explosive gas atmospheres – Part 11: Intrinsic safety 'i'
	EN60079-26:2007	Explosive atmospheres. Equipment with equipment protection level (EPL) Ga
IECEx	IEC 60079-0:2004 Ed: 4	Electrical apparatus for explosive gas atmospheres – Part 0: General requirements
	IEC 60079-11:2006 Ed: 5.0	Electrical apparatus for explosive gas atmospheres – Part 11: Intrinsic safety 'i'
	IEC60079-26:2006 Ed: 2	Explosive atmospheres. Equipment with equipment protection level (EPL) Ga
Notified body		Baseefa Ltd. Ref No: - 1180
FM	FM3600: 11/98	Approval Standard for Electric Equipment for use in Hazardous (Classified) Locations – General Requirements
	FM3610: 10/99	Approval Standard for Intrinsically Safe Apparatus and Associated Apparatus for Use in Class I, II, & III, Division 1, and Class I, Zone 0 & 1 Hazardous (Classified) Locations
Notified Body		FM Approvals Ltd.
Special Conditions		None

ADT645 Interface	Serial No.	INT YY/ZZZ
(Ga) [Ex ia] IIB IECEx BAS 08.0052		
 II (1) G (Ga) [Ex ia] IIB Baseefa08ATEX0168		
Manufactured by:- INTECPC LTD, POYNTON, SK12 1PQ, UK		

ADT645 Interface	Serial No.	INT YY/ZZZ
 Associated apparatus for CL I, DIV 1, GPS C,D Um = 253Vac Control Drawing 213-703.		
Manufactured by:- INTECPC LTD, POYNTON, SK12 1PQ, UK		

Intecpc Ltd, Rupert House, London Rd Stn, Poynton, Cheshire, SK12 1PQ,
United Kingdom

22/07/2010

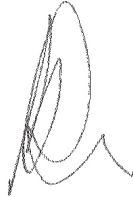

Mark Russell
Managing Director



Andy Griffin
Technical Director

9 Annex

9.1 Disposal



In conformance with the European Directive 2002/96/EC on Waste Electrical and Electronic Equipment (WEEE), this device must not be disposed of in domestic waste. This also applies to countries outside the EU as per their specific regulations.

→ Please dispose of this product in accordance with local regulations at the collecting point specified for electrical and electronic equipment.

If you have any questions, please contact the responsible authority or the distributor from which you purchased this device.

Should this device be passed on to other parties (for private or professional use), the content of this regulation must also be related.

Thank you for your contribution to environmental protection.

9.2 FCC notice

This equipment has been tested and found to comply with the limits for a Class A digital device, pursuant to both Part 15 of the FCC Rules and the radio interference regulations of the Canadian Department of Communications. These limits are designed to provide a reasonable protection against harmful interference when the equipment is operated in a commercial environment. This equipment generates, uses and can radiate radio frequency energy and, if not installed and used in accordance with the user manual, may cause harmful interference to radio communications. Operation of this equipment in a residential area is likely to cause harmful interference, in which case the user will be required to correct the interference at his own expense.



www.mt.com/service

For more information

Mettler-Toledo AG

CH-8606 Greifensee

Switzerland

Tel. +41 44 944 22 11

Fax +41 44 944 30 60

Subject to technical changes

© 07/2010 Mettler-Toledo AG

Printed in Switzerland

Order number 44099370B