

# Operation Manual Transmitter M300



- **pH/Redox, Dissolved Oxygen, Conductivity/Resistivity, Dissolved Ozone, single channel version**
- **Cond/Cond dual channel version**
- **Multiparameter dual channel version for analog sensors**
- **Multiparameter single and dual channel version for ISM sensors**

Transmitter M300  
52 121 389



---

# Operation Manual Transmitter M300

# Content

<b>1</b>	<b>Introduction</b>	<b>9</b>
<b>2</b>	<b>Safety instructions</b>	<b>10</b>
2.1	Definition of equipment and documentation symbols and designations	10
2.2	Correct disposal of the unit	11
<b>3</b>	<b>Unit overview</b>	<b>12</b>
3.1	Overview 1/4DIN	12
3.2	Overview 1/2DIN	12
3.3	Control/Navigation Keys	13
3.3.1	Menu Structure	13
3.3.2	Navigation keys	13
3.3.2.1	Navigating the menu tree	13
3.3.2.2	Escape	14
3.3.2.3	Enter	14
3.3.2.4	Menu	14
3.3.2.5	Calibration mode	14
3.3.2.6	Info mode	14
3.3.3	Navigation of data entry fields	14
3.3.4	Entry of data values, selection of data entry options	14
3.3.5	Navigation with ↑ in Display	15
3.3.6	"Save changes" dialog	15
3.3.7	Security Passwords	15
3.4	Display	15
<b>4</b>	<b>Installation instruction</b>	<b>16</b>
4.1	Unpacking and inspection of equipment	16
4.1.1	Panel cutout dimensional information – 1/4DIN models	16
4.1.2	Installation procedure – 1/4DIN models	17
4.1.3	Panel cutout dimensional information – 1/2DIN models	18
4.1.4	Installation procedure – 1/2DIN models	19
4.1.5	Assembly – 1/2DIN version	19
4.1.6	1/2DIN version – Dimension drawings	20
4.1.7	1/2DIN version – Pipe mounting	20
4.1.8	1/4DIN version – Dimension drawings	21
4.2	Connection of power supply	22
4.2.1	1/4DIN housing (panel mount)	22
4.2.2	1/2DIN housing (wall mount)	23
4.3	Connector PIN definition	24
4.3.1	TB1 and TB2 for 1/2DIN and 1/4DIN versions	24
4.3.2	TB3 and TB4* for 1/2DIN and 1/4DIN versions – Conductivity Sensors	24
4.3.3	TB3 and TB4* for 1/2DIN and 1/4DIN versions – pH/ORP Sensors	25
4.3.4	TB3 and TB4* for 1/2DIN and 1/4DIN versions – Dissolved Oxygen/Dissolved Ozone Sensors (except 58 037 221)	25
4.3.5	TB3 and TB4* for 1/2DIN and 1/4DIN versions – Dissolved Oxygen Sensor 58 037 221 only (Thornton Models only)	26
4.3.6	TB3/TB4* – ISM (digital) Sensors for pH, Conductivity and Dissolved Oxygen	26
4.4	Connection of Analogue Sensor for pH/ORP	27
4.4.1	Connecting the Sensor to the VP Cable	27
4.4.2	VP Cable Assignment	28
4.4.3	Typical Wiring (Using TB3/TB4)	29
4.4.3.1	Example 1	29
4.4.3.2	Example 2	30
4.4.4	Example 3	31
4.4.4.1	Example 4	32
4.5	Connection of Analogue Sensor for Dissolved Oxygen/Dissolved Ozone (except 58 037 221)	33
4.5.1	Connecting the Sensor to the VP Cable	33
4.5.2	Typical Wiring using TB3/TB4	34
4.6	Connection of Analogue Sensor for Dissolved Oxygen 58 037 221	35

4.7	Connection of ISM Sensor	35
4.7.1	Connection of ISM Sensor for pH, Cond 4-e and Dissolved Oxygen	35
4.7.2	AK9 Cable Assignment	36
4.7.3	Connection of ISM Sensor for Cond 2-e (Thornton Models only)	36
4.7.4	Cable Assignment of ISM Sensor for Cond 2-e (Thornton Models only)	36
<b>5</b>	<b>Placing transmitter in, or out, of service</b>	<b>37</b>
5.1	Placing transmitter in service	37
5.2	Placing transmitter out of service	37
<b>6</b>	<b>Quick Setup</b>	<b>38</b>
<b>7</b>	<b>Sensor Calibration</b>	<b>39</b>
7.1	Enter Calibration Mode	39
7.2	Conductivity/Resistivity Calibration	40
7.2.1	One-point Sensor Calibration	41
7.2.2	Two-point Sensor Calibration (4-electrode sensors only)	41
7.2.3	Process Calibration	42
7.3	Oxygen Calibration	43
7.3.1	One-Point Sensor Calibration	43
7.3.2	Process Calibration	43
7.4	Ozone Calibration (Thornton Models only)	44
7.4.1	One-Point Sensor Calibration	44
7.5	pH Calibration	45
7.5.1	One Point Calibration	45
7.5.1.1	Auto Mode	45
7.5.1.2	Manual Mode	46
7.5.2	Two Point Calibration	46
7.5.2.1	Auto Mode	46
7.5.2.2	Manual Mode	47
7.5.3	Process Calibration	47
7.5.4	mV Calibration (not on ISM Version)	48
7.5.5	ORP Calibration (only on ISM Version)	48
7.6	Sensor Temperature Calibration (not on ISM Version)	49
7.6.1	One-Point Sensor Temperature Calibration (not on ISM Version)	49
7.6.2	Two-Point Sensor Temperature Calibration (not on ISM version)	50
7.7	Edit Sensor Calibration Constants (not on ISM version)	50
7.8	Sensor Verification	51
<b>8</b>	<b>Configuration</b>	<b>52</b>
8.1	Enter Configuration Mode	52
8.2	Measurement	52
8.2.1	Channel Setup	52
8.2.2	Derived Measurements (Thornton models only)	53
8.2.2.1	% Rejection measurement	54
8.2.2.2	Calculated pH (Power plant applications only)	54
8.2.2.3	Calculated CO <sub>2</sub> (Power plant applications only)	55
8.2.3	Temperature Source (not on ISM version)	55
8.2.4	Parameter Related Settings	56
8.2.4.1	Conductivity/Resistivity Temperature Compensation	57
8.2.4.2	pH/ORP Parameters	58
8.2.4.3	Dissolved Oxygen Parameters	59
8.2.5	Set Averaging	60
8.3	Analog Outputs	60
8.4	Setpoints	62
8.5	Alarm/Clean	65
8.5.1	Alarm	65
8.5.2	Clean	66
8.6	Display	66
8.6.1	Measurement	67
8.6.2	Resolution	67
8.6.3	Backlight	67
8.6.4	Name	68
8.7	Hold Analog Outputs	68

<b>9</b>	<b>System</b>	<b>69</b>
9.1	Set Language	69
9.2	USB	69
9.3	Passwords	70
9.3.1	Changing Passwords	70
9.3.2	Configuring Menu Access for Operator	70
9.4	Set/Clear Lockout	70
9.5	Reset	71
9.5.1	Reset System	71
9.5.2	Reset Meter Calibration (not on ISM version)	71
9.5.3	Reset Analog Calibration	72
9.5.4	Reset Sensor Calibration Data to Factory Settings	72
9.5.5	Reset Calibration Data of Sensor Electronic to Factory Settings	72
<b>10</b>	<b>PID Setup</b>	<b>73</b>
10.1	Enter PID Setup	74
10.2	PID Auto/Manual	75
10.3	Mode	75
10.3.1	PID Mode	75
10.4	Tune Parameters	77
10.4.1	PID Assignment & Tuning	77
10.4.2	Setpoint & Deadband	77
10.4.3	Proportional Limits	77
10.4.4	Corner Points	77
10.5	PID Display	78
<b>11</b>	<b>Service</b>	<b>79</b>
11.1	Enter Service Menu	79
11.2	Diagnostics	79
11.2.1	Model/Software Revision	79
11.2.2	Digital Input	80
11.2.3	Display	80
11.2.4	Keypad	80
11.2.5	Memory	80
11.2.6	Set Relay	81
11.2.7	Read Relays	81
11.2.8	Set Analog Outputs	81
11.2.9	Read Analog Outputs	81
11.3	Calibrate	82
11.3.1	Calibrate Meter (not on ISM version)	82
11.3.1.1	Resistance	82
11.3.1.2	Temperature	83
11.3.1.3	Current	84
11.3.1.4	Voltage	84
11.3.1.5	Rg Diagnostic	85
11.3.1.6	Rr Diagnostics	85
11.3.2	Calibrate Analog	86
11.3.3	Calibrate Unlock	86
11.4	Tech Service	86
<b>12</b>	<b>Info</b>	<b>87</b>
12.1	Info Menu	87
12.2	Messages	87
12.3	Calibration Data	87
12.4	Model/Software Revision	88
12.5	ISM Sensor Info (ISM version only)	88
<b>13</b>	<b>Maintenance</b>	<b>89</b>
13.1	For Technical Support	89
13.2	Front Panel Cleaning	89
<b>14</b>	<b>Troubleshooting</b>	<b>90</b>
14.1	Changing the Fuse	90
14.2	pH Error Messages / Warning- and Alarm List	91
14.3	O <sub>2</sub> Error Messages / Warning- and Alarm List	91
14.4	Cond Error Messages / Warning- and Alarm List	92
14.5	O <sub>2</sub> (I) Error Messages / Warning- and Alarm List (Thornton Models only)	92
14.6	O <sub>2</sub> (V) Error Messages / Warning- and Alarm List (Thornton Models only)	92
14.7	Ozone Error Messages / Warning- and Alarm List (Thornton Models only)	93

14.8	Warning- and Alarm indication on the display	93
14.8.1	Warning indication	93
14.8.2	Alarm indication	93
<b>15</b>	<b>Accessories and Spare Parts</b>	<b>94</b>
<b>16</b>	<b>Specifications</b>	<b>95</b>
16.1	General specifications	95
16.2	Electrical specifications for 1/2DIN and 1/4DIN versions	97
16.3	Mechanical specifications for 1/4DIN version	97
16.4	Mechanical specifications for 1/2DIN version	98
16.5	Environmental specifications for 1/2DIN and 1/4DIN versions	98
<b>17</b>	<b>Default tables</b>	<b>99</b>
17.1	M300 ISM (Single-Channel Instruments)	99
17.2	M300 ISM (Dual-Channel Instruments)	101
17.3	M300 Conductivity (Single-Channel Instruments)	103
17.4	M300 O <sub>2</sub> (Single-Channel Instruments)	104
17.5	M300 pH (Single-Channel Instruments)	106
17.6	M300 Multiparameter (Dual-Channel Instruments)	108
17.7	M300 Conductivity (Dual-Channel Instruments, Thornton Models only)	111
<b>18</b>	<b>Warranty</b>	<b>113</b>
<b>19</b>	<b>Certificate</b>	<b>114</b>
<b>20</b>	<b>Buffer tables</b>	<b>115</b>
20.1	Mettler-9	115
20.2	Mettler-10	115
20.3	NIST Technical Buffers	116
20.4	NIST standard buffers (DIN 19266: 2000-01)	116
20.5	Hach buffers	117
20.6	Ciba (94) buffers	117
20.7	Merck Titrisole, Riedel-de-Haën Fixanale	118
20.8	WTW buffers	118





# 1 Introduction

Statement of Intended Use – The M300 Multiparameter transmitter is a single- or dual channel online process instrument for measuring various properties of fluids. These include Conductivity/Resistivity, Dissolved Oxygen, Dissolved Ozone and pH/ORP. It will interface with a variety of different Mettler-Toledo sensors, which connect to the transmitter using cables of varied lengths.

Depending on the type, the transmitter can handle conventional analog sensors or the future oriented ISM (Intelligent Sensor Management) sensors.

A large four line backlit Liquid Crystal Display conveys measuring data and setup information. The menu structure allows the operator to modify all operational parameters by using keys on the front panel. A menu-lockout feature, with password protection, is available to prevent the unauthorized use of the meter. The M300 Multiparameter transmitter can be configured to use its 2 (4 on dual channel version) analog and/or 4 (6 on dual channel version) relay outputs for process control.

The M300 Multiparameter transmitter is equipped with a USB communication interface. This interface provides real-time data output and complete instrument configuration capabilities for central monitoring via Personal Computer (PC).

This manual applies for all available M300 transmitters as follows:

- Single parameter and single channel version for pH/ORP, dissolved Oxygen, Conductivity/Resistivity, and dissolved Ozone
- Multiparameter dual channel version for analog sensors
- Multiparameter single and dual channel version for ISM sensors
- Dual channel Cond/Cond version for analog sensors

## M300 parameter fit guide

### M300 Thornton models

Designation	Order no.	Analog Sensors	ISM Sensors
M300 ISM 1-channel 1/4DIN	58 000 301		pH, DO, Cond
M300 ISM 1-channel 1/2DIN	58 000 311		pH, DO, Cond
M300 ISM 2-channel 1/4DIN	58 000 302		pH, DO, Cond
M300 ISM 2-channel 1/2DIN	58 000 312		pH, DO, Cond
M300 pH 1-channel 1/4DIN	58 001 303	pH	
M300 pH 1-channel 1/2DIN	58 001 313	pH	
M300 Cond 1-channel 1/4DIN	58 002 301	Cond	
M300 Cond 1-channel 1/2DIN	58 002 311	Cond	
M300 Cond 2-channel 1/4DIN	58 001 304	Cond	
M300 Cond 2-channel 1/2DIN	58 001 314	Cond	
M300 Multi 2-channel 1/4DIN	58 001 306	pH, Cond, DO ppm, DO ppb, O3	
M300 Multi 2-channel 1/2DIN	58 001 316	pH, Cond, DO ppm DO ppb, O3	

### M300 Ingold models

Designation	Order no.	Analog Sensors	ISM Sensors
M300 ISM 1-channel 1/4DIN	52 121 354		pH, DO, Cond 4-e
M300 ISM 1-channel 1/2DIN	52 121 355		pH, DO, Cond 4-e
M300 ISM 2-channel 1/4DIN	52 121 356		pH, DO, Cond 4-e
M300 ISM 2-channel 1/2DIN	52 121 357		pH, DO, Cond 4-e
M300 pH 1-channel 1/4DIN	52 121 286	pH	
M300 pH 1-channel 1/2DIN	52 121 289	pH	
M300 Cond 1-channel 1/4DIN	52 121 288	Cond	
M300 Cond 1-channel 1/2DIN	52 121 291	Cond	
M300 O2 1-channel 1/4DIN	52 121 287	DO	
M300 O2 1-channel 1/2DIN	52 121 290	DO	
M300 Multi 2-channel 1/4DIN	52 121 292	pH, Cond, DO	
M300 Multi 2-channel 1/2DIN	52 121 293	pH, Cond, DO	

The print screen images in this manual have a general explaining character and can differ from the real display in your transmitter.

This description corresponds to the firmware release, version 1.3 of the M300 ISM transmitter and version 1.5 for all other M300 transmitters. Changes are taking place constantly, without prior notification

## 2 Safety instructions

This manual includes safety information with the following designations and formats.

### 2.1 Definition of equipment and documentation symbols and designations



**WARNING:** POTENTIAL FOR PERSONAL INJURY.



**CAUTION:** possible instrument damage or malfunction.



**NOTE:** Important operating information.



**On the transmitter or in this manual text indicates:** Caution and/or other possible hazard including risk of electric shock (refer to accompanying documents).

The following is a list of general safety instructions and warnings. Failure to adhere to these instructions can result in damage to the equipment and/or personal injury to the operator.

- The M300 Transmitter should be installed and operated only by personnel familiar with the transmitter and who are qualified for such work.
- The M300 Transmitter must only be operated under the specified operating conditions (see section 16).
- Repair of the M300 Transmitter must be performed by authorized, trained personnel only.
- With the exception of routine maintenance, cleaning procedures or fuse replacement, as described in this manual, the M300 Transmitter must not be tampered with or altered in any manner.
- Mettler-Toledo accepts no responsibility for damage caused by unauthorized modifications to the transmitter.
- Follow all warnings, cautions, and instructions indicated on and supplied with this product.
- Install equipment as specified in this instruction manual. Follow appropriate local and national codes.
- Protective covers must be in place at all times during normal operation.
- If this equipment is used in a manner not specified by the manufacturer, the protection provided by it against hazards may be impaired.

#### **WARNINGS:**

Installation of cable connections and servicing of this product require access to shock hazard voltage levels.

Main power and relay contacts wired to separate power source must be disconnected before servicing.

Switch or circuit breaker shall be in close proximity to the equipment and within easy reach of the OPERATOR; it shall be marked as the disconnecting device for the equipment.

Main power must employ a switch or circuit breaker as the disconnecting device for the equipment.

Electrical installation must be in accordance with the National Electrical Code and/or any other applicable national or local codes.



**NOTE! RELAY CONTROL ACTION:** the M300 transmitter relays will always de-energize on loss of power, equivalent to normal state, regardless of relay state setting for powered operation. Configure any control system using these relays with fail-safe logic accordingly.



**NOTE! PROCESS UPSETS:** Because process and safety conditions may depend on consistent operation of this transmitter, provide appropriate means to maintain operation during sensor cleaning, replacement or sensor or instrument calibration.



**NOTE:** This is a 4-wire-product with an active 4–20 mA analog output.  
Please do not supply to Pin1–Pin6 of TB2.

## **2.2 Correct disposal of the unit**

When the transmitter is finally removed from service, observe all local environmental regulations for proper disposal.

### 3 Unit overview

M300 models are available in both a 1/4DIN and 1/2DIN case size. The 1/4DIN is a panel-mount only design and the 1/2DIN models provide an integral IP65 housing for wall-, or pipe-mount.

#### 3.1 Overview 1/4DIN

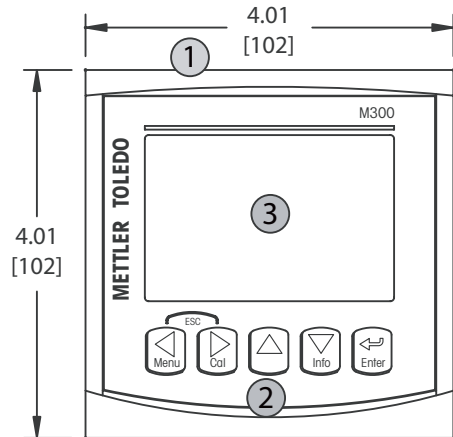
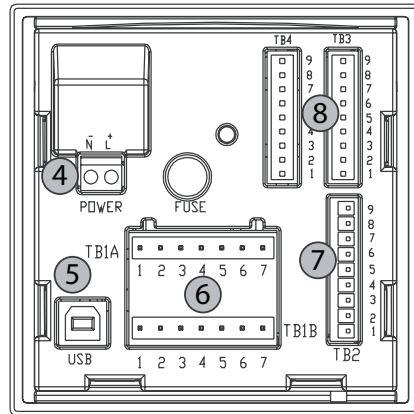

- 1: Hard Polycarbonate case
- 2: Five Tactile-Feedback Navigation Keys
- 3: Four-line LCD Display
- 4: Power Supply Terminals

- 5: USB Interface Port
- 6: Relay Output Terminals
- 7: Analog Output/Digital Input Terminals
- 8: Sensor Input Terminals

#### 3.2 Overview 1/2DIN

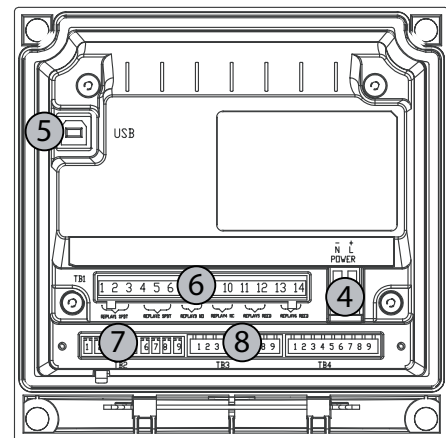
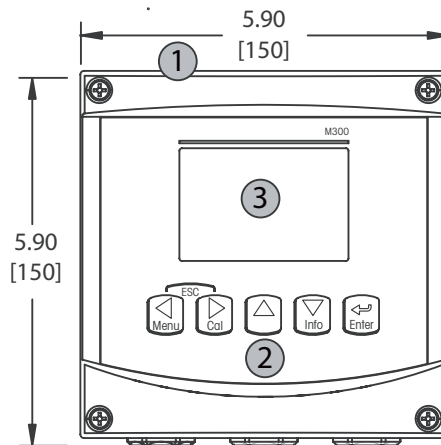

- 1: Hard Polycarbonate case
- 2: Five Tactile-Feedback Navigation Keys
- 3: Four-line LCD Display
- 4: Power Supply Terminals

- 5: USB Interface Port
- 6: Relay Output Terminals
- 7: Analog Output/Digital Input Terminals
- 8: Sensor Input Terminals

### 3.3 Control/Navigation Keys

#### 3.3.1 Menu Structure

Below is the structure of the M300 menu tree:

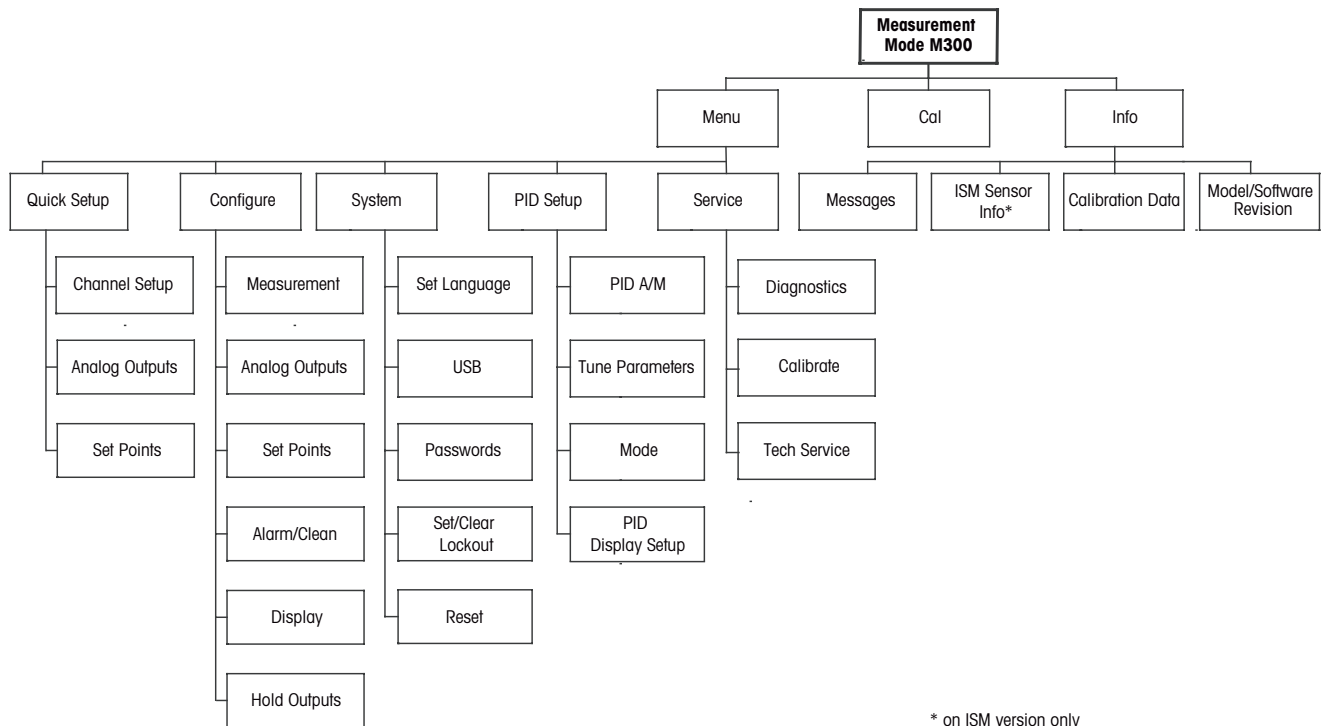

#### 3.3.2 Navigation keys



##### 3.3.2.1 Navigating the menu tree

Enter the desired main Menu branch with the ◀ ▶ or ▲ keys. Use the ▲ and ▼ keys to navigate through the selected Menu branch.



**NOTE:** In order to back up one menu page, without escaping to the measurement mode, move the cursor under the UP Arrow character (↑) at the bottom right of the display screen and press [Enter].

### 3.3.2.2 Escape

Press the ◀ and ▶ key simultaneously (escape) to return to the Measurement mode.

### 3.3.2.3 Enter

Use the ↵ key to confirm action or selections.

### 3.3.2.4 Menu

Press the ◀ key to access the main Menu.

### 3.3.2.5 Calibration mode

Press the ▶ key to enter Calibration Mode.

### 3.3.2.6 Info mode

Press the ▼ key to enter Info Mode

## 3.3.3 Navigation of data entry fields

Use the ▶ key to navigate forward or the ◀ key to navigate backwards within the changeable data entry fields of the display.

## 3.3.4 Entry of data values, selection of data entry options

Use the ▲ key to increase or the ▼ key to decrease a digit. Use the same keys to navigate within a selection of values or options of a data entry field.

**NOTE:** Some screens require configuring multiple values via the same data field (ex: configuring multiple setpoints). Be sure to use the ▶ or ◀ key to return to the primary field and the ▲ or ▼ key to toggle between all configuration options before entering to the next display screen.



### 3.3.5 Navigation with ↑ in Display

If a ↑ is displayed on the bottom right hand corner of the display, you can use the ► or the ◀ key to navigate to it. If you click [ENTER] you will navigate backwards through the menu (go back one screen). This can be a very useful option to move back up the menu tree without having to exit into the measuring mode and re-enter the menu.

### 3.3.6 "Save changes" dialog

Three options are possible for the "Save changes" dialog: Yes & Exit (Save changes and exit to measuring mode), "Yes & ↑" (Save changes and go back one screen) and "No & Exit" (Don't save changes and exit to measuring mode). The "Yes & ↑" option is very useful if you want to continue configuring without having to re-enter the menu.

### 3.3.7 Security Passwords

The M300 transmitter allows a security lock-out of various menus. If the security lock-out feature of the transmitter has been enabled, a security password must be entered to allow access to the menu. See section 9.3 for more information.

## 3.4 Display



**NOTE:** In the event of an alarm or other error condition the M300 Transmitter will display a flashing ⚠ in the upper right corner of the display. This symbol will remain until the condition that caused it has been cleared.



**NOTE:** During calibrations, clean, Digital In with Analog Output/Relay/USB in Hold state, a flashing H will appear in the upper left corner of the display. This symbol will remain for 20 seconds until after the calibration or clean is completed. This symbol will also disappear when Digital In is deactivated.

## 4 Installation instruction

### 4.1 Unpacking and inspection of equipment

Inspect the shipping container. If it is damaged, contact the shipper immediately for instructions. Do not discard the box.

If there is no apparent damage, unpack the container. Be sure all items shown on the packing list are present.

If items are missing, notify Mettler-Toledo immediately.

#### 4.1.1 Panel cutout dimensional information – 1/4DIN models

1/4DIN Model transmitters are designed for panel-mount installation only. Each transmitter is supplied with mounting hardware to provide fast and simple installation to a flat panel or flat enclosure door. To insure a good seal and maintain IP integrity of installation, the panel or door must be flat and have a smooth finish. Hardware consists of:

- 2 snap-on Mounting brackets
- 1 mounting gasket seal

Transmitter dimensions and mounting are shown in the figures below.

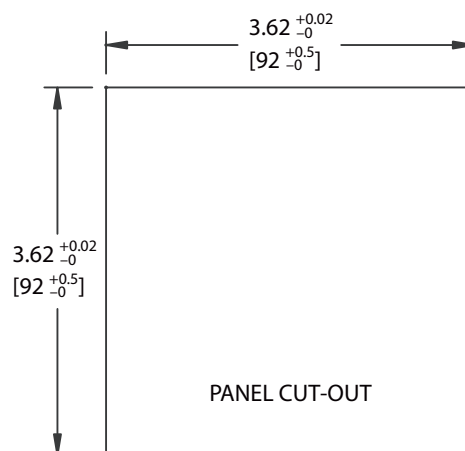



## 4.1.2 Installation procedure – 1/4DIN models

- Make cutout in panel (see dimensions cutout drawing).
- Be sure surface surrounding cutout is clean, smooth and free of burrs.
- Slide face gasket (supplied with transmitter) around transmitter from the back of the unit.
- Place transmitter into cutout hole. Be sure there are no gaps between the transmitter and panel surface.
- Place the two mounting brackets on either side of the transmitter as shown.
- While holding transmitter firmly into the cutout hole, push the mounting brackets toward the backside of panel.
- Once secure, use a screwdriver to tighten the brackets against the panel. In order to provide IP65 environmental enclosure rating, the two clamps provided shall be securely tightened to create an adequate seal between the panel enclosure and M300 front face.
- Face gasket will compress between transmitter and panel.



**CAUTION:** Do not over tighten brackets.

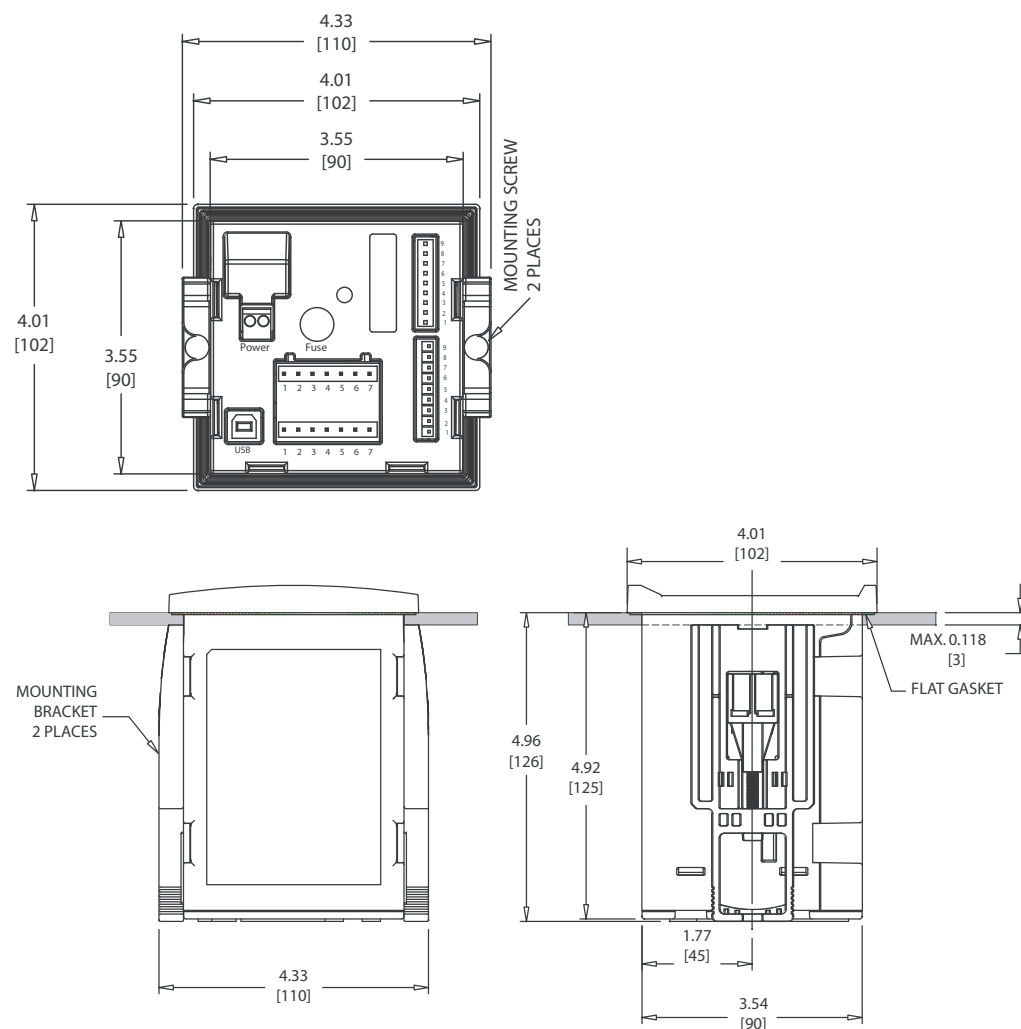

### 4.1.3 Panel cutout dimensional information – 1/2DIN models

1/2DIN Model transmitters are designed with an integral rear cover for stand-alone wall mount installation.

The unit may also be wall mounted using the integral rear cover. See installation instructions in Section 4.1.4.

Below are cut-out dimensions required by the 1/2DIN models when mounted within a flat panel or on a flat enclosure door. This surface must be flat and smooth. Textured or rough surfaces are not recommended and may limit the effectiveness of the gasket seal provided.

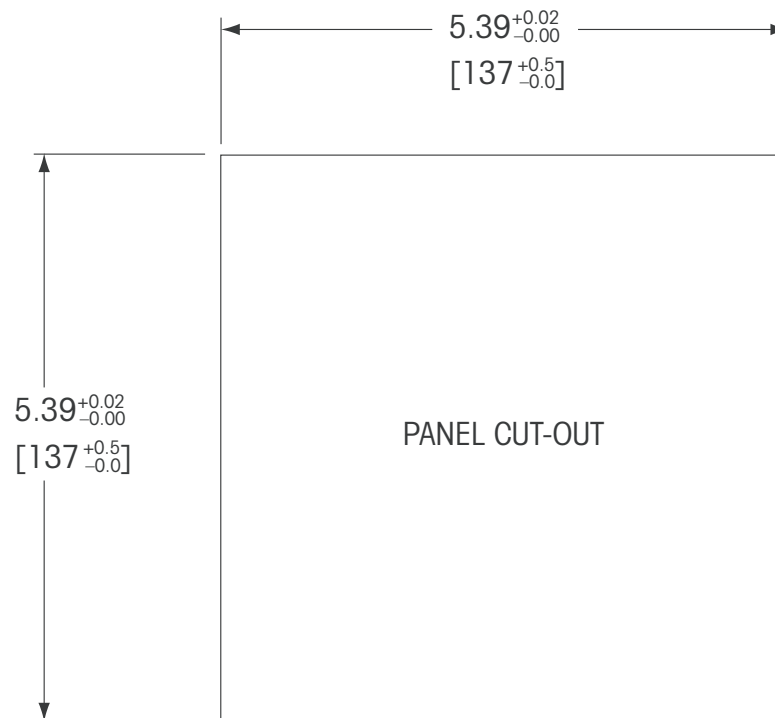

Optional hardware accessories are available that allow for panel- or pipe-mount. Refer to Section 15 "Accessories and Spare Parts" for ordering information.

## 4.1.4 Installation procedure – 1/2DIN models

General:

- Orient the transmitter so that the cable grips face downward.
- Wiring routed through the cable grips shall be suitable for use in wet locations.
- In order to provide IP65 enclosure ratings, all cable glands must be in place. Each cable gland must be filled using a cable, or suitable Cable Gland Hole Seal.

**For Wall Mount:**

- Remove rear cover from front housing.
- Start by unscrewing the four screws located on the face of the transmitter, in each corner. This allows the front cover to swing away from the rear housing.
- Remove the hinge-pin by squeezing the pin from each end. This allows the front housing to be removed from the rear housing.
- Mount rear housing to wall. Secure mounting kit to the M300 according to the supplied instructions. Attach to wall using appropriate mounting hardware for wall surface. Be sure it is level and securely fastened and the installation adheres to any and all clearance dimensions required for transmitter service and maintenance. Orient the transmitter so that the cable grips are facing downward.
- Replace the front housing to the rear housing. Securely tighten the rear-cover screws to ensure that IP65 enclosure environmental rating is provided. The unit is ready to be wired.

**For Pipe Mount:**

- Use only manufacturer-supplied components for pipe-mounting the M300 transmitter and install per the supplied instructions. See section 15 for ordering information.

## 4.1.5 Assembly – 1/2DIN version

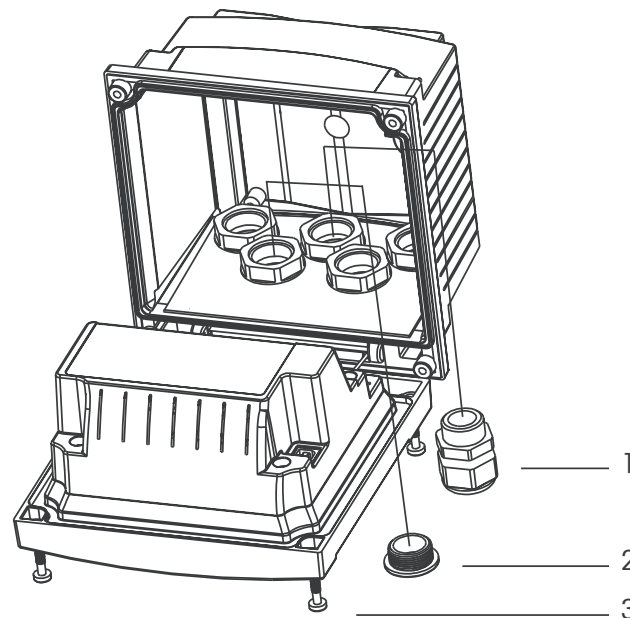

- 1: 3 Pg 13.5 cable glands  
 2: 2 plastic plugs  
 3: 4 screws

### 4.1.6 1/2DIN version – Dimension drawings

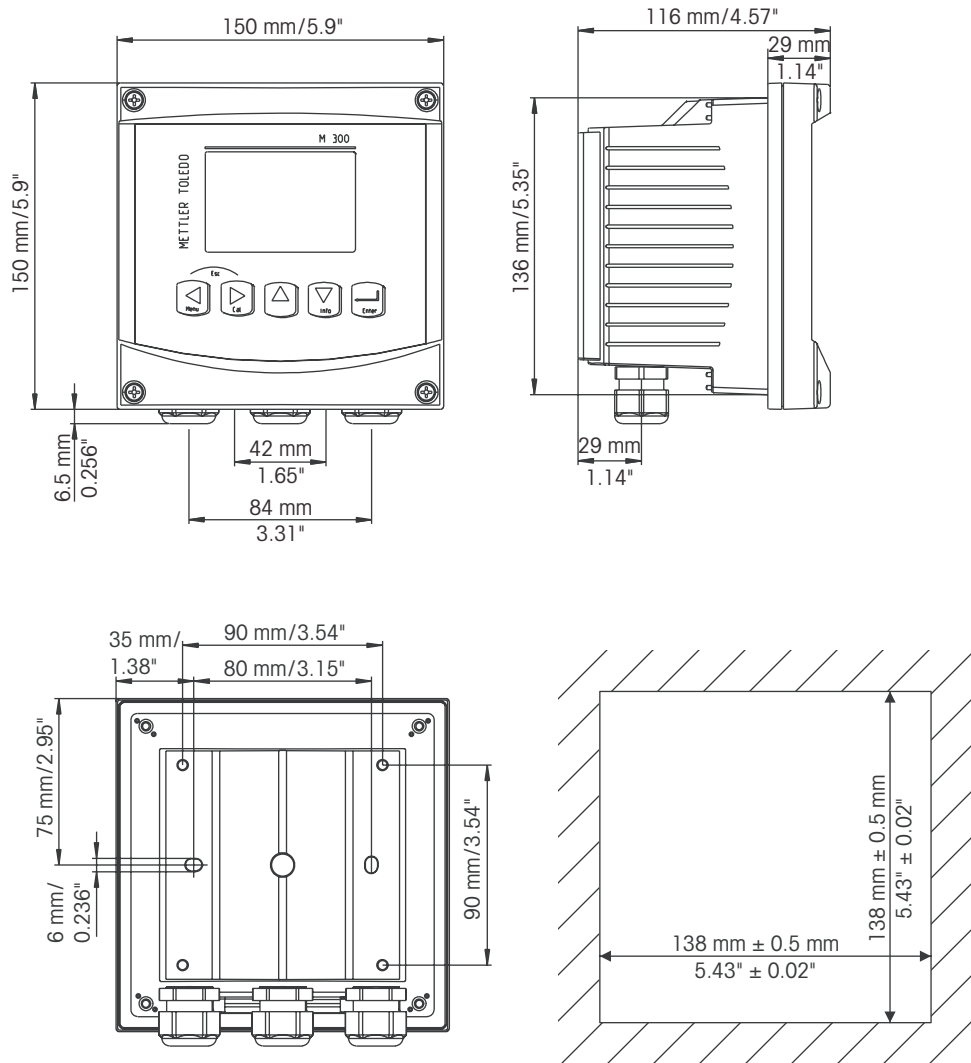

### 4.1.7 1/2DIN version – Pipe mounting

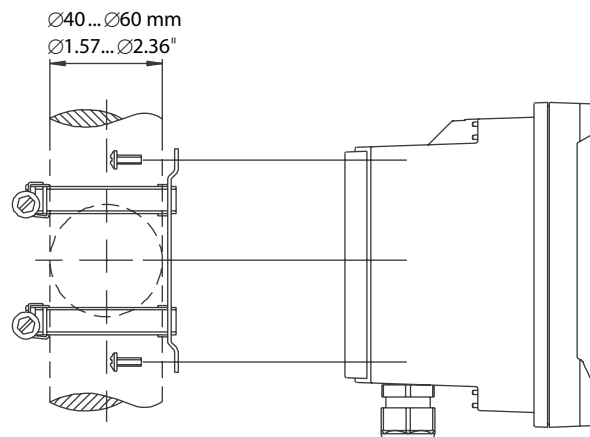

### 4.1.8 1/4DIN version – Dimension drawings

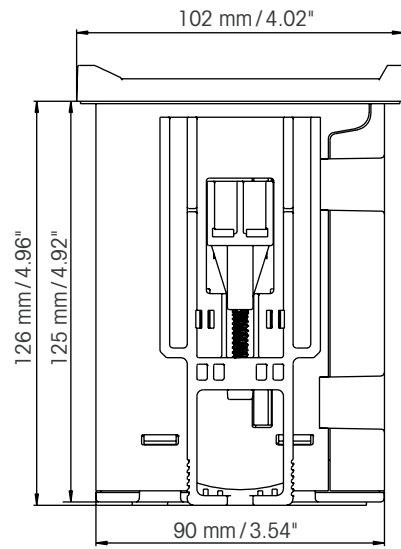
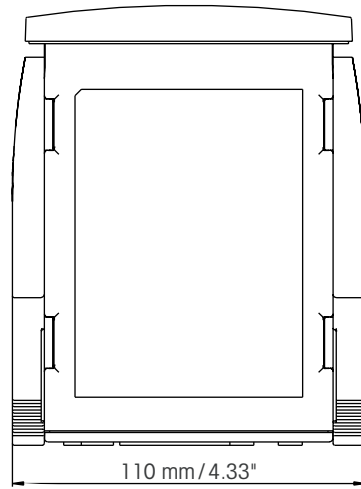
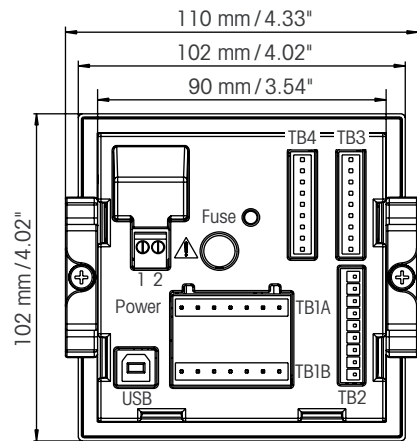
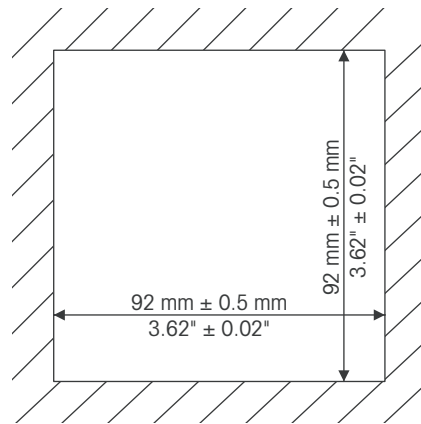

## 4.2 Connection of power supply

All connections to the transmitter are made on the rear panel of all models.



Be sure power to all wires is turned off before proceeding with the installation. High voltage may be present on the input power wires and relay wires.

A two-terminal connector on the rear panel of all M300 models is provided for power connection. All M300 models are designed to operate from a 20–30 VDC or a 100 to 240 VAC power source. Refer to specifications for power requirements and ratings and size power wiring accordingly.

The terminal block for power connections is labeled “Power” on the rear panel of the transmitter. One terminal is labeled **-N** for the Neutral wire and the other **+L** for the Line (or Load) wire. The terminals are suitable for single wires and flexible leads up to 2.5 mm<sup>2</sup> (AWG 14). There is no earth ground terminal on the transmitter. For this reason the internal power wiring within the transmitter is double insulated and the product label designates this using the □ symbol.

### 4.2.1 1/4DIN housing (panel mount)

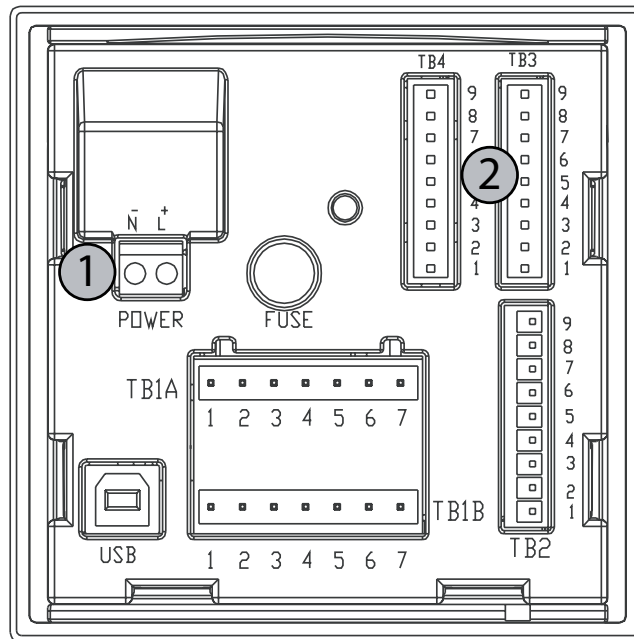

- 1: Connection of power supply
- 2: Terminal for sensors

### 4.2.2 1/2DIN housing (wall mount)

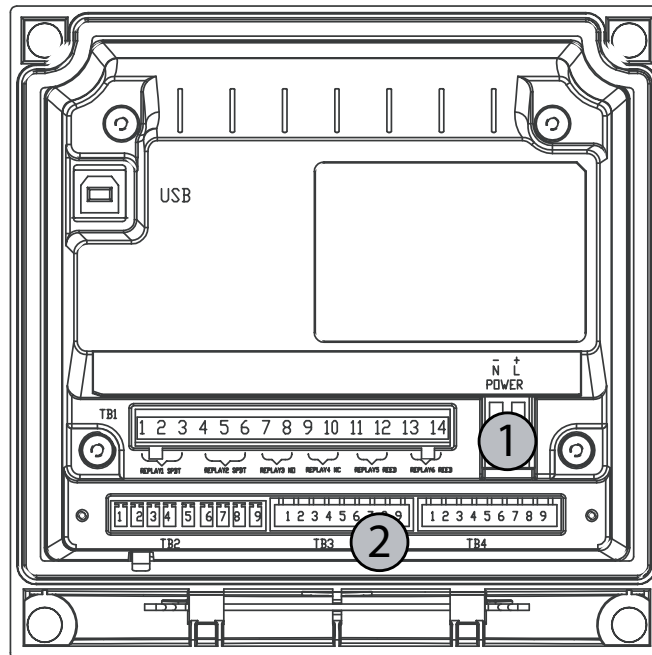

- 1: Connection of power supply
- 2: Terminal for sensors

### 4.3 Connector PIN definition

#### 4.3.1 TB1 and TB2 for 1/2DIN and 1/4DIN versions

Power connections are labeled –N for Neutral and +L for Line, for 100 to 240 VAC or 20–30 VDC.

1	AO1+
2	AO1-/AO2-
3	AO2+
4	AO3+*
5	AO3-/AO4-*
6	AO4+*
7	DI1+
8	DI1-/DI2-*
9	DI2+*

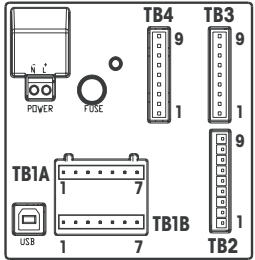

1	NO2
2	COM2
3	NC2
4	NO6*
5	COM6*
6	NO4
7	COM4

1	NO1
2	COM1
3	NC1
4	NC5*
5	COM5*
6	NO3
7	COM3

1	AO1+
2	AO1-/AO2-
3	AO2+
4	AO3+*
5	AO3-/AO4-*
6	AO4+*
7	DI1+
8	DI1-/DI2-*
9	DI2+*

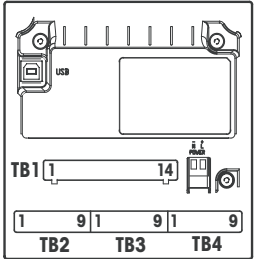

1	NO1	8	NC5*
2	COM1	9	COM6*
3	NC1	10	NO6*
4	NO2	11	NO3
5	COM2	12	COM3
6	NC2	13	NO4
7	COM5*	14	COM4

\* Dual channel only

NO: normally open (contact open if un-actuated)  
 NC: normally closed (contact closed if un-actuated)

AO: Analog Output  
 DI: Digital Input

#### 4.3.2 TB3 and TB4\* for 1/2DIN and 1/4DIN versions – Conductivity Sensors

TB 3 provides access to channel A signal inputs, TB4\* provides access to channel B signal inputs.

Conductivity sensors use 58 080 20X or 58 080 25X series cables.

Pin no.	Sensor wire Color**	Function
1	white	Cnd inner 1
2	white/blue	Cnd outer 1
3	blue	Cnd inner 2
4	black	Cnd outer 2/ Shield
5	–	not used
6	bare shield	RTD ret/GND
7	red	RTD sense
8	green	RTD
9	–	+5V

\* Only on dual channel version

\*\* Transparent not connected.

Terminal 4 and 6 are internally connected, either terminal can be used to connect a wire.



### 4.3.3 TB3 and TB4\* for 1/2DIN and 1/4DIN versions – pH/ORP Sensors

pH/ORP sensors use 52 300 1XX series VP cables, or 10 001 XX02 series AS9 cables (ORP only).

Pin no.	Sensor wire Color	Function
1	Coax inner/transparent	Glass
2		not used
3**	Coax shield/red	Reference
4**	green/yellow, blue	Solution GND/Shield
5	–	not used
6	white	RTD ret/GND
7		RTD sense
8	green	RTD
9	–	+5V
	grey (no connection)	

\* Only on dual channel version.

Terminal 4 and 6 are internally connected, either terminal can be used to connect a wire.



**NOTE:** \*\* Install Jumper 3 to 4 when used without Solution Ground.



**NOTE:** For sensors with Pt100 temperature probe, the Pt100 adapter is required. The Pt100 adapter is enclosed in the package of each transmitter.

### 4.3.4 TB3 and TB4\* for 1/2DIN and 1/4DIN versions – Dissolved Oxygen/Dissolved Ozone Sensors (except 58 037 221)

These sensors use 52 300 1XX series VP cables.

Pin no.	Sensor wire Color	Function
1**	–	not used
2	Coax Shield/red	Anode
3**	–	not used
4**	green/yellow	Shield/GND
5	Coax Inner/transparent	Cathode
6	white, grey	Temperature, Guard
7	–	not used
8	green	Temperature
9	–	+5V

Blue wire not used.

\* Only on dual channel version.

Terminal 4 and 6 are internally connected, either terminal can be used to connect a wire.



**NOTE:** \*\* Install Jumper (supplied) 1 to 3 to 4 when using Thornton Dissolved Oxygen and Ozone Sensors.

### 4.3.5 TB3 and TB4\* for 1/2DIN and 1/4DIN versions – Dissolved Oxygen Sensor 58 037 221 only (Thornton Models only)

This sensor uses 58 080 25X series cables.

Pin no.	Sensor wire Color	Function
1	white	Signal
2	white/blue,	Range
3	–	
4	black, bare shield	Shield, Ground
5	–	
6	Transparent	Ground
7	Red	Temperature
8	Green	Temperature
9	Blue	+5V

\* Only on dual channel version.

Terminal 4 and 6 are internally connected, either terminal can be used to connect a wire.

### 4.3.6 TB3/TB4\* – ISM (digital) Sensors for pH, Conductivity and Dissolved Oxygen

The wiring of the digital 9 terminal connectors is:

Pin no.	Function	pH, Oxygen, Cond 4-e Color	Cond 2-e*** Color**
1	24 VDC	–	–
2	GND (24 VDC)	–	–
3	1-Wire	transparent (cable core)	–
4	GND (5 VDC)	red (shield)	–
5	–	–	–
6	GND (5 VDC)	–	white
7	RS485-B	–	black
8	RS485-A	–	red
9	5 VDC	–	blue

\* Only on dual channel version

\*\* Bare wire not connected

\*\*\* For Thornton models only

## 4.4 Connection of Analogue Sensor for pH/ORP

### 4.4.1 Connecting the Sensor to the VP Cable

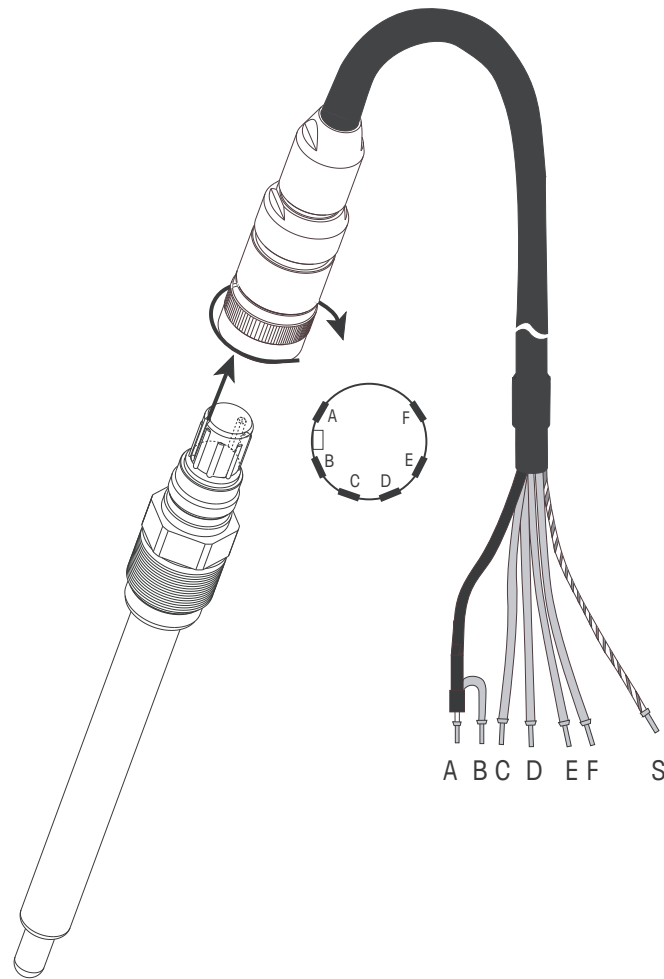

**NOTE:** Cable lengths > 20 m can worsen the response during pH measurement. Be sure to observe the sensor instruction manual.

### 4.4.2 VP Cable Assignment

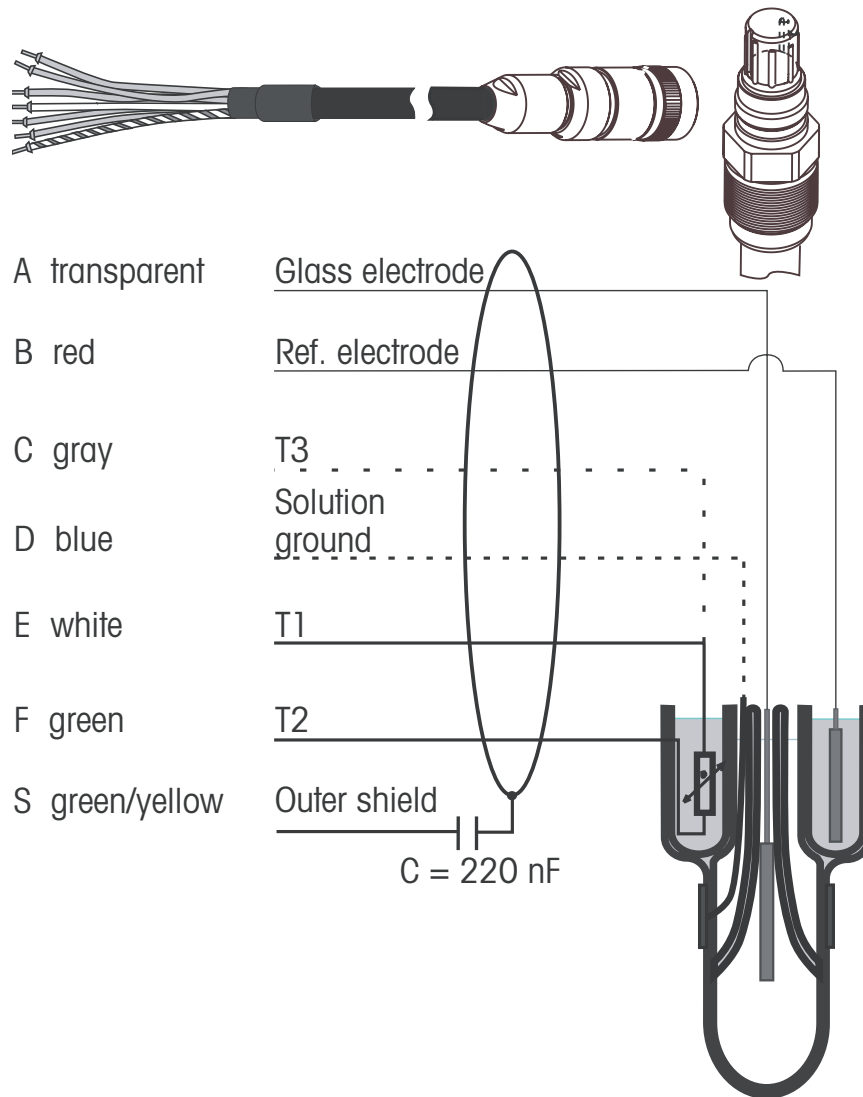

T1/T2: Temperature probe for 2-wire connection

T3: Additional connection for temperature probe (3-wire connection)

### 4.4.3 Typical Wiring (Using TB3/TB4)

#### 4.4.3.1 Example 1

pH measurement without Solution Ground.

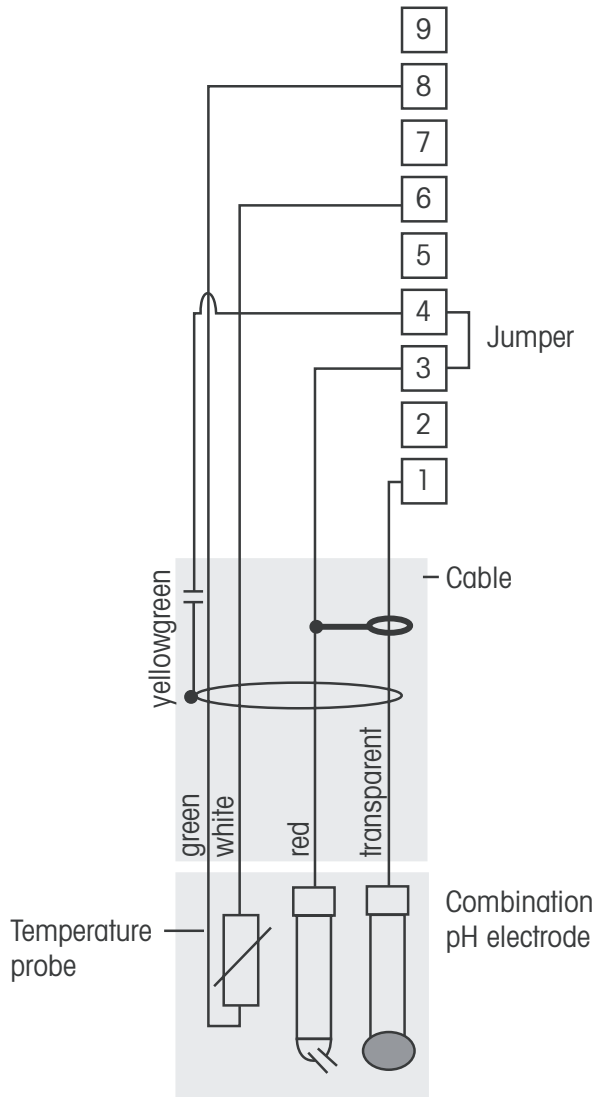

#### Pt100 Adapter wiring diagramm for TB3/4

Change M300 setting to Pt100 under Configuration/Measurement/Temperature Source

#### 2-wire

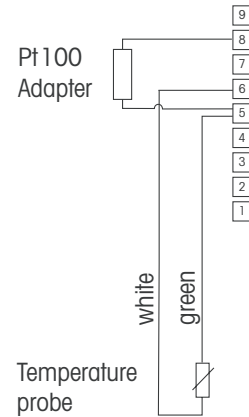

#### 3-wire

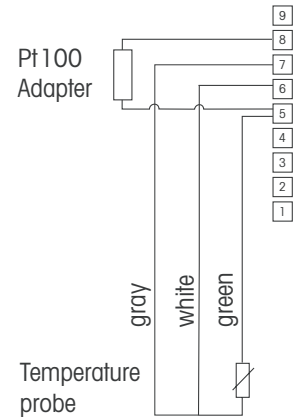

**NOTE:** Jumper Terminals 3 and 4.



**NOTE:** Pt100 adapter required (enclosed) for sensors with Pt100 temperature probe. For wiring details see page 24.

Wire colors only valid for connection with VP cable; blue and grey not connected.

- |               |                         |
|---------------|-------------------------|
| 1: Glass      | 6: Solution GND/RTD ref |
| 2: Not used   | 7: Not used             |
| 3: Reference  | 8: RTD                  |
| 4: Shield/GND | 9: Not used             |
| 5: Not used   |                         |

### 4.4.3.2 Example 2

pH measurement with Solution Ground

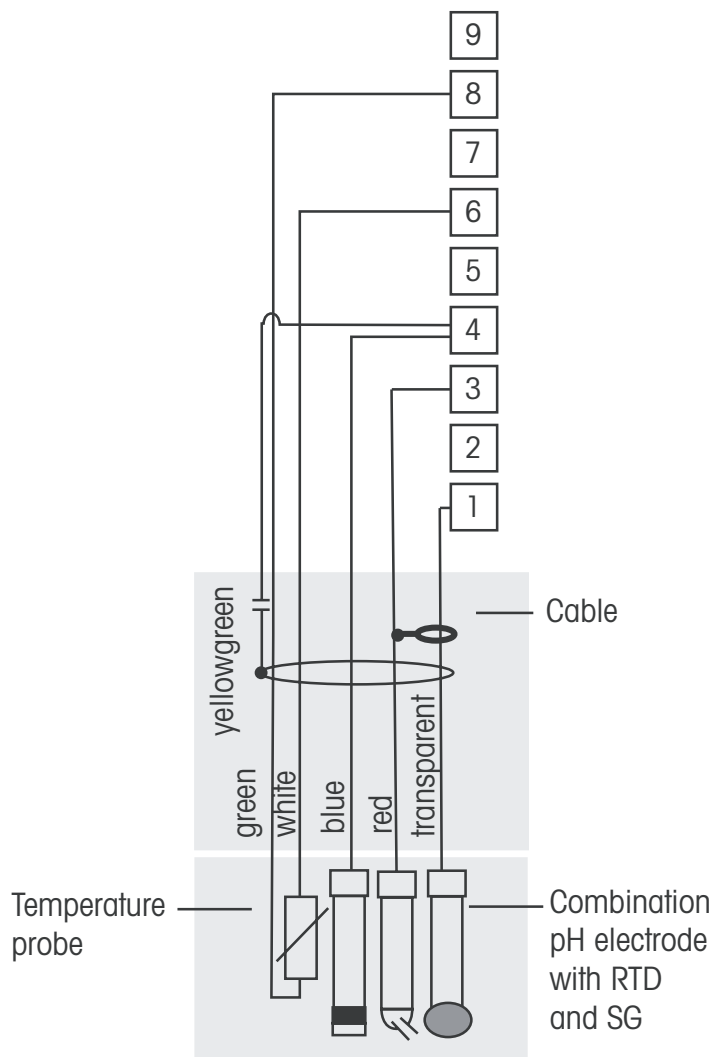

**NOTE:** Wire colors only valid for connection with VP cable, grey not connected.



**NOTE:** Pt100 adapter required (enclosed) for sensors with Pt100 temperature probe.  
For wiring details see page 24.

- |                        |                |
|------------------------|----------------|
| 1: Glass               | 6: GND/RTD ret |
| 2: Not used            | 7: Not used    |
| 3: Reference           | 8: RTD         |
| 4: Shield/Solution GND | 9: Not used    |
| 5: Not used            |                |

### 4.4.4 Example 3

ORP (redox) measurement (temperature optional).

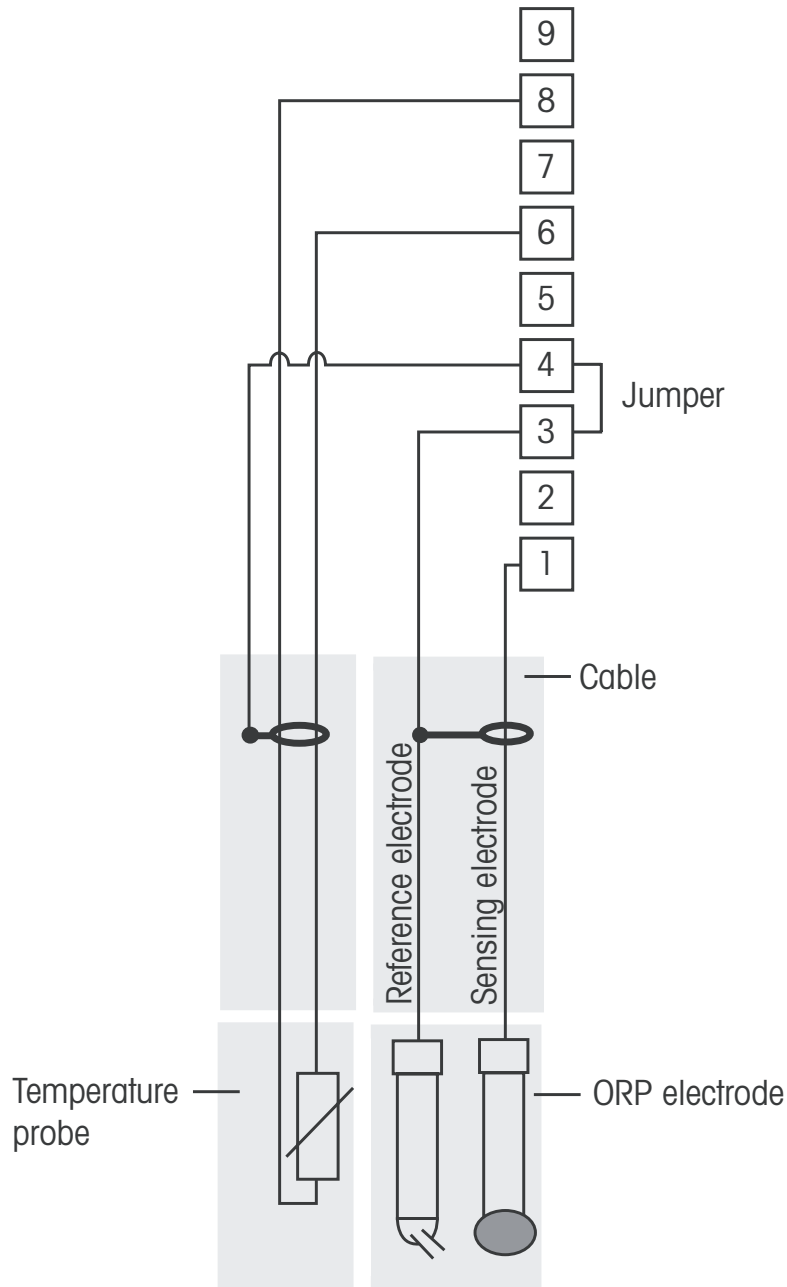

**NOTE:** Jumper Terminal 3 and 4.



**NOTE:** Pt100 adapter required (enclosed) for sensors with Pt100 temperature probe.  
For wiring details see page 24.

- |               |             |
|---------------|-------------|
| 1: Platinum   | 6: RTD ref  |
| 2: Not used   | 7: Not used |
| 3: Reference  | 8: RTD      |
| 4: Shield/GND | 9: Not used |
| 5: Not used   |             |

### 4.4.4.1 Example 4

ORP measurement with pH Solution ground electrode (e.g. InPro 3250SG, InPro 4800SG).

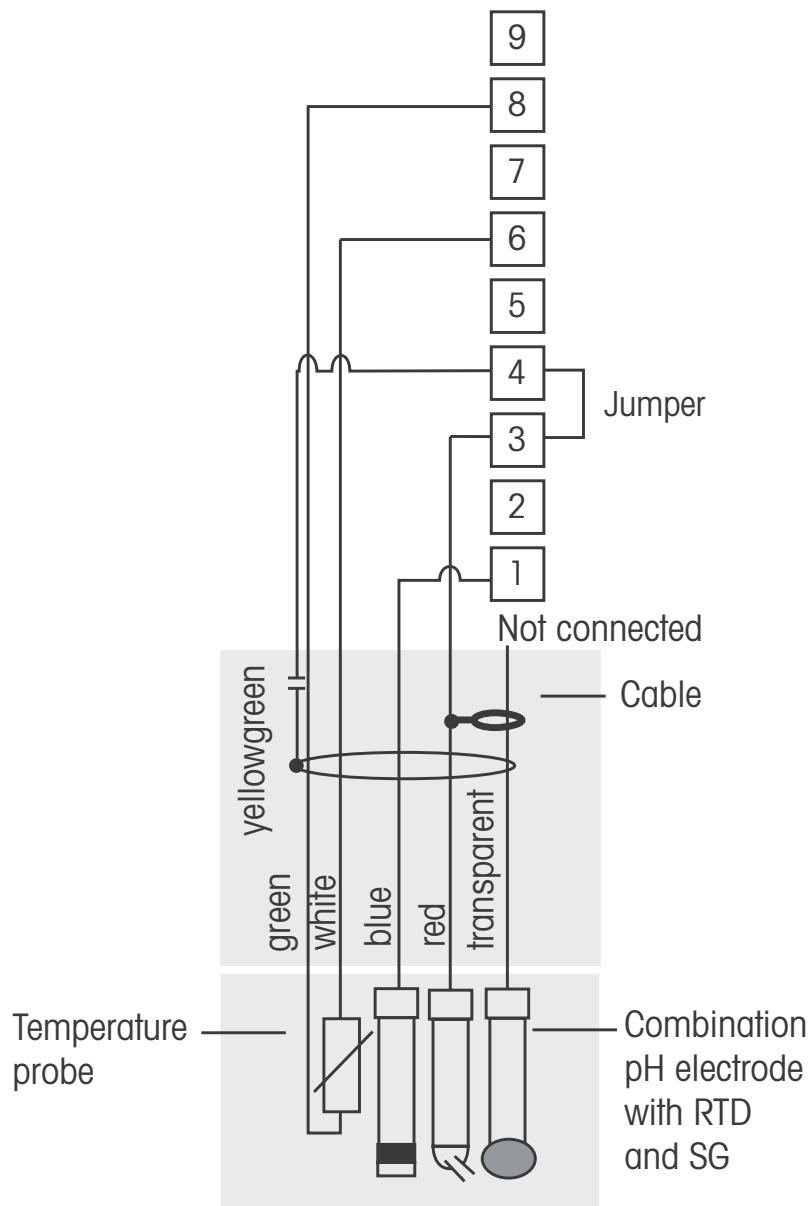

**NOTE:** Jumper Terminal 3 and 4.



**NOTE:** Pt100 adapter required (enclosed) for sensors with Pt100 temperature probe.  
For wiring details see page 24.

- |               |             |
|---------------|-------------|
| 1: Platinum   | 6: RTD ref  |
| 2: Not used   | 7: Not used |
| 3: Reference  | 8: RTD      |
| 4: Shield/GND | 9: Not used |
| 5: Not used   |             |



## 4.5 Connection of Analogue Sensor for Dissolved Oxygen/Dissolved Ozone (except 58 037 221)

### 4.5.1 Connecting the Sensor to the VP Cable

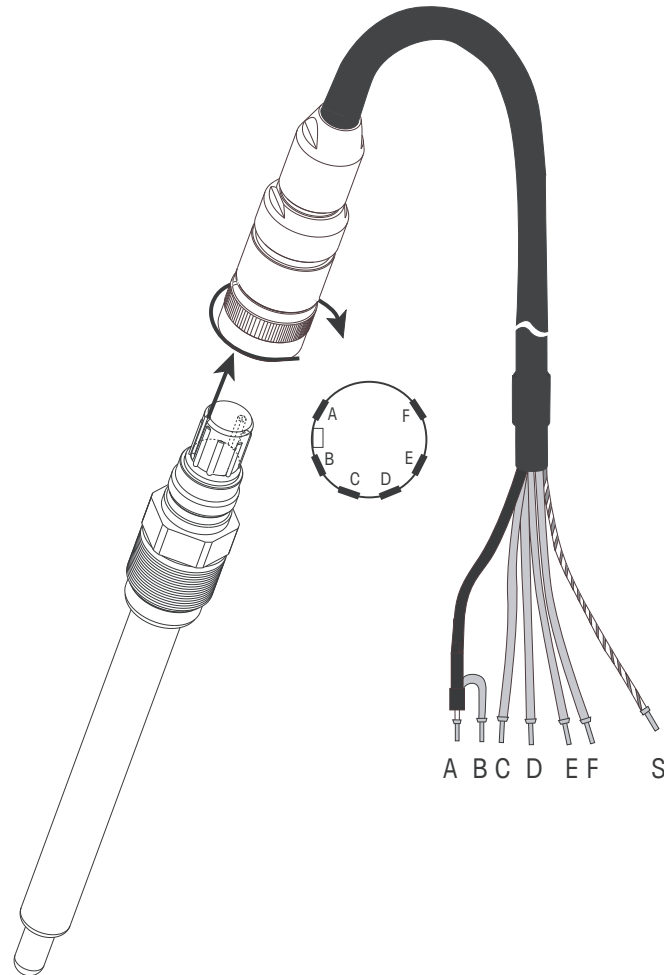

**NOTE:** Be sure to observe the sensor instruction manual.

### 4.5.2 Typical Wiring using TB3/TB4

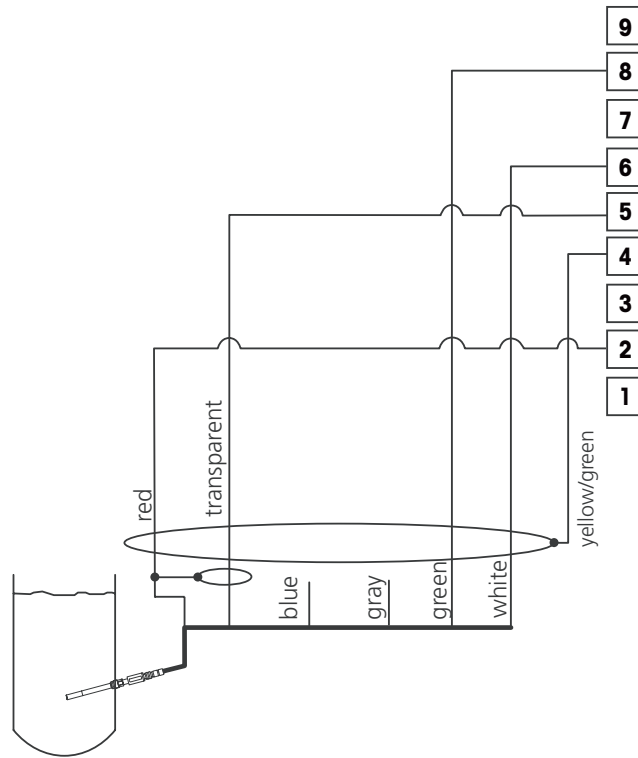

**NOTE:** Wire colors only valid for connection with VP cable, blue not connected.

M300 connector:

- 1: not used
- 2: Anode
- 3: not used
- 4: Shield/GND
- 5: Cathode
- 6: NTC ref, Guard
- 7: Not used
- 8: NTC 2
- 9: not used

## 4.6 Connection of Analogue Sensor for Dissolved Oxygen 58 037 221

This sensor consists of a Thornton Long Life dissolved oxygen probe that comes directly wired to a preamplifier box. The preamplifier connects to the M300 using a 58 080 25X series cable. Use the connections shown in the last table of section 4.3 and follow the additional instructions supplied with the sensor.

## 4.7 Connection of ISM Sensor

### 4.7.1 Connection of ISM Sensor for pH, Cond 4-e and Dissolved Oxygen

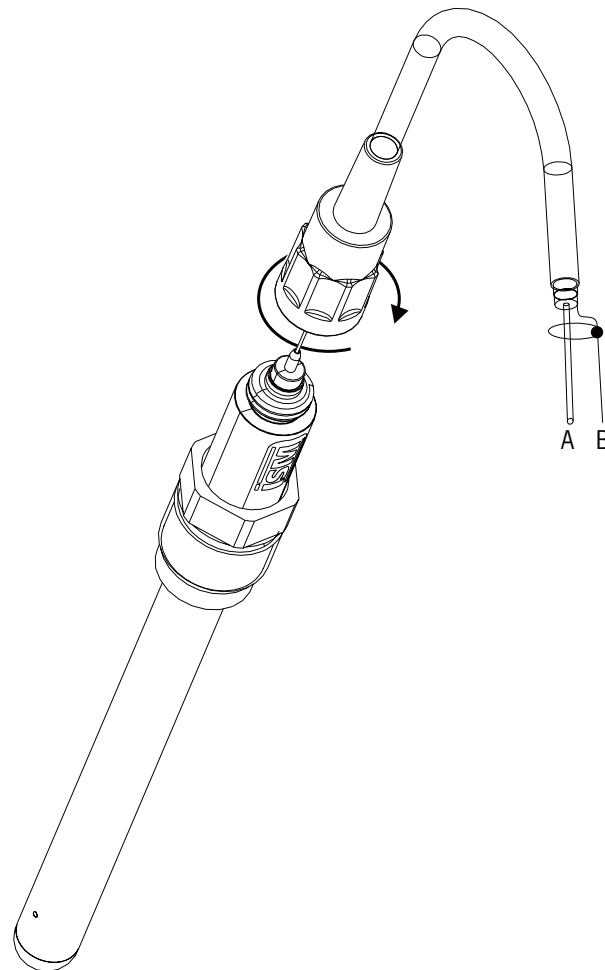

**NOTE:** Connect the Sensor and screw the plug head clockwise (hand tight).

### 4.7.2 AK9 Cable Assignment

- A: 1-wire data (transparent)
- B: Ground/shield

### 4.7.3 Connection of ISM Sensor for Cond 2-e (Thornton Models only)

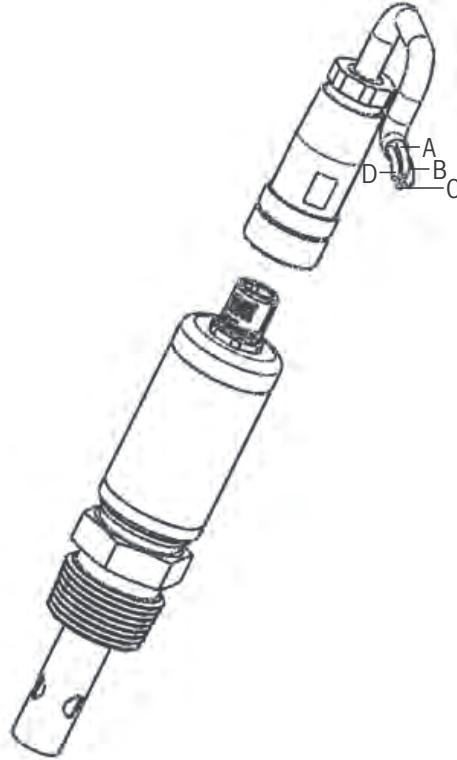

### 4.7.4 Cable Assignment of ISM Sensor for Cond 2-e (Thornton Models only)

- A: GND (white)
- B: Data RS485-B (black)
- C: Data RS485-A (red)
- D: 5 VDC (blue)

## **5 Placing transmitter in, or out, of service**

### **5.1 Placing transmitter in service**



After connecting the transmitter to power supply circuit, it will be active as soon as the circuit is powered.

### **5.2 Placing transmitter out of service**

First disconnect the unit from the main power source, then disconnect all remaining electrical connections. Remove the unit from the wall/panel. Use the installation instruction in this manual as reference for dis-assembling mounting hardware.

## 6 Quick Setup

(PATH: Menu/Quick Setup)

Select Quick Setup and press the [ENTER] key. Enter the security code if necessary (see section 9.3 "Passwords").



**NOTE:** Please find the complete description of the Quick Setup routine described in the separate booklet "Quick Setup Guide for Transmitter M300" enclosed in the box.



**NOTE:** Refer to section 3.3 "Control/Navigation Keys" for information on menu navigation.

## 7 Sensor Calibration

(PATH: Cal)

The calibration key ► allows the user one-touch access to Sensor calibration and verification features. Thornton models also allow access to Meter and Analog Output calibration (see chapter 11.3.1 and 11.3.2). All other models also allow access to Analog Output and Meter calibration if the access has been previously unlocked (see chapter 11.3.3 “Calibrate Unlock”).



**NOTE:** During Calibration, a flashing “H” in the upper left corner of the display indicates a calibration is in process with a Hold condition active. (The hold output function need to be activated.) See also chapter 3.3 “Display”

### 7.1 Enter Calibration Mode

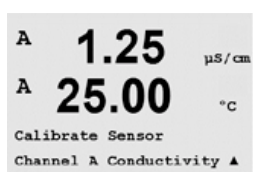

While in Measurement mode press the ► key. If the display prompts you to enter the calibration security code, press the ▲ or ▼ key to set the calibration security mode, then press the [ENTER] key to confirm the calibration security code.

For dual-channel devices: Using the the ▲ or ▼ key on the “Channel A” field let you change the channel to be calibrated. Then use the ► key to move to the calibration field.

Press the ▲ or ▼ key to select the type of calibration desired. The choices for each sensor type are:

Conductivity = Conductivity, Resistivity, Temperature\*, Edit\*, Verify  
 Oxygen\*\* = Oxygen, Temperature\*, Edit\*, Verify  
 Ozone\*\* = Ozone, Temperature\*, Edit\*, Verify  
 pH = pH, mV, Temperature\*, Edit pH\*, Edit mV, Verify  
 Press [ENTER].

\* not on ISM version

\*\* For Thornton transmitters (p/n 58001 316 and 58001 306), a jumper is required between terminal 1, 3 and 4 on TB3 and/or TB4.

After every successful calibration, the following options are available:

Calibrate: Calibration values will be overtaken and used for the measurement. Additionally, the data will be stored in the sensor\*.

Abort: Calibration values will be discarded.

\* only available with ISM sensors

## 7.2 Conductivity/Resistivity Calibration

This feature provides the ability to perform a one-point, two-point or process Conductivity resp. Resistivity "Sensor" calibration for two- or four-electrode sensors. The procedure described below works for both types of calibrations. There is no reason to perform a two-point calibration on a 2-electrode conductivity sensor. 4-electrode sensors do require a two-point calibration. It is also not practical to calibrate conductivity sensors using (low conductivity) reference solutions. It is recommended that conductivity sensors be sent back to the factory for calibration. Consult factory for assistance.



**NOTE:** When performing calibration on a conductivity sensor, results will vary depending on the methods, calibration apparatus and/or quality of reference standards used to perform the calibration.



**NOTE:** For measuring tasks the temperature compensation for the application as defined at the menu Resistivity (resp. for M300 dual channel the menu Comp/pH/O2) will be considered and not the temperature compensation selected thru the calibration procedure (see also chapter 8.2.4.1 "Conductivity/Resistivity/ Temperature Compensation"; PATH: Menu/Configure/Measurement/Resistivity).

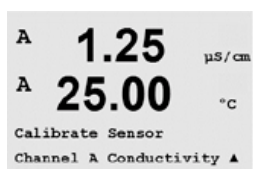

Enter Conductivity Sensor Calibration mode as described in section 7.1 "Enter Calibration Mode".

When configuring Thornton model transmitters, after selecting the desired sensor calibration and pressing [ENTER], the next screen will ask to select the type of temperature compensation mode desired during the calibration process. The choices are "None", "Standard", "Light 84", "Std 75 °C", "Lin 20°C = 02.0%/°C" (user selectable value), "Lin 25°C = 02.0%/°C" (user selectable value), "Glycol.5", "Glycol1", "Alcohol" and "Nat H2O".



All other models provide the options "Standard", "Lin 20°C = 02.0%/°C" (user selectable value), and "Lin 25°C = 02.0%/°C" (user selectable value) as Compensation mode thru the calibration.

Standard compensation includes compensation for non-linear high purity effects as well as conventional neutral salt impurities and conforms to ASTM standards D1125 and D5391.

Lin 25°C compensation adjusts the reading by a factor expressed as "% per °C" deviation from 25 °C. The factor can be modified.

Lin 20°C compensation adjusts the reading by a factor expressed as "% per °C" deviation from 20 °C. The factor can be modified.

Choose the compensation mode, modify the factor where appropriate and press [ENTER]



## 7.2.1 One-point Sensor Calibration

(Display reflects typical Sensor calibration)

Enter Conductivity Sensor Calibration mode as described in section 7.1 "Enter Calibration Mode" and choose one of the compensation modes (see section 7.2 "Conductivity/Resistivity Calibration").

```
A 1.25 µS/cm
A 25.00 °C
Conductivity Calibration
Type = 1 point ▲
```

Select 1 point Calibration and press [ENTER]. With conductivity sensors a one-point calibration is always performed as a slope calibration.

Place the electrode into the reference solution.

```
A 1.25 µS/cm
A 25.00 °C
A Point1 = 1.413 µS/cm
A C = 1.250 µS/cm ▲
```

Enter the Value of calibration Point 1 and then press the [ENTER] key to start calibration. The value in the 2nd text line is the actual measured value from the sensor prior to calibration.

After the calibration the Multiplier or slope calibration factor "M" and the Adder or offset calibration factor "A" are displayed.

```
A 1.25 µS/cm
A 25.00 °C
C M=0.1000 A=0.0000
Save Calibration Yes ▲
```

Select Yes to save the calibration values and the Successful Calibration is confirmed on the display. If an ISM sensor is connected, the calibration data will be stored in the sensor.

You will get the message "Re-install sensor" and "Press Enter" on the display. After pressing "Enter" the M300 returns to the measuring mode.

## 7.2.2 Two-point Sensor Calibration (4-electrode sensors only)

Enter Conductivity Sensor Calibration mode as described in section 7.1 Enter Calibration Mode and choose one of the compensation modes (see section 7.2 "Conductivity/Resistivity Calibration").

Select 2 point Calibration and press [ENTER].

Place the electrode into the first reference solution.

CAUTION: Rinse sensors with a high-purity water solution between calibration points to prevent contamination of the reference solutions.

```
A 1.25 µS/cm
A 25.00 °C
Conductivity Calibration
Type = 2 point ▲
```

Enter the Value of Point 1 and press the [ENTER] key. Place the sensor into the second reference solution.

Enter the Value of Point 2 and press the [ENTER] key to start the calibration.

```
A 1.25 µS/cm
A 25.00 °C
A Point2 = 0.055 µS/cm
A C = 0.057 µS/cm ▲
```

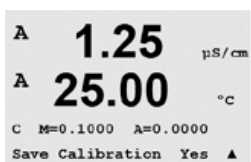

After the calibration the Multiplier or slope calibration factor "M" and the Adder or offset calibration factor "A" are displayed.

Select Yes to save the calibration values and the Successful Calibration is confirmed on the display. If an ISM sensor is connected, the calibration data will be stored in the sensor.

You will get the message "Re-install sensor" and "Press Enter" on the display. After pressing "Enter" the M300 returns to the measuring mode.

## 7.2.3 Process Calibration

Enter Conductivity Sensor Calibration mode as described in section 7.1 "Enter Calibration Mode" and choose one of the compensation modes (see section 7.2 "Conductivity/Resistivity Calibration").

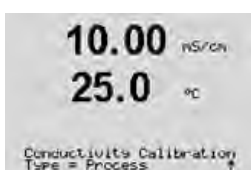

Select Process Calibration and press [ENTER]. With conductivity sensors a process calibration is always performed as a slope calibration.

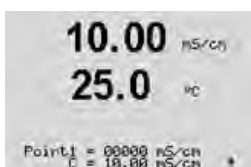

Take a sample and press the [ENTER] key again to store the current measuring value.

During the ongoing calibration process, the letter of the channel, which is concerned by the calibration, "A" or "B" is blinking in the display.

After determining the conductivity value of the sample, press the [CAL] key again to proceed with the calibration.



Enter the conductivity value of the sample, then press the [ENTER] key to start the calculation of calibration results.



After the calibration the Multiplier or slope calibration factor "M" and the Adder or offset calibration factor "A" are displayed.

Select Yes to save the calibration values and the Successful Calibration is confirmed on the display.

## 7.3 Oxygen Calibration

Dissolved Oxygen calibration is performed as either a one-point or process calibration.

### 7.3.1 One-Point Sensor Calibration

Before air calibration, for highest accuracy, enter the barometric pressure and relative humidity as in section 8.2.4.3 "Dissolved Oxygen Parameters" described

Enter Oxygen Calibration mode as described in section 7.1 "Enter Calibration Mode".

```
A 1.25  μS/cm
A 25.00 °C
Calibrate Sensor
Channel B Oxygen ▲
```

A DO sensor calibration is always either a one point Air (Slope) or a Zero (Offset) calibration. A one point slope calibration is done in air and a one point offset calibration is done at 0 ppb DO. A one-point zero dissolved oxygen calibration is available but not normally recommended since zero DO is very hard to achieve.

Select 1 point followed by either Slope or ZeroPt as the calibration type. Press [ENTER].

```
A 1.25  μS/cm
A 25.00 °C
O2 Calibration
Type = 1 point Slope ▲
```

Enter the value for Point 1 including a decimal point and units. The value in the second text line is the value being measured by the transmitter and sensor in the units selected by the user. Press [ENTER] when this value is stable to perform the calibration.

```
A 1.25  μS/cm
A 25.00 °C
B Point1 = 100.0 ppb
B O2 = 101.3 ppb ▲
```

After the calibration the slope calibration factor S and the offset calibration factor Z are displayed.

Select Yes to save the calibration values and the successful Calibration is confirmed on the display. If an ISM sensor is connected, the calibration data will be stored in the sensor.

```
A 1.25  μS/cm
A 25.00 °C
O2 S=0.1000 Z=0.0000
Save Calibration Yes ▲
```

You will get the message "Re-install sensor" and "Press Enter" on the display. After pressing "Enter" the M300 returns to the measuring mode.

### 7.3.2 Process Calibration

Enter Oxygen Calibration mode as described in section 7.1 "Enter Calibration Mode".

Select Process followed by either Slope or ZeroPt as the calibration type. Press [ENTER]

```
A 1.25  μS/cm
A 25.00 °C
O2 Calibration
Type = Process Slope ▲
```

Take a sample and press the [ENTER] key again to store the current measuring Value. To show the ongoing Calibration Process, A or B (depending on the channel) is displayed in the top left hand corner.

```
A 1.25  μS/cm
A 25.00 °C
B Point1 = 100.0 ppb
B O2 = 101.3 ppb ▲
```

```

A 1.25 µS/cm
A 25.00 °C
O2 S=0.1000 Z=0.0000
Save Calibration Yes ▲

```

After determining the O<sub>2</sub> Value of the Sample press the [CAL] key again to proceed with the calibration. Enter the O<sub>2</sub> value of the sample then press the [ENTER] key to start calibration.

After the calibration the slope calibration factor S and the offset calibration factor Z are displayed. Select Yes to save the new calibration values and the successful Calibration is confirmed on the display. If an ISM sensor is connected, the calibration data will be stored in the sensor. The A resp. B in the top left hand corner disappears after 20 seconds.

## 7.4 Ozone Calibration (Thornton Models only)

Dissolved Ozone calibration is performed as a 1 point calibration and must be performed quickly because ozone decays rapidly into oxygen, especially at warm temperatures.

### 7.4.1 One-Point Sensor Calibration

```

A 1.25 µS/cm
A 25.00 °C
Calibrate Sensor
Channel B Ozone ▲

```

Enter Ozone Calibration mode as described in section 7.1 "Enter Calibration Mode" and select Ozone.

Ozone sensor calibration is always either a one point Comparison (Slope) or a Zero (Offset) calibration. A one point slope calibration is always obtained from a comparison instrument or colorimetric test kit and a one point offset calibration is done in air or in Ozone-free water.

Select 1 point followed by either Slope or ZeroPt as the calibration type. Press [ENTER].

```

A 1.25 µS/cm
A 25.00 °C
O3 Calibration
Type = 1 point Slope ▲

```

Enter the value for Point 1 including a decimal point and units. The value in the second text line is the value being measured by the transmitter and sensor in the units selected by the user. Press [ENTER] when this value is stable to perform the calibration.

```

A 1.25 µS/cm
A 25.00 °C
B Point1 = 0.147 ppm O3
B O3 = 0.164 ppm ▲

```

After the calibration the slope calibration factor S and the offset calibration factor Z are displayed.

```

A 1.25 µS/cm
A 25.00 °C
O3 S=0.1000 Z=0.0000
Save Calibration Yes ▲

```

Select Yes to save the calibration values and the successful Calibration is confirmed on the display.

You will get the message "Re-install sensor" and "Press Enter" on the display. After pressing "Enter" the M300 returns to the measuring mode.

## 7.5 pH Calibration

For pH sensors, the M300 transmitter features one-point, two-point (Auto or Manual mode) or process calibration with 8 preset buffer sets or manual buffer entry. Buffer values refer to 25 °C. To calibrate the instrument with automatic buffer recognition, you need a standard pH buffer solution that matches one of these values (see section 8.2.4.2 "pH Parameters" for configuring modes and selecting buffer sets). Please select the correct buffer table before using automatic calibration (see chapter 20 "Buffer tables").

Enter pH Calibration mode as described in section 7.1 "Enter Calibration Mode".



### 7.5.1 One Point Calibration

Select 1 point Calibration. With pH sensors a one point calibration is always performed as a offset calibrator.

Depending on the parameterized Drift control (see chapter 8.2.4.2 "pH Parameters") one of the two following modes is active.

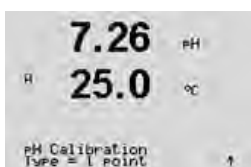

#### 7.5.1.1 Auto Mode

Place the electrode in the buffer solution and press the [ENTER] key to start the calibration.



The display shows the buffer the transmitter has recognized (Point 1) and the measured value.

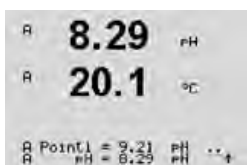

As soon as the stabilisation criteria have been fulfilled, the display changes to show the slope calibration factor S and the offset calibration factor Z.

Select Yes to save the calibration values and the successful Calibration is confirmed on the display. If an ISM sensor is connected, the calibration data will be stored in the sensor.

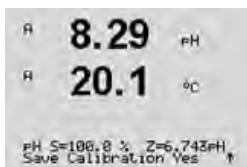

You will get the message "Re-install sensor" and "Press Enter" on the display. After pressing "Enter" the M300 returns to the measuring mode.

### 7.5.1.2 Manual Mode

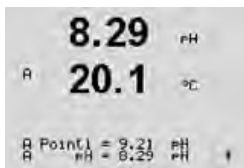

Place the electrode in the buffer solution. The display shows the buffer the transmitter has recognized (Point 1) and the measured value. Press [ENTER] to proceed.



The display shows now the slope calibration factor S and the offset calibration factor Z.

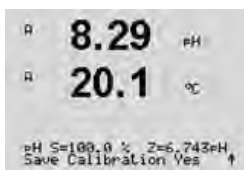

Select Yes to save the calibration values and the successful Calibration is confirmed on the display. If an ISM sensor is connected, the calibration data will be stored in the sensor.

You will get the message "Re-install sensor" and "Press Enter" on the display. After pressing "Enter" the M300 returns to the measuring mode.

### 7.5.2 Two Point Calibration

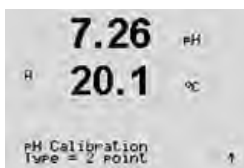

Select 2 point Calibration.

Depending on the parameterized Drift control (see chapter 8.2.4.2 "pH Parameters") one of the two following modes is active.

#### 7.5.2.1 Auto Mode

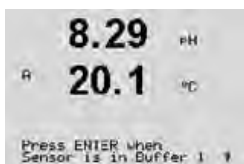

Place the electrode in the buffer solution and press the [ENTER] key to start the calibration.

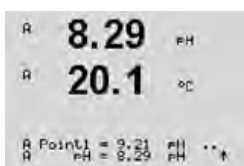

The display shows the buffer the transmitter has recognized (Point 1) and the measured value.

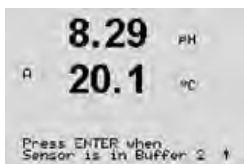

As soon as the stabilisation criteria have been fulfilled, the display changes and prompts you to place the electrode in the second buffer.

Place the electrode in the second buffer solution and press the [ENTER] key to go on with the calibration.

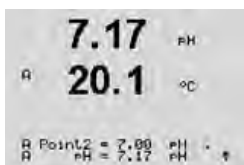

The display shows the second buffer the transmitter has recognized (Point 2) and the measured value.



As soon as the stabilisation criteria have been fulfilled, the display changes to show the slope calibration factor S and the offset calibration factor Z.

Select Yes to save the calibration values and the successful Calibration is confirmed on the display. If an ISM sensor is connected, the calibration data will be stored in the sensor.

You will get the message "Re-install sensor" and "Press Enter" on the display. After pressing "Enter" the M300 returns to the measuring mode.

### 7.5.2.2 Manual Mode



Place the electrode in the first buffer solution. The display shows the buffer the transmitter has recognized (Point 1) and the measured value. Press [ENTER] to proceed.

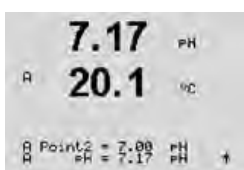

Place the transmitter in the second buffer solution. The display shows the buffer the transmitter has recognized (Point 2) and the measured value. Press [ENTER] to proceed.

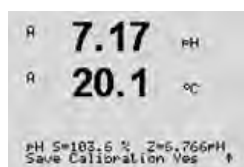

The display shows the slope calibration factor S and the offset calibration factor Z.

Select Yes to save the calibration values and the successful Calibration is confirmed on the display. If an ISM sensor is connected, the calibration data will be stored in the sensor.

You will get the message "Re-install sensor" and "Press Enter" on the display. After pressing "Enter" the M300 returns to the measuring mode.

### 7.5.3 Process Calibration

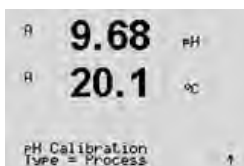

Select Process Calibration. At pH sensors a process calibration is always performed as a offset calibraton.

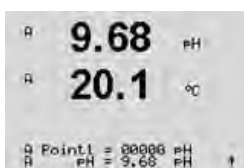

Take a sample and press the [ENTER] key again to store the current measuring Value. To show the ongoing Calibration Process, A or B (depending on the channel) is displayed in the top left hand corner.



After determining the pH Value of the Sample, press the [CAL] key again to proceed with the calibration.

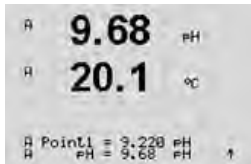

Enter the pH value of the sample then press the [ENTER] key to start the calculation of the calibration results.

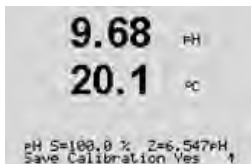

After the calibration the slope calibration factor S and the offset calibration factor Z are displayed. Select Yes to save the new calibration values and the successful Calibration is confirmed on the display. If an ISM sensor is connected, the calibration data will be stored in the sensor. The A resp. B in the top left hand corner disappears after 20 seconds.

## 7.5.4 mV Calibration (not on ISM Version)



Enter mV Calibration mode as described in section 7.1 "Enter Calibration Mode".

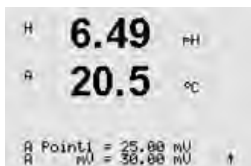

Enter the value for Point 1. The offset calibration factor is calculated by using the value of Point1 instead of the measured value (line 4, mV = ....) and is displayed on the next screen.

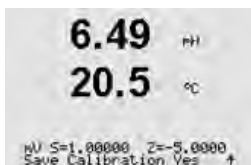

Z is the newly calculated offset calibration factor. The slope calibration factor S is always 1 and does not enter the calculation.

Select Yes to save the new calibration values and the successful Calibration is confirmed on the display.

You will get the message "Re-install sensor" and "Press Enter" on the display. After pressing "Enter" the M300 returns to the measuring mode.

## 7.5.5 ORP Calibration (only on ISM Version)

In case that an pH sensor with solution ground, based on the ISM technology is connected to the transmitter, the M300 ISM give the option to make in addition an ORP calibration.

Enter ORP calibration mode as described in section 7.1 "Enter Calibration Mode".







Enter Point 1. In addition the actual ORP is displayed.

Press [ENTER] to proceed.

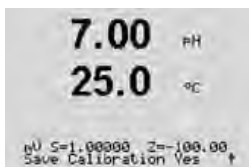

The display shows the slope calibration factor S and the offset calibration factor Z.

Select Yes to save the new calibration values and the successful Calibration is confirmed on the display. The calibration data will be stored in the sensor.

You will get the message "Re-install sensor" and "Press Enter" on the display. After pressing "Enter" the M300 returns to the measuring mode.

## 7.6 Sensor Temperature Calibration (not on ISM Version)

Enter Calibration Mode as described in section 7.1 "Enter Calibration Mode" and select Temperature.

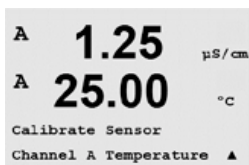

### 7.6.1 One-Point Sensor Temperature Calibration (not on ISM Version)

Select 1 point calibration. Slope or Offset can be selected with the 1 point calibration. Select Slope to recalculate the Slope factor M (Multiplier) or Offset to recalculate the offset calibration factor A (Adder).

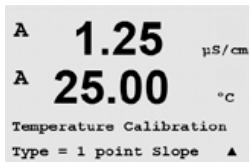

Enter the value for Point 1 and press [ENTER].

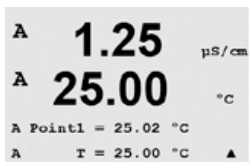

The newly calculated value – either M or A – is displayed. Select Yes to save the new calibration values and the successful Calibration is confirmed on the display.

You will get the message "Re-install sensor" and "Press Enter" on the display. After pressing "Enter" the M300 returns to the measuring mode.

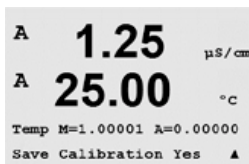

## 7.6.2 Two-Point Sensor Temperature Calibration (not on ISM version)

Select 2 point as calibration Type.

```
A 1.25 µS/cm
A 25.00 °C
Temperature Calibration
Type = 2 point ▲
```

Enter the value for Point 1 and press [ENTER].

```
A 1.25 µS/cm
A 25.00 °C
A Point1 = 25.02 °C
A T = 25.00 °C ▲
```

Enter the value for Point 2 and press [ENTER].

```
A 1.25 µS/cm
A 25.00 °C
A Point2 = 50.00 °C
A T = 50.64 °C ▲
```

The newly calculated values M and A are displayed. Select Yes and press [ENTER] to save the new calibration values and the successful Calibration is confirmed on the display.

You will get the message "Re-install sensor" and "Press Enter" on the display. After pressing "Enter" the M300 returns to the measuring mode.

```
A 1.25 µS/cm
A 25.00 °C
Temp M=1.00001 A=0.00000
Save Calibration Yes ▲
```

## 7.7 Edit Sensor Calibration Constants (not on ISM version)

Enter Calibration mode as described in section 7.1 "Enter Calibration Mode" and select Edit, Edit pH or Edit mV.

```
A 1.25 µS/cm
A 25.00 °C
Calibrate Sensor
Channel A Edit ▲
```

All calibration constants for the selected sensor channel are displayed. Primary measurement constants (p) are displayed on Line 3. Secondary measurement (temperature) constants (s) for the sensor are displayed on Line 4.

```
A 1.25 µS/cm
A 25.00 °C
Ap M=0.1000 A=0.0000
As M=0.1000 A=0.0000 ▲
```

The calibration constants can be changed in this menu.

Select Yes to save the new calibration values and the successful Calibration is confirmed on the display.

```
A 1.25 µS/cm
A 25.00 °C
Save Calibration Yes
Press ENTER to Exit ▲
```



**NOTE:** Each time a new analogue conductivity sensor is connected to the M300 transmitter, it is necessary to enter the unique calibration constant located on the sensor label.

## 7.8 Sensor Verification

Enter Calibration mode as described in section 7.1 "Enter Calibration Mode" and select Verify.



The measured signal of the primary and the secondary measurement in electrical units are shown. The meter calibration factors are used when calculating these values.

Use the ▲ or ▼ key to toggle between Channel A and B\*.

\* Only on dual channel version.



## 8 Configuration

(PATH: Menu/Configure)

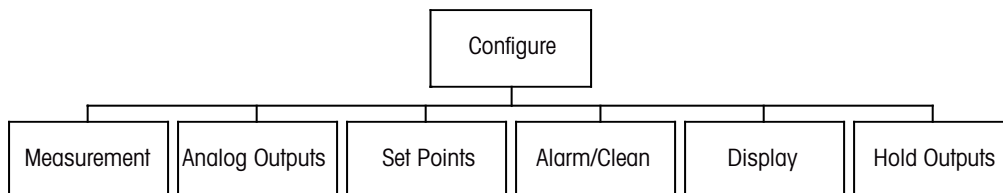

### 8.1 Enter Configuration Mode



While in Measurement mode, press the ◀ key. Press the ▲ or ▼ key to navigate to the Configure – Menu and press [ENTER].

### 8.2 Measurement

(PATH: Menu/Configure/Measurement)

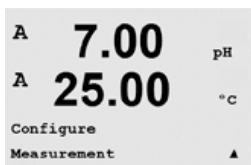

Enter configuration mode as described in Section 8.1 “Enter Configuration Mode”.

Press the [ENTER] key to select this Menu. The following sub menus can now be selected: Channel Setup, Temperature Source\*, Comp/pH/O2\*\* and Set Averaging.

\* Not on ISM version

\*\* for single channel transmitters M300 and M300ISM the term in the display does not show Comp/pH/O2 but Resistivity or pH or O2. The term depends on the version of the transmitter M300 resp. the ISM sensor, that has been connected to the transmitter M300 ISM.

#### 8.2.1 Channel Setup

(PATH: Menu/Configure/Measurement/Channel Setup)

Press the [ENTER] key to select the “Channel Setup” Menu.

 **NOTE:** The selection depends on the transmitter type.

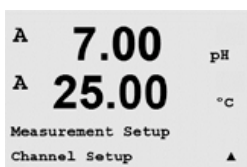

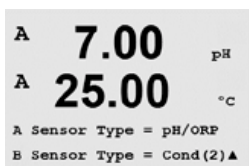
**Analog Sensors:**

Select Sensor Type and press [ENTER].

Available Sensor Types are:

pH/ORP	= pH or ORP
Cond(2)	= 2 electrode conductivity
Cond(4)	= 4 electrode conductivity
O <sub>2</sub> hi	= Dissolved Oxygen (ppm)
O <sub>2</sub> (l)	= Dissolved Oxygen (except 58037221, Thornton models only)
O <sub>2</sub> (V)	= Dissolved Oxygen 58037221 (Thornton models only)
O <sub>3</sub>	= Dissolved Ozone (Thornton models only)

**ISM Sensors:**

pH/ORP = pH or ORP  
 O<sub>2</sub> hi = Dissolved oxygen (ppm)  
 Cond (2) = Cond 2-e sensor (Thornton models only)  
 Cond (4) = Cond 4-e sensor  
 Auto: = The transmitter automatically recognizes the connected sensor  
 If you select a specific parameter instead of auto, the transmitter only accepts the selected parameter type.



The 4 lines of the display can now be configured with sensor channel "A" or "B" for each line of the display as well as measurements and unit multipliers. Pressing the [ENTER] key will display the selection for lines c and d.

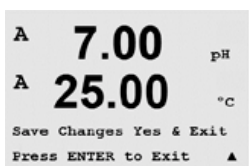

Pressing the [ENTER] key again will bring up the Save Changes dialog. Selecting No will discard the entered values and return to the measurement display screen, selecting Yes will save changes made.

**8.2.2 Derived Measurements (Thornton models only)**

There are three derived measurements available for configuration with two Conductivity sensors: %Rej (% Rejection), pH Cal (Calculated pH) and CO<sub>2</sub> Cal (Calculated CO<sub>2</sub>). To set up any of the derived measurements, first set up the two primary conductivity measurements, which will be used to calculate the derived measurement. Define the primary measurements as if they were stand-alone readings. Then the derived measurement can be defined.



**NOTE:** It is important to use the same units for both measurements.

### 8.2.2.1 % Rejection measurement

For reverse osmosis (RO) applications, percent rejection is measured with conductivity to determine the ratio of impurities removed from product or permeate water to the total impurities in the incoming feed water. The formula for obtaining Percent Rejection is:

$$[1 - (\text{Product}/\text{Feed})] \times 100 = \% \text{ Rejection}$$

Where Product and Feed are the conductivity values measured by the respective sensors.

Figure 4.1 shows a diagram of an RO installation with sensors installed for Percent Rejection.

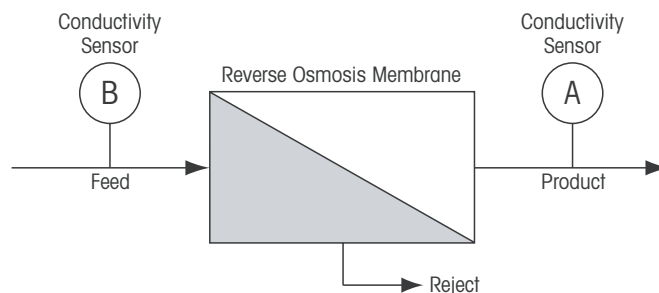

Figure 4.1: % Rejection



**NOTE:** The product monitoring sensor must be on the channel that will measure percent rejection. If the product conductivity sensor is installed in channel A, then percent rejection must be measured in channel A.

### 8.2.2.2 Calculated pH (Power plant applications only)

Calculated pH may be obtained very accurately from specific and cation conductivity values on power plant samples when the pH is between 7.5 and 10.5 due to ammonia or amines and when the specific conductivity is significantly greater than the cation conductivity. This calculation is not suitable where significant levels of phosphates are present. The M300 uses this algorithm when pH CAL is selected as a measurement.

The calculated pH must be configured on the same channel as specific conductivity. For example, set up measurement "a" on channel A to be specific conductivity, measurement "b" on Channel B to be cation conductivity, measurement "c" on channel A to be calculated pH and measurement "d" on channel A to be temperature. Set the temperature compensation mode to "Ammonia" for measurement "a" and to "Cation" for measurement "b".



**NOTE:** If operation goes outside the recommended conditions, a glass electrode pH measurement is needed to obtain an accurate value. On the other hand, when sample conditions are within the ranges noted above, the calculated pH provides an accurate standard for one-point trim calibration of the electrode pH measurement.

### 8.2.2.3 Calculated CO<sub>2</sub> (Power plant applications only)

Carbon dioxide may be calculated from cation conductivity and degassed cation conductivity measurements on power plant samples using tables from ASTM Standard D4519. The M300 has these tables stored in memory, which it uses when units of CO<sub>2</sub> CAL are selected.

The calculated CO<sub>2</sub> measurement must be configured to the same channel as cation conductivity. For example, set up measurement "a" on channel A to be cation conductivity, measurement "b" on channel B to be degassed cation conductivity, measurement "c" on channel A to be calculated CO<sub>2</sub> and measurement "d" on channel B to be temperature. Set the temperature compensation mode to "Cation" for both conductivity measurements.

### 8.2.3 Temperature Source (not on ISM version)

(PATH: Menu/Configure/Measurement/Temperature Source)

Enter Configuration Mode as described in section 8.1 "Enter Configuration mode" and select the menu Measurement (see section 8.2 "Configuration/Measurement").

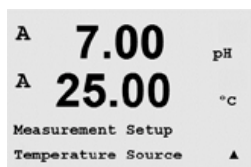

Navigate to the menu Temperature Source by using the ▲ or ▼ key. Press the [ENTER] key to select this Menu. The following options can be chosen:

"Fixed": allows a specific temperature value to be entered.

**NOTE:** The selection depends on the transmitter type. For detailed overview see the specifications in section 16 "Specification".

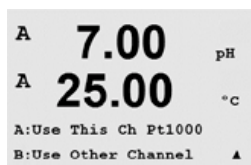

"Use this Ch Pt1000": temperature input will be taken from the sensor attached.

"Use this Ch Pt100": temperature input will be taken from sensor attached

"Use this NTC22K": temperature will be taken from the sensor attached

"Fixed = 25°C": allows a specific temperature value to be entered

"Use Other Channel": temperature input will be taken from the sensor attached to the other channel (only on dual channel version)

Pressing the [ENTER] key will bring up the Save Changes dialog.

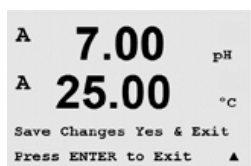

Selecting No will discard the entered values and return to the measurement display screen, selecting Yes will save changes made.

## 8.2.4 Parameter Related Settings

(PATH: Menu/Configure/Measurement/Comp/pH/O2)

Additional measurement and calibration parameters can be set for each parameter; conductivity, pH and O2.

Enter Configuration Mode as described in section 8.1 "Enter Configuration mode" and select the menu Measurement (see section 8.2 "Configuration/Measurement").

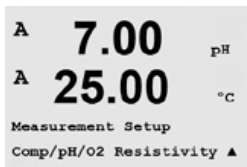

For dual channel devices: The menu Comp/pH/O2 can be selected by using the ▲ or ▼ key. Then use the ► key to move to the next input field and select the parameter using the ▲ or ▼ key. The choices are Resistivity (for conductivity measurement), pH and O2. Press [ENTER]

For single-channel devices: The menu can be selected by using the ▲ or ▼ key. Depending on the connected ISM sensor resp. used transmitter M300 the following term is shown in the display: Resistivity (for conductivity measurement), pH or O2. Press [ENTER]

For more details, please see the following explanations according to the different parameters.



## 8.2.4.1 Conductivity/Resistivity Temperature Compensation



**NOTE:** The full Temperature Compensation selection is available on Thornton model transmitters only. All other models provide Standard, Lin 25°C or Lin 20°C compensation.

Select Resistivity and press [ENTER].

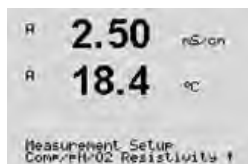

The temperature compensation mode for any of the four measurement lines can be selected. Temperature compensation should be matched to the characteristics of the application. Choices are "None"\*, "Standard", "Light 84"\*, "Std 75 °C"\*, "Lin 25°C", "Glycol.5"\*, "Glycol1"\*, "Cation"\*, "Alcohol"\*, "Ammonia"\* and "Lin 20°C".



Standard compensation includes compensation for non-linear high purity effects as well as conventional neutral salt impurities and conforms to ASTM standards D1125 and D5391.

\* Std 75 °C compensation is the Standard compensation algorithm referenced to 75°C. This compensation may be preferred when measuring Ultrapure Water at an elevated temperature. (Resistivity of ultrapure water compensated to 75 °C is 2.4818 Mohm-cm.)

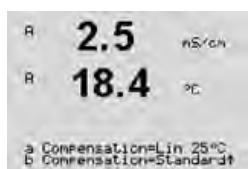

Lin 25 °C compensation adjusts the reading by a factor expressed as a "% per °C" (deviation from 25 °C). Use only if the sample has a well-characterized linear temperature coefficient. The factory default setting is 2.0%/°C.

\* Glycol.5 compensation matches the temperature characteristics of 50% ethylene glycol in water. Compensated measurements using this solution may go above 18 Mohm-cm.

\* Glycol1 compensation matches the temperature characteristics of 100% ethylene glycol. Compensated measurements may go well above 18 Mohm-cm.

\* Cation compensation is used in power industry applications measuring the sample after a cation exchanger. It takes into account the effects of temperature on the dissociation of pure water in the presence of acids.

\* Alcohol compensation provides for the temperature characteristics of a 75% solution of isopropyl alcohol in pure water. Compensated measurements using this solution may go above 18 Mohm-cm.

\* Light 84 compensation matches the high purity water research results of Dr. T.S. Light published in 1984. Use only if your institution has standardized on that work.

\* Ammonia compensation is used in power industry applications for specific conductivity measured on samples using ammonia and/or ETA (ethanolamine) water treatment. It takes into account the effects of temperature on the dissociation of pure water in the presence of these bases.



Lin 20 °C compensation adjusts the reading by a factor expressed as a “% per °C” (deviation from 20 °C). Use only if the solution has a well-characterized linear temperature coefficient. The factory default setting is 2.0%/°C.



If compensation mode “Lin 25 °C” or “Lin 20 °C” has been chosen, the factor for the adjustment of the reading can be modified after pressing [ENTER] (If working at measurement line a or b press [ENTER] twice).

Pressing [ENTER] will bring up the Save Changes dialog. Selecting No will discard the entered values and return to the measurement display screen, selecting Yes will save changes made.

\* On Thornton models only.

## 8.2.4.2 pH/ORP Parameters

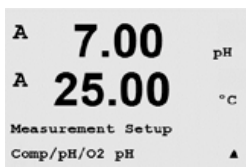

Select pH and press [ENTER].

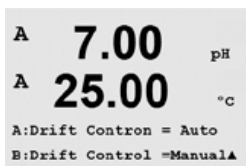

Select the drift control for calibration as Auto (stabilisation and time criteria have to be fulfilled) or Manual (the user can decide when a signal is stable enough to complete calibration) followed by the relevant buffer table for the automatic buffer recognition. If the drift rate is less than 0.8 mV over a 20 second interval then the reading is stable and the calibration is done using the last reading. If the drift criteria is not met within 300 seconds then the calibration times out and the message “Calibration not done” is displayed. Press [ENTER].

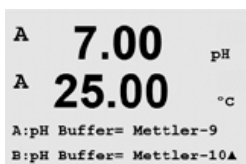

For automatic buffer recognition during calibration, select the buffer solution set that will be used: Mettler-9, Mettler-10, NIST Tech, NIST Std, HACH, CIBA, MERCK, WTW or None. See Section 20 “Buffer Tables” for buffer values. If the auto buffer feature will not be used or if the available buffers are different from those above, select None. Press [ENTER].

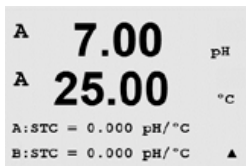

STC is the solution temperature coefficient in units of pH/°C referenced to 25 °C (Default = 0.000 for most applications). For pure waters, a setting of 0.016 pH/°C should be used. For low conductivity power plant samples near 9 pH, a setting of 0.033 pH/°C should be used. These positive coefficients compensate for the negative temperature influence on the pH of these samples. Press [ENTER].

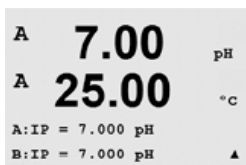

IP is the isothermal point value (Default = 7.000 for most applications). For specific compensation requirements or non standard inner buffer value, this value can be changed. Press [ENTER].

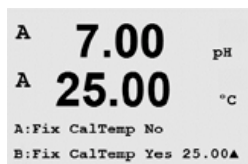

The option to enter a **fixed calibration temperature** is given. "Fixed" allows a specific temperature value to be entered. Selecting "No" means the temperature configured under 8.2.3 "Temperature Source" will be used for the calibration. Press [ENTER].



The units for the slope and the zero point, that will be shown on the display can be chosen. The default setting for the unit of the slope is [%] and can be changed to [pH/mV]. For the zero point the default setting of the unit is [pH] and can be changed to [mV]. Use the ► key to move to the input field and select the unit by using the ▲ or ▼ key.

Pressing [ENTER] again will bring up the Save Changes dialog. Selecting No will discard the entered values and return to the measurement display screen, selecting Yes will save changes made.

### 8.2.4.3 Dissolved Oxygen Parameters



Select O<sub>2</sub> and press [ENTER]

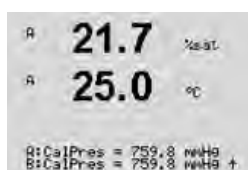

Enter the Calibration pressure. The default value for CalPres is 759.8 and the default unit is mmHg. Press [ENTER]



Enter the Process Pressure. The units for ProcPres and CalPres do not have to be the same. Press [ENTER]



For the algorithm of the process calibration the applied pressure (ProcCalPres) has to be defined. The value of the process pressure (ProcPres) or the calibration pressure (CalPres) can be used. Choose the pressure, that applies during the process calibration, resp. should be used for the algorithm and press [ENTER]

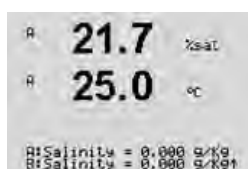

In the next step the salinity of the measured solution can be modified. Press [ENTER]



In addition the relative humidity of the calibration gas can also be entered. The allowed values for relative humidity are in the range 0% to 100%.

Pressing the [ENTER] key again will bring up the Save Changes dialog. Selecting No will discard the entered values and return to the measurement display screen, selecting Yes will save changes made.

## 8.2.5 Set Averaging

(PATH: Menu/Configure/Measurement/Set Averaging)

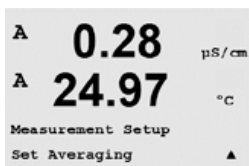

Press the [ENTER] key to select this Menu. The averaging method (noise filter) for each measurement line can now be selected. The options are Special (Default), None, Low, Medium and High:



- None = no averaging or filtering
- Low = equivalent to a 3 point moving average
- Medium = equivalent to a 6 point moving average
- High = equivalent to a 10 point moving average
- Special = averaging depending on signal change (normally High averaging but Low averaging for large changes in input signal)

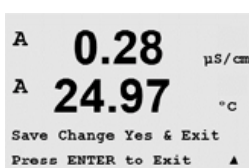

Pressing the [ENTER] key again will bring up the Save Changes dialog. Selecting No will discard the entered values and return to the measurement display screen, selecting Yes will save changes made.

## 8.3 Analog Outputs

(PATH: Menu/Configure/Analog Outputs)

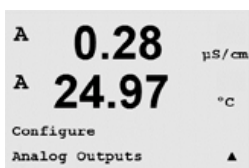

Enter configuration mode as described in Section 8.1 "Enter Configuration Mode" and navigate to the menu "Analog Outputs" by using the ▲ or ▼ key.

Press the [ENTER] key to select this Menu, which lets you configure the 2 (4 for dual channel version) Analog Outputs.

Once analog outputs have been selected, use the ◀ and ▶ buttons to navigate between configurable parameters. Once a parameter is selected, its setting can be selected per the following table:

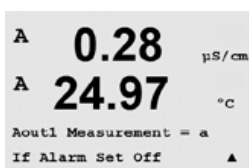

When an Alarm Value is selected, the analog output will go to this value if any alarm condition occurs.

Parameter	Selectable Values
Aout:	1, 2, 3* or 4* (default is 1)
Measurement:	a, b, c, d or blank (none) (default is blank)
Alarm Value:	3.6 mA, 22.0 mA or Off (default is off)

\* Only on dual channel version.

The Aout type can be Normal, Bi-Linear, Auto-Range or Logarithmic. The range can be 4–20mA or 0–20mA. Normal provides linear scaling between the minimum and maximum scaling limits and is the default setting. Bi-Linear will also prompt for a scaling value for the mid-point of the signal and allows two different linear segments between the minimum and maximum scaling limits.

```

A 0.28  μS/cm
A 24.97 °C
Aout1 Type= Normal
Aout1 Range = 4-20 ▲

```

Enter the minimum and maximum Value of Aout.

```

0.28  μS/cm
24.97 °C
Aout1 min= 0.000 μS/cm
Aout1 max= 10.00 μS/cm ▲

```

```

A 0.28  μS/cm
A 24.97 °C
Aout1 max1=20.00 MΩ-cm ▲

```

If Auto-range was selected then Aout max1 can be configured. Aout max1 is the maximum value for the first range on Auto-Range. The maximum value for the second range on Auto-Range was set in the previous menu. If Logarithmic Range was selected, it will also prompt for the number of decades as "Aout1 # of Decades =2".

```

A 0.28  μS/cm
A 24.97 °C
Aout1 hold mode
Last Value ▲

```

The value for the Hold mode can be configured to hold the Last value or can be set to a Fixed value.

```

A 0.28  μS/cm
A 24.97 °C
Save Change Yes & Exit
Press ENTER to Exit ▲

```

Pressing the [ENTER] key again will bring up the Save Changes dialog. Selecting No will discard the entered values and return to the measurement display screen, selecting Yes will save changes made.

## 8.4 Setpoints

(PATH: Menu/Configure/Setpoints)

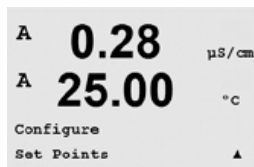

Enter configuration mode as described in Section 8.1 "Enter Configuration Mode".

Press the [ENTER] key to select this Menu.

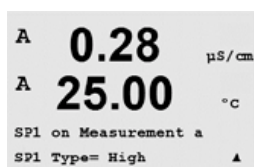

4 (6 for dual channel version) Setpoints can be configured on any of the measurements (a thru d). The possible Setpoint types are Off, High, Low, Outside and Between. Thornton models also include types, %USP, %EP PW and %EP WFI for configuration with conductivity sensors.

An "Outside" Setpoint will cause an alarm condition whenever the measurement goes above its high limit or below its low limit. A "Between" Setpoint will cause an alarm condition to occur whenever the measurement is between its high and low limits.

USP and EP Setpoints on Thornton models provide a high alarm used for pharmaceutical water monitoring with non-temperature compensated conductivity measurements. USP (United States Pharmacopoeia) section <645> and European Pharmacopoeia require that non-temperature compensated conductivity of pharmaceutical waters must be below a limit from tables based on the temperature of the sample. In other words, pharmaceutical requirements temperature-compensate the limit rather than the measurement.

The Mettler Toledo Thornton M300 has these pharmaceutical limit tables in memory and automatically determines the conductivity limit based on the measured temperature. USP and EPWFI (Water for Injection) setpoints use Table 8.1. The limit is the conductivity value corresponding to the 5 °C temperature step immediately below or equal to the measured temperature value. EP *Highly Purified Water* limits are identical to EP WFI limits.

EP PW (Purified Water) setpoints use Table 8.2. The limit in this case is the conductivity value interpolated for the measured temperature. The M300 takes care of this automatically.

The pharmaceutical setpoint value entered into the M300 is the percentage safety margin *below* the limits to activate the setpoint. For example, the USP table conductivity limit at 15 °C is 1.0 μS/cm. If the setpoint value is set at 40% then the setpoint will activate whenever the conductivity goes above 0.6 μS/cm at 15 °C.

Table 8.1: USP Section <645> Stage 1, EP WFI (Water for Injection), and EP Highly Purified Water Conductivity Limits as a Function of Temperature.

Temperature (°C)	Conductivity Limit (µS/cm)
0	0.6
5	0.8
10	0.9
15	1.0
20	1.1
25	1.3
30	1.4
35	1.5
40	1.7
45	1.8
50	1.9
55	2.1
60	2.2
65	2.4
70	2.5
75	2.7
80	2.7
85	2.7
90	2.7
95	2.9
100	3.1

Table 8.2: EP PW (Purified Water) Conductivity Limits as a Function of Temperature

Temperature (°C)	Conductivity Limit (µS/cm)
0	2.4
10	3.6
20	4.3
25	5.1
30	5.4
40	6.5
50	7.1
60	8.1
70	9.1
75	9.7
80	9.7
90	9.7
100	10.2

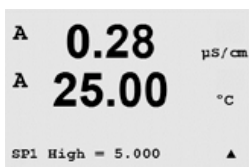

Enter the desired value(s) for the Setpoint and press [ENTER]

This screen provides the option to configure a setpoint to be active on an over range condition. Select the setpoint and "Yes" or "No". Select the desired relay that will activate when the setpoint alarm condition is reached.



#### Out of Range

Once configured, the selected relay will be activated if a sensor Out of Range condition is detected on the assigned input channel.

#### Delay

Enter the delay time in seconds. A time delay requires the setpoint to be exceeded continuously for the specified length of time before activating the relay. If the condition disappears before the delay period is over, the relay will not be activated.

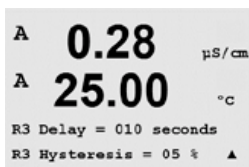

#### Hysteresis

Enter the hysteresis as a percentage-value. A hysteresis value requires the measurement to return within the setpoint value by a specified percentage before the relay is deactivated.

For a high setpoint, the measurement must decrease more than the indicated percentage below the setpoint value before the relay is deactivated. With a low setpoint, the measurement must rise at least this percentage above the setpoint value before the relay is deactivated. For example, with a high setpoint of 100, when this value is exceeded, the measurement must fall below 90 before the relay is deactivated.



#### Hold

Enter the Relay Hold Status of "Last", "On" or "Off". This is the state the Relay will go to during a Hold status.

#### State

Relay contacts are in normal state until the associated setpoint is exceeded, then the relay is activated and the contact states change.

Select "Inverted" to reverse the normal operating state of the relay (i.e. Normally open contacts are in a closed state, and normally closed contacts are in an open state, until the setpoint is exceeded). "Inverted" relay operation is functional when power is applied to the M300 transmitter.

Pressing the [ENTER] key again will bring up the Save Changes dialog. Selecting No will discard the entered values and return to the measurement display screen, selecting Yes will save changes made.



## 8.5 Alarm/Clean

(PATH: Menu/Configure/Alarm/Clean)

Enter configuration mode as described in Section 8.1 "Enter Configuration Mode".

This Menu allows the configuration of Alarm and Clean functionality.

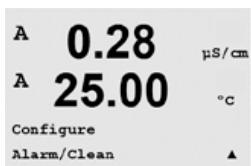

### 8.5.1 Alarm

To select "Setup Alarm", press the ▲ or ▼ key so that "Alarm" is flashing.

Using the ◀ and ▶ buttons, navigate to "Use Relay #". Using the ▲ or ▼ keys, select a relay to be used for the Alarm and press [ENTER].

One of the following events may be alarmed:

1. Power Failure
2. Software Failure
3. Rg Diagnostics – pH glass membrane resistance (pH sensors only)
4. Rr Diagnostics – pH reference resistance (pH sensors only)
5. Cond cell open (cond sensors only)
6. Cond cell shorted (cond sensors only)
7. Channel A disconnected (ISM sensors only)
8. Channel B disconnected (only for ISM sensors and dual channel version)

If any of these criterias are set to Yes and the conditions for an alarm are given, the flashing symbol  $\triangle$  will be shown in the display, an alarm message will be recorded (see also chapter 12.1 "Messages"; PATH: Info/Messages) and the selected relay will be activated. Furthermore an alarm can be indicated by the current output if this has been parameterized (see chapter 8.3 "Analog Outputs"; PATH: Menu/Configure/Analog Outputs)

1. there is a power failure or power cycling
2. the software watchdog performs a reset
3. Rg is out of tolerance – for example, broken measuring electrode (pH only)
4. Rr is out of tolerance – for example, coated or depleted reference electrode (pH only)
5. If the conductivity sensor is on air (for example in an empty pipe)
6. If the conductivity sensor has a short cut
7. If no sensor is connected on channel A (ISM sensors only)
8. If no sensor is connected on channel B (only for ISM sensors and dual channel version)

For 1 and 2 the alarm indicator will be turned off when the alarm message is cleared. It will reappear if the power is constantly cycling or if the watchdog is repeatedly resetting the system.

#### Only for pH sensors

For 3 and 4 the alarm indicator will go off if the message is cleared and the sensor has been replaced or repaired so that the Rg and Rr values are within specification. If the Rg or Rr message is cleared and Rg or Rr is still out of tolerance then the alarm will stay on and the message will reappear. The Rg and Rr alarm can be turned off by going into this menu and setting Rg Diagnostics and/or Rr Diagnostics to No. The message can then be cleared and the alarm indicator will be off even though Rg or Rr is out of tolerance.

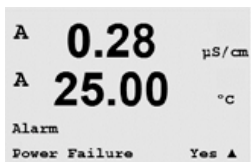
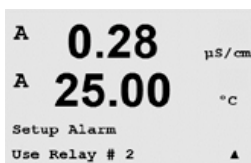

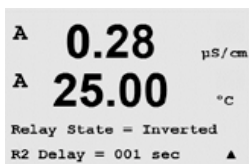

A 0.28 µS/cm  
A 25.00 °C  
Relay State = Inverted  
R2 Delay = 001 sec ▲

Each Alarm Relay can be configured in either a Normal or Inverted state. Select "Inverted" to reverse the normal operating state of the relay (i.e. Normally open contacts are in a closed state, and normally closed contacts are in an open state, until an alarm occurs). "Inverted" relay operation is functional when power is applied to the M300 transmitter.

In addition, a Delay for the activation can be set. Enter the delay time in seconds. A time delay requires the alarm to occur continuously for the specified length of time before activating the relay. If the alarm disappears before the delay period is over, the relay will not be activated.

If power failure is turned on, only inverted state is possible and cannot be changed.

Pressing the [ENTER] key again will bring up the Save Changes dialog. Selecting No will discard the entered values, selecting Yes will make the entered values the current ones.



Please note, that there are additional alarms, which will be indicated in the display. See therefore in chapter 14 "Troubleshooting" the different warning- and alarm lists.

## 8.5.2 Clean

Configure the Relay to be used for the cleaning cycle.

The Default value is Relay 1.

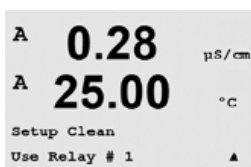

A 0.28 µS/cm  
A 25.00 °C  
Setup Clean  
Use Relay # 1 ▲

The Cleaning Interval can be set from 0.000 to 999.9 hours. Setting it to 0 turns the clean cycle off. The cleaning time can be 0 to 9999 seconds and must be smaller than the Cleaning Interval.

Select the desired Relay state: Normal or Inverted.

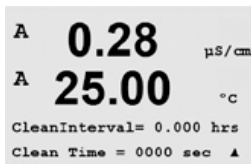

A 0.28 µS/cm  
A 25.00 °C  
CleanInterval= 0.000 hrs  
Clean Time = 0000 sec ▲

Pressing the [ENTER] key again will bring up the Save Changes dialog. Selecting No will discard the entered values and return to the measurement display screen, selecting Yes will save changes made.

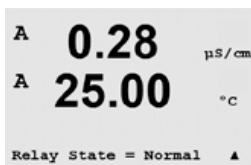

A 0.28 µS/cm  
A 25.00 °C  
Relay State = Normal ▲

## 8.6 Display

(PATH: Menu/Configure/Display)

Enter configuration mode as described in Section 8.1 "Enter Configuration Mode".

This Menu allows for the configuration of the values to be displayed and also the configuration of the Display itself.



A 0.28 µS/cm  
A 25.00 °C  
Configure  
Display ▲

## 8.6.1 Measurement

The Display has 4 lines. Line 1 on top and Line 4 on the bottom.

Select the values (Measurement a, b, c or d) to be displayed on each line of the display.



The selection of the values for a, b, c, d needs to be done under Configuration/Measurement/Channel Setup.

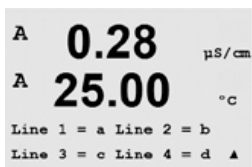

Select the "Error Display" mode. If this is set to "On" when an alarm has occurred, the message "Failure – Press Enter" will be displayed on Line 4 when an alarm occurs in the normal Measurement mode.



Pressing the [ENTER] key again will bring up the Save Changes dialog. Selecting No will discard the entered values, selecting Yes will make the entered values the current ones.

## 8.6.2 Resolution

This menu allows the setting of the resolution of each displayed value.

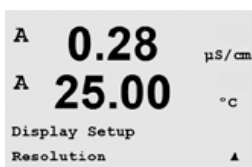

Possible settings are 1, 0.1, 0.01, 0.001 or Auto.

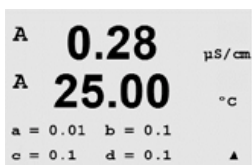

Pressing the [ENTER] key will bring up the Save Changes dialog.

## 8.6.3 Backlight

This Menu allows the setting of the back light options of the display.

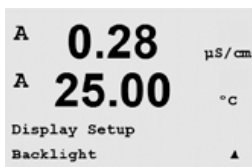

Possible settings are On, On 50% or Auto Off 50%. If Auto Off 50% is selected then the backlight will go to 50% after 4 minutes with no keypad activity. The backlight will automatically come back on if a key is pressed.

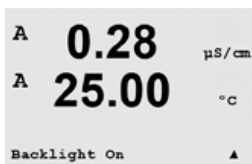

Pressing the [ENTER] key Will bring up the Save Changes dialog.

### 8.6.4 Name

This menu allows for the configuration of an alpha-numeric name which is displayed in the first 9 characters on Lines 3 and 4 of the Display. The default is nothing (blank).

If a name is entered on line 3 and/or 4 a measurement can be still displayed on the same line.



Use the ◀ and ▶ keys to navigate between digits to be altered. Using the ▲ and ▼ keys to change the character to be displayed. Once all digits of both display channels have been entered, press [ENTER] to bring up the Save Changes dialog.



The resulting display in the measurement mode appears on Lines 3 and 4 ahead of the measurements.



### 8.7 Hold Analog Outputs

(PATH: Menu/Configure/Hold Outputs)

Enter configuration mode as described in Section 8.1 "Enter Configuration Mode".

The "Hold outputs" function applies during the calibration process. If set "Hold outputs" to Yes, during calibration process the analog output, the output relay and USB output will be at hold state. The hold state depends on the setting. For the possible hold settings, see the list below. The following options are possible:

Hold Outputs? Yes/No

The "DigitalIn" function applies all the time. As soon as a signal is active on the digital input the transmitter goes to hold mode and the values on the analog output, the output relays and the USB output will be at hold state.

DigitalIn1/2\* State = Off/Low/High

**NOTE:** DigitalIn1 is to hold channel A  
DigitalIn2 is to hold channel B\*

\* Only on dual channel version.

Possible Hold states:

Output relays:	On/Off	(Configuration/Set point)
Analog Output:	Last/Fixed	(Configuration/Analog output)
USB:	Last/Off	(System/USB)
PID relay:	Last/Off	(PID setup/Mode)
PID analog:	Last/Off	(PID setup/Mode)

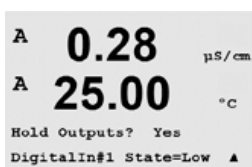
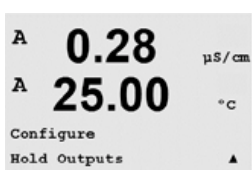

## 9 System

(PATH: Menu/System)

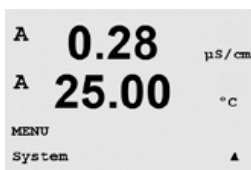
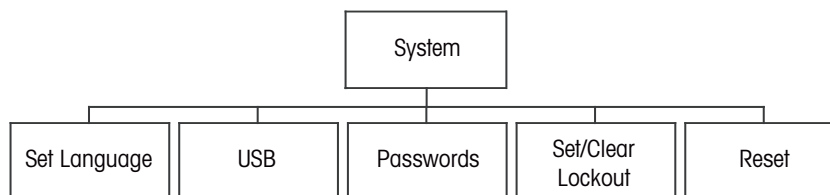

While in Measurement mode press the ◀ key. Press the ▼ or ▲ key to navigate to “System” – Menu and press [ENTER].

### 9.1 Set Language

(PATH: Menu/System/Set Language)

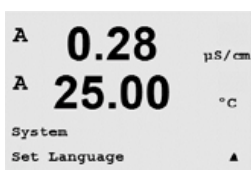

This Menu allows the configuration of the Display language.

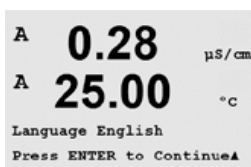

The following selections are possible:

English, French, German, Italian, Spanish, Russian, Portuguese and Japanese.

Pressing the [ENTER] key will bring up the Save Changes dialog.

### 9.2 USB

(PATH: Menu/System/USB)

This menu allows configuration of the USB hold function.

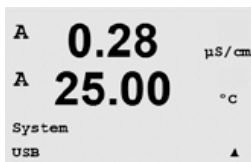

USB Hold may be set to either Off or Last Values. An external host device may poll the M300 for data. If the USB Hold is set to Off, current values are returned. If the USB Hold is set to Last Values, the values present at the time the hold condition was established are returned.

Press [ENTER] to bring up the Save Changes dialog.



## 9.3 Passwords

(PATH: Menu/System/Passwords)

This Menu allows for the configuration of Operator and Administrator Passwords, as well as setting up a List of allowed Menus for the Operator. The Administrator has rights to access all Menus. All default passwords for new transmitters are "00000".

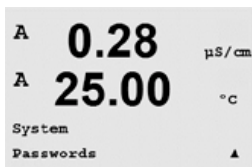

The Passwords Menu is protected: Enter the Administrator Password to enter the Menu.

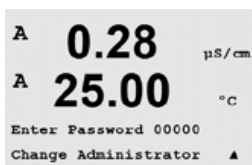

### 9.3.1 Changing Passwords

See Section 9.3 "Passwords" how to enter the Passwords Menu. Select Change Administrator or Change Operator and set the new Password.

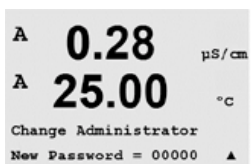

Press the [ENTER] key and confirm the new password. Press [ENTER] again to bring up the Save Changed dialog.

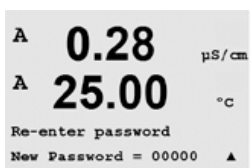

### 9.3.2 Configuring Menu Access for Operator

See 9.3 "Passwords" how to enter the Passwords Menu. Select Configure Operator to configure the Access list for the Operator. It is possible to assign/deny rights to the following Menus: Cal Key, Quick Setup, Configuration, System, PID Setup and Service.

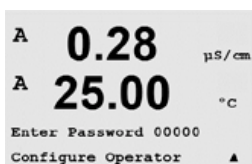

Choose either Yes or No to give/deny access to the above Menus and press [ENTER] to advance to the next items. Pressing the [ENTER] key after configuring all menus will bring up the Save Changes dialog. Selecting No will discard the entered values, selecting Yes will make the entered values the current ones.

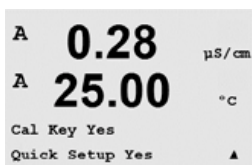

## 9.4 Set/Clear Lockout

(PATH: Menu/System/Set/Clear Lockout)

This menu enables/disables the Lockout functionality of the transmitter. The user will be asked for a password before being allowed into any menus if the Lockout functionality is enabled.

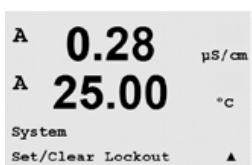

```

A 0.28 µS/cm
A 25.00 °C
Password = 00000
Enable Lockout = Yes ▲

```

The Lockout – Menu is protected: Enter the Administrator Password and select YES to enable or NO to disable the Lockout functionality. Pressing the [ENTER] key after the selection will bring up the Save Changes dialog. Selecting No will discard the entered value, selecting Yes will make the entered value the current one.

## 9.5 Reset

(PATH: Menu/System/Reset)

```

A 0.28 µS/cm
A 25.00 °C
System
Reset ▲

```

This Menu allows access to the following options:  
Reset System, Reset Meter Cal\*, Reset Analog Cal, Reset Cal Data\*\*.

\* Not on ISM version

\*\* For ISM version of Cond 2-e sensors only.

### 9.5.1 Reset System

```

A 0.28 µS/cm
A 25.00 °C
Reset System ? Yes
Press ENTER to Continue▲

```

This Menu allows the reset of the meter to the factory default settings (Setpoints off, analog outputs off, etc.). The meter calibration and the analog output calibration are not affected.

```

A 0.28 µS/cm
A 25.00 °C
Reset System
Are you sure? Yes ▲

```

Pressing the [ENTER] key after the selection will bring up a confirmation screen. Selecting No will return the user to the Measurement mode with no changes. Selecting Yes will reset the meter.

### 9.5.2 Reset Meter Calibration (not on ISM version)

```

A 0.28 µS/cm
A 25.00 °C
Reset Meter Cal ? Yes
Press ENTER to Continue▲

```

This Menu allows the reset of the meter's calibration factors to the last factory calibration values.

```

A 0.28 µS/cm
A 25.00 °C
Reset Meter Calibration
Are you sure? Yes ▲

```

Pressing the [ENTER] key after the selection will bring up a confirmation screen. Selecting No will return the user to the Measurement mode with no changes. Selecting Yes will reset the meter calibration factors.

### 9.5.3 Reset Analog Calibration

```

A  0.28  μS/cm
A  25.00  °C
Reset Analog Cal? Yes
Press ENTER to Continue▲

```

This Menu allows reset of the Analog Output calibration factors to the last factory calibration values.

```

A  0.28  μS/cm
A  25.00  °C
Reset Analog Calibration
Are you sure? Yes ▲

```

Pressing the [ENTER] key after the selection will bring up a confirmation screen. Selecting No will return the user to the Measurement mode with no changes. Selecting Yes will reset the Analog Output calibration.

### 9.5.4 Reset Sensor Calibration Data to Factory Settings

If a Cond 2-e sensor based on ISM technology is connected to the transmitter, this menu is available. The menu allows the reset of the calibration data (M resp. A) of the sensors to the factory settings.

Pressing the [ENTER] key after the selection will bring up a confirmation screen. Selecting No will return the user to the Measurement mode with no changes. Selecting Yes will reset the calibration data of the sensor to factory settings.



**NOTE:** To ensure best measuring results, a new calibration of the sensor is recommended after a reset of the calibration data to factory settings. Depending on the application, the calibration could be temporarily performed as a process calibration, recommended however is an one point calibration (see chapter 7.2 "Conductivity/Resistivity Calibration").

### 9.5.5 Reset Calibration Data of Sensor Electronic to Factory Settings

If a Cond 2-e sensor based on ISM technology is connected to the transmitter, this menu is available. The menu allows the reset of the calibration data of the sensor's evaluation electronic to the factory settings.

The procedure for this functions is described in the sensor manual.



## 10 PID Setup

(PATH: Menu/PID Setup)

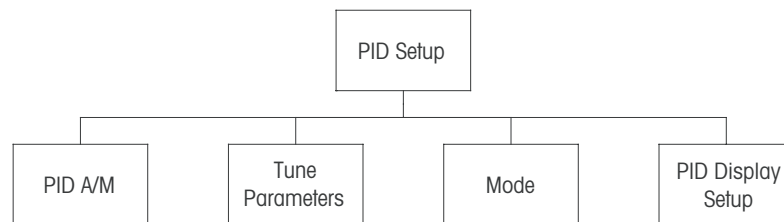

PID control is proportional, integral and derivative control action that can provide smooth regulation of a process. Before configuring the transmitter, the following process characteristics must be identified.

Identify the **control direction** of the process

– **Conductivity:**

Dilution – direct acting where increasing measurement produces increasing control output such as controlling the feed of low conductivity diluting water to rinse tanks, cooling towers or boilers

Concentrating – reverse acting where increasing measurement produces decreasing control output, such as controlling chemical feed to attain a desired concentration

– **Dissolved Oxygen:**

Deaeration – direct acting where increasing DO concentration produces increasing control output such as controlling the feed of a reducing agent to remove oxygen from boiler feed-water

Aeration – reverse acting where increasing DO concentration produces decreasing control output, such as controlling an aerator blower speed to maintain a desired DO concentration in fermentation or wastewater treatment

– **pH/ORP:**

Acid feed only – direct acting where increasing pH produces increasing control output, also for ORP reducing reagent feed

Base feed only – reverse acting where increasing pH produces decreasing control output, also for ORP oxidizing reagent feed

Both acid and base feed – direct and reverse acting

– **Ozone:**

Ozone destruct – direct acting where increasing ozone concentration produces increasing control output such as increasing UV lamp intensity

Ozonation – reverse acting where increasing ozone concentration produces a decreasing control output to decrease the output of an ozonator.

Identify the **control output type** based on the control device to be used:

Pulse Frequency – used with pulse input metering pump

Pulse Length – used with solenoid valve

Analog – used with current input device such as electric drive unit, analog input metering pump or current-to-pneumatic (I/P) converter for pneumatic control valve

Default control settings provide linear control, which is appropriate for conductivity, dissolved oxygen and ozone. Therefore, when configuring PID for these parameters (or simple pH control) ignore settings of deadband and corner points in the Tuning Parameter section below. The non-linear control settings are used for more difficult pH/ORP control situations.

If desired, identify the non-linearity of the pH/ORP process. Improved control can be obtained if the non-linearity is accommodated with an opposing non-linearity in the controller. A titration curve (graph of pH or ORP vs. reagent volume) made on a process sample provides the best information. There is often a very high process gain or sensitivity near the setpoint and decreasing gain further away from the setpoint. To counteract this, the instrument allows for adjustable non-linear control with settings of a deadband around the setpoint, corner points further out and proportional limits at the ends of control as shown in the figure below. Determine the appropriate settings for each of these control parameters based on the shape of the pH process titration curve.

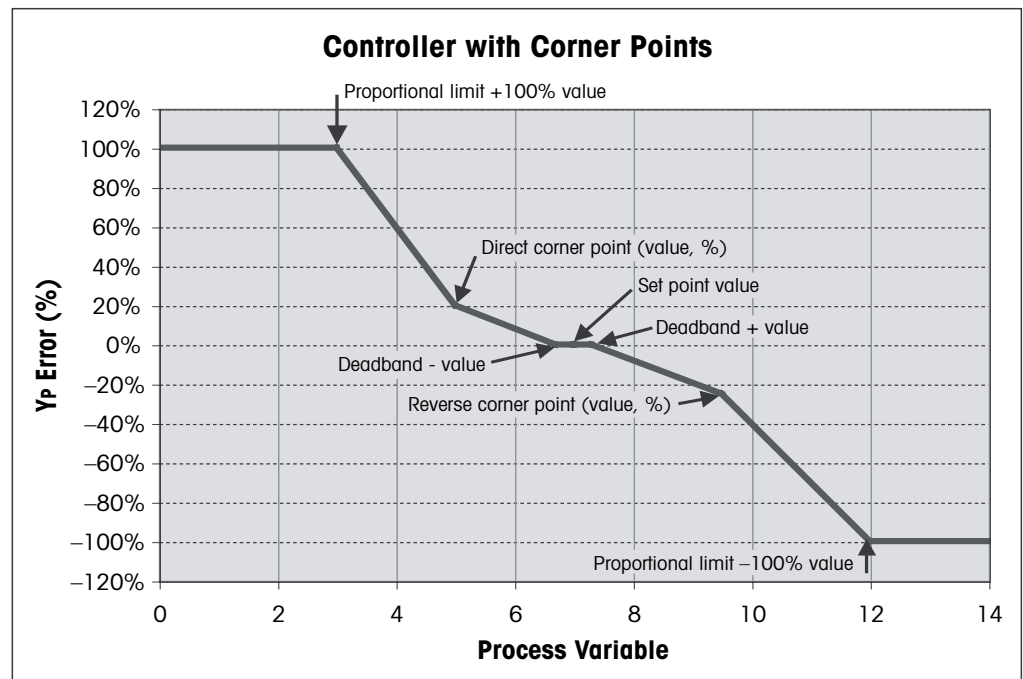

### 10.1 Enter PID Setup

(PATH: Menu/PID Setup)

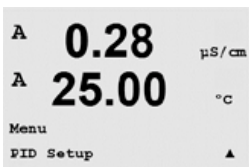

While in Measurement mode press the ◀ key. Press the ▲ or ▼ key to navigate to the PID Setup – Menu and press [ENTER].

## 10.2 PID Auto/Manual

(PATH: MENU/PID Setup/PID A/M)

This menu allows selection of Automatic or Manual operation. Select Auto or Manual operation. Pressing the [ENTER] key will bring up the Save Changes dialog.



## 10.3 Mode

(PATH: MENU/PID Setup/Mode)

This menu contains the selection of control modes using relays or analog outputs. Press [ENTER].

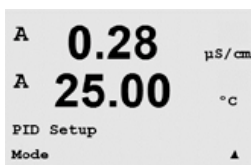

### 10.3.1 PID Mode

This menu assigns a relay or analog output for PID control action as well as details of their operation. Based on the control device being used, select one of the following three paragraphs for use with solenoid valve, pulse input metering pump or analog control.

**Pulse Length** – If using a solenoid valve, select “Relays” and “PL”, Pulse Length. Choose the first relay position as #3 (recommended) and/or the second relay position as #4 (recommended) as well as the Pulse Length (PL) according to the table below. A longer pulse length will reduce wear on the solenoid valve. The % “on” time in the cycle is proportional to the control output.

**NOTE:** All relays from #1 to #6 can be used for the controlling function.



	1 <sup>st</sup> Relay Position (#3)	2 <sup>nd</sup> Relay Position (#4)	Pulse Length (PL)
Conductivity	Controlling concentrating reagent feed	Controlling dilution water	Short (PL) provides more uniform feed. Suggested start point = 30 sec
pH/ORP	Feeding base	Feeding acid	Reagent addition cycle: short PL provides more uniform addition of reagent. Suggested start point = 10 sec
Dissolved Oxygen	Reverse control action	Direct acting control action	Feed cycle time: short PL provides more uniform feed. Suggested start point = 30 sec
Dissolved Ozone	not recommended	not recommended	

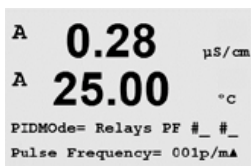

**Pulse Frequency** – If using a pulse input metering pump, select “Relays” and “PF”, Pulse Frequency. Choose the first relay position as #3 and/or the second relay position as #4 according to the table below. Set the pulse frequency to the maximum frequency allowed for the particular pump being used, typically 60 to 100 pulses/minute. Control action will produce this frequency at 100% output.



**NOTE:** All relays from #1 to #6 can be used for the controlling function.

**CAUTION:** Setting the Pulse Frequency too high may cause the pump to overheat.

	1 <sup>st</sup> Relay Position = #3	2 <sup>nd</sup> Relay Position = #4	Pulse Frequency (PF)
Conductivity	Controlling concentrating chemical feed	Controlling dilution water	Max allowed for the pump used (typically 60–100 pulses/minute)
pH/ORP	Feeding base	Feeding acid	Max allowed for the pump used (typically 60–100 pulses/minute)
Dissolved Oxygen	Reverse control action	Direct acting control action	Max allowed for the pump used (typically 60–100 pulses/minute)
Dissolved Ozone	not recommended	not recommended	

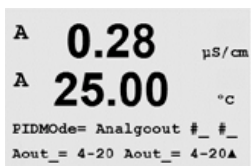

**Analog** – If using Analog control, change “Relays” to “Analogout” using up/down arrow keys. Choose the first Analogout position as #1 and/or the second Analogout position as #2 according to the table below. Select the analog output current range required by the control device, 4–20 or 0–20 mA. Press [ENTER].

	1 <sup>st</sup> Analogout Position = #1	2 <sup>nd</sup> Analogout Position = #2
Conductivity	Controlling concentrating chemical feed	Controlling dilution water
pH/ORP	Feeding base	Feeding acid
Dissolved Oxygen	Reverse control action	Direct acting control action
Dissolved Ozone	Controlling ozonation	Controlling ozone destruction

## 10.4 Tune Parameters

(PATH: MENU/PID Setup/Tune Parameters)

This menu assigns control to a measurement and sets the setpoint, tuning parameters and non-linear functions of the controller through a series of screens.

```
A 0.28  μS/cm
A 25.00 °C
PID Setup
Tune Parameters ▲
```

### 10.4.1 PID Assignment & Tuning

Assign the measurement, a, b, c, or d to be controlled after "PID on\_". Set the Gain (unitless), Integral or Reset time Tr (minutes) and Rate or Derivative time Td (minutes) needed for control. Press [ENTER]. Gain, Reset and Rate are later adjusted by trial and error based on process response. Always begin with Td at zero.

```
A 0.28  μS/cm
A 25.00 °C
PID on _ Gain = 1.000
Tr=0.00 m Td=0.00 m ▲
```

### 10.4.2 Setpoint & Deadband

Enter the desired setpoint value and the deadband around the setpoint, where no proportional control action will take place. Be sure to include the units multiplier  $\mu$  or m for conductivity. Press [ENTER].

```
A 0.28  μS/cm
A 25.00 °C
SetPoint = 0.000 _
Dead Band= +/-0.000 _ ▲
```

### 10.4.3 Proportional Limits

Enter the low and high proportional limits – the range over which control action is required. Be sure to include the units multiplier  $\mu$  or m for conductivity. Press [ENTER].

```
A 0.28  μS/cm
A 25.00 °C
Prop Limit Low 0.000 _
Prop Limit High 0.000 _▲
```

### 10.4.4 Corner Points

Enter the low and high corner points in conductivity, pH, dissolved oxygen or dissolved ozone units and the respective output values from -1 to +1, shown in the figure as -100 to +100%. Press [ENTER].

```
A 0.28  μS/cm
A 25.00 °C
Corner Low 0.000_ 1.000
CornerHigh 0.000_ -1.00▲
```

## 10.5 PID Display

(PATH: Menu/PID Setup/PID Display Setup)

This screen enables display of PID control status in the normal measurement mode.

```

A  0.28  μS/cm
A  25.00  °C
PID Setup
PID Display Setup ▲
  
```

When PID Display is selected, the status (Man or Auto) and control output (%) will be displayed on the bottom line. If controlling pH, the reagent will also be displayed. In addition, for the display to be enabled, a measurement must be assigned under Tune Parameters and a relay or analog output must be assigned under Mode.

```

A  0.28  μS/cm
A  25.00  °C
PID Display Yes ▲
  
```

In Manual, the control output may be adjusted with the up and down arrow keys. (The "Info" key function is not available in Manual.)

```

A  0.28  μS/cm
A  25.00  °C
B          7.00 pH
Man Ctrl Out 0.0%
  
```

# 11 Service

(PATH: Menu/Service)

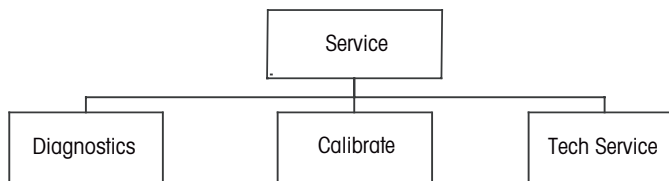

## 11.1 Enter Service Menu

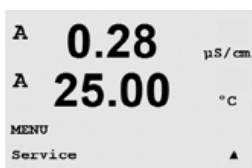

While in Measurement mode press the ◀ key. Press the ▲ or ▼ key to navigate to the “Service” Menu and press [ENTER]. The available system configuration options are detailed below

## 11.2 Diagnostics

(PATH: Menu/Service/Diagnostics)

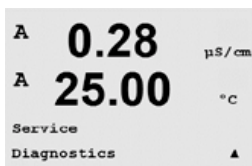

Enter Service Menu as described in section 11.1 “Enter Service Menu” and press [ENTER] .

This Menu is a valuable tool for troubleshooting and provides diagnostic functionality for the following items: Model/Software Revision, Digital Input, Display, Keypad, Memory, Set Relays, Read Relays, Set Analog Outputs, Read Analog Outputs.

### 11.2.1 Model/Software Revision

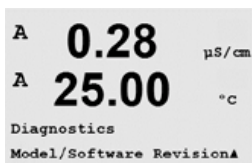

Essential information for every Service call is the model and software revision number. This menu shows the part number, model and the serial number of the transmitter. By using the ▼ key it is possible to navigate forward through this submenu and get additional information like the current version of firmware implemented on the transmitter (Master V\_XXXX and Comm V\_XXXX); and – if an ISM sensor is connected – the version of the sensor firmware (FW V\_XXX) and sensor hardware (HW XXXX).



Press [ENTER] to exit from this display.

## 11.2.2 Digital Input

The digital Input menu shows the state of the digital inputs. Press [ENTER] to exit from this display.

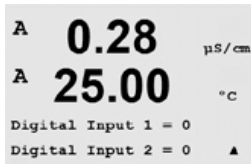
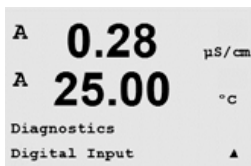

## 11.2.3 Display

All pixels of the display will be lit for 15 seconds to allow troubleshooting of the display. After 15 seconds the transmitter will return to the normal Measuring mode or press [ENTER] to exit sooner.

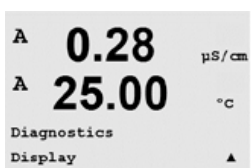

## 11.2.4 Keypad

For keypad diagnostics, the display will indicate which key is pressed. Pressing [ENTER] will return the transmitter to the normal Measuring mode.

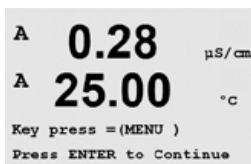
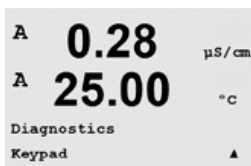

## 11.2.5 Memory

If Memory is selected then the transmitter will perform a RAM and ROM memory test. Test patterns will be written to and read from all RAM memory locations. The ROM checksum will be recalculated and compared to the value stored in the ROM.

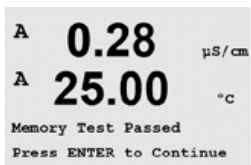
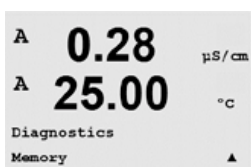



## 11.2.6 Set Relay

The Set Relays diagnostic menu allows to open or close each relay manually. To access relays 5 and 6, press [ENTER].

0 = open the relay  
1 = close the relay

Press [ENTER] to return to Measurement mode.

```
A 0.28  μS/cm
A 25.00 °C
Diagnostics
Set Relays ▲
```

```
A 0.28  μS/cm
A 25.00 °C
Relay1 = 0 Relay2 = 0
Relay3 = 0 Relay4 = 0 ▲
```

## 11.2.7 Read Relays

The Read Relays diagnostic menu shows the state of each Relay as defined below. To display Relays 5 and 6, press [ENTER]. Press [ENTER] again to exit from this display.

0 = Normal  
1 = Inverted.

```
A 0.28  μS/cm
A 25.00 °C
Diagnostics
Read Relays ▲
```

```
A 0.28  μS/cm
A 25.00 °C
Relay1 = 0 Relay2 = 0
Relay3 = 0 Relay4 = 0
```

## 11.2.8 Set Analog Outputs

This menu enables the user to set all analog outputs to any mA value within the 0–22 mA range. Press [ENTER] to exit from this display.

```
A 0.28  μS/cm
A 25.00 °C
Diagnostics
Set Analog Outputs ▲
```

```
A 0.28  μS/cm
A 25.00 °C
Analog out1 = 04.0 mA
Analog out2 = 04.0 mA ▲
```

## 11.2.9 Read Analog Outputs

This menu shows the mA value of the analog Outputs. Press [ENTER] to exit from this display.

```
A 0.28  μS/cm
A 25.00 °C
Diagnostics
Read Analog Outputs ▲
```

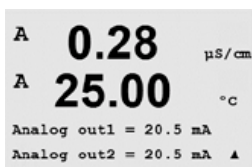

## 11.3 Calibrate

(PATH: Menu/Service/Calibrate)

Enter Service Menu as described in section 11.1 "Enter Service Menu", select Calibrate, and press [ENTER].

This menu has the options to calibrate the transmitter and the analog outputs and also allows the unlocking of calibration functionality.

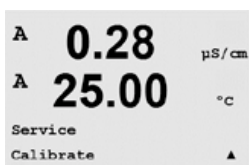

### 11.3.1 Calibrate Meter (not on ISM version)

The M300 transmitter is factory calibrated within specifications. It is not normally necessary to perform meter re-calibration unless extreme conditions cause an out of spec operation shown by Calibration Verification. Periodic verification/re-calibration may also be necessary to meet Q.A. requirements. Meter calibration can be selected as Resistance (1–5, used for conductivity), Current (used for most dissolved oxygen and dissolved ozone), Voltage, Rg Diagnostic, Rr Diagnostic (used for pH and 58037221 dissolved oxygen), and Temperature (used for all measurements).

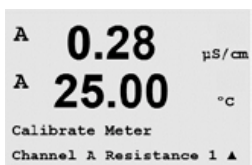

#### 11.3.1.1 Resistance

The meter is equipped with five (5) internal ranges of measurement on each channel. Each resistance range and temperature is calibrated separately, with each resistance range consisting of a two-point calibration.

Below is a table showing the resistance values for all calibration ranges.

Range:	Point 1	Point 2	Point 3
Resistivity 1	1.0 Mohms	10.0 Mohms	–
Resistivity 2	100.0 Kohms	1.0 Mohms	–
Resistivity 3	10.0 Kohms	100.0 Kohms	–
Resistivity 4	1.0 Kohms	10.0 Kohms	–
Resistivity 5	100 Ohms	1.0 Kohms	–
Temperature	1000 Ohms	3.0 Kohms	66 Kohms

It is recommended that both calibration and verification be performed using the M300 Calibrator Module Accessory (refer to accessory list, in section 15). Instructions on the use of this accessory are provided with the calibrator module.

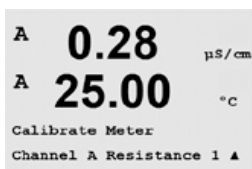

Navigate to the Calibrate Meter screen and select Channel A or B, and Resistance 1, designating that the transmitter is ready to calibrate the first range resistor. This resistance may be changed, selecting range 1 thru 5. Each resistance range consists of a two-point calibration.

Press [ENTER] to begin the calibration process.

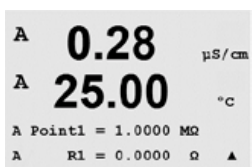

The first text line will ask for the Point 1 resistance value (this will correspond to Resistance 1 value shown on the Calibration Module Accessory). The second text line will show the measured resistance value. When the value stabilizes, press [ENTER] to perform calibration.

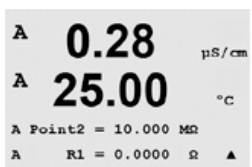

The transmitter screen will then prompt the user to enter the value for Point 2, and R1 will display the measured resistance value. When this value stabilizes, press [ENTER] to calibrate this range and bring up a confirmation screen.

Select Yes to save the calibration values and the successful Calibration is confirmed on the display. The transmitter will return to the Measurement mode in approximately 5 seconds.

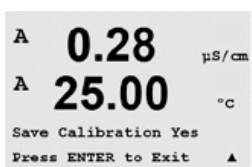

Once point 1 and 2 are calibrated, return to the Calibrate Meter screen. Move the cursor to change to Resistance 2, designating the second calibration range. Proceed with the two-point calibration process as performed for the first range. This same process must be followed to complete the resistance calibration of all 5 ranges.

### 11.3.1.2 Temperature

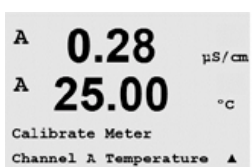

Temperature is performed as a three point calibration. The table above shows the resistance values of these three points.

Navigate to the Calibrate Meter screen and choose Temperature calibration for either Channel A or B.

Press [ENTER] to begin temperature calibration process

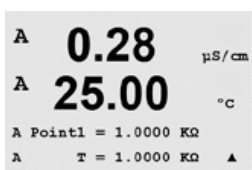

The first text line will ask for the Point 1 temperature resistance value (this will correspond to Temperature 1 value shown on the Calibration Module Accessory). The second text line will show the measured resistance value. When the value stabilizes, press [ENTER] to perform calibration.

The transmitter screen will then prompt the user to enter the value for Point 2, and T2 will display the measured resistance value. When this value stabilizes, press [ENTER] to calibrate this range.

Repeat these steps for Point 3.

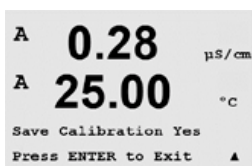

Press [ENTER] to bring up a confirmation screen. Select Yes to save the calibration values and the successful Calibration is confirmed on the display.

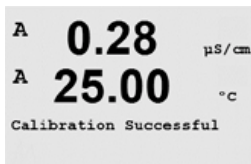

The transmitter will return to the Measurement mode in approximately 5 seconds.

### 11.3.1.3 Current

Current Calibration is performed as a two point calibration.

Navigate to the Calibrate Meter screen and select Channel A or B and Current.

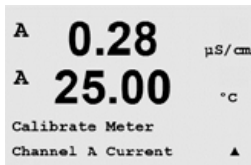

Enter the value for Point 1, in milliamps, of the current source connected to the input. The second display line will show the measured current. Press

[ENTER] to begin the calibration process.

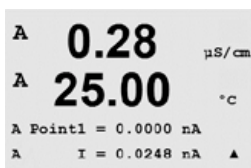

Enter the value for Point 2, in milliamps, of the current source connected to the input. The second display line shows the measured current.

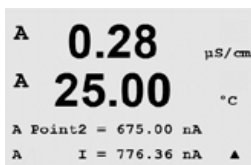

Pressing the [ENTER] key after entering Point 2 will bring up a confirmation screen. Select Yes to save the calibration values and the successful Calibration is confirmed on the display. The transmitter will return to the Measurement mode in approximately 5 seconds.

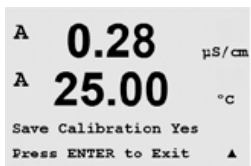

### 11.3.1.4 Voltage

Voltage Calibration is performed as a two point calibration.

Navigate to the Calibrate Meter screen and select Channel A or B and Voltage.

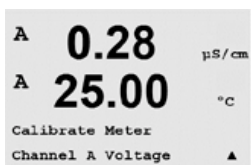

Enter the value for Point 1 in, volts, connected to the input. The second display line will show the measured voltage. Press [ENTER] to begin the calibration process.

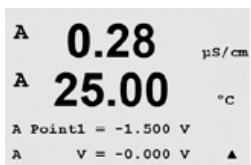

Enter the value for Point 2, in volts, of the source connected to the input. The second display line shows the measured voltage.

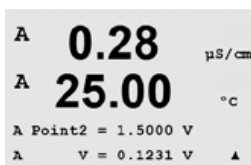

```

A  0.28  μS/cm
A  25.00  °C
Save Calibration Yes
Press ENTER to Exit  ▲

```

Pressing the [ENTER] key after entering Point 2 will bring up a confirmation screen. Select Yes to save the calibration values and the successful Calibration is confirmed on the display. The transmitter will return to the Measurement mode in approximately 5 seconds.

### 11.3.1.5 Rg Diagnostic

```

A  0.28  μS/cm
A  25.00  °C
Calibrate Meter
Channel A Rg Diagnostic▲

```

Rg Diagnostic is performed as a two point calibration. Navigate to the Calibrate Meter screen and select Channel A or B and Rg Diagnostic.

```

A  0.28  μS/cm
A  25.00  °C
A Point1 = 30.000 MΩ
A   Rg = 572.83 Ω  ▲

```

Enter the value for Point 1 of the calibration according to the resistor connected across the pH glass electrode measuring input. Press [ENTER] to begin the calibration process.

```

A  0.28  μS/cm
A  25.00  °C
A Point2 = 500.00 MΩ
A   Rg = 572.83 Ω  ▲

```

Enter the value for Point 2 of the calibration according to the resistor connected across the pH glass electrode measuring input.

```

A  0.28  μS/cm
A  25.00  °C
Save Calibration Yes
Press ENTER to Exit  ▲

```

Pressing the [ENTER] key after entering Point 2 will bring up a confirmation screen. Select Yes to save the calibration values and the successful Calibration is confirmed on the display. The transmitter will return to the Measurement mode in approximately 5 seconds.

### 11.3.1.6 Rr Diagnostics

```

A  0.28  μS/cm
A  25.00  °C
Calibrate Meter
Channel A Rr Diagnostic▲

```

Rr Diagnostic is performed as a two point calibration. Navigate to the Calibrate Meter screen and select Channel A or B and Rr Diagnostic.

```

A  0.28  μS/cm
A  25.00  °C
A Point1 = 30.000 KΩ
A   Rr = 29.448 KΩ  ▲

```

Enter the value for Point 1 of the calibration according to the resistor connected across the pH reference measuring input. Press [ENTER] to begin the calibration process.

```

A  0.28  μS/cm
A  25.00  °C
A Point2 = 200.00 KΩ
A   Rr = 29.446 KΩ  ▲

```

Enter the value for Point 2 of the calibration according to the resistor connected across the pH reference measuring input.

```

A 0.28 µS/cm
A 25.00 °C
Save Calibration Yes
Press ENTER to Exit ▲

```

Pressing the [ENTER] key after entering Point 2 will bring up a confirmation screen. Select Yes to save the calibration values and the successful Calibration is confirmed on the display. The transmitter will return to the Measurement mode in approximately 5 seconds.

### 11.3.2 Calibrate Analog

```

A 0.28 µS/cm
A 25.00 °C
Calibrate Analog
Analog Output 1 ▲

```

Select the Analog Output you wish to calibrate. Each Analog output can be calibrated at 4 and 20 mA.

```

A 0.28 µS/cm
A 25.00 °C
Aout1 20mA Set 45000
Press ENTER when Done ▲

```

Connect an accurate milliamp meter to the Analog output terminals and then adjust the five digit number in the display until the milliamp meter reads 4.00 mA and repeat for 20.00 mA.

```

A 0.28 µS/cm
A 25.00 °C
Aout1 4mA Set 08800
Press ENTER when Done ▲

```

As the five digit number is increased the output current increases and as the number is decreased the output current decreases. Thus coarse changes in the output current can be made by changing the thousands or hundreds digits and fine changes can be made by changing the tens or ones digits.

```

A 0.28 µS/cm
A 25.00 °C
Save Calibration Yes
Press ENTER to Exit ▲

```

Pressing the [ENTER] key after entering both values will bring up a confirmation screen. Selecting No will discard the entered values, selecting Yes will make the entered values the current ones.

### 11.3.3 Calibrate Unlock

```

A 0.28 µS/cm
A 25.00 °C
Calibrate Unlock

```

Select this Menu to configure the CAL Menu (see chapter 7 "Sensor Calibration").

```

A 0.28 µS/cm
A 25.00 °C
Unlock Calibration Yes
Press ENTER to Continue▲

```

Selecting Yes means that Meter calibration menu (see chapter 11.3.1 "Calibrate Meter") and Analog Output calibration menu (see chapter 11.3.2 "Calibrate Analog") will be selectable under the CAL Menu. Selecting No means that only the Sensor calibration is available under the CAL Menu. Press [ENTER] after the selection to display a confirmation screen.

## 11.4 Tech Service

(PATH: Menu/Tech Service)

**Note:** This Menu is for Mettler Toledo Service personnel use only.



## 12 Info

(PATH: Info)

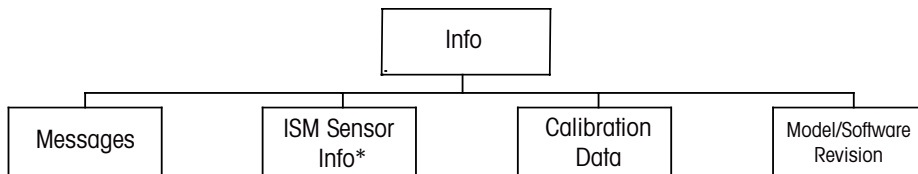

\* ISM version only

### 12.1 Info Menu

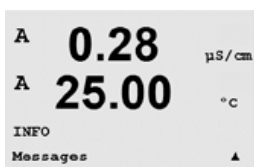

Pressing the ▼ key will display the Info Menu with the options Messages, Calibration Data and Model/Software Revision.

### 12.2 Messages

(PATH: Info/Messages)

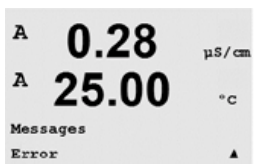

Enter Info Menu as described in section 12.1 “Info Menu” and press [ENTER].

The most recent message is displayed. The up and down arrow keys allow scrolling through the last four messages that have occurred.



Clear Messages clears all the messages. Messages are added to the message list when the condition that generates the message first occurs. If all messages are cleared and a message condition still exists and started before the clear then it will not appear in the list. For this message to re-occur in the list the condition must go away and then reappear.

### 12.3 Calibration Data

(PATH: Info/Calibration Data)



Enter Info Menu as described in section 12.1 “Info Menu”, select Calibration Data, and press [ENTER].

The menu displays the calibration constants for each sensor. Use the up and down arrow keys to toggle between channels “A” and “B”.

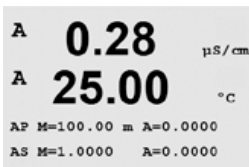

P = calibration constants for the primary measurement  
 S = calibration constants for the secondary measurement

Press [ENTER] to exit from this display.

## 12.4 Model/Software Revision

(PATH: Info/Model/Software Revision)

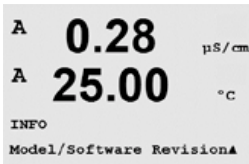

Enter Info Menu as described in section 12.1 "Info Menu", select Model/Software Revision, and press [ENTER].

Selecting Model/Software Revision will display the part number, model and the serial number of the transmitter. By using the ▼ key it is possible to navigate forward through this menu and get additional information like the current version of firmware implemented on the transmitter (Master V\_XXXX and Comm V\_XXXX); and – if an ISM sensor is connected – the version of the sensor firmware (FW V\_XXX) and sensor hardware (HW XXXX).

The displayed information is important for any Service call. Press [ENTER] to return to the normal measurement mode.



## 12.5 ISM Sensor Info (ISM version only)

(PATH: Info/ISM Sensor Info)



Enter Info Menu as described in section 12.1 "Info Menu", select ISM Sensor Info, and press [ENTER].

After plugging in an ISM sensor, the following information about the sensor will be shown in this menu. Use up and down arrows to scroll in the menu.



Type: Type of sensor (e.g. InPro 3250)  
 Cal Date: Date of the last calibration  
 Serial-No.: Serial number of the connected Sensor  
 Part-No.: Part number of the connected Sensor



---

## **13 Maintenance**

### **13.1 For Technical Support**

For technical support and product information for M300 Thornton Transmitters contact:

Mettler-Toledo Thornton, Inc.  
36 Middlesex Turnpike  
Bedford, MA 01730 USA  
Phone: 781-301-8600 or 800-510-PURE  
Fax: 781-271-0214  
Email: [service@thorntoninc.com](mailto:service@thorntoninc.com)

Or: Your local Mettler-Toledo Sales Office or representative.

### **13.2 Front Panel Cleaning**

Clean the front panel with a damp soft cloth (water only, no solvents). Gently wipe the surface and dry with a soft cloth.

## 14 Troubleshooting

If the equipment is used in a manner not specified by Mettler-Toledo Thornton, Inc., the protection provided by the equipment may be impaired.

Review the table below for possible causes of common problems:

Problem	Possible Cause
Display is blank.	<ul style="list-style-type: none"> <li>– No power to M300.</li> <li>– Blown fuse.</li> <li>– LCD display contrast set incorrectly.</li> <li>– Hardware failure.</li> </ul>
Incorrect measurement readings.	<ul style="list-style-type: none"> <li>– Sensor improperly installed.</li> <li>– Incorrect units multiplier entered.</li> <li>– Temperature compensation incorrectly set or disabled.</li> <li>– Sensor or transmitter needs calibration.</li> <li>– Sensor or patch cord defective or exceeds recommended maximum length.</li> <li>– Hardware failure.</li> </ul>
Measurement readings not stable.	<ul style="list-style-type: none"> <li>– Sensors or cables installed too close to equipment that generates high level of electrical noise.</li> <li>– Recommended cable length exceeded.</li> <li>– Averaging set too low.</li> <li>– Sensor or patch cord defective.</li> </ul>
Displayed $\Delta$ is flashing.	<ul style="list-style-type: none"> <li>– Setpoint is in alarm condition (setpoint exceeded).</li> <li>– Alarm, that has been selected (see chapter 8.5.1 "Alarm"), has occurred.</li> </ul>
Cannot change menu settings.	<ul style="list-style-type: none"> <li>– User locked out for security reasons.</li> </ul>

### 14.1 Changing the Fuse



Make sure that the mains cable is unplugged before changing the fuse. This operation should only be carried out by personnel familiar with the transmitter and who are qualified for such work.

If the power consumption of the M300 transmitter is too high or a malfunction leads to a short circuit the fuse will blow. In this case remove the fuse and replace it with one specified in Section 15 "Accessories and Spare Parts".

## 14.2 pH Error Messages / Warning- and Alarm List

Warnings	Description
Warning pH slope > 102%	Slope too big
Warning pH Slope < 90%	Slope too small
Warning pH Zero > 7.5 pH	Zero offset too big
Warning pH Zero < 6.5 pH	Zero offset too small
Warning pHGIs change < 0.3	Glass electrode resistance changed by more than factor 0.3
Warning pHGIs change > 3	Glass electrode resistance changed by more than factor 3
Warning pHRef change < 0.3	Reference electrode resistance changed by more than factor 0.3
Warning pHRef change > 3	Reference electrode resistance changed by more than factor 3

Alarms	Description
Watchdog time-out	SW/System fault
Error pH Slope > 103%	Slope too big
Error pH Slope < 80%	Slope too small
Error pH Zero > 8.0 pH	Zero offset too big
Error pH Zero < 6.0 pH	Zero offset too small
Error pH Ref Res > 150 K $\Omega$ *	Reference electrode resistance too big (break)
Error pH Ref Res < 2000 $\Omega$ *	Reference electrode resistance too small (short)
Error pH GIs Res > 2000 M $\Omega$ *	Glass electrode resistance too big (break)
Error pH GIs Res < 5 M $\Omega$ *	Glass electrode resistance too small (short)

\* According to the parameterization of the transmitter (see chapter 8.5.1 "Alarm";  
PATH: Menu/Configure/Alarm/Clean/Setup Alarm)

## 14.3 O<sub>2</sub> Error Messages / Warning- and Alarm List

Warnings	Description
Warning O <sub>2</sub> Slope < -90 nA	Slope too big
Warning O <sub>2</sub> Slope > -35 nA	Slope too small
Warning O <sub>2</sub> ZeroPt > 0.3 nA	Zero offset too big
Warning O <sub>2</sub> ZeroPt < -0.3 nA	Zero offset too small

Alarms	Description
Watchdog time-out	SW/System fault
Error O <sub>2</sub> Slope < -110 nA	Slope too big
Error O <sub>2</sub> Slope > -30 nA	Slope too small
Error O <sub>2</sub> ZeroPt > 0.6 nA	Zero offset too big
Error O <sub>2</sub> ZeroPt < -0.6 nA	Zero offset too small

## 14.4 Cond Error Messages / Warning- and Alarm List

Alarms	Description
Watchdog time-out	SW/System fault
Cond Cell open*	Cell running dry (no measurement solution) or wires are broken
Cond Cell shorted*	Short circuit caused by sensor or cable

\* According to the parameterization of the transmitter (see chapter 8.5.1 "Alarm";  
PATH: Menu/Configure/Alarm/Clean/Setup Alarm)

## 14.5 O<sub>2</sub>(I) Error Messages / Warning- and Alarm List (Thornton Models only)

Warnings	Description
Warning DO Slope < -460 nA	Slope too big
Warning DO Slope > -250 nA	Slope too small
Warning DO ZeroPt > 0.5 nA	Zero offset too big
Warning DO ZeroPt < -0.5 nA	Zero offset too small

Alarms	Description
Watchdog time-out	SW/System fault
Error Install O2 Jumper	Wrong installation of jumper
Error DO Slope < -525 nA	Slope too big
Error DO Slope > -220 nA	Slope too small
Error DO ZeroPt > 1.0 nA	Zero offset too big
Error DO ZeroPt < -1.0 nA	Zero offset too small

## 14.6 O<sub>2</sub>(V) Error Messages / Warning- and Alarm List (Thornton Models only)

Warnings	Description
Warning DO Slope > 1.50	Slope too big
Warning DO Slope < 0.65	Slope too small
Warning DO ZeroPt > 15 $\mu$ V	Zero offset too big
Warning DO ZeroPt < -15 $\mu$ V	Zero offset too small

Alarms	Description
Watchdog time-out	SW/System fault
Warning DO Slope < 2.00	Slope too big
Warning DO Slope < 0.25	Slope too small
Warning DO ZeroPt > 30 $\mu$ V	Zero offset too big
Warning DO ZeroPt < -30 $\mu$ V	Zero offset too small

## 14.7 Ozone Error Messages / Warning- and Alarm List (Thornton Models only)

Warnings	Description
Warning O <sub>3</sub> Slope >1.83 nA	Slope too big
Warning O <sub>3</sub> Slope <0.73 nA	Slope too small
Warning O <sub>3</sub> ZeroPt >0.5 nA	Zero offset too big
Warning O <sub>3</sub> ZeroPt <-0.5 nA	Zero offset too small

Alarms	Description
Watchdog time-out	SW/System fault
Error O <sub>3</sub> Slope >2.75 nA	Slope too big
Error O <sub>3</sub> Slope <0.65 nA	Slope too small
Error O <sub>3</sub> ZeroPt >1.0 nA	Zero offset too big
Error O <sub>2</sub> ZeroPt <-1.0 nA	Zero offset too small

## 14.8 Warning- and Alarm indication on the display

### 14.8.1 Warning indication

If there are conditions, that generate a warning, the message will be recorded through the menu Messages (see chapter 12.1 "Messages"; PATH: Info/Messages). According to the parameterisation of the transmitter the hint "Failure – Press Enter" will be shown at line 4 of the display if a warning or alarm has occurred (see chapter 8.6. "Display"; PATH: Menu/Configure/Display/Measurement).

### 14.8.2 Alarm indication

Alarms will be shown in the display by a flashing symbol  $\Delta$  and recorded through the menu Messages (see chapter 12.1 "Messages"; PATH: Info/Messages).

Furthermore the detection of some alarms can be activated or deactivated (see chapter 8.5 "Alarm/Clean"; PATH: Menu/Configure/Alarm/Clean) for an indication on the display. If one of these alarms occurs and the detection has been activated, the flashing symbol  $\Delta$  will be shown on the display. The message will be recorded through the menu Messages (see chapter 12.1 "Messages"; PATH: Info/Messages).

Alarms, that are caused by a violation of the limitation of a setpoint or the range (see chapter 8.4 "Setpoints"; PATH: Menu/Configure/Setpoint) will be shown by a flashing symbol  $\Delta$  and recorded through the menu Messages (see chapter 12.1 "Messages"; PATH: Info/Messages).

According to the parameterisation of the transmitter the hint "Failure – Press Enter" will be shown at line 4 of the display if a warning or alarm has occurred (see chapter 8.6. "Display"; PATH: Menu/Configure/Display/Measurement).

## 15 Accessories and Spare Parts

Please contact your local Mettler-Toledo Sales office or representative for details for additional accessories and spare parts.

For M300 Thornton

<b>Description</b>	<b>Order no.</b>
Pipe Mount Kit for 1/2DIN models	52 500 212
Panel Mount Kit for 1/2DIN models	52 500 213
Adaptor Panel – M300 to 200/2000 cutout	58 083 300
M300 Conductivity Calibrator Module	58 082 300
Replacement power fuse 5x20 mm, 1 A, 250 V, time lag, Littlefuse or Hollyland	58 091 326
Terminal blocks for M300	52 500 504

For M300

<b>Description</b>	<b>Order no.</b>
Pipe Mount Kit for 1/2DIN models	52 500 212
Panel Mount Kit for 1/2DIN models	52 500 213
Protective Hood for 1/2DIN models	52 500 214
Terminal blocks for M300, M400	52 500 504

## 16 Specifications

### 16.1 General specifications

<b>Conductivity/resistivity Specifications</b>	
Range 0.01 cm <sup>-1</sup> constant sensor	0.002 to 200 µS/cm (5000 Ω x cm to 500 MΩ x cm)
Range 0.1 cm <sup>-1</sup> constant sensor	0.02 to 2000 µS/cm (500 Ω x cm to 50 MΩ x cm)
Range 10 cm <sup>-1</sup> constant sensor	10 to 40,000 µS/cm (25 Ω x cm to 100 KΩ x cm)
Display range for 2-e sensor	0 to 40,000 mS/cm (25 Ω x cm to 100 MΩ x cm)
Display range for 4-e sensor	0.01 to 650 mS/cm (1.54 Ω x cm to 0.1MΩ x cm)
Chemical concentration curves	NaCl: 0–26% @ 0°C to 0–28% @ +100 °C NaOH: 0–12% @ 0°C to 0–16% @ +40 °C to 0–6% @ +100 °C HCl: 0–18% @ –20 °C to 0–18% @ 0 °C to 0–5% @ +50 °C HNO <sub>3</sub> : 0–30% @ –20 °C to 0–30% @ 0 °C to 0–8% @ +50 °C H <sub>2</sub> SO <sub>4</sub> : 0–26% @ –12 °C to 0–26% @ +5 °C to 0–9% @ +100 °C H <sub>3</sub> PO <sub>4</sub> : 0–35% @ +5 °C to +80 °C
TDS ranges	NaCl, CaCO <sub>3</sub>
Temperature input*	Pt1000
Temperature measuring range	–40 to + 200.0 °C (–40 to 392 °F)
Sensor maximum distance	Analogue 2-e: 61 m (200 ft), Analogue 4-e: 15 m (50 ft), ISM 2-e: 90 m (300 ft) ISM 4-e: 80 m (260 ft),
Cond/Res resolution	Auto/0.001/0.01/0.1/1 (can be selected)
Cond/Res accuracy**	± 0.5% of reading or 0.25Ω, whichever is greater,
Cond/Res repeatability**	± 0.25% of reading or 0.25 ohm, whichever is greater
Temperature resolution	Auto/0.001/0.01/0.1/1 °C (°F) (can be selected)
Temperature accuracy**	±0.25°C (±0.45 °F)
Temperature repeatability**	±0.13°C (±0.23 °F)
<b>pH Specifications</b>	
pH range	–1.00 to 15.00 pH
mV range	–1500 to 1500 mV
Temperature input*	Pt1000 (Pt100 with adapter)
Temperature measuring range	–30 to 130 °C (–22 to 266 °F)
Sensor maximum distance	Analogue: 10 to 20 m (33 to 65 ft) depending on sensor ISM: 80 m (260 ft)
pH resolution	auto/0.01/0.1/1 (can be selected)
pH accuracy**	±0.03 pH
mV resolution	1 mV
mV accuracy	± 2 mV
Temperature resolution	Auto/0.001/0.01/0.1/1 °C (°F), (can be selected)
Temperature accuracy**	±0.25°C (±0.45 °F)

\* Not required on ISM sensors

\*\* For analogue input signal (ISM signal causes no additional error)

<b>Available Buffer Sets:</b>	
MT-9 buffers, MT-10 buffers, NIST Technical Buffers, NIST Standard Buffers (DIN 19266:2000-01), JIS Standard, Hach buffers, CIBA (94) buffers, Merck Titrisols-Reidel Fixanals, WTW buffers	
<b>Dissolved Oxygen Specifications</b>	
Measuring current range	0 to 900 nA
Concentration range	0.00 to 50.00 ppm (mg/l)
Temperature input*	NTC 22 k $\Omega$
Temperature measuring range	-10 to 80 °C (14 to 176 °F)
Sensor maximum distance	Analogue: 20 m ( 65 ft) ISM: 80 m (260 ft)
DO resolution	Auto/0.001/0.01/0.1/1, (can be selected)
DO accuracy**	$\pm 0.5\%$ of full scale reading
Temperature resolution	Auto/0.001/0.01/0.1/1 °C (°F), (can be selected)
Temperature accuracy**	$\pm 0.25$ °C ( $\pm 0.45$ °F)
<b>Dissolved Ozone Specifications</b>	
Ozone range	0–5,000 ppb, 0–5 ppm
Ozone resolution	1 ppb, 0.001 ppm
Relative accuracy	$\pm 2\%$ of reading or $\pm 3$ ppb, system
Temperature input	Pt1000

\* Not required on ISM sensors

\*\* For analogue input signal (ISM signal causes no additional error)



## 16.2 Electrical specifications for 1/2DIN and 1/4DIN versions

Power requirements	100 to 240 VAC or 20 to 30 VDC, 10 VA; AWG 14 < 2.5 mm <sup>2</sup>
Frequency	50 to 60 Hz
Analog output signals	4 (2 for single channel version) 0/4 to 22 mA outputs, galvanically isolated from input and from earth/ground
Measurement Error through analog outputs	< ±0.05 mA over 1 to 22 mA range, < ±0.1 mA over 0 to 1 mA range
Analog output configuration	Linear, Bi-Linear, Logarithmic, Autoranging
Load	Max. 500 Ω
Connection terminals	Detachable screw terminals
Digital communication	USB port, Type B connector
PID process controller	Pulse length, pulse frequency or analog control
Cycle time	Ca 1 sec.
Connection terminals	Detachable screw terminals
Digital Input	1 (2 for dual channel version) with switching limits 0.00 VDC to 1.00 VDC for low level 2.30 VDC to 30.00 VDC for high level
Mains power fuse	1.0 A slow blow type FC
Relays	– 2-SPDT mechanical 250 VAC, 30 VDC, 3 Amps – 2-SPST mechanical rated at 250 VAC, 3 Amps (dual channel only) – 2-Reed 250 VAC or DC, 0.5 A, 10 W
Alarm Relay delay	0–999 s
Keypad	5 tactile feedback keys
Display	Backlit LCD, four-line



**NOTE:** This is a 4-wire-product with an active 4–20 mA analog output.  
Please do not supply to Pin1–Pin6 of TB2.

## 16.3 Mechanical specifications for 1/4DIN version

Dimensions (housing – H x W x D)*	96 x 96 x 140 mm (1/4DIN model)
Front bezel – (H x W)	102 x 102 mm
Max. depth	125 mm (excludes plug-in connectors)
Weight	0.6 kg (1.5 lb)
Material	ABS/polycarbonate
Ingress rating	IP 65 (front)/IP 20 (housing)

\* H = Height, W = Width, D = Depth

## 16.4 Mechanical specifications for 1/2DIN version

Dimensions (housing – H x W x D)*	144 x 144 x 116 mm
Front bezel – H x W	150 x 150 mm
Max. D – panel mounted	87 mm (excludes plug-in connectors)
Weight	0.95 kg (2 lb)
Material	ABS/polycarbonate
Ingress rating	IP 65 (when back cover is attached)

\* H = Height, W = Width, D = Depth

## 16.5 Environmental specifications for 1/2DIN and 1/4DIN versions

Storage temperature	–40 to 70 °C (–40 to 158 °F)
Ambient temperature operating range	–10 to 50 °C (14 to 122 °F)
Relative humidity	0 to 95% non-condensing
Emissions	According to EN55011 Class A
UL Electrical Environment	Installation (overvoltage) category II

## 17 Default tables

### 17.1 M300 ISM (Single-Channel Instruments)

Parameter	Sub parameter	Value	Unit
Alarm	Relay	2	
	Power Failure	No	
	Software Failure	No	
	Rg Diagnostics	No	
	Rr Diagnostics	No	
	Cond Cell Open	No	
	Cond Cell Shorted	No	
	Disconnect ChA	No	
	Hold Mode*	Last	
	Delay	1	Sec
	Hysteresis	0	
	State	Inverted	
	Clean	Relay	1
Hold Mode*		Last	
Interval		0	Hrs
Clean time		0	Sec
State		Normal	
Delay		0	
Language		English	
Passwords	Administrator	00000	
	Operator	00000	
All Relays (Unless Otherwise Specified)	Delay	10	Sec
	Hysteresis	5	%
	State	Normal	
	Hold Mode*	Last	
Lockout	Yes/No	No	
Display	Line 1	a	
	Line 2	b	
	Line 3	c (not available)	
	Line 4	d (not available)	
Analog Out	1	a	
	2	b	
All analog out	Mode	4–20 mA	
	Type	Normal	
	Alarm	Off	
	Hold Mode	Last Value	

Parameter	Sub parameter	Value	Unit
Conductivity <i>Resistivity</i>	Value 4 mA	0.1 <i>10</i>	$\mu\text{S/cm}$ <i>M<math>\Omega</math>-cm</i>
	Value 20 mA	10 <i>20</i>	$\mu\text{S/cm}$ <i>M<math>\Omega</math>-cm</i>
O <sub>2</sub>	Value 4 mA	0	%sat
	Value 20 mA	100	%sat
pH	Value 4 mA	2	pH
	Value 20 mA	12	pH
Temperature	Value 4 mA	0	°C
	Value 20 mA	100	°C
Set Point 1	Measurement	a	
	Type	Off	
Conductivity <i>Resistivity</i>	High Value	0 <i>0</i>	$\mu\text{S/cm}$ <i>M<math>\Omega</math>-cm</i>
	Low Value	0 <i>0</i>	$\mu\text{S/cm}$ <i>M<math>\Omega</math>-cm</i>
O <sub>2</sub>	High Value	50	%sat
	Low Value	0	%sat
pH	High Value	12	pH
	Low Value	0	pH
Relay 3	Set point	1	
Set Point 2	Measurement	b	
	Type	Off	
	High Value	0	°C
	Low Value	0	°C
Relay 4	Set Point	2	
Resolution		Auto	
Conductivity Resistivity	Compensation	Standard	
O <sub>2</sub>	V polarisation**	-675	mV
	CalPres	759.8	mmHg
	ProcPres	759.8	mmHg
	ProcCalPres	CalPres	
	Salinity	0.0	g/kg
	Humidity	100	%
pH	Drift Control	Auto	
	IP	7.0	pH
	STC	0.000	pH/°C
	FixCalTemp	No	
	pH Buffer	Mettler-9	
	Cal info slope	[%]	
	Cal info offset	[pH]	

\* For analogue output signal if relay is switched

\*\* Not adjustable

*Italics = default values if resistivity instead of conductivity is chosen.*

## 17.2 M300 ISM (Dual-Channel Instruments)

Parameter	Sub parameter	Value	Unit
Alarm	Relay	2	
	Power Failure	No	
	Software Failure	No	
	Rg Diagnostics	No	
	Rr Diagnostics	No	
	Cond Cell Open	No	
	Cond Cell Shorted	No	
	Disconnect ChA	No	
	Disconnect CHB	No	
	Hold Mode*	Last	
	Delay	1	Sec
	Hysteresis	0	
	State	Inverted	
Clean	Relay	1	
	Hold Mode*	Last	
	Interval	0	Hrs
	Clean time	0	Sec
	State	Normal	
	Delay	0	
	Hysteresis	0	
Language		English	
Passwords	Administrator	00000	
	Operator	00000	
All Relays (Unless Otherwise Specified)	Delay	10	Sec
	Hysteresis	5	%
	State	Normal	
	Hold Mode*	Last	
Lockout	Yes/No	No	
Display	Line 1	a	
	Line 2	b	
	Line 3	c	
	Line 4	d	
Analog Out	1	a	
	2	b	
	3	c	
	4	d	
All analog out	Mode	4–20 mA	
	Type	Normal	
	Alarm	Off	
	Hold Mode	Last Value	
Conductivity <i>Resitivity</i>	Value 4 mA	0.1 10	$\mu\text{S/cm}$ $M\Omega\text{-cm}$
	Value 20 mA	10 20	$\mu\text{S/cm}$ $M\Omega\text{-cm}$
O <sub>2</sub>	Value 4 mA	0	%sat
	Value 20 mA	100	%sat

Parameter	Sub parameter	Value	Unit
pH	Value 4 mA	2	pH
	Value 20 mA	12	pH
Temperature	Value 4 mA	0	°C
	Value 20 mA	100	°C
Set Point 1	Measurement	a	
	Type	Off	
Conductivity <i>Resitivity</i>	High Value	0 <i>0</i>	μS/cm <i>MΩ-cm</i>
	Low Value	0 <i>0</i>	μS/cm <i>MΩ-cm</i>
O <sub>2</sub>	High Value	50	%sat
	Low Value	0	%sat
pH	High Value	12	pH
	Low Value	0	pH
Relay 3	Set point	1	
Set Point 2	Measurement	c	
	Type	Off	
Conductivity <i>Resitivity</i>	High Value	0 <i>0</i>	μS/cm <i>MΩ-cm</i>
	Low Value	0 <i>0</i>	μS/cm <i>MΩ-cm</i>
O <sub>2</sub>	High Value	50	%sat
	Low Value	0	%sat
pH	High Value	12	pH
	Low Value	0	pH
Relay 4	Set Point	2	
Resolution		Auto	
Set Point 3	Measurement	_(none)	
	Type	Off	
	Relay	_(none)	
Set Point 4	Measurement	_(none)	
	Type	Off	
	Relay	_(none)	
Conductivity Resistivity	Compensation	Standard	
O <sub>2</sub>	V polarisation**	-675	mV
	CalPres	759.8	mmHg
	ProcPres	759.8	mmHg
	ProcCalPres	CalPres	
	Salinity	0.0	g/kg
	Humidity	100	%
pH	Drift Control	Auto	
	IP	7.0	pH
	STC	0.000	pH/°C
	FixCalTemp	No	
	pH Buffer	Mettler-9	
	Cal info slope	[%]	
	Cal info offset	[pH]	

\* For analogue output signal if relay is switched \*\* Not adjustable

*Italics = default values if resitivity instead of conductivity is chosen.*

### 17.3 M300 Conductivity (Single-Channel Instruments)

Parameter	Sub parameter	Value	Unit
Alarm	Relay	2	
	Power Failure	No	
	Software Failure	No	
	Cond Cell Open	No	
	Cond Cell Shorted	No	
	Hold Mode*	Last	
	Delay	1	Sec
	Hysteresis	0	
Clean	State	Inverted	
	Relay	1	
	Hold Mode*	Last	
	Interval	0	Hrs
	Clean time	0	Sec
	State	Normal	
	Delay	0	
	Hysteresis	0	
Language		English	
Passwords	Administrator	00000	
	Operator	00000	
All Relays (Unless Otherwise Specified)	Delay	10	Sec
	Hysteresis	5	%
	State	Normal	
	Hold Mode*	Last	
Lockout	Yes/No	No	
Display	Line 1	a (Conductivity)	S/cm
	Line 2	b (Temperature)	°C
	Line 3	c (not available)	
	Line 4	d (not available)	
Cal constants	Cond/Res	M = 0.1 A = 0.0	cm <sup>-1</sup> Ω
	Temperature	M = 1.0, A = 0.0	Ω
Analog Out	1	a (Resitivity)	
	2	b (Temperature)	
All analog out	Mode	4–20 mA	
	Type	Normal	
	Alarm	Off	
	Hold Mode	Last Value	
Conductivity <i>Resitivity</i>	Value 4 mA	0.1 10	μS/cm MΩ-cm
	Value 20 mA	10 20	μS/cm MΩ-cm
Temperature	Value 4 mA	0	°C
	Value 20 mA	100	°C

Parameter	Sub parameter	Value	Unit
Set Point 1	Measurement	a	
	Type	Off	
	High Value	0 <i>0</i>	$\mu\text{S/cm}$ $\text{M}\Omega\text{-cm}$
	Low Value	0 <i>0</i>	$\mu\text{S/cm}$ $\text{M}\Omega\text{-cm}$
Relay 3	Set point	1	
Set Point 2	Measurement	b	
	Type	Off	
	High Value	0	$^{\circ}\text{C}$
	Low Value	0	$^{\circ}\text{C}$
Relay 4	Set Point	2	
Resolution		Auto	
Conductivity Resistivity	Compensation	Standard	

\* For analogue output signal if relay is switched

*Italics = default values if resistivity instead of conductivity is chosen.*

## 17.4 M300 O<sub>2</sub> (Single-Channel Instruments)

Parameter	Sub parameter	Value	Unit
Alarm	Relay	2	
	Power Failure	No	
	Software Failure	No	
	Hold Mode*	Last	
	Delay	1	Sec
	Hysteresis	0	
	State	Inverted	
Clean	Relay	1	
	Hold Mode*	Last	
	Interval	0	Hrs
	Clean time	0	Sec
	State	Normal	
	Delay	0	
	Hysteresis	0	
Language		English	
Passwords	Administrator	00000	
	Operator	00000	
All Relays (Unless Otherwise Specified)	Delay	10	Sec
	Hysteresis	5	%
	State	Normal	
	Hold Mode*	Last	
Lockout	Yes/No	No	



Parameter	Sub parameter	Value	Unit
Display	Line 1	a (O2)	% sat
	Line 2	b (Temperature)	°C
	Line 3	c (not available)	
	Line 4	d (not available)	
Cal constants	O2	S = -70.00 A = 0.0	nA nA
	Temperature	M = 1.0 A = 0.0	Ω
Analog Out	1	a (O2)	
	2	b (Temperature)	
All analog out	Mode	4–20 mA	
	Type	Normal	
	Alarm	Off	
	Hold Mode	Last Value	
O2	Value 4 mA	0	% sat
	Value 20 mA	100	% sat
Temperature	Value 4 mA	0	°C
	Value 20 mA	100	°C
Set Point 1	Measurement	a	
	Type	Off	
	High Value	50	% sat
	Low Value	0	% sat
Relay 3	Set point	1	
Set Point 2	Measurement	b	
	Type	Off	
	High Value	0	°C
	Low Value	0	°C
Relay 4	Set Point	2	
Resolution		Auto	
O2	V polarisation**	-675	mV
	CalPres	759.8	mmHg
	ProcPres	759.8	mmHg
	ProcCalPres	CalPres	
	Salinity	0.0	g/kg
	Humidity	100	%

\* For analogue output signal if relay is switched

\*\* Not adjustable

## 17.5 M300 pH (Single-Channel Instruments)

Parameter	Sub parameter	Value	Unit
Alarm	Relay	2	
	Power Failure	No	
	Software Failure	No	
	Rg diagnostics	No	
	Rr diagnostics	No	
	Hold Mode*	Last	
	Delay	1	Sec
	Hysteresis	0	
	State	Inverted	
Clean	Relay	1	
	Hold Mode*	Last	
	Interval	0	Hrs
	Clean time	0	Sec
	State	Normal	
	Delay	0	
	Hysteresis	0	
Language		English	
Passwords	Administrator	00000	
	Operator	00000	
All Relays (Unless Otherwise Specified)	Delay	10	Sec
	Hysteresis	5	%
	State	Normal	
	Hold Mode*	Last	
Lockout	Yes/No	No	
Display	Line 1	a (pH)	pH
	Line 2	b (Temperature)	°C
	Line 3	c (not available)	
	Line 4	d (not available)	
Cal constants	pH	S = 100 Z = 7.0	% pH
	Temperature	M = 1.0 A = 0.0	Ω
Analog Out	1	a (pH)	
	2	b (Temperature)	
All analog out	Mode	4–20 mA	
	Type	Normal	
	Alarm	Off	
	Hold Mode	Last Value	
pH	Value 4 mA	2	pH
	Value 20 mA	12	pH
Temperature	Value 4 mA	0	°C
	Value 20 mA	100	°C

Parameter	Sub parameter	Value	Unit
Set Point 1	Measurement	a	
	Type	Off	
	High Value	12	pH
	Low Value	0	pH
Relay 3	Set point	1	
Set Point 2	Measurement	b	
	Type	Off	
	High Value	0	°C
	Low Value	0	°C
Relay 4	Set Point	2	
Resolution		Auto	
pH	Drift Control	Auto	
	IP	7.0	
	STC	0.000	pH/°C
	Fix CalTemp	No	
	pH Buffer	Mettler-9	
	Cal info slope	[%]	
	Cal info offset	[pH]	

\* For analogue output signal if relay is switched

## 17.6 M300 Multiparameter (Dual-Channel Instruments)

Parameter	Sub parameter	Value	Unit	
Alarm	Relay	2		
	Power Failure	No		
	Software Failure	No		
	Rg Diagnostics	No		
	Rr Diagnostics	No		
	Cond Cell Open	No		
	Cond Cell Shorted	No		
	Hold Mode*	Last		
	Delay	1	Sec	
	Hysteresis	0		
Clean	State	Inverted		
	Relay	1		
	Hold Mode*	Last		
	Interval	0	Hrs	
	Clean time	0	Sec	
	State	Normal		
	Delay	0		
Language	Hysteresis	0		
		English		
Passwords	Administrator	00000		
	Operator	00000		
All Relays (Unless Otherwise Specified)	Delay	10	Sec	
	Hysteresis	5	%	
	State	Normal		
	Hold Mode*	Last		
Lockout	Yes/No	No		
Display	Line 1	a		
	Line 2	b		
	Line 3	c		
	Line 4	d		
Cal Constants	Cond/Res	M = 0.1 A = 0.0	cm <sup>-1</sup> Ω	
	O2	S = -70.00 Z = 0.00	nA nA	
	O2(I)***	S = -350.00 Z = 0.00	nA nA	
	O2(V)***	S = 1.000 Z = 0.000	μV	
	pH	S = 100 Z = 7.0	% pH	
	O3***	S = -1.000 M = 0.000	nA	
	Temperature		M = 1.0 A = 0.0	Ω

Parameter	Sub parameter	Value	Unit
Analog Out	1	a	
	2	b	
	3	c	
	4	d	
All analog out	Mode	4–20 mA	
	Type	Normal	
	Alarm	Off	
	Hold Mode	Last Value	
Conductivity <i>Resitivity</i>	Value 4 mA	0.1 10	μS/cm MΩ-cm
	Value 20 mA	10 20	μS/cm MΩ-cm
O <sub>2</sub>	Value 4 mA	0	%sat
	Value 20 mA	100	%sat
pH	Value 4 mA	2	pH
	Value 20 mA	12	pH
O <sub>2</sub> (I)***	Value 4 mA	0	ppb
	Value 20 mA	100	ppb
O <sub>2</sub> (V)***	Value 4 mA	0	ppb
	Value 20 mA	100	ppb
Dissolved Ozone***	Value 4 mA	0.000	ppb
	Value 20 mA	20.00	ppm
Temperature	Value 4 mA	0	°C
	Value 20 mA	100	°C
Set Point 1	Measurement	a	
	Type	Off	
Conductivity <i>Resitivity</i>	High Value	0 0	μS/cm MΩ-cm
	Low Value	0 0	μS/cm MΩ-cm
O <sub>2</sub>	High Value	50	%sat
	Low Value	0	%sat
pH	High Value	12	pH
	Low Value	0	pH
O <sub>2</sub> (I)***	High Value	40.00	ppb
	Low Value	0.000	ppb
O <sub>2</sub> (V)***	High Value	0.000	ppb
	Low Value	0.000	ppb
Dissolved Ozone***	High Value	0.000	ppb
	Low Value	0.000	ppb
Relay 3	Set point	1	
Set Point 2	Measurement	c	
	Type	Off	
Conductivity <i>Resitivity</i>	High Value	0 0	μS/cm MΩ-cm
	Low Value	0 0	μS/cm MΩ-cm
O <sub>2</sub>	High Value	50	%sat
	Low Value	0	%sat

Parameter	Sub parameter	Value	Unit
pH	High Value	12	pH
	Low Value	0	pH
O <sub>2</sub> (I) <sup>***</sup>	High Value	40.00	ppb
	Low Value	0.000	ppb
O <sub>2</sub> (V) <sup>***</sup>	High Value	0.000	ppb
	Low Value	0.000	ppb
Dissolved Ozone <sup>***</sup>	High Value	0.000	ppb
	Low Value	0.000	ppb
Relay 4	Set Point	2	
Resolution		Auto	
Set Point 3	Measurement	_(none)	
	Type	Off	
	Relay	_(none)	
Set Point 4	Measurement	_(none)	
	Type	Off	
	Relay	_(none)	
Conductivity Resistivity	Compensation	Standard	
O <sub>2</sub>	V polarisation <sup>**</sup>	-675	mV
	CalPres	759.8	mmHg
	ProcPres	759.8	mmHg
	ProcCalPres	CalPres	
	Salinity	0.0	g/kg
	Humidity	100	%
pH	Drift Control	Auto	
	IP	7.0	pH
	STC	0.000	pH/°C
	FixCalTemp	No	
	pH Buffer	Mettler-9	
	Cal info slope	[%]	
	Cal info offset	[pH]	

\* For analogue output signal if relay is switched

\*\* Not adjustable

\*\*\* Thornton models only

*Italics = default values if resistivity instead of conductivity is chosen.*

## 17.7 M300 Conductivity (Dual-Channel Instruments, Thornton Models only)

Parameter	Sub parameter	Value	Unit
Alarm	Relay	2	
	Power Failure	No	
	Software Failure	No	
	Cond Cell Open	No	
	Cond Cell Shorted	No	
	Hold Mode*	Last	
	Delay	1	Sec
	Hysteresis	0	
Clean	State	Inverted	
	Relay	1	
	Hold Mode*	Last	
	Interval	0	Hrs
	Clean time	0	Sec
	State	Normal	
	Delay	0	
	Hysteresis	0	
Language		English	
Passwords	Administrator	00000	
	Operator	00000	
All Relays (Unless Otherwise Specified)	Delay	10	Sec
	Hysteresis	5	%
	State	Normal	
	Hold Mode*	Last	
Lockout	Yes/No	No	
Display	Line 1	a (Resistivity)	$\Omega$ -cm
	Line 2	b (Temperature)	$^{\circ}\text{C}$
	Line 3	c (Resistivity)	$\Omega$ -cm
	Line 4	d (Temperature)	$^{\circ}\text{C}$
Cal Constants	Cond/Res	M = 0.1 A = 0.0	$\text{cm}^{-1}$ $\Omega$
	Temperature	M = 1.0 A = 0.0	$\Omega$
Analog Out	1	a (Resistivity)	
	2	b (Temperature)	
	3	c (Resistivity)	
	4	d (Temperature)	
All analog out	Mode	4–20 mA	
	Type	Normal	
	Alarm	Off	
	Hold Mode	Last Value	

Parameter	Sub parameter	Value	Unit
Conductivity <i>Resitivity</i>	Value 4 mA	0.1 <i>10</i>	$\mu\text{S/cm}$ <i>M<math>\Omega</math>-cm</i>
	Value 20 mA	10 <i>20</i>	$\mu\text{S/cm}$ <i>M<math>\Omega</math>-cm</i>
Temperature	Value 4 mA	0	°C
	Value 20 mA	100	°C
Set Point 1	Measurement	a (Resistivity)	
	Type	Off	
Conductivity <i>Resitivity</i>	High Value	0 <i>0</i>	$\mu\text{S/cm}$ <i>M<math>\Omega</math>-cm</i>
	Low Value	0 <i>0</i>	$\mu\text{S/cm}$ <i>M<math>\Omega</math>-cm</i>
Relay 3	Set point	1	
Set Point 2	Measurement	c	
	Type	Off	
Conductivity <i>Resitivity</i>	High Value	0 <i>0</i>	$\mu\text{S/cm}$ <i>M<math>\Omega</math>-cm</i>
	Low Value	0 <i>0</i>	$\mu\text{S/cm}$ <i>M<math>\Omega</math>-cm</i>
Relay 4	Set Point	2	
Resolution		Auto	
Set Point 3	Measurement	_(none)	
	Type	Off	
	Relay	_(none)	
Set Point 4	Measurement	_(none)	
	Type	Off	
	Relay	_(none)	
Conductivity Resistivity	Compensation	Standard	

\* For analogue output signal if relay is switched

*Italics = default values if resistivity instead of conductivity is chosen.*



## 18 Warranty

METTLER TOLEDO warrants this product to be free from significant deviations in material and workmanship for a period of one year from the date of purchase. If repair is necessary and not the result of abuse or misuse within the warranty period, please return by freight pre-paid and amendment will be made without any charge. METTLER TOLEDO's Customer Service Dept. will determine if the product problem is due to deviations or customer abuse. Out-of-warranty products will be repaired on an exchange basis at cost.

The above warranty is the only warranty made by METTLER TOLEDO and is lieu of all other warranties, expressed or implied, including, without limitation, implied warranties of merchantability and fitness for a particular purpose. METTLER TOLEDO shall not be liable for any loss, claim, expense or damage caused by, contributed to or arising out of the acts or omissions of the Buyer or Third Parties, whether negligent or otherwise. In no event shall METTLER TOLEDO's liability for any cause of action whatsoever exceed the cost of the item giving rise to the claim, whether based in contract, warranty, indemnity, or tort (including negligence).

## 19 Certificate

Mettler-Toledo Thornton, Inc., 36 Middlesex Turnpike, Bedford, MA 01730, USA has obtained Underwriters Laboratories' listing for M300 Model Transmitters. They bear the cULus Listed mark, signifying that the products have been evaluated to the applicable ANSI/UL and CSA Standards for use in the U.S. and Canada.

## 20 Buffer tables

M300 transmitters have the ability to do automatic pH buffer recognition. The following tables show different standard buffers that are automatically recognized.

### 20.1 Mettler-9

Temp (°C)	pH of buffer solutions			
0	2.03	4.01	7.12	9.52
5	2.02	4.01	7.09	9.45
10	2.01	4.00	7.06	9.38
15	2.00	4.00	7.04	9.32
20	2.00	4.00	7.02	9.26
25	2.00	4.01	7.00	9.21
30	1.99	4.01	6.99	9.16
35	1.99	4.02	6.98	9.11
40	1.98	4.03	6.97	9.06
45	1.98	4.04	6.97	9.03
50	1.98	4.06	6.97	8.99
55	1.98	4.08	6.98	8.96
60	1.98	4.10	6.98	8.93
65	1.99	4.13	6.99	8.90
70	1.99	4.16	7.00	8.88
75	2.00	4.19	7.02	8.85
80	2.00	4.22	7.04	8.83
85	2.00	4.26	7.06	8.81
90	2.00	4.30	7.09	8.79
95	2.00	4.35	7.12	8.77

### 20.2 Mettler-10

Temp (°C)	pH of buffer solutions			
0	2.03	4.01	7.12	10.32
5	2.02	4.01	7.09	10.25
10	2.01	4.00	7.06	10.18
15	2.00	4.00	7.04	10.12
20	2.00	4.00	7.02	10.06
25	2.00	4.01	7.00	10.01
30	1.99	4.01	6.99	9.97
35	1.99	4.02	6.98	9.93
40	1.98	4.03	6.97	9.89
45	1.98	4.04	6.97	9.86
50	1.98	4.06	6.97	9.83
55	1.98	4.08	6.98	9.83
60	1.98	4.10	6.98	9.83
65	1.99	4.13	6.99	9.83
70	1.99	4.16	7.00	9.83
75	2.00	4.19	7.02	9.83
80	2.00	4.22	7.04	9.83
85	2.00	4.26	7.06	9.83
90	2.00	4.30	7.09	9.83
95	2.00	4.35	7.12	9.83

## 20.3 NIST Technical Buffers

Temp (°C)	pH of buffer solutions				
0	1.67	4.00	7.115	10.32	13.42
5	1.67	4.00	7.085	10.25	13.21
10	1.67	4.00	7.06	10.18	13.01
15	1.67	4.00	7.04	10.12	12.80
20	1.675	4.00	7.015	10.06	12.64
25	1.68	4.005	7.00	10.01	12.46
30	1.68	4.015	6.985	9.97	12.30
35	1.69	4.025	6.98	9.93	12.13
40	1.69	4.03	6.975	9.89	11.99
45	1.70	4.045	6.975	9.86	11.84
50	1.705	4.06	6.97	9.83	11.71
55	1.715	4.075	6.97	9.83*	11.57
60	1.72	4.085	6.97	9.83*	11.45
65	1.73	4.10	6.98	9.83*	11.45*
70	1.74	4.13	6.99	9.83*	11.45*
75	1.75	4.14	7.01	9.83*	11.45*
80	1.765	4.16	7.03	9.83*	11.45*
85	1.78	4.18	7.05	9.83*	11.45*
90	1.79	4.21	7.08	9.83*	11.45*
95	1.805	4.23	7.11	9.83*	11.45*

\* Extrapolated

## 20.4 NIST standard buffers (DIN 19266: 2000–01)

Temp (°C)	pH of buffer solutions			
0				
5	1.668	4.004	6.950	9.392
10	1.670	4.001	6.922	9.331
15	1.672	4.001	6.900	9.277
20	1.676	4.003	6.880	9.228
25	1.680	4.008	6.865	9.184
30	1.685	4.015	6.853	9.144
35	1.694	4.028	6.841	9.095
40	1.697	4.036	6.837	9.076
45	1.704	4.049	6.834	9.046
50	1.712	4.064	6.833	9.018
55	1.715	4.075	6.834	8.985
60	1.723	4.091	6.836	8.962
70	1.743	4.126	6.845	8.921
80	1.766	4.164	6.859	8.885
90	1.792	4.205	6.877	8.850
95	1.806	4.227	6.886	8.833



**NOTE:** The pH(S) values of the individual charges of the secondary reference materials are documented in a certificate of an accredited laboratory. This certificate is supplied with the respective buffer materials. Only these pH(S) values shall be used as standard values for the secondary reference buffer materials. Correspondingly, this standard does not include a table with standard pH values for practical use. The table above only provides examples of pH(PS) values for orientation.

## 20.5 Hach buffers

Buffer values up to 60 °C as specified by Bergmann & Beving Process AB.

Temp (°C)	pH of buffer solutions		
0	4.00	7.14	10.30
5	4.00	7.10	10.23
10	4.00	7.04	10.11
15	4.00	7.04	10.11
20	4.00	7.02	10.05
25	4.01	7.00	10.00
30	4.01	6.99	9.96
35	4.02	6.98	9.92
40	4.03	6.98	9.88
45	4.05	6.98	9.85
50	4.06	6.98	9.82
55	4.07	6.98	9.79
60	4.09	6.99	9.76
65	4.09*	6.99*	9.76*
70	4.09*	6.99*	9.76*
75	4.09*	6.99*	9.76*
80	4.09*	6.99*	9.76*
85	4.09*	6.99*	9.76*
90	4.09*	6.99*	9.76*
95	4.09*	6.99*	9.76*

\* Values complemented

## 20.6 Ciba (94) buffers

Temp (°C)	pH of buffer solutions			
0	2.04	4.00	7.10	10.30
5	2.09	4.02	7.08	10.21
10	2.07	4.00	7.05	10.14
15	2.08	4.00	7.02	10.06
20	2.09	4.01	6.98	9.99
25	2.08	4.02	6.98	9.95
30	2.06	4.00	6.96	9.89
35	2.06	4.01	6.95	9.85
40	2.07	4.02	6.94	9.81
45	2.06	4.03	6.93	9.77
50	2.06	4.04	6.93	9.73
55	2.05	4.05	6.91	9.68
60	2.08	4.10	6.93	9.66
65	2.07*	4.10*	6.92*	9.61*
70	2.07	4.11	6.92	9.57
75	2.04*	4.13*	6.92*	9.54*
80	2.02	4.15	6.93	9.52
85	2.03*	4.17*	6.95*	9.47*
90	2.04	4.20	6.97	9.43
95	2.05*	4.22*	6.99*	9.38*

\* Extrapolated

## 20.7 Merck Titrisole, Riedel-de-Haën Fixanale

Temp (°C)	pH of buffer solutions				
0	2.01	4.05	7.13	9.24	12.58
5	2.01	4.05	7.07	9.16	12.41
10	2.01	4.02	7.05	9.11	12.26
15	2.00	4.01	7.02	9.05	12.10
20	2.00	4.00	7.00	9.00	12.00
25	2.00	4.01	6.98	8.95	11.88
30	2.00	4.01	6.98	8.91	11.72
35	2.00	4.01	6.96	8.88	11.67
40	2.00	4.01	6.95	8.85	11.54
45	2.00	4.01	6.95	8.82	11.44
50	2.00	4.00	6.95	8.79	11.33
55	2.00	4.00	6.95	8.76	11.19
60	2.00	4.00	6.96	8.73	11.04
65	2.00	4.00	6.96	8.72	10.97
70	2.01	4.00	6.96	8.70	10.90
75	2.01	4.00	6.96	8.68	10.80
80	2.01	4.00	6.97	8.66	10.70
85	2.01	4.00	6.98	8.65	10.59
90	2.01	4.00	7.00	8.64	10.48
95	2.01	4.00	7.02	8.64	10.37

## 20.8 WTW buffers

Temp (°C)	pH of buffer solutions			
0	2.03	4.01	7.12	10.65
5	2.02	4.01	7.09	10.52
10	2.01	4.00	7.06	10.39
15	2.00	4.00	7.04	10.26
20	2.00	4.00	7.02	10.13
25	2.00	4.01	7.00	10.00
30	1.99	4.01	6.99	9.87
35	1.99	4.02	6.98	9.74
40	1.98	4.03	6.97	9.61
45	1.98	4.04	6.97	9.48
50	1.98	4.06	6.97	9.35
55	1.98	4.08	6.98	
60	1.98	4.10	6.98	
65	1.99	4.13	6.99	
70	2.00	4.16	7.00	
75	2.00	4.19	7.02	
80	2.00	4.22	7.04	
85	2.00	4.26	7.06	
90	2.00	4.30	7.09	
95	2.00	4.35	7.12	

**Sales and Service:****Australia**

Mettler-Toledo Ltd.  
220 Turner Street  
Port Melbourne  
AUS-3207 Melbourne/VIC  
Phone +61 1300 659 761  
Fax +61 3 9645 3935  
e-mail info.mtaus@mt.com

**Austria**

Mettler-Toledo Ges.m.b.H.  
Südrandstraße 17  
A-1230 Wien  
Phone +43 1 604 19 80  
Fax +43 1 604 28 80  
e-mail infoprocess.mtat@mt.com

**Brazil**

Mettler-Toledo Ind. e Com. Ltda.  
Alameda Araguaia, 451  
Alphaville  
BR-06455-000 Barueri/SP  
Phone +55 11 4166 7444  
Fax +55 11 4166 7401  
e-mail mettler@mettler.com.br  
service@mettler.com.br

**China**

Mettler-Toledo Instruments  
(Shanghai) Co. Ltd.  
589 Gui Ping Road  
Cao He Jing  
CN-200233 Shanghai  
Phone +86 21 64 85 04 35  
Fax +86 21 64 85 33 51  
e-mail mtcs@public.sta.net.cn

**Croatia**

Mettler-Toledo d.o.o.  
Mandlova 3  
HR-10000 Zagreb  
Phone +385 1 292 06 33  
Fax +385 1 295 81 40  
e-mail mt.zagreb@mt.com

**Czech Republic**

Mettler-Toledo s.r.o.  
Trebohosticka 2283/2  
CZ-100 00 Praha 10  
Phone +420 2 72 123 150  
Fax +420 2 72 123 170  
e-mail sales.mt.cz@mt.com

**Denmark**

Mettler-Toledo A/S  
Naverland 8  
DK-2600 Glostrup  
Phone +45 43 27 08 00  
Fax +45 43 27 08 28  
e-mail info.mtdk@mt.com

**France**

Mettler-Toledo  
Analyse Industrielle S.A.S.  
30, Boulevard de Douaumont  
BP 949  
F-75829 Paris Cedex 17  
Phone +33 1 47 37 06 00  
Fax +33 1 47 37 46 26  
e-mail mtpro-f@mt.com

**Germany**

Mettler-Toledo GmbH  
Prozeßanalytik  
Ockerweg 3  
D-35396 Gießen  
Phone +49 641 507 333  
Fax +49 641 507 397  
e-mail prozess@mt.com

**Great Britain**

Mettler-Toledo LTD  
64 Boston Road, Beaumont Leys  
GB-Leicester LE4 1AW  
Phone +44 116 235 7070  
Fax +44 116 236 5500  
e-mail enquire.mtuk@mt.com

**Hungary**

Mettler-Toledo Kereskedelmi KFT  
Teve u. 41  
HU-1139 Budapest  
Phone +36 1 288 40 40  
Fax +36 1 288 40 50  
e-mail mth@axelero.hu

**India**

Mettler-Toledo India Private Limited  
Amar Hill, Saki Vihar Road  
Powai  
IN-400 072 Mumbai  
Phone +91 22 2857 0808  
Fax +91 22 2857 5071  
e-mail sales.mtin@mt.com

**Italy**

Mettler-Toledo S.p.A.  
Via Vialba 42  
I-20026 Novate Milanese  
Phone +39 02 333 321  
Fax +39 02 356 2973  
e-mail customercare.italia@mt.com

**Japan**

Mettler-Toledo K.K.  
Process Division  
6F Ikenohata Nisshoku Bldg.  
2-9-7, Ikenohata  
Taito-ku  
JP-110-0008 Tokyo  
Tel. +81 3 5815 5606  
Fax +81 3 5815 5626  
e-mail helpdesk.ing.jp@mt.com

**Malaysia**

Mettler-Toledo (M) Sdn Bhd  
Bangunan Electrocon Holding, U 1-01  
Lot 8 Jalan Astaka U8/84  
Seksyen U8, Bukit Jelutong  
MY-40150 Shah Alam Selangor  
Phone +60 3 78 44 58 88  
Fax +60 3 78 45 87 73  
e-mail  
MT-MY.CustomerSupport@mt.com

**Mexico**

Mettler-Toledo S.A. de C.V.  
Ejercito Nacional #340  
Col. Chapultepec Morales  
Del. Miguel Hidalgo  
MX-11570 México D.F.  
Tel. +52 55 1946 0900  
e-mail ventas.lab@mt.com

**Poland**

Mettler-Toledo (Poland) Sp.z.o.o.  
ul. Poleczki 21  
PL-02-822 Warszawa  
Phone +48 22 545 06 80  
Fax +48 22 545 06 88  
e-mail polska@mt.com

**Russia**

Mettler-Toledo Vostok ZAO  
Sretenskij Bulvar 6/1  
Office 6  
RU-101000 Moscow  
Phone +7 495 621 56 66  
Fax +7 495 621 63 53  
e-mail inforus@mt.com

**Singapore**

Mettler-Toledo (S) Pte. Ltd.  
Block 28  
Ayer Rajah Crescent #05-01  
SG-139959 Singapore  
Phone +65 6890 00 11  
Fax +65 6890 00 12  
+65 6890 00 13  
e-mail precision@mt.com

**Slovakia**

Mettler-Toledo s.r.o.  
Haffalova 12/A  
SK-831 03 Bratislava  
Phone +421 2 4444 12 20-2  
Fax +421 2 4444 12 23  
e-mail predaj@mt.com

**Slovenia**

Mettler-Toledo d.o.o.  
Pot heroja Trtnika 26  
SI-1261 Ljubljana-Dobrunje  
Phone +386 1 530 80 50  
Fax +386 1 562 17 89  
e-mail keith.racman@mt.com

**South Korea**

Mettler-Toledo (Korea) Ltd.  
Yeil Building 1 & 2 F  
124-5, YangJe-Dong  
SeCho-Ku  
KR-137-130 Seoul  
Phone +82 2 3498 3500  
Fax +82 2 3498 3555  
e-mail Sales\_MTKR@mt.com

**Spain**

Mettler-Toledo S.A.E.  
C/Miguel Hernández, 69-71  
ES-08908 L'Hospitalet de Llobregat  
(Barcelona)  
Phone +34 93 223 76 00  
Fax +34 93 223 76 01  
e-mail bcn.centralita@mt.com

**Sweden**

Mettler-Toledo AB  
Virkesvägen 10  
Box 92161  
SE-12008 Stockholm  
Phone +46 8 702 50 00  
Fax +46 8 642 45 62  
e-mail sales.mts@mt.com

**Switzerland**

Mettler-Toledo (Schweiz) GmbH  
Im Langacher  
Postfach  
CH-8606 Greifensee  
Phone +41 44 944 45 45  
Fax +41 44 944 45 10  
e-mail salesola.ch@mt.com

**Thailand**

Mettler-Toledo (Thailand) Ltd.  
272 Soi Soonvijai 4  
Rama 9 Rd., Bangkok  
Huay Kwang  
TH-10320 Bangkok  
Phone +66 2 723 03 00  
Fax +66 2 719 64 79  
e-mail  
MT-TH.ProcessSupport@mt.com

**USA/Canada**

Mettler-Toledo Ingold, Inc.  
36 Middlesex Turnpike  
Bedford, MA 01730, USA  
Phone +1 781 301 8800  
Freephone +1 800 352 8763  
Fax +1 781 271 0681  
e-mail mtprous@mt.com



Management System  
certified according to  
ISO 9001 / ISO 14001

Subject to technical changes.  
© Mettler-Toledo AG, Process Analytics  
02/10 Printed in Switzerland. 51 121 389

Mettler-Toledo AG, Process Analytics  
Im Hackacker 15, CH-8902 Urdorf, Switzerland  
Tel. +41 44 729 62 11, Fax +41 44 729 66 36

**www.mt.com/pro**