

M420 Cond Ind

Instruction Manual



www.mt.com/pro



75568

METTLER TOLEDO

A graphic element consisting of a series of parallel green lines that form a stylized arrow pointing towards the right, positioned behind the company name.

Warranty

Warranty

Defects occurring within 1 year from delivery date shall be remedied free of charge at our plant (carriage and insurance paid by sender).
Sensors, fittings, and accessories: 1 year.

Subject to change without notice.

Return of Products Under Warranty

Please contact our Service Team before returning a defective device. Ship the cleaned device to the address you have been given. If the device has been in contact with process fluids, it must be decontaminated/disinfected before shipment. In that case, please attach a corresponding certificate, for the health and safety of our service personnel.

Disposal

Please observe the applicable local or national regulations concerning the disposal of “waste electrical and electronic equipment”.



CD-ROM

Complete documentation:

- Instruction manuals
- Safety instructions
- Short instructions



Safety Information

In official EU languages and others.

- FM / CSA
- EC Declarations of Conformity



Short Instructions

In German, English, French, Russian, Spanish, Portuguese, Japanese, Chinese.

Download: www.mt.com/pro

- Installation and commissioning
- Operation
- Menu structure
- Calibration
- Error messages and recommended actions

Specific Test Report

Contents

Documents Supplied	3
Introduction	7
Intended Use	7
Safety Information	8
Overview of M420 Cond Ind	10
Assembly	11
Package Contents	11
Mounting Plan, Dimensions	12
Pipe Mounting, Protective Hood.....	13
Panel Mounting	14
Installation	15
Installation Instructions.....	15
Rating Plates / Terminal Assignments	16
Wiring of M420 Cond Ind.....	17
InPro 7250 ST, InPro 7250 PFA Wiring	18
InPro 7250 HT Wiring.....	19
User Interface, Keypad	20
Display	21
Measuring Mode.....	22
Selecting the Mode / Entering Values	23
Operating Modes.....	24
Menu Structure of Modes and Functions	25
HOLD Mode	26
Alarm	27
Configuration	28
Menu Structure of Configuration.....	28
Parameter Set A/B.....	30
Configuration (Original for Copy)	35
Sensor.....	38
Current Output 1.....	44
Current Output 2.....	50

Temperature Compensation.....	52
Alarm Settings.....	56
Time and Date.....	58
Tag Number	58
Calibration	61
Selecting a Calibration Mode.....	61
Calibration with Calibration Solution.....	62
Calibration by Input of Cell Factor.....	64
Product Calibration	65
Zero Calibration in Air / with Calibration Solution	67
Temp Probe Adjustment	68
Measurement	69
Diagnostics	70
Service	75
Operating States.....	78
Product Line and Accessories	80
M420: Supply Units and Connection.....	81
Specifications	82
Calibration Solutions	88
Concentration Curves.....	91
Error Handling.....	97
Error Messages.....	98
HART: Typical Applications.....	100
Sensoface.....	101
EC Declaration of Conformity	103
M420 XH: Control Drawings.....	105
FM Control Drawing.....	107
CSA Control Drawing	108

Contents

FDA 21 CFR Part 11	109
Electronic Signature – Passcodes.....	109
Audit Trail.....	109
Index	110
Trademarks.....	119
Passcodes	120

Intended Use

M420 Cond Ind is used for measurement of electrical conductivity and temperature in liquids using electrodeless sensors. Fields of application are: biotechnology, chemical industry, environment, food processing, water/waste-water treatment.

The sturdy molded enclosure can be fixed into a control panel or mounted on a wall or at a post. The protective hood, which is available as accessory, provides additional protection against direct weather exposure and mechanical damage.

The device has been designed for application with electrodeless sensors, in particular for sensors of the InPro 7250 Series.

Plain-text messages in a large, backlit display allow intuitive operation. The "Sensocheck" automatic monitoring of sensor and cables and the "Sensoface" function for clear indication of the sensor condition provide excellent diagnostics.

The internal logbook (TAN SW-420-002) can handle up to 100 entries – up to 200 with AuditTrail (TAN SW-420-003).

The device provides two parameter sets which can be switched manually or via a control input for different process adaptations or different process conditions (e.g. beer and CIP).

Password protection for granting access rights during operation can be configured.

Two floating, digital control inputs ("Hold" and "Control") are available for external control.

The device provides two current outputs (for transmission of measured value and temperature, for example).

Approvals for Measurement in Hazardous Locations:

M420 Cond Ind: General Safety.

M420 Cond Ind XH: Approved for operation in hazardous locations according to IECEx / ATEX / FM* / CSA*.

* FM and CSA pending

Safety Information

Safety information –

Be sure to read and observe the following instructions!

The device has been manufactured using state of the art technology and it complies with applicable safety regulations.

When operating the device, certain conditions may nevertheless lead to danger for the operator or damage to the device.

See also separate document:

- “Safety Instructions“.
(EC Declaration of Conformity, FM*, CSA*, ATEX (if applicable) Certificates)



CAUTION!

Commissioning must only be performed by trained personnel authorized by the operating company! Whenever it is likely that protection has been impaired, the device shall be made inoperative and secured against unintended operation.

The protection is likely to be impaired if, for example:

- the device shows visible damage
- the device fails to perform the intended measurements
- after prolonged storage at temperatures above 70°C
- after severe transport stresses

Before recommissioning the device, a professional routine test must be performed. This test must be carried out at the manufacturer's factory.

Please note:

Before commissioning it must be proved that the device may be connected with other equipment.

* FM and CSA pending

Information for Installation in Hazardous Locations (M420 Cond Ind XH)

- Be sure to observe the stipulations of EN 60079-10 / EN 60079-14 or the corresponding local regulations during installation and commissioning. See also separate “Safety Instructions” document.

Approvals for application in hazardous locations (M420 Cond Ind XH)

- according to IECEx in Zone 0, 1, 20, 21
- according to ATEX in Zone 0, 1, 2, 20, 21
- according to cCSAus in Class I Div 1, 2 / Zone 1
- according to FM in Class I, Div 1, 2 / Zone 1

* FM and CSA pending



Important Notice:

The operator must indicate the type of protection!

When the device provides different types of protection, the operator must specify the applied type of protection during installation. To do so, use the checkboxes on the rating plate:

METTLER TOLEDO Cond Ind	KEMA 08 ATEX 0144		IECEx KEM 08.0029
M420 Cond Ind XH OUT2	<input type="checkbox"/> II 2(1) G Ex ib [ia] IIC T4/		<input checked="" type="checkbox"/> Ex ib [ia] IIC T4/
Art. No. 52 121 438	<input type="checkbox"/> II 1 G Ex ia IIC T4		Zone 0 Ex ia IIC T4
No. 12345 / 1234567 / 0832	<input type="checkbox"/> II 1 D Ex iaD 20 IP6x T85°C/		<input type="checkbox"/> Ex iaD 20 IP6x T85°C
-20 ≤ T _a ≤ +65°C	<input type="checkbox"/> II 2 D Ex iaD 21 IP6x T85°C		
	Electrical data see Control drawing 212.002-230		
CH-8906 Nänikon Made in Germany			0344

M420 Cond Ind XH OUT2 rating plate at outside bottom of front with checkboxes for marking the respective application after installation

Terminals:

Screw terminal, suitable for single wires / flexible leads up to 2.5 mm² (AWG 14). Recommended torque for the terminal screws: 0.5 ... 0.6 Nm.

Overview

Overview of M420 Cond Ind

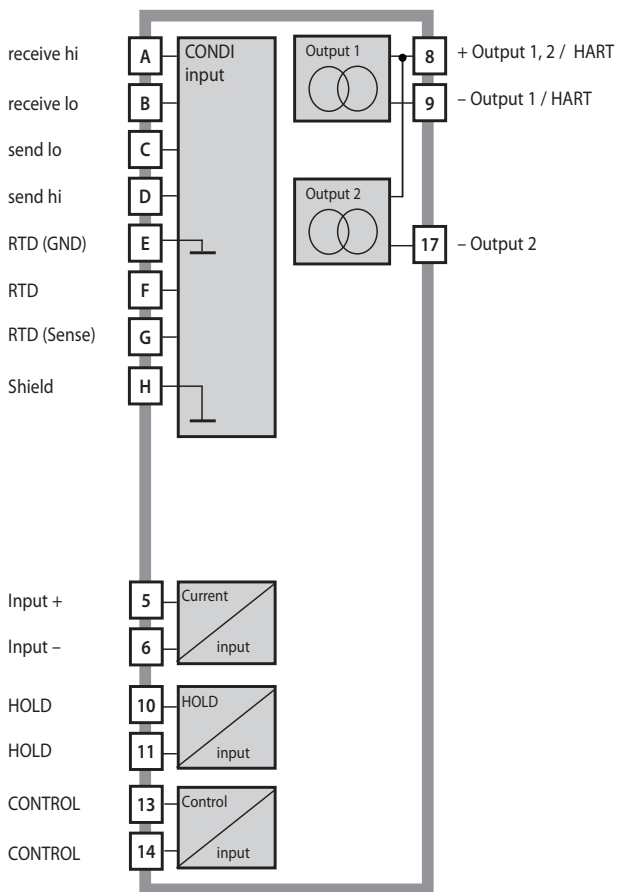

Package Contents

Check the shipment for transport damage and completeness!

The package should contain:

- Front unit, rear unit, bag containing small parts
- Specific test report
- Documentation (cf Pg 3)
- CD-ROM

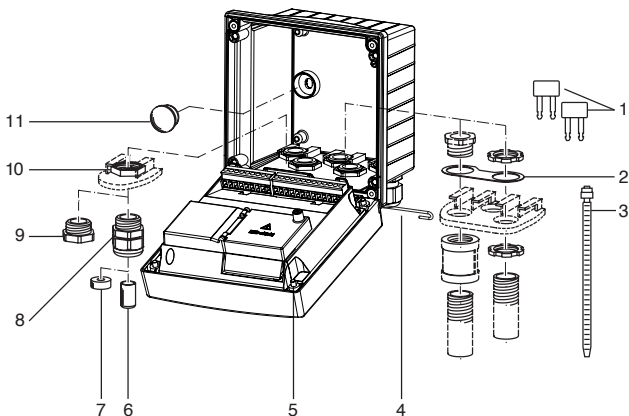

Fig.: Assembling the enclosure

- | | |
|---|--|
| 1) Jumper (3 x) | 6) Sealing insert (1 x) |
| 2) Washer (1 x), for conduit mounting: Place washer between enclosure and nut | 7) Rubber reducer (1 x) |
| 3) Cable tie (3 x) | 8) Cable gland (3 x) |
| 4) Hinge pin (1 x), insertable from either side | 9) Filler plug (3 x) |
| 5) Enclosure screw (4 x) | 10) Hexagon nut (5 x) |
| | 11) Sealing plug (2 x), for sealing in case of wall mounting |

Mounting Plan, Dimensions

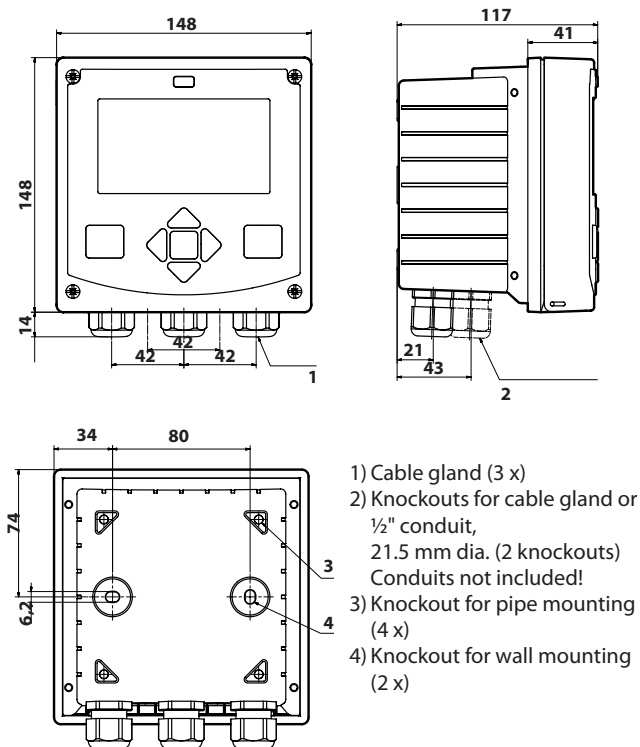
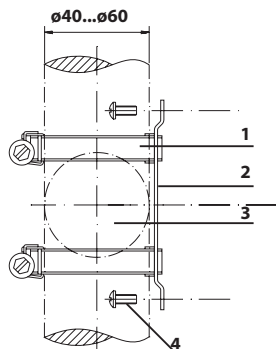

Fig.: Mounting plan (All dimensions in mm!)

Pipe Mounting, Protective Hood



- 1) Hose clamp with worm gear drive to DIN 3017 (2 x)
- 2) Pipe-mount plate (1 x)
- 3) For vertical or horizontal posts or pipes
- 4) Self-tapping screw (4 x)

Fig.: Pipe-mount kit (521202741) – All dimensions in mm!

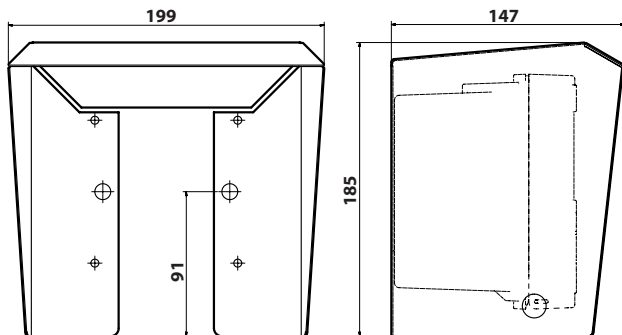

Fig.: Protective hood for wall and pipe mounting (52121470)
– All dimensions in mm!

Panel Mounting

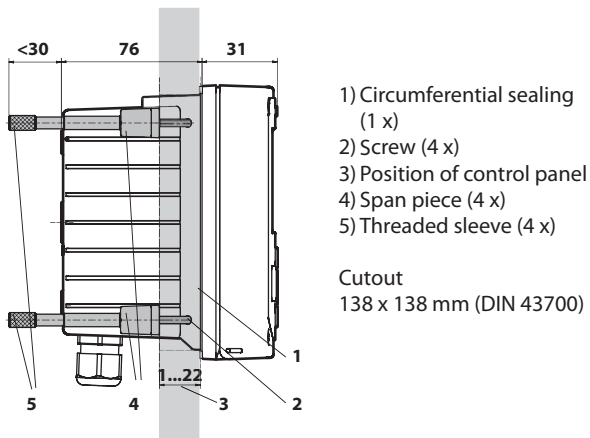

Fig.: Panel-mount kit (52121471) – All dimensions in mm!

Installation Instructions

- Installation of the device must be carried out by trained experts in accordance with this instruction manual and as per applicable local and national codes.
- Be sure to observe the technical specifications and input ratings during installation!
- Be sure not to notch the conductor when stripping the insulation!
- The supplied current must be galvanically isolated. If not, connect an isolator module.
- All parameters must be set by a system administrator prior to commissioning!

Terminals:

suitable for single wires / flexible leads up to 2.5 mm² (AWG 14)



Additional safety precautions have to be taken for applications in hazardous locations according to IECEx, ATEX, FM*, CSA*!
(See also separate "Safety Instructions" document.)

* FM and CSA pending

Rating Plates / Terminal Assignments

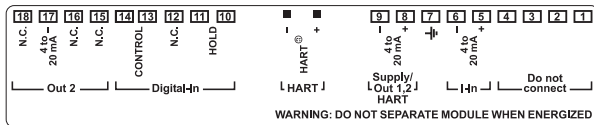

Fig.: Terminal assignments of M420



Fig.: M420 Cond Ind H OUT2 rating plate at outside bottom of front

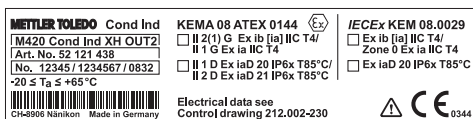

Fig.: M420 Cond Ind XH OUT2 rating plate at outside bottom of front

Important Notice:

The operator must indicate the type of protection!

When the device provides different types of protection, the operator must specify the applied type of protection during installation. To do so, use the checkboxes on the rating plate.

See also "Safety Information" chapter.

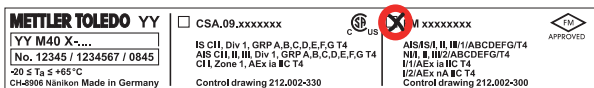
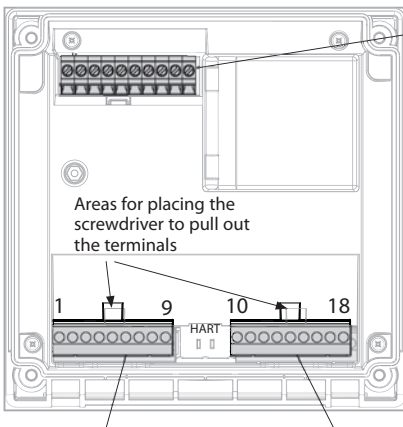

Fig.: Example of additional approval plate (cCSAus, FM)
The specifications refer to the respective device.

Wiring of M420 Cond Ind



Areas for placing the screwdriver to pull out the terminals

Terminal row 1

1	Do not connect
2	Do not connect
3	Do not connect
4	Do not connect
5	+ input
6	- input
7	PA (equipot. bonding)
8	+ out 1,2/HART
9	- out1/HART

Terminal row 2

10	hold
11	hold
12	n.c.
13	contr.
14	contr.
15	n.c.
16	n.c.
17	- out 2
18	n.c.

In addition:

2 HART pins (between terminal row 1 and 2)

Sensor connection Cond Ind input

A	HI RECEIVE
B	LO RECEIVE
C	LO SEND
D	HI SEND
E	RTD (GND)
F	RTD
G	RTD (Sense)
H	Shield

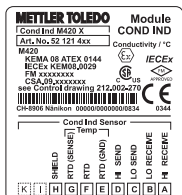
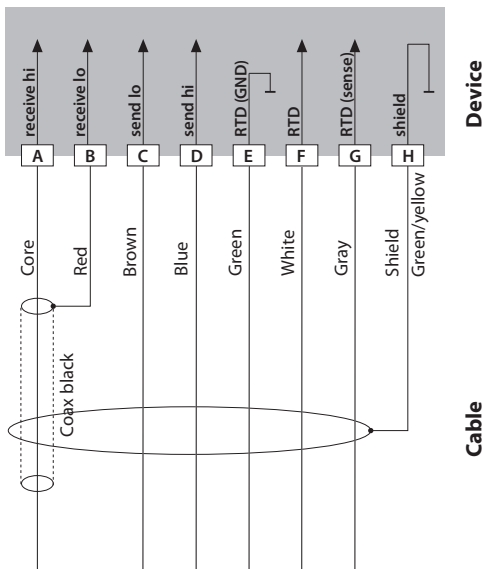

Fig.: Terminal assignments

Fig.: Terminals, device opened, back of front unit

InPro 7250 ST, InPro 7250 PFA Wiring

Measuring task: Conductivity, temperature
Sensors: InPro 720 ST, InPro 720 PFA



InPro 7250 HT Wiring

Measuring task: Conductivity, temperature

Sensors: InPro 7250 HT

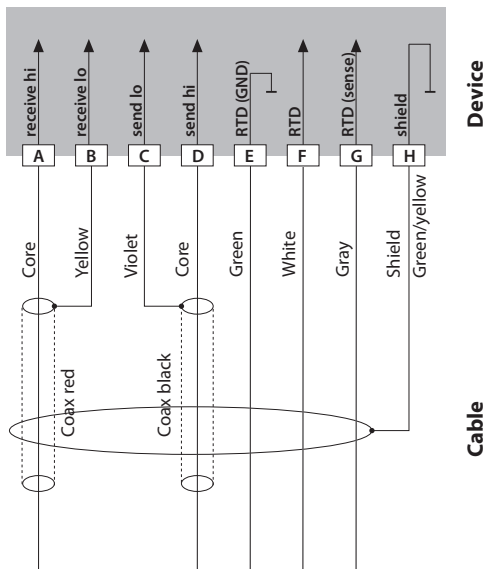

User Interface, Keypad

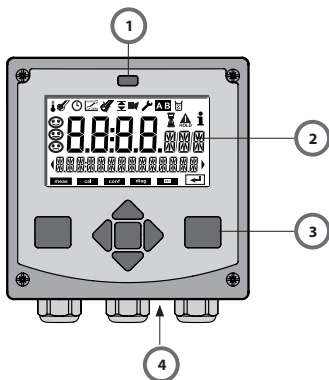

- 1 IrDA transmitter/receiver
- 2 Display
- 3 Keypad
- 4 Rating plate (bottom)

Key	Function
meas	<ul style="list-style-type: none">• Return to last menu level• Directly to measuring mode (press > 2 s)
info	<ul style="list-style-type: none">• Retrieve information• Show error messages
enter	<ul style="list-style-type: none">• Configuration: Confirm entries, next configuration step• Calibration: Continue program flow• Measuring mode: Display output current
Arrow keys up / down	<ul style="list-style-type: none">• Measuring mode: Call menu• Menu: Increase/decrease a numeral• Menu: Select
Arrow keys left / right	<ul style="list-style-type: none">• Measuring mode: Call menu• Menu: Previous/next menu group• Number entry: Move between digits

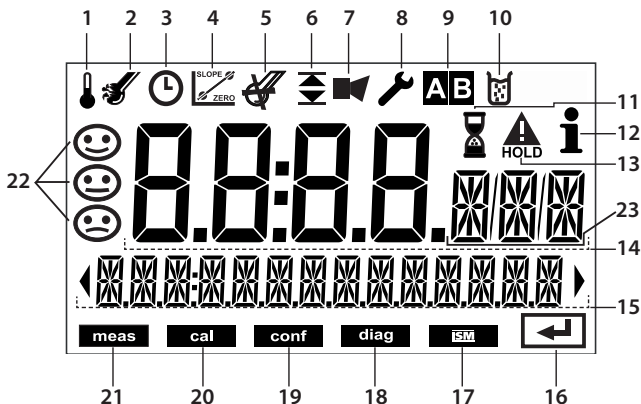

- | | |
|--------------------------|-----------------------|
| 1 Temperature | 13 HOLD mode active |
| 2 Sensocheck | 14 Main display |
| 3 Interval/response time | 15 Secondary display |
| 4 Sensor data | 16 Proceed with enter |
| 5 Not used | 17 Not used |
| 6 Limit values | 18 Diagnostics |
| 7 Alarm | 19 Configuration mode |
| 8 Service | 20 Calibration mode |
| 9 Parameter sets A/B | 21 Measuring mode |
| 10 Calibration | 22 Sensoface |
| 11 Waiting time running | 23 Measurement symbol |
| 12 Info available | |

Measuring Mode

After the operating voltage has been connected and the sensor identified, the device automatically goes to "Measuring" mode. To call the measuring mode from another operating mode (e.g. Diagnostics, Service): Hold **meas** key depressed (> 2 s).

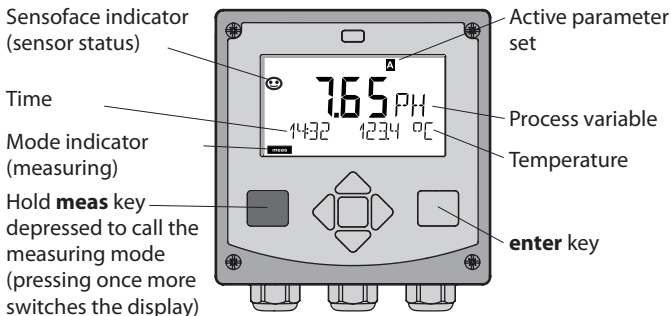

In measuring mode the display indicates:

- Measured value and time (24/12 h AM/PM) as well as temperature in °C or °F (formats selected during configuration)

By pressing the **meas** key in measuring mode you can view the following displays (for approx. 60 sec):

- Measured value and selection of parameter set A/B (if set to "Manual")
- Measured value and tag (point of measurement designation – entered during configuration)
- Time and date

Pressing the **enter** key shows the output currents. They are displayed as long as **enter** is held depressed, then the measured-value display will return after 3 sec.



The device must be configured for the respective measurement task!

Selecting the Mode / Entering Values

To select the operating mode:

- 1) Hold **meas** key depressed (> 2 s) (directly to measuring mode)
- 2) Press any arrow key: the selection menu appears
- 3) Select operating mode using left / right arrow key
- 4) Press **enter** to confirm the selected mode

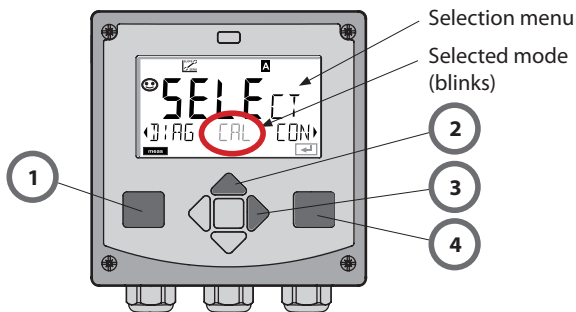

To enter a value:

- 5) Select numeral: left / right arrow key
- 6) Change numeral: up / down arrow key
- 7) Confirm entry by pressing **enter**

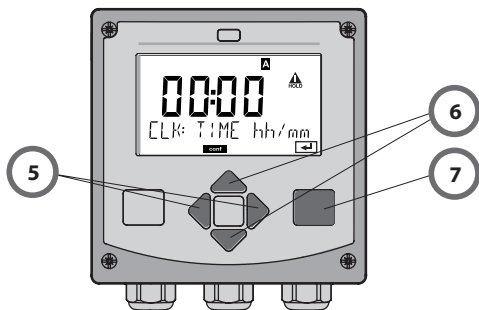

Operating Modes

Diagnostics

Display of calibration data, display of sensor data, performing a device self-test, viewing the logbook entries, display of hardware/software versions of the individual components. The logbook can store 100 events (00...99). They can be displayed directly on the device.

The logbook can be extended to 200 entries using a TAN (Option).

HOLD

Manual activation of HOLD mode, e.g. for servicing. The signal outputs adopt a defined state.

Calibration

Every sensor has typical characteristic values. Calibration is required to supply a correct measured value. The device checks which value the sensor delivers when measuring in a known solution. When there is a deviation, the device can be "adjusted". In that case, the device displays the "actual" value and internally corrects the measurement error of the sensor. During calibration the device is in HOLD mode.

During calibration the analyzer remains in the HOLD mode until it is stopped by the operator.

Configuration

The analyzer must be configured for the respective measurement task. In the "Configuration" mode you select the connected sensor, the measuring range to be transmitted, and the conditions for warning and alarm messages. During configuration the device is in HOLD mode.

Configuration mode is automatically exited 20 minutes after the last keystroke. The device returns to measuring mode.

Service

Maintenance functions (current source), IrDA operation, passcode assignment, reset to factory settings, enabling of options (TAN).

Menu Structure of Modes and Functions



Pressing any arrow key opens the selection menu.
 Select the menu group using the left/right arrow keys.
 Press **enter** to open a menu. Press **meas** to return.

<div style="text-align: center;"> </div>															
DIAG	<table border="1"> <tbody> <tr><td>CALDATA</td><td>Display of calibration data</td></tr> <tr><td>SENSOR</td><td>Display of sensor data</td></tr> <tr><td>SELFTEST</td><td>Self test: RAM, ROM, EEPROM, module</td></tr> <tr><td>LOGBOOK</td><td>100 events with date and time</td></tr> <tr><td>MONITOR</td><td>Display of direct, uncorrected sensor signals</td></tr> <tr><td>VERSION</td><td>Display of software version, model designation, serial number</td></tr> </tbody> </table>	CALDATA	Display of calibration data	SENSOR	Display of sensor data	SELFTEST	Self test: RAM, ROM, EEPROM, module	LOGBOOK	100 events with date and time	MONITOR	Display of direct, uncorrected sensor signals	VERSION	Display of software version, model designation, serial number		
CALDATA	Display of calibration data														
SENSOR	Display of sensor data														
SELFTEST	Self test: RAM, ROM, EEPROM, module														
LOGBOOK	100 events with date and time														
MONITOR	Display of direct, uncorrected sensor signals														
VERSION	Display of software version, model designation, serial number														
HOLD	Manual activation of HOLD mode, e.g. for sensor replacement. The signal outputs behave as configured (e.g. last measured value, 21 mA)														
CAL	<table border="1"> <tbody> <tr><td>CAL_SOL</td><td>Calibration with calibration solution</td></tr> <tr><td>CAL_CELL</td><td>Calibration by entry of cell factor</td></tr> <tr><td>CAL_ZERO</td><td>Zero calibration</td></tr> <tr><td>P_CAL</td><td>Product calibration</td></tr> <tr><td>CAL_RTD</td><td>Adjustment of temperature probe</td></tr> </tbody> </table>	CAL_SOL	Calibration with calibration solution	CAL_CELL	Calibration by entry of cell factor	CAL_ZERO	Zero calibration	P_CAL	Product calibration	CAL_RTD	Adjustment of temperature probe				
CAL_SOL	Calibration with calibration solution														
CAL_CELL	Calibration by entry of cell factor														
CAL_ZERO	Zero calibration														
P_CAL	Product calibration														
CAL_RTD	Adjustment of temperature probe														
CONF	<table border="1"> <tbody> <tr><td>PARSET A</td><td>Configuring parameter set A</td></tr> <tr><td>PARSET B</td><td>Configuring parameter set B</td></tr> </tbody> </table>	PARSET A	Configuring parameter set A	PARSET B	Configuring parameter set B										
PARSET A	Configuring parameter set A														
PARSET B	Configuring parameter set B														
SERVICE (Access via code, factory setting: 5555)	<table border="1"> <tbody> <tr><td>MONITOR</td><td>Display of measured values for validation (simulators)</td></tr> <tr><td>OUT1</td><td>Current source, output 1</td></tr> <tr><td>OUT2</td><td>Current source, output 2</td></tr> <tr><td>IRDA</td><td>Activating the IrDA interface</td></tr> <tr><td>CODES</td><td>Specifying access codes for operating modes</td></tr> <tr><td>DEFAULT</td><td>Reset to factory setting</td></tr> <tr><td>OPTION</td><td>Enabling an option via TAN</td></tr> </tbody> </table>	MONITOR	Display of measured values for validation (simulators)	OUT1	Current source, output 1	OUT2	Current source, output 2	IRDA	Activating the IrDA interface	CODES	Specifying access codes for operating modes	DEFAULT	Reset to factory setting	OPTION	Enabling an option via TAN
MONITOR	Display of measured values for validation (simulators)														
OUT1	Current source, output 1														
OUT2	Current source, output 2														
IRDA	Activating the IrDA interface														
CODES	Specifying access codes for operating modes														
DEFAULT	Reset to factory setting														
OPTION	Enabling an option via TAN														

HOLD Mode

The HOLD mode is a safety state during configuration and calibration. Output current is frozen (Last) or set to a fixed value (Fix). The HOLD mode is indicated by orange display backlighting.

HOLD mode, display icon:



Output Signal Response

- **Last:** The output current is frozen at its last value. Recommended for short configuration procedures. The process should not change decisively during configuration. Changes are not noticed with this setting!
- **Fix:** The output current is set to a value that is noticeably different from the process value to signal the control system that the device is being worked at.

Output Signal During HOLD:

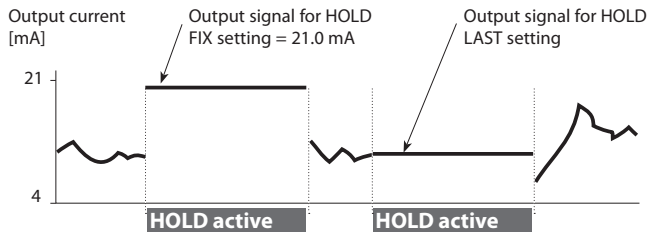

Terminating the HOLD Mode

The HOLD mode is ended by switching to measuring mode (hold **meas** key depressed). The display reads “Good Bye”, after that, the HOLD mode is exited.

When the calibration mode is exited, a confirmation prompt ensures that the installation is ready for operation (e.g.: sensor reinstalled, located in process).

External Activation of HOLD

The HOLD mode can be activated from outside by sending a signal to the Hold input (e.g. from the process control system).

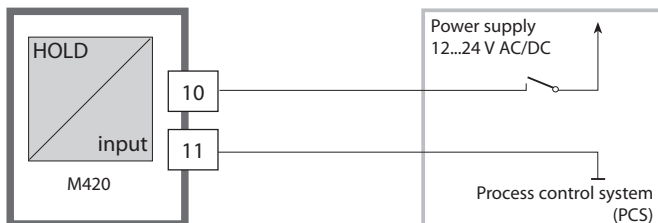

HOLD inactive	0...2 V AC/DC
HOLD active	10...30 V AC/DC

Manual Activation of HOLD

The HOLD can be activated manually from the HOLD menu. This allows checking or replacing a sensor, for example, without provoking unintended reactions of outputs or contacts. Press **meas** key to return to selection menu.

Alarm

When an error has occurred, **Err xx** is displayed immediately. Only after expiry of a user-defined delay time will the alarm be registered and entered in the logbook. During an alarm the display blinks.

Error messages can also be signaled by a 22 mA output current (see Configuration). 2 sec after the failure event is corrected, the alarm status will be deleted.

Configuration

Menu Structure of Configuration

The device provides 2 parameter sets "A" and "B". By switching between the parameter sets you can adapt the device to different measurement situations, for example.

Parameter set "B" only permits setting of process-related parameters. The configuration steps are assigned to different menu groups.

Using ◀ and ▶, you can jump between the individual menu groups. Each menu group contains menu items for setting the parameters.

Pressing **enter** opens a menu item.

The values are edited using ▲ and ▼.

Pressing **enter** confirms/stores the settings.

Return to measurement: Press **meas**.

Select menu group	Menu group	Code	Display	Select menu item
	Sensor selection	SNS:		 enter enter enter enter
		Menu item 1		
		⋮		
		Menu item ...		
▶	Current output 1	OT1:		
▶	Current output 2	OT2:		
▶	Compensation	COR:		
▶	Alarm mode	ALA:		◀
▶	Setting the clock	CLK:		◀
▶	Tag number	TAG:		◀

Parameter Set A/B: Configurable Menu Groups



(Some parameters are identical in A and B. They are configured in parameter set A only.)

Menu group	Parameter set A	Parameter set B
SENSOR	Sensor selection	---
OUT1	Current output 1	Current output 1
OUT2	Current output 2	Current output 2
CORRECTION	Compensation	Compensation
ALARM	Alarm mode	Alarm mode
PARSET	Parameter set selection	---
CLOCK	Setting the clock	---
TAG	Tag number	---

Configuration

Parameter Set A/B

Manual selection

Display	Action	Remark
	To switch between parameter sets: Press meas	Manual selection of parameter sets must have been preset in CONFIG mode. Default setting is a fixed parameter set A. Wrong settings change the measurement properties!
	PARSET blinks in the lower line. Select parameter set using ◀ and ▶ keys	
	Select PARSET A / PARSET B	
	Confirm by pressing enter Cancel by pressing meas	

Configuration		Choices	Default
SENSOR			
SNS:		InPro 7250 ST InPro 7250 PFA InPro 7250 HT OTHER	InPro 7250 ST
OTHER	RTD TYPE	1000 PT 100 PT 30 NTC	1000 PT
	CELL FACTOR	XX.XXx	01.980
	TRANS RATIO	XXX.Xx	120.00
MEAS MODE		Cond Conc % Sal ‰	COND
Cond	MEAS RANGE ¹⁾	x.xxx mS/cm xx.xx mS/cm xxx.x mS/cm xxxx mS/m x.xxx S/m xx.xx S/m	xxx.x mS/cm
Conc	Solution	-01- (NaCl) -02- (HCl) -03- (NaOH) -04- (H ₂ SO ₄) -05- (HNO ₃) -06- (H ₂ SO ₄) -07- (HCl) -08- (HNO ₃) -09- (H ₂ SO ₄) -10- (NaOH)	-01- (NaCl)
TEMP UNIT		°C / °F	°C
TEMPERATURE		AUTO MAN EXT (only if enabled via TAN)	AUTO
MAN	TEMPERATURE	-50...200 °C (-58...392 °F)	025.0 °C (077.0 °F)

Configuration

Configuration		Choices	Default	
SENSOR				
SNS:	CIP COUNT	ON / OFF	OFF	
	SIP COUNT	ON / OFF	OFF	
Output 1 (OUT1)				
OT1:	CHANNEL		COND/TMP	COND
	OUTPUT (with Cond only)		LIN / LOG	LIN
	LIN ¹⁾	BEGIN 4mA	xxxx	000.0 mS/cm
		END 20 mA	xxxx	100.0 mS/cm
	LOG	BEGIN 4mA	Decades	
		END 20 mA	Decades	
	TMP °C	BEGIN 4mA	-50...200 °C	
		END 20 mA	-50...200 °C	
	TMP °F	BEGIN 4mA	-58...392 °F	
		END 20 mA	-58...392 °F	
	FILTERTIME		0...120 SEC	0000 SEC
	22mA-FAIL		ON/OFF	OFF
	HOLD MODE		LAST/FIX	LAST
	FIX	HOLD-FIX	4...22 mA	021.0 mA

- 1) The range selection allows selecting the maximum resolution. If the upper limit of this range is exceeded, the device automatically switches to the next higher range.

Configuration		Choices	Default	
Output 2 (OUT2)				
OT2:	CHANNEL	COND/TMP	TMP Begin: 0 °C End: 100 °C	
	... other steps like output 1			
Temperature compensation (CORRECTION)				
COR:	TC SELECT	OFF LIN NLF	OFF	
	LIN	TC LIQUID	00.00...19.99%/K	
	I-INPUT		0...20 mA/4...20 mA	4...20 mA
	°C	BEGIN 4 mA	-50...200 °C	000.0 °C
		END 20 mA	-50...200 °C	100.0 °C
	°F	BEGIN 4 mA	-58...392 °F	
END 20 mA		-58...392 °F		
Alarm (ALARM)				
ALA:	DELAYTIME	0...600 SEC	0010 SEC	
	SENSOCHECK	ON/OFF	OFF	

Configuration

Configuration		Choices	Default
Parameter set (PARSET)			
PAR	Select fixed parameter set (A) or switch between A/B via control input or manually in measuring mode	PARSET FIX / CNTR INPUT / MANUAL	PARSET FIX (fixed parameter set A)
Real-time clock (CLOCK)			
CLK:	FORMAT	24 h / 12 h	
	24 h	TIME hh/mm	00..23:00...59
	12 h	TIME hh/mm	00...11:00...59 AM/PM:
	DAY/MONTH		01...31/01...12
	YEAR		2000...2099
Tag number (TAG)			
TAG:	(Input in text line)		—

Configuration (Original for Copy)

Default Settings of Parameter Sets

Two complete parameter sets are stored in the EEPROM.
As delivered, the two sets are identical but can be edited.

Please note:

Fill in your configuration data on the following pages or use them as original for copy.

Configuration (Original for Copy)

Parameter	Parameter set A	Parameter set B
SNS: Sensor type		--- *)
Only with "Sensor type Others":		
SNS: Type of temp probe		---
SNS: Cell factor		---
SNS: Transfer ratio		---
SNS: Measuring mode		---
SNS: Measuring range		---
SNS: Concentration determination		---
SNS: Temperature unit		---
SNS: Temp detection		---
SNS: Manual temp		---
SNS: CIP counter		---
SNS: SIP counter		---
OT1: Process variable		
OT1: LIN/LOG output		
OT1: Current start		
OT1: Current end		
OT1: Filter time		
OT1: 22 mA error current		
OT1: HOLD mode		
OT1: HOLD-FIX current		

*) These parameters cannot be adjusted in parameter set B, the values are the same as in parameter set A.

(Original for Copy) Configuration

Parameter	Parameter set A	Parameter set B
OT2: Process variable		
OT2: LIN/LOG output		
OT2: Current start		
OT2: Current end		
OT2: Filter time		
OT2: 22 mA error current		
OT2: HOLD mode		
OT2: HOLD-FIX current		
COR: TC SELECT		
COR: Temp coefficient		
COR: Current range		
COR: Current start		
COR: Current end		
ALA: Delay		
ALA: Sensocheck on/off		
CLK: Time & Date		---*)
TAG: Tag number		---*)

*) These parameters cannot be adjusted in parameter set B, the values are the same as in parameter set A.

Configuration

Sensor

Selecting the parameters



enter



enter

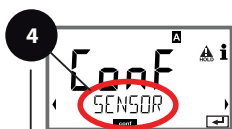

enter

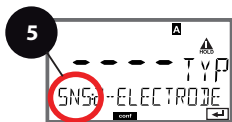



meas



- 1 Press any arrow key.
- 2 Select **CONF** using ◀ ▶ keys, press **enter**.
- 3 Select parameter set using ◀ ▶ keys, press **enter**.
- 4 Select **SENSOR** menu using ◀ ▶ keys, press **enter**.
- 5 All items of this menu group are indicated by the "SNS:" code. Press **enter** to select menu, edit using arrow keys (see next page). Confirm (and proceed) by pressing **enter**.
- 6 End: Press **meas** key until the [meas] mode indicator is displayed.

5

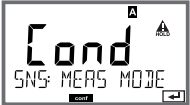
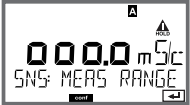
Select sensor type	enter
(With "OTHER": Sensor parameters)	enter
Select measuring mode	enter
Select range	
Concentration determination	
Temperature unit	
Temperature detection	
Cleaning cycles	
Sterilization cycles	

Menu item	Action	Choices
Select sensor type	Select sensor type using ▲ ▼ keys. Press enter to confirm.	InPro 7250 ST InPro 7250 PFA InPro 7250 HT OTHER
Only with "OTHER": Input of type of temperature probe, cell factor, transfer ratio	Modify digit using ▲ ▼ keys, select next digit using ◀ ▶ keys. Press enter to confirm.	
Select measuring mode	Select desired measuring mode using ▲ ▼ keys. Press enter to confirm.	Cond Conc % Sal %
	For cond measurement only Select desired range using ▲ ▼ keys. Press enter to confirm.	x.xxx mS/cm, xx.xx mS/cm xxx.x mS/cm xxxx mS/cm, x.xxx S/m xx.xx S/m
Select range 	For conc measurement only Select desired concentration solution using ▲ ▼ (see appendix for ranges). Press enter to confirm.	-01- (NaCl) -02- (HCl) -03- (NaOH) -04- (H2SO4) -05- (HNO3) -06- (H2SO4) -07- (HCl) -08- (HNO3) -09- (H2SO4) -10- (NaOH)
Concentration determination 		

Configuration

Sensor

Select: Temperature unit, temperature detection, type of temp probe



enter



enter

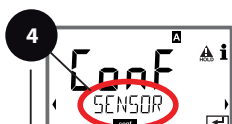

enter

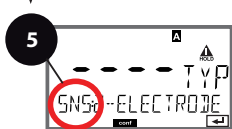

meas



- 1 Press any arrow key.
- 2 Select **CONF** using ◀ ▶ keys, press **enter**.
- 3 Select parameter set using ◀ ▶ keys, press **enter**.
- 4 Select **SENSOR** menu using ◀ ▶ keys, press **enter**.



All items of this menu group are indicated by the "SNS:" code.

Press **enter** to select menu, edit using arrow keys (see next page). Confirm (and proceed) by pressing **enter**.

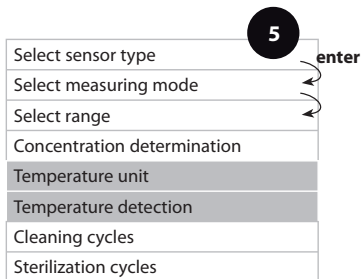
- 5 End: Press **meas** key until the [meas] mode indicator is displayed.

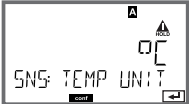

enter

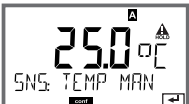
Menu item	Action	Choices
Temperature unit 	Select °C or °F using ▲ ▼ keys. Press enter to confirm.	°C / °F
Temp detection 	Select mode using ▲ ▼ keys: AUTO: Measured by sensor MAN: Direct input of temperature, no measurement (see next step) EXT: Temperature specified via current input (only if TAN E enabled) Press enter to confirm.	AUTO MAN EXT
(Manual temp) 	Modify digit using ▲ ▼ keys, select next digit using ◀ ▶ keys. Press enter to confirm.	-50...200 °C (-58...+392 °F)

Configuration

Sensor

Adjust: Cleaning cycles, sterilization cycles



enter



enter

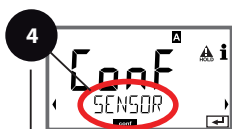

enter

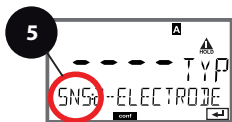

meas



- 1 Press any arrow key.
- 2 Select **CONF** using ◀ ▶ keys, press **enter**.
- 3 Select parameter set using ◀ ▶ keys, press **enter**.
- 4 Select **SENSOR** menu using ◀ ▶ keys, press **enter**.



All items of this menu group are indicated by the "SNS:" code.

Press **enter** to select menu, edit using arrow keys (see next page). Confirm (and proceed) by pressing **enter**.

- 5 End: Press **meas** key until the [meas] mode indicator is displayed.

5

Select sensor type	enter
Select measuring mode	
Select range	
Concentration determination	
Temperature unit	
Temperature detection	
Cleaning cycles	
Sterilization cycles	

Menu item	Action	Choices
CIP / SIP		
Cleaning cycles On / Off 	Select ON or OFF using ▲ ▼ keys. Activates/deactivates log- ging in extended logbook Press enter to confirm.	ON/OFF
Sterilization cycles On / Off 	Select ON or OFF using ▲ ▼ keys. Activates/deactivates log- ging in extended logbook Press enter to confirm.	ON/OFF

Configuration

Current Output 1

Process variable, current start, current end

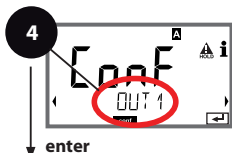

- 1 Press any arrow key.
- 2 Select **CONF** using ◀ ▶ keys, press **enter**.
- 3 Select parameter set using ◀ ▶, press **enter**.
- 4 Select **OUT1** menu using ◀ ▶ keys, press **enter**.





All items of this menu group are indicated by the "OT1:" code.

Press **enter** to select menu, edit using arrow keys (see next page). Confirm (and proceed) by pressing **enter**.

- 5 End: Press **meas** key until the [meas] mode indicator is displayed.

5

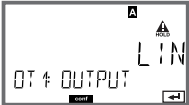
Process variable	enter
LIN/LOG output	enter
Current start	enter
Current end	
Time averaging filter	
Output current during error message	
Output current during HOLD	
Output current for HOLD FIX	

Menu item	Action	Remark
Process variable 	Select using \uparrow \downarrow keys: Cond: Conductivity TMP: Temperature Press enter to confirm.	Cond/TMP 
Select LIN/LOG: 	Select using \uparrow \downarrow keys: LIN: Linear characteristic LOG: Logarithmic – See right column for selectable decades. Press enter to confirm.	Selectable decades with logarithmic setting (LOG): S/cm: 1.0 μ S/cm, 10.0 μ S/cm, 100.0 μ S/cm, 1.0 mS/cm, 10.0 mS/cm, 100.0 mS/cm, 1000 mS/cm S/m: 0.001 S/m, 0.01 S/m, 0.1 S/m, 1.0 S/m, 10.0 S/m, 100 S/m
Current start 	Modify digit using \uparrow \downarrow keys, select next digit using \leftarrow \rightarrow keys. Press enter to confirm.	As selected for process variable/range If the adjusted range is exceeded, the device automatically switches to the next higher range (Autorange)
Current end 	Enter value using \uparrow \downarrow \leftarrow \rightarrow keys. Press enter to confirm.	As selected for process variable/range If the adjusted range is exceeded, the device automatically switches to the next higher range (Autorange)

Assignment of measured values: Current start and current end

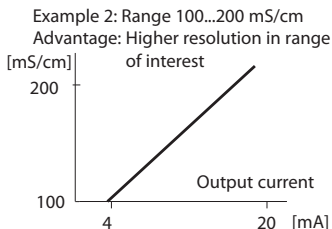
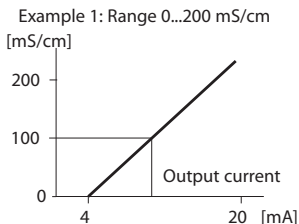

Configuration

Current Output 1

Adjust time interval of output filter



enter



enter

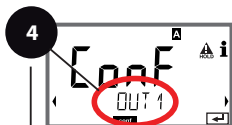

enter



meas



- 1 Press any arrow key.
- 2 Select **CONF** using ◀ ▶ keys, press **enter**.
- 3 Select parameter set using ◀ ▶ keys, press **enter**.
- 4 Select **OUT1** menu using ◀ ▶ keys, press **enter**.

All items of this menu group are indicated by the "OT1:" code.

Press **enter** to select menu, edit using arrow keys (see next page). Confirm (and proceed) by pressing **enter**.

- 5 End: Press **meas** key until the [meas] mode indicator is displayed.

5

Process variable	enter
LIN/LOG output	enter
Current start	enter
Current end	
Time averaging filter	
Output current during error message	
Output current during HOLD	
Output current for HOLD FIX	

Menu item	Action	Choices
Time averaging filter 	Enter value using ▲ ▼ ◀ ▶ keys. Press enter to confirm.	0...120 SEC (0000 SEC)

Time Averaging Filter (Attenuation)

To smoothen the current output, a low-pass filter with adjustable filter time constant can be switched on. When there is a jump at the input (100 %), the output level is at 63 % after the time interval has been reached.

The time interval can be set from 0 to 120 sec.

If the time interval is set to 0 sec, the current output directly follows the input.

Please note:

The filter only acts on the current output, not on the display!

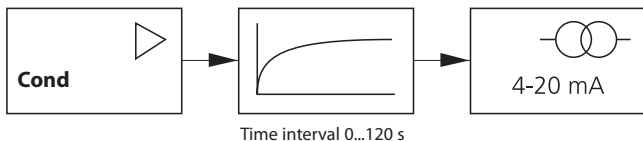

Configuration

Current Output 1

Output current during Error and HOLD.



enter



enter



enter



meas



- 1 Press any arrow key.
- 2 Select **CONF** using ◀ ▶ keys, press **enter**.
- 3 Select parameter set using ◀ ▶ keys, press **enter**.
- 4 Select **OUT1** menu using ◀ ▶ keys, press **enter**.



All items of this menu group are indicated by the "OT1:" code.

Press **enter** to select menu, edit using arrow keys (see next page). Confirm (and proceed) by pressing **enter**.

- 5 End: Press **meas** key until the [meas] mode indicator is displayed.

5

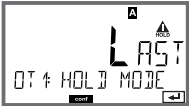
Process variable	enter
LIN/LOG output	enter
Current start	enter
Current end	
Time averaging filter	
Output current during error message	
Output current during HOLD	
Output current for HOLD FIX	

Menu item	Action	Choices
Output current during error message	Select ON or OFF using \blacktriangle \blacktriangledown keys. Press enter to confirm.	ON/OFF
		
Output current during HOLD	LAST: During HOLD the last measured value is maintained at the output. FIX: During HOLD a value (to be entered) is maintained at the output. Select using \blacktriangle \blacktriangledown Press enter to confirm.	LAST/FIX
		
Output current for HOLD FIX	Only with FIX selected: Enter current which is to flow at the output during HOLD Enter value using \blacktriangle \blacktriangledown \blacktriangleleft \blacktriangleright keys. Press enter to confirm.	04.00...22.00 mA (21.00 mA)
		

Output Signal During HOLD:

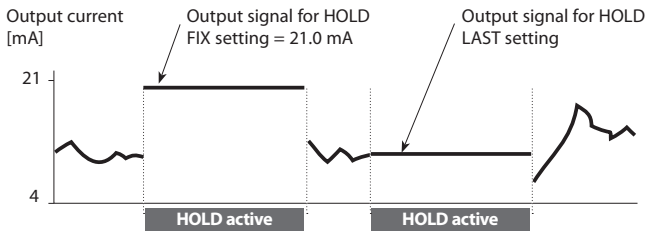

Configuration

Current Output 2

Output current range, process variable



enter



enter



enter



meas



meas

- 1 Press any arrow key.
- 2 Select **CONF** using ◀ ▶ keys, press **enter**.
- 3 Select parameter set using ◀ ▶ keys, press **enter**.
- 4 Select **OUT2** menu using ◀ ▶ keys, press **enter**.

All items of this menu group are indicated by the "OT2:" code.

Press **enter** to select menu, edit using arrow keys (see next page). Confirm (and proceed) by pressing **enter**.

- 5 End: Press **meas** key until the [meas] mode indicator is displayed.

5

Current range	enter
Process variable	enter
LIN/LOG output	
Current start	
Current end	
Time averaging filter	
Output current during error message	
Output current during HOLD	
Output current for HOLD FIX	

Menu item	Action	Choices
Process variable 	Select using ▲ ▼ keys: Cond: Conductivity TMP: Temperature Press enter to confirm.	Cond/TMP Begin: 0 °C End: 100°C
. . .		

All the following adjustments are made as for current output 1 (see there)!

Temperature Compensation Selecting the compensation method



enter



enter



enter





meas



- 1 Press any arrow key.
 - 2 Select **CONF** using ◀ ▶ keys, press **enter**.
 - 3 Select parameter set using ◀ ▶ keys, press **enter**.
 - 4 Select **CORRECTION** menu using ◀ ▶ keys, press **enter**.
- All items of this menu group are indicated by the "COR:" code.
Press **enter** to select menu, edit using arrow keys (see next page). Confirm (and proceed) by pressing **enter**.
- 5 End: Press **meas** key until the [meas] mode indicator is displayed.

5

Temperature compensation	enter
Temperature compensation, process medium	↶
Current input for external temperature measurement	↶
Current start	
Current end	

Menu item	Action	Choices
Temperature compensation	Select desired compensation using ▲ ▼ keys:	
	OFF: Temperature compensation switched off	
	LIN: Linear temperature compensation with entry of temperature coefficient	
	nLF: Temperature compensation for natural waters to EN 27888	

Temperature Compensation

TC process medium, current input for temp measurement







- 1 Press any arrow key.
- 2 Select **CONF** using ◀ ▶ keys, press **enter**.
- 3 Select parameter set using ◀ ▶ keys, press **enter**.
- 4 Select **CORRECTION** menu using ◀ ▶ keys, press **enter**.

All items of this menu group are indicated by the "COR:" code.

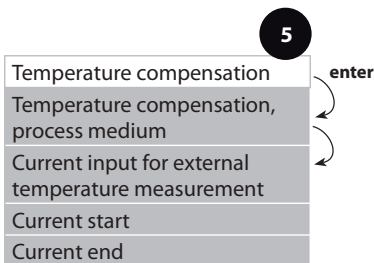
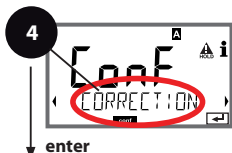
Press **enter** to select menu, edit using arrow keys (see next page). Confirm (and proceed) by pressing **enter**.

- 5 End: Press **meas** key until the [meas] mode indicator is displayed.



Menu item	Action	Choices
Temp compensation, process medium	With linear compensation only: Enter temperature compensation of the process medium. Enter value using \blacktriangle \blacktriangledown \blacktriangleleft \blacktriangleright keys. Press enter to confirm.	0...19.99 %/K
		
Current range	Select desired range using \blacktriangle \blacktriangledown keys. Press enter to confirm.	4-20 mA / 0-20 mA
		
Current start	Modify digit using \blacktriangle \blacktriangledown , select next digit using \blacktriangleleft \blacktriangleright keys. Press enter to confirm.	Input range: -50...200 °C / -58...392 °F
		
Current end	Enter value using \blacktriangle \blacktriangledown \blacktriangleleft \blacktriangleright keys. Press enter to confirm.	Input range: -50...200 °C / -58...392 °F
		

Configuration

Alarm Settings

Delay, Sensocheck

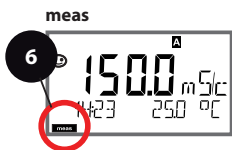
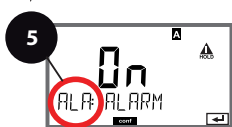



- 1 Press any arrow key.
- 2 Select **CONF** using ◀ ▶ keys, press **enter**.
- 3 Select parameter set using ◀ ▶ keys, press **enter**.
- 4 Select **ALARM** menu using ◀ ▶ keys, press **enter**.

All items of this menu group are indicated by the "ALA:" code.

Press **enter** to select menu, edit using arrow keys (see next page). Confirm (and proceed) by pressing **enter**.

- 5 End: Press **meas** key until the [meas] mode indicator is displayed.



Menu item	Action	Choices
Delay 	Enter value using ▲ ▼ ◀ ▶ keys. Press enter to confirm.	0...600 SEC (010 SEC)
Sensocheck 	Select Sensocheck (continuous monitoring of sensor). Select ON or OFF using ▲ ▼ keys. Press enter to confirm.	ON/OFF

Error messages can be signaled by a 22 mA output current (see Error Messages and Configuration of Output 1/Output 2).
The alarm delay time delays the 22 mA signal (if configured).

Configuration

Time and Date Tag Number

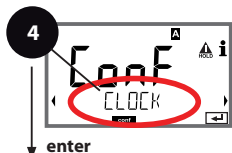

- 1 Press any arrow key.
- 2 Select **CONF** using ◀ ▶ keys, press **enter**.
- 3 Select parameter set A using ◀ ▶ keys, press **enter**.
- 4 Press **enter**.
- 5 Select **CLOCK** or **TAG** using ◀ ▶ keys, press **enter**.
- 6 All items of this menu group are indicated by the "CLK:" or "TAG" code. Press **enter** to select menu, edit using arrow keys (see next page). Confirm (and proceed) by pressing **enter**.
- 7 End: Press **meas** key until the [meas] mode indicator is displayed.

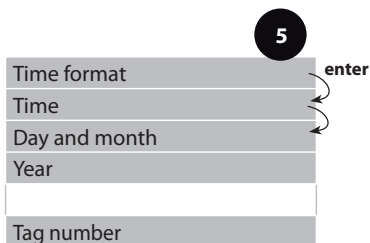

Time and Date

Control of the calibration and cleaning cycles is based on the time and date of the integrated real-time clock.

In measuring mode the time is shown in the lower display.

When using digital sensors, the calibration data is written in the sensor head.

In addition, the logbook entries (cf Diagnostics) are provided with a time stamp.

Please note:

- After prolonged power outage (> 5 days) the time display is replaced by dashes and cannot be used for processing.
Enter the correct time.
- There is no automatic switchover from winter to summer time!
Be sure to manually adjust the time!

Tag Number ("TAG")

You can enter a designation for the point of measurement (tag number) in the lower display line. Up to 32 digits are possible.

Pressing **meas** (repeatedly) in the measuring mode indicates the tag number.

Being part of the device configuration, the "TAG" can be read out via IrDA. A standardized tag number helps, for example, to correctly re-install a device after repair.

5

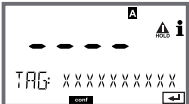
Menu item	Action	Choices
Tag number 	Select character using ▲ ▼ keys, select next digit using ◀ ▶ keys. Confirm with enter	A...Z, 0...9, - + < > ? / @ The first 10 characters are seen in the display with- out scrolling.

Please note:

- All calibration procedures must be performed by trained personnel. Incorrectly set parameters may go unnoticed, but change the measuring properties.

Calibration can be performed by:

- Determining the cell factor with a known calibration solution taking account of the temperature
- Input of cell factor (e.g. for ultrapure-water sensors)
- Sampling (product calibration)
- Zero calibration in air or with calibration solution
- Temperature probe adjustment

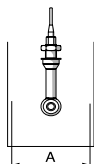

Please note:

If measurements are performed in fittings with $A < 110$ mm, be sure to choose a calibration beaker with the same cross-section and of the same material (metal/plastic)!

Selecting a Calibration Mode

Calibration adapts the device to the individual sensor characteristics. Access to calibration can be protected with a passcode (SERVICE menu).

First, you open the calibration menu and select the calibration mode:

CAL_SOL	Calibration with calibration solution
CAL_CELL	Calibration by entry of cell factor
P_CAL	Product calibration (calibration with sampling)
CAL_ZERO	Zero calibration
CAL_RTD	Temperature probe adjustment

Calibration



Calibration with Calibration Solution



Input of temperature-corrected value of calibration solution with simultaneous display of cell factor.

Be sure to use known calibration solutions and the respective temperature-corrected conductivity values (see calibration solution tables in the appendix). During the calibration procedure the temperature must be kept constant.

Please note:





When using an ARF 210/215 flow-through fitting, you should use the included calibration beakers (identical dimensions and materials) for calibration to prevent calibration errors.

Display	Action	Remark
	Select Calibration. Press enter to proceed. Select CAL_SOL calibration method. Press enter to proceed.	
	Ready for calibration. Hourglass blinks.	Display (3 sec) Now the device is in HOLD mode.
	Immerse sensor in calibration solution. Enter the temperature- corrected value of the calibration solution us- ing the arrow keys (see table in the appendix). Press enter to confirm.	Lower line: display of cell factor and temperature

Display	Action	Remark
	<p>The cell factor and zero point are displayed. The “hourglass” icon is blinking.</p>	
	<p>Use the arrow keys to select:</p> <ul style="list-style-type: none"> • Repeat (repeat calibration) or • Measuring. <p>Press enter to confirm.</p>	
	<p>With MEAS selected: End calibration by pressing enter.</p>	<p>Display of measured variable, Sensoface is active.</p> <p>After end of calibration, the outputs remain in HOLD mode for a short time.</p> <p>After display of GOOD BYE, the device automatically returns to measuring mode.</p>

Calibration by Input of Cell Factor

You can directly enter the value for the cell factor of a sensor. This value must be known, e.g. determined beforehand in the laboratory. The selected process variable and the temperature are displayed. This method is suitable for all process variables.

Display	Action	Remark
	Select Calibration. Press enter to proceed. Select CAL_CELL calibration method. Press enter to proceed.	
	Ready for calibration. Hourglass blinks.	Display (3 sec) Now the device is in HOLD mode.
	Enter cell factor. Press enter to proceed.	The selected process variable and the temperature are displayed.
	The device shows the calculated cell factor and zero point (at 25 °C). Sensoface is active.	
	Use the arrow keys to select: • MEAS (end) • REPEAT Press enter to proceed.	End: HOLD is deactivated after a short time.

Please refer to the Specifications for the nominal cell factor. When measuring in a restricted space, the individual cell factor must be determined.

Product Calibration

(Calibration by sampling)

For product calibration, the uncompensated conductivity (mS/cm, S/m) is used. During product calibration the sensor remains in the process. The measurement process is only interrupted briefly.

Procedure:



1) The sample is measured in the lab or directly on the site using a portable meter. To ensure an exact calibration, sample temperature and process temperature should be the same.

During sampling the device saves the currently measured value and then returns to measuring mode. Then, the “calibration” mode indicator blinks.







2) In the second step you enter the measured sample value in the device. From the difference between the stored measured value and entered sample value, the device calculates the new cell factor.

If the sample is invalid, you can take over the value stored during sampling. In that case the old calibration values are stored.





Afterwards, you can start a new product calibration.

Display	Action	Remark
	Select Calibration. Press enter to proceed. Select P_CAL calibration method. Press enter to proceed.	
	Ready for calibration. Hourglass blinks.	Display (3 sec) Now the device is in HOLD mode.
	Take sample and save value. Press enter to proceed.	Now the sample can be measured in the lab.

Calibration





Display	Action	Remark
	The device returns to measuring mode.	From the blinking CAL mode indicator you see that product calibration has not been terminated.
	Product calibration step 2: When the sample value has been determined, open the product calibration once more	Display (3 sec) Now the device is in HOLD mode.
	The stored value is displayed (blinking) and can be overwritten with the lab value. Press enter to proceed.	
	Display of new cell factor and zero point (based on 25°C). Sensoface is active. Press enter .	To repeat calibration: Select REPEAT, then enter
	To end calibration: Select MEAS, then enter	
	After calibration is ended, the device will switch to measuring mode.	After end of calibration, the outputs remain in HOLD mode for a short time.



Zero Calibration in Air / with Calibration Solution

Display	Action	Remark
	Select Calibration. Press enter to proceed. Select CAL_ZERO calibration method. Press enter to proceed.	
	Ready for calibration. Hourglass blinks.	Display (3 sec) Now the device is in HOLD mode.
	Calibration in air. Edit digits until the lower display indicates Zero Calibration with solution Edit digits until the lower display indicates the solution value Press enter to proceed.	
	The device shows the cell factor (at 25 °C) and the zero point. Sensiface is active.	
	Use the arrow keys to select: <ul style="list-style-type: none"> • MEAS (end) • REPEAT Press enter to proceed.	End: HOLD is deactivated after a short time.

Calibration

Temp Probe Adjustment

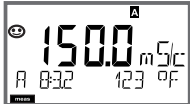
Display	Action	Remark
	Select Calibration. Press enter to proceed. Select CAL_RTD calibration method. Press enter to proceed.	Wrong settings change the measurement properties!
	Measure the temperature of the process medium using an external thermometer.	Display (3 sec) Now the device is in HOLD mode.
	Enter the measured temperature value. Maximum difference: 10 K. Press enter to proceed.	Display of actual temperature (un-compensated) in the lower display.
	The corrected temperature value is displayed. Sensoface is active. To end calibration: Select MEAS, then enter To repeat calibration: Select REPEAT, then enter	After end of calibration, the outputs remain in HOLD mode for a short time.
	After calibration is ended, the device will switch to measuring mode.	

Display	Remark
	<p>From the configuration or calibration menus, you can switch the device to measuring mode by pressing the meas key. In the measuring mode the main display shows the configured process variable (Cond or temperature), the secondary display shows the time and the second configured process variable (Cond or temperature). The [meas] mode indicator lights and the active parameter set (A/B) is indicated. A/B is not displayed with parameter set Fix A.</p>
	<p>Please note:</p> <ul style="list-style-type: none"> • After prolonged power outage (> 5 days) the time display is replaced by dashes and cannot be used for processing. Enter the correct time.
<p>Pressing the enter key briefly shows the output currents. By pressing the meas key you can step through the following displays. When no key has been pressed for 60 sec, the device returns to the standard display.</p>	
	<p>Selecting the parameter set (if set to "manual" in the configuration). Select the desired parameter set using the ◀ ▶ arrow keys (PARSET A or PARSET B blinks in the lower display line). Press enter to confirm.</p>
	<p>Further displays (each with meas).</p> <ol style="list-style-type: none"> 1) Display of tag number ("TAG") 2) Display of time and date

Diagnostics

In the Diagnostics mode you can access the following menus without interrupting the measurement:



CALDATA	Viewing the calibration data
SENSOR	Viewing the sensor data
SELFTEST	Starting a device self-test
LOGBOOK	Viewing the logbook entries
MONITOR	Displaying currently measured values
VERSION	Displaying device type, software version, serial number

Access to diagnostics can be protected with a passcode (SERVICE menu).





Please note:





HOLD is not active during Diagnostics mode!

Action	Key	Remark
Activate Diagnostics		Press any arrow key to call the selection menu. Select DIAG using ◀ ▶ keys, press enter to confirm.
Select diagnostics option		Use ◀ ▶ keys to select from: CALDATA SENSOR SELFTEST LOGBOOK MONITOR VERSION See next pages for further proceeding.
End	meas	End by pressing meas .

Menu item	Remark
	<p>Display of calibration data</p> <p>Select CALDATA using ◀ ▶, press enter to confirm. Use the ◀ ▶ keys to select the desired parameter from the bottom line of the display (LAST_CAL CELLFACTOR ZERO). The selected parameter is shown in the main display.</p>
	<p>Press meas to return to measurement.</p>

Diagnostics

Display	Menu item
	Device self-test (To abort, you can press meas) 1 Display test: Display of all segments. Press enter to proceed.
	2 RAM test: Hourglass blinks, then display of --PASS-- or --FAIL-- Press enter to proceed.
	3 EEPROM test: Hourglass blinks, then display of --PASS-- or --FAIL-- Press enter to proceed.
	4 FLASH test: Hourglass blinks, then display of --PASS-- or --FAIL-- Press enter to proceed.
	5 Module test: Hourglass blinks, then display of --PASS-- or --FAIL-- Press enter or meas to return to measuring mode.

Menu item	Remark
	<p>Display of logbook entries. Select LOGBOOK using ◀ ▶, press enter to confirm.</p> <p>By using the ▲ ▼ keys, you can scroll backwards and forwards through the logbook (entries -00...-99), -00- being the last entry.</p> <p>By using the ◀ ▶ keys, you can view a logbook entry.</p> <p>Press meas to return to measurement.</p>
	<p>Press meas to return to measurement.</p>
	<p>Extended logbook / Audit Trail (via TAN) By using the ▲ ▼ keys, you can scroll backwards and forwards through the extended logbook (entries -000...-199), -000- being the last entry.</p> <p>Display: CFR Audit Trail also records function activations (CAL CONFIG SERVICE), some Sensoface messages, and opening of the enclosure.</p>
	<p>Display of currently measured values (sensor monitor): Select MONITOR using ◀ ▶, press enter to confirm. Use the ◀ ▶ keys to select the desired parameter from the bottom line of the display (R_COND G_COND RTD TEMP I-INPUT (Option)). The selected parameter is shown in the main display.</p> <p>Press meas to return to measurement.</p>
<p>Display example:</p> 	<p>Press meas to return to measurement.</p>

Diagnostics



Display	Remark
 A screenshot of a diagnostic display. The display shows '1.0.2 SW' in large digits at the top. Below it, 'SERIAL-NO 0073' is displayed. There are navigation arrows on the left and right sides of the display area.	<p>Version</p> <p>Here, you find the data you require for requesting a device-specific Option.</p> <p>Display of device type, software/hardware version, and serial number for all device components.</p> <p>Use the ▲ ▼ keys to switch between software and hardware version. Press enter to proceed to next device component.</p>

In the Service mode you can access the following menus:



MONITOR	displaying currently measured values
OUT1	testing current output 1
OUT2	testing current output 2
IRDA	activating and communicating via the IrDA interface
CODES	assigning and editing passcodes
DEFAULT	resetting the device to factory settings
OPTION	enabling options via TAN.

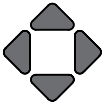

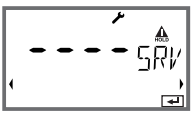

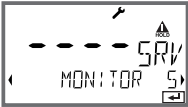

Please note:

HOLD is active during Service mode!























Action	Key/Display	Remark
Activate Service		Press any arrow key to call the selection menu. Select SERVICE using ◀ ▶ keys, confirm with enter
Passcode		Enter passcode "5555" for service mode using the ▲ ▼ ◀ ▶ keys. Confirm with enter .
Display		In service mode the following icons are displayed: <ul style="list-style-type: none"> • [diag] mode indicator • HOLD triangle • Service (wrench)
End	meas	End with meas .

Service

Menu item	Remark
 <p>Display example:</p> 	<p>Display of currently measured values (sensor monitor) with HOLD mode activated: Select MONITOR using ◀ ▶, press enter to confirm. Select variable in the bottom text line using ◀ ▶.</p> <p>The selected parameter is shown in the main display. As the device is in HOLD mode, you can perform validations using simulators without influencing the signal outputs.</p> <p>Press meas to return to the service menu. Return to measurement: Press meas once more.</p>
	<p>Specify current at outputs 1 and 2: Select OUT1 or OUT2 using the ◀ ▶ keys, press enter to confirm. Enter a valid current value for the respective output using ▲ ▼ ◀ ▶ keys. Press enter to confirm. For checking purposes, the actual output current is shown in the bottom right corner of the display. End by pressing enter or meas.</p>

Menu item	Remark
	<p>IrDA communication: Select IRDA using ◀ ▶ , press enter to confirm.</p>
	<p>When IrDA communication is active, the device remains in the HOLD mode for reasons of safety. Further operation is performed via IrDA.</p>
	<p>End communication by pressing meas.</p> <p>Exception: Firmware update (must not be interrupted!)</p>
	<p>Assigning passcodes: In the "SERVICE - CODES" menu you can assign passcodes to DIAG, HOLD, CAL, CONF, and SERVICE modes (Service preset to 5555).</p> <p>When you have lost the Service passcode, you have to request an "Ambulance TAN" from the manufacturer specifying the serial number of your device. To enter the "Ambulance TAN", call the Service function and enter passcode 7321. After correct input of the ambulance TAN the device signals "PASS" for 4 sec and resets the Service passcode to 5555.</p>
	<p>Reset to factory settings: In the "SERVICE - DEFAULT" menu you can reset the device to factory settings.</p> <p>Caution! After a reset to factory setting the device must be reconfigured completely, including the sensor parameters!</p>
	<p>Release of options: Options come with a "transaction number" (TAN). This TAN must be entered and confirmed with enter to release the option.</p>

Operating States

Operating status	OUT 1	OUT 2	Time out
Measuring			-
Diag			60 s
CAL_SOL Cal solution			No
CAL_CELL Cell factor			No
P_CAL Product cal S1			No
P_CAL Product cal S2			No
CAL_ZERO Zero point			No
CAL_RTD Temp adjustment			No
CONF ParSet A			20 min
CONF ParSet B			20 min
HOLD input			No

Explanation:  as configured (Last/Fix)
 active

Product Line and Accessories

M420

Designation		Article Number
M420 pH H		52121405
M420 pH H OUT2	with 2nd current output	52121406
M420 pH XH		52121407
M420 pH XH OUT2	with 2nd current output	52121408
M420 O2 H		52121415
M420 O2 H OUT2	with 2nd current output	52121416
M420 O2 XH		52121417
M420 O2 XH OUT2	with 2nd current output	52121418
M420 Cond H		52121425
M420 Cond H OUT2	with 2nd current output	52121426
M420 Cond XH		52121427
M420 Cond XH OUT2	with 2nd current output	52121428
M420 Cond Ind H		52121435
M420 Cond Ind H OUT2	with 2nd current output	52121436
M420 Cond Ind XH		52121437
M420 Cond Ind XH OUT2	with 2nd current output	52121438

TAN options

Logbook	SW-420-002	52121466
Extended logbook (Audit Trail)	SW-420-003	52121467
Trace oxygen measurement	SW-420-004	52121468
Current input + 2 digital inputs	SW-420-005	52121469

Mounting accessories

Pipe-mount kit		52120741
Protective hood		52121470
Panel-mount kit		52121471

M420: Supply Units and Connection

Recommended Power Supply Units: Order No.:

Repeater power supply, IS, 24 V AC/DC, output 0/4...20 mA	52120688 WG 20 A2 Power Supply
Repeater power supply, IS, 90...253 V AC, output 4...20 mA	52121689 WG 21 A7 Power Supply
Repeater power supply, IS, 90...253 V AC, HART, output 4...20 mA	52120704 WG 21 A7 Opt. 470
Repeater power supply, IS, 24 V AC/DC, output 4...20 mA	52129772 WG 21 A7 Opt. 336
Repeater power supply, IS, 24 V AC/DC, HART, output 4...20 mA	52120774 WG 21 A7 Opt. 336, 470

Option 336: 24 V AC/DC power supply

Option 470: for transmission of HART protocol

Connection to Supply Units

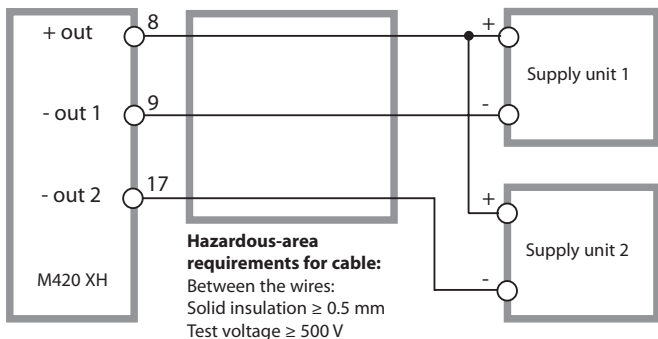

Specifications

Cond ind input	Input for electrodeless conductivity sensors InPro 7250 ST, InPro 7250 PFA, InPro 7250 HT	
Effective ranges	Conductivity	0.000 ... 1999 mS/cm
	Concentration	0.00 ... 100.0% by wt
	Salinity	0.0 ... 45.0 ‰ (0 ... 35 °C)
Ranges	Conductivity	0.000 ... 9.999 mS/cm 00.00 ... 99.99 mS/cm 000.0 ... 999.9 mS/cm 0000 ... 1999 mS/cm 0.000 ... 9.999 S/cm 00.00 ... 99.99 S/cm
	Concentration	0.00 ... 9.99 % / 10.0 ... 100.0 %
	Salinity	0.0 ... 45.0 ‰ (0 ... 35 °C)
	Response (T90)	Approx. 1 s
Meas. error^{1,2,3)}	< 1 % meas. val. + 0.005 mS	
Temp compensation^{*)} (reference temp 25°C)	(OFF)	Without
	(LIN)	Linear characteristic 00.00 to 19.99 %/K
	(NLF)	Natural waters to EN 27888
Concentration determination	-01- NaCl	0 - 26% by wt (0 °C) ... 0 - 28% by wt (100 °C)
	-02- HCl	0 - 18% by wt (-20 °C) ... 0 - 18% by wt (50 °C)
	-03- NaOH	0 - 13% by wt (0 °C) ... 0 - 24% by wt (100 °C)
	-04- H ₂ SO ₄	0 - 26% by wt (-17 °C) ... 0 - 37% by wt (110 °C)
	-05- HNO ₃	0 - 30% by wt (-20 °C) ... 0 - 30% by wt (50 °C)
	-06- H ₂ SO ₄	94 - 99% by wt (-17 °C) ... 89 - 99% by wt (115 °C)
	-07- HCl	22 - 39% by wt (-20 °C) ... 22 - 39% by wt (50 °C)
	-08- HNO ₃	35 - 96% by wt (-20 °C) ... 35 - 96% by wt (50 °C)
	-09- H ₂ SO ₄	28 - 88% by wt (-17 °C) ... 39 - 88% by wt (115 °C)
	-10- NaOH	15 - 50% by wt (0 °C) ... 35 - 50% by wt (100 °C)

Sensor standardization	<p>Input of cell factor with simultaneous display of selected process variable and temperature</p> <p>Input of conductivity of calibration solution with simultaneous display of cell factor and temperature</p> <p>Product calibration for conductivity</p> <p>Zero adjustment</p> <p>Temperature probe adjustment</p>
Permitted cell factor	00.100 ... 19.999
Permitted transfer ratio	01.00 ... 199.99
Permitted zero offset	± 0.5 mS
Sensocheck	Monitoring of primary and secondary coils and lines for open circuit and of primary coil and lines for short circuit
Delay	Approx. 30 s
Sensoface	Provides information on the sensor condition (zero point, Sensocheck)
Sensor monitor	Direct display of measured values from sensor for validation (resistance/temperature)
Temperature input *	<p>Pt100/Pt1000/NTC 30 kΩ</p> <p>3-wire connection, adjustable</p>
Measuring range	<p>Pt 100/Pt 1000 -50 ... +200 °C / -58 ... +392 °F</p> <p>NTC 30 kΩ -20 ... +150 °C / -4 ... +302 °F</p>
Resolution	0.1 °C / 0.1 °F
Meas. error ^{1,2,3)}	< 0.5 K (< 1 K for Pt 100; <1K for NTC >100°C)
I input (TAN)	Current input 0/4 ... 20 mA / 50 Ω for external temperature signal
Start/end of scale	Configurable -50 ... +200 °C / -58 ... +392 °F
Characteristic	Linear
Measurement error ^{1,3)}	< 1% current value + 0.1 mA

Specifications

HOLD input	Galvanically separated (OPTO coupler)
Function	Switches device to HOLD mode
Switching voltage	0 ... 2 V (AC/DC) HOLD inactive 10 ... 30 V (AC/DC) HOLD active
CONTROL input	Galvanically separated (OPTO coupler)
Function	Selecting parameter set A/B
Switching voltage	0 ... 2 V (AC/DC) Parameter set A 10 ... 30 V (AC/DC) Parameter set B
Output 1	Current loop, 4 ... 20 mA, floating, protected against inverse polarity HART communication (see further below for specifications)
Supply voltage	14 ... 30 V
Process variable*	Conductivity, concentration, salinity, or temperature
Characteristic	Linear or logarithmic
Overrange*	22 mA in the case of error messages
Output filter*	PT ₁ filter, time constant 0 ... 120 s
Measurement error ¹⁾	< 0.25% current value + 0.025 mA
Start/end of scale*	Configurable within selected range
Minimum span	LIN 5% of selected range LOG 1 decade
Output 2	Current loop, 4 ... 20 mA, floating, protected against inverse polarity
Supply voltage	14 ... 30 V
Process variable*	Conductivity, concentration, salinity, or temperature
Characteristic	Linear or logarithmic
Overrange*	22 mA in the case of error messages
Output filter*	PT ₁ filter, time constant 0 ... 120 s
Measurement error ¹⁾	< 0.25% current value + 0.05 mA

Start/end of scale *	Configurable within selected range
Minimum span	LIN 5% of selected range
	LOG 1 decade
Real-time clock	Different time and date formats selectable
Power reserve	> 5 days
Display	LC display, 7-segment with icons
Main display	Character height approx. 22 mm, unit symbols approx. 14 mm
Secondary display	Character height approx. 10 mm
Text line	14 characters, 14 segments
Sensoface	3 status indicators (friendly, neutral, sad face)
Mode indicators	meas, cal, conf, diag
	Further icons for configuration and messages
Alarm indication	Display blinks
Keypad	Keys: meas, info, 4 cursor keys, enter
HART communication	HART version 6 Digital communication by FSK modulation of output current 1 Device identification, measured values, status and messages, parameter setting, calibration, records
IrDA interface	Infrared interface for transmission of records and logbook, parameter setting, calibration, firmware update
FDA 21 CFR Part 11	Access control by editable passcodes Logbook entry and flag via HART in the case of configuration changes Message and logbook entry when enclosure is opened

Specifications

Diagnostics functions	
Calibration data	Calibration date, cell factor, zero point
Device self-test	Displaytest, automatic memory test (RAM, FLASH, EEPROM), module test
Logbook	100 events with date and time
Extended logbook (TAN)	Audit Trail: 200 events with date and time
Service functions	
Sensor monitor	Display of direct sensor signals
Current source	Current specifiable for output 1 and 2 (00.00 ... 22.00 mA)
IrDA	Activating the IrDA function
Passcodes	Assigning passcodes for menu access
Factory setting	Resetting all parameters to factory setting
TAN	Enabling optionally available additional functions
Data retention	Parameters, calibration data, logbook > 10 years (EEPROM)
EMC	EN 61326-1 (General Requirements)
Emitted interference	Class B (residential area)
Immunity to interference	Industry EN 61326-2-3
Explosion protection	Europe: ATEX Zone 0, 1, 2, 20, 21
M420 XH..	USA: FM Class I Div 1,2 / Zone 1 (pending)
	Canada: cCSAus Class I Div 1,2 / Zone 1 (pending)
	International: IECEx Zone 0, 1, 20, 21

Nominal operating conditions	
Ambient temperature	-20 ... +65 °C
Transport/Storage temperature	-20 ... +70 °C
Relative humidity	10 ... 95% not condensing
Supply voltage	14 ... 30 V
Enclosure	
Fastening	Molded enclosure made of PBT/PC, glass reinforced Wall, pipe/post, or panel mounting
Color	Gray, RAL 7001
Ingress protection	IP 67
Flammability	UL 94 V-0
Dimensions	148 mm x 148 mm
Control panel cutout	138 mm x 138 mm to DIN 43 700
Weight	Approx. 1200 g
Cable glands	3 knockouts for M20 x 1.5 cable glands 2 knockouts for NPT ½" or rigid metallic conduit
Connections	Terminals, conductor cross section max. 2.5 mm ²
* User-defined	1) Acc. to EN 60746, at nominal operating conditions
2) ± 1 count	3) Plus sensor error

Calibration Solutions

Potassium Chloride Solutions

(Conductivity in mS/cm)

Temperature [°C]	Concentration ¹		
	0.01 mol/l	0.1 mol/l	1 mol/l
0	0.776	7.15	65.41
5	0.896	8.22	74.14
10	1.020	9.33	83.19
15	1.147	10.48	92.52
16	1.173	10.72	94.41
17	1.199	10.95	96.31
18	1.225	11.19	98.22
19	1.251	11.43	100.14
20	1.278	11.67	102.07
21	1.305	11.91	104.00
22	1.332	12.15	105.94
23	1.359	12.39	107.89
24	1.386	12.64	109.84
25	1.413	12.88	111.80
26	1.441	13.13	113.77
27	1.468	13.37	115.74
28	1.496	13.62	
29	1.524	13.87	
30	1.552	14.12	
31	1.581	14.37	
32	1.609	14.62	
33	1.638	14.88	
34	1.667	15.13	
35	1.696	15.39	
36		15.64	

¹ Data source: K. H. Hellwege (Editor), H. Landolt, R. Börnstein: Zahlenwerte und Funktionen ..., volume 2, part. volume 6

Sodium Chloride Solutions

(Conductivity in mS/cm)

Temperature [°C]	Concentration		
	0.01 mol/l ¹⁾	0,1 mol/l ¹⁾	Saturated ²⁾
0	0.631	5.786	134.5
1	0.651	5.965	138.6
2	0.671	6.145	142.7
3	0.692	6.327	146.9
4	0.712	6.510	151.2
5	0.733	6.695	155.5
6	0.754	6.881	159.9
7	0.775	7.068	164.3
8	0.796	7.257	168.8
9	0.818	7.447	173.4
10	0.839	7.638	177.9
11	0.861	7.831	182.6
12	0.883	8.025	187.2
13	0.905	8.221	191.9
14	0.927	8.418	196.7
15	0.950	8.617	201.5
16	0.972	8.816	206.3
17	0.995	9.018	211.2
18	1.018	9.221	216.1
19	1.041	9.425	221.0
20	1.064	9.631	226.0
21	1.087	9.838	231.0
22	1.111	10.047	236.1
23	1.135	10.258	241.1
24	1.159	10.469	246.2
25	1.183	10.683	251.3
26	1.207	10.898	256.5
27	1.232	11.114	261.6
28	1.256	11.332	266.9
29	1.281	11.552	272.1
30	1.306	11.773	277.4
31	1.331	11.995	282.7
32	1.357	12.220	288.0
33	1.382	12.445	293.3
34	1.408	12.673	298.7
35	1.434	12.902	304.1
36	1.460	13.132	309.5

1 Data source: Test solutions calculated according to DIN IEC 746-3

2 Data source: K. H. Hellwege (Editor), H. Landolt, R. Börnstein: Zahlenwerte und Funktionen ..., volume 2, part. volume 6

Concentration Measurement

Ranges

Substance	Concentration ranges		
NaCl Configuration	0-26% by wt (0°C) 0-26% by wt (100°C) -01-		
HCl Configuration	0-18% by wt (-20 °C) 0-18% by wt (50 °C) -02-	22-39% by wt (-20 °C) 22-39% by wt (50°C) -07-	
NaOH Configuration	0-13% by wt (0 °C) 0-24% by wt (100 °C) -03-	15-50% by wt (0 °C) 35-50% by wt (100°C) -10-	
H ₂ SO ₄ Configuration	0-26% by wt (-17 °C) 0-37% by wt (110 °C) -04-	28-77% by wt (-17°C) 39-88% by wt (115°C) -09-	94-99% by wt (-17°C) 89-99% by wt (115°C) -06-
HNO ₃ Configuration	0-30% by wt (-20°C) 0-30% by wt (50°C) -05-	35-96% by wt (-20°C) 35-96% by wt (50°C) -08-	

For the solutions listed above, the device can determine the substance concentration from the measured conductivity and temperature values in % by wt. The measurement error is made up of the sum of measurements errors during conductivity and temperature measurement and the accuracy of the concentration curves stored in the device. We recommend to calibrate the device together with the sensor, e.g. directly to concentration using the CAL_CELL method. For exact temperature measurement, you should perform a temperature probe adjustment. For measuring processes with rapid temperature changes, a separate temperature probe with fast response should be used.

When measuring processes such as dilution or intensification of CIP solutions (Clean-In-Place), it is helpful to switch between the parameter sets for measuring the process medium and for measuring the CIP solution.

Concentration Curves

-01- Sodium chloride solution NaCl

← -01- →

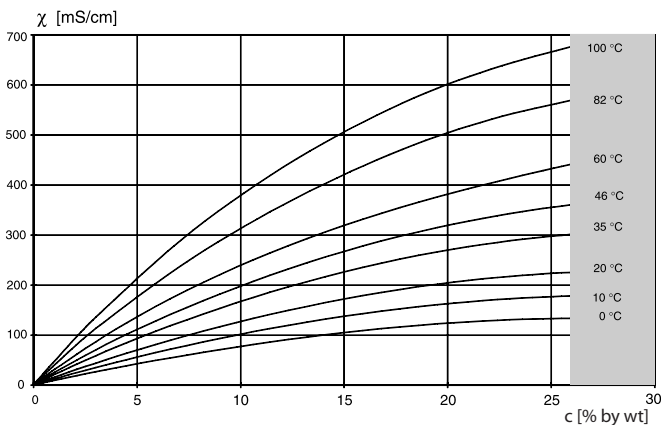

■ Concentration measurement not possible in this range.

Conductivity versus substance concentration and process temperature for sodium chloride solution (NaCl)

Concentration Curves

-02- Hydrochloric acid HCl

-07-

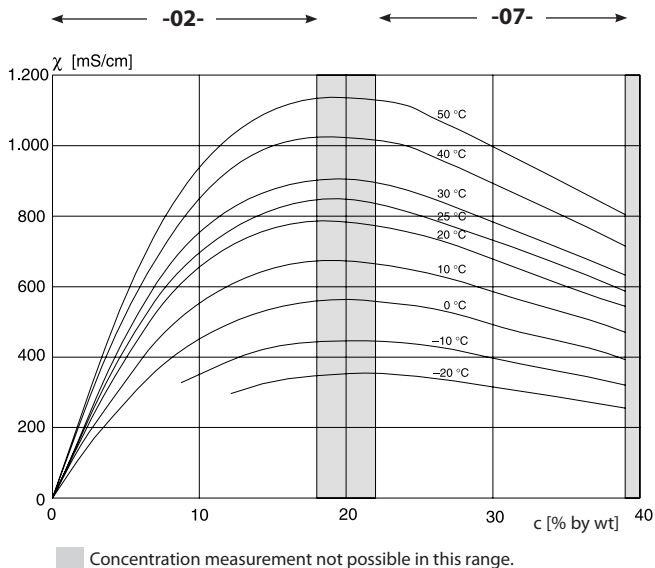

Conductivity versus substance concentration and process temperature for hydrochloric acid (HCl)

Source: Haase/Sauerermann/Dücker; Z. phys. Chem. New Edition, Vol. 47 (1965)

-03- Sodium hydroxide solution NaOH

-10-

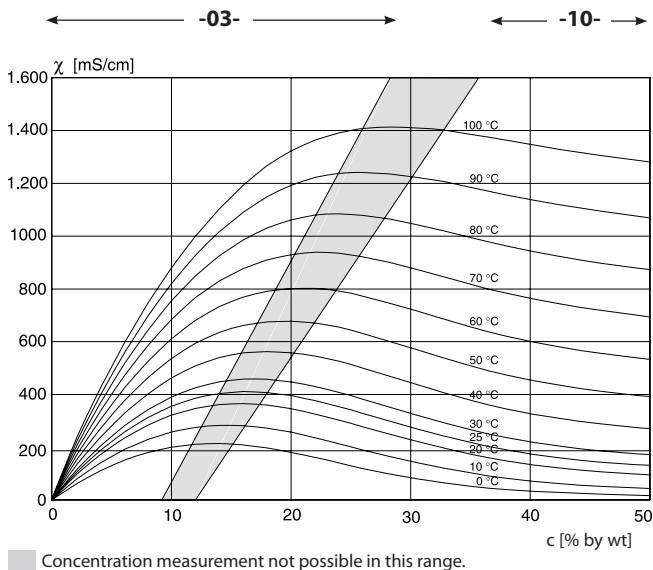

Conductivity versus substance concentration and process temperature for sodium hydroxide solution (NaOH)

Concentration Curves

-04- Sulfuric acid H_2SO_4

-06-

-09-

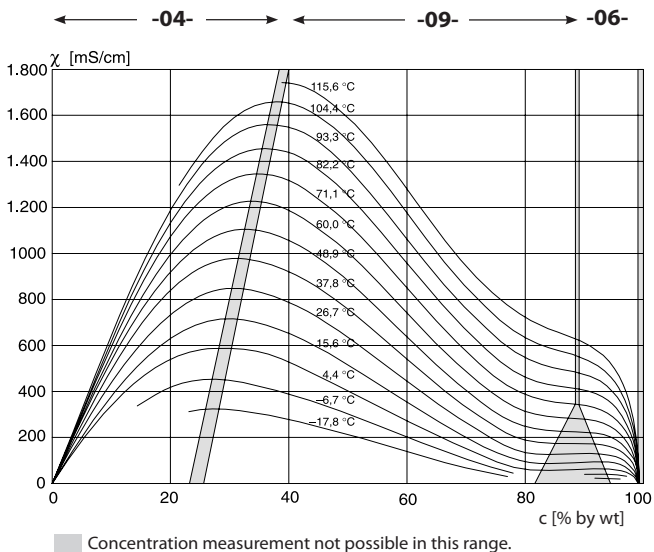

Conductivity versus substance concentration and process temperature for sulfuric acid (H_2SO_4)

Source: Darling; Journal of Chemical and Engineering Data; Vol.9 No.3, July 1964

-05- Nitric acid HNO_3

-08-

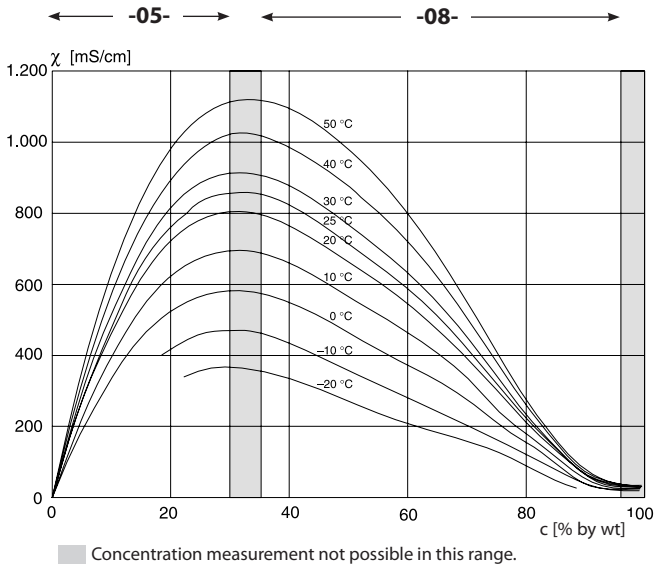

Conductivity versus substance concentration and process temperature for nitric acid (HNO_3)

Source: Haase/Sauermann/Dücker; Z. phys. Chem. New Edition, Vol. 47 (1965)

Alarm Condition:

- The  alarm icon is displayed
- The complete measured-value display blinks
- “**ERR xxx**” is displayed in the lower menu line

Press the [**info**] key to view a short error text:

- The error text appears in the lower menu line
- The main display reads “**InFo**”.

Parameter Errors:

Configuration data such as current range, limit values, etc are checked during the input.

If they are out of range,

- “**ERR xxx**” is displayed for 3 sec,
- the respective maximum or minimum value is shown,
- input must be repeated

If a faulty parameter arrives through the interface (IrDA, HART),

- an error message will be displayed: “**ERR 100...199**”
- the faulty parameter can be localized by pressing the [**info**] key

Calibration Errors:

If errors occur during calibration, e.g. by using a wrong buffer,

- an error message will be displayed
- calibration will be restarted

Sensoface:

If the Sensoface becomes sad

- the cause can be seen by pressing the [**info**] key
- the calibration data can be seen in the Diagnostics menu

Error Messages

Error	Info text (is displayed in case of fault when the Info key is pressed)	Problem Possible causes
ERR 99	DEVICE FAILURE	Error in factory settings EEPROM or RAM defective This error message only occurs in the case of a total defect. The device must be repaired and recalibrated at the factory.
ERR 98	CONFIGURATION ERROR	Error in configuration or calibration data Memory error in device program Configuration or calibration data defective; completely reconfigure and recalibrate the device.
ERR 97	NO MODULE INSTALLED	No module Please have the module replaced in the factory.
ERR 96	WRONG MODULE	Wrong module Please have the module replaced in the factory.
ERR 95	SYSTEM ERROR	System error Restart required. If error still persists, send in the device for repair.
ERR 100	INVALID SPAN OUT1	Span Out1 configuration error
ERR 101	INVALID SPAN OUT2	Span Out2 configuration error
ERR 105	INVALID SPAN I-INPUT	I-Input configuration error

Error	Info text (is displayed in case of fault when the Info key is pressed)	Problem Possible causes
ERR 11	CONDUCTIVITY RANGE CONCENTRATION RANGE SALINITY RANGE	Display range violation Cond > 999,9 mS/cm > 99,99 S/m Conc > 99.9 % SAL > 45.0 ‰
ERR 12	CONDUCTANCE TOO HIGH	Measuring range of conductance exceeded > 3500 mS
ERR 13	TEMPERATURE RANGE	Temperature range violation
ERR 15	SENSOCHECK	Sensocheck
ERR 60	OUTPUT LOAD	Load error
ERR 61	OUTPUT 1 TOO LOW	Output current 1 < 3.8 mA
ERR 62	OUTPUT 1 TOO HIGH	Output current 1 > 20.5 mA
ERR 63	OUTPUT 2 TOO LOW	Output current 2 < 3.8 mA
ERR 64	OUTPUT 2 TOO HIGH	Output current 2 > 20.5 mA

HART: Typical Applications

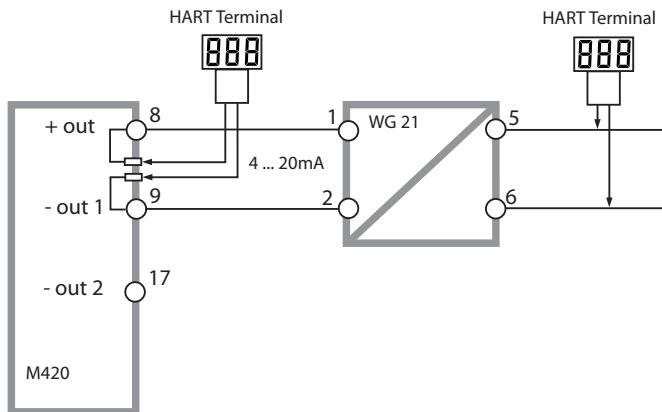
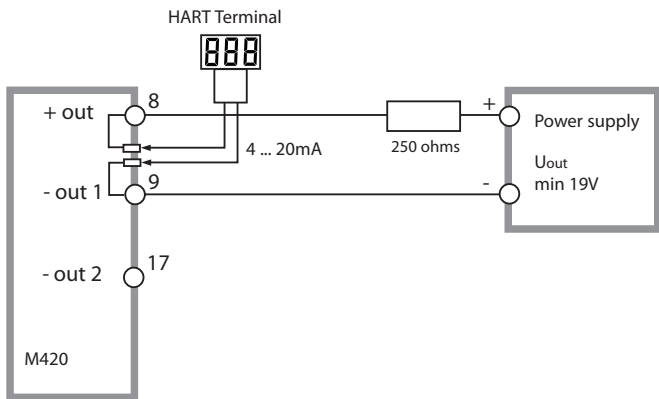

(Sensochek must have been activated during configuration.)



The smiley in the display (Sensoface) alerts to sensor problems (defective sensor, defective cable, maintenance required). The



permitted calibration ranges and the conditions for a friendly, neutral, or sad Sensoface are summarized in the following



table. Additional icons refer to the error cause.

Sensochek

Continuously monitors the sensor and leads for short circuits or open circuits. Critical values make the Sensoface “sad” and the corresponding icon blinks:



The Sensochek message is also output as error message Err 15.

The alarm contact is active, output current 1 is set to 22 mA (when configured correspondingly).

Sensochek can be switched off during configuration (then Sensoface is also disabled).





Exception:

After a calibration a smiley is always displayed for confirmation.

Please note:

The worsening of a Sensoface criterion leads to the devaluation of the Sensoface indicator (Smiley becomes “sad”). An improvement of the Sensoface indicator can only take place after calibration or removal of the sensor defect.

Sensoface

Display	Problem	Status	
	Sensor defect		Wrong or defective sensor or excessive cable capacitance (see also error message Err 15).
	Temperature		Temperature outside range for TC, conc, sal

EC Declaration of Conformity

Mettler-Toledo AG

Process Analytix

Address Im Hockacker 15, CH-8902 Udorf, Switzerland
Mail address P.O. Box, CH-8902 Udorf, Switzerland
Phone +41-44-729 62 11
Fax +41-44-729 66 36
Bank Credit Suisse, 8070 Zurich, Clearing 4835
Account No. 370501-21-90 CH-FIBAN CH71 0483 5037 0501 2109 0

www.mtpro.com

EC Declaration of conformity EG-Konformitätserklärung EC Déclaration de Conformité



We
Wir
Nous

Mettler-Toledo AG, Process Analytix

Im Hockacker 15
8902 Udorf
Switzerland Schweiz Suisse

declare under our sole responsibility that the product,
erklären in alleiniger Verantwortung, dass dieses Produkt,
déclarons sous notre seule responsabilité que le produit,

Description
Beschreibung
Description

M420 Series / Serie / Série

to which this declaration relates is in conformity with the following standard(s) or other normative document(s),
auf welches sich diese Erklärung bezieht, mit dem/den folgenden Norm(en) oder Richtlinie(n)
übereinstimmt,
à laquelle se réfère cette déclaration est conforme à la (sua) norme(s) ou à d'autres document(s) normatif(s).

EMC Directive
EMV-Richtlinie
CEN Directive

2004/108/EC
2004/108/EG
2004/108/CE

Low-voltage directive
Niederspannungs-Richtlinie
Directive basse tension

2006/95/EC
2006/95/EG
2006/95/CE

Standard
Norm
Norme

DIN EN 61010-1 / VDE 0411 Teil 1 : 2002-08
DIN EN 61326-1 / VDE 0843 Teil 20-1 : 2006-10
DIN EN 61326-2-3 / VDE 0843 Teil 20-2-3 : 2007-05

Mettler-Toledo AG, Process Analytix

Waldemar Rauch
General Manager PO Udorf

Thomas Hübli
Head of Operation and R&D

Place and Date of Issue
Ausstellungs-ort und Datum
Lieu et date d'émission

Udorf, 07.08.2006

This Original may not be copied, as subject to technical changes
Dieses Original darf nicht kopiert werden, da es dem Änderungsrisiko unterliegt
Cet original ne doit pas être copié, sujet de changement technique

CE_M420_int.doc

METTLER TOLEDO

EC Declaration of Conformity

Mettler-Toledo AG

Process Analytics

Address Im Hackacker 15, CH-8902 Urdorf, Switzerland
Mail address P.O. Box, CH-8902 Urdorf, Switzerland
Phone +41-44-729 62 11
Fax +41-44-729 66 36
Bank Credit Suisse, 8070 Zurich, Clearing 4835
Account No. 370001-21-90 CH/FIBAN CH71 0483 5037 0501 2109 0

www.mtpro.com

EC Declaration of conformity EG-Konformitätserklärung EC Déclaration de Conformité



We
Wir
Nos

Mettler-Toledo AG, Process Analytics
Im Hackacker 15
8902 Urdorf
Schweizland Schweiz Suisse

declare under our sole responsibility that the product,
erklären in alleiniger Verantwortung, dass dieses Produkt,
déclarons sous notre seule responsabilité que le produit,

Description
Beschreibung
Description

M420 X Series / Serie / Série

to which this declaration relates is in conformity with the following directive(s) and standard(s),
auf welches sich diese Erklärung bezieht, mit dem/den folgenden Norm(en) oder Richtlinie(n)
/obereinstimmt.
à ce que cette déclaration rapporte est conforme aux directive(s) et aux norme(s) suivantes.

ATEX Directive
ATEX Richtlinie
ATEX Directive

94/9/EC
94/9/EC
94/9/CE

**EC-Type Examination Certificate / EG-Baumeisterprüfbescheinigung /
Attestation d'Examen CE de Type
KEMA 06 ATEX 0144, KEMA Quality B.V. NL-6812 Arnhem, ExNB-No. 0344**

EMC Directive
EMV-Richtlinie
CEM Directive

2004/108/EC
2004/108/EG
2004/108/CE

Low-voltage directive
Niederspannungs-Richtlinie
Directive basse tension

2006/95/EC
2006/95/EG
2006/95/CE

Standard
Norm
Norme

EN 60079-0 :2006
EN 60079-11 :2007
EN 60079-26 :2007
EN 61241-0 :2006
EN 61241-11 :2006

DIN EN 61010-1 / VDE 0411 Teil 1 : 2002-08
DIN EN 61326-1 / VDE 0843 Teil 20-1 : 2006-10
DIN EN 61326-2-3 / VDE 0843 Teil 20-2-3 : 2007-05

Mettler-Toledo AG, Process Analytics

Wolfram Rauh
General Manager PO Urdorf

Thomas Hölzl
Head of Operation and R&D

Place and Date of issue
Ausstellungsort und Datum
Lieu et date d'émission

Urdorf, 09.09.2008

This Original may not be copied, as subject to technical changes
Dieses Original darf nicht kopiert werden, da es dem Änderungenplan unterliegt
Cet original ne doit pas être copié, sujet de changement technique

CE_M420_X_int.doc

METTLER TOLEDO

Conformity with FDA 21 CFR Part 11

In their directive “Title 21 Code of Federal Regulations, 21 CFR Part 11, Electronic Records; Electronic Signatures” the US American health agency FDA (Food and Drug Administration) regulates the production and processing of electronic documents for pharmaceutical development and production. This results in requirements for measuring devices used for corresponding applications. The following features ensure that the measuring devices of this Series meet the demands of FDA 21 CFR Part 11:

Electronic Signature – Passcodes

Access to the device functions is regulated and limited by individually adjustable codes – “Passcodes” (see SERVICE). This prevents unauthorized modification of device settings or manipulation of the measurement results. Appropriate use of these passcodes makes them suitable as electronic signature.

Audit Trail

Every (manual) change of device settings can be automatically documented. Each change is tagged with a “Configuration Change Flag”, which can be interrogated and documented using HART communication. Altered device settings or parameters can also be retrieved and documented using HART communication.

Extended logbook

Audit Trail also records function activations (CAL, CONFIG, SERVICE), some Sensoface messages (cal timer, wear), and opening of the enclosure.

Index

A

- Access codes 77, 109, 120
- Accessories 80
- Alarm 27
- Alarm settings 56
- Ambulance TAN 77
- Application in hazardous locations 15
- Approvals for application in hazardous locations 9, 86
- Assembly 11
- Audit Trail 109
- Autorange 45

C

- Calibration 24, 61
- Calibration by entry of cell factor 64
- Calibration data 71
- Calibration mode 61
- Calibration solutions 88
- Calibration with calibration solution 62
- CD-ROM 3
- CIP / SIP 43
- Commissioning 8
- Compulsory marking 9, 16
- Concentration curves
 - Hydrochloric acid HCl 92
 - Nitric acid HNO₃ 95
 - Sodium chloride solution NaCl 91
 - Sodium hydroxide solution NaOH 93
 - Sulfuric acid H₂SO₄ 94
- Concentration measurement 90
 - Configuration 39
 - Ranges 90
- Configuration 24
 - Current output 1 44
 - Current output 2 50
 - Individual configuration data 35

- Menu groups 29
- Menu structure 28
- Sensor 38
- Tag number 58
- Temperature compensation 52
- Time and date 58
- Connection to supply units 81
- Control Drawings 105
- CSA Control Drawings 108
- Current start/end 45

D

- Date 59
 - Display 69
- Device self-test 72
- Device type, display 74
- Diagnostics 24, 70
 - Calibration data 71
 - Device self-test 72
 - Logbook 73
 - Sensor monitor 73
 - Version 74
- Dimensions 12
- Display 21
 - Display data in Diagnostics mode 70
 - Display test 72
- Disposal 2
- Documentation 3

E

- EC Declaration of Conformity 103
- EEPROM test 72
- Electronic Signature 109
- Enclosure 12
- Enclosure components 11
- Entering values 23
- Error messages 98

Index

Explosion protection **86**

Extended logbook **109**

F

FDA 21 CFR Part 11 **109**

FLASH test **72**

FM Control Drawings **107**

H

HART **100**

HOLD **24, 26**

 End **26**

 External activation of HOLD **27**

 Manual activation of HOLD **27**

 Output signal during HOLD **26, 49**

 Output signal response **26**

I

Installation **15**

 Hazardous locations **9**

Intended use **7**

IrDA communication **77**

K

Keypad **20**

L

Logbook **73**

M

Measurement **69**

Measuring **22**

Menu structure **25**

 Configuration **28**

Module test **72**

Mounting plan **12**

O

- Operating modes 24
- Operating mode, selection 23
- Operating states 78
- Option request: Conditions 74
- Options 77, 80
- Output current, fixed value 76
- Output filter 46
- Output signal during HOLD 26, 49
- Overview 10

P

- Package contents 3, 11
- Panel mounting 14
- Parameter set A/B 29
 - Display 69
 - Manual selection 30
- Passcodes 109, 120
 - Assigning passcodes 77
- Pipe mounting 13
- Point of measurement (TAG) 59
- Power supply units 81
- Product calibration 65
- Product line 80
- Protective hood 13

R

- RAM test 72
- Rating plates 16
- Registered trademarks 119
- Release of options 77
- Reset to factory settings 77
- Return of products under warranty 2

S

- Safety information 7, 8
- Safety instructions 3
- Selection menu 23
- Sensocheck 56, 101
 - Configuration 57
- Sensoface 101
- Sensor connection 17, 18
- Sensor monitor 73, 76
- Sensor type selection 38, 40
- Serial number, display 74
- Service 24, 75
 - Factory setting 77
 - IrDA communication 77
 - Passcodes 77
 - Releasing options 77
 - Sensor monitor 76
 - Specifying current outputs 76
- Service passcode lost 77
- Software version, display 74
- Specifications 82
- Start-up 8
- Supply units 81

T

- Tag number (TAG) 59
- TAN options 77, 80
- Temperature compensation 53, 55
- Temperature probe 68
- Terminal assignments 16
- Terminals 9, 15, 16
- Time 59
 - Display 69
- Time averaging filter 47
- Trademarks 119

U

User interface **20**

W

Warranty **2**

Wiring **17**

 Power supply units **81**

Wiring examples **18**

Z

Zero calibration **67**

Trademarks

The following names are registered trademarks. For practical reasons they are shown without trademark symbol in this manual.

Sensocheck®

Sensoface®

Calimatic®

GainCheck®

InPro®, ISM® are registered trademarks of Mettler-Toledo.

HART® is a registered trademark of the HART Communication Foundation.

Passcodes

In the SERVICE – CODES menu you can assign passcodes to protect the access to certain functions.

Operating mode	Passcode
Service (SERVICE)	5555
Diagnostics (DIAG)	
HOLD mode	
Calibration (CAL)	
Configuration (CONF)	

Mettler-Toledo AG,
Process Analytics
Im Hackacker 15
CH-8902 Urdorf
Tel. +41 (44) 729 62 11
Fax +41 (44) 729 66 36
www.mt.com/pro



Subject to technical changes.

FM and CSA approvals pending