

M420 O₂

Instruction Manual



www.mt.com/pro



75571

METTLER TOLEDO

Warranty

Warranty

Defects occurring within 1 year from delivery date shall be remedied free of charge at our plant (carriage and insurance paid by sender).
Sensors, fittings, and accessories: 1 year.

Subject to change without notice.

Return of Products Under Warranty

Please contact our Service Team before returning a defective device. Ship the cleaned device to the address you have been given. If the device has been in contact with process fluids, it must be decontaminated/disinfected before shipment. In that case, please attach a corresponding certificate, for the health and safety of our service personnel.

Disposal

Please observe the applicable local or national regulations concerning the disposal of “waste electrical and electronic equipment”.



CD-ROM

Complete documentation:

- Instruction manuals
- Safety instructions
- Short instructions

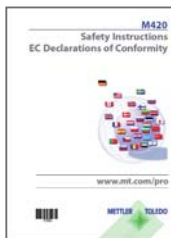

Safety Information

In official EU languages and others.

- FM / CSA
- EC Declarations of Conformity



Short Instructions

In German, English, French, Russian, Spanish, Portuguese, Japanese, Chinese.

Download: www.mt.com/pro

- Installation and commissioning
- Operation
- Menu structure
- Calibration
- Error messages and recommended actions

Specific Test Report

Contents

Documents Supplied	3
Introduction	7
Intended Use.....	7
Safety Information	8
Registered Trademarks	9
Overview of M420 O₂.....	10
Assembly	11
Package Contents.....	11
Mounting Plan, Dimensions.....	12
Pipe Mounting, Protective Hood	13
Panel Mounting.....	14
Installation	15
Installation Instructions	15
Rating Plates / Terminal Assignments.....	16
Wiring of M420 O ₂	17
Wiring Examples	19
User Interface, Keypad	22
Display	23
Measuring Mode.....	24
Selecting the Mode / Entering Values	25
Operating Modes.....	26
Menu Structure of Modes and Functions.....	27
HOLD Mode	28
Alarm.....	29
Configuration	30
Menu Structure of Configuration	30
Parameter Set A/B	32
Configuration (Original for Copy).....	39
Sensor	42
Current Output 1	48
Current Output 2	54

Correction	56
Alarm.....	58
Time and Date	60
Tag Number	60
ISM® Sensors.....	62
Operation	62
Connecting a Digital Sensor.....	63
Sensor Replacement	64
Calibrating a Digital Sensor	65
Calibration	66
Selecting a Calibration Mode	67
Zero Calibration	68
Product Calibration.....	70
Slope Calibration (Medium: Air).....	72
Temp Probe Adjustment.....	74
Measurement	75
Diagnostics	76
Service	81
Operating States.....	84
Product Line and Accessories	85
M420: Supply Units and Connection.....	86
Specifications	87
Error Handling.....	94
Error Messages.....	95
HART: Typical Applications.....	97
Sensoface	98
FDA 21 CFR Part 11	101
Electronic Signature – Passcodes	101
Audit Trail	101

Contents

EC Declarations of Conformity	102
M420 X Control Drawing.....	104
Index	108
Passcodes	116

Intended Use

The M420 O₂ is used for dissolved oxygen and temperature measurement in biotechnology, pharmaceutical industry, as well as in the field of industry, environment, food processing, and sewage treatment.

The sturdy molded enclosure can be fixed into a control panel or mounted on a wall or at a post. The protective hood, which is available as accessory, provides additional protection against direct weather exposure and mechanical damage.

The device has been designed for application with amperometric sensors and ISM® sensors.

Plain-text messages in a large, backlit display allow intuitive operation. Diagnostics functions are provided by the “Sensocheck” automatic monitoring of sensor membrane and sensor lines and the “Sensoface” indication of the sensor condition. The internal logbook can handle up to 100 entries – up to 200 with AuditTrail (TAN).

The device provides two parameter sets which can be switched manually or via a control input for different process adaptations or different process conditions (e.g. beer and CIP).

Password protection for granting access rights during operation can be configured.

Two floating, digital control inputs (“Hold” and “Control”) are available for external control.

The device provides two current outputs (for transmission of measured value and temperature, for example).

Approvals for Measurement in Hazardous Locations:

M420 O₂: General Safety, approved for operation in hazardous locations Zone 2 (FM* and CSA*, Class I Div 2)

M420 O₂ X: Approved for operation in hazardous locations Zone 1/0 (ATEX; FM* and CSA*, Class I Div 1) as well as Zone 2 (FM* and CSA*, Class I Div 2).

* FM and CSA approvals pending

Safety Information

Safety information –

Be sure to read and observe the following instructions!

The device has been manufactured using state of the art technology and it complies with applicable safety regulations.

When operating the device, certain conditions may nevertheless lead to danger for the operator or damage to the device.

See also separate document:

- “Safety Instructions”
(EC Declaration of Conformity, FM*, CSA*, ATEX (if applicable) Certificates)



CAUTION!

Commissioning must only be performed by trained personnel authorized by the operating company! Whenever it is likely that protection has been impaired, the device shall be made inoperative and secured against unintended operation.

The protection is likely to be impaired if, for example:

- the device shows visible damage
- the device fails to perform the intended measurements
- after prolonged storage at temperatures above 70°C
- after severe transport stresses

Before recommissioning the device, a professional routine test must be performed. This test must be carried out at the manufacturer's factory.

Please note:

Before commissioning it must be proved that the device may be connected with other equipment.

* FM and CSA approvals pending

Information for Installation in Hazardous Locations

(M420 O₂ X)

- Be sure to observe the stipulations of EN 60079-10 / EN 60079-14 or the corresponding local regulations during installation and commissioning. See also separate "Safety Instructions" document.

Approvals for Application in Hazardous Locations:

M420 O₂ X

acc. to ATEX in Zone 0, 1, 2

- acc. to FM and CSA in Class I Div 1, 2 / Zone 0, 1, 2

M420 O₂

- acc. to FM and CSA in Class I Div 2

Terminals:

Screw terminal, suitable for single wires / flexible leads up to 2.5 mm² (AWG 14).

Recommended torque for the terminal screws: 0,5 ... 0,6 Nm.

Registered Trademarks

The following names are registered trademarks. For practical reasons they are shown without trademark symbol in this manual.

ISM[®] is a registered trademark of Mettler-Toledo AG.

InPro[®] is a registered trademark of Mettler-Toledo AG.

HART[®] is a registered trademark of the HART Communication Foundation.

* FM and CSA approvals pending

Overview

Overview of M420 O₂

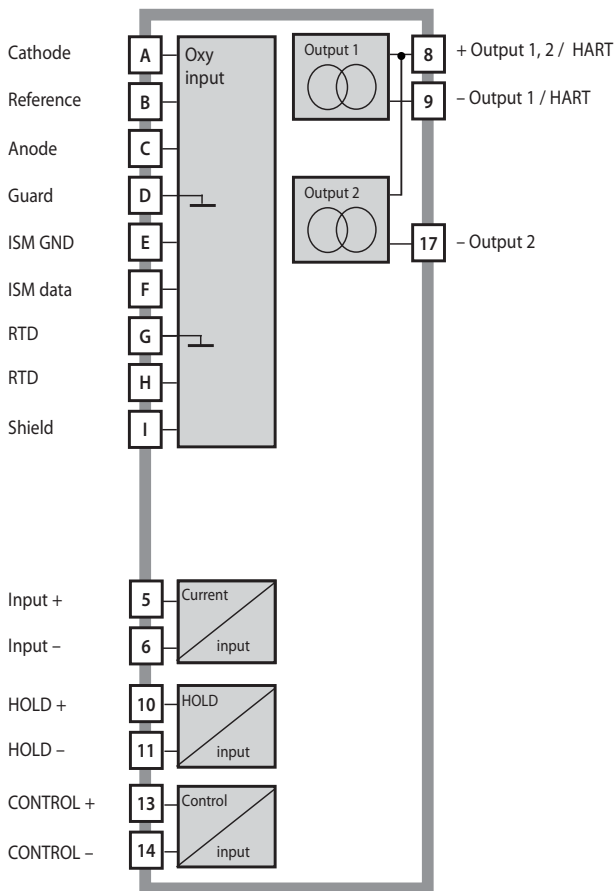

Package Contents

Check the shipment for transport damage and completeness!

The package should contain:

- Front unit, rear unit, bag containing small parts
- Specific test report
- Documentation (cf Pg 3)
- CD-ROM

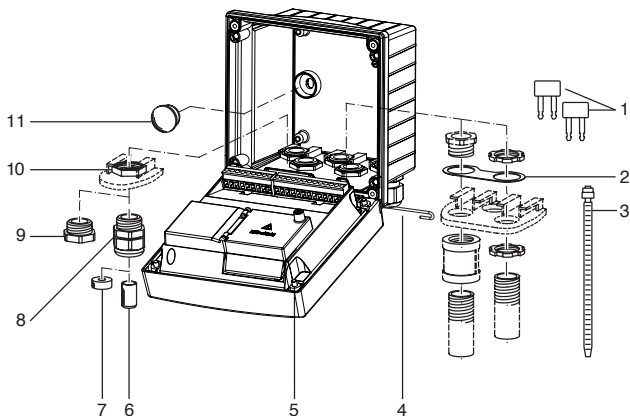

Fig.: Assembling the enclosure

- | | |
|---|--|
| 1) Jumper (3 x) | 6) Sealing insert (1 x) |
| 2) Washer (1 x), for conduit mounting: Place washer between enclosure and nut | 7) Rubber reducer (1 x) |
| 3) Cable tie (3 x) | 8) Cable gland (3 x) |
| 4) Hinge pin (1 x), insertable from either side | 9) Filler plug (3 x) |
| 5) Enclosure screw (4 x) | 10) Hexagon nut (5 x) |
| | 11) Sealing plug (2 x), for sealing in case of wall mounting |

Mounting Plan, Dimensions

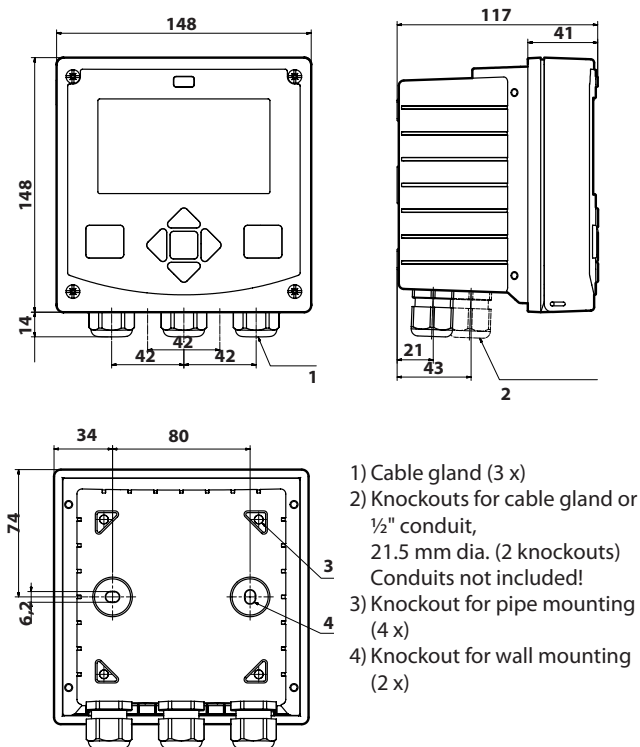
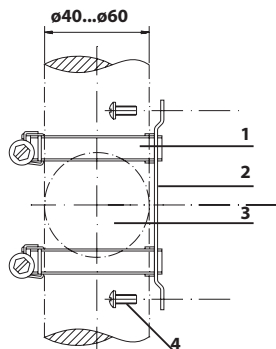

Fig.: Mounting plan (All dimensions in mm!)

Pipe Mounting, Protective Hood



- 1) Hose clamp with worm gear drive to DIN 3017 (2 x)
- 2) Pipe-mount plate (1 x)
- 3) For vertical or horizontal posts or pipes
- 4) Self-tapping screw (4 x)

Fig.: Pipe-mount kit (521202741) – All dimensions in mm!

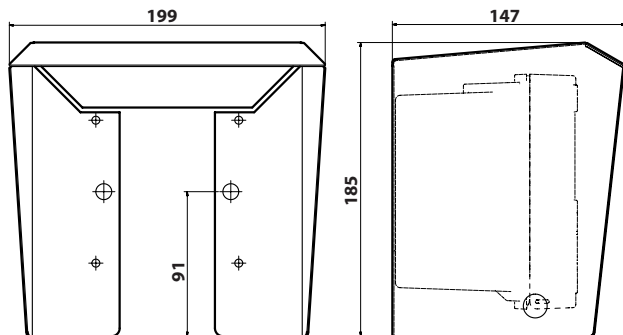

Fig.: Protective hood for wall and pipe mounting (52121470)
– All dimensions in mm!

Panel Mounting

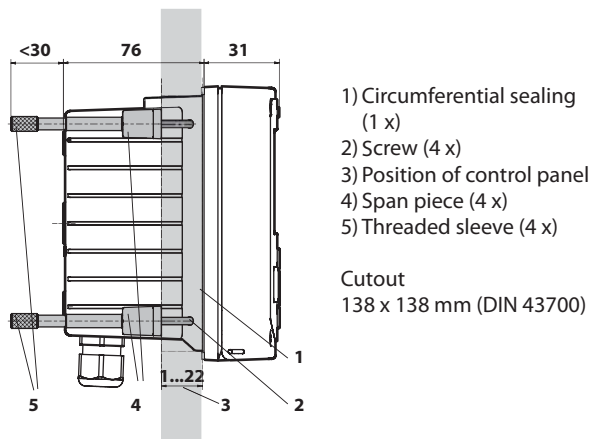

Fig.: Panel-mount kit (52121471) – All dimensions in mm!

Installation Instructions

- Installation may should be carried out by trained and qualified personnel in accordance with the instruction manual and as per applicable standards and regulations!
- Be sure to observe the technical specifications and input ratings during installation!
- Be sure not to notch the conductor when stripping the insulation!
- The supplied current must be galvanically isolated. If not, connect an isolator module.
- All parameters must be set by a system administrator prior to commissioning!

Terminals:

suitable for single wires / flexible leads up to 2.5 mm² (AWG 14)



Additional safety precautions have to be taken for operation in hazardous locations ATEX Zone 0, 1, 2 and FM*, CSA* Cl. I Div 1, 2 / Zone 0, 1, 2!

(See separate "Safety Instructions" document.)

* FM and CSA approvals pending

Rating Plates / Terminal Assignments

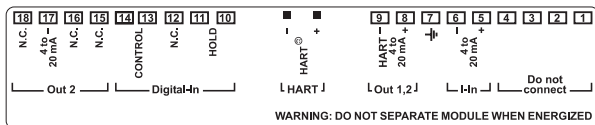

Fig.: Terminal assignments of M420

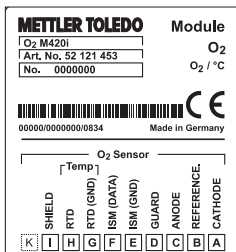

Fig.: M420 O₂ sensor input terminal assignments

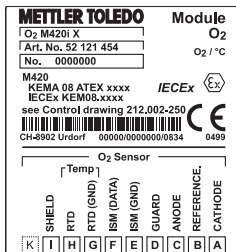

Fig.: M420 O₂ X sensor input terminal assignments

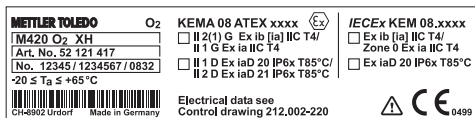
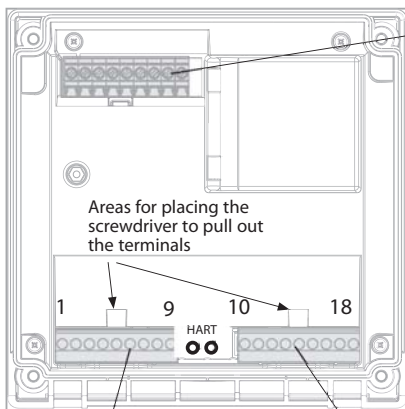

Fig.: M420 O₂ XH rating plate (outside at bottom of front)



Fig.: M420 O₂ H rating plate (outside at bottom of front)

Wiring of M420 O₂Sensor connection
O₂ input

A	cathode
B	reference
C	anode
D	guard
E	ISM DGND
F	ISM data
G	RTD (GND)
H	RTD
I	

Terminal row 1

1	Do not connect!
2	Do not connect!
3	Do not connect!
4	Do not connect!
5	+ input
6	- input
7	PA (equip. bonding)
8	+ out1,2/HART
9	- out1/HART

Terminal row 2

10	hold
11	hold
12	n.c.
13	contr
14	contr
15	n.c.
16	n.c.
17	- out 2
18	n.c.

In addition:

2 HART pins (between terminal row 1 and 2)

Fig.: Terminals, device opened, back of front unit

Wiring Examples

Example 1:

Measuring task: Oxygen (STANDARD)

Sensors (example): "10" (e.g. InPro 6800)

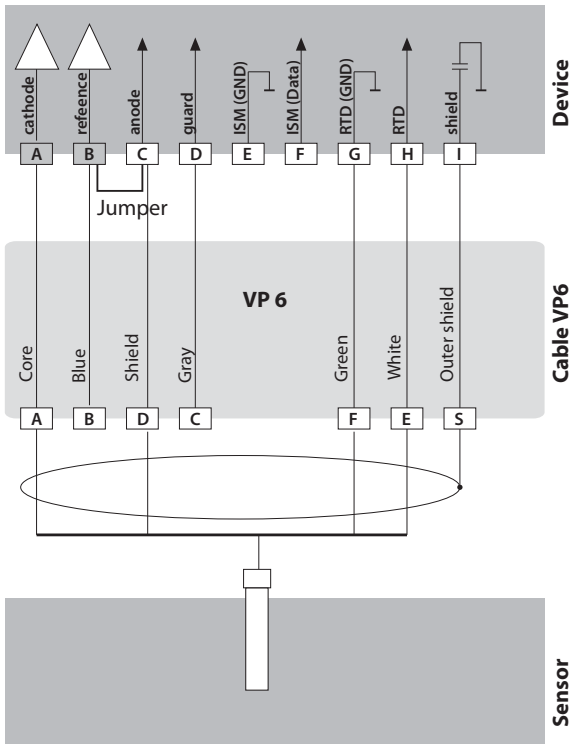

Wiring Examples

Example 2:

Measuring task: Oxygen (TRACES)

Sensors (example): "01" (e.g. InPro 6900)

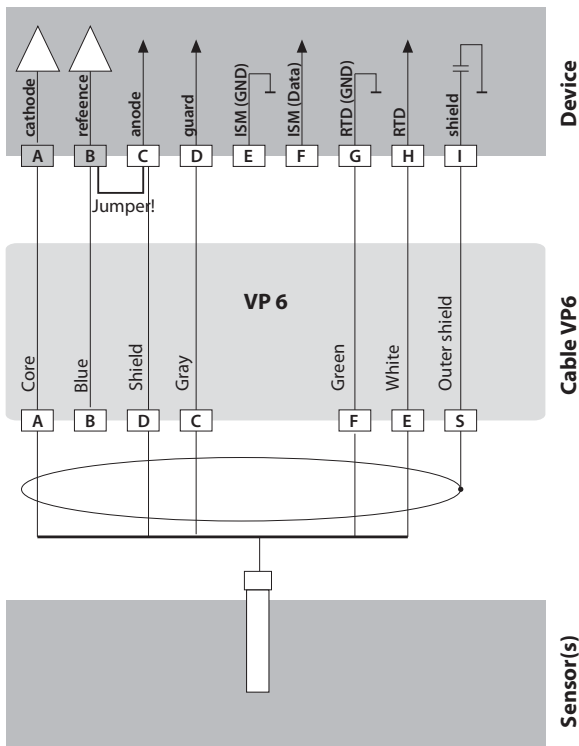

Example 3:

Measuring task: Oxygen (SUBTRACES)

Sensors (example): "001" (e.g. InPro 6950)

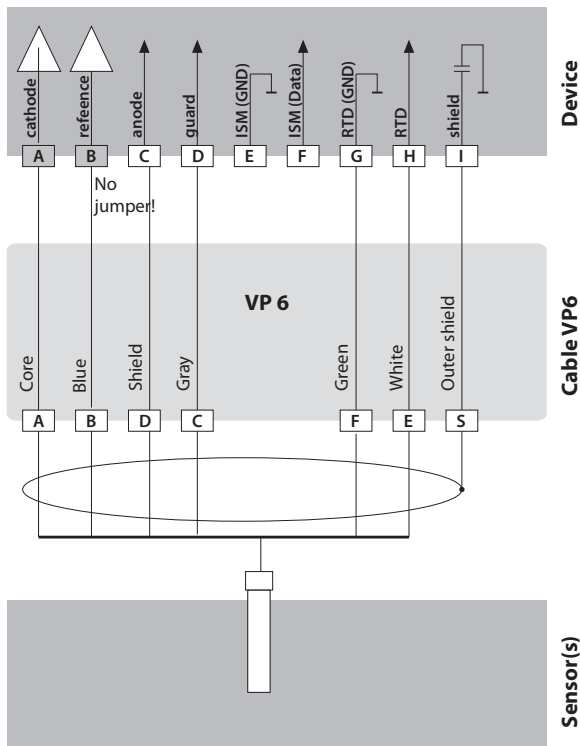

User Interface, Keypad

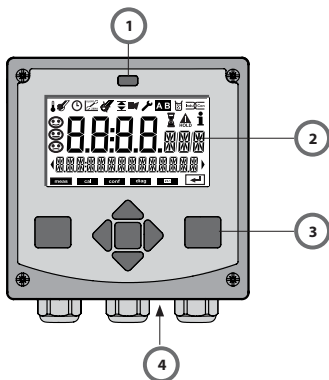

- 1 IrDA transmitter/receiver
- 2 Display
- 3 Keypad
- 4 Rating plate (bottom)

Key	Function
meas	<ul style="list-style-type: none">• Return to last menu level• Directly to measuring mode (press > 2 s)
info	<ul style="list-style-type: none">• Retrieve information• Show error messages
enter	<ul style="list-style-type: none">• Configuration: Confirm entries, next configuration step• Calibration: Continue program flow• Measuring mode: Display output current
Arrow keys up / down	<ul style="list-style-type: none">• Measuring mode: Call menu• Menu: Increase/decrease a numeral• Menu: Selection
Arrow keys left / right	<ul style="list-style-type: none">• Measuring mode: Call menu• Menu: Previous/next menu group• Number entry: Move between digits

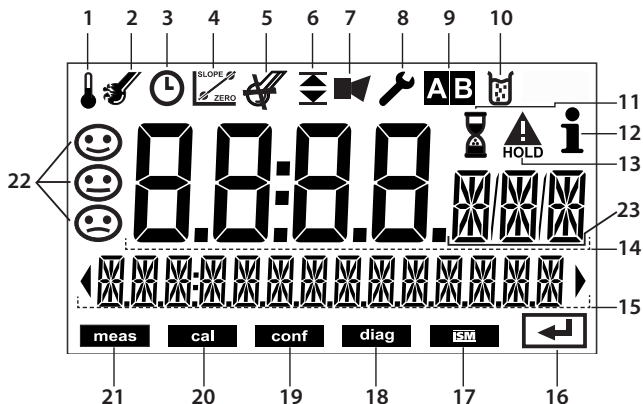

- | | |
|-----------------------------|-----------------------|
| 1 Temperature | 13 HOLD mode active |
| 2 Sensocheck | 14 Main display |
| 3 Interval/response time | 15 Secondary display |
| 4 Sensor data | 16 Proceed with enter |
| 5 Digital sensor devaluated | 17 Digital sensor |
| 6 Limit values | 18 Diagnostics |
| 7 Alarm | 19 Configuration mode |
| 8 Service | 20 Calibration mode |
| 9 Parameter sets A/B | 21 Measuring mode |
| 10 Calibration | 22 Sensoface |
| 11 Waiting time running | 23 Measurement symbol |
| 12 Info available | |

Measuring Mode

After the operating voltage has been connected, the device automatically goes to “Measuring” mode. To call the measuring mode from another operating mode (e.g. Diagnostics, Service): Hold **meas** key depressed (> 2 s).

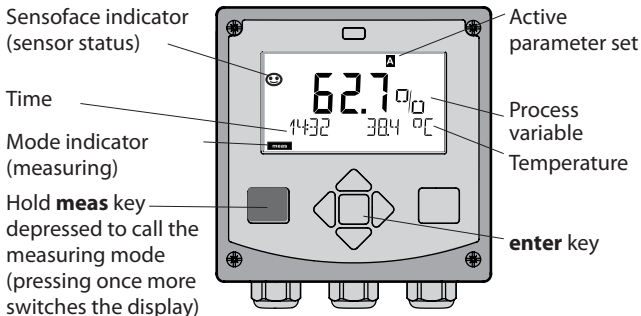

In measuring mode the display indicates:

- Measured value and time (24/12 h AM/PM) as well as temperature in °C or °F (formats selected during configuration)

By pressing the **meas** key in measuring mode you can view the following displays (for approx. 60 sec):

- Measured value and selection of parameter set A/B (if set to “Manual”)
- Measured value and tag (point of measurement designation – entered during configuration)
- Time and date

Pressing the **enter** key shows the output currents. They are displayed as long as **enter** is held depressed, then the measured-value display will return after 3 sec.



The device must be configured for the respective measurement task!

Selecting the Mode / Entering Values

To select the operating mode:

- 1) Hold **meas** key depressed (> 2 s) (measuring mode)
- 2) Press any arrow key: the selection menu appears
- 3) Select operating mode using left / right arrow key
- 4) Press **enter** to confirm the selected mode

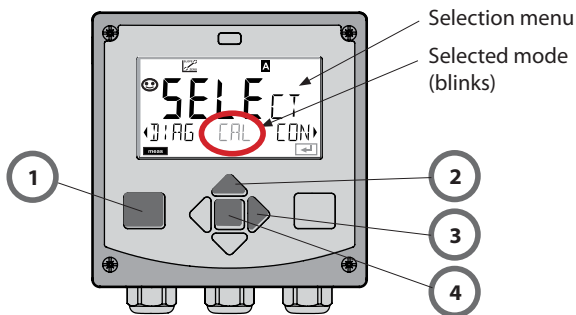

To enter a value:

- 5) Select numeral: left / right arrow key
- 6) Change numeral: up / down arrow key
- 7) Confirm entry with **enter**

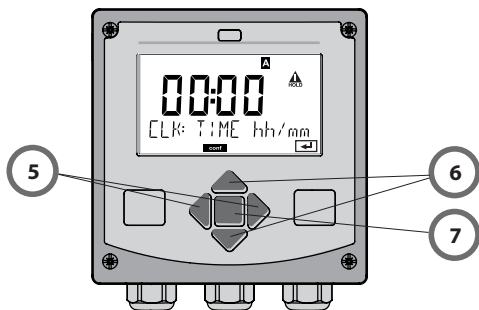

Operating Modes

Diagnostics

Display of calibration data, display of sensor data, performing a device self-test, viewing the logbook entries, display of hardware/software versions of the individual components. The logbook can store 100 events (00...99). They can be displayed directly on the device. The logbook can be extended to 200 entries using a TAN (Option).

HOLD

Manual activation of HOLD mode, e.g. for replacing a digital sensor. The signal outputs adopt a defined state.

Calibration

Every sensor has typical characteristic values, which change in the course of the operating time. Calibration is required to supply a correct measured value. The device checks which value the sensor delivers when measuring in a known solution. When there is a deviation, the device can be "adjusted". In that case, the device displays the "actual" value and internally corrects the measurement error of the sensor. Calibration must be repeated at regular intervals. The time between the calibration cycles depends on the load on the sensor. During calibration the device is in HOLD mode.

During calibration the analyzer remains in the HOLD mode until it is stopped by the operator.

Configuration

The analyzer must be configured for the respective measurement task. In the "Configuration" mode you select the connected sensor, the measurement range to be transmitted, and the conditions for warning and alarm messages. During configuration the device is in HOLD mode.

Configuration mode is automatically exited 20 minutes after the last keystroke. The device returns to measuring mode.

Service

Maintenance functions (monitor, current source), IrDA operation, passcode assignment, reset to factory settings, enabling of options (TAN).

Menu Structure of Modes and Functions



Pressing any arrow key opens the selection menu.
 Select the menu group using the left/right arrow keys.
 Press **enter** to open a menu. Press **meas** to return.

DIAG	CALDATA	Display of calibration data
	SENSOR	Display of sensor data
	SELFTEST	Self test: RAM, ROM, EEPROM, module
	LOGBOOK	Logbook: 100 events with date and time
	MONITOR	Display of direct, uncorrected sensor signals
	VERSION	Display of software version, model designation, serial number
HOLD	Manual activation of HOLD mode, e.g. for sensor replacement. The signal outputs behave as configured (e.g. last measured value, 21 mA)	
CAL	WTR / AIR	Calibration in water/air (as configured)
	ZERO	Zero adjustment
	P_CAL	Product calibration
	CAL_RTD	Adjustment of temperature probe
CONF	PARSET A	Configuring parameter set A
	PARSET B	Configuring parameter set B
SERVICE (Access via code, factory setting: 5555)	MONITOR	Display of measured values for verification
	OUT1	Current source, output 1
	OUT2	Current source, output 2
	IRDA	Activating the IrDA interface
	CODES	Specifying access codes for operating modes
	DEFAULT	Reset to factory setting
	OPTION	Enabling an option via TAN

HOLD Mode

The HOLD mode is a safety state during configuration and calibration. Output current is frozen (Last) or set to a fixed value (Fix).

HOLD mode, display icon:



Output Signal Response

- **Last:** The output current is frozen at its last value. Recommended for short configuration procedures. The process should not change decisively during configuration. Changes are not noticed with this setting!
- **Fix:** The output current is set to a value that is noticeably different from the process value to signal the control system that the device is being worked at.

Output Signal During HOLD:

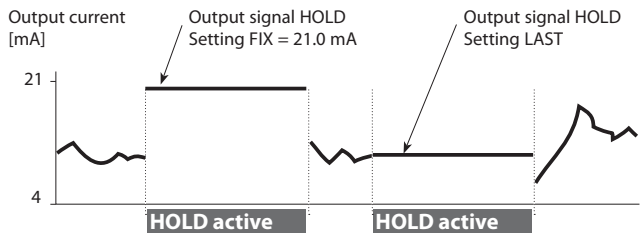

Terminating the HOLD Mode

The HOLD mode is ended by switching to measuring mode (hold **meas** key depressed). The display reads "Good Bye", after that, the HOLD mode is exited.

When the calibration mode is exited, a confirmation prompt ensures that the installation is ready for operation (e.g.: sensor reinstalled, located in process).

External Activation of HOLD

The HOLD mode can be activated from outside by sending a signal to the Hold input (e.g. from the process control system).

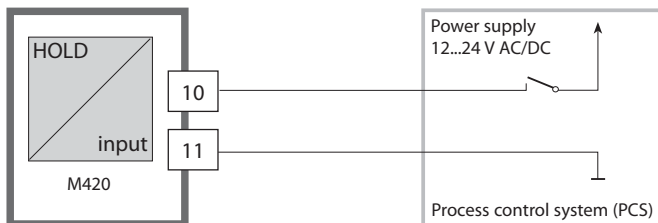

HOLD inactive	0...2 V AC/DC
HOLD active	10...30 V AC/DC

Manual Activation of HOLD

The HOLD can be activated manually from the HOLD menu. This allows checking or replacing a sensor, for example, without provoking unintended reactions of outputs or contacts. Press **meas** key to return to selection menu.

Alarm

When an error has occurred, **Err xx** is displayed immediately. Only after expiry of a user-defined delay time will the alarm be registered and entered in the logbook. During an alarm the display blinks.

Error messages can also be signaled by a 22 mA output current (see Configuration). 2 sec after the failure event is corrected, the alarm status will be deleted.

Configuration

Menu Structure of Configuration

The device provides 2 parameter sets "A" and "B". By switching between the parameter sets you can adapt the device to different measurement situations, for example.

Parameter set "B" only permits setting of process-related parameters. The configuration steps are assigned to different menu groups.

Using ◀ and ▶, you can jump between the individual menu groups. Each menu group contains menu items for setting the parameters.

Pressing **enter** opens a menu item.

The values are edited using ▲ and ▼.

Pressing **enter** confirms/stores the settings.

Return to measurement: Press **meas**.

Select menu group	Menu group	Code	Display	Select menu item
	Sensor selection	SNS:		
		Menu item 1		
		⋮		
		Menu item ...		
▶	Current output 1	OT1:		
▶	Current output 2	OT2:		
▶	Compensation	COR:		
▶	Alarm mode	ALA:		
▶	Setting the clock	CLK:		
▶	Tag number	TAG:		

Parameter Set A/B: Configurable Menu Groups



(Some parameters are identical in A and B. They are configured in parameter set A only.)

Menu group	Parameter set A	Parameter set B
SENSOR	Sensor selection	---
OUT1	Current output 1	Current output 1
OUT2	Current output 2	Current output 2
CORRECTION	Compensation	Compensation
ALARM	Alarm mode	Alarm mode
PARSET	Parameter set selection	---
CLOCK	Setting the clock	---
TAG	Tag number	---

Configuration

Parameter Set A/B

Manual selection

Display	Action	Remark
	To switch between parameter sets: Press meas	Manual selection of parameter sets must have been preset in CONFIG mode. Default setting is a fixed parameter set A. Wrong settings change the measurement properties!
	PARSET blinks in the lower line. Select parameter set using ◀ and ▶ keys	
	Select PARSET A / PARSET B	
	Confirm with enter Cancel with meas	

Configuration		Choices	Default
Sensor (SENSOR)			
SNS:	MEAS MODE	DO % DO mg/l DO ppm GAS %	DO %
	(Select text line)	STANDARD 10 Typ TRACES 01 Typ SUBTRACES 001 T. (requires "Traces" Option) ISM-DIGITAL	STANDARD 10 Typ
	U-POL	-400...-1000 mV (0000...-1000 mV for traces)	-675 mV
	MEMBR. COMP.	00.50...05.00	01.00
	RTD TYPE	22 NTC 30 NTC	22 NTC
	TEMP UNIT	°C / °F	°C
	CAL MODE	CAL AIR CAL WTR	CAL AIR
	CAL TIMER	ON/OFF	OFF
ON	CAL-CYCLE	0...9999 h	0168 h
ISM*	CIP COUNT	ON/OFF	OFF
	ON CIP CYCLES	0...9999 CYC	0000 CYC
	SIP COUNT	ON/OFF	OFF
	ON SIP CYCLES	0...9999 CYC	0000 CYC

*) For ISM® sensors only

Configuration

Configuration		Choices	Default	
Output 1 (OUT1, no trace measurement)				
OT1:	CHANNEL		OXY/TMP	OXY
	OXY DO %	BEGIN 4mA (0 mA)	000.0...600.0 %	000.0 %
		END 20 mA	0.000...600.0 %	600.0 %
	OXY DO mg/l	BEGIN 4mA (0 mA)	00.00...99.99 mg/l	00.00 mg/l
		END 20 mA	00.00...99.99 mg/l	99.99 mg/l
	OXY DO ppm	BEGIN 4mA (0 mA)	00.00...99.99 ppm	00.00 ppm
		END 20 mA	00.00...99.99 ppm	99.99 ppm
	OXY GAS %	BEGIN 4mA (0 mA)	00.00...99.99 %	00.00 %
		END 20 mA	00.00...99.99 %	99.99 %
	TMP °C	BEGIN 4mA (0 mA)	-20...150 °C	000.0 °C
		END 20 mA	-20...150 °C	100.0 °C
	TMP °F	BEGIN 4mA (0 mA)	-4...302 °F	0032 °F
		END 20 mA	-4...302 °F	0212 °F
	FILTERTIME		0...120 SEC	0000 SEC
	22mA-FAIL		ON/OFF	OFF
	HOLD MODE		LAST/FIX	LAST
	FIX	HOLD-FIX	(0) 4...22 mA	021.0 mA

Configuration		Choices	Default	
Output 1 (OUT1, trace measurement, sensor type 01)				
OT1:	CHANNEL		OXY/TMP	OXY
	OXY DO %	BEGIN 4mA (0 mA)	000.0...600.0 %	000.0 %
		END 20 mA	000.0...600.0 %	600.0 %
	OXY DO mg/l	BEGIN 4mA (0 mA)	000.0...99.00 mg/l	00.00 mg/l
		END 20 mA	000.0...99.00 mg/l	99.99 mg/l
	OXY DO ppm	BEGIN 4mA (0 mA)	00.00...99.99 ppm	00.00 ppm
		END 20 mA	00.00...99.99 ppm	99.99 ppm
	OXY GAS %	BEGIN 4mA (0 mA)	0000 ppm... 50.00 %	0000 ppm
		END 20 mA	0000 ppm... 50.00 %	50.00 %
	TMP °C	BEGIN 4mA (0 mA)	-20...150 °C	000.0 °C
		END 20 mA	-20...150 °C	100.0 °C
	TMP °F	BEGIN 4mA (0 mA)	-4...302 °F	0032 °F
		END 20 mA	-4...302 °F	0212 °F
	FILTERTIME		0...120 SEC	0000 SEC
	22mA-FAIL		ON/OFF	OFF
	HOLD MODE		LAST/FIX	LAST
	FIX	HOLD-FIX	(0) 4...22 mA	021.0 mA

Configuration

Configuration		Choices	Default	
Output 1 (OUT1, trace measurement, sensor type 001)				
OT1:	CHANNEL		OXY/TMP	OXY
	OXY DO %	BEGIN 4mA (0 mA)	000.0...150.0 %	000.0 %
		END 20 mA	000.0...150.0 %	150.0 %
	OXY DO mg/l	BEGIN 4mA (0 mA)	000.0 µg... 20.00 mg/l	00.00 µg/l
		END 20 mA	000.0 µg... 20.00 mg/l	20.00 mg/l
	OXY DO ppm	BEGIN 4mA (0 mA)	00.00 ppb... 20.00 ppm	00.00 ppb
		END 20 mA	00.00 ppb... 20.00 ppm	20.00 ppm
	OXY GAS %	BEGIN 4mA (0 mA)	0000 ppb...50 %	0000 ppb
		END 20 mA	0000 ppb...50 %	50.00 %
	TMP °C	BEGIN 4mA (0 mA)	-20...150 °C	000.0 °C
		END 20 mA	-20...150 °C	100.0 °C
	TMP °F	BEGIN 4mA (0 mA)	-4...302 °F	0032 °F
		END 20 mA	-4...302 °F	0212 °F
	FILTERTIME		0...120 SEC	0000 SEC
	22mA-FAIL		ON/OFF	OFF
	HOLD MODE		LAST/FIX	LAST
	FIX	HOLD-FIX	(0) 4...22 mA	021.0 mA

Configuration		Choices	Default		
Output 2 (OUT2)					
OT2:	CHANNEL	OXY/TMP	TMP		
	... other steps like output 1				
Temperature compensation (CORRECTION)					
COR:	SALINITY		00.00...45.00 ppt	00.00 ppt	
	PRESSURE UNIT		BAR/kPa/PSI	BAR	
	PRESSURE		MAN/EXT *		
	MAN	BAR	0.000...9.999 BAR	1.013 BAR	
		kPa	000.0...999.9 kPa	100 kPa	
		PSI	000.0...145.0 PSI	14.5 PSI	
	EXT	I-Input		OFF/4(0)...20 mA	4...20 mA
		BAR	BEGIN 4mA (0 mA)	0.000...9.999 BAR	0.000 BAR
			END 20 mA	0.000...9.999 BAR	9.999 BAR
		kPa	BEGIN 4mA (0 mA)	000.0...999.9 kPa	000.0 kPa
			END 20 mA	000.0...999.9 kPa	999.9 kPa
		PSI	BEGIN 4mA (0 mA)	000.0...145.0 PSI	000.0 PSI
	END 20 mA		000.0...145.0 PSI	145.0 PSI	
	Alarm (ALARM)				
ALA:	DELAYTIME	0...600 SEC	0010 SEC		
	SENSOCHECK	ON/OFF	OFF		

* EXT with external I input option only

Configuration

Configuration		Choices	Default
Parameter set (PARSET)			
PAR:	Select fixed parameter set (A) or switch between A/B via control input or manually in measuring mode	PARSET FIX / CNTR INPUT / MANUAL	PARSET FIX A (fixed parameter set A)
Real-time clock (CLOCK)			
CLK:	FORMAT	24 h / 12 h	
	24 h	TIME hh/mm 00..24:00...59	00:00
	12 h	TIME hh/mm 00...12 AM/PM: 00...59	00.00
	DAY/MONTH	01...31/01...12	31.12.
	YEAR	2000...2099	2006
Tag number (TAG)			
TAG:	(Input in text line)		XXXXXXXXXX

Configuration (Original for Copy)

Default Settings of Parameter Sets

Two complete parameter sets are stored in the EEPROM.
As delivered, the two sets are identical but can be edited.

Please note:

Fill in your configuration data on the following pages or use them as original for copy.

Configuration (Original for Copy)

Parameter	Parameter set A	Parameter set B
SNS: Measuring mode		--- *)
SNS: Sensor type		--- *)
SNS: V polarization		--- *)
SNS: MEMBR. COMP.		--- *)
SNS: RTD type		--- *)
SNS: Temperature unit		--- *)
SNS: Calibration mode		--- *)
SNS: Calibration timer		--- *)
SNS: Calibration cycle		--- *)
SNS: CIP counter		--- *)
SNS: CIP cycles		--- *)
SNS: SIP counter		--- *)
SNS: SIP cycles		--- *)
OT1: Process variable		
OT1: Current start		
OT1: Current end		
OT1: Filter time		
OT1: 22 mA error current		
OT1: HOLD mode		
OT1: HOLD-FIX current		

*) These parameters cannot be adjusted in parameter set B, the values are the same as in parameter set A.

(Original for Copy) Configuration

Parameter	Parameter set A	Parameter set B
OT2: Process variable		
OT2: Current start		
OT2: Current end		
OT2: Filter time		
OT2: 22 mA error current		
OT2: HOLD mode		
OT2: HOLD-FIX current		
COR: Salinity (ppt)		
COR: Pressure unit (BAR, kPa, PSI)		
COR: Pressure (MAN/EXT)		
COR: Ext. current input (Option)		
ALA: Delay		
ALA: Sensocheck on/off		
PAR: Parameter set selection		--- *)
CLK: Time format		--- *)
CLK: Time hh/mm		--- *)
CLK: Day/month		--- *)
CLK: Year		--- *)
TAG: Tag number		--- *)

*) These parameters cannot be adjusted in parameter set B, the values are the same as in parameter set A.

Configuration

Sensor

Select: Measuring mode, sensor type analog/digital, polarization voltage, membrane compensation, temp probe type



enter



enter

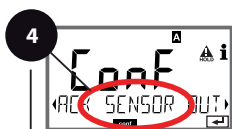

enter

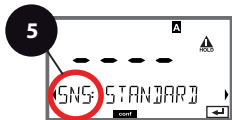





meas

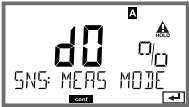

- 1 Press any arrow key.
- 2 Select **CONF** using ◀ ▶ keys, press **enter**.
- 3 Select parameter set using ◀ ▶, press **enter**.
- 4 Select **SENSOR** menu using ◀ ▶ keys, press **enter**.
- 5 All items of this menu group are indicated by the "SNS:" code.
Press **enter** to select menu, edit with arrow keys (see next page). Confirm (and proceed) with **enter**.
- 6 End: Press **meas** key until the [meas] mode indicator is displayed.

5

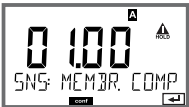
Select measuring mode	enter
Select sensor type	enter
Polarization voltage	enter
Membrane compensation	
Type of temp probe	
Temperature unit	
Medium: water/air	
Calibration timer	
Cleaning cycle counter	
Cleaning cycles	
Sterilization cycle counter	
Sterilization cycles	

Menu item	Action	Choices
Select measuring mode 	Select measuring mode using \blacktriangle \blacktriangledown keys. DO: Measurement in liquids GAS: Measurement in gases Confirm with enter	DO % , DO mg/l DO ppm GAS %
Select sensor type analog/digital 	Select sensor type using \blacktriangle \blacktriangledown keys. Confirm with enter	STANDARD 10 Typ TRACES 01 Typ SUBTRACES 001 Typ ISM
Polarization voltage 	Enter V_{pol} using \blacktriangle \blacktriangledown \blacktriangleleft \blacktriangleright keys. Confirm with enter	-675 mV -400...-1000 mV (0000...-1000 mV for trace measurement)
Membrane compensation 	(not for ISM® sensors) Enter membrane compensation using \blacktriangle \blacktriangledown \blacktriangleleft \blacktriangleright keys. Confirm with enter	01.00 00.50...05.00
Type of temp probe 	(not for ISM® sensors) Select type of temperature probe using \blacktriangle \blacktriangledown keys. Confirm with enter	22 NTC 30 NTC

Configuration

Sensor



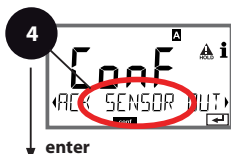

Select: Temperature unit, medium: water/air, calibration timer

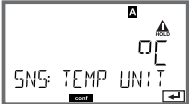

- 1 Press any arrow key.
- 2 Select **CONF** using ◀ ▶ keys, press **enter**.
- 3 Select parameter set using ◀ ▶, press **enter**.
- 4 Select **SENSOR** menu using ◀ ▶ keys, press **enter**.
- 5 All items of this menu group are indicated by the "SNS:" code. Press **enter** to select menu, edit with arrow keys (see next page). Confirm (and proceed) with **enter**.
- 6 End: Press **meas** key until the [meas] mode indicator is displayed.

5

Select measuring mode	enter
Select sensor type	enter
Polarization voltage	enter
Membrane compensation	
Type of temp probe	
Temperature unit	
Calibration medium water/air	
Calibration timer	
Cleaning cycle counter	
Cleaning cycles	
Sterilization cycle counter	
Sterilization cycles	

Menu item	Action	Choices
Temperature unit 	Select temperature unit using ▲ ▼ keys. Confirm with enter	°C °F
Medium: air/water 	Select calibration medium using ▲ ▼ keys. AIR: Cal medium air WTR: Cal medium water Confirm with enter	CAL_AIR CAL_WTR
Calibration timer 	Select/deselect calibration timer using ▲ ▼ keys. Confirm with enter	OFF ON
(ON: Calibration cycle) 	Enter calibration cycle in hours using ▲ ▼ ◀ ▶ keys. Confirm with enter	0..9999 h 0168 h

Configuration

Sensor

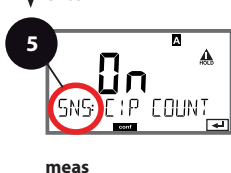
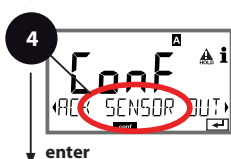

Adjust: CIP cleaning cycles, SIP sterilization cycles



- 1 Press any arrow key.
- 2 Select **CONF** using ◀ ▶ keys, press **enter**.
- 3 Select parameter set using ◀ ▶, press **enter**.
- 4 Select **SENSOR** menu using ◀ ▶ keys, press **enter**.
- 5 All items of this menu group are indicated by the "SNS:" code.
Press **enter** to select menu, edit with arrow keys (see next page). Confirm (and proceed) with **enter**.
- 6 End: Press **meas** key until the [meas] mode indicator is displayed.





5

Select measuring mode	enter
Select sensor type	enter
Polarization voltage	enter
Membrane compensation	
Type of temp probe	
Temperature unit	
Medium: water/air	
Calibration timer	
Cleaning cycle counter	
Cleaning cycles	
Sterilization cycle counter	
Sterilization cycles	

Menu item	Action	Choices
CIP counter 	Adjust CIP counter using ▲ ▼ keys: OFF: No counter ON: Fixed cleaning cycle (adjust in the next step) Confirm with enter	OFF/ON
CIP cycles 	Only with CIP COUNT ON: Enter max. number of cleaning cycles using ▲ ▼ ◀ ▶ keys. Confirm with enter	0...9999 CYC (0000 CYC)
SIP counter 	Adjust SIP counter using ▲ ▼ keys: OFF: No counter ON: Max. sterilization cycles (adjust as for CIP counter) Confirm with enter	OFF/ON

Note for the calibration timer:

When Sensocheck has been activated in the Configuration > Alarm menu, the expiration of the calibration interval is indicated by Sensoface:

Display	Status
 + 	Over 80% of the calibration interval has already past.
 + 	The calibration interval has been exceeded.

The calibration timer settings apply to both parameter sets A and B. The time remaining until the next due calibration can be seen in the diagnostics menu (see "Diagnostics").

Configuration

Current Output 1

Process variable, current start, current end



enter



enter



enter





meas



- 1 Press any arrow key.
- 2 Select **CONF** using ◀ ▶ keys, press **enter**.
- 3 Select parameter set using ◀ ▶, press **enter**.
- 4 Select **OUT1** menu using ◀ ▶ keys, press **enter**.
- 5 All items of this menu group are indicated by the "OT1:" code.
Press **enter** to select menu, edit with arrow keys (see next page). Confirm (and proceed) with **enter**.
- 6 End: Press **meas** key until the [meas] mode indicator is displayed.

5

Process variable	enter
Current start	enter
Current end	enter
Time constant of output filter	
Output current during error message	
Output current during HOLD	
Output current for HOLD FIX	

Menu item	Action	Choices
Process variable 	Select using \blacktriangle \blacktriangledown keys: OXY: O ₂ value TMP: Temperature Confirm with enter	OXY /TMP
Current start 	Modify digit using \blacktriangle \blacktriangledown , select next digit using \blacktriangleleft \blacktriangleright keys. Confirm with enter	000.0...0600% (OXY, Sensor 10) 0.000...0150% (OXY, Sensor 01, 001 and traces Option) -20...150 °C / -4...302 °F (TMP)
Current end 	Enter value using \blacktriangle \blacktriangledown \blacktriangleleft \blacktriangleright keys. Confirm with enter	000.0...0600% (OXY, Sensor 10) 0.000...0150% (OXY, Sensor 01, 001 and traces Option) -20...150 °C / -4...302 °F (TMP)

For **process variables comprising several decades**, decimal point and dimension can be shifted using the \blacktriangleleft \blacktriangleright cursor keys. Then, the desired number is entered using \blacktriangle \blacktriangledown and \blacktriangleleft \blacktriangleright . For measurement in gases (GAS), this method is used to switch between ppm and % for volume concentration (10000 ppm = 1 %).

Assignment of Measured Values: Current Start and Current End

Example 1: Range 0...100%

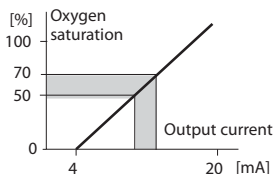

Example 2: Range 50...70%
 Advantage: Higher resolution in
 range of interest

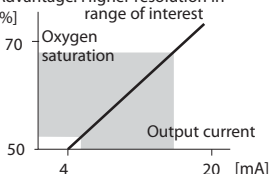

Configuration

Current Output 1

Adjust time constant of output filter

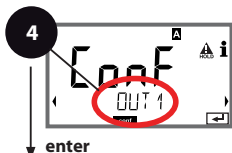

- 1 Press any arrow key.
- 2 Select **CONF** using ◀ ▶ keys, press **enter**.
- 3 Select parameter set using ◀ ▶, press **enter**.
- 4 Select **OUT1** menu using ◀ ▶ keys, press **enter**.
- 5 All items of this menu group are indicated by the "OT1:" code. Press **enter** to select menu, edit with arrow keys (see next page). Confirm (and proceed) with **enter**.
- 6 End: Press **meas** key until the [meas] mode indicator is displayed.

5

Process variable	enter
Current start	enter
Current end	enter
Time constant of output filter	
Output current during error message	
Output current during HOLD	
Output current for HOLD FIX	

Menu item	Action	Choices
Time constant of output filter	Enter value using ▲ ▼ ◀ ▶ keys.	0...120 SEC (0000 SEC)
		Confirm with enter

Time Constant of Output Filter

To smoothen the current output, a low-pass filter with adjustable filter time constant can be switched on. When there is a jump at the input (100 %), the output level is at 63 % after the time constant has been reached. The time constant can be set from 0 to 120 sec. If the time constant is set to 0 sec, the current output directly follows the input.

Please note:

The filter only acts on the current output, not on the display!
During HOLD the filter is not applied. This prevents a jump at the output.

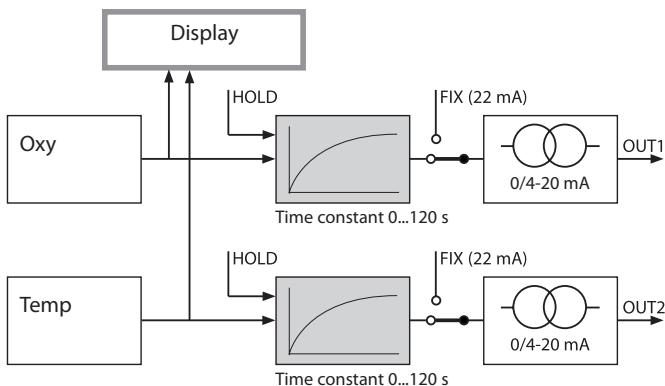

Configuration

Current Output 1

Output current during Error and HOLD



enter



enter



enter





meas

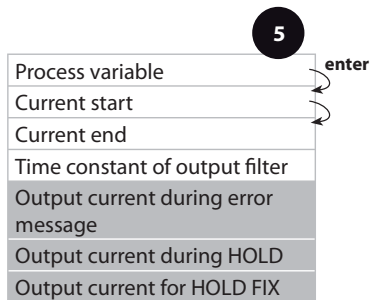

- 1 Press any arrow key.
- 2 Select **CONF** using ◀ ▶ keys, press **enter**.
- 3 Select parameter set using ◀ ▶, press **enter**.
- 4 Select **OUT1** menu using ◀ ▶ keys, press **enter**.
- 5 All items of this menu group are indicated by the "OT1:" code.
Press **enter** to select menu, edit with arrow keys (see next page). Confirm (and proceed) with **enter**.
- 6 End: Press **meas** key until the [meas] mode indicator is displayed.

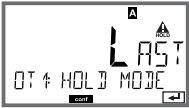

Menu item	Action	Choices
Output current during error message 	Select ON (22 mA for error message) or OFF using \blacktriangle \blacktriangledown keys. Confirm with enter	ON/OFF
Output current during HOLD 	LAST: During HOLD the last measured value is maintained at the output. FIX: During HOLD a value (to be entered) is maintained at the output. Select using \blacktriangle \blacktriangledown keys. Confirm with enter	LAST/FIX
Output current for HOLD FIX 	Only with FIX selected: Enter current which is to flow at the output during HOLD. Enter value using \blacktriangle \blacktriangledown \blacktriangleleft \blacktriangleright keys. Confirm with enter	00.00...22.00 mA 21.00 mA

Output Signal During HOLD:

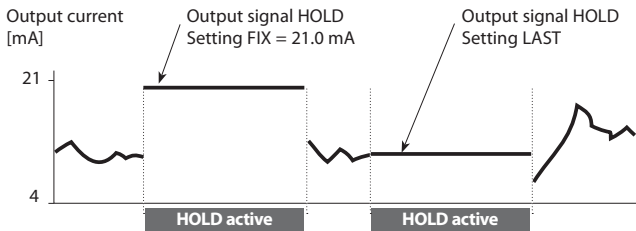

Configuration

Current Output 2

Current start. Current end.

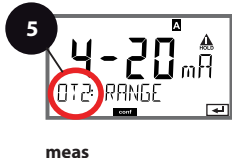

- 1 Press any arrow key.
- 2 Select **CONF** using ◀ ▶ keys, press **enter**.
- 3 Select parameter set using ◀ ▶, press **enter**.
- 4 Select **OUT2** menu using ◀ ▶ keys, press **enter**.
- 5 All items of this menu group are indicated by the "OT2:" code. Press **enter** to select menu, edit with arrow keys (see next page). Confirm (and proceed) with **enter**.
- 6 End: Press **meas** key until the [meas] mode indicator is displayed.

5

Process variable	enter
Current start	↻
Current end	↻
Time constant of output filter	
Output current during error message	
Output current during HOLD	
Output current for HOLD FIX	

Menu item	Action	Choices
Process variable 	Select using ▲ ▼ keys: OXY: O ₂ value TMP: Temperature Confirm with enter	OXY/TMP
<ul style="list-style-type: none"> • • • 		

All the following adjustments are made as for current output 1 (see there)!

Correction

Salinity correction. Pressure correction. Current input



enter



enter



enter



meas



- 1 Press any arrow key.
- 2 Select **CONF** using ◀ ▶ keys, press **enter**.
- 3 Select parameter set using ◀ ▶, press **enter**.
- 4 Select **CORRECTION** menu using ◀ ▶ keys, press **enter**.
- 5 All items of this menu group are indicated by the "COR:" code. Press **enter** to select menu, edit with arrow keys (see next page). Confirm (and proceed) with **enter**.
- 6 End: Press **meas** key until the [meas] mode indicator is displayed.

5

Salinity

Pressure unit





Pressure correction

Manual pressure input

Current input

Current range/Pressure range

enter

Menu item	Action	Choices
Enter salinity 	Enter salinity of the process medium. Enter value using \blacktriangle \blacktriangledown \blacktriangleleft \blacktriangleright keys. Confirm with enter	00.00...45.00 ppt
Enter pressure unit 	Select desired pressure unit using \blacktriangle \blacktriangledown keys. Confirm with enter	Bar /kPa/PSI
Enter pressure correction 	Select desired procedure for pressure correction using \blacktriangle \blacktriangledown keys: MAN: Manual specification EXT: Ext. pressure correction via current input Confirm with enter	MAN / EXT
(Manual pressure input) 	Enter value using \blacktriangle \blacktriangledown \blacktriangleleft \blacktriangleright keys. Confirm with enter	Input range: 0.000...9.999 BAR / 000.0...999.9 kPa / 000.0...145.0 PSI 1.013 BAR / 100 kPa / 14.5 PSI
Current input/ Pressure range 	For external pressure detection, enter 0(4) ... 20 mA current input and current start / end values for pressure parameter using \blacktriangle \blacktriangledown \blacktriangleleft \blacktriangleright keys.	0(4)...20 mA 0.000...9.999 Bar / 000.0...999.9 kPa / 000.0...9990.9 PSI

Configuration

Alarm

Alarm delay. Sensocheck



enter



enter



enter



meas





- 1 Press any arrow key.
- 2 Select **CONF** using ◀ ▶ keys, press **enter**.
- 3 Select parameter set using ◀ ▶, press **enter**.
- 4 Select **ALARM** menu using ◀ ▶ keys, press **enter**.
- 5 All items of this menu group are indicated by the "ALA:" code. Press **enter** to select menu, edit with arrow keys (see next page). Confirm (and proceed) with **enter**.
- 6 End: Press **meas** key until the [meas] mode indicator is displayed.

Delay

Sensocheck

5

enter

Menu item	Action	Choices
Alarm delay	Enter alarm delay using ▲ ▼ ◀ ▶ keys. Confirm with enter	0...600 SEC (010 SEC)
		
Sensocheck	Select Sensocheck (continuous monitoring of sensor membrane and lines). Select ON or OFF using ▲ ▼ keys. Confirm with enter . (At the same time, Sensoface is activated. With OFF, Sensoface is also switched off.)	ON/OFF
		

Error messages can be signaled by a 22 mA output current (see Error Messages and Configuration of Output 1/Output 2).

The alarm delay time delays the 22 mA signal (if configured).

Configuration

Time and Date Tag Number

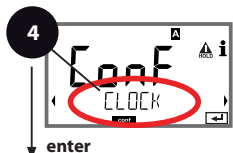

- 1 Press any arrow key.
- 2 Select **CONF** using ◀ ▶ keys, press **enter**.
- 3 Select parameter set A using ◀ ▶ keys, press **enter**.
- 4 Press **enter**.
- 5 Select **CLOCK** or **TAG** using ◀ ▶ keys, press **enter**.
- 6 All items of this menu group are indicated by the "CLK:" or "TAG" code. Press **enter** to select menu, edit with arrow keys (see next page). Confirm (and proceed) with **enter**.
- 7 End: Press **meas** key until the [meas] mode indicator is displayed.

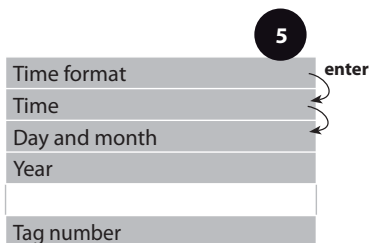

Time and Date

Control of the calibration and cleaning cycles is based on the time and date of the integrated real-time clock.

In measuring mode the time is shown in the lower display.

When using digital sensors, the calibration data is written in the sensor head.

In addition, the logbook entries (cf Diagnostics) are provided with a time stamp.

Please note:

There is no automatic switchover from winter to summer time!

Be sure to manually adjust the time!

Tag Number ("TAG")

You can enter a designation for the point of measurement (tag number) in the lower display line. Up to 32 digits are possible.

Pressing **meas** (repeatedly) in the measuring mode indicates the tag number.

Being part of the device configuration, the "TAG" can be read out via IrDA.

A standardized tag number helps, for example, to correctly re-install a device after repair.

5

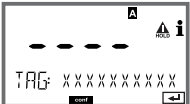
Menu item	Action	Choices
Tag number 	Select character using ▲ ▼ keys, select next digit using ◀ ▶ keys. Confirm with enter	A...Z, 0...9, - + < > ? / @ The first 10 characters are seen in the display with- out scrolling.

ISM® Sensors

Operation

M420 can be operated with ISM® sensors.

The following display examples refer to an M420 pH transmitter and a pH ISM® sensor (slight variations for other combinations).

The sensor type is selected during **configuration**, the selected type is indicated by a display icon:



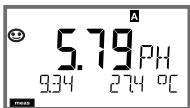

The device only switches to measuring mode when the connected sensor corresponds to the type configured (Sensoface is happy):

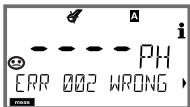

Otherwise, an error message is released. The **info** icon is displayed. You can display the error text in the bottom line using the ◀ ▶ keys. Sensoface is sad (see table of error messages and Sensoface in the Appendix):



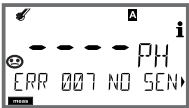

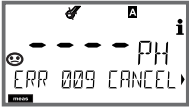
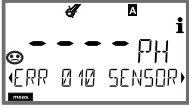
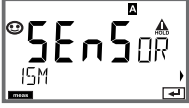
Connecting a Digital Sensor

Step	Action/Display	Remark
Connect sensor		Before a digital sensor is connected, the error message "No sensor" is displayed.
Wait until the sensor data are displayed.		The hourglass in the display blinks.
(Sensor devaluated) Replace sensor		When this error message appears, the sensor cannot be used any more. Sensoface is sad.
(Sensor defective) Replace sensor		When this error message appears, the sensor cannot be used. Sensoface is sad.
Check sensor data	 <p data-bbox="397 1089 643 1188">View sensor information using ◀ ▶ keys, confirm with enter.</p>	The ISM icon is displayed. Sensoface is happy.
Go to measuring mode	Press meas , info , or enter	After 60 sec the device automatically returns to measuring mode (timeout).

Sensor Replacement

An ISM® sensor should only be replaced during HOLD mode to prevent unintended reactions of the outputs or contacts. When you first want to calibrate the new sensor, it can also be replaced in calibration mode.

Step	Action/Display	Remark
Select HOLD mode	Press any key to call the selection menu, select HOLD using the ◀ ▶ keys, confirm with enter .	Now the device is in HOLD mode. The HOLD mode can also be activated externally via the HOLD input. During HOLD the output current is frozen at its last value or set to a fixed value.
Disconnect and remove old sensor		
Install and connect new sensor.		Temporary messages which are activated during the replacement are indicated but not output to the alarm contact and not entered in the log-book.
Wait until the sensor data are displayed.		

Step	Action/Display	Remark
Check sensor data	 <p data-bbox="397 346 643 438">View sensor information using ◀ ▶ keys, confirm with enter.</p>	You can view the sensor manufacturer and type, serial number, and last calibration date.
Check measured values		
Exit HOLD	Hit meas key: Return to selection menu. Hold meas key depressed: Device switches to measuring mode	The sensor replacement is entered in the extended logbook.

Calibrating a Digital Sensor

After calibration of a digital sensor the calibration and statistics data are written into the sensor. During this time the display indicates "STORING DATA". This process takes approx. 5 to 10 sec.

Do not remove the sensor during this process!

Calibration

Calibration adapts the device to the individual sensor characteristics. It is always recommended to calibrate in air.

Compared to water, air is a calibration medium which is easy to handle, stable, and thus safe. In the most cases, however, the sensor must be dismantled for a calibration in air.

When dealing with biotechnological processes which require sterile conditions, the sensor cannot be removed for calibration. Here, calibration must be performed with aeration directly in the process medium (e.g. after sterilization).

In the field of biotechnology, for example, often saturation is measured and calibration is performed in the medium for reasons of sterility.

For other applications where concentration is measured (water control etc.), calibration in air has proved to be useful.

Please note:

- All calibration procedures must be performed by trained personnel. Incorrectly set parameters may go unnoticed, but change the measuring properties.
- If a 2-point calibration is prescribed, the zero calibration should be performed prior to slope calibration.

Common Combination:

Process Variable / Calibration Mode / Calibration Medium

Process variable	Cal mode	Calibration	Default rel. humidity	Default cal pressure
Saturation (%)	SAT	Water	100 %	Process pressure
Concentration (mg/l, ppm)	Conc	Air	50 %	1.013 bar

The calibration procedures for these two common applications are described on the following pages. Of course, other combinations of process variable and calibration mode are possible.

Selecting a Calibration Mode

Calibration is used to adapt the device to the individual sensor characteristics, namely asymmetry potential and slope.

Access to calibration can be protected with a passcode (SERVICE menu).

First, you open the calibration menu and select the calibration mode:

WTR / AIR	Calibration in water/air (as configured)
ZERO	Zero adjustment
P_CAL	Product calibration (calibration with sampling)
CAL-RTD	Temperature probe adjustment

Zero Calibration







The InPro6900 sensors and have a very low zero current. Therefore, a zero calibration is only recommended for measurement of oxygen traces.

When a zero calibration is performed, the sensor should remain for at least 10 to 30 minutes in the calibration medium in order to obtain stable, non-drifting values.

During zero calibration, a drift check is not performed. Zero current of a properly functioning sensor is notably less than 0.5 % of air current. The display (bottom: measured value, top: entered value) does not change until an input current is entered for the zero point.

When measuring in an oxygen-free medium, the displayed current can be taken directly.

Zero Calibration

Display	Action	Remark
	Select calibration, proceed with enter	
	Ready for calibration. Hourglass blinks. Place sensor in oxygen-free medium	Display (3 sec) Now the device is in HOLD mode.
	Main display: Zero current. Press enter to save this value or correct using arrow keys and then save with enter . Secondary display: Sensor current measured	
	Display of slope Display of new zero current. End calibration with enter key, place sensor in process	Sensoface display
	The oxygen value is shown in the main display, "enter" blinks. Stop Hold with enter .	New calibration: Select REPEAT, press enter key.
	Quit with enter .	After end of calibration, the outputs remain in HOLD mode for a short time.

Product Calibration

Calibration with Sampling

During product calibration the sensor remains in the process.

The measurement process is only interrupted briefly.



Procedure: During sampling the currently measured value is stored in the device.

The device immediately returns to measuring mode.







The cal mode indicator blinks and reminds you that calibration has not been terminated. The comparison value is measured on the site, e.g. using a portable DO meter in a bypass.

This value is then entered in the device. The new value for slope or zero is calculated from the stored value and the comparison value. From the measured value, the device automatically recognizes whether a new slope or zero must be calculated (above approx. 5 % saturation: slope, below: zero).

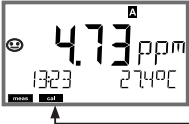
If the sample is invalid, you can take over the measured value stored during sampling instead of the comparison value. In that case the old calibration values remain stored. Afterwards, you can start a new product calibration. The following describes a product calibration with slope correction – a product calibration with zero correction is performed correspondingly.







Display	Action	Remark
	Select calibration, then product calibration P_CAL. Proceed with enter	
	Ready for calibration. Hourglass blinks.	Display (3 sec) Now the device is in HOLD mode.
	Take sample and save value. Proceed with enter	Now the sample can be measured. If the value is already available, press info+enter to proceed to step 2.

Product Calibration







Display	Action	Remark
	The device returns to measuring mode.	From the blinking CAL mode indicator you see that product calibration has not been terminated.
	Product calibration step 2 : When the sample value has been determined, open the product calibration once more.	Display (3 sec) Now the device is in HOLD mode.
	The stored value is displayed (blinking) and can be overwritten with the lab value. Proceed with enter	
	Display of new slope and zero. Sensoface is active. Proceed with enter	Related to 25 °C and 1013 mbars
	Display of new oxy value. Sensoface is active. To end calibration: Select MEAS, then enter	To repeat calibration: Select REPEAT, then enter
	End of calibration	After end of calibration, the outputs remain in HOLD mode for a short time.

Slope Calibration (Medium: Air)





(air-saturated)





Display	Action	Remark
	Select calibration (SLOPE). Immerse sensor in cal medium, start with enter	"Medium water" or "Medium air" is selected in the configuration.
	Enter cal pressure Proceed with enter	Default: 1.000 bar Unit bar/kpa/PSI
	Drift check: Display of: Sensor current (nA) Response time (s) Temperature (°C/°F)	Device goes to HOLD mode. The drift check might take some time.
	Display of calibration data (slope and zero) and Sensoface Proceed with enter	Related to 25 °C and 1013 mbars
	Display of selected process value. To end calibration: Select MEAS using ◀ ▶, then enter	To repeat calibration: Select REPEAT using ◀ ▶, then enter
	Place sensor in process. End of calibration	After end of calibration, the outputs remain in HOLD mode for a short time.

Slope Calibration (Medium: Air)

Display	Action	Remark
	Select calibration. Place sensor in air, start with enter Device goes to HOLD mode.	“Medium water” or “Medium air” is selected in the configuration.
	Enter relative humidity using arrow keys Proceed with enter	Default for relative humidity in air: rH = 50%
	Enter cal pressure using arrow keys Proceed with enter	Default: 1.000 bar Unit bar/kpa/PSI
	Drift check: Display of: Sensor current (nA) Response time (s) Temperature (°C/°F) Proceed with enter	The drift check can take some minutes.
	Display of calibration data (slope and zero). Proceed with enter .	
	Display of selected process variable (here: %vol). Now the device is in HOLD mode: Reinstall the sensor and check whether the message is OK. MEAS ends calibration, REPEAT permits repetition.	After end of calibration, the outputs remain in HOLD mode for a short time.

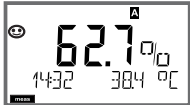
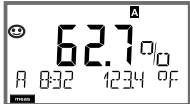
Temp Probe Adjustment

Display	Action	Remark
 The display shows 'CAL' in large characters at the top. Below it, 'CAL RTD' is visible. There are navigation arrows on the left and right sides.	Select temp adjustment. Proceed with enter	Wrong settings change the measurement properties!
 The display shows 'CAL' at the top, followed by 'TEMP ADJUST' in smaller characters. A warning triangle icon is in the top right corner.	Measure the temperature of the process medium using an external thermometer.	Display (3 sec) Now the device is in HOLD mode.
 The display shows '25.0' in large characters with a degree Celsius symbol. Below it, 'ADJUST' and '235°C' are visible. A warning triangle icon is in the top right corner.	Enter the measured temperature value. Maximum difference: 10 K. Proceed with enter	Display of actual temperature (uncompensated) in the lower display.
 The display shows '25.0' in large characters with a degree Celsius symbol. Below it, 'MEAS' is visible. A smiley face icon is in the top left corner, and a warning triangle icon is in the top right corner.	The corrected temperature value is displayed. Sensoface is active. To end calibration: Select MEAS, then enter To repeat calibration: Select REPEAT, then enter	After end of calibration, the outputs remain in HOLD mode for a short time.
 The display shows '20.93' in large characters with a degree Celsius symbol. Below it, 'GOOD BYE' is visible. A smiley face icon is in the top left corner, and a warning triangle icon is in the top right corner.	After calibration is ended, the device will switch to measuring mode.	

Display	Remark
	<p>From the configuration or calibration menus, you can switch the device to measuring mode by pressing the meas key.</p> <p>(Waiting time for signal stabilization approx. 20 sec).</p> <p>In the measuring mode the main display shows the configured process variable (Oxy [%] or temperature), the secondary display shows the time and the second configured process variable (Oxy [%] or temperature). The [meas] mode indicator lights and the active parameter set (A/B) is indicated.</p>
<p>or AM/PM and °F:</p>	
	
<p>Pressing the enter key briefly shows the output currents.</p> <p>By pressing the meas key you can step through the following displays. When no key has been pressed for 60 sec, the device returns to the standard display.</p>	
	<p>1) Selecting the parameter set (if set to "manual" in the configuration). Select the desired parameter set using the ◀ ▶ arrow keys (PARSET A or PARSET B blinks in the lower display line). Confirm with enter.</p>
	<p>Further displays (each with meas).</p>
	<p>2) Display of tag number ("TAG") 3) Display of time and date</p>

Diagnostics

In the Diagnostics mode you can access the following menus without interrupting the measurement:







CALDATA	Viewing the calibration data
SENSOR	Viewing the sensor data
SELFTEST	Starting a device self-test
LOGBOOK	Viewing the logbook entries
MONITOR	Displaying currently measured values
VERSION	Displaying device type, software version, serial number

Access to diagnostics can be protected with a passcode (SERVICE menu).





Please note:





HOLD is not active during Diagnostics mode!





Action	Key	Remark
Activate diagnostics		Press any arrow key to call the selection menu. Select DIAG using ◀ ▶ keys, confirm with enter
Select diagnostics option		Use ◀ ▶ keys to select from: CALDATA SENSOR SELFTEST LOGBOOK MONITOR VERSION See next pages for further proceeding.
End	meas	End with meas .

Display	Menu item
	<p>Display of calibration data</p> <p>Select CALDATA using \leftarrow \rightarrow, confirm with enter. Use the \leftarrow \rightarrow keys to select the desired parameter from the bottom line of the display (LAST_CAL ZERO SLOPE NEXT_CAL). The selected parameter is shown in the main display.</p>
	
	
	
	
	<p>Press meas to return to measurement.</p>
	<p>Display of sensor data</p> <p>For analog sensors, the type is displayed, for digital sensors, the manufacturer, type, serial number, and last calibration date. In each case Sensoface is active.</p>
	<p>Display data using \leftarrow \rightarrow keys, return with enter or meas.</p>

Diagnostics

Display	Menu item
	Device self-test (To abort, you can press meas) 1 Display test: Display of all segments. Proceed with enter
	2 RAM test: Hourglass blinks, then display of --PASS-- or --FAIL-- Proceed with enter
	3 EEPROM test: Hourglass blinks, then display of --PASS-- or --FAIL-- Proceed with enter
	4 FLASH test: Hourglass blinks, then display of --PASS-- or --FAIL-- Proceed with enter
	5 Module test: Hourglass blinks, then display of --PASS-- or --FAIL-- Press enter or meas to return to measuring mode.

Display	Menu item
	<p>Display of logbook entries Select LOGBOOK using ◀ ▶, confirm with enter.</p> <p>With the ▲ ▼ keys, you can scroll backwards and forwards through the logbook (entries -00-...-99-), -00- being the last entry.</p>
	<p>If the display is set to date/time, you can search for a particular date using the ▲ ▼ keys. Press ◀ ▶ to view the corresponding message text.</p>
	<p>If the display is set to the message text, you can search for a particular message using the ▲ ▼ keys. Press ◀ ▶ to display the date and time.</p>
	<p>Press meas to return to measurement.</p> <p>Extended logbook / Audit Trail (via TAN) With the ▲ ▼ keys, you can scroll backwards and forwards through the extended logbook (entries -000-...-199-), -000- being the last entry.</p> <p>Display: CFR Audit Trail also records function activations (CAL CONFIG SERVICE), some Sensoface messages (cal timer, wear), and opening of the enclosure.</p>



Display	Menu item
 <p>Display examples:</p>   	<p>Display of currently measured values (sensor monitor)</p> <p>Select MONITOR using ◀ ▶, confirm with enter. Use the ◀ ▶ keys to select the desired parameter from the bottom line of the display: OXY, RTD, I-INPUT (for digital sensors also: OPERATION TIME SENSOR WEAR LIFETIME CIP SIP AUTOCLAVE). The selected parameter is shown in the main display. Press meas to return to measurement.</p> <p>Display of directly measured value (for validation, sensor can be immersed in a calibration solution, for example, or the device is checked by using a simulator)</p> <p>Display of remaining lifetime (for digital sensors only) The “Dynamic Lifetime Indicator”, DLI, calculates the expected remaining sensor lifetime based on the sensor load.</p> <p>Display of sensor operating time (for digital sensors only)</p>
	<p>Version</p> <p>Display of device type, software/hardware version, and serial number for all device components.</p> <p>Use the ▲ ▼ keys to switch between software and hardware version. Press enter to proceed to next device component.</p>

The Service mode allows



- displaying the currently measured values with the sensor monitor
- performing a device self-test
- testing the two current outputs
- activating and communicating via the IrDA interface
- assigning and editing passcodes
- resetting the device to factory settings
- enabling options via TAN.

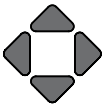

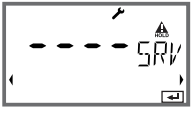

Please note:

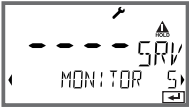
HOLD is active during Service mode!



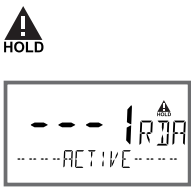































Action	Key/Display	Remark
Activate Service		Press any arrow key to call the selection menu. Select SERVICE using ◀ ▶ keys, confirm with enter
Passcode		Enter passcode "5555" for service mode using the ▲ ▼ ◀ ▶ keys. Confirm with enter .
Display		In service mode the following icons are displayed: <ul style="list-style-type: none"> • [diag] mode indicator • HOLD triangle • Service (wrench)
End	meas	End with meas .

Service

Menu item	Remark
 <p>Display example:</p> 	<p>Display of currently measured values (sensor monitor) with HOLD mode activated: Select MONITOR using ◀ ▶, confirm with enter. Select variable in the bottom text line using ◀ ▶.</p> <p>The selected parameter is shown in the main display. As the device is in HOLD mode, you can perform validations using simulators without influencing the signal outputs.</p> <p>Press meas to return to the service menu. Return to measurement: Press meas once more.</p>
	<p>Specify current at outputs 1 and 2: Select OUT1 or OUT2 using the ◀ ▶ keys, confirm with enter. Enter a valid current value for the respective output using ▲ ▼ ◀ ▶ keys. Confirm with enter. For checking purposes, the actual output current is shown in the bottom right corner of the display. End with enter or meas.</p>

Menu item	Remark
	<p>IrDA communication: Select IRDA using ◀ ▶, confirm with enter.</p>
	<p>When IrDA communication is active, the device remains in the HOLD mode for reasons of safety. Further operation is performed via IrDA.</p> <p>End communication with meas.</p> <p>Exception: Firmware update (must not be interrupted!)</p>
	<p>Assigning passcodes: In the "SERVICE - CODES" menu you can assign passcodes to DIAG, HOLD, CAL, CONF, and SERVICE modes (Service preset to 5555).</p> <p>When you have lost the Service passcode, you have to request an "Ambulance TAN" from the manufacturer specifying the serial number of your device. To enter the "Ambulance TAN", call the Service function and enter passcode 7321. After correct input of the ambulance TAN the device signals "PASS" for 4 sec and resets the Service passcode to 5555.</p>
	<p>Reset to factory settings: In the "SERVICE - DEFAULT" menu you can reset the device to factory settings. Not affected: calibration data</p>
	<p>Release of options: Options come with a "transaction number" (TAN). This TAN must be entered and confirmed with enter to release the option.</p>

Operating States

Operating status	OUT 1	OUT 2	Time out
Measuring			-
DIAG			60 s
CAL_ZERO Zero point			No
CAL_SLOPE Slope			No
P_CAL Product calibration S1			No
P_CAL Product calibration S2			No
CAL_RTD Temp adjustment			No
CONF_A ParSet A			20 min
CONF_B ParSet B			20 min
SERVICE MONITOR			20 min
SERVICE OUT 1			20 min
SERVICE OUT 2			20 min
SERVICE IRDA			20 min
SERVICE CODES			20 min
SERVICE DEFAULT			20 min
SERVICE OPTION			20 min
HOLD input			No

Explanation:  as configured (Last/Fix or Last/Off)

 active  manual

Product Line and Accessories

M420

Designation		Article Number
M420 pH H		52121405
M420 pH H OUT2	with 2nd current output	52121406
M420 pH XH		52121407
M420 pH XH OUT2	with 2nd current output	52121408
<hr/>		
M420 O2 H		52121415
M420 O2 H OUT2	with 2nd current output	52121416
M420 O2 XH		52121417
M420 O2 XH OUT2	with 2nd current output	52121418
<hr/>		
M420 Cond H		52121425
M420 Cond H OUT2	with 2nd current output	52121426
M420 Cond XH		52121427
M420 Cond XH OUT2	with 2nd current output	52121428
<hr/>		
M420 Cond Ind H		52121435
M420 Cond Ind H OUT2	with 2nd current output	52121436
M420 Cond Ind XH		52121437
M420 Cond Ind XH OUT2	with 2nd current output	52121438

TAN options

Logbook	SW-420-002	52121466
Extended logbook (Audit Trail)	SW-420-003	52121467
Trace oxygen measurement	SW-420-004	52121468
Current input + 2 digital inputs	SW-420-005	52121469

Mounting accessories

Pipe-mount kit		52120741
Protective hood		52121470
Panel-mount kit		52121471

M420: Supply Units and Connection

Recommended Power Supply Units: Order No.:

Repeater power supply, IS, 24 V AC/DC, output 0/4...20 mA	52120688 WG 20 A2 Power Supply
Repeater power supply, IS, 90...253 V AC, output 4...20 mA	52121689 WG 21 A7 Power Supply
Repeater power supply, IS, 90...253 V AC, HART, output 4...20 mA	52120704 WG 21 A7 Opt. 470
Repeater power supply, IS, 24 V AC/DC, output 4...20 mA	52129772 WG 21 A7 Opt. 336
Repeater power supply, IS, 24 V AC/DC, HART, output 4...20 mA	52120774 WG 21 A7 Opt. 336, 470

Option 336: 24 V AC/DC power supply

Option 470: for transmission of HART protocol

Connection to Supply Units

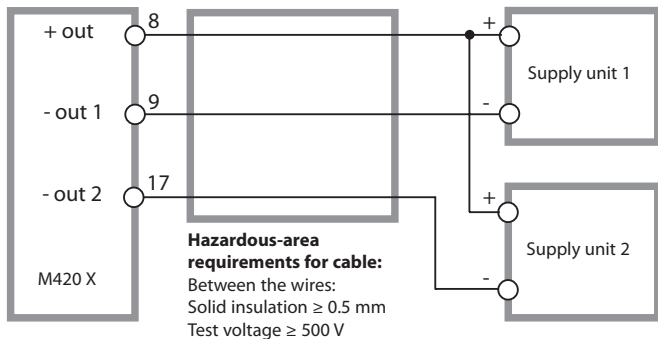

Standard device

Sensors: InPro 6800

Input range Measuring current 0 ... 600 nA Resolution 10 pA

Measurement error < 0.5% meas. val. + 0.05 nA + 0.005 nA/K

Operating modes
GAS Measurement in gases
DO Measurement in liquids

Display range
Saturation (-10 ... 80°C) 0.0 ... 600.0 %
Concentration (-10 ... 80°C) 0.00 ... 99.99 mg/l
(Dissolved oxygen) 0.00 ... 99.99 ppm
Volume concentration in gas 0.00 ... 99.99 %vol

Polarization voltage
-400 ... -1000 mV
Default -675 mV (resolution < 5 mV)

Permitted guard current $\leq 20 \mu\text{A}$

Trace device

Sensors: InPro 6800/6900/6950

Input range I¹⁾ Measuring current 0 ... 600 nA Resolution 10 pA

Measurement error < 0.5% meas. val. + 0.05 nA + 0.005 nA/K

Input range II¹⁾ Meas. current 0 ... 10000 nA Resolution 166 pA

Measurement error < 0.5% meas. val. + 0.8 nA + 0.08 nA/K

Operating modes
GAS Measurement in gases
DO Measurement in liquids

Specifications

Ranges with standard sensors "10"

Saturation (-10 ... 80°C)	0.0 ... 600.0 %
Concentration (-10 ... 80°C)	0.00 ... 99.99 mg/l
(Dissolved oxygen)	0.00 ... 99.99 ppm
Volume concentration in gas	0,00 ... 99.99 %vol

Ranges with trace sensors "01"

Saturation (-10 ... 80°C)	0.000 ... 150.0 %
Concentration (-10 ... 80°C)	0000 ... 9999 µg/l / 10.00 ... 20.00 mg/l
(Dissolved oxygen)	0000 ... 9999 ppb / 10.00 ... 20.00 ppm
Volume concentration in gas	0000 ... 9999 ppm / 1.000 ... 50.00 %vol

Ranges with trace sensors "001"

Saturation (-10 ... 80°C)	0.000 ... 150.0 %
Concentration (-10 ... 80°C)	000.0 ... 9999 µg/l / 10.00 ... 20.00 mg/l
(Dissolved oxygen)	000,0 ... 9999 ppb / 10.00 ... 20.00 ppm
Volume concentration in gas	000.0 ... 9999 ppm / 1.000 ... 50.00 %vol

Polarization voltage

0 ... -1000 mV
Default -675 mV (resolution < 5 mV)

Permitted guard current

≤ 20 µA

Input correction

Pressure correction *	0.000...9.999 bars / 999.9 kPa / 145.0 psi manually or through current input 0(4) ... 20 mA
Salinity correction	0.0 ... 45.0 g/kg

Sensor standardization *

Operating modes *

AIR Automatic calibration in air
WTR Automatic calibration in air-saturated water
Product calibration
Zero calibration

Calibration range

Zero point ± 2 nA

Standard sensor "10"

Slope 25 ... 130 nA (at 25°C, 1013 mbars)

Calibration range	Zero point	± 2 nA
Standard sensor "01"	Slope	200 ... 550 nA (at 25°C, 1013 mbars)
Calibration range	Zero point	± 3 nA
Standard sensor "001"	Slope	2000 ... 9000 nA (at 25°C, 1013 mbars)
Calibration timer *	Interval	0000 ... 9999 h
Pressure correction *	Manual	0.000 ... 9.999 bars / 999.9 kPa / 145.0 psi
Sensocheck	Monitoring of membrane and electrolyte and the sensor wires for short circuits or open circuits (can be disabled)	
Delay	Approx. 30 s	
Sensoface	Provides information on the sensor condition, evaluation of zero/slope, response time, calibration interval, Sensocheck (for digital sensors also wear), can be switched off	
Temperature input	NTC 22 k Ω / NTC 30 k Ω * 2-wire connection, adjustable	
Measuring range	-20.0 ... +150.0 °C / -4 ... +302 °F	
Adjustment range	10 K	
Resolution	0.1 °C / 0,1 °F	
Measurement error ^{2,3,4)}	< 0.5 K (< 1 K at > 100°C)	
ISM input	"One wire" interface for operation with ISM (digital sensors) (6 V / Ri= approx. 1.2 k Ω)	
I input	Current input 0/4 ... 20 mA / 50 Ω for external pressure compensation	
Start/end of scale	Configurable 0 ... 9.999 bars	
Characteristic	Linear	
Measurement error ^{2,4)}	< 1% current value + 0.1 mA	
HOLD input	Galvanically separated (OPTO coupler)	
Function	Switches device to HOLD mode	
Switching voltage	0 ... 2 V (AC/DC)	Inactive
	10 ... 30 V (AC/DC)	HOLD active

Specifications

CONTROL input	Galvanically separated (OPTO coupler)
Function	Selecting parameter set A/B
Switching voltage	0 ... 2 V (AC/DC) Parameter set A 10 ... 30 V (AC/DC) Parameter set B
Output 1	Current loop 4 ... 20 mA, floating, protected against inverse polarity, HART communication, supply voltage 14 ... 30 V
Process variable*	DO saturation /DO concentration / Temperature
Characteristic	Linear
Overrange*	22 mA in the case of error messages
Output filter*	PT ₁ filter, time constant 0 ... 120 s
Measurement error ³⁾	< 0,25 % current value + 0,025 mA
Start/end of scale*	Configurable within selected range
Minimum span	Standard: 5 % / 0.5 mg/l (ppm) / 2 %vol Traces: 2 % / 0.1 mg/l (ppm) / 100 ppm
Output 2	Current loop 4 ... 20 mA, floating, protected against inverse polarity
Process variable*	DO saturation /DO concentration / Temperature
Characteristic	Linear
Overrange*	22 mA in the case of error messages
Output filter*	PT ₁ filter, time constant 0 ... 120 s
Measurement error ^{2,3,4)}	< 0,25 % current value + 0,025 mA
Start/end of scale*	Configurable within selected range
Minimum span	Standard: 5 % / 0.5 mg/l (ppm) / 2 %vol Traces: 2 % / 0.1 mg/l (ppm) / 100 ppm
Real-time clock	Different time and date formats selectable
Power reserve	> 5 days

Display	LC display, 7-segment with icons
Main display	Character height approx. 22 mm, unit symbols approx. 14 mm
Secondary display	Character height approx. 10 mm
Text line	14 characters, 14 segments
Sensoface	3 status indicators (friendly, neutral, sad face)
Mode indicators	meas, cal, conf, diag Further icons for configuration and messages
Alarm indication	Alarm icon, display blinks
Keypad	Keys: meas, info, 4 cursor keys, enter
HART communication	Digital communication by FSK modulation of output current 1 Device identification, measured values, status and messages, parameter setting, calibration, records
IrDA interface	Infrared interface for service purposes
FDA 21 CFR Part 11	Access control by editable passcodes Logbook entry and flag via HART in the case of configuration changes Message and logbook entry when enclosure is opened
Diagnostics Functions	
Calibration data	Calibration date, zero, slope, response time
Device self-test	Displaytest, automatic memory test (RAM, FLASH, EEPROM), module test
Logbook	100 events with date and time
Extended logbook (TAN)	AuditTrail: 200 events with date and time

Specifications

Service functions

Sensor monitor	Display of direct, uncorrected sensor signal
Current source	Current specifiable for output 1 and 2 (00.00 ... 22.00 mA)
IrDA	Activating the IrDA function
Passcodes	Assigning passcodes for menu access
Factory setting	Resetting all parameters to factory setting Exception: calibration data
TAN	Enabling optionally available additional functions

Data retention	Parameters, calibration data, logbook > 10 years (EEPROM)
-----------------------	---

EMC	EN 61326
------------	----------

Emitted interference	Class B (residential area)
----------------------	----------------------------

Immunity to interference	Industry
--------------------------	----------

Explosion protection	USA: FM / CSA Cl I Div 2 (pending)
M420 X O ₂ X (see "Safety Instructions": "Explosion Protection")	Canada: CSA Cl I Div 2 (pending)
	IECEX KEMA 08.009
	KEMA 08 ATEX 0144

Nominal operating conditions

Ambient temperature	-20 ... +65 °C
Transport/Storage temperature	-20 ... +70 °C
Relative humidity	10 ... 95% not condensing
Supply voltage	14 ... 30 V

Enclosure	Molded enclosure made of PBT, glass reinforced
Fastening	Wall, pipe/post, or panel mounting
Color	Gray, RAL 7001
Ingress protection	IP 67
Flammability	UL 94 V-0
Dimensions	148 mm x 148 mm
Control panel cutout	138 mm x 138 mm to DIN 43 700
Weight	1.2 kg (1.6 kg incl. accessories and packaging)
Cable glands	3 knockouts for M20 x 1.5 cable glands 2 knockouts for NPT ½" or rigid metallic conduit
Connections	Terminals, conductor cross section max. 2.5 mm ²

* User-defined

- 1) Automatic range selection
- 2) Acc. to EN 60746-1, at nominal operating conditions
- 3) ± 1 count
- 4) Plus sensor error

Error Handling

Alarm Condition:

- The  alarm icon is displayed
- The complete measured-value display blinks
- “ERR xxx” is displayed in the lower menu line

Press the [info] key to view a short error text:

- The error text appears in the lower menu line
- The main display reads “InFo”.

Parameter Errors:

Configuration data such as current range, limit values, etc are checked during the input.

If they are out of range,

- “ERR xxx” is displayed for 3 sec,
- the respective maximum or minimum value is shown,
- input must be repeated

If a faulty parameter arrives through the interface (IrDA, HART),

- an error message will be displayed: “ERR 100...199”
- the faulty parameter can be localized by pressing the [info] key

Calibration Errors:

If errors occur during calibration, e.g. by using a wrong buffer,

- an error message will be displayed for 4 sec
- calibration will be restarted

Sensoface:

If the Sensoface becomes sad

- the cause can be seen by pressing the [info] key
- the calibration data can be seen in the Diagnostics menu

Error Messages

Error	Info text (is displayed in case of fault when the Info key is pressed)	Problem Possible causes
ERR 99	DEVICE FAILURE	Error in factory settings EEPROM or RAM defective This error message only occurs in the case of a total defect. The device must be repaired and recalibrated at the factory.
ERR 98	CONFIGURATION ERROR	Error in configuration or calibration data Memory error in device program Configuration or calibration data defective; completely reconfigure and recalibrate the device.
ERR 97	NO MODULE INSTALLED	No module Please have the module replaced in the factory.
ERR 96	WRONG MODULE	Wrong module Please have the module replaced in the factory.
ERR 95	SYSTEM ERROR	System error Restart required. If error still persists, send in the device for repair.
ERR 01	NO SENSOR	O₂ sensor * Sensor defective Sensor not connected Break in sensor cable
ERR 02	WRONG SENSOR	Wrong sensor *
ERR 03	CANCELED SENSOR	Sensor devaluated *

Error messages

Error	Info text (is displayed in case of fault when the Info key is pressed)	Problem Possible causes
ERR 04	SENSOR FAILURE	Failure in sensor *
ERR 05	CAL DATA	Error in cal data *
ERR 11	OXY RANGE	Display range violation SAT saturation CONC concentraton or GAS volume concentration
ERR 12	SENSOR CURRENT RANGE	Measuring range of sensor exceeded
ERR 13	TEMPERATURE RANGE	Temperature range violation
ERR 15	SENSOCHECK	Sensocheck
ERR 60	OUTPUT LOAD	Load error
ERR 61	OUTPUT 1 TOO LOW	Output current 1 < 0 (3.8) mA
ERR 62	OUTPUT 1 TOO HIGH	Output current 1 > 20.5 mA
ERR 63	OUTPUT 2 TOO LOW	Output current 2 < 0 (3.8) mA
ERR 64	OUTPUT 2 TOO HIGH	Output current 2 > 20.5 mA
ERR 69	TEMP. OUTSIDE TABLE	Temperature value outside table
ERR 100 ...255	VOID PARAMETER	Invalid parameter

* ISM® sensors

HART: Typical Applications

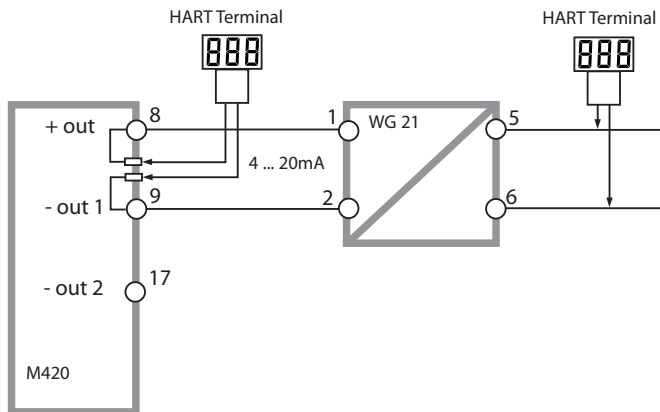
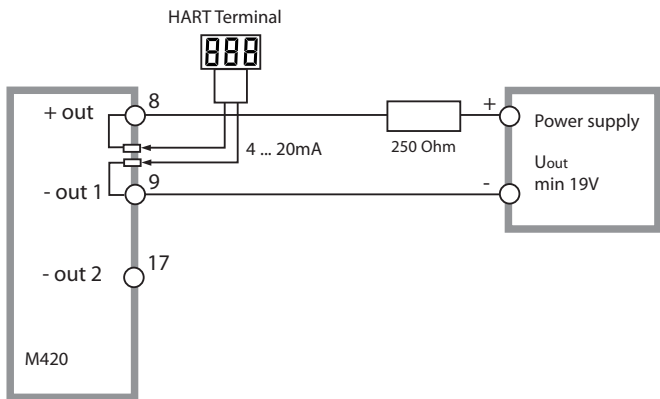

Sensoface

(Sensochek must have been activated during configuration.)



The smiley in the display (Sensoface) alerts to sensor problems (defective sensor, sensor wear, defective cable, maintenance request). The permitted calibration ranges and the conditions



for a friendly, neutral, or sad Sensoface are summarized in the



following table. Additional icons refer to the error cause.

Sensochek

Continuously monitors the sensor and its wiring.

Critical values make the Sensoface “sad” and the corresponding icon blinks:



The Sensochek message is also output as error message Err 15.

The alarm contact is active, output current 1 is set to 22 mA (when configured correspondingly).











Sensochek can be switched off during configuration (then Sensoface is also disabled).

Exception:



After a calibration a smiley is always displayed for confirmation.

Please note:

The worsening of a Sensoface criterion leads to the devaluation of the Sensoface indicator (Smiley becomes “sad”). An improvement of the Sensoface indicator can only take place after calibration or removal of the sensor defect.

Display	Problem	Status
	Zero and slope	 Zero and slope of the sensor are still okay. The sensor should be replaced soon.
		 Zero and/or slope of the sensor have reached values which no longer ensure proper calibration. Replace sensor.
	Calibration timer	 Over 80% of the calibration interval has already past.
		 The calibration interval has been exceeded.
	Sensor defect	 Check the sensor and its connections (see also Err 15, Error Messages).
	Response time	 Sensor response time has increased. The sensor should be replaced soon. To achieve an improvement, clean or wet the sensor.
		 Sensor response time significantly increased (> 600 s, calibration aborted after 720 s) Replace sensor.

Sensoface

Display	Problem	Status
	Sensor wear (for digital sensors only)	 Wear is over 80%. The sensor should be replaced soon.  Wear is at 100%. Replace sensor.

Conformity with FDA 21 CFR Part 11

In their directive “Title 21 Code of Federal Regulations, 21 CFR Part 11, Electronic Records; Electronic Signatures” the US American health agency FDA (Food and Drug Administration) regulates the production and processing of electronic documents for pharmaceutical development and production. This results in requirements for measuring devices used for corresponding applications. The following features ensure that the measuring devices of the M420 Series meet the demands of FDA 21 CFR Part 11:

Electronic Signature – Passcodes

Access to the device functions is regulated and limited by individually adjustable codes – “Passcodes” (see SERVICE). This prevents unauthorized modification of device settings or manipulation of the measurement results. Appropriate use of these passcodes makes them suitable as electronic signature.

Audit Trail

Every (manual) change of device settings can be automatically documented. Each change is tagged with a “Configuration Change Flag”, which can be interrogated and documented using HART communication. Altered device settings or parameters can also be retrieved and documented using HART communication.

Extended logbook

Audit Trail also records function activations (CAL, CONFIG, SERVICE), some Sensoface messages (cal timer, wear), and opening of the enclosure.

EC Declarations of Conformity

Mettler-Toledo AG

Process Analytics

Address Im Hookacker 15, CH-8902 Udorf, Switzerland
Mail address P.O. Box, CH-8902 Udorf, Switzerland
Phone +41-44-729 62 11
Fax +41-44-729 66 36
Bank Credit Suisse, 8070 Zurich, Clearing 4535
Account No. 370501-21-90 CH-FIBAN CH71 0463 5037 0501 2109 0

www.mtpro.com

EC Declaration of conformity EG-Konformitätserklärung EC Déclaration de Conformité



We
Wir
Nous

Mettler-Toledo AG, Process Analytics
Im Hookacker 15
8902 Udorf
Schweizland Schweiz Suisse

declare under our sole responsibility that the product,
erklären in alleiniger Verantwortung, dass dieses Produkt,
déclarons sous notre seule responsabilité que le produit,

Description
Beschreibung
Description

M420 Series / Serie / Série

to which this declaration relates is in conformity with the following standard(s) or other normative document(s),
auf welches sich diese Erklärung bezieht, mit dem/den folgenden Norm(en) oder Richtlinie(n)
übereinstimmt.
auquel se réfère cette déclaration est conforme à la (aux) norme(s) ou au(x) document(s) normatif(s).

EMC Directive
EMV-Richtlinie
CEM Directive

2004/108/EC
2004/108/EG
2004/108/CE

Low-voltage directive
Niederspannungs-Richtlinie
Directive basse tension

2006/95/EC
2006/95/EG
2006/95/CE

Standard
Norm
Norme

DIN EN 61010-1 / VDE 0411 Teil 1 : 2002-08
DIN EN 61326-1 / VDE 0843 Teil 20-1 : 2006-10
DIN EN 61326-2-3 / VDE 0843 Teil 20-2-3 : 2007-05

Mettler-Toledo AG, Process Analytics

Waldemar Rauch
General Manager PG Udorf

Thomas Hösl
Head of Operation and R&D

Place and Date of Issue
Ausstellungsart und Datum
Lieu et date d'émission

Udorf, 07.08.2008

This Original may not be copied, as subject to technical changes
Dieses Original darf nicht kopiert werden, da es dem Änderungsprozess unterliegt
Cet original ne doit pas être copié, sujet de changement technique

CE_M420_int.doc

METTLER TOLEDO

Mettler-Toledo AG

Process Analytics

Address Im Hackacker 15, CH-8902 Udorf, Switzerland
 Mail address P.O. Box, CH-8902 Udorf, Switzerland
 Phone +41-44-729 62 11
 Fax +41-44-729 66 36
 Bank Credit Suisse, 6070 Zurich, Clearing 4835
 Account No. 370501-21-90 CH-FIBAN CH71 0483 3037 0501 2109 0

www.mtpro.com

**EC Declaration of conformity
 EG-Konformitätserklärung
 EC Déclaration de Conformité**



We _____
Wir _____
Noos _____

Mettler-Toledo AG, Process Analytics
 Im Hackacker 15
 8902 Udorf
 Switzerland Schweiz Suisse

declares under our sole responsibility that the product,
 erklart in oller Verantwortung, dass dieses Produkt,
 dclare sous notre seule responsabilit que le produit,

Description
Beschreibung
Description _____

M420 X Series / Serie / Srie

to which this declaration relates is in conformity with the following directive(s) and standard(s),
 auf welches sich diese Erklrung bezieht, mit den/ten folgenden Norm(en) oder Richtlinie(n)
 (bereinstimmt).
  ce que cette dclaration rapporte est conforme aux directive(s) et aux norme(s) suivantes.

ATEX Directive
ATEX Richtlinie
ATEX Directive _____

94/9/EC
94/9/EG
94/9/CE

**EC-Type Examination Certificate / EG-Beurteilungszertifikat/Bescheinigung /
 Attestation d'Examen CE de Type**
KEMA 08 ATEX 0144, KEMA Quality B.V. NL-6812 Arnhem, ExNB-No. 0344

EMC Directive
EMV-Richtlinie
CEM Directive _____

2004/108/EC
2004/108/EG
2004/108/CE

Low-voltage directive
Niederspannungs-Richtlinie
Directive basse tension _____

2006/95/EC
2006/95/EG
2006/95/CE

Standard
Norm
Norme _____

EN 60079-0 :2006
EN 60079-11 :2007
EN 60079-26 :2007
EN 61241-0 :2006
EN 61241-11 :2006

DIN EN 61010-1 / VDE 0411 Teil 1 : 2002-08
DIN EN 61326-1 / VDE 0843 Teil 20-1 : 2006-10
DIN EN 61326-2-3 / VDE 0843 Teil 20-2-3 : 2007-05

Mettler-Toledo AG, Process Analytics

Waldemar Rauch
 General Manager PD Udorf

Thomas Hall
 Head of Operation and R&D

Place and Date of Issue
Ausstellungsport und Datum
Lieu et date d'mission _____

Udorf, 09.09.2006

This Original may not be copied, as subject to technical changes
 Dieses Original darf nicht kopiert werden, da es dem nderungsdienset unterliegt
 Cet original ne doit pas tre copi, sujet de changement technique

CE_M420_X_int.doc

METTLER TOLEDO

M420 X Control Drawing

Hazardous classified Area

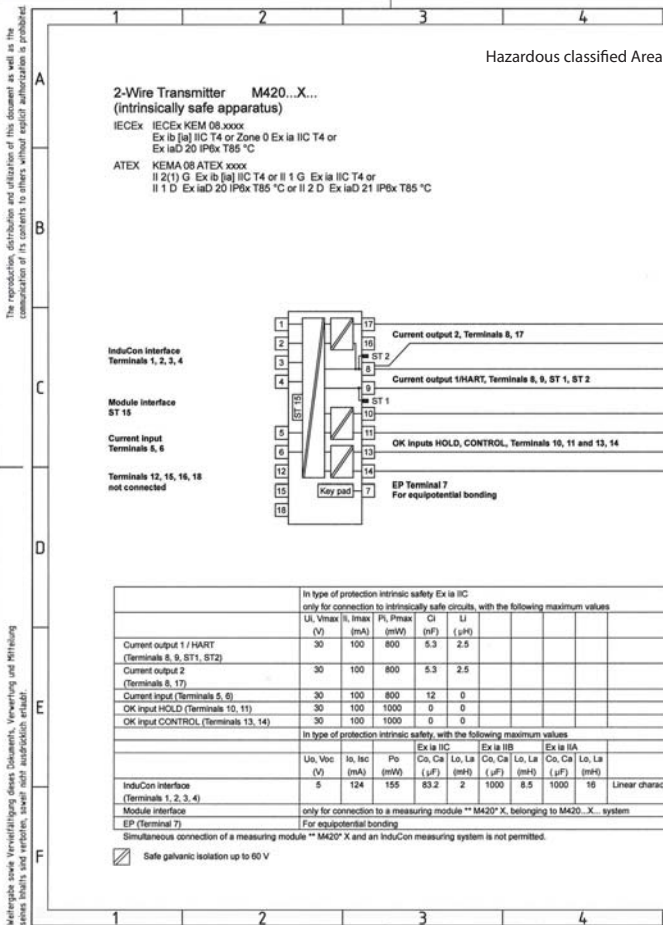

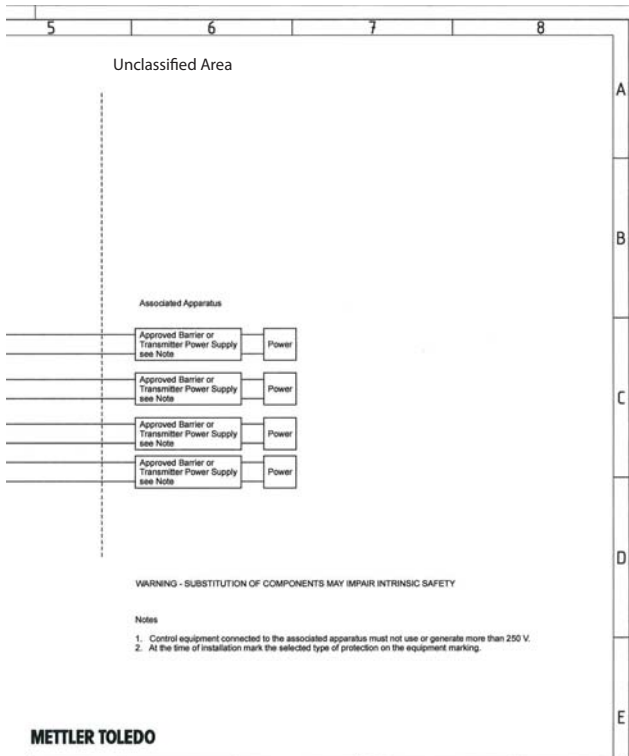

WARNING - SUBSTITUTION OF COMPONENTS MAY IMPAIR INTRINSIC SAFETY

Notes

1. Control equipment connected to the associated apparatus must not use or generate more than 250 V.
2. At the time of installation mark the selected type of protection on the equipment marking.

METTLER TOLEDO

Verteiler: FUL (2x)	Zul. Abweichungen für Maße ohne Toleranzangabe		Hallstab	
			Halbzeug	
		Datum	Name	Bezeichnung M420...X... Control drawing
	Bearb.	11.08.2008	dsm	
		Gepr. (GDN)	Freigabe	Zeichnungsnummer 212.002-230
Schutzvermerk nach ISO/IEC beachten.			Blatt 1	
Nr.	Änderungen	Datum	Bearb.	FGI (3N)

M420 X Control Drawing

The reproduction, distribution and utilization of this document as well as the communication of its contents to others without explicit authorization is prohibited.

Hazardous Classified Area
Measuring Module O₂ M420i X
belonging to
M420...X...
control drawing 212.002-230

Module interface	In type of protection intrinsic safety Ex ia IIC, only for connection to M420...X...									
In type of protection intrinsic safety, with the following maximum values										
	Uo, Voc (V)	Io, Isc (mA)	Po (mW)	Ex ia IIC		Ex ia IIB		Ex ia IIA		
				Co, Ca (nF)	Lo, La (mH)	Co, Ca (μ F)	Lo, La (mH)	Co, Ca (μ F)	Lo, La (mH)	
OXY Measuring Loop (Terminals A, B, C, D, I)	15	8.2	20.5	580	500	3.55	1000	14	1000	Linear character
Temperature Measuring Loop (Terminals G, H)	10	1.6	4	2.88 μ F	1000	19.8	1000	99	1000	Linear character
OXY/Temperature Measuring Loop (Terminals A, B, C, D, G, H, I,)	15	9.7	25	481	300	3.46	1000	13.9	1000	Linear character
ISM Measuring Loop (Terminals E, F)	15	10.6	26.6	580	300	3.55	1000	14	1000	Linear character

The measuring circuits are galvanically connected

Wiedergabe sowie Vervielfältigung dieses Dokuments, Verwertung und Mitteilung seines Inhalts sind verboten, soweit nicht ausdrücklich erlaubt.

M420 X Control Drawing

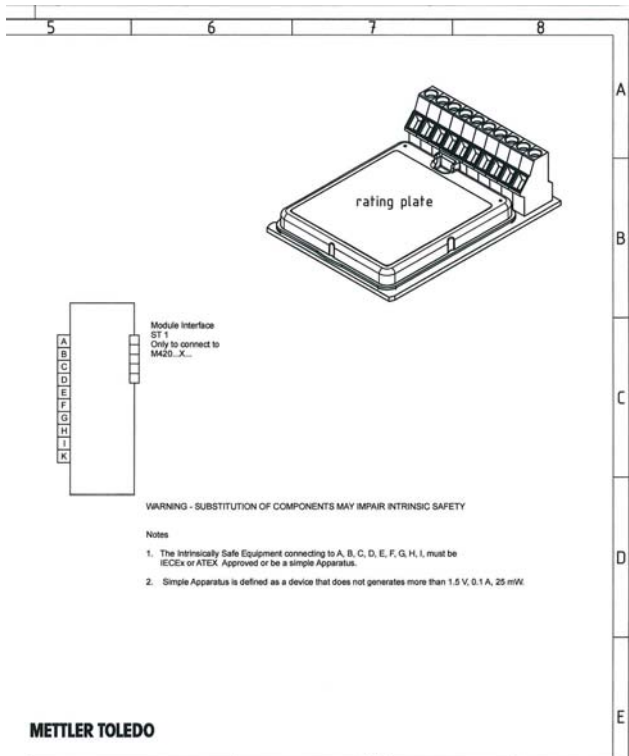

METTLER TOLEDO

Verteiler: FUL (Zx)	Zul. Abweichungen für Maße ohne Toleranzangabe	Maßstab	
		Halbzeug	
		Benennung	Module 02 M420i X Control drawing
		Zeichnungsnummer	212.002-250
		Blatt	1
			1 Bl.
Nr.	Änderungen	Datum	Bearb. / FUL KON

Index

A

- Access codes **83, 101, 116**
- Accessories **85**
- Alarm **29**
 - Delay **58**
- Ambulance TAN **83**
- Application in hazardous locations **15**
- Approvals for application in hazardous locations **9**
- Assembly **11**
- Audit Trail **101**

C

- Calibration **26, 66**
 - ISM sensor **65**
- Calibration data **77**
- Calibration mode **67**
- Calibration timer **47, 99**
- CD-ROM **3**
- CIP **46**
- Commissioning **8**
- Configuration **26**
 - Alarm **58**
 - Cleaning cycles **46**
 - Correction **56**
 - Current output 1 **48**
 - Current output 2 **54**
 - Individual configuration data **39**
 - Menu groups **31**
 - Menu structure **30**
 - Output current during Error and HOLD **52**
 - Sensocheck **58**
 - Sensor **42**
 - Sterilization cycles **46**
 - Tag number **60**
 - Time and date **60**
 - Time constant of output filter **50**

Connection examples 19
Connection to supply units 86
Control Drawings 104

D

Date 61
 Display 75
Declarations of Conformity 102
Device self-test 78
Device type, display 80
Diagnostics 26, 76
 Calibration data 77
 Device self-test 78
 Sensor data 77
 Sensor monitor 80
 Version 80
Digital sensors
 Calibration 65
 Connection 63
 Operating time 80
 Remaining lifetime 80
 Sensor replacement 64
Dimensions 12
Display 23
 Display test 78
Disposal 2
Documentation 3
Dynamic Lifetime Indicator 80

E

EC Declarations of Conformity 102
EEPROM test 78
Electronic Signature 101
Enclosure 12
Enclosure components 11
Entering values 25
Error messages 95
Explosion protection 92
Extended logbook 79, 101

F

FDA 21 CFR Part 11 101

FLASH test 78

H

HART 97

HOLD 26, 28

End 28

External activation of HOLD 29

Manual activation of HOLD 29

Output signal during HOLD 28, 53

Output signal response 28

I

Info text 95

Installation 15

Hazardous locations 9

Intended use 7

IrDA communication 83

ISM sensors 62

Calibration 65

Connection 63

Operating time 80

Remaining lifetime 80

Sensor replacement 64

K

Keypad 22

L

Logbook 79

M

M420 X Control Drawing 104

Measured values, display 80

Measurement 75

Measuring 24

Measuring mode selection 42

Measuring range 49

Membrane compensation 42

- Menu structure 27
 - Configuration 30
- Module test 78
- Mounting plan 12

- O**
- Operating modes 26
- Operating mode, selection 25
- Operating states 84
- Options 83, 85
- Output current, fixed value 82
- Output filter 50
- Output signal during HOLD 28, 53
- Overview 10

- P**
- Package contents 3, 11
- Panel mounting 14
- Parameter set A/B 31
 - Display 75
 - Manual selection 32
- Passcodes 101, 116
 - Assigning passcodes 83
- Pipe mounting 13
- Point of measurement (TAG) 61
- Polarization voltage 42
- Power supply 17
- Power supply units 86
- Pressure correction 56
- Product calibration 70
- Product line 85
- Protective hood 13

- R**
- RAM test 78
- Rating plates 16
- Release of options 83
- Reset to factory settings 83
- Return of products under warranty 2

S

- Safety information 7, 8
- Safety instructions 3
- Salinity 56
- Selection menu 25
- Sensocheck 58, 98
 - Configuration 59
- Sensoface 98
- Sensor connection 17, 19
- Sensor data, display 77
- Sensor defect 99
- Sensor monitor 80, 82
- Sensor type, analog/digital 42
- Sensor wear 100
- Serial number, display 80
- Service 26, 81
 - Factory setting 83
 - IrDA communication 83
 - Passcodes 83
 - Releasing options 83
 - Sensor monitor 82
 - Specifying current outputs 82
- Service passcode lost 83
- Signal lines 17
- SIP 46
- Slope calibration 72
 - Calibration medium 45
- Software version, display 80
- Specifications 87
- Start-up 8
- Supply units 86

T

- Tag number (TAG) 61
- TAN options 83, 85
- Temperature probe adjustment 74
- Temperature probe selection 42

Terminal assignments 16
Terminals 9, 15, 16
Time 61
 Display 75
Time constant of output filter 51
Trademarks 9

U

User Interface 22

W

Warranty 2
Wiring 17
 Examples 19
 Power supply units 86

Z

Zero calibration 68

Passcodes

In the SERVICE – CODES menu you can assign passcodes to protect the access to certain functions.

Mode of operation	Passcode
Service (SERVICE)	5555
Diagnostics (DIAG)	
HOLD mode	
Calibration (CAL)	
Configuration (CONF)	

Mettler-Toledo AG,
Process Analytics
Im Hackacker 15
CH-8902 Urdorf
Tel. +41 (44) 729 62 11
Fax +41 (44) 729 66 36
www.mt.com/pro



Subject to technical changes.

FM and CSA approvals pending