

Operating instructions

METTLER TOLEDO MultiRange Application software IND690-Fill

METTLER TOLEDO

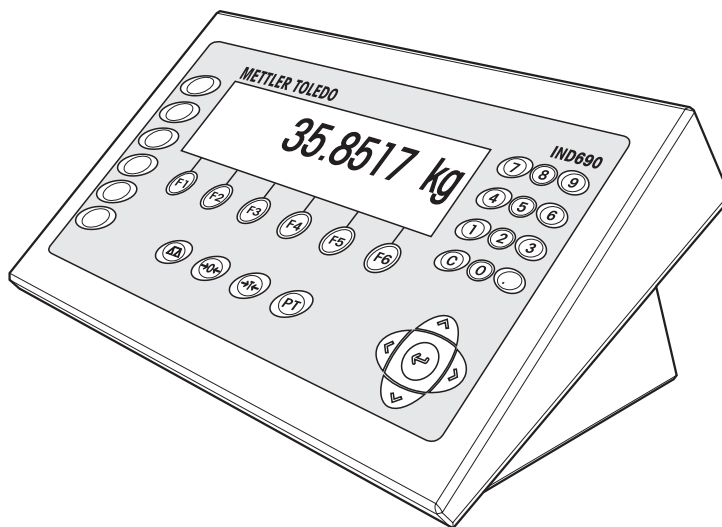
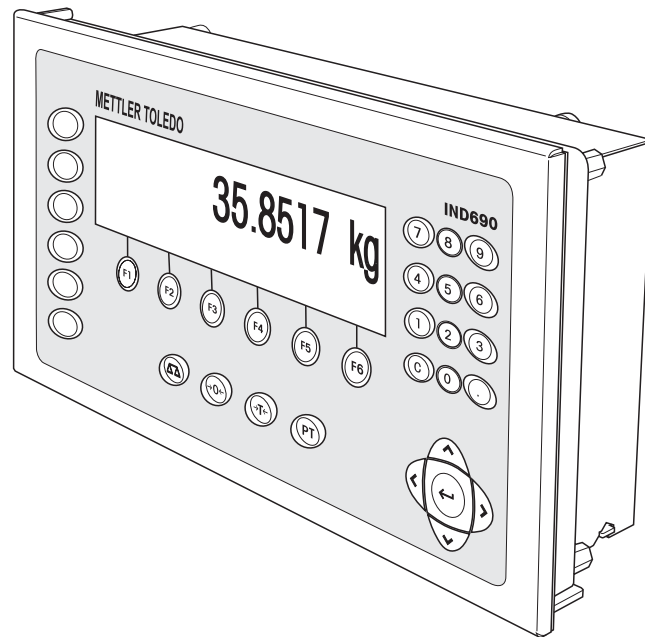

www.mt.com/support

ServiceXXL

Tailored Services

Congratulations on choosing the quality and precision of METTLER TOLEDO. Proper use according to these instructions and regular calibration and maintenance by our factory-trained service team ensure dependable and accurate operation, protecting your investment. Contact us about a ServiceXXL agreement tailored to your needs and budget.

We invite you to register your product at www.mt.com/productregistration so we can contact you about enhancements, updates and important notifications concerning your product.

Contents

	Page
1	Dispensing functions 4
1.1	Documentation 4
1.2	Introduction 4
1.3	Dispensing system 5
1.4	Dispensing process 6
1.5	Entering dispensing parameters 7
1.6	Dispensing 7
1.7	Interrupting dispensing process 10
1.8	Cancelling or ending the dispensing process 10
1.9	Redispensing 11
1.10	Manual recorection 11
1.11	Totalizing automatically 12
1.12	Recalling application-specific information 13
2	Settings in the master mode 14
2.1	Overview of the PAC master mode block 14
2.2	Settings in the PAC master mode block 15
3	Application blocks 32
4	What to do if ...? 38
5	Technical data 40
6	Appendix 41
6.1	Connection diagram and terminal assignment for 8-690 relay box 41
6.2	Sequence chart 44
7	Index 47

1 Dispensing functions

1.1 Documentation

The weighing terminal IND690-... comes supplied with a CD containing all the documentation on the weighing system IND690.

These operating instructions describe the operation and configuration of the application software IND690-Fill.

The basic information for working with the weighing terminal IND690-... can be found in the operating instructions IND690-Base.

1.2 Introduction

With the IND690-Fill you can dispense liquid, pasty, powdery or grainy weighing samples in accordance with a specified target weight.

With the function keys the IND690-Fill makes the following functions available:

N	SUM	MAN	LIMIT	STOP	START
Enter item counter	Display and print total sum	Manual redispensing	Enter and print dispensing parameters	Interrupt or cancel dispensing process	Start dispensing process and print results of dispensing after the dispensing process is completed

→ Select the function by pressing the function key.

Example

→ Press the N key.

Then enter the start and stop value of the item counter manually with the keypad.

Note

When PASSWORD BLOCK ON is set in the master mode, a personal code must be entered after pressing the N key.

When the function keys are otherwise allocated

→ Press the cursor keys < or > repeatedly until the function key assignment shown above appears.

CAUTION

Danger of injury when pressing keys which start and stop the dispensing system or control the valves!

→ Before pressing these keys, make sure that no one is in the area of moving system parts.



1.3 Dispensing system

With feed valves or feed chutes controlled with coarse and fine feed, the dispensing sample is automatically infed up to the specified target value.

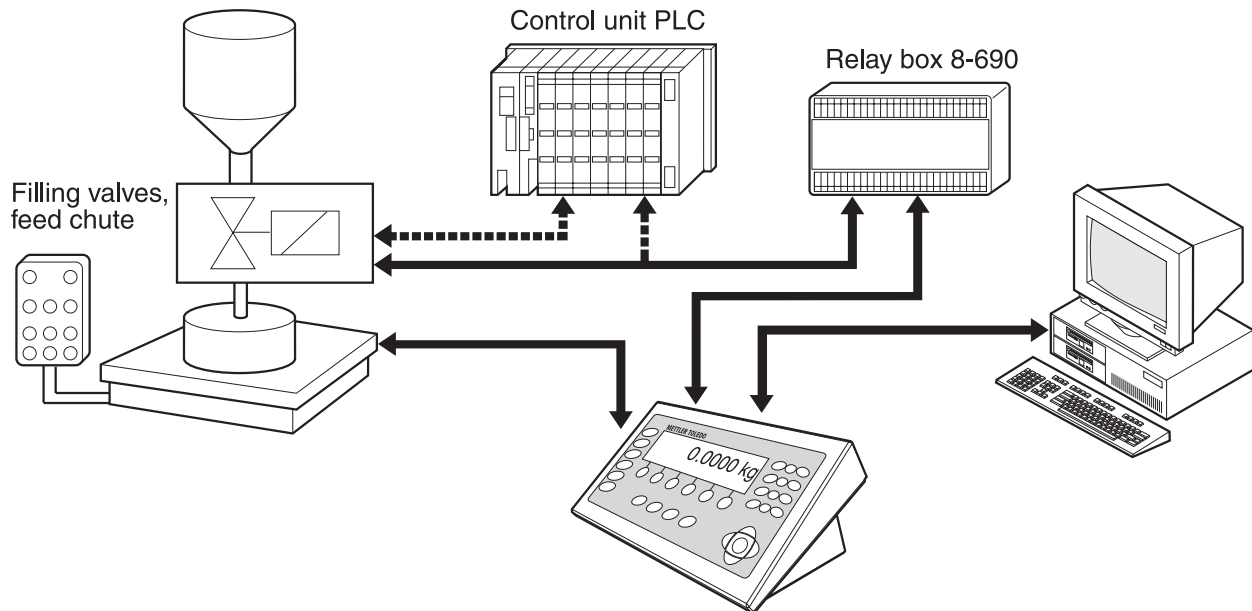

The control signals for the feed valves are transmitted to the 8-690 relay box via the RS485-690 interface. The 8-690 relay box controls the dispensing system either directly or via an additional external control unit (PLC). In the case of overloading or underloading of the weighing platform, all valves are closed immediately.

A maximum of two 8-690 relay boxes can be connected. With a second relay box a dispensing system with below-level dispensing can be controlled without a PLC ("nozzle control"). The IND690-Fill then assumes the function of a control unit with the moving of a filling nozzle or the switching of a drip pan and outputs signals to the nozzle correction, pregasing and postgasing.

The IND690-Fill can be remote controlled with "electronic fingers". These electronic fingers trigger various keys via interface commands on the terminal, see section 3.

Alternatively to the relay box 8-690 the dispensing system can also be controlled by using the interface 4/I/O-690 and relay box 4-690 or by using ARM100.

Please note that the accuracy of the filling results and the filling speed are not only dependent on the scale, but also on the other system parts, and in particular on the filling device itself (valves, feed chutes etc.). Only the optimum co-ordination of all components with each other produces the best filling results.

1.4 Dispensing process

Dispensing is carried out in 5 consecutive steps:

- **Automatic tare** – Automatic taring of the container and dispensing start
- **Coarse feed** – Dispensing with coarse feed up to the coarse/fine-feed switch-over point (limit 1)
- **Fine feed** – Dispensing with fine feed up to the switch-off point of the fine feed (limit 2)
- **Redispensing correction** – Redispensing correction of fine feed beyond limit 2
- **Redispensing** – If the weight value does not lie within the tolerance of the target value at the end of dispensing, automatic or manual redispensing up to the target value

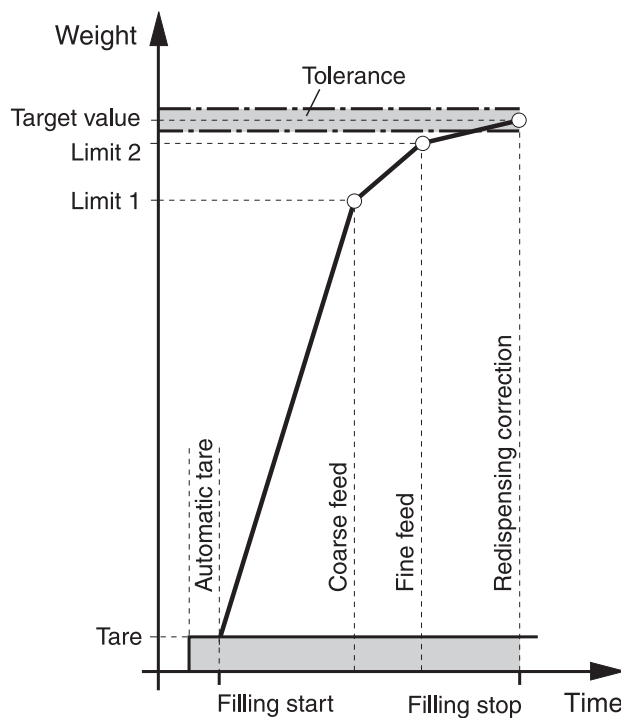

If not limits are entered, the IND690-Fill automatically determines Limit 1 and Limit 2 in a learn mode, see page 20. The target weight is then exactly reached already during the first dispensing.

To optimize the dispensing process, Limit 2 is automatically adjusted with the same component during the next dispensing process, see REDISP. CORRECTION block on page 16.

If the container is underfilled, manual or automatic redispensing can be carried out depending on the settings in the master mode.

1.5 Entering dispensing parameters

Entering numerically

1. Press LIMIT key.
2. Enter target weight and confirm with ENTER.
3. Specify limits: enter ENTER LIMIT 1 and LIMIT 2 and confirm with ENTER.
To automatically determine the limits, press ENTER without making an entry.
4. Specify tolerance: enter TOL and confirm with ENTER.
5. If tare checking is to be used, specify tare values TMIN and TMAX and confirm with ENTER.

Notes

- The weight unit for entering the limits can be selected with the cursor keys < or >.
- The entry can be corrected one character at a time with the CLEAR key.
- If LEARN MODE OFF is set in the mastermode, Limit 1 and Limit 2 **must** be specified, and if the 3rd switch-off point is also activated (see section 2.2.5), Limit 0 as well.
- If PASSWORD BLOCK ON is set in the master mode, a personal code must be entered after pressing the LIMIT key.
- If ANALOG OUTPUT ON is set in the master mode, the throughput preflow (with additionally activated 3rd shutoff point), throughput coarse feed and throughput fine feed **must** be specified.
- Press the LIMIT key in order to display or correct dispensing parameters in the READY FOR DISPENSING state. The target weight cannot be entered in this case.

Copying constants

1. Enter number of target memory: 1 ... 999.
2. Press LIMIT key.

Note

If PASSWORD BLOCK ON is set in the master mode, a personal code must be entered after pressing the LIMIT key.

1.6 Dispensing

The dispensing type is dependent on the application set in the master mode:

- ABOVE LEVEL: Dispensing above the filling level (without filling lance)
- BELOW LEVEL Dispensing lance below the dispensing level
The filling process is not started unless the dispensing lance is recognised in the right position, meaning that the input signal NOZZLE DOWN has to be active.
- BELOW BUNGHOLE Dispensing lance below the bung hole
The filling process is not started unless the dispensing lance is recognised in the right position, meaning that the input signal NOZZLE MIDDLE has to be active.

Notes

- For the application BELOW LEVEL/BELOW BUNGHOLE, NOZZLE CONTROL ON two 8-690 relay boxes must be connected.
- During the filling process exactly one of the signals NOZZLE DOWN / MIDDLE / UP has to be active. Otherwise the error message SEVERAL INPUTS ON or WAITING FOR INPUT is displayed. The filling process is not continued until exactly one of these signals is active.
- A new filling process can only be started if the input signal NOZZLE UP has been recognised beforehand.
- For sequence charts of the individual applications, see section 6.2.

1.6.1 Displaying of dispensing state

The display shows the dispensing state with texts and a 3-digit code, e.g.:

Text	Code	Meaning
READY FOR DISPENSING	010	Dispensing parameters loaded
COARSE FEED	040	Dispensing with coarse feed
FINE FEED	050	Dispensing with fine feed
DISPENSING OKAY	101	Target value achieved
UNDERFILLED	084	Target value not achieved
OVERFILLED	111	Target value exceeded
EVALUATING	070	Evaluation of dispensing results

Notes

- The dispensing states are listed in application block 361, see section 3.
- If STATUS INDICATOR WITH DELTATRAC is set in the master mode, the display also shows the DeltaTrac as an analog weigh-in aid.

1.6.2 Dispensing with filling container on the weighing platform

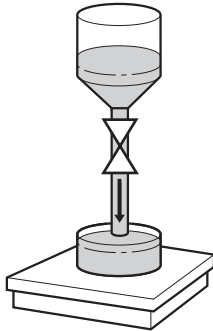

During dispensing the filling container on the weighing platform is filled from a supply vessel.

1. Enter dispensing parameters, see section 1.5.
The display shows READY FOR DISPENSING.
2. Place empty filling container on the weighing platform.
3. Press START key.
The display shows the following: weight value, dispensing status and DeltaTrac.
When the dispensing process is completed, the display indicates whether the weight value lies within the tolerance limits (DISPENSING OKAY) or outside (OVERFILLED, UNDERFILLED).
The dispensing result is printed.
4. Relieve weighing platform.
If ACKNOWLEDGE ON is set in the master mode, the dispensing process is acknowledged and the display shows READY FOR DISPENSING.

1.6.3 Dispensing with a supply vessel on the weighing platform

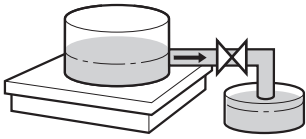

During dispensing the filling container is dispensed from a supply vessel on the weighing platform.

1. Enter dispensing parameters, see section 1.5.
The display shows READY FOR DISPENSING.
2. Place filled supply vessel on the weighing platform.
3. Press START key.
The display shows the following: weight value with negative sign, dispensing status and DeltaTrac.
When the dispensing process is completed, the display indicates whether the weight value lies within the tolerance limits (DISPENSING OKAY) or outside (OVERFILLED, UNDERFILLED).
The dispensing result is printed.
4. Acknowledge dispensing process.
If ACKNOWLEDGEMENT ON is set in master mode, READY FOR DISPENSING is shown in the display. With ACKNOWLEDGEMENT OFF, the next dispensing process is started automatically.

1.7 Interrupting dispensing process

Same container

1. Press STOP key.
The dispensing process is interrupted.
2. To continue the dispensing process, press START key.

New container

1. Press STOP key twice.
The dispensing process is cancelled.
2. Place a new container on the weighing platform.
3. If TOTALIZING ON is set in the master mode, the sum can be displayed with the SUM key.
4. To continue the dispensing process, press START key.

1.8 Cancelling or ending the dispensing process

By pressing key on weighing terminal

- Press STOP key twice.
The dispensing process is cancelled or ended when the dispensing process is completed.

By external signal

- Cancel dispensing process with a pulse at input IN 7 of first 8-690 relay box. The IND690-Fill is then in the READY FOR DISPENSING (010) state.

Note

If TOTALIZING ON, CORRECT DISPENSINGS is set in the master mode, cancelled dispensing processes can be added to the sum by pressing the SUM key when CONTINUE WITH START is displayed.

1.9 Redispensing

If, for example, the weight value is briefly exceeded, the fine feed is switched off too early and the current weight value (actual value) is below the target value. During redispensing the fine feed is opened in intervals until the target value is reached. Depending on the setting in the master mode, redispensing is carried out manually or automatically, see section 2.2.

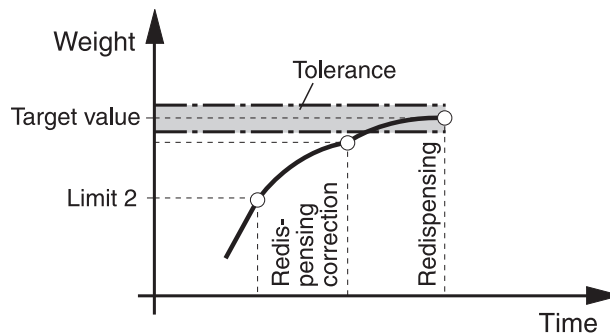

Manual redispensing

Prerequisite

MANUAL REDISPENSING is set in the master mode.

- When the display shows MANUAL, press and hold down the MAN key. The fine feed is switched on in pulses as long as the key is pressed and until the target value is reached.

1.10 Manual recorection

If MANUAL CORRECTION ON is set in the master mode, the display shows MANUAL CORRECTION after the actual-target comparison if the final weight lies outside the tolerances.

- Recorrect manually and confirm correction with START key.

1.11 Totalizing automatically

To automatically totalize dispensing processes with the same dispensing samples, an item counter can be specified which determines the number of dispensing processes. When the item counter reaches its stop value, the dispensing system stops automatically.

Prerequisite

TOTALIZING ON is set in the master mode.

1. To set the item counter:
 - Press N key.
 - Enter start value of item counter and confirm with ENTER.
 - Enter stop value of item counter and confirm with ENTER.
2. Carry out 1st dispensing process, see section 1.6.
3. Relieve weighing platform.
4. Carry out additional dispensing processes, see section 1.6.
When the item counter reaches its stop value, the dispensing system stops automatically.
5. To display and print the total sum, press the SUM, ENTER key sequence.
6. To carry out additional dispensing processes with the same dispensing sample, e.g. after redispensing the supply vessel, repeat steps 1 to 3.
When doing so, make sure that the item counter continues to count.
 - or –
 - To carry out dispensing processes with a different dispensing sample, or to end totalizing, press the SUM, CLEAR key sequence.

Notes

- If TOTALIZING ON, CORRECT DISPENSINGS is set in the master mode, cancelled dispensing processes can only be added to the total sum by pressing the SUM key when CONTINUE WITH START is displayed.
- If PASSWORD BLOCK ON is set in the master mode, a personal code must be entered after pressing the SUM and N keys.

1.12 Recalling application-specific information

Information on dispensing can be recalled with the following key combinations:

INFO, N	Display item counter.
INFO, SUM	Display current weight sum.
INFO, LIMIT	Display current dispensing parameters.
INFO, fixed target number, LIMIT	Display stored dispensing parameters.

Notes

- If several pieces of information are recalled with one key, the display changes automatically after the set DISPLAY DURATION. It is also possible to switch back and forth between these pieces of information with the CLEAR key.
- No information can be displayed during the dispensing process (dispensing valves open).

2 Settings in the master mode

2.1 Overview of the PAC master mode block

The following system settings can be entered in this block:

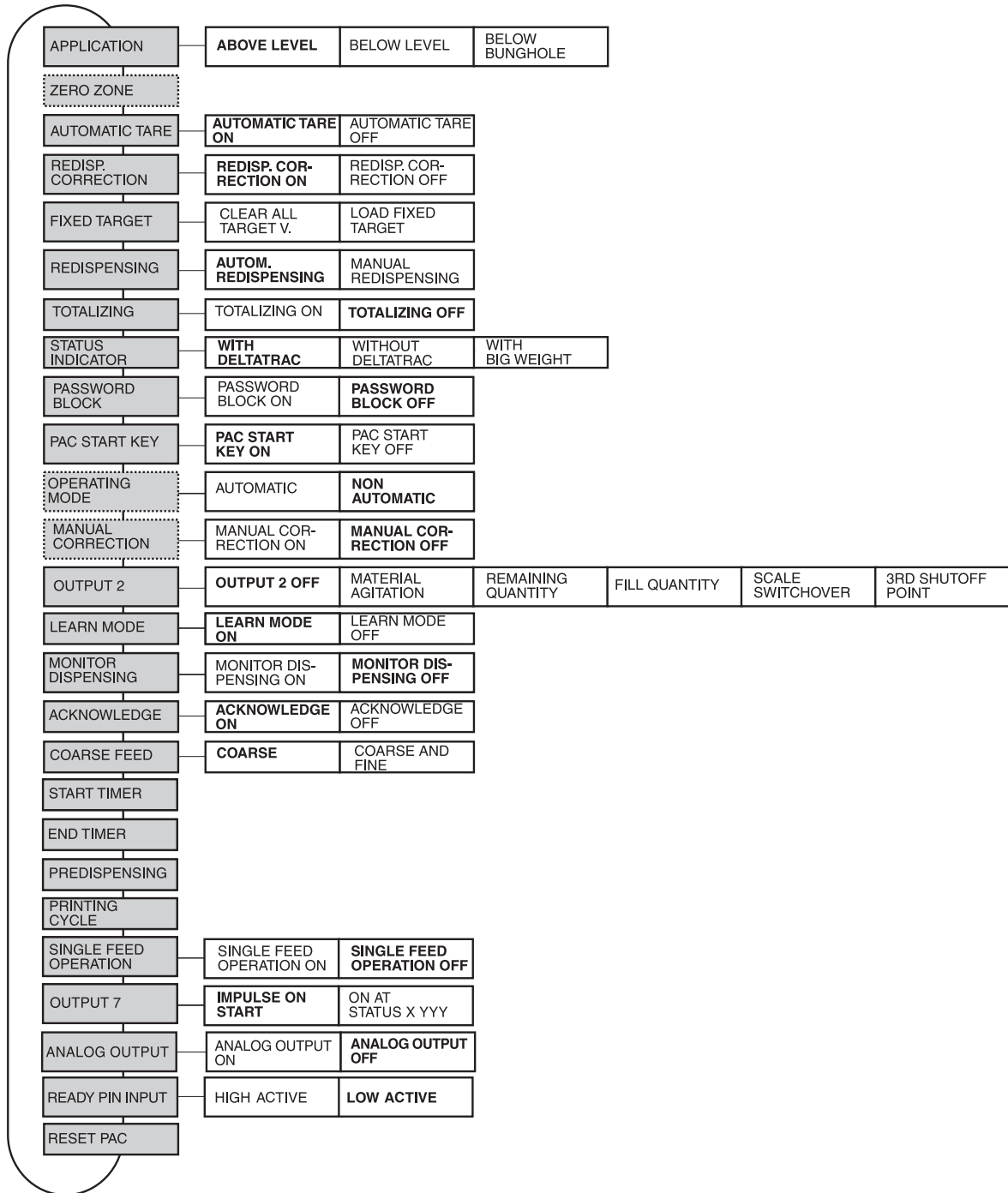

Legend

- Blocks on a **grey** background are described in detail in the following.
- Factory settings are shown in **bold** print.
- Blocks which only appear under certain conditions appear with a **dotted** outline.

2.2 Settings in the PAC master mode block

Note

You can make all master mode adjustments conveniently with the PC using the FillTool software. Ask your METTLER TOLEDO sales partner. See section 2.2.6 for examples.

APPLICATION	Select application
ABOVE LEVEL	Dispensing above the filling level (factory setting)
BELOW LEVEL NOZZLE CONTROL	<p>Filling with dispensing lance below the dispensing level</p> <p>Switch nozzle control on or off. Factory setting: NOZZLE CONTROL OFF Nozzle control operates best when 2 relay boxes 8-690 are connected. Addition settings with NOZZLE CONTROL ON:</p> <ul style="list-style-type: none"> • DRIP PAN – working with or without drip pan control Factory setting: DRIP PAN OFF • EVALUATION POSITION: <ul style="list-style-type: none"> – NOZZLE MIDDLE (factory setting) – NOZZLE TOP • NOZZLE MONITORING – working with or without monitoring of the nozzle position Factory setting: NOZZLE MONITORING OFF
BELOW BUNGHOLE NOZZLE CONTROL	<p>Filling with dispensing lance below the bung hole</p> <p>Switch nozzle control on or off. Factory setting: NOZZLE CONTROL OFF Nozzle control operates best when 2 relay boxes 8-690 are connected. Addition settings with NOZZLE CONTROL ON:</p> <ul style="list-style-type: none"> • DRIP PAN – working with or without drip pan control Factory setting: DRIP PAN OFF
Comments	<ul style="list-style-type: none"> • Take terminal diagram and terminal assignment of 8-690 relay box into account, see section 6.1. • For example sequence charts for the three applications, see section 6.2.

ZERO ZONE	Adjust weight monitoring while lowering the filling nozzle with the below level application
	If the current weight value exceeds the threshold ZERO, the filling nozzle is moved back to the starting position. The cause may be poor positioning when the filling nozzle, e. g. scrapes the container rim or runs into the cover.
ZERO	Enter threshold weight value of the zero zone

AUTOMATIC TARE	Switch automatic taring before dispensing on or off
	Factory setting: AUTOMATIC TARE ON

REDISP. CORRECTION	Switch redispensing correction on or off
	<p>The redispensing correction function optimizes the switch-off point of the fine feed (limit 2).</p> <p>If REDISP. CORRECTION ON is set, the target-actual difference is determined for each container and multiplied by a FACTOR.</p> <p>Target-actual difference x correction factor = Δ</p> <p>Limit 2 is automatically corrected by the value Δ when dispensing the next container:</p> <p>Example: For a target-actual difference of 10 g and a factor of 0.5, limit 2 is corrected by 5 g.</p>
	Factory setting: REDISP. CORRECTION ON

FACTOR	<p>Correction factor by which the target-actual difference is multiplied. The result is the value Δ by which limit 2 is corrected.</p> <p>Possible values: 0.1 ... 0.9 (factory setting: 0.5)</p>
---------------	---

CORREC. THRESHOLD	<p>The correction threshold specifies the target-actual difference up to which the redispensing correction corrects limit 2.</p> <ul style="list-style-type: none"> • Possible values: 0 ... 99 in multiples of the tolerance (Factory setting: 0, i. e. limit 2 is corrected for all actual values) • Limit 2 is not corrected when TOTALIZING ON is set and after at least 10 consecutive dispensings the actual value lies outside the correction threshold for the first time. This value is considered a freak value. If during the next dispensing the actual value lies outside the correction threshold, limit 2 is automatically corrected. If in the process $\text{limit } 2 \leq \text{limit } 1$, then the learn mode is automatically activated.
--------------------------	---

FIXED TARGET	Save dispensing parameters for various components in target memories protected against power failure
LOAD FIXED TARGET	<ol style="list-style-type: none"> 1. Enter FIXED TARGET NO. memory number: 1 ... 999. 2. Enter article designation NAME, e.g. M8 SCREW. 3. Enter TARG target weight. 4. If OUTPUT 2 = 3RD SHUTOFF POINT: Enter switchover point preflow/coarse feed LIMIT 0. 5. Enter coarse/fine feed switchover point LIM 1. 6. Enter switch-off point of fine feed LIM 2: $LIMIT\ 1 \leq LIMIT\ 2$. 7. Enter tolerance TOL in the displayed unit. <ul style="list-style-type: none"> – Minimum tolerance: 1 digit – Maximum tolerance: target weight; with DeltaTrac: 10 % of target weight – Target weight + tolerance \leq maximum load 8. Enter lower limit of permissible tare range TMIN. 9. Enter upper limit of permissible tare range TMAX: $TMIN \leq TMAX$. 10. If ANALOG OUTPUT = ON and OUTPUT 2 = 3rd SHUTOFF POINT: Enter THROUGHPUT PREFLOW. If ANALOG OUTPUT = ON: Enter THROUGHPUT COARSE FEED and THROUGHPUT FINE FEED 11. End entry: Confirm memory number without entry with ENTER.
CLEAR ALL TARGET V.	Clear all target memories.

REDISPENSING	Set automatic or manual redispensing
	Factory setting: AUTOMAT. REDISPENSING
AUTOMAT. REDISPENSING MANUAL REDISPENSING	Possible entries: <ul style="list-style-type: none"> • PULSE DURATION During the pulse duration the fine feed is opened. Possible values: 1 ... 99 times a measuring cycle (factory setting: 5) • PULSE PAUSE During the pulse pause the fine feed is closed. Possible values: 0 ... 99 times a measuring cycle (factory setting: 5)

TOTALIZING	Switch automatic totalizing on or off
	If TOTALIZING ON is set, the dispensings to be totalized can be selected. Factory setting: TOTALIZING OFF
CORRECT DISPENSINGS	Only totalize dispensings within the tolerances. Cancelled dispensings can be added to the total sum with the SUM key in the CONTINUE WITH START state.
ALL DISPENSINGS	Totalize all dispensings.

STATUS INDICATOR	Set display of dispensing state on IND690-Fill
WITH DELTATRAC	The dispensing state is displayed with text, a 3-digit code and the DeltaTrac, see section 1.6.1 (factory setting).
WITHOUT DELTATRAC	The dispensing process is displayed with texts and a 3-digit code.
WITH BIG WEIGHT	During the dispensing process the BIG WEIGHT DISPLAY weight display is switched on. Dispensing states such as READY FOR DISPENSING or DISPENSING OKAY continue to be displayed, and the display switches over to the normal weight display for this purpose.
	The following possibilities are also available for all settings: <ul style="list-style-type: none"> • NOT ENLARGED (factory setting): When the weighing platform is ready for dispensing, the display shows READY FOR DISPENSING. • ENLARGED: When a target memory has been recalled, the memory designation appears in the display in the ready for dispensing state. For manually entered dispensing parameters, READY FOR DISPENSING appears.

PASSWORD BLOCK	Switch password block on or off
	Protect SUM, N and LIMIT keys with the personal code which also protects the master mode, see "Master mode" section in the operating instructions for the IND690-Base weighing terminal. Factory setting: PASSWORD BLOCK OFF

PAC START KEY	Switch locking of the START key on or off
	If PAC START KEY OFF is set, the START key is locked and the dispensing process can only be started via an external switch or a 8-690 relay box. This prevents double operation with external operating elements (e.g. footswitch or key). Factory setting: PAC START KEY ON

OPERATING MODE	Set operating mode with certified weighing platforms
NON AUTOMATIC	The dispensing process does not run automatically and the permissibility of the weight values must be monitored by the operator.
AUTOMATIC	The dispensing process runs automatically (factory setting).
Comments	<ul style="list-style-type: none"> • Different national tolerances are taken into account. • For calibration reasons, the operating mode can only be switched over in the non-certified mode of the weighing platform.

MANUAL CORRECTION	Switch manual recorection on or off
	When MAN. CORRECTION ON is set, the final weight can be manually recorrected, e.g. in the case of incorrect dispensing, see section 1.10. Factory setting: MAN. CORRECTION OFF
Comments	<ul style="list-style-type: none"> • At output OUT4 and OUT5 of the first 8-690 relay box, it can be read off whether dispensing lies within the tolerances (DISPENSING OKAY) or outside (DISPENSING POOR). • Manual correction is not possible in case of verifiable weighing platforms in the AUTOMATIC operating mode. • If REDISPENSING is set to AUTOMATIC, the MANUAL CORRECTION only becomes active in the case of overfilling (underfilled containers are automatically redispensed). If REDISPENSING is set to MANUAL, the MANUAL CORRECTION becomes active in the case of underfilling and overfilling.

OUTPUT 2	Control various additional devices via output 2
OUTPUT 2 OFF	Output 2 is not actuated (factory setting).
MATERIAL AGITATION	Control of an agitator during or after dispensing; for additional settings, see section 2.2.1.
REMAINING QUANTITY	Remaining quantity: Control of an emptying device on the filling container; for additional settings, see section 2.2.2.
FILL QUANTITY	Fill quantity: Control of a refilling valve during subtractive weighing; for additional settings, see section 2.2.3.
SCALE SWITCHOVER	Control of a signal which enables switching over between 2 weighing platforms; for additional settings, see section 2.2.4.
3RD SHUTOFF POINT	Control of a third valve; for additional settings, see section 2.2.5.
Comment	To read or set the status of output 2, see application block 359 on page 35.

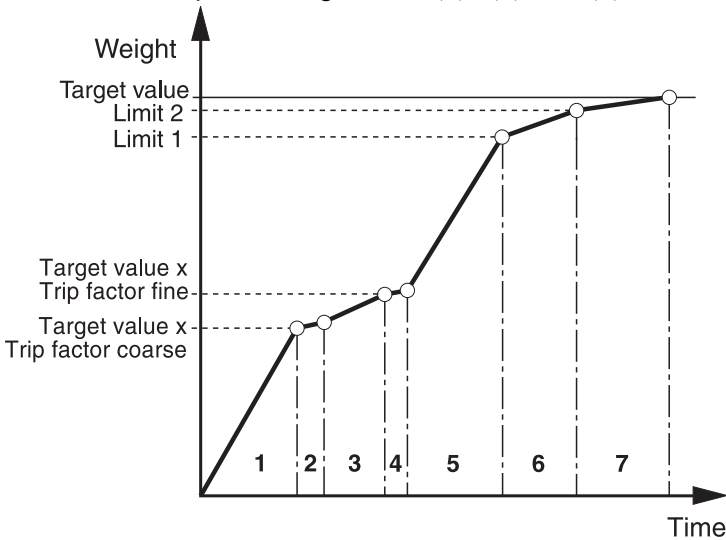
LEARN MODE	Switch Learn mode on or off
	<p>If LEARN MODE ON is set and the dispensing parameters are entered without limits or limit 2 \leq limit 1, the IND690-Fill determines the valve switch-off points limit 1 and limit 2.</p> <p>If LEARN MODE OFF is set, limit 1 and limit 2 must be entered manually.</p> <p>Factory setting: LEARN MODE ON</p> <ul style="list-style-type: none"> The coarse feed is opened (1) in the learn mode up to the value (target value x trip factor coarse feed) and the redispensing correction determined (2). Then the fine feed is opened (3) during the number of measuring cycles specified with the trip factor fine feed and its redispensing correction determined (4). Then limit 1 and limit 2 are calculated in dependence on the target value. Following this filling is carried out up to the target value (5), (6) and (7). 
TRIP FACTOR COARSE	<p>The trip factor coarse feed determines when the coarse feed is switched off in the learn mode.</p> <ul style="list-style-type: none"> Possible values: 0.1 ... 0.9 (factory setting: 0.5). With high pressures and pulse forces or large mass feeds, reduce the trip factor.
TRIP FACTOR FINE	<p>The trip factor fine feed specifies how long the fine feed is open in the learn mode. The larger the trip factor fine feed, the more accurately the fine feed run-on can be determined.</p> <p>Possible settings: TRIP FACTOR FINE FEED = 0.1 ... 0.9 (Factory setting: 0.5)</p> <p>The value 0.1 is equal to 5 measuring cycles, 0.5 is equal to 25 measuring cycles and 0.9 is equal to 45 measuring cycles.</p>
Comments	<ul style="list-style-type: none"> If SINGLE FEED OPERATION ON is set, limit 1 is set to zero in the learn mode. TRIP FACTOR COARSE and TRIP FACTOR FINE are available as application blocks (blocks 363 to 367).

MONITOR DISPENSING	Switch monitor dispensing on or off
	<p>Dispensing monitoring monitors the weight increase in each measuring cycle. If MONITOR DISPENSING ON is set and the weight value exceeds or drops below the SENSITIVITY value, dispensing monitoring is activated.</p> <p>Factory setting: MONITOR DISPENSING OFF</p>
SENSITIVITY	<p>AABBCCDDEEFF – Response behavior of dispensing monitoring as a 12-digit number</p> <p>Possible settings:</p> <ul style="list-style-type: none"> • WEIGHING-IN – Dispensing monitoring during weighing-in • SUBTRACTIVE WEIGH. – Dispensing monitoring during subtractive weighing <p>Response behavior of dispensing monitor</p> <p>AA AA = 00 digit: Dispensing monitoring is activated when the weight increase per measuring cycle drops below the corresponding value (DD, EE or FF) (negative monitoring). The corresponding valve (preflow, coarse or fine feed) is automatically switched off. The display alternately shows MONITOR DISPENSING and CONTINUE WITH START. The dispensing process can be ended with the STOP key or continued with the START key.</p> <p>AA = 01 digit: Dispensing monitoring is activated when the weight increase per measuring cycle exceeds the set value (DD, EE or FF) (positive monitoring). The corresponding valve (preflow, coarse or fine feed) is automatically switched off. Dispensing is first continued when the weighing platform is stable.</p> <p>BB Switch-on value of dispensing monitoring: weight increase per measuring cycle for which dispensing monitoring is activated after starting or interrupting the dispensing process: 00 ... 99 digit (factory setting: 03)</p> <p>CC Number of measuring cycles during which the dispensing monitor pauses and the weight increase takes place: 01 ... 99 (factory setting: 10)</p> <p>DD Weight increase per measuring cycle for the fine feed: 01 ... 99 digit (factory setting: 01)</p> <p>EE Weight increase per measuring cycle for the coarse feed: 01 ... 99 digit (factory setting: 01)</p> <p>FF Weight increase per measuring cycle for the preflow: 01 ... 99 digit (factory setting: 01)</p>
Comments	<ul style="list-style-type: none"> • In the case of valve or material sluggishness increase the value BB. • In the case of uneven material feed increase the value CC. • With an increased material flow, increase the values DD, EE and FF (minus monitoring). • In application block 361 the dispensing state minus or plus monitoring is available, and the response behaviour is available in application block 362, see section 3.

MONITOR DISPENSING	Switch monitor dispensing on or off
Example	<p>Big bag emptying</p> <p>If SUBTRACTIVE WEIGHING ON is selected, the dispensing monitor stops the emptying process as soon as the big bag is fully emptied. The last filling process is generally not yet complete here. The previously removed weight can be saved by pressing the TARE key. After inserting a new big bag and pressing the START key, the interrupted filling process is then completed.</p> <p>Practical example</p> <p>A big bag with 2,000 kg of bulk material is to be filled into sacks of 300 kg each.</p> <ul style="list-style-type: none"> • IND690-Fill performs six filling processes (1,800 kg filled). • With the seventh filling process, only 200 kg can be filled. The dispensing monitor stops the filling process. • Press the TARE key to save the 200 kg already filled. • Insert a new big bag and press the START key. • The seventh sack is topped up to the required 300 kg.

ACKNOWLEDGE	Switch acknowledgement of the next dispensing process on or off
	<p>After completing one dispensing process, the next dispensing process can be started with or without acknowledgement.</p> <p>Acknowledgement is triggered with the following actions:</p> <ul style="list-style-type: none"> • Weight change > 30 digit • Pressing the START key • Interface command <code>A,W3,5,2_1</code> or <code>A,W3,0,6_\$\$9</code>, see section • Signal at input IN 4 of the first 8-690 relay box
ACKNOWLEDGE ON	<p>Moving the weighing platform by at least 30 digit or pressing the START key in the DISPENSING OKAY state results in the READY FOR DISPENSING state.</p> <p>The next dispensing process is started with the START key (factory setting).</p>
ACKNOWLEDGE OFF	<p>After the dispensing process is completed and the START is pressed, the next dispensing process is started immediately. READY FOR DISPENSING is not displayed.</p>

COARSE FEED	Set valves during coarse feed
COARSE	Open coarse feed up to limit 1 (factory setting).
COARSE AND FINE	Open coarse and fine feed up to limit 1 simultaneously.

START TIMER	Set delay time between the start of the dispensing process and opening of the coarse feed
TIME	Possible values: 0 ... 999 seconds (factory setting: 0)
Comments	<ul style="list-style-type: none"> • When the start timer is activated, the display shows the time remaining. • The start timer can be interrupted or cancelled with the STOP key. • If two 8-690 relay boxes are installed, the OUT7 output on the second 8-690 relay box is set to HIGH during the delay time. This signal can, for example, be used for pregasing when dispensing fruit juices.

END TIMER	Set delay time between stabilization of the weighing platform after the end of dispensing and evaluation of the weighing data
TIME	Possible values: 0 ... 999 seconds (factory setting: 0)
Comments	<ul style="list-style-type: none"> • When the end timer is activated, the display shows the time remaining. • The stop timer can be interrupted or cancelled with the STOP key. • If two 8-690 relay boxes are installed, the OUT6 output on the second 8-690 relay box is set to HIGH during the delay time. This signal can, for example, be used for regasing when dispensing fruit juices.

PREDISPENSING	Set time for predispensing
	The fine feed valve is actuated before each opening of the coarse feed. The fine feed valve can be opened either for a specific period of time or up to a specific weight.
TIME	Possible values: 0 ... 999 seconds (factory setting: 0)
WEIGHT	Weight limit for predispensing Possible values: 0 ... target weight (factory setting: 0 kg)
Comments	<ul style="list-style-type: none"> • Predispensing can be interrupted or cancelled with the STOP key. When limit 1 is reached, predispensing is automatically cancelled. • When predispensing is activated, the display shows the time still remaining.

PRINTING CYCLE	Enter number of dispensings after which the dispensing result is automatically printed or a corresponding data string is transmitted
	Possible values: 1 ... 99 (factory setting: 1)

SINGLE FEED OPERATION	Switch single feed operation on or off
	If SINGLE FEED OPERATION ON is set and the target value of the specified LIMIT is dropped below, dispensing is then only carried out with fine feed. This also enables smaller quantities to be dispensed without switching over the dispensing system (valves, pumps). Factory setting: SINGLE FEED OPERATION OFF
LIMIT	Enter threshold value for single feed operation.

OUTPUT 7	Set switch-on of the OUT 7 output to the first 8-690 relay box
IMPULSE ON START	OUT 7 is briefly switched on during the start-up of the IND690-Fill (factory setting).
ON AT STATUS X YYY	Enter up to 30 dispensing states for which OUT 7 is switched on. X is the serial number (1 ... 30), YYY is the code for the various dispensing states (000 ... 254), see application block 361 on page 36. To end the input of the dispensing states, press ENTER without making an entry.

ANALOG OUTPUT	Output throughput at analog output
	When ANALOG OUTPUT ON is set, a respective throughput (0 ... 99 %) is output at an integrated analogue output during the opening of the preflow, coarse feed or fine feed. The size of the throughput can be entered manually with the LIMIT key or with a port via the application blocks 322 ... 347 or 323_001 ... 323_999. Factory setting: ANALOG OUTPUT OFF
Note	For this purpose, the analog output must be configured as follows: Start-Stop mode BLOCK NUMBER 366 START VALUE 0 kg STOP VALUE Maximum load of weighing platform START V/MA as required STOP V/MA as required

READY PIN INPUT	Setting the logic for the stand-by signal
LOW ACTIVE HIGH ACTIVE	The READY signal has to be configured for a digital input to this purpose. This signal is used to stop the filling process when the signal that can be switched in the logic between LOW ACTIVE (factory setting) and HIGH ACTIVE is no longer recognized. The stopped dispensing process has to be reactivated by pressing a key (START).

RESET PAC	Reset all functions to the factory settings	
	Block	Factory setting
	APPLICATION	above level
	AUTOMATIC TARE	on
	REDISP. CORRECTION	on; factor = 0.5; correction threshold = 0
	REDISPENSING	autom. redispensing; pulse duration 5 s; pulse pause 5 s
	TOTALIZING	off
	STATUS INDICATOR	with DeltaTrac; not enlarged
	PASSWORD BLOCK	off
	PAC START KEY	on
	OPERATING MODE	automatic
	MANUAL CORRECTION	off
	OUTPUT 2	output 2 off
	LEARN MODE	on; trip factor coarse feed = 0.5; trip factor fine feed = 0.5
	MONITOR DISPENSING	off; sensitivity 00 03 10 01 01 01; weighing in
	ACKNOWLEDGE	on
	COARSE FEED	coarse
	START TIMER	0 s
	END TIMER	0 s
	PREDISPENSING	0
	PRINTING CYCLE	1
	SINGLE FEED OPERATION	off
	OUTPUT 7	impulse on start
	ANALOG OUTPUT	off
	READY PIN INPUT	LOW active

2.2.1 Material agitation

MATERIAL AGITATION	Switch agitator in dependence on weight and time
LIMIT 1, LIMIT 2, TARGET VALUE WEIGHT + TIME PERCENT WEIGHT VALUE	LIMIT 1, LIMIT 2 or TARGET VALUE are reference quantities for the material agitation. Possible settings: <ul style="list-style-type: none"> • WEIGHT: Enter switch-on value as difference to the reference quantity. • TIME: Enter switch-on time between 0 ... 9999 seconds; The dispensing process is interrupted during the switch-on time. • SWITCH-ON VALUE: Enter switch-on value relative to the reference quantity: 0.1 ... 0.9. • SWITCH-OFF VALUE: Enter switch-off value relative to the reference quantity: 0.1 ... 0.9. • ON: Enter switch-on value as difference to the reference quantity. • OFF: Enter switch-off value as difference to the reference quantity.
Comment	The corresponding values are available in the application blocks 354 ... 358, see section 3.

2.2.2 Remaining quantity

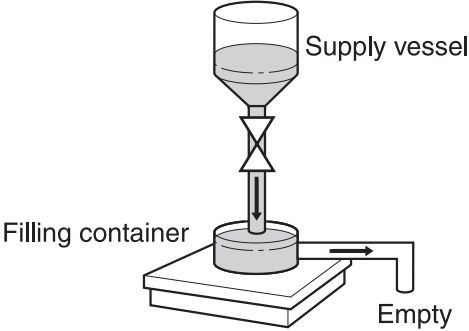
REMAINING QUANTITY	Set remaining quantity during weighing-in
	<p>If the gross weight of the filling container exceeds a specified WEIGHT following a dispensing process, the output OUT2 on the first 8-690 relay box is set to HIGH. The filling container is automatically emptied and the display shows EMPTY. When the WEIGHT is reached, OUT2 is set to LOW again.</p>  <p>The diagram shows a funnel-shaped supply vessel on top of a cylindrical filling container. The filling container sits on a platform scale. An arrow points from the side of the filling container to the word 'Empty', indicating the state of the system when the weight limit is reached.</p>
WEIGHT	Enter absolute switch-on value of the remaining quantity as the weight value.
Comments	<ul style="list-style-type: none"> • The next dispensing process can only be started with the START key if output OUT2 is set to LOW. • With the STOP key output OUT2 can be manually set to LOW. • The absolute switch-on value is available in the application block 356, see section 3.

2.2.3 Fill quantity

FILL QUANTITY	Set fill quantity control during weighing-out
	<p>If the gross weight of the filling container drops below a specified value ALARM VALUE after a dispensing process, output OUT2 on the first 8-690 relay box is set to HIGH.</p> <p>The supply vessel is automatically refilled and the display shows REFILL.</p> <p>When the specified weight value FILL QUANTITY is reached, output OUT2 is set to LOW.</p> <div data-bbox="486 660 1133 873" style="text-align: center;"> <p>The diagram shows a 'Supply vessel' on a platform scale. A tube with a valve connects it to a 'Filling container'. An arrow labeled 'Refill' points down into the supply vessel.</p> </div>
ALARM VALUE	Enter absolute switch-on value of fill quantity control as weight value.
FILL QUANTITY	Enter absolute switch-off value of fill quantity control as weight value.
Comments	<ul style="list-style-type: none"> • The next dispensing process can only be started with the START key if output OUT2 is set to LOW. • With the STOP key output OUT2 can be manually set to LOW. • The ALARM VALUE is available in the application block 356, the FILL QUANTITY in application block 357, see section 3.

2.2.4 Weighing platform switchover

SCALE SWITCHOVER	Switch back and forth between two weighing platforms
MANUAL	Manual switchover with a pulse at input IN 6 of the first 8-690 relay box.
AUTOMATIC WEIGHING-IN SUBTRACTIVE WEIGH.	<p>Switch over automatically.</p> <p>If ACKNOWLEDGE OFF is also set and the output OUT6 (End of Dispensing) on the first 8-690 relay box is connected to the input IN 2 (Start), the dispensing process and change run automatically.</p> <p>To prevent valves from opening when no container is on the scale, the tare monitoring function must be used in this setting.</p> <p>Separate dispensing parameters can be entered for both weighing platforms. This enables the control of two dispensing systems. For weighing platform 1 the dispensing parameters must be saved to target memory 1, and for weighing platform 2 to target memory 2.</p> <p>If the same dispensing parameters are to be used for dispensing on both weighing platforms, target memory 1 and 2 may not be assigned.</p> <p>This function enables the quasi continuous dispensing from two supply vessels standing on weighing platforms 1 and 2.</p> <p>If the entered gross weight value WEIGHT is dropped below, the valves are closed, the stabilization of the weighing platform is waited for and the other weighing platform selected. The interrupted dispensing process is ended from the second container.</p> <p>With this alternative only one parameter set can be used.</p>
Comments	<ul style="list-style-type: none"> • Output OUT2 shows which weighing platform is currently active during the dispensing process: LOW = weighing platform 1, HIGH = weighing platform 2. • The correct weighing platform number automatically appears on the printout. • The weight value WEIGHT required during WEIGHING OUT is available in the application block 356, see section 3.

2.2.5 3rd shutoff point

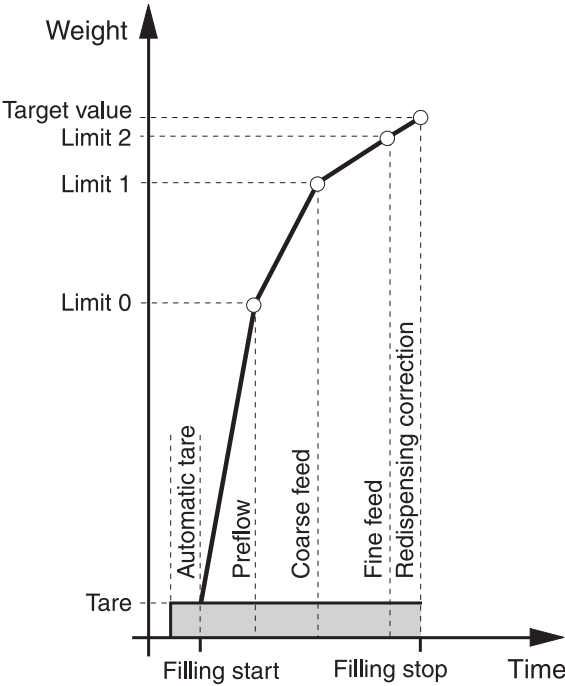
3RD SHUTOFF POINT	Control of a third valve
	<p>Dispensing systems with 3 valves have a 3rd shutoff point (limit 0), which is controlled via output 2. Up to limit 0 (switchover point preflow/coarse feed) dispensing is carried out with preflow.</p> 
<p>Comments</p>	<ul style="list-style-type: none"> • The learn mode is automatically switched off an all 3 limits must be manually entered. • Limit 0 may not be entered greater than limit 1.

2.2.6 FillTool

FillTool is a free configuration and editing tool for IND690-Fill which runs on every PC. It communicates with the IND690-Fill via a serial interface or Ethernet/WLAN and enables convenient configuration and data management, monitoring and conversion from and to ACCESS databases.

Please ask METTLER TOLEDO Customer Service about FillTool.

Setting parameters

All the master mode settings can be made on a screen with FillTool in a clear and concise manner.

Master Mode Settings	
Application	Above Level
ZeroZone	0.0 kg
Automatic Tare	Autotare On
Redisp.Correction	Correction On
Redispersing	Manual
• Pulse Duration	5 Secs
• Pulse Pause	5 Secs
Totalizing	Totalizing Off
Status Indicator	With DeltaTrac
• Indicator Type	Not Enlarged
Password	Off
Pac Start Key	On
Operating Mode	Automatic
Manual Correction	Off
Output2	Output2Off
Monitor Dispensing	Monitor Dispense Off
Learn Mode	On
• Trip Factor Coarse	0.5
• Trip Factor Fine	0.5
Acknowledge	On
Coarse Feed	Coarse
Start Timer	0 Secs
End Timer	0 Secs
Predispensing	0 Secs
Printing Cycle	1
Single Feed operation	On
• Limit	0.0 kg
Output7	Impulse on Start
Freeweigh Mode	Off
Analog Output	Off

Set valves during coarse feed.

Ready 9600,n,8,1

Editing fixed target entries

Fixed target entries can be edited easily with FillTool.

The screenshot shows the 'Fixed Target Entries' window in the Fill Tool application. The window title is 'Fill Tool - C:\Program Files\Mettler Toledo\FillTool\Untitled.mdb'. The menu bar includes 'File', 'System', 'Language', and 'Help'. The toolbar contains icons for 'New', 'Open', 'Save', 'Master Mode', 'Default', 'Settings', 'Read', 'Write', 'About', and 'Exit'. The main area contains a table with the following data:

Index	Name	Target	Limit0	Limit1	Limit2	Tolerance	TareMin	TareMax	Tput.Coarse	Tput.Fine	Tput.Pr
1	Fix-Target 1	1 kg	0 kg	0.2 kg	0.8 kg	0.002 kg	10 kg	12 kg			
2	Fix-Target 2	2 kg	0 kg	0.4 kg	1.9 kg	0.05 kg	5 kg	6 kg			
3	Fix-Target 3	3 kg	0 kg	0.6 kg	2.8 kg	0.1 kg	3 kg	5 kg			
4											
5											
6											
7											
8											
9											
10											
11											
12											

Below the table, there is a status bar with a warning icon and the text: 'Press F2 to Edit, F3 to Save, F4 to Delete and F5 to cancel.' The bottom left corner shows 'Ready' and the bottom right corner shows '9600,n,8,1'.

3 Application blocks

In the following description, the application blocks are shown in the syntax for the MMR command set. When used with the SICS command set, please observe the SICS conventions, see Operating instructions for IND690-Base weighing terminal.

No.	Content	Format
301	Pac version	Response: <code>A,B _ IND690-Fill_Vx.xx_</code>
302	Program number	Response: <code>A,B _ IP64-0-0xxx_</code>
305	Keypad entry or read-in barcode	Response: <code>A,B _ Entry</code> Write: <code>A,W 3,0,5 _ \$ \$ Entry</code> Comment: Entry = Text_20, number or weight value
306	Electronic finger	Response: <code>A,B _ K e y s _ _ _ _ _ 1 _ 1 2 , 2 3 _ 4 , 7</code> Write: Trigger keys for the electronic finger <code>A,W 3,0,6 _ \$ \$ Number (1 ... 12; integral)</code> Each number is assigned a key: 1: N key 2: SUM key 3: CODE A key 4: MAN key 5: LIMIT key 6: CODE B key 7: STOP key 8: CODE C key 9: START key 10: CODE D key 11: CLEAR key 12: ENTER key Correct triggering of the key is confirmed with a beep tone. Recall target memory <code>A,W 3,0,6 _ \$ \$ Number (1 ... 47; integral)</code> Number: 22: Display current dispensing parameters 23_001 ... 23_999 or 23 ... 47: Call up target memory 1 ... 999 or 1 ... 25
310	Item counter	Response: <code>A,B _ Number_4</code>
311	Start value item counter	Response: <code>A,B _ Number_4</code> Write: <code>A,W 3,1,1 _ Number_4</code>
312	Stop value item counter	Response: <code>A,B _ Number_4</code> Write: <code>A,W 3,1,2 _ Number_4</code>
313	Sum net weight	Response: <code>A,B _ Weight value _ Unit</code>
314	Sum gross weight	Response: <code>A,B _ Weight value _ Unit</code>

No.	Content	Format
315	Correction factor for redispensing correction	Response: <input type="text" value="A,B _ Factor (0.0 ... 0.9; step size 0.1)"/> Write: <input type="text" value="A,W 3,1,5 _ Factor (0.0 ... 0.9; step size 0.1)"/>
316	Weight value (actual value) of last filling	Response: <input type="text" value="A,B _ Weight value _ Unit"/>
317	Target – actual difference of last filling	Response: <input type="text" value="A,B _ Weight value _ Unit"/>
318_001 ... 318_006	Identification data Code A ... Code F	Response: <input type="text" value="A,B _ Name (text_20) _ _ Identification (text_20)"/> Write: <input type="text" value="A,W 3,x,x _ Name (text_20) \$ \$ Identification (text_20)"/> Comment: xx = 18_001 ... 18_006; corresponds to the application blocks 094 ... 099
318 ... 321	Identification data Code A ... Code D	Response: equal to 318_001 Write: equal to 318_001 Comment: xx = 18 ... 21; corresponds to the application blocks 094_001 ... 094_004
322	Current dispensing parameters	Response: <input type="text" value="A,B _ Name (text_20) _ _"/> <input type="text" value="Target weight (weight value) _ Unit _ _"/> <input type="text" value="Limit 0 (weight value) _ Unit _ _"/> <input type="text" value="Limit 1 (weight value) _ Unit _ _"/> <input type="text" value="Limit 2 (weight value) _ Unit _ _"/> <input type="text" value="Tolerance (weight value) _ Unit _ _"/> <input type="text" value="Tare min (weight value) _ Unit _ _"/> <input type="text" value="Tare max (weight value) _ Unit _ _"/> <input type="text" value="Throughput preflow (number_2) _ _"/> <input type="text" value="Throughput coarse feed (number_2) _ _"/> <input type="text" value="Throughput fine feed (number_2)"/> Write: <input type="text" value="A,W 3,x,x _ Name (text_20) \$ \$"/> <input type="text" value="Target weight (weight value) _ Unit \$ \$"/> <input type="text" value="Limit 0 (weight value) _ Unit \$ \$"/> <input type="text" value="Limit 1 (weight value) _ Unit \$ \$"/> <input type="text" value="Limit 2 (weight value) _ Unit \$ \$"/> <input type="text" value="Tolerance (weight value) _ Unit \$ \$"/> <input type="text" value="Tare min (weight value) _ Unit \$ \$"/> <input type="text" value="Tare max (weight value) _ Unit \$ \$"/> <input type="text" value="Throughput preflow (number_2) \$ \$"/> <input type="text" value="Throughput coarse feed (number_2) \$ \$"/> <input type="text" value="Throughput fine feed (number_2)"/> Comment xx = 22
323_001 ... 323_999	Target memory 1 ... 999	Response: equal to 322 Write: equal to 322 Comment: xx = 23_001 ... 23_999

No.	Content	Format
323 ... 347	Target memory 1 ... 25	Response: equal to 322 Write: equal to 322 Comment: xx = 23 ... 47
348	Mean value \bar{x}	Response: <input type="text" value="A"/> <input type="text" value="B"/> <input type="text" value="Weight value"/> <input type="text" value="Unit"/>
349	Standard deviation s	Response: <input type="text" value="A"/> <input type="text" value="B"/> <input type="text" value="Weight value"/> <input type="text" value="Unit"/>
350	Minimum x_{Min}	Response: <input type="text" value="A"/> <input type="text" value="B"/> <input type="text" value="Weight value"/> <input type="text" value="Unit"/>
351	Maximum x_{Max}	Response: <input type="text" value="A"/> <input type="text" value="B"/> <input type="text" value="Weight value"/> <input type="text" value="Unit"/>
352	Start/Stop of dispensing	Response: <input type="text" value="A"/> <input type="text" value="B"/> <input type="text" value="x"/> Write: <input type="text" value="A"/> <input type="text" value="W"/> <input type="text" value="3"/> <input type="text" value="5"/> <input type="text" value="2"/> <input type="text" value="x"/> Comment: Start: x = 1, Stop: x = 0
353	Zero threshold value of zero zone	Response: <input type="text" value="A"/> <input type="text" value="B"/> <input type="text" value="Weight value"/> <input type="text" value="k"/> <input type="text" value="g"/> Write: <input type="text" value="A"/> <input type="text" value="W"/> <input type="text" value="3"/> <input type="text" value="5"/> <input type="text" value="3"/> <input type="text" value="Weight value"/> <input type="text" value="k"/> <input type="text" value="g"/>
354	Relative switch-on value for output 2	Response: <input type="text" value="A"/> <input type="text" value="B"/> <input type="text" value="Factor (0.0 ... 0.9; step size 0.1)"/> Write: <input type="text" value="A"/> <input type="text" value="W"/> <input type="text" value="3"/> <input type="text" value="5"/> <input type="text" value="4"/> <input type="text" value="Factor (0.0 ... 0.9; step size 0.1)"/> Comment: only for output 2 = material agitation
355	Relative switch-off value for output 2	Response: <input type="text" value="A"/> <input type="text" value="B"/> <input type="text" value="Factor (0.0 ... 0.9; step size 0.1)"/> Write: <input type="text" value="A"/> <input type="text" value="W"/> <input type="text" value="3"/> <input type="text" value="5"/> <input type="text" value="5"/> <input type="text" value="Factor (0.0 ... 0.9; step size 0.1)"/> Comment: only for output 2 = material agitation
356	Absolute switch-on value for output 2	Response: <input type="text" value="A"/> <input type="text" value="B"/> <input type="text" value="Weight value"/> <input type="text" value="Unit"/> Write: <input type="text" value="A"/> <input type="text" value="W"/> <input type="text" value="3"/> <input type="text" value="5"/> <input type="text" value="6"/> <input type="text" value="Weight value"/> <input type="text" value="Unit"/> Comment: with material agitation, fill quantity
357	Absolute switch-off value for output 2	Response: <input type="text" value="A"/> <input type="text" value="B"/> <input type="text" value="Weight value"/> <input type="text" value="Unit"/> Write: <input type="text" value="A"/> <input type="text" value="W"/> <input type="text" value="3"/> <input type="text" value="5"/> <input type="text" value="7"/> <input type="text" value="Weight value"/> <input type="text" value="Unit"/> Comment: with material agitation, fill quantity
358	Switch-on time for output 2 in seconds	Response: <input type="text" value="A"/> <input type="text" value="B"/> <input type="text" value="Number_4"/> Write: <input type="text" value="A"/> <input type="text" value="W"/> <input type="text" value="3"/> <input type="text" value="5"/> <input type="text" value="8"/> <input type="text" value="Number_4"/> Comment: only for output 2 = material agitation

No.	Content	Format																																
359	Status of output 2	Response: <input type="text" value="A"/> <input type="text" value="B"/> <input type="text" value="_"/> <input type="text" value="Code (Number_4)"/> , e.g.: <table border="0"> <thead> <tr> <th data-bbox="762 383 826 409">Code</th> <th data-bbox="884 383 979 409">Meaning</th> </tr> </thead> <tbody> <tr> <td>0000</td> <td>Output 2 off</td> </tr> <tr> <td>0001</td> <td>Remaining quantity</td> </tr> <tr> <td>0002</td> <td>Fill quantity</td> </tr> <tr> <td>0003</td> <td>Scale switchover – manual</td> </tr> <tr> <td>0004</td> <td>3rd shutoff point – absolute weight value</td> </tr> <tr> <td>0006</td> <td>Scale switchover – automatic</td> </tr> <tr> <td>0013</td> <td>Material agitation – target value – percent</td> </tr> <tr> <td>0014</td> <td>Material agitation – target value – weight value</td> </tr> <tr> <td>0015</td> <td>Material agitation – target value – weight + time</td> </tr> <tr> <td>0023</td> <td>Material agitation – limit 1 – percent</td> </tr> <tr> <td>0024</td> <td>Material agitation – limit 1 – weight value</td> </tr> <tr> <td>0025</td> <td>Material agitation – limit 1 – weight + time</td> </tr> <tr> <td>0033</td> <td>Material agitation – limit 2 – percent</td> </tr> <tr> <td>0034</td> <td>Material agitation – limit 2 – weight value</td> </tr> <tr> <td>0035</td> <td>Material agitation – limit 2 – weight + time</td> </tr> </tbody> </table> Write: <input type="text" value="A"/> <input type="text" value="W"/> <input type="text" value="3"/> <input type="text" value="5"/> <input type="text" value="9"/> <input type="text" value="_"/> <input type="text" value="Code (number_4)"/>	Code	Meaning	0000	Output 2 off	0001	Remaining quantity	0002	Fill quantity	0003	Scale switchover – manual	0004	3rd shutoff point – absolute weight value	0006	Scale switchover – automatic	0013	Material agitation – target value – percent	0014	Material agitation – target value – weight value	0015	Material agitation – target value – weight + time	0023	Material agitation – limit 1 – percent	0024	Material agitation – limit 1 – weight value	0025	Material agitation – limit 1 – weight + time	0033	Material agitation – limit 2 – percent	0034	Material agitation – limit 2 – weight value	0035	Material agitation – limit 2 – weight + time
Code	Meaning																																	
0000	Output 2 off																																	
0001	Remaining quantity																																	
0002	Fill quantity																																	
0003	Scale switchover – manual																																	
0004	3rd shutoff point – absolute weight value																																	
0006	Scale switchover – automatic																																	
0013	Material agitation – target value – percent																																	
0014	Material agitation – target value – weight value																																	
0015	Material agitation – target value – weight + time																																	
0023	Material agitation – limit 1 – percent																																	
0024	Material agitation – limit 1 – weight value																																	
0025	Material agitation – limit 1 – weight + time																																	
0033	Material agitation – limit 2 – percent																																	
0034	Material agitation – limit 2 – weight value																																	
0035	Material agitation – limit 2 – weight + time																																	
360	Items poor (items outside tolerance)	Response: <input type="text" value="A"/> <input type="text" value="B"/> <input type="text" value="_"/> <input type="text" value="Number_4"/>																																

No.	Content	Format																																																																																
361	Dispensing state	<p>Response: <input type="text" value="A"/> <input type="text" value="B"/> <input type="text" value="_"/> Code (number_3) , e.g.:</p> <table border="1"> <thead> <tr> <th data-bbox="730 383 826 412">Code</th> <th data-bbox="852 383 954 412">Meaning</th> </tr> </thead> <tbody> <tr><td>000</td><td>Basic or switch-on state</td></tr> <tr><td>005</td><td>Material agitation, weight + time, output 2 = HIGH</td></tr> <tr><td>010</td><td>Ready for dispensing (dispensing parameters loaded)</td></tr> <tr><td>020</td><td>Zero monitoring</td></tr> <tr><td>022</td><td>Overload or underload during redispensing</td></tr> <tr><td>030</td><td>Taring with automatic tare</td></tr> <tr><td>037</td><td>Display WRONG TARE</td></tr> <tr><td>040</td><td>Coarse feed on</td></tr> <tr><td>042</td><td>Coarse feed off with STOP key</td></tr> <tr><td>044</td><td>Below level application cancelled: Wait until nozzle is up</td></tr> <tr><td>046</td><td>Learn mode: Coarse feed off through overload or underload</td></tr> <tr><td>050</td><td>Fine feed on</td></tr> <tr><td>052</td><td>Fine feed off with STOP key</td></tr> <tr><td>056</td><td>Fine feed off through overload or underload</td></tr> <tr><td>060</td><td>Fine feed off: Wait until nozzle is up</td></tr> <tr><td>070</td><td>Dispensing ended: Evaluation of the dispensing results</td></tr> <tr><td>072</td><td>Dispensing ended: Intermediate stop with STOP key</td></tr> <tr><td>074</td><td>Redispensing: During the pulse duration fine feed off with STOP key</td></tr> <tr><td>075</td><td>Redispensing: During the pulse duration fine feed on</td></tr> <tr><td>076</td><td>Redispensing: During the pulse pause fine feed off</td></tr> <tr><td>078</td><td>Redispensing: During the pulse pause fine feed off with STOP key</td></tr> <tr><td>084</td><td>Display UNDERFILLED</td></tr> <tr><td>085</td><td>Display OVERFLOW SUM REACHED</td></tr> <tr><td>087</td><td>Display END VALUE REACHED</td></tr> <tr><td>088</td><td>Display of net weight sum</td></tr> <tr><td>090</td><td>End timer running</td></tr> <tr><td>101</td><td>Display DISPENSING OKAY</td></tr> <tr><td>111</td><td>Display OVERFILLED</td></tr> <tr><td>130</td><td>Empty during remaining quantity</td></tr> <tr><td>140</td><td>Redispensing for fill quantity</td></tr> <tr><td>150</td><td>Preflow on</td></tr> <tr><td>152</td><td>Preflow off with STOP key</td></tr> <tr><td>235</td><td>Coarse feed off through overload or underload</td></tr> <tr><td>242</td><td>Learn mode: Coarse feed off</td></tr> <tr><td>245</td><td>Learn mode: Fine feed on</td></tr> <tr><td>246</td><td>Learn mode: Fine feed off through overload or underload</td></tr> <tr><td>250</td><td>Learn mode: Fine feed off with STOP key</td></tr> <tr><td>253</td><td>Monitor dispensing: Positive monitoring</td></tr> <tr><td>254</td><td>Monitor dispensing: Negative monitoring</td></tr> </tbody> </table> <p>Write: <input type="text" value="A"/> <input type="text" value="W"/> <input type="text" value="3"/> <input type="text" value="6"/> <input type="text" value="1"/> <input type="text" value="_"/> <input type="text" value="0"/> <input type="text" value="0"/> <input type="text" value="0"/> Reset to basic state. In the process the current dispensing parameters are deleted and impermissible steps may be carried out, e.g. deleting the sum when TOTALIZING ON is set.</p>	Code	Meaning	000	Basic or switch-on state	005	Material agitation, weight + time, output 2 = HIGH	010	Ready for dispensing (dispensing parameters loaded)	020	Zero monitoring	022	Overload or underload during redispensing	030	Taring with automatic tare	037	Display WRONG TARE	040	Coarse feed on	042	Coarse feed off with STOP key	044	Below level application cancelled: Wait until nozzle is up	046	Learn mode: Coarse feed off through overload or underload	050	Fine feed on	052	Fine feed off with STOP key	056	Fine feed off through overload or underload	060	Fine feed off: Wait until nozzle is up	070	Dispensing ended: Evaluation of the dispensing results	072	Dispensing ended: Intermediate stop with STOP key	074	Redispensing: During the pulse duration fine feed off with STOP key	075	Redispensing: During the pulse duration fine feed on	076	Redispensing: During the pulse pause fine feed off	078	Redispensing: During the pulse pause fine feed off with STOP key	084	Display UNDERFILLED	085	Display OVERFLOW SUM REACHED	087	Display END VALUE REACHED	088	Display of net weight sum	090	End timer running	101	Display DISPENSING OKAY	111	Display OVERFILLED	130	Empty during remaining quantity	140	Redispensing for fill quantity	150	Preflow on	152	Preflow off with STOP key	235	Coarse feed off through overload or underload	242	Learn mode: Coarse feed off	245	Learn mode: Fine feed on	246	Learn mode: Fine feed off through overload or underload	250	Learn mode: Fine feed off with STOP key	253	Monitor dispensing: Positive monitoring	254	Monitor dispensing: Negative monitoring
Code	Meaning																																																																																	
000	Basic or switch-on state																																																																																	
005	Material agitation, weight + time, output 2 = HIGH																																																																																	
010	Ready for dispensing (dispensing parameters loaded)																																																																																	
020	Zero monitoring																																																																																	
022	Overload or underload during redispensing																																																																																	
030	Taring with automatic tare																																																																																	
037	Display WRONG TARE																																																																																	
040	Coarse feed on																																																																																	
042	Coarse feed off with STOP key																																																																																	
044	Below level application cancelled: Wait until nozzle is up																																																																																	
046	Learn mode: Coarse feed off through overload or underload																																																																																	
050	Fine feed on																																																																																	
052	Fine feed off with STOP key																																																																																	
056	Fine feed off through overload or underload																																																																																	
060	Fine feed off: Wait until nozzle is up																																																																																	
070	Dispensing ended: Evaluation of the dispensing results																																																																																	
072	Dispensing ended: Intermediate stop with STOP key																																																																																	
074	Redispensing: During the pulse duration fine feed off with STOP key																																																																																	
075	Redispensing: During the pulse duration fine feed on																																																																																	
076	Redispensing: During the pulse pause fine feed off																																																																																	
078	Redispensing: During the pulse pause fine feed off with STOP key																																																																																	
084	Display UNDERFILLED																																																																																	
085	Display OVERFLOW SUM REACHED																																																																																	
087	Display END VALUE REACHED																																																																																	
088	Display of net weight sum																																																																																	
090	End timer running																																																																																	
101	Display DISPENSING OKAY																																																																																	
111	Display OVERFILLED																																																																																	
130	Empty during remaining quantity																																																																																	
140	Redispensing for fill quantity																																																																																	
150	Preflow on																																																																																	
152	Preflow off with STOP key																																																																																	
235	Coarse feed off through overload or underload																																																																																	
242	Learn mode: Coarse feed off																																																																																	
245	Learn mode: Fine feed on																																																																																	
246	Learn mode: Fine feed off through overload or underload																																																																																	
250	Learn mode: Fine feed off with STOP key																																																																																	
253	Monitor dispensing: Positive monitoring																																																																																	
254	Monitor dispensing: Negative monitoring																																																																																	

No.	Content	Format
362	Sensitivity of dispensing monitoring	Read: <input type="text" value="A"/> <input type="text" value="B"/> <input type="text" value=""/> <input type="text" value="Number_12"/> Write: <input type="text" value="A"/> <input type="text" value="W"/> <input type="text" value="3"/> <input type="text" value="6"/> <input type="text" value="2"/> <input type="text" value=""/> <input type="text" value="Number_12"/>
363	Trip factor coarse feed in learn mode	Read: <input type="text" value="A"/> <input type="text" value="B"/> <input type="text" value=""/> <input type="text" value="Factor (0.1 ... 0.9; step size 0.1)"/> Write: <input type="text" value="A"/> <input type="text" value="W"/> <input type="text" value="3"/> <input type="text" value="6"/> <input type="text" value="3"/> <input type="text" value=""/> <input type="text" value="Factor (0.1 ... 0.9; step size 0.1)"/>
364	Dispensing result: Gross weight	Response: <input type="text" value="A"/> <input type="text" value="B"/> <input type="text" value=""/> <input type="text" value="Weight value"/> <input type="text" value=""/> <input type="text" value="Unit"/>
365	Dispensing result: Net weight	Response: <input type="text" value="A"/> <input type="text" value="B"/> <input type="text" value=""/> <input type="text" value="Weight value"/> <input type="text" value=""/> <input type="text" value="Unit"/>
366	Transfer block for analog output	Response: <input type="text" value="A"/> <input type="text" value="B"/> <input type="text" value=""/> <input type="text" value="Weight value"/> <input type="text" value=""/> <input type="text" value="Unit"/>
367	Trip factor fine feed in learn mode	Read: <input type="text" value="A"/> <input type="text" value="B"/> <input type="text" value=""/> <input type="text" value="Factor (0.1 ... 0.9; step size 0.1)"/> Write: <input type="text" value="A"/> <input type="text" value="W"/> <input type="text" value="3"/> <input type="text" value="6"/> <input type="text" value="7"/> <input type="text" value=""/> <input type="text" value="Factor (0.1 ... 0.9; step size 0.1)"/>

4 What to do if ...?

Error / Display	Possible causes	Remedy
– EMPTY –	<ul style="list-style-type: none"> Output 2 = Remaining quantity, container is automatically emptied 	→ Wait until the container is empty
– REFILL –	<ul style="list-style-type: none"> Output 2 = Fill quantity, container is refilled 	→ Wait until the fill quantity is reached
– TARE –	<ul style="list-style-type: none"> Automatic taring during start of dispensing process 	→ Wait until scale is stabilized and tared
NOT ZERO	<ul style="list-style-type: none"> Below-level dispensing: Nozzle has run dry 	→ Prevent nozzle from running dry, acknowledge and restart
READY FOR DISPENSING	<ul style="list-style-type: none"> Filling process may be started 	→ Press START key
ENDVALUE REACHED	<ul style="list-style-type: none"> Item counter has reached end-value 	→ Recall sum and delete
MANUAL	<ul style="list-style-type: none"> Underfilled, manual redispensing possible 	→ Press MAN key until target weight is reached
LEARN MODE IS OFF	<ul style="list-style-type: none"> Learn mode switched off and limit 1 and/or limit 2 not entered 	→ Switch on learn mode or enter limit
LIMIT 2 TOO LARGE	<ul style="list-style-type: none"> Value for limit 2 too large 	→ Decrease limit 2
LIMIT 0 TOO LARGE	<ul style="list-style-type: none"> Limit 0 greater than limit 1 entered 	→ Enter limit 0 less than limit 1
LIM 2 EXCEEDS MAXLOAD	<ul style="list-style-type: none"> Limit 2 is greater than the maximum load of the active weighing platform 	→ Select limit 2 less than the maximum load of this weighing platform
MANUAL CORRECTION	<ul style="list-style-type: none"> Container overfilled or underfilled 	→ Manually remove or add dispensing product
MAX LIM	<ul style="list-style-type: none"> Limit 1 or limit 2 too large 	→ Decrease limit 1 or limit 2
MAX TOL	<ul style="list-style-type: none"> Tolerance too large 	→ Decrease tolerance
ZERO NOT ALLOWED	<ul style="list-style-type: none"> Entered value smaller than 1 	→ Increase value
CLEAR SUM	<ul style="list-style-type: none"> Totalizing function switched on 	→ Clear sum
MEMORY FULL	<ul style="list-style-type: none"> Memory has reached maximum value 	→ Clear sum
WRONG TARE	<ul style="list-style-type: none"> Container on weighing platform outside entered tare limits 	→ Place correct filling container on weighing platform
TMAX EXCEEDS MAXLOAD TMIN EXCEEDS MAXLOAD	<ul style="list-style-type: none"> Entered tare limits above weighing platform maximum load 	→ Decrease values for tare min. and tare max. accordingly

Error / Display	Possible causes	Remedy
TMAX LESS THAN TMIN	<ul style="list-style-type: none"> Maximum tare value is less than minimum tare value 	→ Increase max. tare value and decrease min. tare value
TOLERANCE INADMISS.	<ul style="list-style-type: none"> Tolerance too small for weighing platform or too large for tolerance table 	→ Enter tolerance in permissible range
OVERFILLED	<ul style="list-style-type: none"> Filling container overfilled 	→ Confirm or correct manually
UNDERFILLED	<ul style="list-style-type: none"> Filling container underfilled 	→ Confirm or correct manually
CONTINUE WITH START	<ul style="list-style-type: none"> Filling process interrupted with STOP key 	→ START key continues dispensing process, STOP key ends dispensing process
NO VALUE	<ul style="list-style-type: none"> 0 was entered for a dispensing parameter 	→ Enter value greater than 0
NO RELAY BOX-8	<ul style="list-style-type: none"> Dispensing process started without Relay box 8-690 or 4 I/O-690 	<p>→ If dispensing is to be carried out without relay box 8-690, 4 I/O-690 or ProfibusDP-690, confirm the message with ENTER.</p> <p>→ Otherwise connect Relay box 8-690 or 4 I/O-690 correctly</p>
TIMEOUT RELAY BOX: X	<ul style="list-style-type: none"> IND690-Fill can no longer access Relay box-8 because, for example, the connecting line has been interrupted 	<p>→ Confirm the message with ENTER, IND690-Fill goes into the basic state</p> <p>→ Connection to Relay box-8 re-established. A new dispensing process can now be started.</p>

5 Technical data

Dispensing functions	
Dispensing	<ul style="list-style-type: none"> • Controlling of coarse and fine flow of material feed for liquid, pasty and pourable weighing samples • Learn mode: automatic determination of dispensing parameters (coarse and fine feed) • Redispensing correction: Optimization of the fine-feed shutoff point (limit 2) • Tolerance check with automatic redispensing • Manual redispensing via keypad • Differentiation between below- and above-level dispensing • Control of elements of a below-level dispensing system
Dispensing parameters	<ul style="list-style-type: none"> • Entry of dispensing parameters either directly via keypad, by recalling from one of 999 fixed memories or via serial data interface • Input format: up to 8 places including decimal point • Tolerance input for certified scales \leq national calibration regulations, for non-certified scales up to maximum target value
Tare functions	<ul style="list-style-type: none"> • Automatic tare compensation at start of dispensing • Tare monitoring in accordance with specified value
Memory	999 target memories for frequently dispensed components
Status display	Documentation of current dispensing process either with clear text or analog weigh-in aid DeltaTrac or BIG WEIGHT DISPLAY
Item counter	Up to 9,999, start value and stop value can be set as desired
Totalizing	Net sum, gross sum, item counter, standard deviation, mean value, x_{\min} and x_{\max}
Sum memory	Up to 8 places including decimal point

6 Appendix

6.1 Connection diagram and terminal assignment for 8-690 relay box

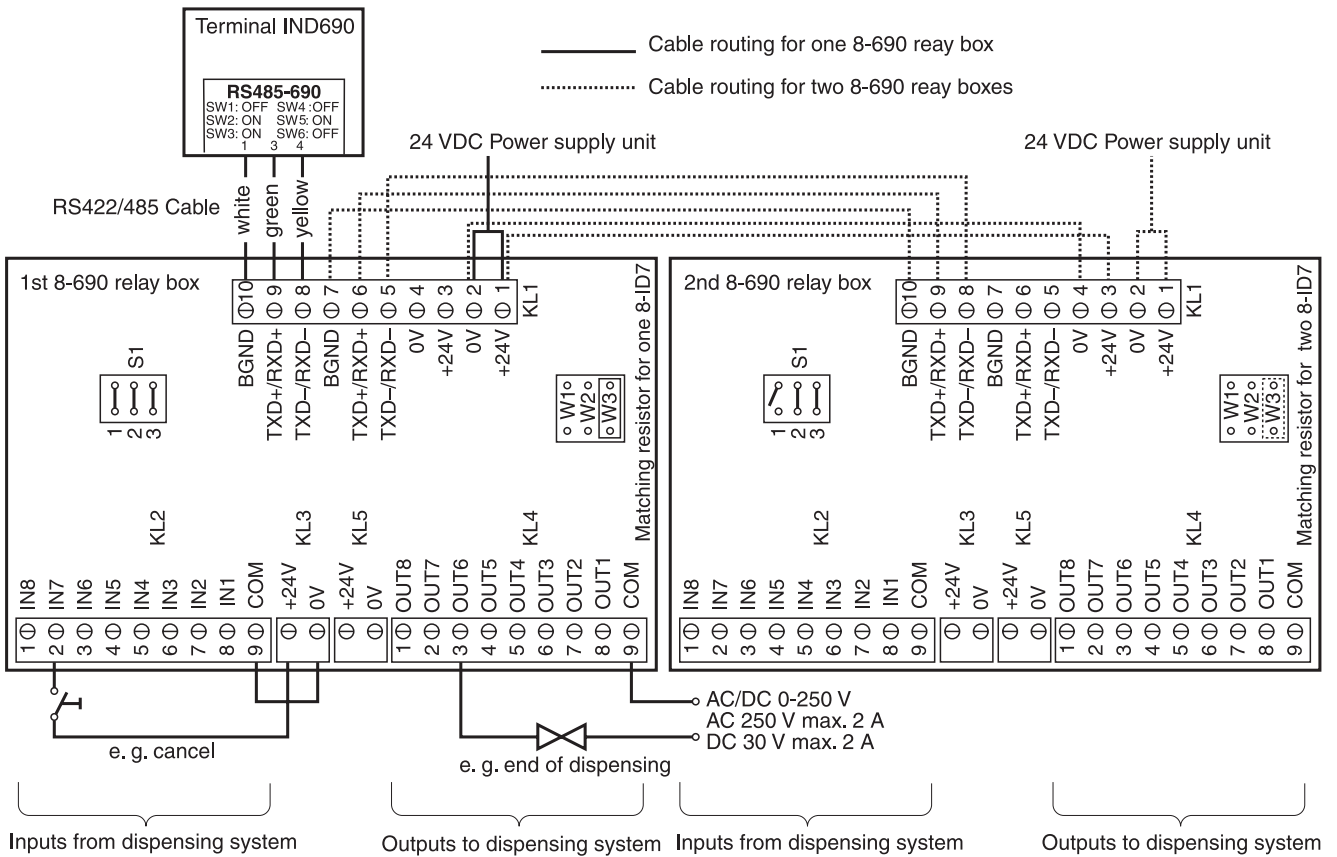

Note

The first 8-690 relay box can also be replaced with 4 I/O-690 interfaces and 4-690 relay boxes.

1st relay box 4-690 on COM6	IN1 ... IN4	Terminal 2, IN0 ... IN3
	OUT1 ... OUT4	Terminal 3, OUT0 ... OUT3
2nd relay box 4-690 on COM5	IN5 ... IN8	Terminal 2, IN4 ... IN7
	OUT5 ... OUT8	Terminal 3, OUT4 ... OUT7

First 8-690 relay box

Assignment with factory setting. For individual assignment, see CONFIGURATION OF INPUTS AND OUTPUTS in master mode of relay box 8 or 4 I/O.

Terminal KL2	Assignment	Inputs from dispensing system	Meaning
8	IN1	Nozzle	With the application BELOW LEVEL WITHOUT NOZZLE CONTROL: Signal with which the IND690-Fill carries out zero monitoring or before the start of the dispensing process, or waits with the evaluation until the nozzle is no longer in the liquid
7	IN2	Start (PLC)	For starting dispensing
6	IN3	Stop (PLC)	For stopping dispensing
5	IN4	Confirm	Confirmation of underfilling/overfilling/acceptable dispensing
4	IN5	Ready	Dispensing system ready
3	IN6	Scale switchover	Manual switchover between several weighing platforms, e.g. for SCALE SWITCHOVER
2	IN7	Cancel	Immediate cancelling of dispensing (emergency stop), then IND690-Fill returns to the basic status
1	IN8	Lock keypad	When IN 8 is set to HIGH, the keypad of the IND690-Fill is locked

Terminal KL4	Assignment	Outputs to dispensing system	Meaning
8	OUT1	Fine feed	For connecting fine feed valve/feed chute, etc.
7	OUT2	Output 2	For various settings of OUTPUT 2, see section 2.2
6	OUT3	Coarse feed	For connecting coarse feed valve/feed chute, etc.
5	OUT4	Poor	Reporting of poor dispensing result (UNDERFILLED, OVERFILLED) or of another error status (WRONG TARE; NOT ZERO)
4	OUT5	Acceptable	Reporting of acceptable dispensing result
3	OUT6	End of dispensing	Filling completed
2	OUT7	Start/output 7	Start pulse for external control for BELOW LEVEL WITHOUT NOZZLE CONTROL application or for settings of OUTPUT 7, see section 2.2
1	OUT8	Ready	Ready to start dispensing

Second 8-690 relay box

Assignment with factory setting. For individual assignment, see CONFIGURATION OF INPUTS AND OUTPUTS in master mode of relay box 8 or 4 I/O.

Terminal KL2	Assignment	Inputs from dispensing system	Meaning
8	IN1	Nozzle up	Only with NOZZLE CONTROL ON: detection of basic nozzle position
7	IN2	Nozzle down	Only with NOZZLE CONTROL ON: detection of bottom nozzle position
6	IN3	Nozzle middle	Only with NOZZLE CONTROL ON: detection of middle nozzle position
5	IN4	Drip pan back	Only with DRIP PAN ON: checking of retracted drip pan prior to lowering nozzle
4	IN5	not assigned	–
3	IN6	not assigned	–
2	IN7	not assigned	–
1	IN8	not assigned	–

Terminal KL4	Assignment	Outputs to dispensing system	Meaning
8	OUT1	Nozzle down	Only with NOZZLE CONTROL ON: move nozzle down
7	OUT2	Nozzle up	Only with NOZZLE CONTROL ON: move nozzle up
6	OUT3	Drip pan forward	Only with DRIP PAN ON: move drip pan under nozzle
5	OUT4	Nozzle on	Only with NOZZLE CONTROL ON: move nozzle up or down
4	OUT5	Nozzle correction	Only with NOZZLE CONTROL ON: prefeed, coarse-feed or fine-feed valve open
3	OUT6	Regasing	Output signal while stop timer running
2	OUT7	Pregasing	Output signal while start timer running
1	OUT8	not assigned	–

6.2 Sequence chart

6.2.1 Below-level application

NOZZLE CONTROL OFF and DRIP PAN OFF

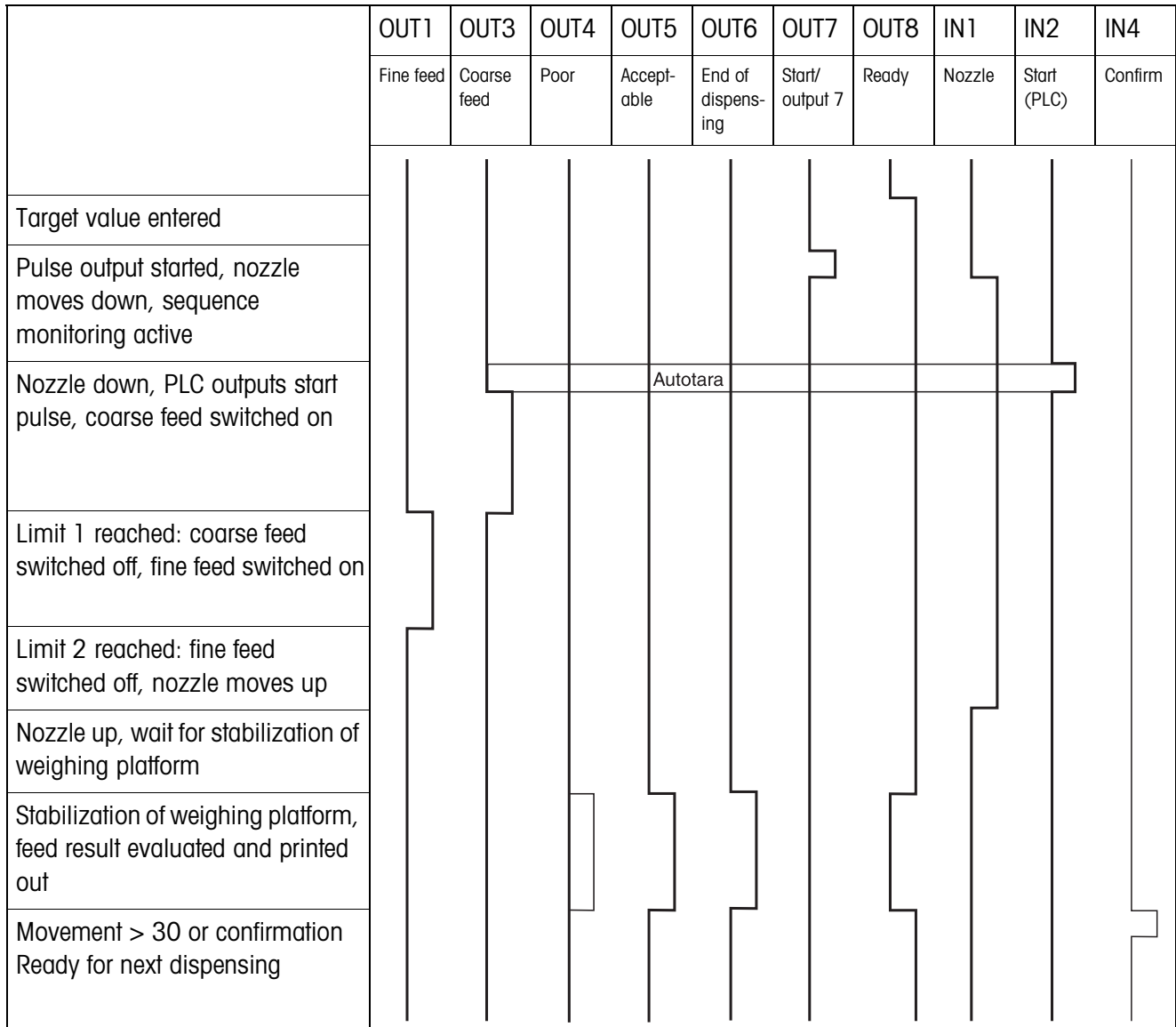

NOZZLE CONTROL ON and DRIP PAN ON

The following sequence chart shows the assigned inputs and outputs of the second 8-690 relay box.

The first 8-690 relay box is assigned in accordance with the flow chart "NOZZLE CONTROL OFF and DRIP PAN OFF", with the exception of the sequence monitoring for the nozzle (IN1, IN2).

	OUT1	OUT2	OUT3	OUT4	OUT5	IN1	IN2	IN3	IN4
	Nozzle down	Nozzle up	Drip pan forward	Nozzle on	Correct nozzle	Nozzle up	Nozzle down	Nozzle middle	Drip pan back
Basic position: nozzle up and drip pan at front	High	Low	Low	Low	Low	Low	Low	Low	Low
Start of dispensing: drip pan moves back	High	Low	High	Low	Low	Low	Low	Low	High
Drip-pan limit switch reached: nozzle moves down	Low	Low	High	Low	Low	High	Low	Low	High
Lower limit switch reached: nozzle stops, weighing platform is tared, dispensing procedure starts	High	Low	High	Low	Low	High	Low	Low	High
While coarse or fine feed is switched on: correct nozzle	High	Low	High	Low	High	High	Low	Low	High
Limit 2 reached: nozzle moves up	High	High	High	Low	High	High	Low	Low	High
Middle position of nozzle: evaluation or refilling	High	Low	High	Low	High	High	High	High	High
Nozzle moves back to upper end position	High	High	High	Low	High	High	Low	Low	High
Nozzle up: drip pan moves forward again	High	Low	Low	Low	High	High	Low	Low	Low
Basic position: nozzle up and drip pan at front Ready for next dispensing	High	Low	Low	Low	Low	Low	Low	Low	Low

6.2.2 Below-bunghole application

The same sequence charts apply to the below-bunghole application as for the below-level application, however the middle end position is moved to instead of the bottom end position.

6.2.3 Above-level application

	OUT1	OUT3	OUT4	OUT5	OUT6	OUT7	OUT8	IN4
	Fine feed	Coarse feed	Poor	Acceptable	End of dispensing	Start/output 7	Ready	Acknowledge
Target value entered								
Pulse output started, coarse feed switched on								
Limit 1 reached: coarse feed switched off, fine feed switched on								
Limit 2 reached: fine feed switched off, wait for stabilization of weighing platform								
Stabilization of weighing platform, dispensing result evaluated and printed out								
Movement > 30 digit or acknowledgement Ready for next dispensing								

7 Index

A

Acknowledge 22
Automatic tare 16

C

Coarse feed 22

D

Dispensing 7
Dispensing functions 4
Dispensing parameters 7
Dispensing system 5

E

Electronic finger 5
End timer 23
Error messages 38

F

Fill quantity 19
Function keys 4

I

Item counter 4, 12

L

Learn mode 6, 20
Limit 0 29

M

Manual recorection 11, 19
Material agitation 19
Monitor dispensing 21

O

Operating mode 19
Outputs 19, 24

P

Pac start key 18
Password block 18
Predispensing 23

R

Recall information 13
Redispensing 11, 17
Redispensing correction 6,
16
Remaining quantity 19
Reset Pac 25

S

Scales switchover 19
Single feed operation 24
Start timer 23
Status indicator 8, 18

T

Target memory 7, 17
Technical data 40
Totalizing 12, 18

W

What to do if ...? 38

Z

Zero zone 15



22012836B

Subject to technical changes © Mettler-Toledo (Albstadt) GmbH 09/08 Printed in Germany 22012836B

Mettler-Toledo (Albstadt) GmbH

D-72458 Albstadt

Tel. ++49-7431-14 0, Fax ++49-7431-14 232

Internet: <http://www.mt.com>