

ICS639

Weighing terminals Terminal and platform combinations

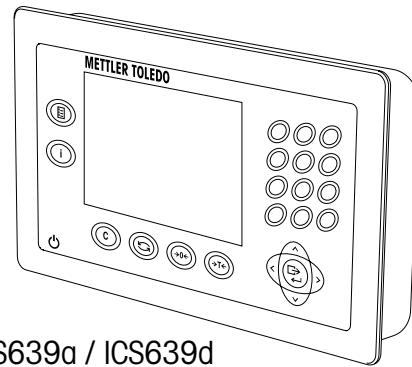

ICS639a / ICS639d

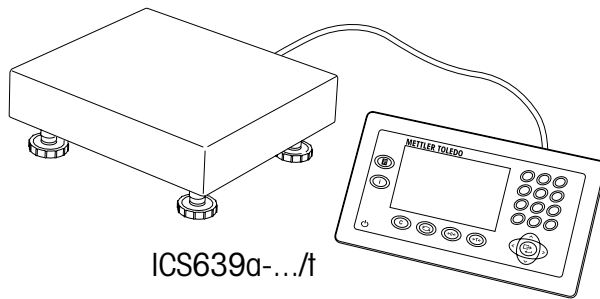

ICS639a-.../t

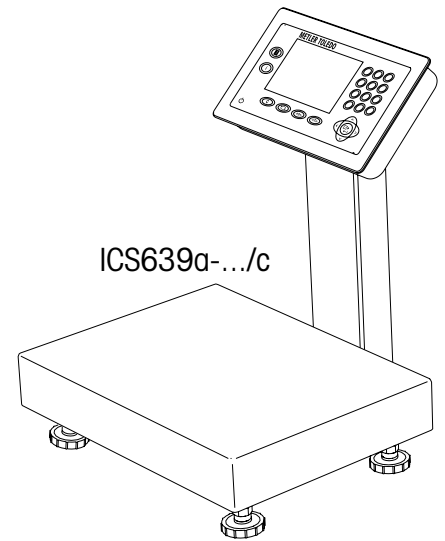

ICS639a-.../c

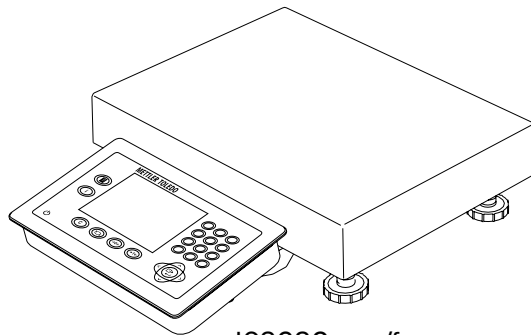

ICS639a-.../f

ServiceXXL

Tailored Services

Congratulations on choosing the quality and precision of METTLER TOLEDO. Proper use according to these instructions and regular calibration and maintenance by our factory-trained service team ensure dependable and accurate operation to protect your investment. Contact us about a ServiceXXL agreement tailored to your needs and budget.

We invite you to register your product at

www.mt.com/productregistration

so we can contact you about enhancements, updates and important notifications concerning your METTLER TOLEDO product.

Contents

1	Introduction.....	5
1.1	Safety instructions	5
1.2	Presentation.....	6
1.3	Tracking and tracing features	13
1.4	Commissioning	15
1.5	Use in hygienically sensitive areas.....	17
2	Operation.....	18
2.1	Switching on and off	18
2.2	Zeroing / Zero point correction.....	19
2.3	Simple weighing.....	19
2.4	Weighing with tare.....	19
2.5	Displaying the capacity available	21
2.6	Switching scales.....	21
2.7	Average (dynamic) weighing.....	22
2.8	Working with identifications	22
2.9	Printing results	23
2.10	Displaying information	23
2.11	Environment and cleaning	24
2.12	Verification test.....	26
3	Settings in the menu.....	27
3.1	Operating the menu	27
3.2	Scale menu block – analog scales	30
3.3	Scale menu block – IDNet scales	33
3.4	Application menu block.....	36
3.5	Terminal menu block.....	38
3.6	Communication menu block.....	42
3.7	Maintenance menu block.....	51
4	Quick Select menu.....	53
4.1	Quick Select menu overview	53
4.2	Entering main menu.....	53
4.3	Logout.....	53
4.4	Performing routine test	54
4.5	Calling up routine test log file.....	55
4.6	Calling up alibi log file.....	56
4.7	Calling up calibration log file.....	57
5	Event and error messages.....	58
5.1	Error conditions	58
5.2	Errors and warnings.....	59
5.3	Smart weighing counter / spanner icon	61

6	Technical data and accessories.....	62
6.1	Technical data weighing terminal	62
6.2	Technical data weighing platforms	65
6.3	Accessories.....	69
7	Appendix	72
7.1	Tests for utilisation in hygienically sensitive areas	72
7.2	Notice for verified instruments in EC countries.....	72
7.3	Tables of Geo Code values.....	73
7.4	Disposal	74
7.5	Protocol printouts	75
7.6	Index.....	76

1 Introduction

1.1 Safety instructions



General

- ▲ Do not use the device in a hazardous environment. Special devices are available in our range of products for hazardous environments.
- ▲ The safety of the device cannot be ensured if it is not operated in accordance with these operating instructions.
- ▲ Only authorised personnel may open the device.



Devices with built-in power supply unit

- ▲ Ensure that the power socket outlet for the device is earthed and easily accessible, so that it can be de-energised rapidly in emergencies.
- ▲ Ensure that the supply voltage at the installation site lies within the range of 100 V to 240 V.
- ▲ Check the power cable regularly for damage. If it is damaged, immediately disconnect the device from the power supply.
- ▲ Ensure that there is a space of at least 3 cm (1.25") at the rear in order to prevent the power cable from being bent too strongly.



Devices with built-in storage battery

- ▲ Do not use the battery charger in humid or dusty rooms or below 0 °C (32 °F) ambient temperature.
- ▲ After the built-in storage battery has been charged, the cover cap of the charging socket at the device must be closed.



Terminal and platform combinations

- ▲ The maximum static safe load must never be exceeded. Observe the operation limits, see Technical data.
- ▲ Avoid falling loads, shock loads as well as impacts from the side.

1.2

Presentation

1.2.1

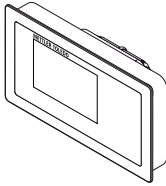

Weighing terminals

There are two versions of the ICS639 weighing terminal:

ICS639a with analog scale interface:

to connect analog METTLER TOLEDO weighing platforms

ICS639d with digital scale interface:

to connect METTLER TOLEDO weighing platforms with IDNet interface

On the rear the weighing terminal is equipped with a swivel bracket for mounting the terminal on the wall or to a METTLER TOLEDO column. As an accessory a table stand for setting up the terminal on the table is available.

1.2.2

Terminal and platform combinations

The complete name of a terminal and platform combination also indicates the type, size and capacity of the connected analog weighing platform. E.g., ICS639a-A6/c stands for

ICS639a type of weighing terminal and type of weighing interface

A design and size of the weighing platform

6 weighing platform capacity in kg

c mechanical design

As default the weighing platforms are equipped with a hermetically sealed stainless steel load cell and a readability setting of 2 x 3000 or 5000 divisions, non-approved.

ICS639a-.../f

The weighing terminal is fixed mounted in front of the weighing platform.

Terminal and platform can be handled as one unit, easy to install and to change location.

The perfect solution if a stand or a bracket would hinder an effective working process.

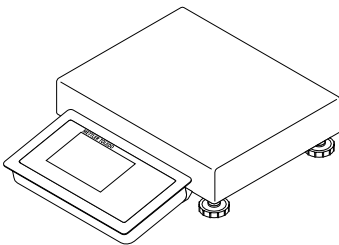

ICS639a-.../t

Weighing terminal and weighing platform are connected by cable.

Suitable for wall mount operation and desk operation with an additional desk mounting plate, see Options. The combination can be upgraded with a stand, see Accessories.

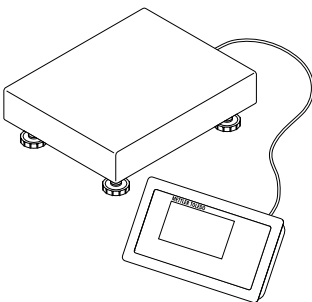

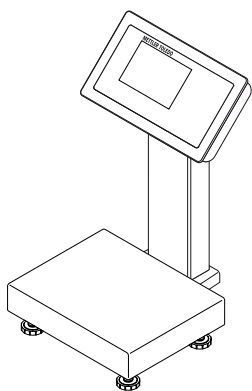

ICS639a-.../c

Hygienic optimal version. Weighing terminal and column are seamlessly welded together. Easy to clean, cables run inside the column.

1.2.3

Options

The following options are available for the ICS639:

	ICS639a, ICS639d, ICS639a-.../f, ICS639a-.../t	ICS639a-.../c
Built-in storage battery	✓	✓
Optional scale interface (SCALE 2)	<ul style="list-style-type: none"> • analog • digital 	–
Optional communication interface (COM 2)	<ul style="list-style-type: none"> • RS232 • RS422/RS485 • Ethernet • WLAN 	<ul style="list-style-type: none"> • RS232 • RS422/RS485 • Ethernet • WLAN • USB • Digital I/O
Optional communication interface (COM 3)	<ul style="list-style-type: none"> • RS232 • RS422/RS485 • USB • Digital I/O 	–
Desk mounting plate	✓	–

Terminal and platform combinations

- Load cells for more challenging environments
 - Standard: hermetically sealed stainless steel load cell (identical to PBA430)
 - Option: loadcell with KS+ coating (identical to PBA430 with option loadcell with KS+ coating)
- Other resolutions (availability depending on region, weighing unit and Weights and Measures approval)
 - Verification OIML Class III, 1 x 3,000 e
 - Verification OIML Class III, 2 x 3,000 e MR
 - 6,000 d (non-approvable)
 - 10,000 d (non-approvable)
 - 15,000 d (non-approvable)
 - 30,000 d (non-approvable)

1.2.4

Display

To meet your special requirements two different display layouts are available.

Default layout

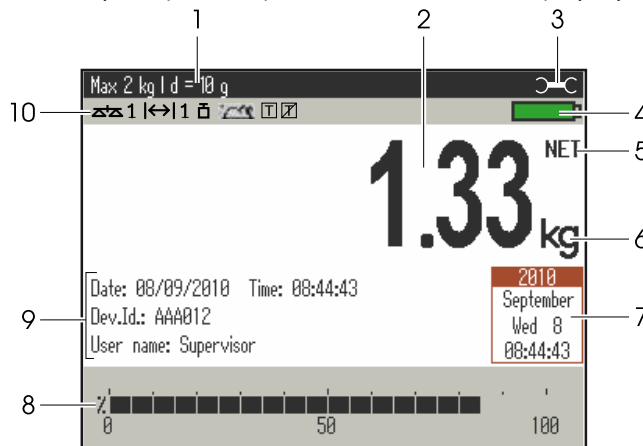

Weight values in 3-line mode

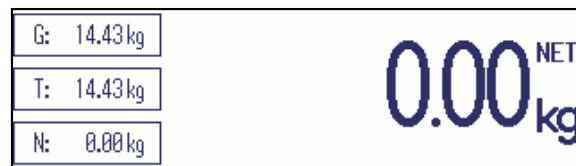

- 1 Metrological data – for details see below
- 2 Weight value with star, sign and stability monitor – for details see below
- 3 Spanner icon: serviced needed – for details see chapter "Event and error messages"
- 4 Battery symbol
- 5 Net/Gross
- 6 Unit
- 7 Calendar – can be activated/deactivated in the menu
- 8 Bargraph – to show the scale capacity used
- 9 3 lines for auxiliary data – can be defined in the menu
- 10 Symbol and info line – for details see below

Metrological data line

In the metrological data line the following information is displayed:

Symbol	Information	Remark
	Accuracy classes	Displayed only if the scale is approved according to the Weights and Measures guidelines
W1 , W2 , W3	Weighing range information	For multi range devices only, displayed only if the scale is approved according to the Weights and Measures guidelines
Max , cap	Maximum capacity	
Min	Minimum capacity	Displayed only if the scale is approved according to the OIML Weights and Measures guidelines
e =	Approved resolution	OIML: Displayed only if the scale is approved NTEP: Displayed only if the scale is approved and d is different from e
d =	Display resolution	OIML: Displayed only if the scale is not approved or if d is different from e NTEP: Displayed always
Approved scale	Approved weighing device	Metrology display disabled, Weights and Measures data must be indicated on a label near the weight display





Weight display

The weight value can be marked with the following symbols:

Symbol	Information	Remark
*	Calculated weight value	E.g., for average weighing results
–	Sign	For negative weight values
○	Stability monitor	For unstable weight values
1.2343 kg	Non-approved last digit with $e > d$	For approved scales only The example shows the weight value for a scale with $e = 1 \text{ g}$ and $d = 0.1 \text{ g}$ The last, smaller digit is not approved

Symbols and info line









In the symbols and info line the following information may be displayed:

Symbol	Information	Remark
<-> 1	Weighing range	For multi range or multi interval scales only
$\Delta^+ \Delta$ 1	Scale number	Indicates the number of the active scale
	Weight below minimum weight	MinWeigh must be activated in the menu
	Average weighing	Average must be activated in the menu
	Automatic taring	Auto Tare must be activated in the menu
	Automatic clearing of the tare weight	A-Clear Tare must be activated in the menu
>0<	Center of zero indication	Availability depending on local Weights and Measures regulations

1.2.5



Keyboard

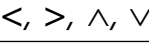



Key	Name	Function in the operating mode	Function in the menu
	Power	<ul style="list-style-type: none"> Switching on and off Cancel editing 	<ul style="list-style-type: none"> Cancel editing Exit menu
	Clear	<ul style="list-style-type: none"> Clear tare Leave info page 	<ul style="list-style-type: none"> Clear value, clear digit
	Switch	<ul style="list-style-type: none"> Switch over weight unit 	<ul style="list-style-type: none"> Re-edit Switch over from numerics to upper/lower case letters
	Zero	<ul style="list-style-type: none"> Set scale to zero, clear tare 	
	Tare	<ul style="list-style-type: none"> Tare scale, clear tare 	
	Quick select	<ul style="list-style-type: none"> Opening Quick Select menu, e.g., for menu access, viewing log files or logout 	
	Info	<ul style="list-style-type: none"> Activate info screen Proceed to next info line / info page Freeze and release startup screen 	
	Transfer	<ul style="list-style-type: none"> Transfer data to a printer or computer 	<ul style="list-style-type: none"> Enter menu item Confirm entry / selection
	Cursor keys	<ul style="list-style-type: none"> Navigating 	<ul style="list-style-type: none"> Navigating

Alphanumeric input









When an alphanumeric input is requested, one of the following symbols is displayed in the right top edge of the display:

- **123**  for numeric input and special characters
- **ABC**  for input in upper case letters
- **abc**  for input in lower case letters

→ To switch between numerics and upper/lower case letters press .

- Text entries work like e.g., on a mobile phone. Up to four characters are assigned to the keys of the numeric keyboard.
- Entries must be confirmed with .

Example: Enter "ICS6x9"

1. Make sure that **ABC**  is displayed.
2. To enter letter "I" press key **4** three times.
3. To enter letter "C" press key **2** three times.
4. To enter letter "S" press key **7** four times.
5. Press  twice to change to numerics **123** .
6. Enter number **6**.
7. Press  twice to change to lower case letters **abc** .
8. To enter letter "x" press key **9** twice.
9. Press  to change to numerics **123** .
10. Enter number **9**.
11. Confirm entry with .

1.2.6

Connections

Weighing terminal only, ICS639a-.../f, ICS639a-.../t

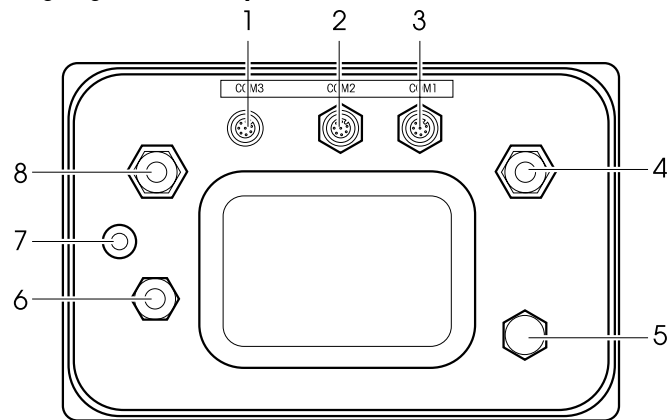

- 1 Optional interface COM3
- 2 Optional interface COM2
- 3 Standard interface COM1 (RS232)
- 4 Weighing platform connection SCALE 1
- 5 Pressure compensation
- 6 AC power supply or battery charging
- 7 Verification securing seal
- 8 Optional weighing platform connection SCALE 2

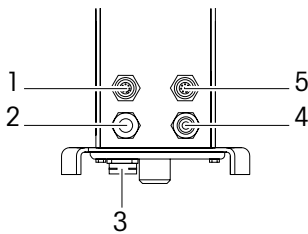

ICS639a-.../c

- 1 Optional interface COM2
- 2 Weighing platform connection
- 3 Pressure compensation
- 4 AC power supply or battery charging
- 5 Standard interface COM1 (RS232)

Note

The verification securing seal is applied on the weighing terminal as described in the section above.

1.3

Tracking and tracing features

ICS639 offers some advanced features for tracking and tracing operation on your weighing terminal:

- User management
- Alibi log file
- Routine test and routine test log file
- Calibration weight management

1.3.1**User management**

The user management of the ICS639 allows you to manage up to 20 users by

- user name
- user profile (operator or supervisor)
- user password
- user language
- user ID

When user management is activated, any access to the terminal is protected by password. To enter the menu a password is no longer necessary.



- User management can be configured in the menu under `Terminal -> User Management`.
- Login/logout with user management is described in chapter 2.

1.3.2**Alibi log file**

If requested by national regulations, you can activate an alibi log file to trace all weighing activities on the scale.

The alibi log file stores all weighings with the mandatory data. In addition you can store up to 4 more items such as identifications, serial numbers and user name.



- The alibi log file can be configured in the menu under `Application -> Log files`.
- Viewing/printing/transferring of the alibi log file is described in the Quick Select menu.

1.3.3**Routine test and routine test log file**

For optimum weighing results the device supports routine calibration tests.

You can configure routine tests by

- Interval (days)
- External test (for analog scales)
- Internal test (for scales with internal calibration weight)

For the external test for analog scales you can specify the following:

- Test weight (value)
- Weight name (to make sure you always use the same weight)
- Tolerance



- The routine test can be configured in the menu under `Application -> Log files`.
- Performing the routine test and viewing/printing/transferring of the routine test log file is described in the Quick Select menu.

1.3.4

Calibration weight management

For verified scales the calibration results are stored in the calibration log.



Viewing/printing/transferring of the calibration log file is described in the Quick Select menu.

1.4

Commissioning

1.4.1

Selecting the weighing platform location

The correct location is crucial to the accuracy of the weighing results.

→ Select a stable, vibration-free and, if possible, a horizontal location for the weighing platform.

The ground must be able to safely bear the weight of the fully loaded weighing platform.

→ Observe the following environmental conditions:

- No direct sunlight
- No strong drafts
- No excessive temperature fluctuations

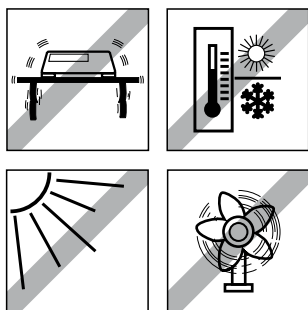

1.4.2

Levelling the weighing platform

Only weighing platforms that have been levelled precisely horizontally provide accurate weighing results. Weights and Measures approved weighing platforms have a spirit level to simplify levelling.

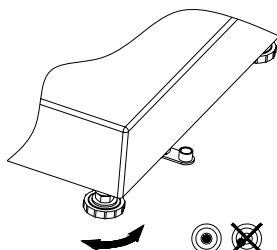

1. Turn the adjustable feet of the weighing platform until the spirit level's air bubble is inside the inner circle.
2. Tighten the lock nuts of the adjustable feet.

1.4.3

Weighing platform connection and interface commissioning

The weighing platform connection to the weighing terminal as well as the commissioning of the interfaces are described in the ICS4x9 installation instructions.

→ Call the METTLER TOLEDO service technician or carry out commissioning in accordance with the installation instructions.

1.4.4

**Power supply connection****CAUTION****Risk of electric shock!**

- ▲ Before connecting the power supply, check whether the voltage value printed on the rating plate corresponds to your local system voltage.
- ▲ Do not under any circumstances connect the device if the voltage value on the rating plate deviates from the local system voltage.
- ▲ Make sure the weighing platform has reached room temperature before switching on the power supply.

→ Plug the power plug into the power socket.
After it has been connected, the device runs a self-test. The device is ready to operate when zero appears on the display.

1.4.5

**Handling of the built-in storage battery**

Note the following when operating a device with a built-in storage battery:

- The operating life depends on the intensity of use, the configuration and the connected scale. For details see the technical data.
- The battery symbol shows the current state of charge of the storage battery.
 - One segment corresponds with approx. 25 % capacity.
 - If the symbol flashes, the storage battery has to be charged. A message is displayed, too.
 - During charging the segments are "running" until the battery is fully charged and all segments light up continuously.
- The charging time of the storage battery amounts to approx. 6 hours.
If work is continued during the charging process, the charging time is extended.
- The storage battery is protected against overcharging.
- The storage battery has a service life of approx. 2 years or 500 to 1,000 charging/discharging cycles.
- The storage battery is also suitable for permanent mains operation.

**CAUTION****Danger of soiling because the charger for the storage battery is not protected to IP69K!**

- ▲ Do not charge the device in humid or dusty rooms.
- ▲ After the storage battery has been charged, close the cover cap of the charging socket at the device.

**CAUTION****No success in charging the storage battery due to low temperatures!**

- ▲ Do not charge the battery if the battery temperature is below 0 °C (32 °F). Charging is not possible in this temperature range.
- ▲ Do not operate the battery charger outside its temperature range of 0 °C to 40 °C (32 °F to 104 °F).

Recommended use of the built-in storage battery

The characteristics mentioned above are only valid if the following recommendations are observed:

- Connect the device to the battery charger as soon as the warning message "Low battery" appears and the battery symbol starts flashing. When the message appears you still have enough time (at least 10 minutes) to complete your current task.
- Keep the battery charger connected until the charging process is completed, i.e., all segments of the battery symbol light up continuously.
- For optimum battery performance operate the device with built-in storage battery at an ambient temperature in the range of 10 °C to 30 °C (50 °F to 86 °F). This applies to discharging as well as charging the battery.
- If you plan to put the scale out of operation for a longer period, charge the battery completely.
- Even if you do not use the instrument, charge the battery at least every 3 months to avoid deep discharge.

1.5 Use in hygienically sensitive areas

The device is easy to clean and is designed to be used in the food industry.

Features

- Suitability of the materials for contact with foodstuffs
- Construction made of stainless steel
- No open threads
- No screws with recesses
- Smooth, non-porous and flat surfaces that are easy to clean
- Reduced horizontal surfaces
- Continuous welding seams

For further information please refer to the appendix.

2 Operation

2.1 Switching on and off

2.1.1 Switching on/off

Switching on → Press .

For a few seconds the device shows a start-up screen with device name, software version, serial number of the weighing terminal and the Geo value (only if an analog weighing device is connected).



- You can freeze the start-up screen by pressing **i**.
- When you start a weighing system with an analog scale the first time, a message is displayed: "Scale not calibrated". Call the METTLER TOLEDO service technician to calibrate the scale.
- When user management is active, you are asked to select your name and enter the corresponding password.



Switching off → Press .

Before the display goes out, **-OFF-** appears briefly.

2.1.2 Login/logout

When user management is active, a login/logout procedure is required. The login screen is displayed after switching on or logging out.

- Login**
1. Select your name using the cursor keys \wedge / \vee and confirm with .
 2. Enter your password using the displayed keyboard.
A welcome screen and then the weight display appear.

- Logout**
1. Press  to open the Quick Select menu.
 2. Select **Logout** using the cursor keys \wedge / \vee and confirm with .
 3. Press .
- The login screen is displayed, the current user is logged out.



Always log out when leaving the terminal in order to prevent unauthorised persons from working on it.

2.2 Zeroing / Zero point correction

Zeroing corrects the influence of slight changes on the load plate or minor deviations from the zero point.

- Manual**
1. Unload scale.
 2. Press **→0←**.
Zero appears in the display.

Automatic In case of non-verified scales, the automatic zero point correction can be deactivated in the menu or the zero range can be changed. Approved scales are set fixed to 0.5 d. As standard, the zero point of the scale is automatically corrected when the scale is unloaded.



- The zero function is only available within a limited weighing range.
- After zeroing the scale, the whole weighing range is still available.
- A successful zeroing will always delete a tare weight.

2.3 Simple weighing

1. Place weighing sample on the scale.
2. Wait until the stability monitor **○** goes out.
3. Read the weighing result.

2.4 Weighing with tare

2.4.1 Taring

- Place the empty container on the scale and press **→T←**.
The zero display and the symbol **NET** appear.
The tare weight remains stored until it is cleared.

2.4.2 Clearing the tare

- Press **C**.
The symbol **NET** goes out, the gross weight appears in the display.



If the symbol  is displayed, i.e., the A-Clear Tare function is activated in the menu under *Scale -> Tare*, the tare weight is automatically cleared as soon as the scale is unloaded.

2.4.3 Automatic clearing of the tare

A tare weight is automatically cleared when the scale is unloaded.

Prerequisite

- ✓ The symbol  is displayed, i.e., the tare function `A-Clear Tare` is activated in the menu under `Scale -> Tare`.

2.4.4 Automatic taring

If you place a weight on an empty scale, the scale tares automatically and the symbol **NET** is displayed.

Prerequisite

- ✓ The symbol  is displayed, i.e., the tare function `Auto Tare` is activated in the menu under `Scale -> Tare`.



The weight to be tared automatically, e.g., packaging material, must be heavier than 9 display steps of the scale.

2.4.5 Chain tare

With this function it is possible to tare several times if, e.g., cardboard is placed between individual layers in a container.

Prerequisite

- ✓ The tare function `Chain tare` is activated in the menu under `Scale -> Tare`.

1. Place the first container or packaging material on the scale and press **→T←**.
The packaging weight is automatically saved as the tare weight, the zero display and the symbol **NET** appear.
2. Weigh the weighing sample and read/print out the result.
3. Place the second container or packaging material on the scale and press **→T←** again.
The total weight on the scale is saved as the new tare weight. The zero display appears.
4. Weigh the weighing sample in the second container and read/print the result.
5. Repeat steps 3 and 4 for other containers.

2.4.6

Tare preset

If you know the weight of your containers, you can enter the tare weight via barcode or SICS command. Thus you do not have to tare the empty container.

Prerequisite

✓ For barcode use `Tare preset` is selected as destination for external input.

1. Enter the known tare weight via barcode or SICS command.
The weight display shows the negative tare weight and the symbol **NET** appears.
2. Place the full container on the weighing platform.
The net weight is displayed.



The entered tare weight is valid until a new tare weight is entered or the tare weight is cleared.

2.5

Displaying the capacity available



The terminal provides a graphic display of the scale capacity available.

The bargraph indicates how many per cent of the scale capacity is already occupied and what capacity is still available.

In the example, approx. 65 % of the scale capacity is occupied.

2.6

Switching scales

Prerequisites

✓ For manual totalisation the soft key $\Delta^+\Delta$ (Switch scale) is activated in the menu under `Terminal -> Device -> Keyboard -> Softkeys`.

- Press the soft key $\Delta^+\Delta$ to switch from scale 1 to scale 2 or vice versa.
The current active scale is displayed in the symbol and info line on the top of the display.

2.7 Average (dynamic) weighing

With the average weighing function, it is possible to weigh restless weighing samples such as living animals. If this function is activated,  is displayed in the info line.

With average weighing, the scale calculates the mean value from 56 weighing operations within 4 seconds.

With manual start

- ✓ Average -> Manual is selected in the menu.
- ✓ Weighing sample heavier than 9 scale divisions.

1. Place the weighing sample on the scale.
2. Press  to start average weighing.
3. During average weighing, stars appear in the display, and the average result will be displayed with the symbol *.
4. Unload the scale to be able to start a new average weighing operation.

With automatic start

- ✓ Average -> Auto is selected in the menu.
- ✓ Weighing sample heavier than 9 scale divisions.

1. Place the weighing sample on the scale.
Average weighing starts automatically.
During average weighing, stars appear in the display, and the average result will be displayed with the symbol *.
2. Unload the scale to be able to perform a new average weighing operation.

2.8 Working with identifications

Weighing series can be assigned 3 identification numbers ID1, ID2 and ID3 with up to 40 characters that are also printed out in the protocols. If, for example, a customer number and an article number are assigned, it can be clearly seen in the protocol which article was weighed for which customer.

Barcode use (for one identification only)

- ✓ ID1, ID2 or ID3 is selected as destination for external input.
- ✓ To display the identification ID1, ID2 or ID3 is activated in the auxiliary line.

Using SICS command set (up to three identifications)

- ✓ To display the identification(s) ID1 and/or ID2 and/or ID3 are activated in the auxiliary line.

2.9 Printing results

If a printer or computer is connected, weighing results and other information can be printed out or transferred to a computer.

→ Press **↵**.

The defined data is printed out or transferred to the computer.



The printout content can be defined in the `Templates` menu.

2.10 Displaying information

Up to 18 different values for display can be configured in the menu for the info key. Depending on the configuration in the menu `Terminal -> Device -> Keyboard -> Info key`, the following data can be assigned in a free order, e.g.:

- Date & Time
- Weight values
- Identifications
- Device information
- Serial numbers and software versions
- User name

1. Press **i**.
The (first) info screen is displayed.
2. Press **i** again.
With one info screen only, the weight display appears.
With several info screens, the next info screen is displayed.
3. With several info screens, press **C** to leave the info screens.



An info screen is displayed until **i** is pressed again or **C** is pressed.

2.11 Environment and cleaning

2.11.1 Overview

The devices are designed to be used in a wet environment. Depending on the environment and the cleaning procedures we suggest weighing platforms with different types of load cells. The following table gives you a detailed overview about the recommended environment and suitable cleaning procedures.

	Terminal	Weighing platform	
	ICS639a ICS639d	Standard version hermetically sealed stainless steel load cell	Option load cell with KS+ coating
IP rating	IP68/IP69k	IP68/IP69k	IP68/IP69k
Environment			
Short time wet (30 min / day)	✓	✓	✓
Part time wet (120 min / day)	✓	✓	✓
Permanent wet	✓	✓	✓
Cleaning procedure			
Wet wipe down	✓	✓	✓
Light hose down < 5 l / min, 20 kPa	✓	✓	✓
Light wash down < 12.5 l / min, 30 kPa	✓	✓	✓
Heavy wash down high pressure water and steam jet up to 10000 kPa	✓	✓	✓
Cleaning detergents			
Mild detergents	✓	✓	✓
Other detergents in accordance with the manufacturer's specifications and instructions	✓	✓	✓
Acids, lyes, solvents	—	—	✓

2.11.2



General cleaning recommendations

Risk of electric shock

- ▲ Before cleaning, unplug the power plug in order to disconnect the terminal from the power supply.
- ▲ Cover open connectors with cap plugs.

- Clean the protective cover separately. The protective hood is dishwasher-safe.
- Replace the protective hood regularly.
- Take off the load plate and remove any dirt and foreign substances which may have collected underneath. Do not use any hard objects to do so.
- Do not disassemble the weighing device.
- Remove any possibly remaining detergent by rinsing with clear water.
- To prolong the lifetime of the load cell, dry it with a soft lint-free cloth immediately after cleaning.
- Observe all the existing regulations on cleaning intervals and permissible cleaning agents.

Cleaning of different weighing platforms as described in this User manual

- Make sure to observe the cleaning instructions for the connected weighing platform. The weighing platform may not be designed for wet environments and the cleaning procedures described above.

2.12

Verification test

The weighing instrument is verified if

- the accuracy class is displayed in the metrological line,
- the securing seal is not tampered with,
- it bears an official verification mark, e.g., the green M sticker (OIML),
- the validity is not expired.

The weighing instrument is also verified if

- the metrological line shows "Approved scale",
- labels with the metrological data are placed near the weight display,
- the securing seal is not tampered with,
- it bears an official verification mark, e.g., the green M sticker (OIML),
- the validity is not expired.



The period of validity is country-specific. It is in the responsibility of the owner to renew verification in due time.

Terminal and platform combinations

Combinations of a weighing terminal and an analog weighing platform use a Geo Code to compensate for gravitational influence.

The manufacturer of the weighing instrument uses a defined Geo Code value for verification.

- ➔ Please check if the Geo Code in the instrument corresponds with the Geo Code value defined for your location.

The Geo Code value is displayed when you switch on the instrument.

The Geo Code for your location is shown in the Appendix.

- ➔ Call the METTLER TOLEDO service technician if the Geo Code values do not match.

3 Settings in the menu

In the menu, settings can be changed and functions can be activated. This enables adaptation to individual weighing requirements.



The menu consists of the following 5 main blocks containing various submenus on several levels.



Scale	see section 3.2 (analog scales) or 3.3 (IDNet scales)
Application	see section 3.4
Terminal	see section 3.5
Communication	see section 3.6
Maintenance	see section 3.7

3.1 Operating the menu

3.1.1 Calling up the menu and entering the password

The menu differentiates between 2 operating levels: Operator and Supervisor. The Supervisor level can be protected by a password. When the device is delivered, both levels are accessible without a password.

- Operator menu**
1. Press .
The Quick Select menu opens, `Menu` is highlighted.
 2. Press .
`Enter code` is displayed.
 3. Press  again.
The menu item `Terminal` is displayed. Only parts of the submenu `Device` are accessible.



- Supervisor menu**
1. Press .
The Quick Select menu opens, `Menu` is highlighted.
 2. Press .
`Enter code` is displayed.
 3. Enter the password.
The first menu item `Scale` is highlighted.



- When the device is first delivered, the supervisor password is set to 423. Set your individual password in the `Terminal` menu.
- If a password has still not been entered after a few seconds, the scale returns to the weighing mode.
- If a password has been issued for Supervisor access to the menu and you have forgotten it, please contact the METTLER TOLEDO service.

Calling up menu when user management is active

If user management is active, password entry is required when logging in.

1. Press .
The Quick Select menu opens, `Menu` is highlighted.
2. Press .
The menu start screen is displayed, depending on the user profile.

3.1.2

Display presentation in the menu

Menu items are displayed together with their context. The following example shows the menu start screen.

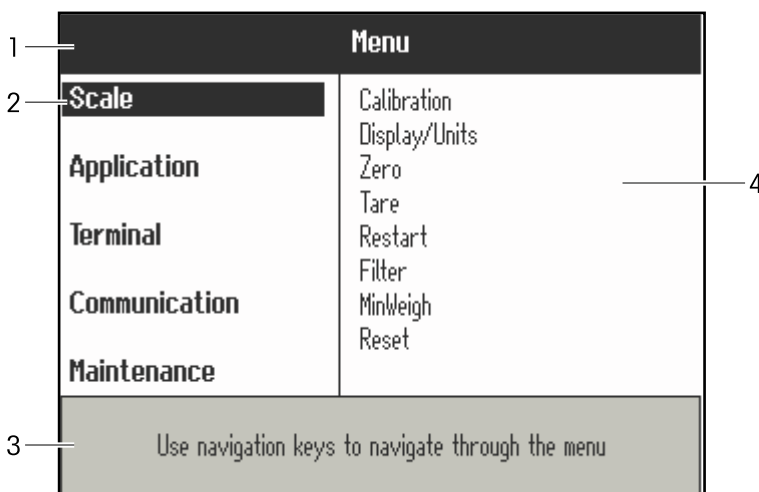

- 1 Menu info line, i.e., menu path of the current menu item
- 2 Menu items; the selected menu item is highlighted
- 3 Navigation info line
- 4 Sub-menu items

3.1.3

Exiting the menu

1. Press .
The last menu item `End` appears. "Save settings ?" is displayed.
2. Press **OK**.
The menu changes are saved and the terminal returns to the weighing mode.
- or -
→ Press **ESC** for further menu settings.
- or -
→ Press **NO** to discard changes and return to the weighing mode.

3.1.4 Selecting and setting parameters in the menu

Example: Setting of the Chain tare function

Menu	
Scale	Calibration
	Display/Units
Application	Zero
	Tare
Terminal	Restart
	Filter
Communication	MinWeigh
	Reset
Maintenance	

1. In the menu start screen press > to switch to the right side.
The first submenu `Calibration` is highlighted.

Scale	
Calibration	Auto tare
Display/Units	Chain tare
Zero	A-Clear tare
Tare	
Restart	
Filter	
MinWeigh	
Reset	

2. Use \downarrow/\uparrow to select `Tare`.
The current `Tare` settings are displayed on the right side.
3. Press > to open the selected (highlighted) menu item `Tare`.
The `Tare` submenus are displayed on the left side.

Scale – Tare	
Auto tare	
Chain tare	On
A-Clear tare	

4. Use \downarrow/\uparrow to select `Chain tare`.
The current `Chain tare` setting is displayed on the right side.
5. Press > to open the selected (highlighted) menu item `Chain tare`.
All possible `Chain tare` settings are displayed on the right side, the current setting is highlighted.
6. Use \downarrow/\uparrow to change the `Chain tare` setting.
7. Confirm the setting with \rightarrow .

3.2 Scale menu block – analog scales

Factory settings are printed in **bold** in the following overview.





3.2.1 Overview

Level 1	Level 2	Level 3
Calibration		
Display/ Units	Unit 1	g, kg , oz, lb, lb-oz, t
	Unit 2	g , kg, oz, lb, lb-oz, t
	Resolution	
	Unit roll	On, Off
Zero	AZM	Off, 0.5 d , 1 d, 2 d, 5 d, 10 d
Tare	Auto tare	On, Off
	Chain tare	On , Off
	A-Clear tare	On, Off , 9 d
Restart	On, Off	
Filter	Vibration	Low, Medium , High
	Process	Universal , Dosing
	Stability	Fast, Standard , Precise
MinWeigh	Function	On, Off
Reset	Perform reset ?	

3.2.2 Description of the (analog) SCALE menu block

(Analog) Scale → Calibration

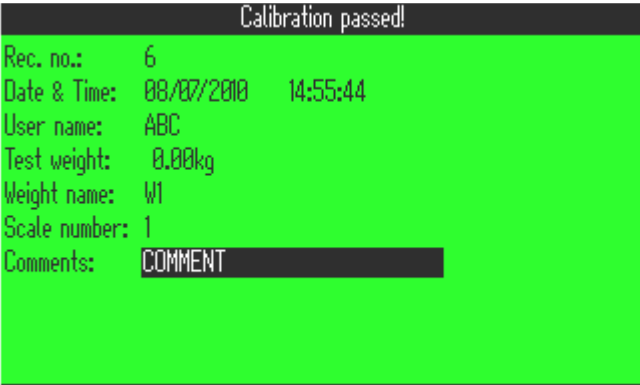
This menu item is not available for verified scales.

<p>Perform calibration ?</p>	<ol style="list-style-type: none"> 1. Unload scale. 2. Start calibration with . The scale determines the zero point, -0- appears in the display. The calibration weight to be placed on the scale flashes in the display. 3. If necessary, change the weight value displayed with →T←. 4. Place the calibration weight on the scale and confirm with . The scale calibrates with the calibration weight loaded. After calibration is completed, -Done- appears briefly in the display and the calibration protocol is displayed.  <ol style="list-style-type: none"> 5. You can now enter User name, Weight name and Comments if applicable.
<p>Note</p>	<ul style="list-style-type: none"> • In order to achieve particularly high precision, calibrate under full load. The calibration process can be aborted using . • The calibration protocol is stored in the calibration log file.

(Analog) Scale → Display/Units – Weighing unit and display accuracy

<p>Unit 1</p>	<p>Select weighing unit 1: g, kg, oz, lb, lb-oz, t</p>
<p>Unit 2</p>	<p>Select weighing unit 2: g, kg, oz, lb, lb-oz, t</p>
<p>Resolution</p>	<p>Select readability (resolution), the possible settings depend on the connected scale.</p>
<p>Unit roll</p>	<p>When unit roll is switched on, the weight value can be displayed in all available units with .</p>
<p>Notes</p>	<ul style="list-style-type: none"> • In case of verified scales, individual sub-items of the Display menu item may not be available or only to a limited extent, depending on the respective country. • On dual-range/dual interval scales, resolutions marked with l<->l 1/2 are divided up into 2 weighing ranges/intervals, e.g., 2 x 3000 d.

(Analog) Scale → Zero – Automatic zero update

AZM	On verified scales, this menu item does not appear. Switching on/off automatic zero update and selecting zeroing range. Possible settings: Off; 0.5 d ; 1 d; 2 d; 5 d; 10 d
------------	--

(Analog) Scale → Tare – Tare function

Auto tare	Switching on/off automatic taring
Chain tare	Switching on/off chain tare
A-Clear tare	Switching on/off automatic clearing of the tare weight when the load is removed from the scale. <ul style="list-style-type: none"> • On The tare weight is automatically cleared if the gross weight is 0 or below zero • Off No automatic clearing of the tare weight • 9 d The tare weight is automatically cleared if the gross weight is within +/- 9 display steps

(Analog) Scale → Restart – Automatic saving of zero point and tare value

Restart	When the restart function is activated, the last zero point and the tare value are saved. After switching off/on or after a power interruption, the device continues to work with the saved zero point and tare value.
----------------	--

**(Analog) Scale → Filter –
Adaptation of the ambient conditions and the weighing type**

Vibration Low Medium High	Adaptation to ambient conditions <ul style="list-style-type: none"> • Very steady and stable environment. The scale works very rapidly, but is very sensitive to external influences. • Normal environment. The scale operates at medium speed. • Restless environment. The scale works more slowly, but is insensitive to external influences.
Process Universal Dosing	Adaptation to the weighing process <ul style="list-style-type: none"> • Universal setting for all weighing samples and normal weighing goods. • Dispensing liquid or powdery weighing samples.
Stability Fast Standard Precise	Adjusting the stability detector <ul style="list-style-type: none"> • The scale operates very fast. • The scale operates at medium speed. • The scale operates with the greatest possible reproducibility. <p>The slower the scale works, the greater the reproducibility of the weighing results.</p>

(Analog) Scale → MinWeigh – Minimum weighing-in quantity

Before you can use this function, the METTLER TOLEDO service technician has to determine and to enter a minimum weight value.

Function	Switching minimum weight function on/off If the weight on the scale drops below the stored minimum weight,  appears in the symbols and info line.
-----------------	---

(Analog) Scale → Reset – Resetting scale settings to factory settings

Perform reset ?	Confirmation inquiry <ul style="list-style-type: none"> • Reset the analog scale settings to factory settings with YES. • Do not reset the analog scale settings with NO.
------------------------	---

3.3 Scale menu block – IDNet scales

Factory settings are printed in **bold** in the following overview.

3.3.1 Overview

Level 1	Level 2	Level 3
Display/ Units	Unit 2	g , kg, oz, lb, t
	Unit roll	On, Off
Zero	AZM	On , Off
Tare	Auto tare	On, Off
	Chain tare	On , Off
	A-Clear tare	On, Off , 9 d
Restart	On, Off	
Filter	Vibration	Stable, Normal , Unstable
	Process	Finefill, Universal , Absolut
	Stability	ASD=0, ASD=1, ASD=2 , ASD=3, ASD=4
Update	The possible settings depend on the connected scale	
MinWeigh	Function	On, Off
Reset	Perform reset?	

3.3.2

Description of the (IDNet) Scale menu block

(IDNet) Scale -> Display – Weighing unit

Unit 2	Select weighing unit 2: g, kg, oz, lb, t
Unit roll	When unit roll is switched on, the weight value can be displayed in all available units with  .
Notes	<ul style="list-style-type: none"> • In case of verified scales, individual sub-items of the Display menu item may not be available or only to a limited extent, depending on the respective country. • On multi-range/multi-interval scales, the symbol I<->I with number indicates the current range or interval.

(IDNet) Scale -> Zero – Automatic zero update

AZM	<p>On verified scales, this menu item does not appear.</p> <p>Switching on/off automatic zero update</p> <p>The effective range of the zero update mode (0.5 d; 1 d; 2 d; 3 d) can only be set by service technician.</p>
------------	--

(IDNet) Scale -> Tare – Tare function

Auto tare	Switching on/off automatic taring
Chain tare	Switching on/off chain tare
A-Clear tare	<p>Switching on/off automatic clearing of the tare weight when the load is removed from the scale.</p> <ul style="list-style-type: none"> • On The tare weight is automatically cleared if the gross weight is 0 or below zero • Off No automatic clearing of the tare weight • 9 d The tare weight is automatically cleared if the gross weight is within +/- 9 display steps

(IDNet) Scale -> Restart – Automatic saving of zero point and tare value

Restart	<p>When the Restart function is activated, the last zero point and the tare value are saved.</p> <p>After switching off/on or after a power interruption, the device continues to work with the saved zero point and tare value.</p>
----------------	--

3.4 Application menu block

Factory settings are printed in **bold** in the following overviews

3.4.1 Overview

Level 1	Level 2	Level 3	Level 4	
Average	Off , Auto, Manual			
Log files	Alibi Log	Activate		
		Item 7	ID1, ID2, ID3, Dev. identifier,	
		...	Dev. location, SNR Terminal,	
		Item 10	SNR Scale 1, SNR Scale 2, User name	
	Delete all records			
	Routine Test Log	Days		
		External test	Test weight, Weight name, Tolerance	
Internal test				
Delete all records				
Reset	Perform reset ?			

3.4.2 Description

**Application → Average –
Determining the average weight for an unstable load (dynamic weighing)**

Off	Calculating average weight switched off
Auto	Calculating average weight with automatic start of the weighing cycle
Manual	Calculating average weight with manual start of the weighing cycle via 

Application -> Log files – Setting up log files

<p>Alibi Log</p> <p>Activate</p> <p>Item 7 ... Item 10</p> <p>Delete all records</p>	<p>Setting up Alibi log file.</p> <p>If set to ON, all weighings are saved in a log file</p> <p>You can add additional information to that required by W & M regulations.</p> <ol style="list-style-type: none"> 1. Select item number. 2. Assign the item contents. <p>A safety prompt is displayed before deleting all stored alibi records.</p>
<p>Routine Test Log</p> <p>Days</p> <p>External test</p> <p>Internal test</p> <p>Delete all records</p>	<p>Setting up routine calibration test for your scale.</p> <p>Enter interval of routine test</p> <ul style="list-style-type: none"> • Test weight Enter the test weight value • Weight name Enter weight name • Tolerance Enter tolerance for passing the routine calibration test <ul style="list-style-type: none"> • Yes for weighing platforms with an internal calibration weight • No for weighing platforms without an internal calibration weight <p>A safety prompt is displayed before deleting all stored routine test records.</p>

Application -> Reset – Resetting application settings to factory settings

<p>Perform reset ?</p>	<p>Confirmation inquiry</p> <ul style="list-style-type: none"> • Reset the application settings to factory settings with YES. • Do not reset application settings with NO.
-------------------------------	--

3.5 Terminal menu block

Factory settings are printed in **bold** in the following overview.

3.5.1 Overview











Level 1	Level 2	Level 3	Level 4	Level 5	
Device	Language	English , German, French, Spanish, Italian, ...			
	Sleep / Power off	Off , 1 minute, 3 minutes, 5 minutes, 15 minutes, 30 minutes			
	Display	Layout	Default , 3-Line mode		
		Auxiliary line 1 ... 3	Not used, Date & Time , Gross, Net, Tare, High Resolution, ID1, ID2, ID3, Dev. identifier, Dev. location, User name		
		Contrast	1 ... 10		
		Brightness	1 ... 10		
		Backlight	off, 5 seconds, 10 seconds, 30 seconds, 1 minute, On		
		Weight hold	0 s ... 10 s		
		Colours	Default colour, < MinWeigh	Yellow, Light blue, Darkblue (< MinWeigh), Red, Purple, Green, Orange, Light green, Pink, White (Default colour)	
	Colour mode	Continuous, Stable			
	Keyboard	Key lock	Power, Clear, Switch, Info, Transfer, QuickSelect, Keypad	Lock, Unlock	
		Info key	Item 1 ... Item 18	Not used, Date & Time, Gross, Net, Tare, HighRes & Net, ID1, ID2, ID3, Dev. identifier, Dev. location, Dev. name, SNR Terminal, SNR Scale 1, Firmware Vers., User name	

Level 1	Level 2	Level 3	Level 4	Level 5
Device	Date & Time	Format	EU, US	
		Date	dd/mm/yyyy (EU), mm/dd/yyyy (US)	
		Time	hh:mm:ss	
		Meridian	AM, PM	
		Calender	On, Off	
	Beeper	On, Off		
	Information	Identification, Location		
User management	Edit user	User 1 ... User 20	User name, Profile, Password, Language, User ID	
	Activate	On, Off		
	Delete all			
	Delete Profile	User No. xx		
Access	Supervisor	Password		
Reset	Perform Reset ?			

3.5.2 Description of the Terminal menu block

Terminal -> Device – General device settings

Language	Selecting the language of the operator interface Possible languages: English , German, French, Spanish, Italian, Chinese We will expand the available languages continuously.
Sleep (User access)	This menu item only appears on devices in mains operation. When Sleep is activated, the device switches off display and backlighting after the time period set when not in use and gross weight is 0. Display and backlighting are switched on again by pressing a key or if the weight changes. Possible settings: Off , 1 min, 3 min, 5 min, 15 min, 30 min (approximate values)
Power Off (User access)	This menu item only appears on devices in battery operation. When Power Off is activated, the device switches itself off automatically after the time period set when not in use. After this, it must be switched on again using  . Possible settings: Off , 1 min, 3 min, 5 min, 15 min, 30 min (approximate values)

<p>Display</p> <p>Layout</p> <p>Auxiliary line 1 ...</p> <p>Auxiliary line 3</p> <p>Contrast (User access)</p> <p>Brightness (User access)</p> <p>Backlight (User access)</p> <p>Weight hold</p> <p>Colours</p> <p>Colour mode</p>	<p>Configuring the display window. For details see section 1.2.4</p> <p>Selecting the presentation of the weight value. Possible settings: Default, Big font mode, 3-Line mode</p> <p>Selecting the contents of the auxiliary display line. 1. Select auxiliary line number. 2. Assign contents to the selected line.</p> <p>Setting the contrast of the display Possible settings: 1 ... 10</p> <p>Setting the brightness of the display Possible settings: 1 ... 10</p> <p>Setting whether and after which time the background lighting is to be switched off. Possible settings: Off (no background lighting), 5 sec, 10 sec, 30 sec, 1 min, On (background lighting always on), (approximate values) Factory setting AC version On Factory setting battery version 5 sec</p> <p>Setting how long the weighing result is frozen in the display after the transfer key  has been pressed or auto print was generated. Possible settings: 0 s ... 10 s</p> <p>Setting the display colour for default and/or weight < MinWeigh 1. Select status. 2. Assign colour to the selected status.</p> <p>Setting the way of changing display colour</p> <ul style="list-style-type: none"> • Continuous Change in colour with stable or dynamic weight values • Stable Change in colour only when the weight value is stable
<p>Keyboard</p> <p>Key lock</p> <p>Info key</p>	<p>Switching keys on/off and setting info key</p> <p>Selecting keys to lock/unlock Possible keys: Power (), Clear (), Unit switch (), Info (), Transfer (), Quick Select (), keypad</p> <p>Setting up to 18 items to be displayed using the info key (). 1. Select the item to be configured (Item 1 ... Item 18). 2. Assign contents.</p>
<p>Note</p>	<ul style="list-style-type: none"> • If you want to lock the tare key () and/or the zero key (), ask the METTLER TOLEDO service technician. • Locked keys cannot be activated by the user, but the supervisor can still activate these keys by entering his password.

Date & Time	Setting date and time.
Format	Selecting date format. Possible settings: EU, US
Date	Setting date in the selected format: dd/mm/yyyy (EU) or mm/dd/yyyy (US)
Time	Setting time in the following format: hh:mm:ss
Meridian	For US format only: Setting AM/PM
Calender	Display a calender sheet in the right bottom edge of the display

Beeper	Each keystroke is confirmed by a short beep. Switching beeper on/off.
---------------	--

Information	Entering device information to identify the device according to your company's naming conventions.
Identification	Entering device identification
Location	Entering device location
Note	This device information can be used as follows: <ul style="list-style-type: none"> • to be displayed in the auxiliary lines of the display • to be displayed via i • to be printed/transferred together with the weight value <p>In addition <code>Device name</code> provides the complete type information already entered in the factory, e.g., ICS639a-A15/t.</p>

Terminal -> User management

Edit User	Configuring user profiles.
User 1 ... User 20	<ul style="list-style-type: none"> • User Name Enter user name, max. xx characters • Profile Assign profile: User or Supervisor • Password Define password, max. xx characters • Language Assign user language • User ID Define user ID, e.g., personnel number
Activate	Activating/deactivating user management
Delete all	Delete all user profiles
Delete Profile	Selecting a single user profile to be deleted

Terminal -> Access – Password for Supervisor menu access

Supervisor	Password entry for Supervisor menu access.
Password	Request to enter password. → Enter password.
Retype code	Request to repeat the password entry. → Enter password again.
Note	The password can consist of up to 6 characters.

Terminal -> Reset – Resetting terminal settings to factory settings

Perform reset ?	Confirmation inquiry <ul style="list-style-type: none"> • Reset the terminal settings to factory settings with YES. • Do not reset terminal settings with NO.
------------------------	--

3.6**Communication menu block**

For detailed information on interface protocols and commands refer to the following documents:

- SICS Reference manual
- MT continuous Reference manual

The Communication menu block consists of the following subblocks:

- COM 1 Parameter settings for the standard RS232 interface COM 1.
- COM 2 Parameter settings for the optional interface COM 2.
- COM 3 Parameter settings for the optional interface COM 3 (not for .../c version).
The interfaces identify themselves. Therefore only those menu settings appear which are relevant for the individual interface.
If no optional interface is installed, the COM 2 and COM 3 menus will not appear.

Templates Define templates to be selected via COM x -> Printer -> Template.

3.6.1

Available interface settings / factory settings

		COM1	COM2/COM3				
		RS232	RS232	RS422/ RS485	Ether- net	USB	WLAN
Mode	Print	✓	✓	✓	✓	–	✓
	Auto print	✓	✓	✓	✓	–	✓
	Instant print	✓	✓	✓	✓	–	✓
	Continuous ¹⁾	✓	✓	✓	✓	✓	✓
	Dialog ¹⁾	Factory setting	Factory setting	Factory setting	Factory setting	Factory setting	Factory setting
	External input	✓	✓	✓	✓	✓	✓
	Demand mode ²⁾	✓	✓	✓	✓	–	✓
	Demand m auto ²⁾	✓	✓	✓	✓	–	✓
	Cont.-weight ²⁾	✓	✓	✓	✓	✓	✓
Printer		✓	✓	✓	✓	–	✓
Destination		✓	✓	✓	✓	✓	✓
Parameter	Baud	9600	9600	9600	–	–	–
	Parity	8 none	8 none	8 none	–	–	–
	Handshake	✓	✓	✓	–	–	–
	RS Type	–	–	✓	–	–	–
	Net Address	–	–	✓	–	–	–
	Checksum	✓	✓	✓	✓	–	✓
	STX	✓	✓	✓	✓	–	✓
	Print G	✓	✓	✓	✓	–	✓
	Load resistor	–	–	✓	–	–	–

¹⁾ for more information see Reference manual "MT-SICS for ICS4xx"

²⁾ for more information see Reference manual "MT-Demand and Continuous", not recommended for new installations



3.6.2 Overview RS232 / RS422 / RS485 menu blocks (COM 1 / COM 2 / COM 3)

Level 1	Level 2	Level 3	Level 4	
Mode	Print, Auto print, Instant print, Continuous, Dialog, External input, Demand mode, Demand m auto, Cont.-Weight			
Printer	Type	ASCII printer , Label printer, GA46 printer		
	Template	Standard , Template 1 ... Template 5		
	ACII Format	Line format	Multiple , Single, Fixed	
		Line length	1 ... 24 ... 100	
		Separator	. , : ; - _ / \ Space	
		Expanded	On, Off	
		Add line feed	0 ... 9	
Destination	Off , Tare preset, ID1, ID2, ID3, User ID			
Parameter	Baud	300, 600, ..., 57600, 115200		
	Parity	7 none, 8 none, 7 odd, 8 odd, 7 even, 8 even		
	Handshake	Off , Xon - Xoff		
	RS Type	RS422 , RS485		
	Net Address	0 ... 31		
	Checksum	On, Off		
	STX	On, Off		
	Print G	On, Off		
	Load resistor	On, Off		
Reset	Perform reset ?			

3.6.3

Description of the RS232 / RS422 / RS485 menu blocks (COM 1 / COM 2 / COM 3)

Communication → COM x → Mode – Operating mode of the serial interface

Print	Manual data output to the printer with 
Auto print	Automatic output of stable results to the printer (e.g., for series weighing operations)
Instant print	Immediate manual data output to the printer with  (not verifiable)
Continuous	Ongoing output of all weight values via the interface
Dialog	Bi-directional communication via MT-SICS commands, control of the device via PC
External input	Input other than via terminal keypad. What the input is used for is defined in the Destination menu block
Demand mode	Manual data transmission with 
Demand m auto	Automatic transmission of stable results (e.g., for series weighing operations)
Cont.-Weight	TOLEDO Continuous mode
Note	<p>Printing conditions for <i>Auto print</i> and <i>Demand m auto</i>:</p> <ul style="list-style-type: none"> • The weight must be heavier than 9 display increments. • A weight change of at least 9 display increments is required to initiate the next printout

Communication → COM x → Printer – Settings for protocol printout

Type	<p>Selecting printer type out of the following: ASCII printer, Label printer, GA46 printer</p> <p>Note If Label printer is selected, the transmitted data does not include the name of the variable, e.g., Date, Gross, ID1, but the value and, if appropriate, the unit as a separate line. This allows the label printer to fill its template with the required data.</p>
Template	<p>Selecting protocol printout. Possible settings: Standard, Template 1 ... Template 5</p>
ASCII Format	<p>Selecting formats for the protocol printout.</p>
Line format	<p>Selecting line format out of the following:</p> <ul style="list-style-type: none"> • Multiple (multiple lines) • Single (single line) • Fixed (Records are output in single lines. Every record encompasses the number of characters that was defined under <i>Line length</i>).
Line length	<p>Setting line length. Possible settings: 0 to 100 characters Factory setting: 24 characters This item is only displayed for the line formats <i>Multiple</i> and <i>Fixed</i>.</p>
Separator	<p>Selecting the separator: Possible settings: , ; : / \ _ - and space This item is only displayed for the line format <i>Single</i>.</p>
Expanded	<p>Printout with bigger font size on METTLER TOLEDO printers.</p>
Add line feed	<p>Adding linefeeds. Possible settings: 0 ... 9</p>

Communication → COM x → Destination – Destination for barcode input

None	<p>Input destination is not predefined. The input will be shown on the display, you can decide what to do with the input.</p>
Tare preset	<p>Input via barcode is recognised as tare preset.</p>
ID1, ID2, ID3	<p>Input via barcode is recognised as ID1 resp. ID2.</p>
User ID	<p>Input via barcode is recognised as user ID.</p>

Communication -> COM x -> Parameter - Communication parameters

Baud	Selecting baud rate Possible settings: 300, 600, 1200, 2400, 4800, 9600 , 19200, 38400, 57600, 115200
Parity	Selecting parity Possible settings: 7 none, 8 none , 7 odd, 8 odd, 7 even, 8 even
Handshake	Selecting handshake Possible settings: Off , Xon-Xoff
RS Type	Selecting type of the optional RS422/RS485 interface: RS422 or RS485
Net Address	Assigning network address: 0 ... 31, only for RS485
Checksum	Activating/deactivating checksum byte
STX	Activating/deactivating STX If STX is enabled, the STX signal (0x02) is sent at the beginning of each output string that is sent via the interface.
Print G	This functionality can only be enabled if one of the Demand mode templates is selected. If it is enabled, the gross weight is marked with "G". Examples Print G enabled, no tare: _ _2.001_kg_G Print G disabled, no tare _ _2.001_kg Print G enabled, tare active: _ _2.025_kg_G_ _ _2.000_kg_T_ _ _0.025_kg_NET Print G disabled, tare active: _ _2.025_kg_ _ _2.000_kg_T_ _ _0.025_kg_NET
Load resistor	Only for the optional RS422/RS485 interface To avoid reflexions on a network, we recommend to make a defined termination. To this purpose the load resistor within the terminal can be used. When set to "On", a resistor of approx. 100 Ω between the signal lines is enabled

**Communication -> COM x -> Reset COM x -
Resetting communication settings to factory settings**

Perform reset ?	Confirmation inquiry <ul style="list-style-type: none"> • Reset the communication settings to factory settings with YES. • Do not reset communication settings with NO.
------------------------	---

3.6.4 Digital I/O menu blocks

Level 1	Level 2	Level 3
Input	Input pin 1 ... Input pin 4	Off , Zero, Tare, Transfer, Switch, Clear, Info
Output	Ready, Stable, Tare, Zero, < MinWeigh, >= MinWeigh, Underload, Overload, <= Setpoint 1, > Setpoint 1, <= Setpoint 2, > Setpoint 2, Star	Off , Output Pin 1 ... Output Pin 4
Setpoints	Setpoint 1, Setpoint 2	
Output mode	Continuous , Stable	
Reset Digital I/O	Perform reset ?	

COM x (Digital I/O) -> Input/Output – Configuring inputs/outputs

Configuring inputs

1. Select an input pin.
2. Assign an input signal to the selected input pin.

Configuring outputs

1. Select an output signal.
2. Assign an output pin.

COM x (Digital I/O) -> Setpoints – Entering values

Setpoint 1	Enter value for setpoint 1
Setpoint 2	Enter value for setpoint 2

COM x (Digital I/O) -> Output Mode – Behaviour of the digital outputs

Continuous	Digital outputs are updated continuously
Stable	Digital outputs are updated only when the weight is stable

COM x (Digital I/O) -> Reset COM x –

Resetting communication settings to factory setting

Perform reset ?	Confirmation inquiry <ul style="list-style-type: none"> • Reset the Digital I/O settings to factory settings with YES. • Do not reset Digital I/O settings with NO.
------------------------	---

3.6.5

Ethernet menu block

Item	Reference
Mode	See RS232 / RS422 / RS485 menu blocks
Printer	
Destination	
Parameter	
DHCP	If DHCP is set to "On", the device will receive the IP address automatically. Then IP address, Subnet mask and Gateway are read-only fields
IP address	Enter/display IP address
Subnet mask	Enter/display Subnet address
Gateway	Enter/display Gateway address
Reset Ethernet	See RS232 / RS422 / RS485 menu blocks

3.6.6

USB menu block

Item	Reference
Mode	See RS232 / RS422 / RS485 menu blocks
Destination	
Checksum	
STX	
Reset USB	

3.6.7 WLAN menu block

Level 1	Level 2	Level 3
Mode	See RS232 / RS422 / RS485 menu blocks.	
Printer		
Destination		
Parameter		
IP address	Enter IP address.	
Subnet mask	Enter Subnet address.	
Gateway	Enter Gateway address.	
Wireless settings	SSID	Enter SSID
	Encryption	Off , WEP, WPA
	WEP Settings	64 Bit, 128 Bit
	WEP key	Key 1, ... Key 4
	WPA Settings	WPA-TKIP, WPA2-AES
	Password	Enter password
Status	Display the current status, e.g., connection status, signal strength.	
Reset COM	See RS232 / RS422 / RS485 menu blocks.	

3.6.8 Templates menu block

Level 1	Level 2	Level 3
Template 1 ... Template 5	Line 1 ... Line 15	Not used , Header, Date, Time, Gross, Net, Tare, High resolution, ID1, ID2, ID3, Dev. identifier, Dev. location, SNR Terminal, SNR Scale 1, User name, Star line, New line, Form feed

Configuring templates

1. Select a template.
2. Select the line to be configured.
3. Assign the line contents.



The header can be specified via SICS command I31, see Reference manual "MT-SICS for ICS6xx".

3.7 Maintenance menu block

<p>Test Scale</p>	<p>Testing the scale</p> <p>Scales with an analog interface will offer the test procedure described below. Scales with an IDNet interface and an internal calibration weight perform an automatic calibration check.</p> <ol style="list-style-type: none"> 1. The scale checks the zero point. –0– appears in the display. 2. The test weight value flashes in the display. If necessary, change the weight value displayed using →T←. 3. Put the test weight on the scale and confirm with ↔. The scale checks the test weight. 4. After the test is completed, the deviation from the last calibration briefly appears in the display, ideally *d=0.0g, after which the device changes to the next menu item.
<p>Keyboard Test</p> <p>Start ?</p>	<p>Keyboard test</p> <ol style="list-style-type: none"> 1. Press ↔ to start the keyboard test. 2. Press the keys in the displayed order. If the key works, the device switches to the next key.
<p>Display Test</p> <p>Start ?</p>	<p>Display test</p> <ol style="list-style-type: none"> 1. Press ↔ to start the display test. A checkerboard pattern in various colour combinations is displayed. 2. Press ⏻ to leave the display test. <p>The display works properly if the bright and dark fields are displayed without missing pixels.</p>
<p>Serial number</p> <p>Start ?</p>	<p>Display of the serial numbers</p> <ol style="list-style-type: none"> 1. Press ↔. The serial numbers of the weighing terminal and the active weighing platform are displayed. 2. Press ⏻ to leave the item.
<p>Print Setup</p> <p>Start ?</p>	<p>Printout of a list of all menu settings</p> <ol style="list-style-type: none"> 1. Press ↔. A safety prompt is displayed. 2. Press ↔ again to start printing.

Reset All Perform reset ?	Reset all settings to factory settings Confirmation inquiry <ul style="list-style-type: none">• Reset all settings to factory settings with YES.• Do not reset settings with NO.
-------------------------------------	--

4 Quick Select menu

4.1 Quick Select menu overview

The Quick Select menu offers access to logout, routine test and several log files, depending on your configuration.

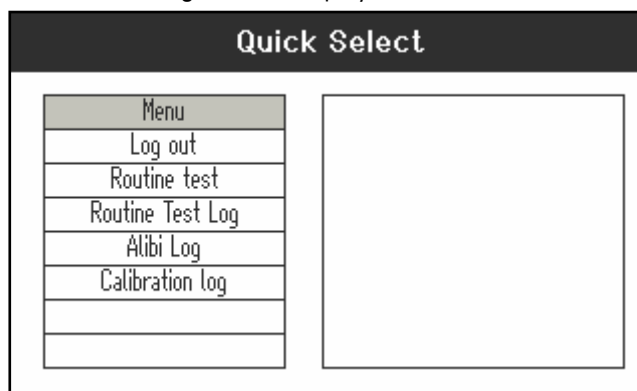

→ Press .

The following menu is displayed.



The example shows the Quick Select menu with the maximum of configurable items.

4.2 Entering main menu

→ In weighing mode press  and then .

The main menu is displayed without a long key press.

4.3 Logout

Prerequisite

✓ User management is activated under Terminal -> User Management.



- Logout is described in the Operation chapter.
- Always log out when leaving the terminal in order to prevent unauthorised persons from working on it.

4.4 Performing routine test

By performing a routine test you can check the calibration of your scale regularly.

Prerequisite

✓ Routine test parameters are set under *Application* -> *Log files*.



If an interval for the routine test is defined (*Days* > 0), the device automatically asks you to perform the routine test.

With external weight

1. Unload the scale.
2. Select *Routine Test* in the *Quick Select* menu using the cursor keys \wedge / \vee and confirm with \rightarrow .

You are asked to put the indicated weight on the platform.

3. When the required weight is put on the platform, press \rightarrow .

The routine test is carried out and the following test protocol is displayed for a short time:

Routine test	
Routine test passed!	
Rec. no.:	9
Date & Time:	08/07/2010 13:58:50
User name:	ABC
Test weight:	1.50 kg
Weight name:	W1
Tolerance:	0.10 kg
Result:	1.50 kg
Deviation:	0.00 kg

With internal weight

1. Unload scale.
2. Select `Routine Test` in the Quick Select menu using the cursor keys `^`/`v` and confirm with `↵`.

The routine test is carried out and the following test protocol is displayed for a short time.

Routine test	
Routine test passed!	
Rec.no.:	9
Date & Time:	08/07/2010 13:58:50
User name:	ABC
Test weight:	Internal weight
Weight name:	W1
Tolerance:	n/a
Result:	n/a
Deviation:	n/a



- The results of the routine test are stored in the routine test log file.
- If the determined weight is not within the tolerance, test protocol is in red. Call the METTLER TOLEDO service technician.
- If an external test weight is defined, an external routine test is performed directly after the internal routine test.

4.5

Calling up routine test log file

Prerequisite

- ✓ Routine test parameters are set under `Application -> Log files`.

Viewing routine test log file

1. Select `Routine Test Log` in the Quick Select menu using the cursor keys `^`/`v` and confirm with `↵`.

The routine test protocol of the last routine test is displayed.

Routine test passed!	
0002	Rec. no.: 11
0003	Date & Time: 21/07/2010 15:01:52
0004	User name: Richard Lebherz
0005	Test weight: 1.00 kg
0006	Weight name: A
0007	Tolerance: 0.01 kg
0008	Result: 1.00 kg
0009	Deviation: 0.00 kg
0010	
0011	

2. To view other routine test protocols use the cursor keys `^`/`v`.



4.6

Printing routine test log file

1. When a routine test record is displayed, press $\boxed{\rightarrow}$.
2. In the next screen select either `Print selected record` to print a single record or `Print whole memory` to print all records.
3. Confirm selection with $\boxed{\rightarrow}$.
The routine test log record(s) is(are) printed.

Deleting routine test log file

Deleting routine test log files is carried out in the menu under `Application -> Log files -> Routine Test Log`.

Calling up alibi log file

Prerequisite

✓ `Alibi Log` is activated under `Application -> Log files`.

Viewing alibi records

1. Select `Alibi Log` in the Quick Select menu using the cursor keys \wedge / \vee and confirm with $\boxed{\rightarrow}$.
The alibi record of the last weighing operation is displayed.

Alibi Log	
000 008	Rec. no.: 000 017
000 009	Date & Time: 20/07/2010 13:27:41
000 010	Net: 5.48 kg
000 011	Tare: 0.00 kg
000 012	Gross: 5.48 kg
000 013	Scale number: 1
000 014	
000 015	
000 016	
000 017	

2. To view other alibi records use the cursor keys \wedge / \vee .

Printing alibi log file

1. When an alibi record is displayed, press $\boxed{\rightarrow}$.
In the next screen you are given the following choice:
 - Print selected record
 - Print whole memory
 - Print today's records
 - Print records by number
 - Print records by date
2. Select the desired printing mode using the cursor keys \wedge / \vee and confirm with $\boxed{\rightarrow}$.
3. If `Print records by number` or `Print records by date` is selected, you are asked to enter start and end number respectively start and end date.
The selected alibi record(s) is(are) printed.

Searching alibi records

1. When an alibi record is displayed, press **i**.
2. In the next screen use **↶** to select the search criterion either `Search by date` or `Search by rec. no` (record number) and confirm with **↵**.
3. Enter record number resp. date of the alibi record(s) you are looking for and confirm with **↵**.
The desired alibi record(s) is(are) displayed.



Deleting alibi log files

Deleting alibi log files is carried out in the menu under `Application -> Log files -> Alibi Log`.

4.7

Calling up calibration log file

For analog scales the results of calibration procedures are stored in the calibration log file.

Viewing calibration log file

1. Select `Calibration Log` in the Quick Select menu using the cursor keys **^**/**v** and confirm with **↵**.
The calibration record of the last calibration is displayed.

Calibration passed!	
001	Rec. no.: 1
002	Date & Time: 20/07/2010 12:04:18
003	User name:
004	Test weight: 60.00kg
005	Weight name:
006	Scale number: 1
007	Comments:
008	
009	
010	



2. To view other calibration records use the cursor keys **^**/**v**.

Printing calibration records

1. When a calibration record is displayed, press **↵**.
2. In the next screen select either `Print selected record` to print a single record or `Print whole memory` to print all records.
3. Confirm selection with **↵**.
The calibration record(s) is(are) printed.

5 Event and error messages

5.1 Error conditions

Error	Cause	Remedy
Display dark	• Backlighting set too dark	→ Set backlighting brighter.
	• No mains voltage	→ Check mains.
	• Unit switched off	→ Switch on unit.
	• Mains cable not plugged in	→ Plug in mains cable.
	• Brief fault	→ Switch device off and on again.
Weight display unstable	• Restless installation location	→ Adjust vibration adapter.
	• Draft	→ Avoid draft.
	• Restless weighing sample	→ Dynamic weighing.
	• Contact between weighing pan and/or weighing sample and surroundings	→ Remedy contact.
	• Mains fault	→ Check mains.
Incorrect weight display	• Incorrect zeroing	→ Unload scale, set to zero and repeat weighing operation.
	• Incorrect tare value	→ Clear tare.
	• Contact between weighing pan and/or weighing sample and surroundings	→ Remedy contact.
	• Weighing platform tilted	→ Level weighing platform.
	• Load plate not on the scale • Weighing range not reached	→ Place load plate on the scale. → Set to zero.
	• Weighing range exceeded	→ Unload scale. → Reduce preload.
	• Result not yet stable	→ If necessary, adjust vibration adapter.
"Attention: Approval invalid" alternating with metrological data	• Approval was tampered with	→ Call METTLER TOLEDO service technician.

5.2 Errors and warnings

5.2.1 Error messages

Error messages contain the following information:

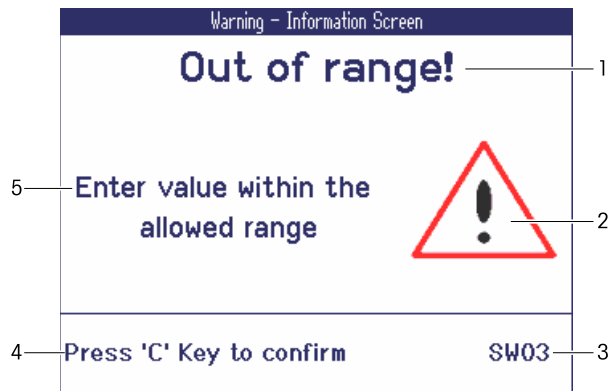

- 1 Error message
- 2 Warning symbol
- 3 Message identifier
- 4 How to clear the message
- 5 Remedy

5.2.2 Warnings

Warnings are displayed briefly and then disappear automatically.

Example

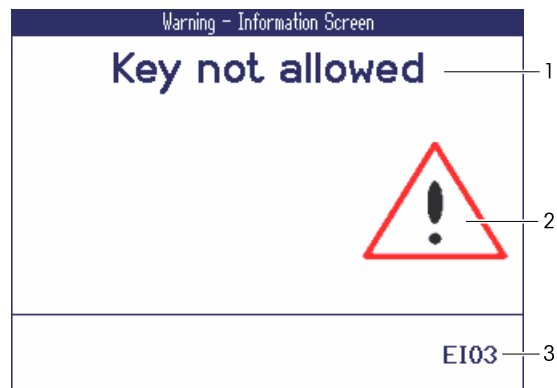

- 1 Warning
- 2 Warning symbol
- 3 Warning identifier

5.2.3**Information**

Information screens are displayed briefly and then disappear automatically.

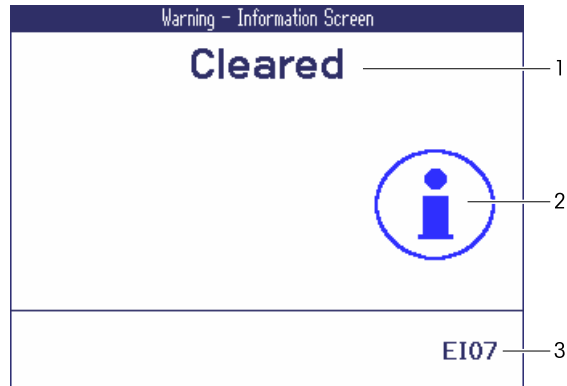
Example

- 1** Info message
- 2** Info symbol
- 3** Info identifier

5.3 Smart weighing counter / spanner icon

This weighing instrument features several control functions to monitor the condition of the device.

The METTLER TOLEDO service technician can setup and enable these functions.

This helps the user and the METTLER TOLEDO service technician to determine how the device is treated and what measures are needed to keep it in a good shape.

If the control functions triggers an alert, a message is shown.

You can confirm the message and continue to work with the weighing instrument. The spanner icon  lights up.

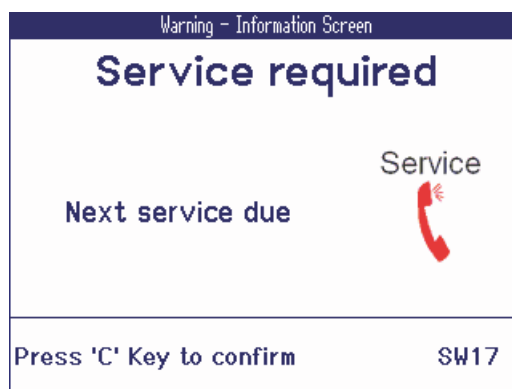

In case of an alert we strongly recommend calling the METTLER TOLEDO service technician

- to replace parts which are at the end of lifetime,
- to correct wrong settings,
- to educate operators about proper handling,
- to perform routine service work,
- to reset the alert.

The control functions monitor the following conditions:

- number of weighings
- number of overloads
- maximum weight
- zero commands and zero failures
- battery charging cycles
- power-on time
- date for the next service inspection

6 Technical data and accessories

6.1 Technical data weighing terminal

Housing	Stainless steel 1.4301 or AISI 304
Display	<ul style="list-style-type: none"> • Color TFT graphical display, with backlighting • Size: 115 x 85 mm / 320 x 240 pixels
Keyboard	<ul style="list-style-type: none"> • Tactile-touch membrane keypad • Scratch-resistant labelling
Protection type	<ul style="list-style-type: none"> • Terminal IP68/IP69k • Standard weighing platform IP68/IP69k • Weighing platform with option load cell with KS+ coating IP68/IP69k
Net weight	<ul style="list-style-type: none"> • Terminal 2.3 kg / 5.1 lb • ICS639a.../c 3.6 kg / 7.9 lb + weight of the weighing platform
Mains connection	<ul style="list-style-type: none"> • Direct connection to power supply (supply voltage fluctuation not exceeding ± 10 % of the rated voltage) • Rated voltage 100 ... 240 VAC / 50 ... 60 Hz / 300 mA
Storage battery operation	<ul style="list-style-type: none"> • Supply of device: 12 V \equiv / 2.5 A • If the supply voltage is interrupted, the device automatically switches over to storage battery operation
Battery charger	<ul style="list-style-type: none"> • Ambient conditions: 0 ... 40 °C / 32 ... 104 °F, dry environment
Ambient conditions	<ul style="list-style-type: none"> • Application indoor use only • Altitude up to 2,000 m • Temperature range Class III -10 ... 40 °C / 14 ... 104 °F • Temperature range Class II 0 ... 40 °C / 32 ... 104 °F • Overvoltage category II • Pollution degree 2 • Humidity: Max. rel. humidity 80 % for temperatures up to 31 °C, decreasing linearly to 50 % rel. humidity at 40 °C
Interfaces	<ul style="list-style-type: none"> • 1 interface RS232 integrated • ICS639a-.../c: <ul style="list-style-type: none"> – 1 additional optional communication interface possible • ICS639a/d, ICS639a-.../f, ICS639a-.../t <ul style="list-style-type: none"> – 2 additional optional communication interfaces possible – 1 additional scale interface possible
W & M approvals	<ul style="list-style-type: none"> • OIML Class II, III, IIII • NTEP Class II, III

Applications and features

- Weighing
- Average weighing
- Alibi log file
- Routine test function
- Calibration log file
- User management

Operating life with storage battery

The operating life during storage battery operation differs depending on the intensity of use, the configuration and the connected scale.

The following approximate values apply with standard RS232 interface and the brightness set to 5.

Weighing platform	Conditions	Duration
With 1 strain gauge weighing cell, e.g., ICS639a-A15...	10 % operation, 90 % power-off mode	150 h
	Continuous operation	15 h
With 4 strain gauge weighing cells, e.g., a floor scale	10 % operation, 90 % power-off mode	120 h
	Continuous operation	12 h
K line weighing platforms	10 % operation, 90 % power-off mode	60 h
	Continuous operation	6 h

Dimensional drawing

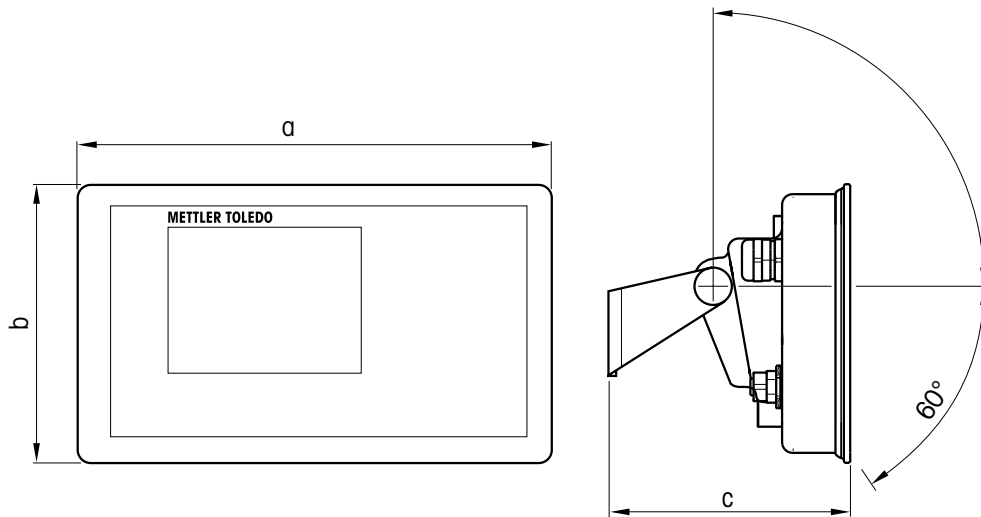

Dimension	[mm]	["]
a	260	10.24
b	170	6.70
c	114	4.49

6.2



Technical data weighing platforms

- The size of the weighing platform (A, BB, B, BC, CC, QB, QC) is indicated at the end of the product name, e.g., ICS639a-A6.
- Other combinations of weighing range and readability can be adjusted by the METTLER TOLEDO service technician on site.
- The table below indicates the factory settings of weighing range and readability.

Weighing ranges and readability (factory setting)

Model	Settings in kg / g		Settings in lb	
	Range	Readability	Range	Readability
A3	1.5 kg / 3 kg	0.5 g / 1 g	2.5 lb / 5 lb	0.0005 lb / 0.001 lb
A6, QA6	3 kg / 6 kg	1 g / 2 g	5 lb / 10 lb	0.001 lb / 0.002 lb
A15, QB15	6 kg / 15 kg	2 g / 5 g	10 lb / 25 lb	0.002 lb / 0.005 lb
BB30, B30, QB30	15 kg / 30 kg	5 g / 10 g	25 lb / 50 lb	0.005 lb / 0.01 lb
BB60, B60, BC60, CC60, QB60, QC60	30 kg / 60 kg	10 g / 20 g	50 lb / 100 lb	0.01 lb / 0.02 lb
BC150, B150, CC150, QC150	60 kg / 150 kg	20 g / 50 g	100 lb / 250 lb	0.02 lb / 0.05 lb
BC300, CC300	150 kg / 300 kg	50 g / 100 g	250 lb / 500 lb	0.05 lb / 0.1 lb
CC600	300 kg / 600 kg	100 g / 200 g	500 lb / 1000 lb	0.1 lb / 0.2 lb

Operation limits – maximum static safe load

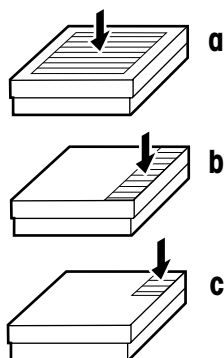

Model	a – center load	b – side load	c – corner load
A	30 kg / 60 lb	20 kg / 40 lb	10 kg / 20 lb
BB	100 kg / 200 lb	70 kg / 140 lb	35 kg / 70 lb
B	200 kg / 400 lb	140 kg / 280 lb	75 kg / 150 lb
BC	400 kg / 800 lb	300 kg / 600 lb	150 kg / 300 lb
CC	700 kg / 1400 lb	400 kg / 800 lb	200 kg / 400 lb
QA	15 kg / 30 lb	10 kg / 20 lb	5 kg / 10 lb
QB	100 kg / 200 lb	70 kg / 140 lb	35 kg / 70 lb
QC	200 kg / 400 lb	140 kg / 280 lb	75 kg / 150 lb

Weights, approx. values

Model	Weight in kg	Weight in lb
A	5.2	11.5
BB	7.4	16.3
B	12.7	28.0
BC	26.5	58.4
CC	35.0	77.2
QA	4.1	9.0
QB	7.8	17.2
QC	13.1	28.9

Length of load cell cable for ICS639a-.../t

Weighing range	Length in m	Length in ft
up to 30 kg / 50 lb	1.5	5
60 kg / 100 lb and higher	2.5	8

Dimensional drawings

The size of the weighing platform (A, BB, B, BC, CC, QB) is indicated at the end of the product name, e.g., ICS639a-A6.

Weighing platform

Front view

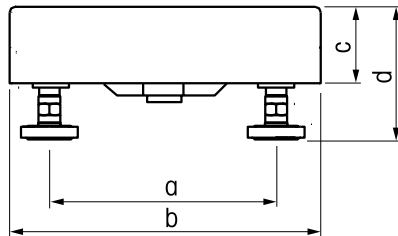

Side view

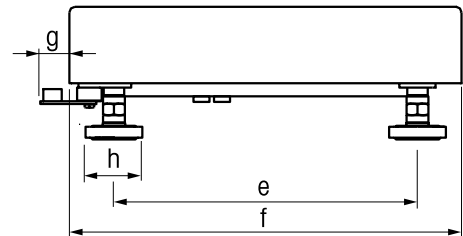

	A		BB		B		BC		CC		QA		QB		QC	
Dim.	[mm]	["]	[mm]	["]	[mm]	["]	[mm]	["]	[mm]	["]	[mm]	["]	[mm]	["]	[mm]	["]
a	175	6.89	235	9.25	335	13.19	435	17.13	503	19.80	170	6.69	233	9.17	392	15.43
b	240	9.45	300	11.81	400	15.75	500	19.69	600	23.62	229	9.02	305	12.01	457	17.99
c	56	2.20	57	2.24	57	2.24	70	2.76	79	3.11	56	2.20	57	2.24	60	2.36
d	95	3.74	97	3.82	100	3.94	108	4.25	130	5.12	95	3.74	108	4.25	100	3.94
e	235	9.25	335	13.19	435	17.13	587	23.11	724	28.50	170	6.69	245	9.65	397	15.63
f	300	11.81	400	15.75	500	19.69	650	25.59	800	31.50	229	9.02	305	12.01	457	17.99
g	22	0.87	15	0.59	15	0.59	15	0.59	21	0.83	22	0.87	15	0.59	15	0.59
h	Circle diameter: 30 mm / 1.18"; diagonal: 34 mm / 1.34"															

* min. height = d, max. height = d + 15 mm / d + 0.59"

ICS639a-.../f

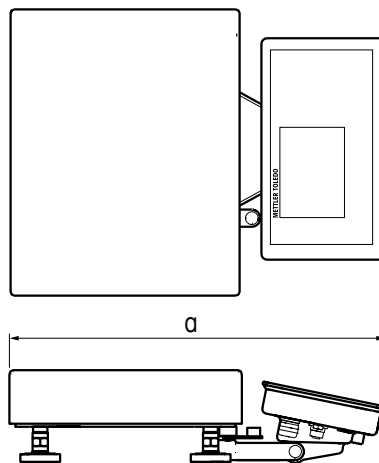

	A		BB		B		BC		CC		QA		QB		QC	
Dim.	[mm]	["]	[mm]	["]	[mm]	["]	[mm]	["]	[mm]	["]	[mm]	["]	[mm]	["]	[mm]	["]
a	418	16.46	485	19.09	581	22.87	681	26.81	772	30.39	407	16.02	489	19.25	640	25.10

ICS639a-.../c

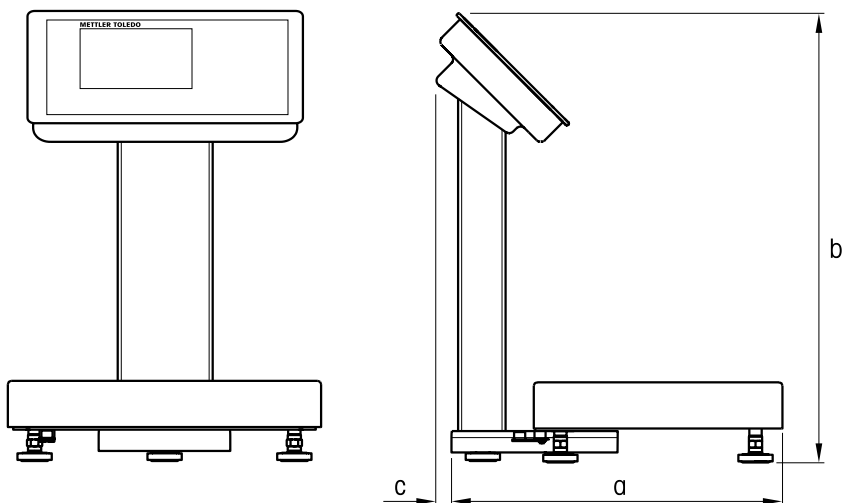

	A		BB		B		BC		CC		QA		QB		QC	
Dim.	[mm]	["]	[mm]	["]	[mm]	["]	[mm]	["]	[mm]	["]	[mm]	["]	[mm]	["]	[mm]	["]
a	337	13.27	404	15.91	500	19.69	600	23.62	691	27.2	326	12.83	408	16.06	559	22.01
b	412 mm / 16.22"															
c	34 mm / 1.34"															

6.3

Accessories

Printers	Order no.
GA46 printer, RS232, incl. 8-pin M12 plug	
2.5 m cable	22 019 925
0.4 m cable	22 019 926
Retrofitable interfaces (conversion kits)	Order no.
Kit must be fitted by a METTLER TOLEDO service technician	
RS232 conversion kit	
terminal version	22 012 112
.../c version	22 012 117
RS422/RS485 conversion kit	
terminal version	22 012 113
.../c version	22 012 118
Ethernet conversion kit	
terminal version	22 012 114
.../c version	22 012 119
USB Device conversion kit	
terminal version	22 012 115
.../c version	22 012 120
Digital I/O conversion kit, 4 outputs and 4 inputs	
terminal version	22 012 116
.../c version	22 012 121
WLAN conversion kit	
terminal version	22 012 126
.../c version	22 012 127
Plugs	Order no.
RS232 counter plug, 8 pin M12	22 021 105
RS485 counter plug, 6 pin M12	22 021 106
Ethernet counter plug, 4 pin, Coding D, M12	22 021 107
USB counter plug, 4 pin, Coding A, M12	22 021 108

Cables (always delivered with 90° angled M12 plug)	Order no.
RS232 cable for SICS scale, 8 pin M12 <-> 9 pin sub D plug, 3 m	22 021 088
RS232 cable for PC, 8 pin M12 <-> 9 pin sub D receptacle, 3 m	22 021 087
RS422/RS485 cable, 6 pin M12 <-> open ends, 3 m	22 021 089
Ethernet 10/100 Base T twisted pair cable, 4 pin M12 Coding D <-> RJ45 5 m	22 021 090
20 m	22 021 091
USB adapter cable, 4 pin M12 Coding A <-> USB series A receptacle 0.2 m	22 021 122
5 m	22 021 123
USB cable, connection to PC, 4 pin M12 Coding A <-> USB series A plug, 3 m	22 021 092
USB cable, connection to USB devices, 4 pin M12 Coding A <-> USB series B plug, 3 m	22 021 124
Cable to connect Digital I/O option with Relay box, 12 pin M12 <-> open ends, 10 m	22 021 093
I/O accessories	Order no.
Relay box for Digital I/O option	22 011 967
Power supply for Relay box 4 (110–230 VAC)	00 505 544
Adapters *	Order no.
RS232 adapter, 8 pin M12 plug <-> 8 pin Binder receptacle, 0.2 m	22 021 094
RS485 adapter, 6 pin M12 plug <-> 6 pin Binder receptacle, 0.2 m	22 021 095
Ethernet adapter, 4 pin Coding D M12 plug <-> 16 pin Binder receptacle, 0.2 m	22 021 096
USB adapter, 4 pin Coding A M12 plug <-> 16 pin Binder receptacle, 0.2 m	22 021 097
Digital I/O adapter, 12 pin M12 plug <-> 19 pin Binder receptacle, 0.2 m	22 021 098

* Use already installed cables/plugs with our new ICS6x9 M12 plug

Mechanical parts	Order no.
Protective cover for terminals ICS6x9, set of 3 pieces	22 021 110
Stand ICS6x9, height 50 mm	22 018 057
Stand ICS6x9, for PBA430 weighing platform height 330 mm height 660 mm	22 013 964 22 013 965
Stand ICS6x9 for KA, KB, MA, MB and DB platforms, height 330 mm	22 014 836
Bench stand ICS6x9 for scale bench 00503632 or 00504854, height 500 mm	22 014 835
Floor stand ICS6x9, height 1000 mm	22 014 834
Standbase for floor stand	22 011 982
Wall bracket ICS6x9, inclinable and swivelling	22 014 833
Desk mounting plate, for terminal and .../t version only	22 021 111

7 Appendix

7.1 Tests for utilisation in hygienically sensitive areas

ICS639 weighing terminals have been assessed by the EHEDG (European Hygienic Engineering and Design Group) and the NSF (National Sanitation Foundation). Both institutes certify the fulfilment of the hygienic requirements for easy cleaning (Hygienic Design Criteria).

EHEDG The EHEDG is an association of device manufacturers, firms in the foodstuff industry, research institutes and health authorities. It was founded in 1989 with the aim of promoting the hygienically faultless manufacturing and packaging of foodstuffs. A positive expertise of the device by the EHEDG has taken place. A corresponding report is available on the internet under www.mt.com.

NSF NSF is an independent NGO founded in 1944 in the USA. Corresponding regulations were published for the use of devices in the foodstuff industry. The device fulfils the NSF criteria C-2 (Special Equipment and/or Devices) for use in the foodstuff industry. The products are listed on the NSF site: www.nsf.org.

7.2 Notice for verified instruments in EC countries



Weighing instruments verified at the place of manufacture bear the preceding mark on the packing label and a green "M" sticker on the descriptive plate. They may be set to work immediately.



Weighing instruments which are verified in two steps have no green "M" on the descriptive plate and bear the preceding identification mark on the packing label. The second step of the verification must be carried out by the approved METTLER TOLEDO service or Weights and Measures authorities. Please contact your METTLER TOLEDO organisation. The first step of the verification has been carried out at the manufacturing plant.

If national regulations in individual countries limit the period of validity of the verification, the operator of such a weighing instrument is himself responsible for its timely re-verification.

7.3 Tables of Geo Code values

For weighing instruments verified at the manufacturer's, the Geo Code value indicates the country or geographical zone for which the instrument is verified. The Geo Code value set in the instrument (e.g. "Geo 18") appears briefly after switching on.

Table "Geo Code values 3000e" shows the Geo Code values for European countries.

Table "Geo Code values 6000e/7500e" shows the Geo Code values for different gravitation zones.

7.3.1 Geo Code values 3000e, OIML Class III (European Countries)

Country	Geographical latitude	Geo Code value
Austria	46°22' – 49°01'	18
Belgium	49°30' – 51°30'	21
Bulgaria	41°41' – 44°13'	16
Croatia	42°24' – 46°32'	18
Czechia	48°34' – 51°03'	20
Denmark	54°34' – 57°45'	23
Estonia	57°30' – 59°40'	24
Finland	59°48' – 64°00'	25*
	64°00' – 70°05'	26
France	41°20' – 45°00'	17
	45°00' – 51°00'	19*
Germany	47°00' – 55°00'	20
Greece	34°48' – 41°45'	15
Hungary	45°45' – 48°35'	19
Iceland	63°17' – 67°09'	26
Ireland	51°05' – 55°05'	22
Italy	35°47' – 47°05'	17
Latvia	55°30' – 58°04'	23

Country	Geographical latitude	Geo Code value
Liechtenstein	47°03' – 47°14'	18
Lithuania	53°54' – 56°24'	22
Luxemburg	49°27' – 50°11'	20
Netherlands	50°46' – 53°32'	21
Norway	57°57' – 64°00'	24*
	64°00' – 71°11'	26
Poland	49°00' – 54°30'	21
Portugal	36°58' – 42°10'	15
Romania	43°37' – 48°15'	18
Slovakia	47°44' – 49°46'	19
Slovenia	45°26' – 46°35'	18
Spain	36°00' – 43°47'	15
Sweden	55°20' – 62°00'	24*
	62°00' – 69°04'	26
Switzerland	45°49' – 47°49'	18
Turkey	35°51' – 42°06'	16
United Kingdom	49°00' – 55°00'	21*
	55°00' – 62°00'	23

* factory setting

7.3.2

Geo Code values 6000e/75000e OIML Class III (Height ≤ 1000 m)

Geographical latitude	Geo Code value	Geographical latitude	Geo Code value
00°00' – 12°44'	18	43°26' – 47°51'	18
05°46' – 17°10'	21	45°38' – 50°06'	22
12°44' – 20°45'	16	47°51' – 52°22'	20
17°10' – 23°54'	18	50°06' – 54°41'	21
20°45' – 26°45'	20	52°22' – 57°04'	24*, 26
23°54' – 29°25'	23	54°41' – 59°32'	21
26°45' – 31°56'	24	57°04' – 62°09'	15
29°25' – 34°21'	25*, 26	59°32' – 64°55'	18
31°56' – 36°41'	17, 19*	62°09' – 67°57'	19
34°21' – 38°58'	20	64°55' – 71°21'	18
36°41' – 41°12'	15	67°57' – 75°24'	15
38°58' – 43°26'	19	71°21' – 80°56'	24*, 26
41°12' – 45°38'	26	75°24' – 90°00'	18

* factory setting

7.4

**Disposal**

In conformance with the European Directive 2002/96 EC on Waste Electrical and Electronic Equipment (WEEE), this device may not be disposed of with domestic waste. This also applies to countries outside the EU, according to their specific requirements.

Please dispose of this product in accordance with local regulations at the collecting point specified for electrical and electronic equipment.

If you have any questions, please contact the responsible authority or the distributor from which you purchased this device.

Should this device be passed on to other parties (for private or professional use), the content of this regulation must also be related.

Thank you for your contribution to environmental protection.

7.5

Protocol printouts

GA46 printouts, in English

Straight weighing

```
XXXXXXXXXXXXXXXXXXXXXXXXX
Gross      1.19 kg
Net        0.37 kg
Tare       0.82 kg
```

Starline
Gross/Net/Tare weights
New line

Average weighing

```
XXXXXXXXXXXXXXXXXXXXXXXXX
Gross      1.19 kg
NetAverage 0.37 kg
Tare       0.82 kg
```

Starline
Gross/Net/Tare weights
New line

Printout with header (standard printout)

```
HETTLER TOLEDO
Tel. +49 7431 140
Germany
mettler.com

Date      27/04/2010
Time      22:21:14
Net       0.37 kg
Tare      0.82 kg

Dev.Id    #4591-22.A
Dev.Loc   Building B9
```

Header
New line
Date & Time
Net/Tare weights
New line
Device information
New line

Printout with header and identification data

```
HETTLER TOLEDO
Tel. +49 7431 140
Germany
mettler.com
Date      27/04/2010
Time      21:50:48
ID1       Company ABC
ID2       67195 Tonn
Net       0.57 kg
Tare      0.82 kg
Gross     1.39 kg
```

Header
Date & Time
Identifications
Net/Tare/Gross weights
New line

7.6 Index

- A**
- Accessories 69
 - Alibi log 14, 37, 56
 - Average weighing 22, 36
- B**
- Barcode
 - Destination 46
 - Identification 22
 - Tare preset 21
 - Battery
 - Handling 16
 - Specification 62
 - Beeper 41
- C**
- Calendar 41
 - Calibration log 15
 - Cleaning 24
 - Commissioning 15
 - Connections 13
- D**
- Date 41
 - Device information 40
 - Display 8
 - 3-line mode 8
 - Backlighting 40
 - Bargraph 8, 21
 - Brightness 40
 - Calendar 8
 - Capacity available 8, 21
 - Colours 40
 - Contrast 40
 - Default layout 8
 - Metrological data 9
 - Presentation in the menu ... 28
 - Symbols and info line 10
 - Weight display 9
 - Disposal 74
 - Dynamic weighing 22, 36
- E**
- Environment 24, 62
 - Errors 58
 - Error conditions 58
 - Error messages 59
- G**
- Geo value 18, 26, 73
- I**
- Identifications , 22
 - Info key , 23
 - Information 60
 - Interface settings 42
 - Digital I/O 48
 - Ethernet 49
 - RS232 44
 - RS422 / RS485 44
 - USB 49
 - WLAN 50
- K**
- Keyboard 11
 - Key lock 40
- L**
- Log files
 - Alibi log file 56
 - Routine test log file 55, 56
 - Login/logout 18
- M**
- Menu
 - Access 42
 - Application 36
 - Communication 42
 - Maintenance 51
 - Operation 27
 - Password 27, 42
 - Quick Select 53
 - Scale (analog) 30
 - Scale (IDNet) 33
 - Terminal 38
 - Messages 58
 - MinWeigh 33, 35
 - Mode
 - Demand mode 45
 - Dialog mode 45
 - Print mode 45
 - MT continuous 42
- O**
- Options 7, 66
 - Output mode 48
- P**
- Power off 39
 - Power supply 16, 62
 - Printing 23
 - Printout
 - Examples 75
 - Templates 50
- Q**
- Quick Select
 - Alibi log file 56
 - Enter main menu 53
 - Logout 53
 - Routine test 54, 55, 56
- R**
- Routine test , 14, 54, 55, 37
- S**
- Safety instructions 5, 25
 - Setpoints 48
 - SICS
 - Command set 42
 - Identifications 22
 - Tare preset 21
 - Simple weighing 19
 - Sleep mode 39
 - Smart weighing counter 61
 - Spanner icon 8, 61
 - Switching on and off 18

T

Tare

Automatic clearing 20, 32, 34

Automatic taring ... 20, 32, 34

Chain tare 20, 32, 34

Tare preset 21

Taring 19

Technical data

Weighing platforms 65

Weighing terminal 62

Terminal and platform

combinations 6, 65

Test

Display 51

Keyboard 51

Scale 51

Verification 26

Time 41

U

User management 14, 41

V

Verified instruments in EC

countries 72

W

Warnings 59

Z

Zero

Automatic zero update. 32, 34

Zeroing 19

Zero point correction 19

**To protect your METTLER TOLEDO
product's future:**

METTLER TOLEDO Service XXL assures
the quality, measuring accuracy and
preservation of value of all METTLER
TOLEDO products for years to come.

Please send for full details about our
attractive terms of service.
Thank you.

www.mt.com/service

For more information

Mettler-Toledo (Albstadt) GmbH

D-72458 Albstadt
Tel. +49 7431-14 0
Fax +49 7431-14 232

Subject to technical changes
© 11/2010 Mettler-Toledo (Albstadt) GmbH
Printed in Germany
Order number 22021151A

