

Excellence Micro- Ultra-Micro Balances

XP / XS Models – Part 1



METTLER TOLEDO

Table of Contents

1	Introduction		5
	1.1	Symbols and presentations used	6
2	Safety Information		7
	2.1	Definition of signal warnings and symbols	7
	2.2	Product specific safety notes	7
3	Overview of XP/XS Micro and Ultra Micro Balances		9
4	Installation and Putting into Operation		11
	4.1	Unpacking	11
	4.2	Scope of delivery	12
	4.3	Location	12
	4.4	Assembling the balance	13
	4.5	Connecting the balance	13
	4.6	Operating of the glass draft shield	14
	4.7	Setting the reading angle and positioning the terminal	15
	4.7.1	Optimise the readability of the terminal	15
	4.7.2	Remove terminal and place close to the balance	15
	4.8	Transporting the balance	16
	4.8.1	Transporting over short distances	16
	4.8.2	Transporting over long distances	16
	4.9	Below-the-balance weighing	17
5	First Steps		18
	5.1	Switching on / off	18
	5.2	Leveling the balance	18
	5.3	Leveling aid of the XP models	18
6	Maintenance		20
	6.1	Cleaning	20
	6.2	Disposal	22
7	Technical Data		23
	7.1	General data	23
	7.2	Explanatory notes for the METTLER TOLEDO AC adapter	23
	7.3	Model-specific data	24
	7.4	Dimensions	27
	7.4.1	Dimensions of the terminal and control unit of XP models	27
	7.4.2	Dimensions of the terminal and control unit of XS models	28
	7.4.3	Dimensions of the weighing cell (XS and XP models)	29
	7.5	Interfaces	30
	7.5.1	Specifications of RS232C	30
	7.5.2	Specifications of "Aux" connection	30
8	Accessories and Spare Parts		31
	8.1	Accessories	31
	8.2	Spare parts	38

9	Appendix		41
	9.1	MT-SICS interface commands and functions	41
	9.2	Procedure for certified balances	41
	Index		43

1 Introduction

Thank you for choosing a METTLER TOLEDO balance.

The balances of the XP/XS line combine a large number of weighing and adjustment possibilities with exceptionally convenient operation.

In this chapter you will be given basic information about your balance. Please read right through this chapter carefully even if you already have experience with METTLER TOLEDO balances. Please pay special attention to the safety warnings!

The different models have different characteristics regarding equipment and performance. Special notes in the text indicate where this makes a difference to operation.

The XP/XS line comprises a range of balances which differ from each other in relation to their weighing range and resolution.

The following features are common to all models of the XP/XS lines:

- Glass draft shield for precise weighing even in unstable environments (XP models with motorized drive).
- Fully automatic adjustment using internal weights ("ProFACT" on XP models, "FACT" on XS models).
- Built-in level sensor, illuminated level indicator and Leveling Assistant for fast and easy leveling (XP models only).
- Built-in applications for normal weighing, statistics, formulation, piece counting, percent weighing, density, differential weighing (XP models only) and LabX Client.
- Integral RS232C interface.
- Slot for second interface (optional).
- Touch-sensitive graphics terminal ("Touch screen") with color (XP models) or monochrome display (XS models).
- Two programmable sensors for hands-off operation ("SmartSens") to speed up frequently recurring tasks (XP models).

A brief word about standards, guidelines, and methods of quality assurance: The balances comply with usual standards and guidelines. They support standard procedures, specifications, working methods, and reports according to **GLP (Good Laboratory Practice)**. In this connection, records of working procedures and adjustments become very important; for this purpose we recommend you to use a printer from the METTLER TOLEDO range, since these are optimally adapted to your balance. The balances conform to the applicable standards and guidelines and possess a EC declaration of conformity. METTLER TOLEDO is certified as manufacturer according to ISO 9001 and ISO 14001.

The operating instructions for the XP/XS balances consist of 3 separate documents, whose contents are listed below.

Part 1, this document

Contents

- Introduction
- Safety information
- Installation and putting into operation
- Leveling the balance
- Cleaning and service
- Technical data
- Accessories
- Spare parts
- Interface commands and MT-SICS functions

Part 2, separate document

Contents: Terminal, System, and Applications

- Basic principles for using the terminal and the firmware
- System settings
- User-specific settings (XP models only)
- Applications
- Firmware (Software) updates
- Error and status messages
- Conversion table for weight units
- Recommended printer settings

Part 3, separate document

Contents: Adjustments, and Tests

- Adjustments
- Tests

Finding more information



► www.mt.com/excellence

Firmware version

The operating instructions are based on the initially installed terminal firmware (software) version V 4.20.

1.1 Symbols and presentations used

The following conventions apply to the operating instructions: part 1, part 2 and part 3.

Key and button designations are indicated by a picture or text in square brackets (e.g. «» or «**On/Off**» XP models, «» or «**On/Off**» XS models).



This symbol indicates press key briefly (less than 1.5 s).



This symbol indicates press and hold key down (longer than 1.5 s).

These symbols indicate an instruction:

- prerequisites
- 1 steps
- 2 ...
- ⇒ results

2 Safety Information

2.1 Definition of signal warnings and symbols

Safety notes are indicated by signal words and warning symbols and contain warnings and information about safety issues. Ignoring safety notes can lead to personal injury, damage to the instrument, malfunctions and erroneous results.

Signal words

WARNING	for a hazardous situation with medium risk, possibly resulting in severe injuries or death if not avoided.
CAUTION	for a hazardous situation with low risk, resulting in damage to the device or the property or in loss of data or minor or medium injuries if not avoided.
Attention	(no symbol) for important information about the product.
Note	(no symbol) for useful information about the product.

Warning symbols



General hazard



Electrical shock

2.2 Product specific safety notes

Intended use

Your balance is used for weighing. Use the balance exclusively for this purpose. Any other type of use and operation beyond the limits of technical specifications without written consent from Mettler-Toledo AG, is considered as not intended.



It is not permitted to use the instrument in explosive atmosphere of gases, steam, fog, dust and flammable dust (hazardous environments).

General safety information

Your instrument meets the state of the art technology and complies with all recognized safety rules, however, certain hazards may arise in extraneous circumstances. Do not open the housing of the instrument: It does not contain any parts which can be maintained, repaired or replaced by the user. If you ever have problems with your instrument, contact your authorized METTLER TOLEDO dealer or service representative.

Always operate and use your balance only in accordance with the operating instructions part 1, part 2 and part 3.

The instructions for setting up your new balance must be strictly observed.

If the instrument is not used according to the manufacturer's operating instructions (part 1, part 2 and part 3), protection of the instrument may be impaired.

Staff safety

In order to use the instrument, you must have read and understood the operating instructions. Keep the operating instructions for further reference.

Never make any modifications to the instrument and use only original spare parts and optional equipment from METTLER TOLEDO.

Safety notes



WARNING

Risk of electric shock

Use only the original universal AC adapter delivered with your balance, and check that the voltage printed on it is the same as your local power supply voltage. Only plug the adapter into a socket which is grounded.



CAUTION

Damage to the balance

- a) Only use indoors in dry locations.
 - b) Do not use pointed objects to operate the keyboard!
The balance is of a very sturdy design, but is still a precision instrument. It must be handled with care.
 - c) Do not open the balance:
The balance contains no user-serviceable parts. In the event of problems, please contact a METTLER TOLEDO representative.
 - d) Only use METTLER TOLEDO original accessories and peripheral devices for the balance. These are specifically designed for the balance.
-

3 Overview of XP/XS Micro and Ultra Micro Balances



- 1 Terminal (XS models: Type "S", monochrome / XP models: Type "P", color), (details **see** Operating Instructions – Part 2)
- 2 Display (Touch-sensitive "Touch screen")
- 3 Operating keys
- 4 SmartSens sensors (terminal type "P" only)
- 5 Type name
- 6 Control unit
- 7 Drawer with weighing tweezers, cleaning brush, and cleaning tweezers



- 8 Door handle
- 9 Weighing chamber plate
- 10 Weighing pan
- 11 Glass draft shield
- 12 Level indicator
- 13 Weighing cell
- 14 Foot screws



- 15 Socket for control unit



- 16** Slot for second interface (optional)
- 17** Socket for AC adapter
- 18** Socket for terminal
- 19** RS232C serial interface
- 20** Socket for weighing cell
- 21** Aux sockets for hand- or foot-switch (XS models) or "ErgoSens" (XP models)

4 Installation and Putting into Operation

This chapter explains how to unpack your new balance, and how to set it up and prepare it for operation. When you have carried out the steps described in this chapter, your balance is ready for operation.

4.1 Unpacking

Note

Please keep all parts of the packaging. This packaging guarantees best possible protection of your balance for transportation.

- 1 Open the outer packaging box.
- 2 Grasp the strap on the inner box and pull this out of the outer box along with the padding.



- 1 Remove the padding.
- 2 Take the inner box out of the plastic bag and place it on a level surface with the opening flap facing up.
- 3 Open the inner box (open the flap and remove the cardboard sleeve).



- Remove the following parts from the upper part of the packaging:
 - Documents (1), already removed here.
 - Connecting cable (2) for weighing cell – control unit.
 - Glass cover (3) of the draft shield.
 - Power cable (4) country-specific for the AC adapter.
 - AC adapter (5).



- 1 Lift off the upper part of the inner packaging.
⇒ You will find the following parts in the lower part:
- 2 Remove the following parts from the packaging:
 - Weighing cell (6) with draft shield.
 - Plastic box (7), contains the parts for the draft disk.
 - Control unit (8) with mounted terminal (9) and protective cover for the terminal.
- 1 Remove the parts from the packaging.
- 2 Remove the shipping lock (10) (plastic protection) from the draft shield.

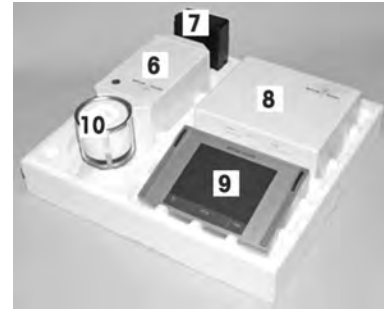

See also

- Transporting the balance (page 16)

4.2 Scope of delivery

The standard scope of delivery contains the following items:

- Weighing cell and control unit with terminal installed, protective cover for the terminal
 - RS232C interface
 - Slot for second interface (optional)
 - Feedthroughs for below-the-balance weighing
- Weighing pan is installed, draft disk and hook weighing pan (XP6U) are delivered separately and must be installed by the user
- AC adapter with country-specific power cable
- Connection cable for connecting the weighing cell to the control unit
- Cleaning brush
- Cleaning tweezers
- Weighing tweezers
- Production certificate
- CE declaration of conformity
- Operating instructions part 1 (this document), part 2 and part 3

4.3 Location

An optimal location will ensure accurate and reliable operation of the balance. The surface must be able to safely take the weight of the balance when fully loaded. The following local conditions must be observed:

Note

If the balance is not horizontal at the outset, it must be leveled during commissioning.

- The balance must only be used indoors and up to a maximum altitude of 4,000 m above sea level.
- Before switching on the balance, wait until all parts are at room temperature (+5 to 40 °C).
The humidity must be between 10% and 80% non-condensing.
- The power plug must be accessible at all times.
- Firm, horizontal and vibration-free location.
- Avoid direct sunlight.
- No excessive temperature fluctuations.
- No strong drafts.

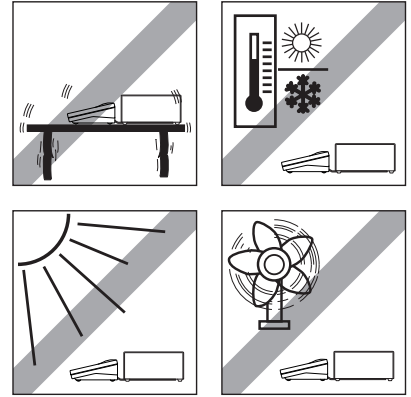

Further information can be found in Weighing the Right Way.

4.4 Assembling the balance

- 1 Remove the parts for the draft disk from the black plastic box.
- 2 Assemble the parts according to the instructions in the cover of the plastic box.
- 3 Connect the terminal cable (1) to the control unit.
- 4 Use the cable delivered (2) to connect the control unit to the weighing cell.



XP6U only

A hook weighing pan is also delivered with this model.

- 1 If you wish to use this, remove the standard round weighing pan.
- 2 Install the hook weighing pan according to the instructions in the cover of the black plastic box.



4.5 Connecting the balance



WARNING

Risk of electric shock

- a) To connect the balance, only use the supplied three-core power cord with equipment grounding conductor.
- b) Only connect the balance to a three-pin power socket with earthing contact.
- c) Only standardized extension cable with equipment grounding conductor must be used for operation of the balance.
- d) Intentional disconnection of the equipment grounding conductor is forbidden.

The balance is supplied with an AC adapter and country-specific power cord. The AC adapter is suitable for use with the following voltage range:

100 – 240 V AC, 50/60 Hz.

Attention

- Check whether your local power supply falls within this range. If this is not the case, under no circumstances connect the AC adapter to the power supply, but contact a METTLER TOLEDO representative.
- The power plug must be accessible at all times.
- Prior to use, check the power cord for damage.
- Route the cable in such a way that it cannot be damaged or cause a hindrance when working.
- Ensure that no liquid comes into contact with the AC adapter.

► Balance and terminal are at the final location.

1 Connect the AC adapter (1) to the connection socket (2) at the rear of the balance.

2 Connect the AC adapter (1) to the power supply.

⇒ The balance performs a self-test after connection to the power supply and is then ready to use.

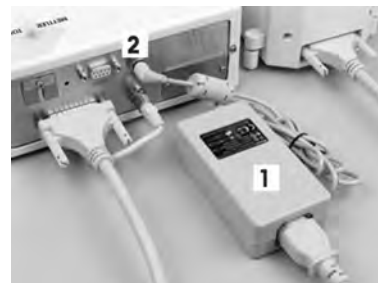

Note

If the display field remains dark, even though the power supply connection functions.

1 First disconnect the balance from the power supply.

2 Open the terminal.

Terminal of XP models

- Press both buttons (1) on the back of the terminal and open the upper part of the terminal.

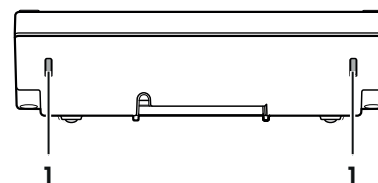

Terminal of XS models

- Press both flaps (1) on the side of the terminal and open the upper part of the terminal.

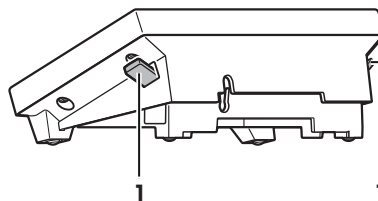

1 Check that the plug for the terminal cable (1) is connected correctly inside the terminal.

2 Ensure that the ferrite core (2) makes full contact on the plug.



4.6 Operating of the glass draft shield

The glass draft shield on your balance can be opened and closed by turning the door handle.

On **XP models**, the draft shield can also be operated via the [↕] button or the "SmartSens" sensors, **see** Operating Instructions – Part 2.

Attention

During weighing, always ensure that the draft shield is closed!

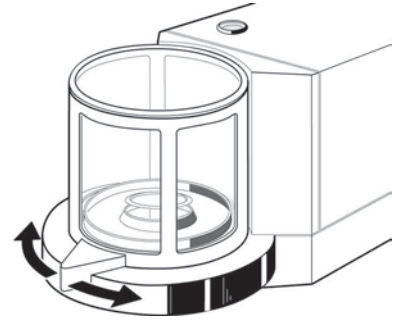

4.7 Setting the reading angle and positioning the terminal

4.7.1 Optimise the readability of the terminal

Changing the reading angle

- 1 Press both buttons (1) or flaps (1) used to open the terminal
 - ⇒ The top of the terminal can then be pulled up or pushed down until it engages in the desired position. A total of 3 setting positions are available.
- 2 Move it in an appropriate position.

XP Terminal

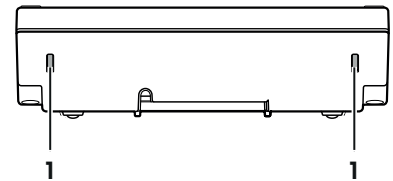

XS Terminal

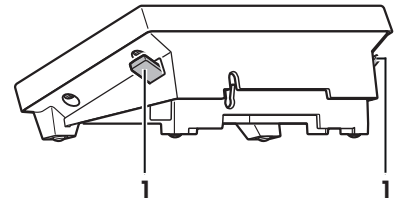

4.7.2 Remove terminal and place close to the balance

The terminal is attached to the control unit, but can be removed and positioned individually if necessary.

- 1 Switch off the balance and disconnect it from the power supply.
- 2 Open the terminal by pressing both buttons or flaps.
- 3 Unplug the cable from the connection socket in the terminal.
- 4 Detach the terminal from the terminal support.
On the XP models, unscrew both knurled screws (1) on the inside of the terminal.
On XS models, the terminal is attached with just one knurled screw (2).
- 5 Pull the terminal cable out of the terminal.
- 6 Release the cable guide (3) on the underside of the control unit (2 Torx T-10 screws).
⇒ The cable is now free and you can position the terminal separately.
The terminal support (4) is attached to the underside of the control unit with 2 screws (Torx T-20). You can leave the terminal support on the control unit or remove it.
- 7 Reconnect the balance to the power supply.

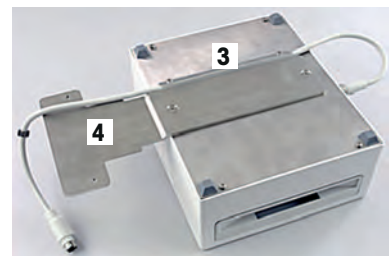

See also

- Connecting the balance (page 13)

4.8 Transporting the balance

- 1 Switch off the balance.
- 2 The balance must be disconnected from the power supply.
- 3 Remove any interface cable from the balance.
It is not necessary to disconnect the control unit from the weighing cell.

4.8.1 Transporting over short distances

If you wish to move your balance over a short distance to a new location, proceed as follows.



CAUTION

Damage of device

Never lift the balance by the glass draft shield, as this can cause damage!

- Grasp the control unit and weighing cell by the sides of the housing and carry them to their new location.

See also

- Location (page 12)

4.8.2 Transporting over long distances

If you want to transport or ship your balance over long distances, or if it is not certain that the balance will be transported upright, use the complete original packaging.

- Place the shipping lock (plastic protection) in the glass draft shield!



4.9 Below-the-balance weighing

So that weighings can be carried out below the working surface (below-the-balance weighing), your balance is provided with a special hanger.

- 1 Switch off the balance.
 - 2 Unplug the connection cable for the control unit from the back panel of the weighing cell.
 - 3 Remove the glass cover, the weighing pan, and the draft disk.
 - 4 Remove the draft shield from the unit.
 - 5 Carefully tip the weighing cell toward the back.
 - 6 Turn the cover plate of the hanger for below-the-balance weighing until the hole for the feedthrough is exposed.
- ⇒ The weighing cell is now ready for installing the feedthrough for below-the balance weighing.

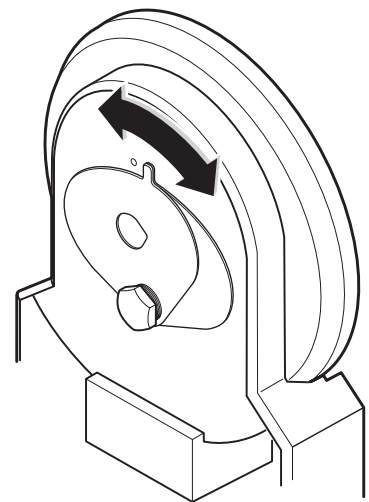

5 First Steps

5.1 Switching on / off

Switching on

- Press «On/Off».
- ⇒ The display appears.



Note

If the balance has not been set up exactly horizontally, a warning text will appear shortly after the balance is turned on, prompting you to level the balance.

Switching off

- Press «On/Off» until "Off" appears in the display.



Note

Do not disconnect the balance from the power supply except if you will not be using the balance for an extended period.

5.2 Leveling the balance

Check the position of the air bubble in the level indicator on the top of the weighing cell. If the air bubble is not in the inner circle, the weighing cell needs to be leveled.

Turn the two leveling screws on the back of the weighing cell until the air bubble is in the inner circle of the level indicator (left figure = leveled correctly, right figure = leveled incorrectly).

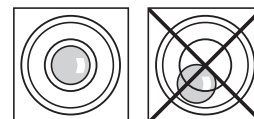

5.3 Leveling aid of the XP models

The XP models have a built-in leveling aid.

On the terminal, tap the large empty space below the weighing result.

- 1 To start the Leveling Assistant, tap «**Show**».
 - ⇒ The Leveling Assistant will guide you step by step through the leveling process.
 - 2 Watch the levelcontrol located of your balance and press the appropriate button of the current position.
 - ⇒ The Leveling Assistant will show you with red arrows in which direction you need to turn the two footscrews on the back of the weighing cell.
 - 3 Screw the footscrew until the air bubble is in the inner circle.
 - 4 Tap «**Exit**».
 - ⇒ A message appears that advises you to adjust the balance.
 - 5 Confirm with «**OK**».
- ⇒ Status icon will no longer appear and balance returns to normal operation.

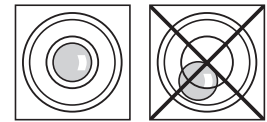
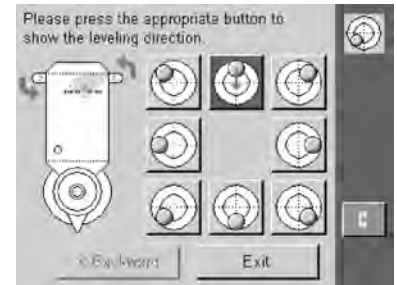
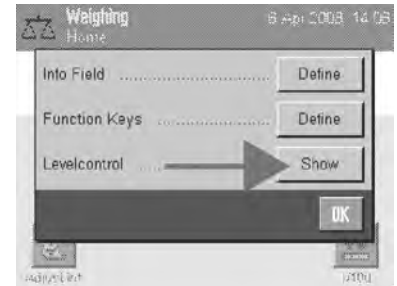

6 Maintenance

6.1 Cleaning

Periodically clean the weighing chamber, the housing, and the terminal of your balance using the brush supplied with it. The maintenance interval depends on your standard operating procedure (SOP).

Please observe the following notes



WARNING

Risk of electric shock

- a) Disconnect the balance from the power supply prior to cleaning and maintenance.
 - b) Only use METTLER TOLEDO power cords, if these need to be replaced.
 - c) Ensure that no liquid comes into contact with the balance, terminal or AC adapter.
 - d) Do not open the balance, terminal or AC adapter.
These contain no user-serviceable parts.
-



CAUTION

Damage of balance

On no account use cleaning agents which contain solvents or abrasive ingredients, as this can result in damage to the terminal overlay.

Cleaning

Your balance is made from high quality, resistant materials and can therefore be cleaned with a commercially available, mild cleaning agent.

- 1 To clean the weighing chamber thoroughly, pull the draft disk (which on the XP2U and XP6U balances is made up of several parts) and the weighing pan vertically up and off. It may be necessary to turn the weighing pan slightly to remove it.
- 2 When you replace these parts, make sure they are in the correct position.

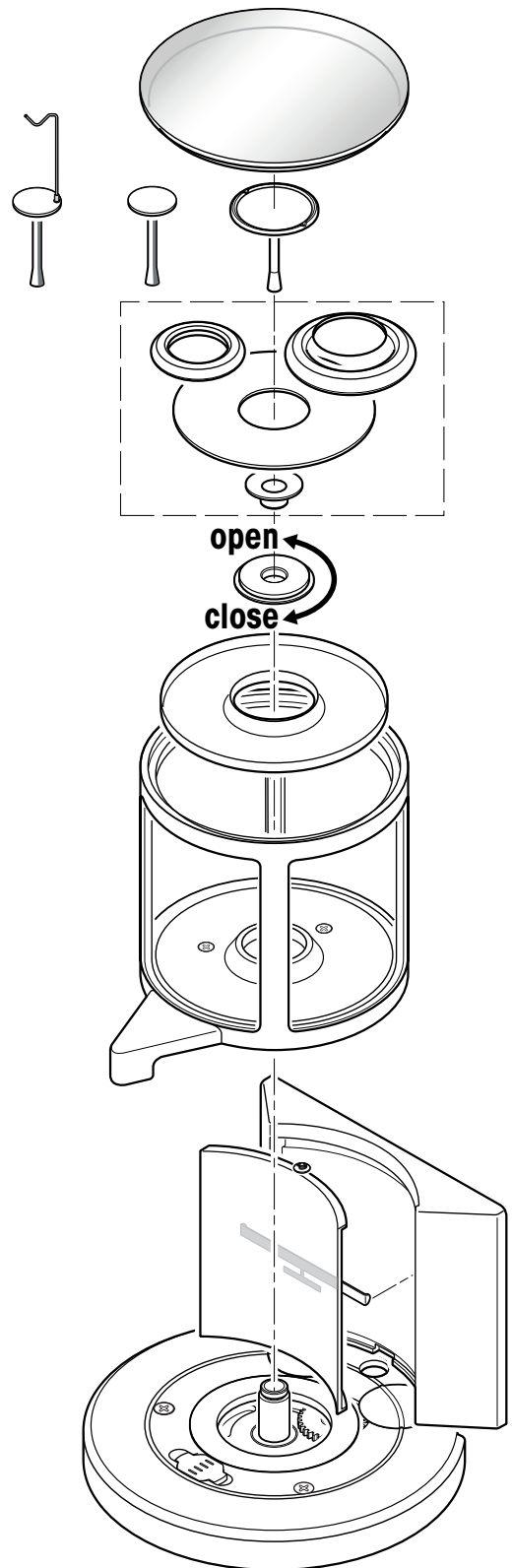

Note

Please contact your METTLER TOLEDO dealer for details of the available service options. Regular servicing by an authorized service engineer ensures constant accuracy for years to come and prolongs the service life of your balance.

6.2 Disposal

In conformance with the European Directive 2002/96/EC on Waste Electrical and Electronic Equipment (WEEE) this device may not be disposed of in domestic waste. This also applies to countries outside the EU, per their specific requirements.

Please dispose of this product in accordance with local regulations at the collecting point specified for electrical and electronic equipment. If you have any questions, please contact the responsible authority or the distributor from which you purchased this device. Should this device be passed on to other parties (for private or professional use), the content of this regulation must also be related.

Thank you for your contribution to environmental protection.



7 Technical Data

7.1 General data



CAUTION

Use only with a tested AC Adapter with SELV output current.
Ensure correct polarity

Power supply

AC adapter:	Primary: 100 – 240 V AC, -15%/+10%, 50/60 Hz Secondary: 12 V DC $\pm 3\%$, 2.5 A (with electronic overload protection)
Cable for AC adapter:	3-core, with country-specific plug
Balance power supply:	12 V DC $\pm 3\%$, 2.25 A, maximum ripple: 80 mVpp

Protection and standards

Overvoltage category:	II
Degree of pollution:	2
Standards for safety and EMC:	See Declaration of Conformity
Range of application:	For use only in closed interior rooms

Environmental conditions

Height above mean sea level:	Up to 4000 m
Ambient temperature:	5–40 °C
Relative air humidity:	Max. 80% up to 31 °C, linearly decreasing to 50% at 40 °C, noncondensing
Warm-up time:	24 hours after connecting the balance to the power supply; when switched on from standby-mode, the balance is ready for operation immediately.

Materials

Housing:	Die-cast aluminum, plastic, chrome steel and glass
Terminal:	Die-cast zinc, chromed and plastics
Weighing pan:	Aluminum, chromed (AlMgSi1 coated chem Ni 15 μm , Cr 0.3 – 0.5 μm)

7.2 Explanatory notes for the METTLER TOLEDO AC adapter

The certified external power supply which conforms to the requirements for Class II double insulated equipment is not provided with a protective earth connection but with a functional earth connection for EMC purposes. This earth connection IS NOT a safety feature. Further information about conformance of our products can be found in the brochure "Declaration of Conformity" which is coming with each product.

In case of testing with regard to the European Directive 2001/95/EC the power supply and the balance have to be handled as Class II double insulated equipment.

Consequently an earth bonding test is not required. Similarly it is not necessary to carry out an earth bonding test between the supply earth conductor and any exposed metalwork on the balance.

Because the balance are sensitive to static charges a leakage resistor, typically 10 k Ω , is connected between the earth connector and the power supply output terminals. The arrangement is shown in the equivalent circuit diagram. This resistor is not part of the electrical safety arrangement and does not require testing at regular intervals.

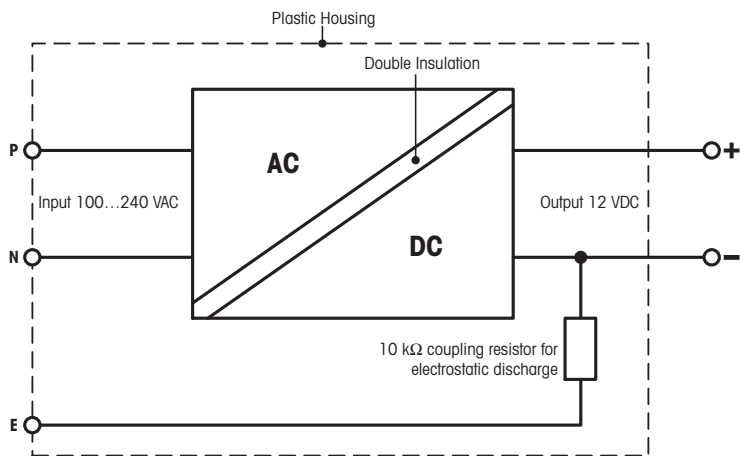

Equivalent circuit diagram

7.3 Model-specific data

		XP2U	XP6U
Limit values			
Maximum capacity		2.1 g	6.1 g
Readability		0.0001 mg	0.0001 mg
Tare range (from...to)		0 ... 2.1 g	0 ... 6.1 g
Repeatability (at nominal load)	sd	0.00025 mg (2 g)	0.0004 mg (5 g)
Repeatability (at low load)	sd	0.0002 mg (0.2 g)	0.00025 mg (0.2 g)
Linearity deviation		0.0015 mg	0.004 mg
Eccentricity deviation (test load) ¹⁾		0.0025 mg (1 g)	0.002 mg (2 g)
Sensitivity offset (test weight)		0.03 mg (2 g)	0.048 mg (6 g)
Sensitivity temperature drift ²⁾		0.0001%/°C	0.0001%/°C
Sensitivity stability ³⁾		0.0001%/a	0.0001%/a
Typical values			
Repeatability (at low load)	sd	0.00015 mg	0.00015 mg
Linearity deviation		0.0008 mg	0.0019 mg
Eccentric deviation (test load) ¹⁾		0.0016 mg (1 g)	0.0012 mg (2 g)
Sensitivity offset (test weight)		0.012 mg (2 g)	0.018 mg (6 g)
Minimum weight (according to USP)		0.3 mg	0.3 mg
Minimum weight (U=1%, k=2)		0.03 mg	0.03 mg
Settling time		10 s	15 s
Dimensions			
Balance dimensions (W × D × H)		128 × 287 × 113 mm	128 × 287 × 113 mm
Weighing pan dimensions		∅ 16 mm	∅ 16 mm
Typical uncertainties and supplementary data			
Repeatability	sd	0.00015 mg + 0.0000025%·Rgr	0.00015 mg + 0.0000025%·Rgr
Differential linearity deviation	sd	√(0.08pg·Rnt)	√(0.15pg·Rnt)
Differential eccentric load deviation	sd	0.00008%·Rnt	0.00003%·Rnt
Sensitivity offset	sd	0.0003%·Rnt	0.00015%·Rnt
Minimum weight (according to USP)		0.3 mg + 0.005%·Rgr	0.3 mg + 0.005%·Rgr
Minimum weight (U=1%, k=2)		0.03 mg + 0.0005%·Rgr	0.03 mg + 0.0005%·Rgr
Interface update rate		23 /s	23 /s
Usable height of draft shield		55 mm	55 mm
Weight of balance		7.5 kg	7.5 kg
Number of built-in reference weights		2	2
Weights for routine testing			
OIML CarePac		2 g E2, 0.1 g E2	5 g E2, 0.2 g E2
	Weights	#11123004	#11123005
ASTM CarePac		2 g 1, 0.1 g 1	5 g 1, 0.2 g 1
	Weights	#11123104	#11123105

sd = Standard deviation

Rnt = Net weight (sample weight)

Rgr = Gross weight

a = Year (annum)

1) Valid for compact objects

2) After adjustment with built-in reference weight

3) After putting into operation for the first time, with the self-adjustment function activated (ProFACT or FACT)

		XP6	XS3DU
Limit values			
Maximum capacity		6.1 g	3.1 g
Readability		0.001 mg	0.01 mg
Tare range (from...to)		0 ... 6.1 g	0 ... 3.1 g
Maximum capacity, fine range		–	0.8 g
Readability, fine range		–	0.001 mg
Repeatability (at nominal load)	sd	0.0008 mg (5 g)	0.006 mg (3 g)
Repeatability (at low load)	sd	0.0006 mg (0.2 g)	0.005 mg (0.2 g)
Repeatability, fine range (at low load)	sd	–	0.0008 mg (0.2 g)
Linearity deviation		0.004 mg	0.01 mg
Eccentricity deviation (test load) ¹⁾		0.003 mg (2 g)	0.004 mg (1 g)
Sensitivity offset (test weight)		0.048 mg (6 g)	0.045 mg (3 g)
Sensitivity temperature drift ²⁾		0.0001%/°C	0.0001%/°C
Sensitivity stability ³⁾		0.0001%/a	0.0001%/a
Typical values			
Repeatability (at low load)	sd	0.0004 mg	0.003 mg
Repeatability, fine range	sd	–	0.0005 mg
Linearity deviation		0.0019 mg	0.0038 mg
Eccentric deviation (test load) ¹⁾		0.002 mg (2 g)	0.0024 mg (1 g)
Sensitivity offset (test weight)		0.018 mg (6 g)	0.018 mg (3 g)
Minimum weight (according to USP)		0.8 mg	6 mg
Minimum weight (according to USP), fine range		–	1 mg
Minimum weight (U=1%, k=2)		0.08 mg	0.6 mg
Minimum weight (U=1%, k=2), fine range		–	0.1 mg
Settling time		7 s	6 s
Settling time, fine range		–	10 s
Dimensions			
Balance dimensions (W × D × H)		128 × 287 × 113 mm	128 × 287 × 113 mm
Weighing pan dimensions		∅ 27 mm	∅ 27 mm
Typical uncertainties and supplementary data			
Repeatability	sd	0.0004 mg + 0.000003%·Rgr	0.003 mg + 0.00006%·Rgr
Repeatability, fine range	sd	–	0.0005 mg + 0.000012%·Rgr
Differential linearity deviation	sd	√(0.15pg·Rnt)	√(1.2pg·Rnt)
Differential eccentric load deviation	sd	0.00005%·Rnt	0.00012%·Rnt
Sensitivity offset	sd	0.00015%·Rnt	0.0003%·Rnt
Minimum weight (according to USP)		0.8 mg + 0.006%·Rgr	6 mg + 0.12%·Rgr
Minimum weight (according to USP), fine range		–	1 mg + 0.024%·Rgr
Minimum weight (U=1%, k=2)		0.08 mg + 0.0006%·Rgr	0.6 mg + 0.012%·Rgr
Minimum weight (U=1%, k=2), fine range		–	0.1 mg + 0.0024%·Rgr
Interface update rate		23 /s	23 /s
Usable height of draft shield		55 mm	55 mm
Weight of balance		7.5 kg	7 kg
Number of built-in reference weights		2	2
Weights for routine testing			
OIML CarePac		5 g E2, 0.2 g E2	2 g E2, 0.1 g E2
	Weights	#11123005	#11123004
ASTM CarePac		5 g 1, 0.2 g 1	2 g 1, 0.1 g 1
	Weights	#11123105	#11123104

sd = Standard deviation

Rnt = Net weight (sample weight)

Rgr = Gross weight

a = Year (annum)

1) Valid for compact objects

2) After adjustment with built-in reference weight

3) After putting into operation for the first time, with the self-adjustment function activated (ProFACT or FACT)

7.4 Dimensions

7.4.1 Dimensions of the terminal and control unit of XP models

Dimensions in mm.

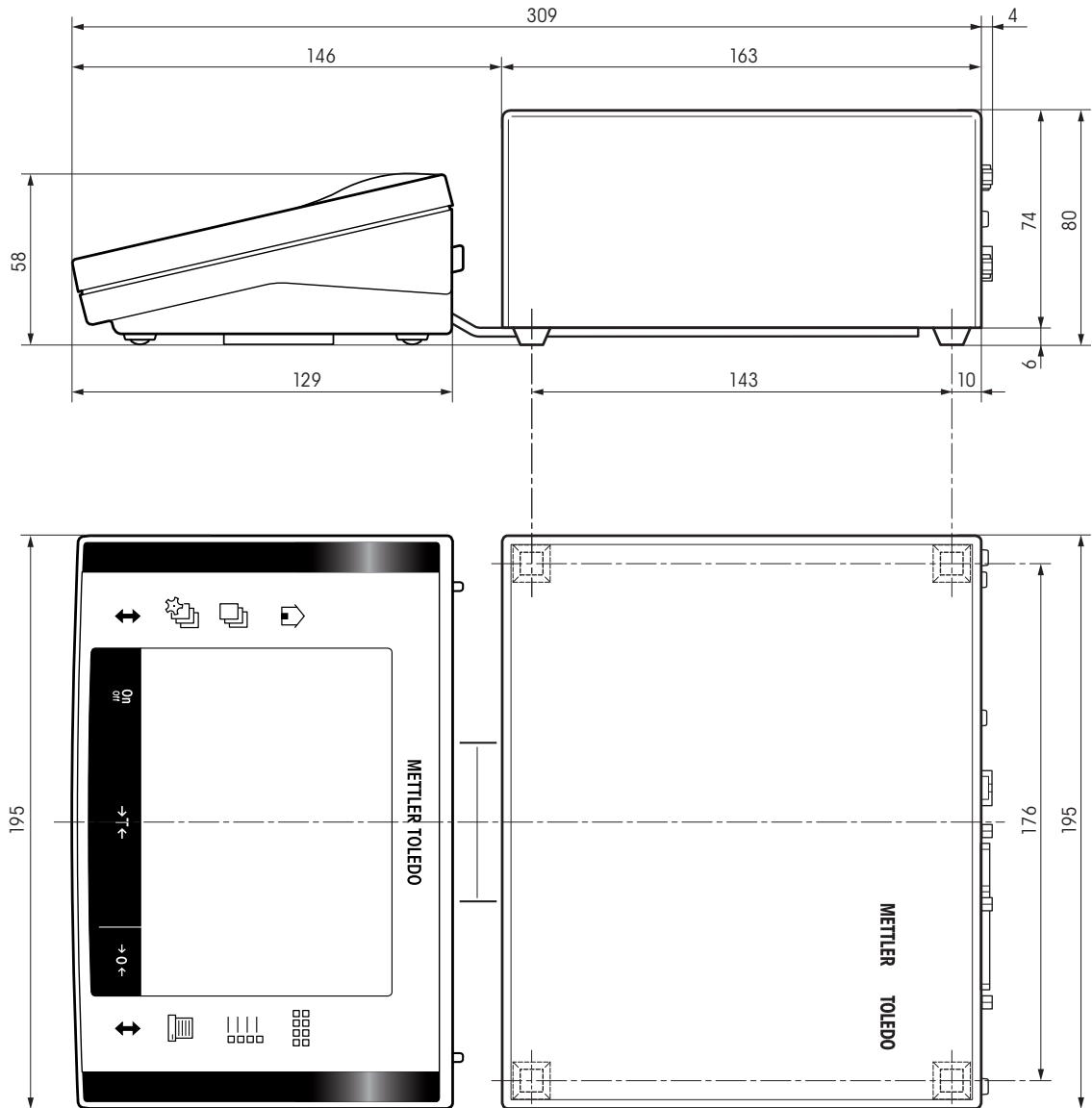

Terminal and Control Unit of XP Models

7.4.2 Dimensions of the terminal and control unit of XS models

Dimensions in millimeters.

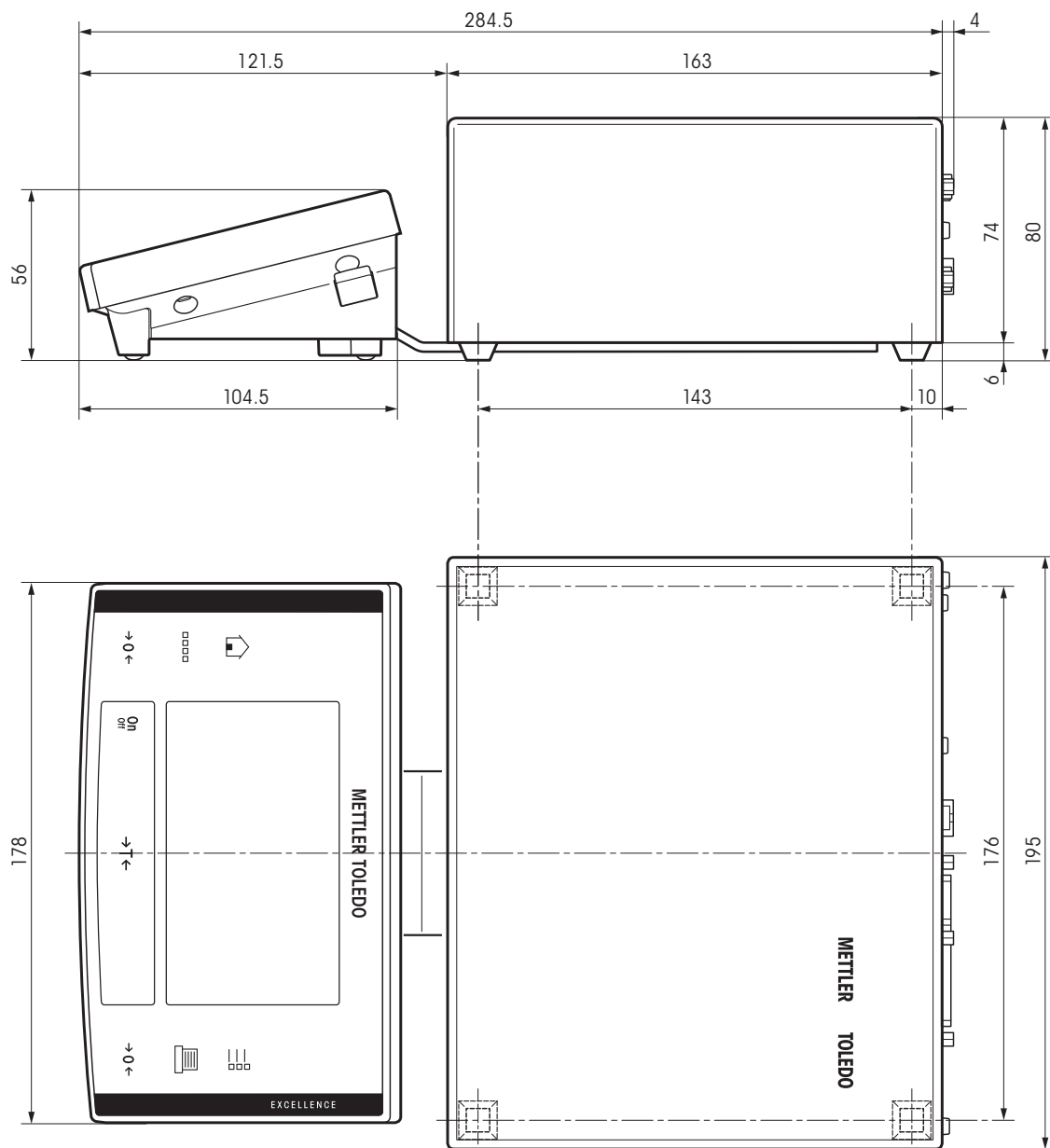

Terminal and Control Unit of XS Models

7.4.3 Dimensions of the weighing cell (XS and XP models)

Dimensions in millimeters.

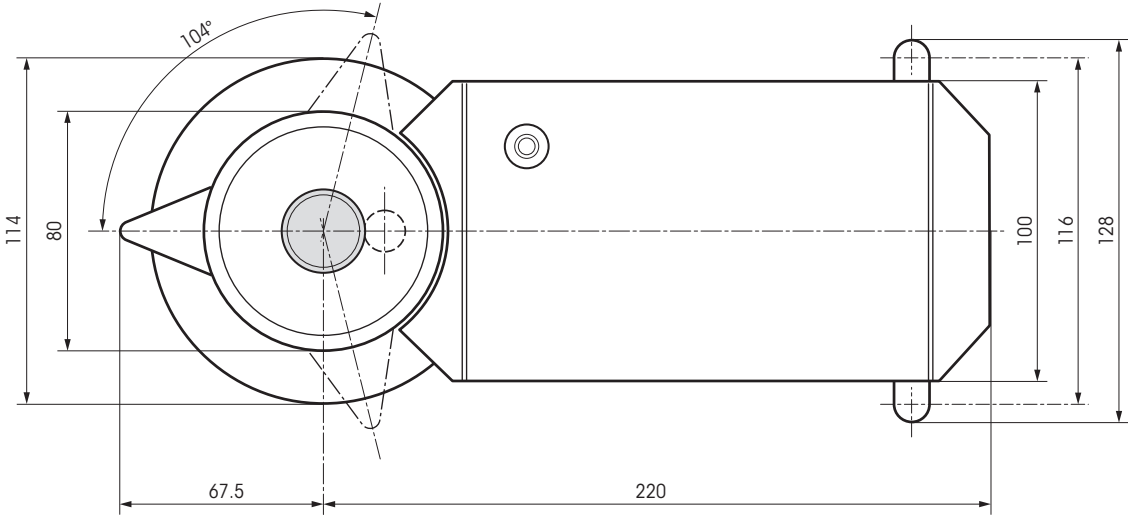
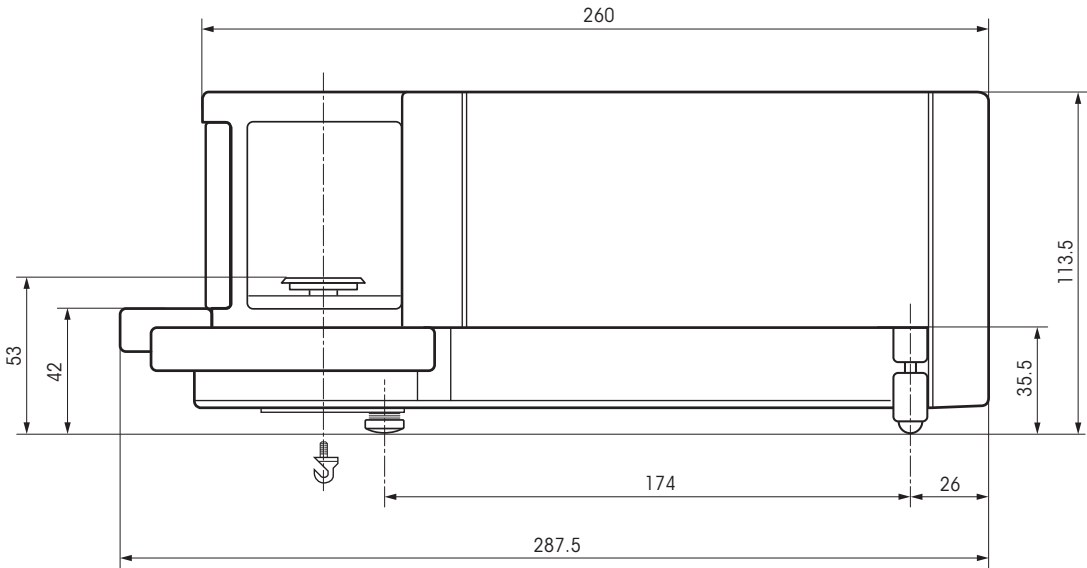

Weighing Cell XP and XS Models

7.5 Interfaces

7.5.1 Specifications of RS232C

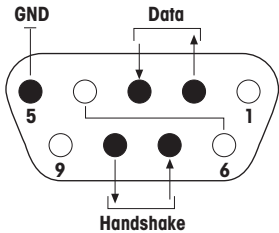
Interface type:	Voltage interface according to EIA RS-232C/DIN 66020 (CCITT V24/V.28)	
Max. cable length:	15 m	
Signal level:	Outputs: +5 V ... +15 V (RL = 3 – 7 kΩ) –5 V ... –15 V (RL = 3 – 7 kΩ)	Inputs: +3 V ... 25 V –3 V ... 25 V
Connector:	Sub-D, 9-pole, female	
Operating mode:	Full duplex	
Transmission mode:	Bit-serial, asynchronous	
Transmission code:	ASCII	
Baud rates:	600, 1200, 2400, 4800, 9600, 19200, 38400 ¹⁾ (firmware selectable)	
Bits/parity:	7-bit/even, 7-bit/odd, 7-bit/none, 8-bit/none (firmware selectable)	
Stop bits:	1 stop bit	
Handshake:	None, XON/XOFF, RTS/CTS (firmware selectable)	
End-of-line:	<CR><LF>, <CR>, <LF> (firmware selectable)	
	Pin 2: Balance transmit line (TxD) Pin 3: Balance receive line (RxD) Pin 5: Ground signal (GND) Pin 7: Clear to send (hardware handshake) (CTS) Pin 8: Request to send (hardware handshake) (RTS)	

¹⁾ 38400 baud is only possible in special cases, such as:

- Weighing platform without terminal, or
- Weighing platform with terminal, only via the optional RS232C interface.

7.5.2 Specifications of "Aux" connection

You can connect the METTLER TOLEDO "ErgoSens" or an external switch to sockets "Aux 1" and "Aux 2". This allows you to start functions such as taring, zeroing, printing and others.

External connection

Connector: 3.5 mm stereo jack connector

Electrical data: Max. voltage 12 V

Max. current 150 mA

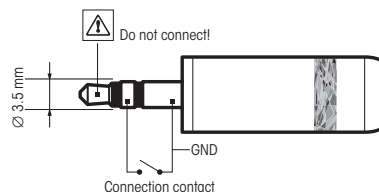

8 Accessories and Spare Parts

8.1 Accessories

You can increase the functionality of your balance with accessories from the METTLER TOLEDO range. The following options are available:

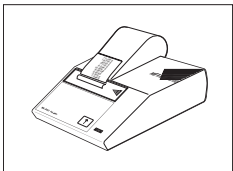
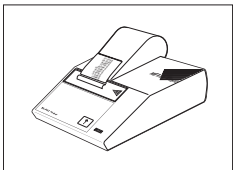
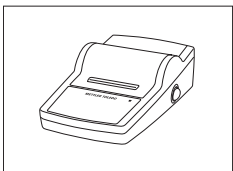
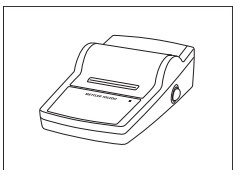
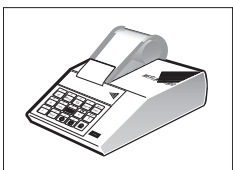
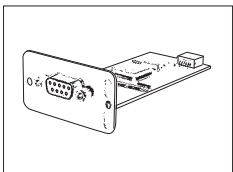
	Description	Part No.
Printers		
	BT-P42 printer with Bluetooth connection to instrument	11132540
	Paper roll, set of 5 pcs	00072456
	Paper roll, self-adhesive, set of 3 pcs	11600388
	Ribbon cartridge, black, set of 2 pcs	00065975
	RS-P42 printer with RS232C connection to instrument	00229265
	Paper roll, set of 5 pcs	00072456
	Paper roll, self-adhesive, set of 3 pcs	11600388
	Ribbon cartridge, black, set of 2 pcs	00065975
	RS-P25 printer with RS232C connection to instrument	11124300
	Paper roll, set of 5 pcs	00072456
	Paper roll, self-adhesive, set of 3 pcs	11600388
	Ribbon cartridge, black, set of 2 pcs	00065975
	RS-P26 printer with RS232C connection to instrument (with date and time)	11124303
	Paper roll, set of 5 pcs	00072456
	Paper roll, self-adhesive, set of 3 pcs	11600388
	Ribbon cartridge, black, set of 2 pcs	00065975
	LC-P45 application printer with additional functions	00229119
	Paper roll, set of 5 pcs	00072456
	Paper roll, self-adhesive, set of 3 pcs	11600388
	Ribbon cartridge, black, set of 2 pcs	00065975
Optional interfaces		
	Second RS232C Interface	11132500

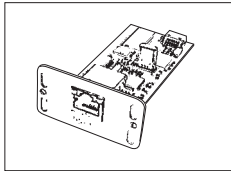

Ethernet Interface for connection to an Ethernet network

11132515



BT option: Bluetooth Interface for multipoint connection for up to 6 Bluetooth devices

11132530



BTS option: Bluetooth Interface, single-point connection

11132535



PS/2 option: Interface for connecting commercial keyboards and barcode readers

11132520

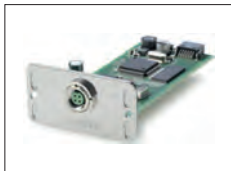

LocalCAN option: Interface for connection of up to 5 LC (LocalCAN) instruments

11132505



MiniMettler option: Interface MiniMettler, for connection to older (legacy) METTLER TOLEDO systems

11132510

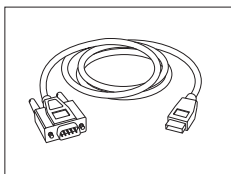

RS232 - USB converter cable – Cable with converter to connect a balance (RS232) to a USB port

64088427

Cables for RS232C interface

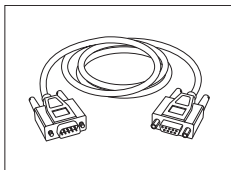

RS9 – RS9 (m/f): connection cable for PC, length = 1 m

11101051

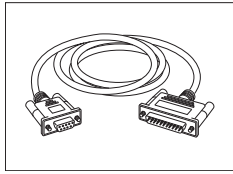

RS9 – RS25 (m/f): connection cable for PC, length = 2 m

11101052

Cables for LocalCAN interface

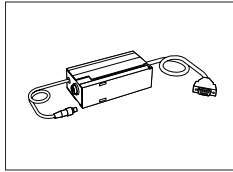

LC – RS9: Cable for connecting a PC with RS232C, 9-pin (f), length = 2 m

00229065

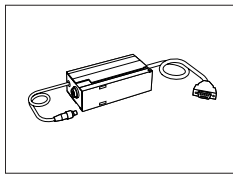

LC – RS25: Cable for connecting a printer or PC with RS232C, 25-pin (m/f), length = 2 m

00229050



LC – CL: Cable for connecting a device with METTLER TOLEDO CL interface (5-pin), length = 2 m

00229130



LC – LC2: Extension cable for LocalCAN, length = 2 m

00229115



LC – LC5: Extension cable for LocalCAN, length = 5 m

00229116



LC – LCT: Cable branch (T-connector) for LocalCAN

00229118

Cables for MiniMettler interface

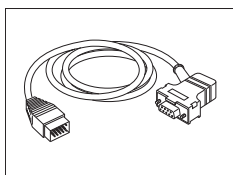

MM – RS9f: RS232C connection cable to MiniMettler interface, length = 1.5 m

00229029

Cables for terminal

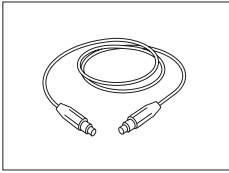

Terminal extension cable, length = 4.5 m

11600517

Auxiliary displays

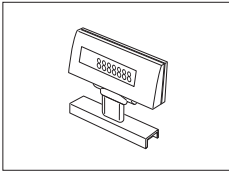

LC/RS-BLD auxiliary display on bench stand, backlit (incl. RS cable and separate AC adapter)

00224200

Sensors

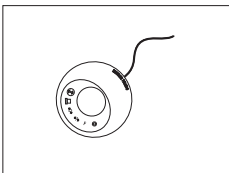

ErgoSens, optical sensor for hands-free operation

11132601

LC-Switchbox



For connection of up to 3 balances with LocalCAN interface to a printer

00229220

Footswitches

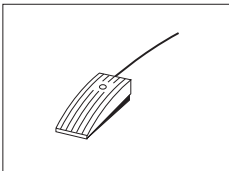

Footswitch with selectable function for balances (Aux 1, Aux 2)

11106741



LC-FS foot switch with selectable function for balances with LocalCAN interface

00229060

AntiStatic kit

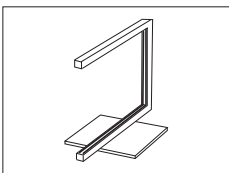

Universal AntiStatic Kit complete (U-shaped), including electrode and power supply

11107767

Optional: Second U-electrode* for universal AntiStatic Kit

11107764

* Power supply for optional, second U-elektrode (11107764)

11107766

Filter kit



Filter kit for XP/XS/MX/UMX balances ø 110 mm

00211227



Filter kit for XP/XS/MX/UMX balances ø 47 mm and ø 70 mm

11122136

Funnel kit



Funnel kit for XP/XS/UMX/MX balances

00211220

Barcode reader

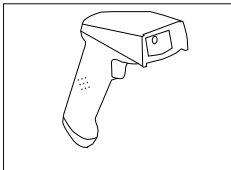

RS232C Barcode Reader

21901297

The following accessories are needed for operation (not included):

RS232 F cable 21901305

Null modem adapter 21900924

Plus one of the following:

AC adapter 5 V for EU 21901370

AC adapter 5 V for US 21901372

AC adapter 5 V for GB 21901371

AC adapter 5 V for AU 21901370

+ 71209966

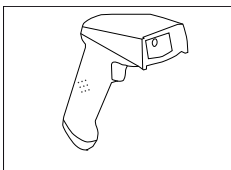

RS232C Barcode Reader – Cordless

21901299

The following accessories are needed for operation (not included):

Cradle 21901300

RS232 F cable 21901305

Null modem adapter 21900924

Plus one of the following:

AC adapter 12 V for EU 21901373

AC adapter 12 V for US 21901375

AC adapter 12 V for GB 21901374

AC adapter 12 V for AU 21901373

+ 71209966

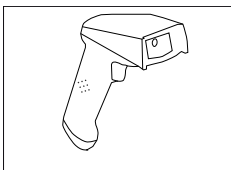

PS/2 Barcode Reader, without cable

21901297

PS/2 wedge single cable 21901307

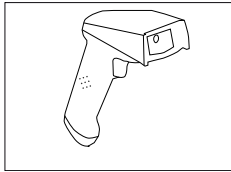

PS/2Y Barcode Reader, without cable

PS/2 wedge twin (Y) cable

21901297

21901308

Transport cases



Transport case for micro balances

11122760

Protective covers



Protective cover for XS terminal

11106870

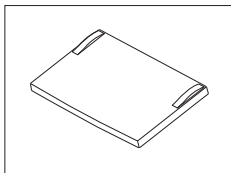

Protective cover for XP terminal

11132570

Dust covers

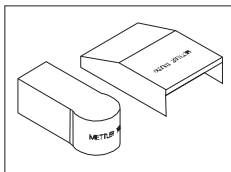

Dust cover

30038799

Software

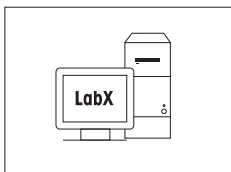

LabX software for one click™ weighing solutions

Enables you to perform One Click™ Standard Preparation, One Click™ Loss on Drying, One Click™ Sieve Analysis and many other applications.

Simply start the method with the One Click™ shortcut on the balance touchscreen. LabX guides you step-by-step through the SOP on the balance, performs your calculations automatically, and takes care of saving all your data. The complete solution can be tailored to match your process requirements. Visit www.mt.com/one-click-weighing for more information

on request

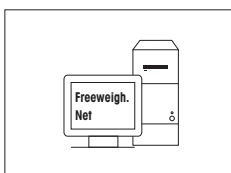

Freeweigh.Net

21900895

Various

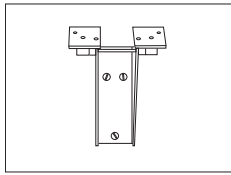

Wall fixture for terminal

11132665

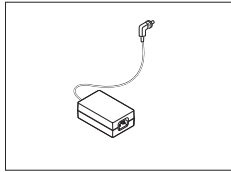

AC/DC adapter (without power cable) 100–240 V AC, 0.8 A, 50/60 Hz, 12 V DC 2.5 A

11107909

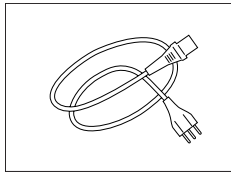

Country-specific 3-Pin power cable with grounding conductor.

Power cable AU

00088751

Power cable BR

30015268

Power cable CH

00087920

Power cable CN

30047293

Power cable DK

00087452

Power cable EU

00087925

Power cable GB

00089405

Power cable IL

00225297

Power cable IN

11600569

Power cable IT

00087457

Power cable JP

11107881

Power cable TH, PE

11107880

Power cable US

00088668

Power cable ZA

00089728

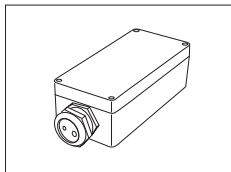

IP54 protective housing for AC adapter

11132550

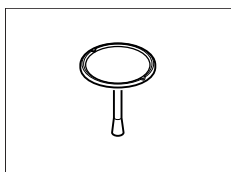

Weighing pan \varnothing 15.7 mm, chrome-nickel steel X5CrNi 18-10

11100437

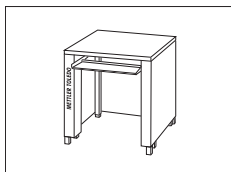

Weighing table

11138044

8.2 Spare parts

Weighing chamber

	Pos	Description	Part No.
	Glass cover for draft shield		
	1	Glass cover for XP6 and XS3DU	00211082
	1	Glass cover for XP2U and XP6U	00211177
	Weighing pan		
	2	Weighing pan for XP6 and XS3DU	00211055
	3	Weighing pan for XP2U and XP6U	00211197
	4	Hook weighing pan for XP2U and XP6U	00211295
	5	Draft disk complete	11100075
	6	Ring nut	11100341
	7	Weighing chamber plate	00211155
	Weighing chamber complete		
	8	Weighing chamber for XP6 and XS3DU	11100861
	8	Weighing chamber for XP2U and XP6U	11100862
	9	Sealing cover	00211122

Weighing cell

	Pos	Description	Part No.
	1	Cover	11122623
	2	Footscrew	11122612

Control unit

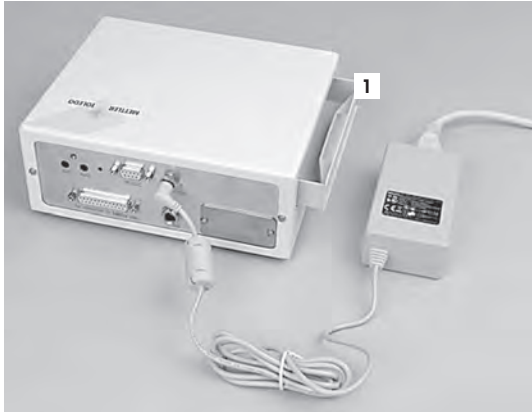
	Pos	Description	Part No.
	1	Drawer	00211163

Terminal Type "P" (color, for XP balances)

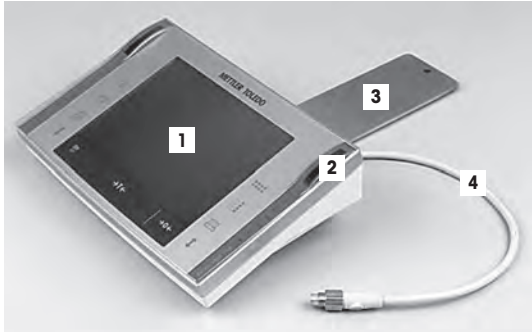
	Pos	Description	Part No.
	1	Terminal Type "P"	11130692
	2	Protective cover for Terminal Type "P"	11132570
	3	Terminal support for Terminal Type "P"	11122950
	4	Terminal cable	11122830

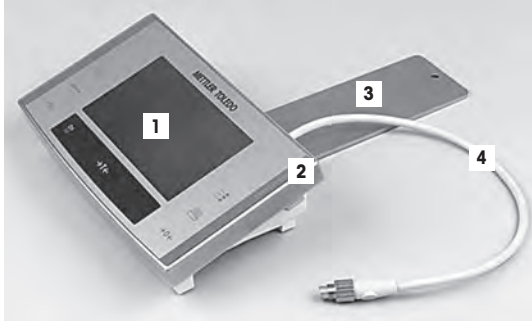

Terminal Type "S" (monochrome, for XS balances)

	Pos	Description	Part No.
	1	Terminal Type "S"	11107899
	2	Protective cover for Terminal Type "S"	11106870
	3	Terminal support for Terminal Type "S"	11122951
	4	Terminal cable	11122830

Small parts

	Pos	Description	Part No.
	1	Cleaning brush	00070114
	2	Cleaning tweezers	00211124
	3	Weighing tweezers	00070661

Transport

	Pos	Description	Part No.
		Packaging complete	11122953
		Export box	11122751

9 Appendix

9.1 MT-SICS interface commands and functions

Many of the instruments and balances used have to be capable of integration in a complex computer or data acquisition system.

To enable you to integrate balances in your system in a simple manner and utilize their capabilities to the full, most balance functions are also available as appropriate commands via the data interface.

All new METTLER TOLEDO balances launched on the market support the standardized command set "METTLER TOLEDO Standard Interface Command Set" (MT-SICS). The commands available depending on the functionality of the balance.

For further information please refer to the Reference Manual MT-SICS downloadable from the Internet under

► <http://www.mt.com/micro>

9.2 Procedure for certified balances

Preface

Certified balances are subject to the national, legal requirements of "non-automatic balances".

Switching on the balance

- **Switching on**
 - Immediately after being switched on, the balance displays 0.000.. g.
 - The balance is always started up with the "Factory setting" unit.
- **Switch-on range**
 - At maximum 20% of the type load, otherwise overload is displayed (OIML R76 4.5.1).
- **Stored value as switch-on zero point**
 - It is not permissible to use a stored value as a switch-on zero point; the MT-SICS M35 command is not available (OIML R76 T.5.2).

Display

- **Display of the weight value**
 - The "e" certification value is always shown in the display and is specified at the model designation plate (OIML R76 T.3.2.3 and 7.1.4).
 - If the display increment is lower than the "e" certification value, this is variably displayed for the net, gross and weighed tare. (Graying of the digits or certification brackets) (OIML R76 T.2.5.4 and 3.4.1).
- In accordance with guidelines, the tested display increment (certification value) is never lower than 1 mg (OIML R76 T.3.4.2).
- At balances with $d = 0.1$ mg, the digits below 1 mg are displayed in gray. These digits in brackets are printed. In accordance with legal metrology requirements, this illustration does not affect the accuracy of the weighing results.
- **Units of measurement**
 - The display and info unit are firmly set to g or mg (depending on the model).
 - The following applies for the "Custom unit":
 - No certification brackets.
 - The following names are blocked, this applies to upper and lower case letters.
 - All official units (g, kg, ct etc.).
 - c, ca, car, cm, crt, cart, kt, gr, gra, gram, grm, k, kilo, to, ton.
 - All names with "o" which can be replaced by a zero (Oz, Ozt etc.).

- **Identification of the weight display**

- Gross, net, tare and other weight values are accordingly marked (OIML R76 4.6.5).
 - Net for net when a tare value has been used.
 - B or G for gross.
 - T for the weighed tare.
 - PT for the specified tare.
 - * or diff for the difference between the net or gross.

- **Info field**

- The info weight value is handled metrologically in the same way as the weight value in the main display.

Printout (OIML R76 4.6.11)

- If a tare value is entered manually (PreTare), the PreTare value is always printed along with the net value (PT 123.45 g).
- The printed weight values are identified in the same way as the weight value on the display. I.e. N, B or G, T, PT, diff or *, with differentiation.

Example:

Single-range balance.

N	123.4[5] g
PT	10.00 g → for PreTare
G	133.4[5] g

DR balance with 100.00 g fine range.

N	80.4[0] g
T	22.5[6] g → for weighed tare
G	102.9[] g

Balance functions

- **Reset to zero**

- The zero range is limited to a maximum of $\pm 2\%$ of the full load (OIML R76 4.5.1).

- **Tare**

- No negative tare values are permitted.
- Tare immediate (TI) is not permitted, the MT-SICS TI command is not available (OIML R76 4.6.4).

- **1/xd**

- **e = d**

The 1/xd switchover is not permitted (OIML R76 3.1.2).

- **e = 10d**

This is only permitted in the case of the 1/10d switchover.

- **e = 100d**

Only the 1/10d and 1/100d switchover are permitted.

Index

A

AC adapter	14, 23, 23
Accessories	31
Assembling the balance	13
Aux connections	30

B

Balance functions	42
Below-the-balance weighing	17

C

Certified balances	41
Changing the reading angle	15
Cleaning	20
Connecting the balance	14
Connecting to power supply	14
Control unit	13, 39
Conventions	6

D

Dimensions	27
Display	41
Display field remains dark	14
Display of the weight value	41
Disposal	22

E

Environmental conditions	23
ErgoSens	30

F

Features	5
----------	---

G

General safety information	7
Glass draft shield	14
GLP	5
Good Laboratory Practice	5

H

Hook weighing pan	13
-------------------	----

I

Identification of the weight display	42
Info field	42
Interface	
MT-SICS	41
ISO 14001	5
ISO 9001	5

L

Leveling	18
Leveling aid	18
Leveling Assistant	19
Local conditions	12
Location	12

M

Materials	23
MT-SICS	41

P

Power cord	13
Power supply	23
Power supply voltage	13
Printout	42
Protection and standards	23

R

Remove terminal	15
Reset to zero	42
RS232C interface	30

S

Safety information	7, 7
Staff safety	7
Scope of delivery	12
Self-test	14
Setting up	11
Shipping lock	12, 17
Spare parts	38
Staff safety	7
Switching off	18
Switching on	18

T

Tare	42
Technical data	23
Terminal	39
Transport	40
Transporting over long distances	16
Transporting over short distances	16
Transporting the balance	16

U

Units of measurement	41
----------------------	----

W

Weighing cell	13, 38
Weighing chamber	38

GWP® – Good Weighing Practice™

The global weighing guideline GWP® reduces risks associated with your weighing processes and helps to

- choose the appropriate balance
- reduce costs by optimizing testing procedures
- comply with the most common regulatory requirements

► www.mt.com/GWP

www.mt.com/excellence

For more information

Mettler-Toledo AG, Laboratory Weighing

CH-8606 Greifensee, Switzerland

Tel. +41 (0)44 944 22 11

Fax +41 (0)44 944 30 60

www.mt.com

Subject to technical changes.

© Mettler-Toledo AG 11/2013

11781193D en

