

# Operating instructions

## HR73 and HG53 Moisture Analyzers

## HR73-P and HG53-P Moisture Analyzers

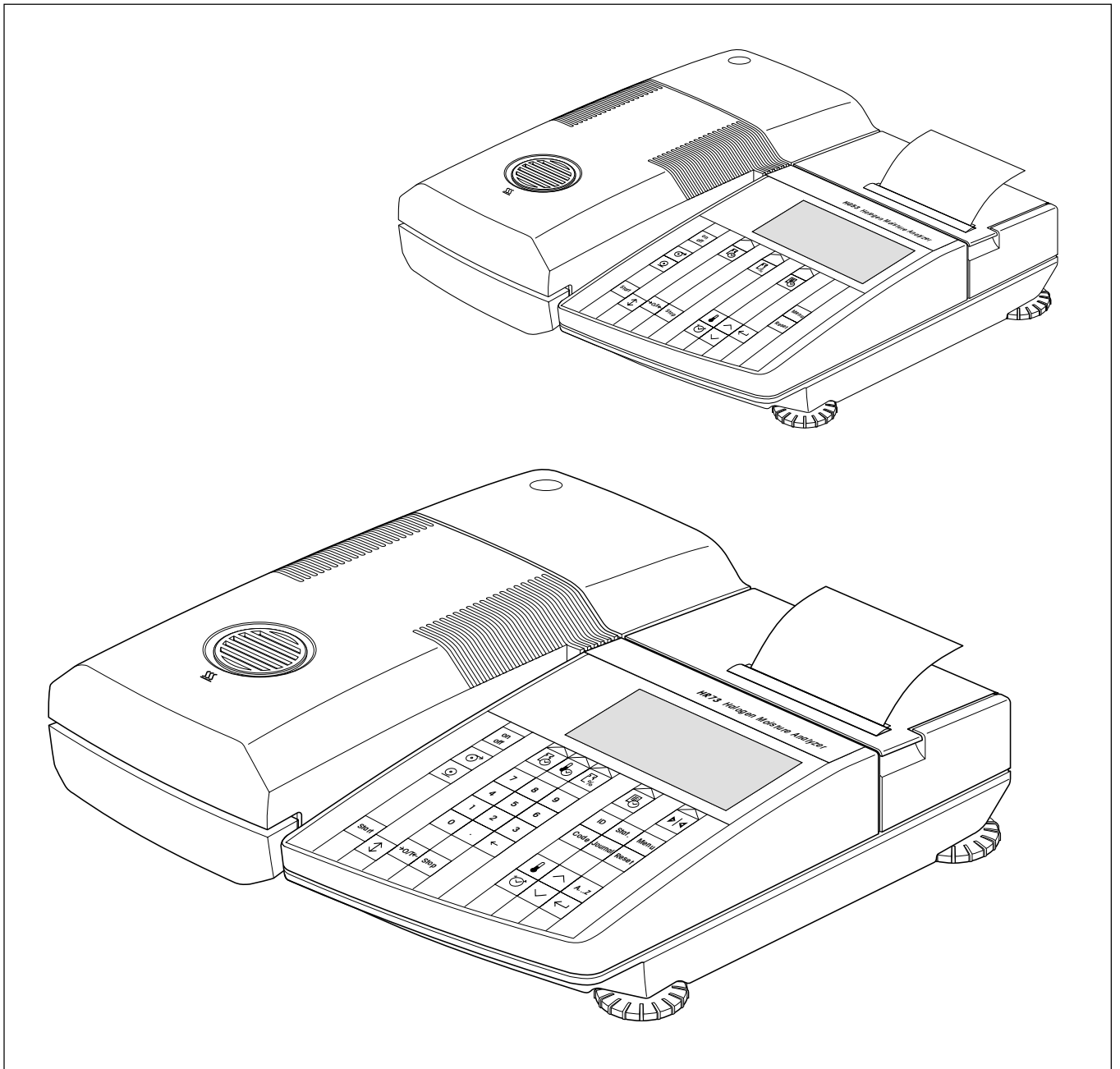

# Overview of your HR73 Halogen Moisture Analyzer

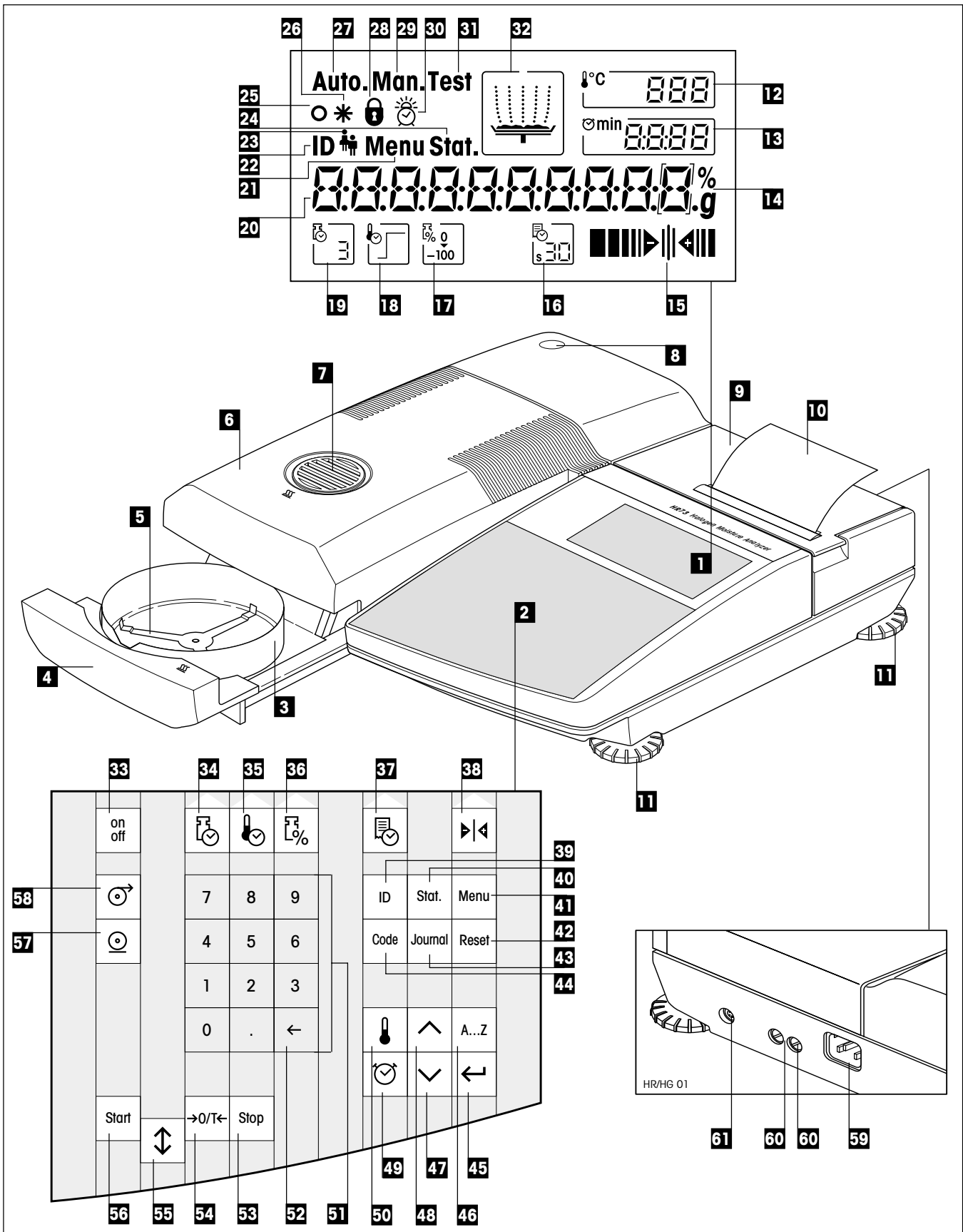

## Display, controls and connections of your HR73

No.	Designation	Info s. section
<b>1</b>	Display	all
<b>2</b>	Keypad	all
<b>3</b>	Draft shield	2.3
<b>4</b>	Automatic sample chamber	2.6
<b>5</b>	Sample pan holder	2.3
<b>6</b>	Dryer unit	7.6
<b>7</b>	Inspection window and vent	6.3
<b>8</b>	Level indicator (level)	2.3
<b>9</b>	Printer cover	7.2
<b>10</b>	Built-in printer (option)	7.5
<b>11</b>	Leveling screw	2.3
<b>12</b>	Display of drying temperature	4.3
<b>13</b>	Display of drying time	4.4
<b>14</b>	Display of unit (percent or grams)	4.5
<b>15</b>	Weighing-in aid	4.7/6.13
<b>16</b>	Function display "Print interval"	4.6
<b>17</b>	Function display "Display mode"	4.5
<b>18</b>	Function display "Drying program"	4.2
<b>19</b>	Function display "Switch-off criterion"	4.4
<b>20</b>	Dialog display (measured values, menu dialog, text entry, etc.)	all
<b>21</b>	Menu symbol	6
<b>22</b>	Method symbol	5
<b>23</b>	Symbol for record comment	4.9
<b>24</b>	Statistics symbol	5.6
<b>25</b>	Stability detector	8.2/8.3
<b>26</b>	Symbol for calculated result	5.5
<b>27</b>	Symbol for automatic operating mode of the automatic sample chamber	6.9
<b>28</b>	Symbol for keypad locking (parameter reset protection)	6.11
<b>29</b>	Symbol for manual operating mode of the automatic sample chamber	6.9
<b>30</b>	Symbol for audio signal device (beeper)	6.10

No.	Designation	Info s. section
<b>31</b>	Symbol for test measurement	4.4
<b>32</b>	Status display (user guide)	2.6
<b>33</b>	Key «on/off»	2.6
<b>34</b>	Function key «Switch-off criterion»	4.4
<b>35</b>	Function key «Drying program»	4.2
<b>36</b>	Function key «Display mode»	4.5
<b>37</b>	Function key «Print interval»	4.6
<b>38</b>	Key «Target weight» (weighing-in aid)	4.7/6.13
<b>39</b>	Key «ID» (method selection)	5.2
<b>40</b>	Key «Stat.» (statistics)	5.6
<b>41</b>	Key «Menu»	6
<b>42</b>	Key «Reset»	2.6
<b>43</b>	Key «Journal»	5.5
<b>44</b>	Key «Code» (record comment)	4.9
<b>45</b>	Key «Accept entry»	all
<b>46</b>	Key «A...Z» (alphanumeric entry)	4.9/5.3
<b>47</b>	Key «Scroll down»	2.5
<b>48</b>	Key «Scroll up»	2.5
<b>49</b>	Key «Drying time»	4.4
<b>50</b>	Key «Drying temperature»	4.3
<b>51</b>	Numeric keypad	4.1
<b>52</b>	Key «Delete»	4.1
<b>53</b>	Key «Stop» (stop drying)	4.8/4.9
<b>54</b>	Key «Tare» (zero)	2.6
<b>55</b>	Key «Open/close auto sample chamber»	2.6
<b>56</b>	Key «Start» (start of drying)	2.6
<b>57</b>	Key «Print»	4.8/6.1
<b>58</b>	Key «Paper feed»	4.8
<b>59</b>	Power supply receptacle	2.3
<b>60</b>	Power line fuses	7.3
<b>61</b>	LocalCAN universal interface port	9.2

# Overview of your HG53 Halogen Moisture Analyzer

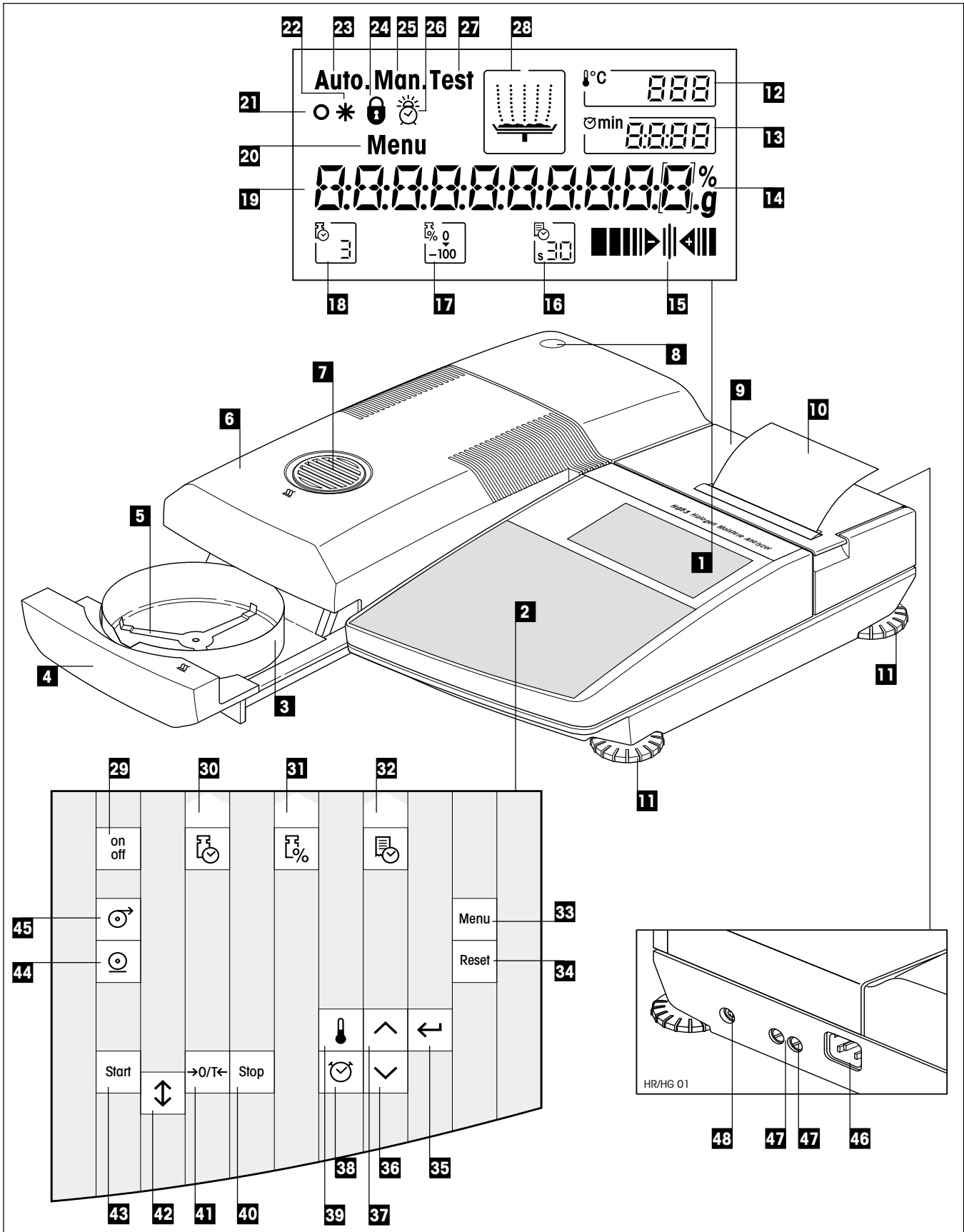

# Display, controls and connections of your HG53

No.	Designation	Info s. section
<b>1</b>	Display	all
<b>2</b>	Keypad	all
<b>3</b>	Draft shield	2.3
<b>4</b>	Automatic sample chamber	2.6
<b>5</b>	Sample pan holder	2.3
<b>6</b>	Dryer unit	7.6
<b>7</b>	Inspection window and vent	6.3
<b>8</b>	Level indicator (level)	2.3
<b>9</b>	Printer cover	7.2
<b>10</b>	Built-in printer (option)	7.5
<b>11</b>	Leveling screw	2.3
<b>12</b>	Display of drying temperature	4.3
<b>13</b>	Display of drying time	4.4
<b>14</b>	Display of unit (percent or grams)	4.5
<b>15</b>	Weighing-in aid	4.7/6.13
<b>16</b>	Function display "Print interval"	4.6
<b>17</b>	Function display "Display mode"	4.5
<b>18</b>	Function display "Switch-off criterion"	4.4
<b>19</b>	Dialog display (measured values, menu, dialog, text entry, etc.)	all
<b>20</b>	Menu symbol	6
<b>21</b>	Stability detector	8.3
<b>22</b>	Symbol for calculated result	5.5
<b>23</b>	Symbol for automatic operating mode of the automatic sample chamber	6.9
<b>24</b>	Symbol for keypad locking (parameter reset protection)	6.11
<b>25</b>	Symbol for manual operating mode of the automatic sample chamber	6.9
<b>26</b>	Symbol for audio signal device (beeper)	6.10
<b>27</b>	Symbol for test measurement	4.4
<b>28</b>	Status display (user guide)	2.6

No.	Designation	Info s. section
<b>29</b>	Key «on/off»	2.6
<b>30</b>	Function key «Switch-off criterion»	4.4
<b>31</b>	Function key «Display mode»	4.5
<b>32</b>	Function key «Print interval»	4.6
<b>33</b>	Key «Menu»	6
<b>34</b>	Key «Reset»	2.6
<b>35</b>	Key «Accept entry»	all
<b>36</b>	Key «Scroll down»	2.5
<b>37</b>	Key «Scroll up»	2.5
<b>38</b>	Key «Drying time»	4.4
<b>39</b>	Key «Drying temperature»	4.3
<b>40</b>	Key «Stop» (stop drying)	4.8/4.9
<b>41</b>	Key «Tare» (zero)	2.6
<b>42</b>	Key «Open/close auto sample chamber»	2.6
<b>43</b>	Key «Start» (start of drying)	2.6
<b>44</b>	Key «Print»	4.8
<b>45</b>	Key «Paper feed»	4.8
<b>46</b>	Power supply receptacle	2.3
<b>47</b>	Power line fuses	7.3
<b>48</b>	LocalCAN universal interface port	9.2

# Contents

<b>1.</b>	<b>Getting to know your Moisture Analyzer</b> .....	<b>8</b>
1.1	Introduction .....	8
1.2	What is the Halogen Moisture Analyzer used for? .....	8
1.3	Safety has priority .....	10
1.4	Important information for these instructions .....	12
<b>2.</b>	<b>Your first measurement in next to no time</b> .....	<b>13</b>
2.1	Unpacking and checking the standard equipment .....	13
2.2	Selecting the location .....	14
2.3	Setting up, leveling and connecting to power supply .....	14
2.4	Preparing the printer .....	18
2.5	Setting the date and time .....	20
2.6	Your first measurement .....	22
<b>3.</b>	<b>How to obtain the best results</b> .....	<b>26</b>
3.1	Measurement principle of the Halogen Moisture Analyzer .....	26
3.2	Notes on adjustment of the balance and the dryer unit .....	27
3.3	Optimum sample preparation .....	27
3.4	Further information on moisture determination .....	28
<b>4.</b>	<b>Practical application of your Moisture Analyzer</b> .....	<b>29</b>
4.1	The operating concept .....	29
4.2	Selecting the drying program .....	30
4.3	Setting the drying temperature .....	32
4.4	Selecting the switch-off criterion and performing a test measurement .....	36
4.5	Selecting the display mode .....	39
4.6	Defining the print interval .....	41
4.7	Working with the weighing-in aid .....	42
4.8	Performing a measurement .....	44
4.9	Information on the measurement record .....	47
<b>5.</b>	<b>Methods facilitate your work</b> .....	<b>51</b>
5.1	What is a method? .....	51
5.2	Recalling a method .....	52
5.3	Naming, compiling or changing methods .....	52
5.4	Printing out methods .....	55
5.5	Measured value journal .....	56
5.6	Measured value statistics .....	58
<b>6.</b>	<b>The menu (basic settings of the instrument)</b> .....	<b>60</b>
6.1	Menu operation .....	60
6.2	Adjusting the balance .....	61
6.3	Adjusting the dryer unit .....	63

---

6.4	Resetting to the factory settings .....	65
6.5	Clearing the method memory .....	66
6.6	Setting the time .....	67
6.7	Entering the date .....	67
6.8	Setting the vibration adapter .....	67
6.9	Selecting operating mode of the automatic sample chamber .....	68
6.10	Audio signal .....	68
6.11	Protecting your settings against change .....	69
6.12	Superimposing or removing the function symbols .....	69
6.13	Switching the weighing-in aid on or off .....	70
6.14	Switching the printer on or off .....	71
6.15	Entering company name for printed records .....	71
6.16	Selecting the type of record .....	72
6.17	Defining the free switch-off criteria .....	74
6.18	Defining the free print interval .....	75
6.19	Switching the method option on or off .....	75
6.20	Selecting the dialog language .....	76
6.21	Menu overview HR73 .....	77
6.22	Menu overview HG53 .....	78
<b>7.</b>	<b>Servicing and replacing individual parts .....</b>	<b>79</b>
7.1	Cleaning .....	79
7.2	Changing the printer paper and ribbon .....	81
7.3	Replacing the power line fuses .....	83
7.4	Printer test .....	83
7.5	Installing the built-in printer .....	83
7.6	Dismantling and replacing the dryer unit .....	84
<b>8.</b>	<b>If problems arise on occasion .....</b>	<b>85</b>
8.1	Notes on the error messages .....	85
8.2	Meaning of the error messages .....	86
8.3	What if...? .....	88
<b>9.</b>	<b>Further useful information .....</b>	<b>91</b>
9.1	Notes on interpretation of the measurement results and the ideal sample weight .....	91
9.2	LocalCAN universal interface .....	91
9.3	Application brochure .....	92
9.4	Switch-off criterion "Weight loss per unit of time" .....	92
9.5	Comments on certified version .....	94
9.6	Technical data .....	95
9.7	Optional equipment, expendable material and spare parts .....	97
<b>10.</b>	<b>Index .....</b>	<b>98</b>

# 1. Getting to know your Moisture Analyzer

Please read through this section carefully, it contains important information for safe and economical operation of your Moisture Analyzer.

Text marked in grey in these operating instructions applies only to the HR73.

## 1.1 Introduction

Thank you for deciding to purchase a Halogen Moisture Analyzer from METTLER TOLEDO – you have made a wise choice. Thanks to revolutionary technology, your Moisture Analyzer operates quickly and dependably. It offers a high level of operating convenience and useful functions to facilitate determination of the moisture content of your samples.

Behind your instrument stands METTLER TOLEDO, a leading manufacturer of not only balances and scales for the lab and production, but also analytical measuring instruments. A customer service network covering the entire globe with well trained personnel is at your service at all times, whether you are choosing accessories or require guidance for a specific application to ensure optimum utilization of your instrument.

To ensure you make full use of the possibilities offered by your Moisture Analyzer, we advise you to read through these operating instructions very carefully.

## 1.2 What is the Halogen Moisture Analyzer used for?

Your Halogen Moisture Analyzer can be used to determine the moisture content of virtually any substance in practice are the sample heating rate and uniform heating of its surface. The instrument operates on the thermogravimetric principle: At the start of the measurement the Moisture Analyzer determines the weight of the sample, the sample is then quickly heated by the integral halogen dryer unit and the moisture vaporizes. During the drying operation, the instrument continuously determines the weight of the sample and displays the loss of moisture. On completion of drying, the moisture content or dry substance content of your sample is displayed as the final result.

Of decisive importance in practice is the rate of heating. In comparison with conventional infrared heating or the drying oven method, for example, the halogen dryer unit of your instrument needs a shorter time to reach its maximum heating power. It also allows use of high temperatures, an additional factor in shortening the drying time. Uniform heating of the sample material ensures good repeatability of the drying results and makes it possible to use a smaller amount of sample.



All parameters of a measurement (drying temperature, drying time, etc.) can be preselected. But your Moisture Analyzer offers many other possibilities. To avoid exceeding the scope of this introduction, only a few of these are listed here:

- In the built-in methods database 20 different methods can be individually optimized to suit your samples. They are simple to activate at the touch of a key.
- The drying process can be adjusted to suit the type of sample
- You can choose between various types of result display at any time
- Your settings and the measurement results can be recorded and stored
- Thanks to the built-in rechargeable battery your valuable data remain stored even on power failure.

This wealth of functions notwithstanding, your Moisture Analyzer is very simple to operate. The status display (user guide) guides you step by step through the measurement cycle and you always know which particular stage in a measurement is currently being executed by the instrument and the next operating step. To exclude faulty handling in routine work, the keypad can be locked to prevent access to all but the elementary functions. The motorized, automatic sample chamber offers the operating convenience you are familiar with from compact disk (CD) players. Moreover, the motorized drive opens up new possibilities for automatic operation of the instrument (loading by means of robots) when used with the LocalCAN universal interface installed as standard.

But in addition to every type of user convenience, the quality of the measurement results continues to be of prime importance. The built-in weighing cell meets the high standard which has made METTLER TOLEDO the worldwide market leader in the field of high-resolution precision balances.

A brief word regarding standards, directives and procedures for quality assurance. The Moisture Analyzer conforms with all common standards and directives. It supports stipulations, work techniques and result records as demanded by all international quality assurance systems, e.g. **GLP (Good Laboratory Practice)**, **GMP (Good Manufacturing Practice)** or **ISO 9001**. The instrument has a CE declaration of conformity and METTLER TOLEDO as the manufacturer has been awarded ISO 9001 certification. This provides you with the assurance that your capital investment is protected in the long term by a high product quality and a comprehensive service package (repairs, maintenance, servicing, calibration service).

As far as the features and possibilities of your Moisture Analyzer are concerned, we shall content ourselves at present with the above brief description. You will find further information in the following sections of these operating instructions. Please read through this information carefully to ensure you can use your instrument in an optimum and safe manner.



### 1.3 Safety has priority

Your Moisture Analyzer employs state of the art technology and meets the latest demands regarding instrument safety. This notwithstanding, improper operation can endanger personnel and cause damage to tangibles. For safe and dependable operation, please comply with the following instructions:

- The Moisture Analyzer is used for determination of the moisture in samples. Please use the instrument exclusively for this purpose. Any other type of use can endanger personnel and damage the instrument or other tangibles.
- The Moisture Analyzer must not be operated in a hazardous environment and only under the ambient conditions specified in these instructions.
- The Moisture Analyzer may be operated only by trained personnel who are familiar with the properties of the samples used and with the handling of the instrument.
- Your Moisture Analyzer is supplied with a 3-pin power cable with an equipment grounding conductor. Only extension cables which meet the relevant standards and also have an equipment grounding conductor may be used. Intentional disconnection of the equipment grounding conductor is prohibited.

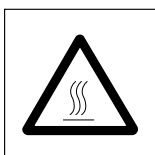

#### **The Halogen Moisture Analyzer works with heat!**

- Ensure sufficient free space around the instrument to avoid heat accumulation and overheating (approx. 1 m free space above the instrument).
- The vent over the sample must never be covered, plugged, taped over or tampered with in any other way.
- Do not place any combustible materials on, under or next to the instrument when it is connected to the power supply, since the area around the dryer unit becomes hot.
- Exercise caution when removing the sample. The sample itself, the automatic sample chamber and any sample vessels used may still be very hot.
- During operation, you should never open the dryer unit as the ring-shaped heating element or its protective glass can reach 400°C! If you have to open the dryer unit on occasion, disconnect the instrument from the power supply and wait until the dryer unit has cooled down completely.
- No modifications must be made within the heating element. It is particularly dangerous to bend any components or remove them, or to make any other changes.

**Certain samples require special care!**

With certain types of samples, there is a possibility of danger to personnel or damage to tangibles through:

**Fire or explosion:**

- Flammable or explosive substances
- Substances containing solvents
- Substances which evolve flammable or explosive gases or vapors when heated.

With such samples, work at a drying temperature that is low enough to prevent the formation of flames or an explosion and wear protective goggles. Should there be any uncertainty regarding the flammability of a sample, always work with a small amounts of sample (max. 1 gram). In such cases, **never leave** the instrument **unattended!** In cases of doubt, perform a careful risk analysis.

**Poisoning, burning:**

- Substances which contain toxic or caustic components. Such substances may be dried only in a fume cupboard.

**Corrosion:**

- Substances which evolve corrosive vapors when heated (e.g. acids). In the case of such substances, we advise you to work with small amounts of sample as the vapor can condense on cooler housing parts and cause corrosion (if necessary, the dryer unit can be changed very easily by the user, see section 7.6).

Please note that the user always takes responsibility and assumes liability for damage caused by use of the types of samples mentioned above!

- Never make any modifications or constructional alterations to the instrument and use only original spare parts and optional equipment from METTLER TOLEDO.
- Your Moisture Analyzer is a rugged precision instrument – but you should still treat it carefully; it will then thank you with many years of trouble-free operation.
- Please comply with all notes and instructions in these operating instructions. Keep the instructions in a safe place where they are immediately to hand if any points are unclear. If you lose these instructions, please contact your METTLER TOLEDO dealer for an immediate replacement.

## 1.4 Important information for these instructions

These instructions guide you step by step through the operation of your Moisture Analyzer. The first two sections help you put the instrument into operation quickly, safely and properly and perform your first measurement within a short space of time. In sections 3 through 6 you become intimately acquainted with the wide range of functions of your Moisture Analyzer. During this learning phase, you will find the table of contents and the detailed index in section 10 a valuable orientation aid. Sections 7 through 9 contain additional information on the maintenance of your instrument, troubleshooting and the available options. As soon as you are familiar with your Moisture Analyzer, you will find the illustrations at the beginning of these instructions and the associated references (in the key) useful for quick access.

The following identifications and symbols are used in these instructions:

- Information marked in grey applies only to the HR73.
- Key designations are shown enclosed by twin angle brackets «». Keys with inscribed text are shown with the actual inscription (e.g. «on/off» or «Start»). For all keys with symbols, designations are used in the text which describe the function of the particular key («Print», «Accept entry » or «Scroll down»).
- This symbol indicates safety and hazard instructions. If these are not complied with, injury to the user, damage to your instrument or other tangibles and malfunctions can result.
- This symbol indicates additional information and directions which facilitate your handling of the instrument and contribute to proper and economical use.

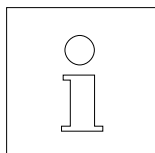

These instructions are also available in foreign languages. Should you require a set of instructions in a different language, please contact your METTLER TOLEDO dealer. You will find the address of your nearest dealer in the attached Declaration of Conformity.

## 2. Your first measurement in next to no time

In the section you will learn how to put your new Moisture Analyzer into operation and obtain measurement results within a very short space of time.

### 2.1 Unpacking and checking the standard equipment

Open the package and remove the instrument and the accessories. Check the completeness of the delivery. The following accessories are part of the standard equipment of your new Moisture Analyzer:

- 80 aluminum sample pans
- 1 sample holder
- 1 sample handler
- 1 specimen sample (circular, absorbent cellulose disk)
- 1 draft shield element
- 1 power cable
- 1 set of operating instructions, 1 set of short-form operating instructions
- 1 MT-SICS Reference Manual with command set of interface
- 1 Application brochure “Methods of moisture content determination”
- 1 Declaration of Conformity
- Setup instructions

Remove the wrapping from the instrument.

Check the instrument for transport damage. Immediately inform your METTLER TOLEDO dealer if you have any complaints or parts are missing.

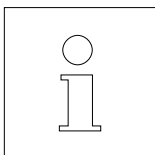

Store all parts of the packaging. This packaging guarantees the best possible protection for the transport of your instrument.

To prevent transport damage, the instrument is provided with a **transport arrestment**, which you have to remove before putting the instrument into operation for the first time. The procedure for removing the transport arrestment is explained in the description “Setup instructions” enclosed with the package.

## 2.2 Selecting the location

Your Moisture Analyzer is a precision instrument. An optimum location guarantees accuracy and dependability:

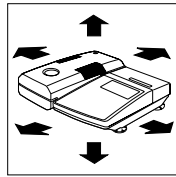
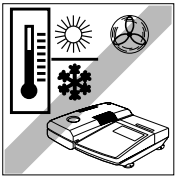
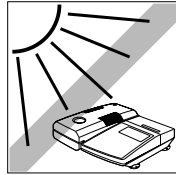
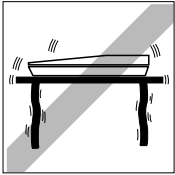

- Firm, horizontal location as free from vibrations as possible
- Avoid direct sunlight
- No excessive temperature fluctuations
- No powerful drafts
- Surroundings as free from dust as possible
- Adequate free space at the front for opening the sample chamber and sufficient clearance around the instrument to allow warm air to dissipate.
- Sufficient distance from heat-sensitive materials in the vicinity of the instrument.

## 2.3 Setting up, leveling and connecting to power supply

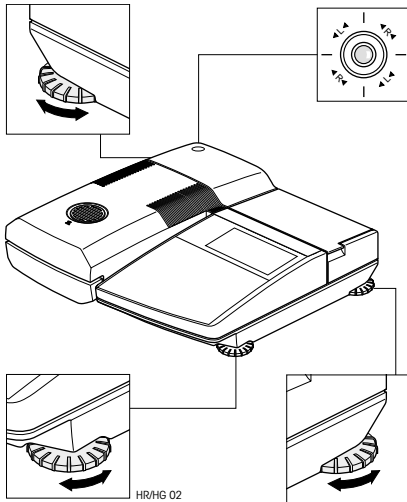

Exact horizontal positioning and stable installation are prerequisites for repeatable results. To compensate small irregularities or inclinations ( $\pm 2\%$ ) at the location, the instrument can be leveled.

For exact horizontal positioning, the Moisture Analyzer has a level indicator (level) and 3 leveling screws. As soon as the air bubble is precisely in the middle of the cross hairs, the instrument is exactly horizontal. To level it, proceed as follows:

Position your Moisture Analyzer at the selected location.

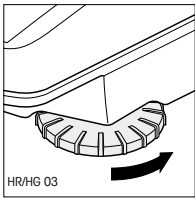

Screw in the right front leveling screw completely (it is not needed for leveling). The instrument is now standing on the front left, nonadjustable foot, as well as on the two rear leveling screws.

Turn the two **rear** leveling screws until the air bubble is located in the middle of the level indicator. The arrows and the leveling screw designations (R = right rear leveling screw, L = left rear leveling screw) on the cross hairs will facilitate the setting:

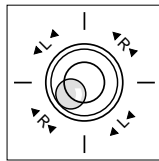
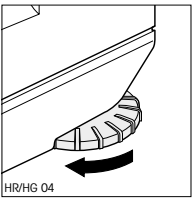

If the air bubble is located at the bottom left, for instance, the inscription indicates the right leveling screw must be turned in a clockwise direction.

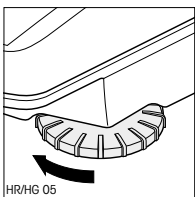
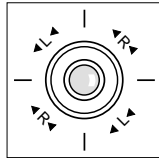

Unscrew the front right leveling screw until it contacts the support and the instrument is resting firmly on all 4 feet. Ensure that the air bubble remains in the center of the level indicator.

**Note:** The instrument should be releveled each time its location is changed.

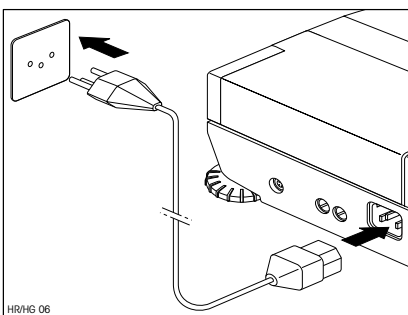

Connect the instrument to the power supply.

**Warning:**

If the power cable supplied is not long enough, use only a **3-pin extension cable with equipment grounding conductor!**

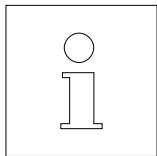

For technical reasons, the halogen dryer unit is designed specifically for a particular line voltage (110 V AC or 230 V AC). A dryer unit is installed in the factory that is matched to the particular line voltage of the country of destination. If you are not sure whether the dryer unit built into your instrument is suitable for your local line voltage, check the voltage data in the interior of the dryer unit before you connect the Moisture Analyzer to the power supply!



Connection to a line voltage that is too high can lead to blowing of the fuses, whereas a supply voltage that is too low will prolong the drying process.

Ensure that the transport arrestment is removed. Instructions on how to remove the transport arrestment can be found on the leaflet enclosed with the package.

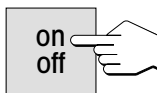

Switch the instrument on with the «on/off» key.

**Note:** When putting into operation for the first time, leave the instrument connected to the power supply for at least 5 hours to allow the built-in battery to charge up! If the instrument is later disconnected from the power supply for several months, the battery will become discharged. This leads to data loss. To recharge the battery, leave the instrument connected to the power supply for at least 5 hours.

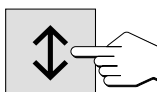

Press the «Open/close auto sample chamber» key and ...

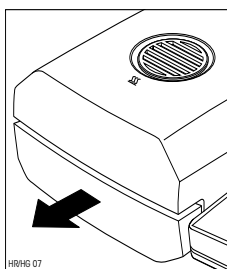

... the motorized, automatic sample chamber opens.



Always ensure **sufficient free space in front of the instrument** since the emerging automatic sample chamber could knock over objects in its path or push them off the bench.



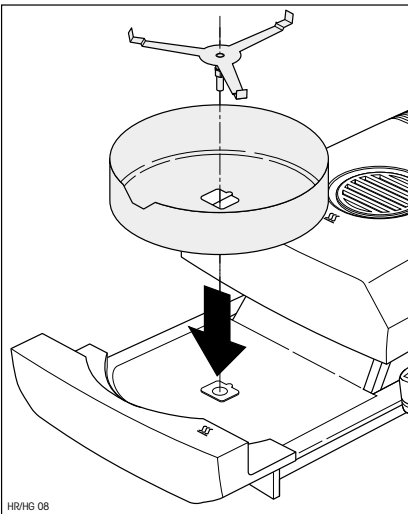

Install the draft shield element (only one position possible) and then the sample pan holder. Turn the sample pan holder until it engages. In the locked position, the rear arm of the sample pan holder points exactly in the direction of motion of the automatic sample chamber.

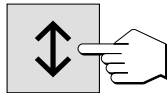

Press the «Open/close auto sample chamber» key and ...

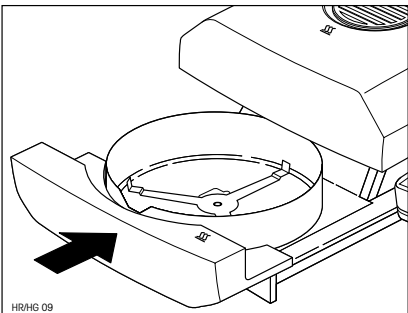

... the motorized, automatic sample chamber closes.

## 2.4 Preparing the printer

If your Moisture Analyzer is not equipped with a built-in printer, there is no need to read this section. You can always order the built-in printer at a later date and install it yourself.

You can prepare the built-in printer for use as follows:

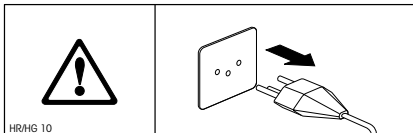

Disconnect the instrument from the power supply.

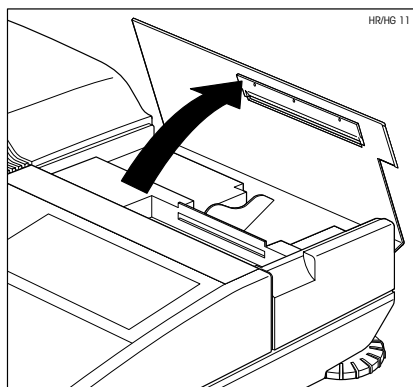

Swing back the cover of the printer.

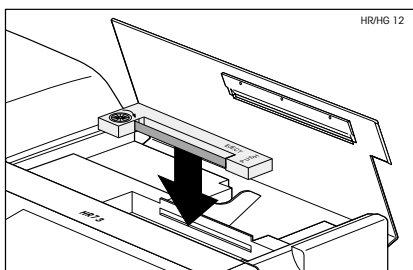

Insert the ribbon cassette in the printer and press it down until you hear it click into place.

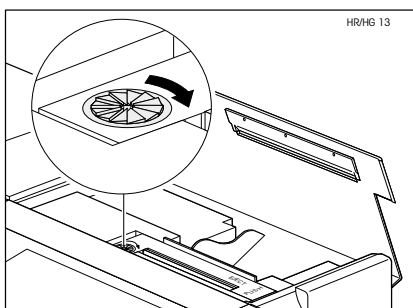

Tension the ribbon by turning the small wheel on the left of the cassette in the direction shown by the arrow.

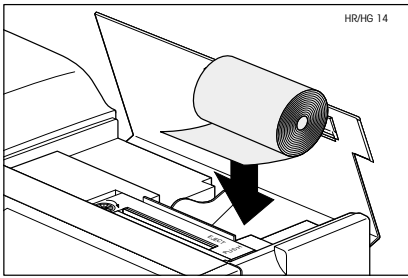

Place the roll of paper in the paper compartment and feed the paper horizontally through the slot at the back of the printing unit.



Connect the instrument to the power supply and switch it on with the «on/off» key. Press the «Paper feed» key until the leading edge of the paper exits the printing unit at the top.

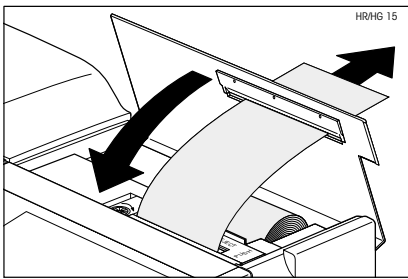

Lead the paper through the slot in the cover of the built-in printer and close the cover.

## 2.5 Setting the date and time

Your Moisture Analyzer prints out the date and time on every record. When you put your new instrument into operation for the first time, you should enter the current date and the time, these settings are retained even if you disconnect your instrument from the power supply.

In this section you will enter the menu for the first time, although this is described in detail in a later section. Do not worry if you have to press keys whose function you are not familiar with, simply follow the instructions step by step. We describe the menu in detail in section 6.

**Note:** Various languages are available for the dialog with your instrument and can be selected in the menu. You will find further details on language selection in section 6.20.

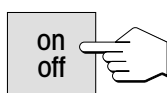

Press the «on/off» key to switch the instrument on.

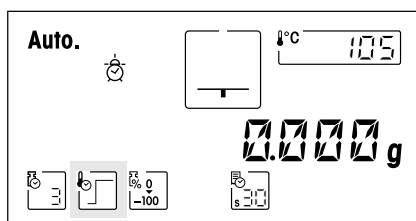

After it has been switched on, the instrument performs a self-test. Wait until the display shown opposite appears.

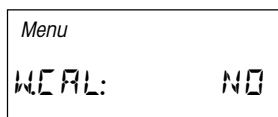
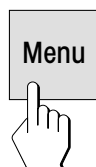

Press the «Menu» key. You are now already in the menu.

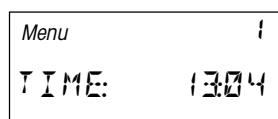
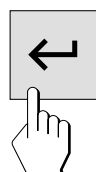

Press the «Accept entry» or «Menu» key repeatedly until the display shown opposite for entry of the time appears.

**Important:** Do not press any other key, otherwise you could possibly change the factory settings of your instrument!

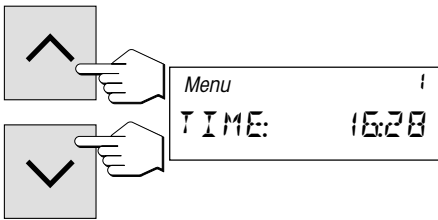

Use the «Scroll up» and «Scroll down» keys to set the time (00:00–23:59). By pressing and holding the keys you can accelerate the change in the time. Confirm your setting with the «Accept entry» key. The instrument stores the time.

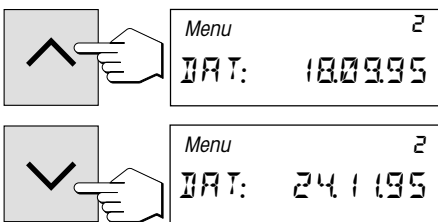
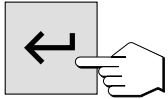

After confirmation of the time, the display for entry of the current date appears. Use the «Scroll up» and «Scroll down» keys to set the date in the format "Day – Month – Year" (DD.MM.YY). By pressing and holding the keys you can accelerate the change in the date. Confirm your entry with the «Accept entry» key and the instrument stores the date.

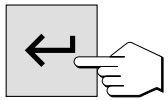

**Note:** With US English as the dialog language, the following applies to entry of the date format "Month – Day – Year" (MM/DD/YY).

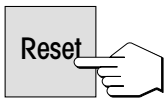

This completes your entry of the date and time and you can now quit the menu by pressing the «Reset» key. Your settings are stored and remain so even in the event of a power failure. The Moisture Analyzer is now ready for your first measurement.

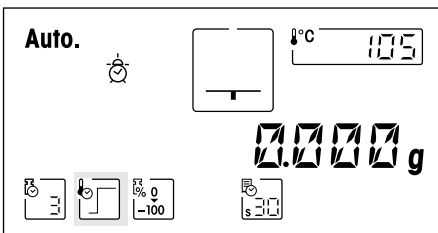

## 2.6 Your first measurement

After you have successfully put your new Moisture Analyzer into operation for the first time, you can immediately perform your first measurement. In doing so, you will become familiar with the instrument and the status display and at the same time perform a function check.

Please use the specimen sample supplied for your first measurement. This sample is an absorbent cellulose disk. During your first measurement, the instrument operates with the factory settings.

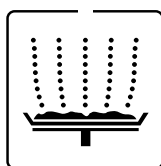

Your Moisture Analyzer has a novel graphical status display (user guide) which you will become acquainted with in this section. The status display informs you continuously about the current status of the instrument and prompts you to execute the next operating step (shown flashing).

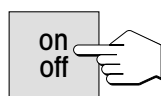

Switch the instrument on with the «on/off» key.

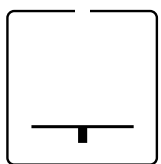

**Initial status** with closed automatic sample chamber.

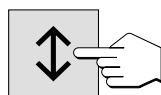

Press the «Open/close auto sample chamber» key and ...

... the motorized, automatic sample chamber opens.

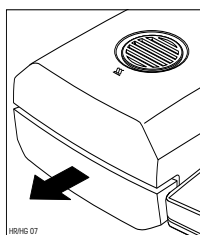

Always ensure **sufficient free space in front of the instrument** since the emerging automatic sample chamber could knock over objects in its path or push them off the bench.

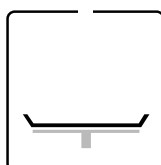

**Status: Ready for taring**

The status display flashes and prompts you to load the empty sample pan and tare.

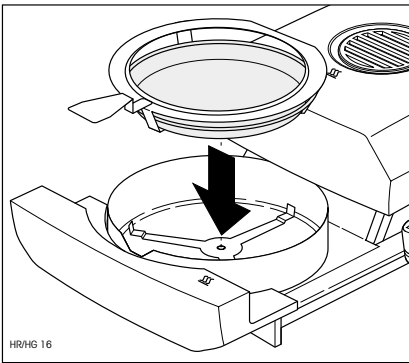

Place the empty sample pan in the sample pan handler (this is possible without tilting the sample pan if you insert this in the pan handler from the side directly below the round flange). Place the sample pan handler in the automatic sample chamber. Ensure that the tongue of the pan handler fits exactly in the slot of the draft shield element. The sample pan must lie flat in the pan holder.

**Note:** We advise you to work with the sample pan handler at all times. The pan handler is ergonomic, safe and provides protection against possible burns due to the hot sample pan.

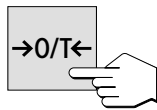

Press the «Tare/zero» key. This sets the balance installed in the Moisture Analyzer to zero. For taring, the automatic sample chamber closes briefly then opens again.



**Status: Ready for weighing**

After taring, the status display flashes and prompts you to place the sample in the sample pan.

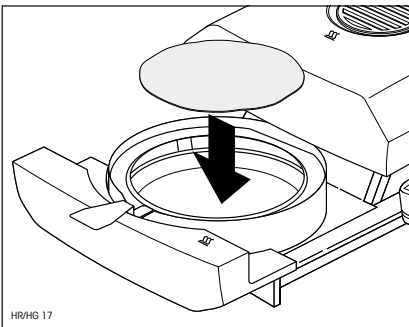

Place the specimen sample in the sample pan.

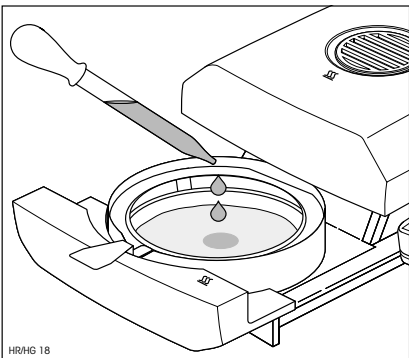

Wet the specimen sample with a few drops of water.

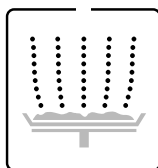

**Status: Ready for start**

The status display flashes and prompts you to start the drying process.

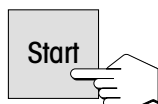

Press the «Start» key and ...

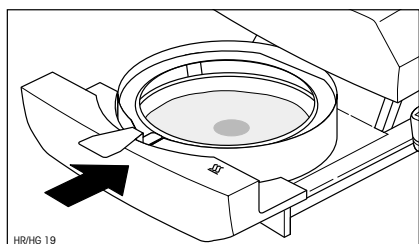

... the motorized, automatic sample chamber closes. The instrument starts the drying and measurement.

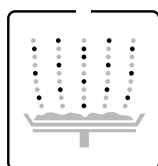

**Status: Drying and measurement**

You can follow the drying and measurement process in the display:

- The status display uses rising bubbles to symbolize the drying process.
- The current temperature in the dryer unit is displayed as well as the elapsed drying time and the current drying value.
- Further, the display shows information on the selected settings. You will find additional information on the meaning of the displays and the various setting possibilities in section 4. If your instrument has a built-in printer, the measurement results will be printed out continually (at intervals of 30 seconds).

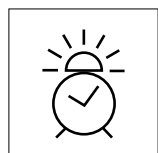
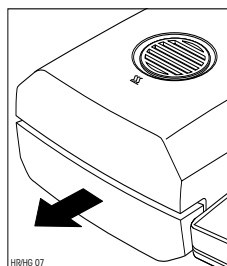
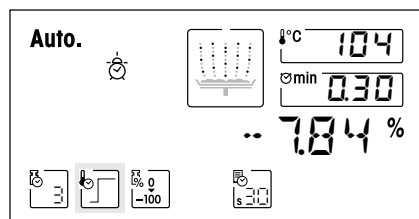

At the end of the drying time, an audio signal sounds and the sample chamber is automatically opened.



**Warning: Sample pan and sample are still hot!**



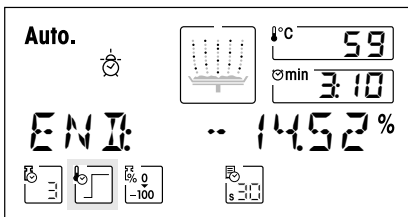

You can now read off the **moisture content** of your sample in the display.

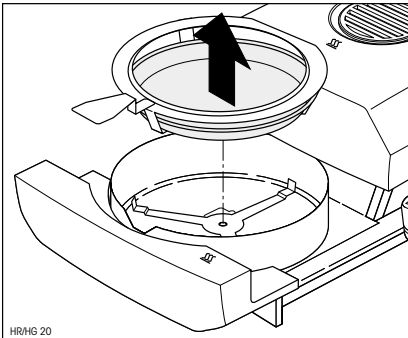

Carefully remove the sample pan handler from the automatic sample chamber.



**Warning: As the pan and sample may still be hot, you should let these cool down before removing the pan from the handler!**

To remove the sample pan from the handler, lift the pan slightly from below and pull it sideways out of the handler (if you no longer need the sample and the pan, you can simply tilt the handler until the pan slides out).

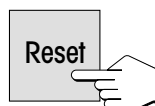

Press the «Reset» key to delete the measurement result from the display. The instrument is now ready for the next measurement. If you do not wish to perform another measurement, press the «Open/close auto sample chamber» key. The automatic sample chamber closes.

### **Congratulations!**

You have just performed your first measurement with your new Moisture Analyzer. In the following section you will find important information on the operating principle of your instrument, its calibration and optimum preparation of your samples.

### **Notes on the automatic sample chamber**

- Before every automatic closure of the automatic sample chamber, an audio signal sounds.
- For reasons of safety, the open automatic sample chamber is automatically closed after 2 minutes. If a weight change occurs or a key is pressed during this time, the 2 minute period starts over again.

## 3. How to obtain the best results

Following your first practical work with the Moisture Analyzer, in this section you will find important information on how to obtain optimum results. You will discover what parameters influence the measurement process and how you can match the instrument optimally to your particular measurement task.

### 3.1 Measurement principle of the Halogen Moisture Analyzer

Your instrument performs measurements based on the **thermogravimetric principle**, i.e. the moisture is determined from the weight loss of a sample dried by heating.

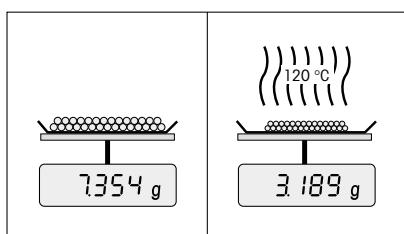

In principle, your instrument thus comprises two instruments: a precision balance and a dryer unit. In contrast to other thermogravimetric methods (drying oven, infrared, microwave), the Halogen Moisture Analyzer operates with a halogen dryer unit. This ensures fast heating of the sample and thus guarantees rapid availability of the measurement results.

In addition to thermogravimetric methods, chemical and electrical methods for moisture determination are also common. A familiar chemical method is that due to Karl Fischer in which the water content is determined by titration. This method is particularly suitable for determination of the water content of liquids or for the detection of very small amounts of water (ppm range) in solid and liquid samples.

Irrespective of the measurement method, the quality of the measurement results stands or falls by the **preparation of the sample** and **a correct choice of the important measurement parameters**:

- Sample size
- Drying temperature
- Drying time

You will find detailed information on the relationships between these parameters in the application brochure for moisture determination (see section 9.3), enclosed to your instrument.

In practice, however, not only the quality of the measurement results, but also the **speed of the measurement process** is important. Thanks to its drying principle (with the heat generated by a halogen radiator), the Halogen Moisture Analyzer is very fast. You can increase the speed even further through optimum setting of the instrument.

The **optimum drying temperature and the drying time** are dependent on the nature and size of the sample and on the desired accuracy of the measurement results. These can be determined only by experiment. The Halogen Moisture Analyzer supports you in this task: It offers **automatic performance and result recording of test measurements** to determine optimum values of the settings.

## 3.2 Notes on adjustment of the balance and the dryer unit

Both the built-in balance and the dryer unit of your instrument can be adjusted. Adjustment of the balance is not absolutely necessary for a correct moisture determination as the measurement is relative: The balance determines the weight of the sample before and after drying and the moisture is calculated on the basis of the ratio between the wet and dry weights.

Nevertheless, you should adjust the built-in balance and dryer unit under the following conditions:

- If this is stipulated by your quality assurance system (GLP, GMP, ISO 9001).

**Note:** You can assure long term reproducibility of the instrument by regular adjustment (e.g. every 6 months) and hence comply with an important requirement of every quality assurance system. METTLER TOLEDO offers an adjustment service – please contact your local dealer.

- If you also use your instrument as a high precision lab balance, you should adjust the balance at regular intervals.
- If you have changed the dryer unit, adjust it with the help of an external thermometer.

The procedure for adjusting the balance and dryer unit is described in section 6.

## 3.3 Optimum sample preparation

Preparation of the sample is decisive for the speed of the measurement process and the quality of the measurement results.

Please note the following **basic rules** for the preparation of your sample:

**The amount of sample you select should be as small as possible and only as large as necessary**

Excessive amounts of sample require more time for drying and thus prolong the measurement process. If the amount of sample is too small, the measurement result may possibly not be representative. The following always holds: The greater the inhomogeneity of the sample, the larger the amount of sample needed to obtain a repeatable result (please see also the list in section 9.1).

### **Distribute the sample evenly over the sample pan**

You thus increase the surface area of the sample and facilitate heat absorption. The base of the pan should be evenly covered.

With liquid, fat-containing, melting and highly reflecting samples, you should cover the sample with the glass fiber disc available as optional equipment (HA-F1 214464, see section 9.7). This also applies to samples which form a skin on their surface when heated. The glass fiber disc ensures even and rapid heat distribution and prevents the formation of a skin impervious to moisture on the sample surface.

## **3.4 Further information on moisture determination**

You will find further information on the moisture determination, the importance of the parameters and the preparation of the samples in the **Application Brochure** "Methods of moisture content determination" dealing with moisture determination (see section 9.3).

If you require information on specific applications, your METTLER TOLEDO dealer will be pleased to help you.

## 4. Practical application of your Moisture Analyzer

In this section we introduce you to the wide range of setting possibilities of your Moisture Analyzer and offer information and tips for optimum setting of the parameters.

### 4.1 The operating concept

You already performed your first measurement in section 2. This measurement was carried out using the factory settings. However, your instrument offers a number of setting possibilities to match the measurement process to your specific requirements. For instance, you can preselect the drying temperature, the type of result display and many other parameters.

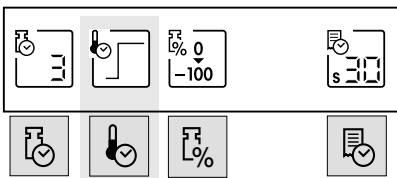

Settings are made using the function keys. These keys are right at the top of the keypad, directly below the display. The setting you select appears in the display directly above the associated key.

You will learn the available setting possibilities and the function keys in detail in the following sections. Further, you will also discover how to set the drying temperature and the drying time and how to work with the weighing-in aid. Finally, you will perform a complete measurement with the specific settings for your sample.

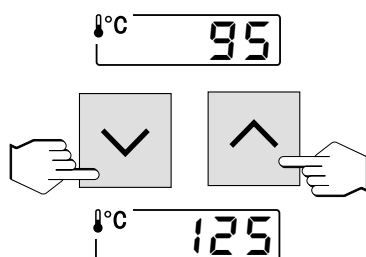

#### Numeric entries

With some settings (e.g. the drying temperature), **numeric entries** are required. It depends on the instrument that you have two different possibilities to enter the values:

You can change the flashing displayed value with the «Scroll up» or «Scroll down» key or ...

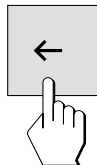
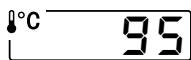

... you can key in the new value directly with the numeric keys.

You can remove wrong numbers with the «Delete» key.

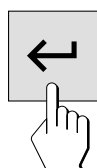
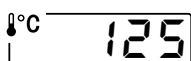

As soon as you have entered the desired value, press the «Accept entry» key. The value will be stored.

### Preliminary information on the methods

All settings for a sample which you will learn in the following sections can be collected in a so-called "Method". You have 20 methods freely available thus giving you the possibility of defining a method for a particular sample and recalling it at any time. This eases the work load considerably as each time you switch to a different type of sample there is no need to repeat all the parameter settings. The methods are retained when the instrument is switched off. You will find information on the compilation and use of methods in section 5.

## 4.2 Selecting the drying program

This function key offers you four different drying programs for optimum matching of the drying characteristics to the sample used.

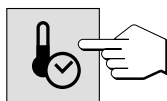

Each time this key is pressed, the next program appears. After the fourth and last program, the first reappears in the display. As soon as you have selected the desired program, the setting is active and you do not have to confirm or store it.

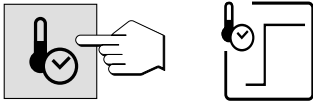

### Standard drying

The temperature control of the HG53 Halogen Moisture Analyzer corresponds to the standard drying program.

This **drying program** is set in the factory and is suitable for most samples. The sample is heated to the drying temperature (set temperature) and held constant at this temperature.

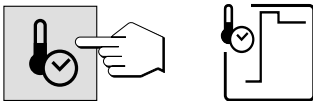

### Rapid drying

This program is primarily suitable for **samples with a moisture content over 30%**. Following the start, the selected temperature is **exceeded** by 40% for 3 minutes to compensate the cooling due to vaporization and accelerate the drying process. The drying temperature is then lowered to the set value and maintained. You will find details on how to enter the drying temperature in the next section.

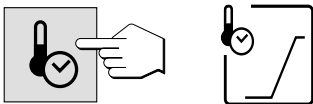

### Gentle drying

This program is suitable for the gentle drying of **substances which tend to form a skin** (e.g. substances containing sugar). With this program the temperature is continuously increased and attains the selected drying temperature **only after the elapse** of the so-called "ramp time". The "ramp", i.e. the time that should elapse between the start of drying and attainment of the final temperature is preselectable. The setting of the "ramp" is described in the next section.

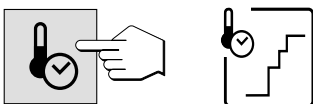

### Step drying

This program is suitable for the drying of **substances composed of several components** which vaporize at different temperatures (e.g. ethereal oils). With this program drying is performed **stepwise**, i.e. the sample is preheated to a particular temperature (1st step) and kept at this temperature for the selected time (hold time).

The temperature is then increased to the next value (2nd step) and again maintained for a certain time. Finally, the temperature is raised to the preselected drying temperature (set temperature) and held constant at this value until the end of drying. With this program you can preselect the temperature and time for each step. These settings are described in the next section. If only one step is needed, the time of step 2 must be set to 0.

Step drying can also be useful for the **rapid determination of substances with a high moisture content**. Here, the 1st step is set higher than the final temperature to compensate the cooling due to vaporization.

### 4.3 Setting the drying temperature

After pressing this key you can enter the drying temperature (set temperature).

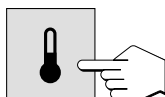

The type of entry depends on the selected drying program (see previous section). If you have selected one of the programs "Standard drying" or "Rapid drying", you need enter only the drying temperature. For the two programs "Gentle drying" and "Step drying", additional entries are required to define the ramp or the steps. The different entry procedures are described below.

**Note:** The admissible input range for temperatures is 50 °C–200 °C.

#### Selecting drying temperature for standard drying and rapid drying

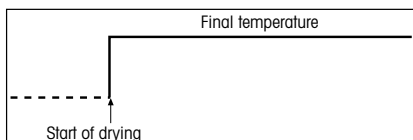

You need enter only the desired final temperature.

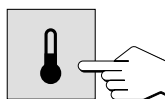

Press the «Drying temperature» key and enter the desired drying temperature (see section 4.1).

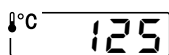

- either with the «Scroll up» and «Scroll down» keys or
- directly via the numeric keypad

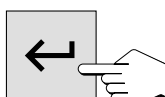

Press the «Accept entry» key.



### Selecting drying temperature for gentle drying

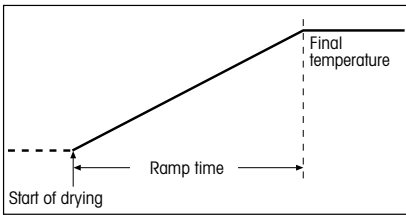

For this temperature program you first define the so-called “ramp”, i.e. the time that should elapse between the start of drying and attainment of the final temperature. You then select the drying temperature (final temperature).

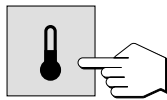

Press the «Drying temperature» key.

RAMP: 300

#### Entering the ramp time

The instrument prompts you to define the ramp time. In the factory the ramp time is set to 3 minutes.

RAMP: 430

Enter the desired value.

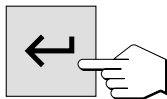

Press the «Accept entry» key.

°C 125

#### Entering the drying temperature

The instrument now prompts you to enter the drying temperature (final temperature). Enter the desired temperature (e.g. 125 °C).

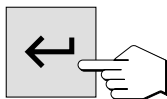

Press the «Accept entry» key.

### Selecting drying temperatures for step drying

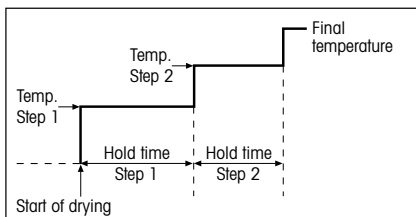

For this temperature program you define the temperature and the hold time for each step.

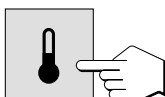

Press the «Drying temperature» key.

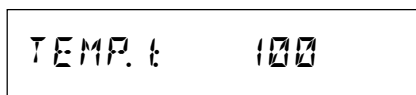

#### Entering the drying temperature and hold time for the first step

The instrument prompts you to define the temperature for the first step. Enter the desired temperature.

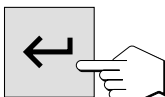

Press the «Accept entry» key.

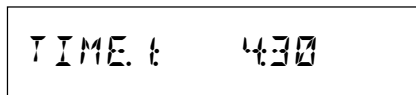

The instrument now prompts you to enter the hold time for the first step. Enter the desired time.

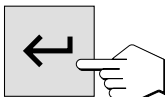

Press the «Accept entry» key.



#### Entering the drying temperature and hold time for the second step

The instrument now requests entry of the temperature for the second step. Enter the desired temperature.

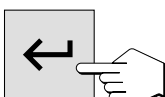

Press the «Accept entry» key.

TIME: 300

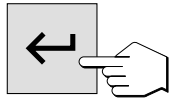

°C 160

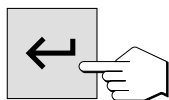

Define the hold time for the second step.

Press the «Accept entry» key.

### Entering the final temperature

Finally, you enter the desired final temperature.

Press the «Accept entry» key.

## Temperature limitation

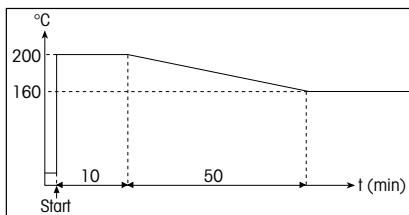

Several mutually independent systems prevent the instrument overheating:

- At temperatures above 160 °C a time limit becomes active. The higher the temperature, the shorter the time until the instrument starts to lower the temperature (envelope curve, see illustration opposite).
- A temperature switch independent of the normal black temperature sensor over the sample (see section 7.1) is triggered when it detects exceptionally high temperatures. This situation could arise, for example, if the sample begins to burn or the temperature calibration is defective. If this happens, the heating element is tripped out by a mechanical switch, and the instrument cannot be restarted. Please refer to section 8.3 for troubleshooting.

When working with temperatures over 180 °C we recommend that you always wait 2 - 3 minutes between individual measurements, in order to ensure good reproducibility of the readings.

## 4.4 Selecting the switch-off criterion and performing a test measurement

This function key offers you different switch-off criteria. A switch-off criterion defines when the instrument should end the drying. Switch-off criteria save you having to keep checking your watch and stopping the drying manually.

The following settings can be selected for the switch-off criterion:

- “Weight loss per unit of time ” (5 settings)
- “Free switch-off criterion” (if activated in the menu)
- “Manual switch-off”
- “Timed switch-off”
- “Test measurement” for determination of the suitable switch-off criterion

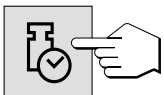

### Weight loss per unit of time

This switch-off criterion is based on a weight loss per unit of time. As soon as the mean weight loss is less than a preset value during a specified time, the instrument considers drying as complete and automatically discontinues the measurement process. During the drying, the time display shows you how long the measurement process has been in progress; the switch-off criterion is inactive during the first 30 sec. You will find additional information in section 9.4.

The following 5 settings are available:

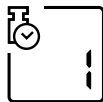
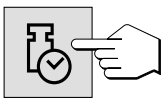

This setting is suitable for samples which dry very quickly (surface moisture) or for (relatively inaccurate) fast measurements to determine a trend.

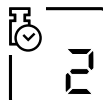
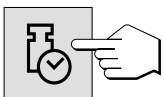

This setting is suitable for quick drying samples.

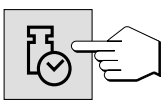

This is the **factory setting**. It is suitable for most types of samples.

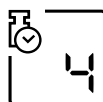
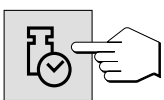

This setting is suitable for samples which dry moderately quickly.

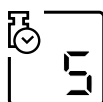
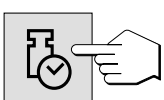

This setting is suitable for samples which dry very slowly (trapped moisture, skin formation).

**Note:** If you do not know the behavior of a sample, perform a test measurement to determine the suitable switch-off criterion. The procedure is described later in this section under the title “Test measurement”.

### Free switch-off criterion

This setting possibility is available only if you have activated it in the menu. The free switch-off criterion is based on a user-defined mean weight loss per unit of time.

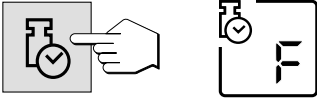

You will find information on the activation and definition of the individual switch-off criterion in sections 6.17 and 9.4.

### Manual

With this switch-off criterion the measurement process continues until you stop it with the «Stop» key.



The time shown in the display tells you how long the current measurement has been in progress.

### Timed switch-off

With this switch-off criterion the measurement lasts until the preset drying time has elapsed (the time display provides you with continuous information on the drying time).



If you select this criterion, you must then enter the desired **drying time** as follows:

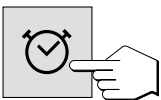

Press the «Drying time» key.

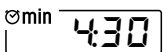

Enter the desired drying time.

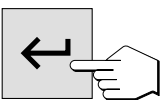

Press the «Accept entry» key.

### Test measurement

You can use this function only if your instrument is fitted with a printer!



TEST MEASUREMENT		
Drying temp.	120	°C
Weight	2.543	g
	0...-100	%MC
0:00 min	-0.00	%MC
0:30 min	-1.96	%MC
1:00 min	-2.88	%MC
1:30 min	-3.52	%MC
4:30 min	-13.80	%MC
5:00 min	-14.39	%MC
Switchoff mode	1	
Time 1	5:37 min	
Result 1	-15.17 %MC	2.158 g
6:00 min	-15.28	%MC
6:30 min	-15.42	%MC
Switchoff mode	2	
Time 2	7:42 min	
Result 2	-15.81 %MC	2.141 g
9:30 min	-16.14	%MC
10:00 min	-16.56	%MC
Switchoff mode	5	
Time 5	11:22 min	
Result 5	-16.91 %MC	2.113 g
Total time	12:33 min	
End result	-17.11 %MC	2.108 g
>>>>>> MANUAL <<<<<<<<		
----16.01.99---16:28----		

If you wish to work with the switch-off criterion “Weight loss per unit of time” and are not familiar with the behavior of the sample, the test measurement will help you select the suitable setting.

You perform a test measurement just like any other measurement. You will find further information on how to perform the measurement in section 4.8.

During the test measurement a record is printed out which explains exactly when and with what measurement result each switch-off criterion was reached. The test procedure can be ended at any time with the «Stop» key. Automatic switch-off follows after a measurement time of 8 hours.

The diagram opposite illustrates the progress of a drying. The points at which the individual switch-off criteria were reached (1–5) are marked.

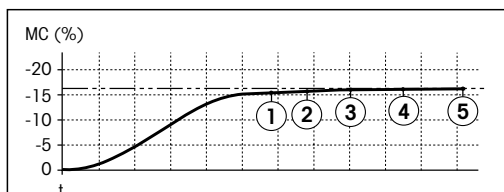

**Note:** The dimensions of the results are designated by **%MC** or **%DC**. You will find information on the meaning of these abbreviations in section 4.5.

Test measurements are not entered in the journal or the statistics (sections 5.5 and 5.6).

## 4.5 Selecting the display mode

With this function key you can select the desired type of result display. You also define what values are printed on the records.

The following display modes are available:

### Moisture content

The moisture content of the sample is displayed (and printed out) as a percentage of the wet weight (=  $ww = \text{initial weight} = 100\%$ ). This is the **factory setting**.

When the results are printed out, the moisture content is marked by "%MC" (**M**oisture **C**ontent) (e.g. -11.35 %MC).

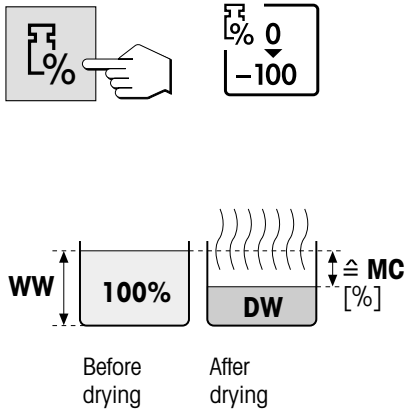

$$\text{MC} [0 \dots -100\%] = - \frac{\text{Wet weight } \mathbf{WW} - \text{Dry weight } \mathbf{DW}}{\text{Wet weight } \mathbf{WW}} * 100\%$$

During the drying the current measured value is continuously displayed in percent.

### Dry content

The dry content of the sample is displayed (and printed out) as a percentage of the wet weight (=  $ww = \text{initial weight} = 100\%$ ).

When the results are printed out, the dry content is marked by "%DC" (**D**ry **C**ontent) (e.g. 88.65 %DC).

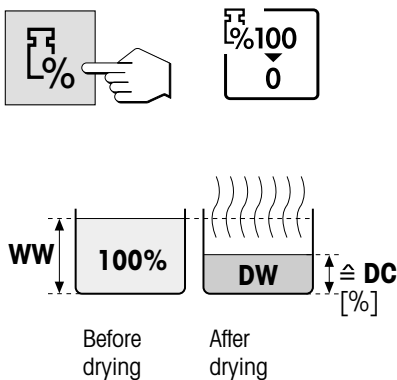

$$\text{DC} [0 \dots 100\%] = \frac{\text{Dry weight } \mathbf{DW}}{\text{Wet weight } \mathbf{WW}} * 100\%$$

During the drying the current measured value is continuously displayed in percent.

### Weight in grams

The weight of the sample is displayed (and printed out) in grams. With this setting, the Moisture Analyzer is used as a precision balance.

During the drying the current weight is continuously displayed in grams.



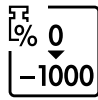
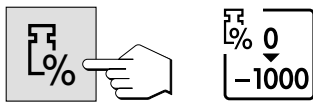

### ATRO moisture content

The moisture content of the sample is displayed (and printed out) as a percentage of the dry weight (= DW = final weight = 100%)

When the results are printed out, the ATRO moisture content is marked by “%AM” (ATRO Moisture Content) (e.g. -255.33 %AM).

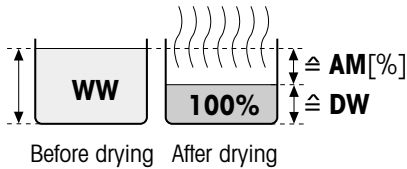

$$AM [0...-1000\%] = - \frac{\text{Wet weight } WW - \text{Dry weight } DW}{\text{Dry weight } DW} * 100\%$$

During the drying, the current measured value is continuously displayed in percent.

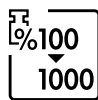
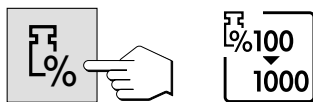

### ATRO dry content (Wet weight)

The wet weight of the sample is displayed (and printed out) as a percentage of the dry weight (= DW = final weight = 100%)

When the results are printed out, the ATRO dry content is marked by “%AD” (ATRO Dry Content) (e.g. 312.56 %AD).

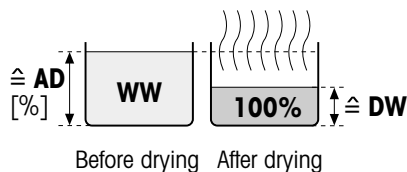

$$AD [100...1000\%] = \frac{\text{Wet weight } WW}{\text{Dry weight } DW} * 100\%$$

During the drying, the current measured value is continuously displayed in percent.

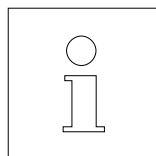

### Comment on the ATRO display mode

If the current measured value in the ATRO display mode is greater or less than the predefined limit value (i.e. greater than 999.99 %AD or less than -999.99 %AM), a warning beep sounds and the instrument automatically switches the display mode (from %AM to %MC and from %AD to %DC). A display in the ATRO mode is no longer possible in this case, even if you have started your drying operation in the %MC, %DC or “g” (grams) display mode. If your measurement series contains such an inadmissible ATRO measured value, the statistical evaluation (see section 5.6) will also be performed in the new, automatically selected mode.



## 4.6 Defining the print interval

**One point before we start:** This setting possibility is available only if the built-in printer is activated in the menu (see section 6.14).

The print interval determines the printout frequency of the intermediate results of an ongoing measurement.

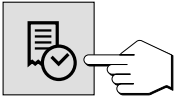

The following settings are available under this function key:

### Printout at intervals

These 6 settings allow printout of the intermediate results at fixed, preset intervals. You can thus trace the drying process using the printed record. The following print intervals are available:

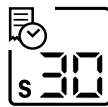

- Printout **every 5 seconds**
- Printout **every 10 seconds**
- Printout **every 30 seconds (factory setting)**



- Printout **every minute**
- Printout **every 2 minutes**
- Printout **every 10 minutes**



### Free print interval

This setting possibility is available only if you have activated it in the menu. You will find information on the activation and definition of the free print interval in section 6.18.

### Manual printout

With this setting there is no automatic printout. However, you can print out the intermediate results at any time with the «Print» key.



## 4.7 Working with the weighing-in aid

The weighing-in aid facilitates weighing in of the sample to a preset weight value (target value). This is particularly useful if you require all the samples you wish to process to have same weight in order to improve the repeatability of the measurement results. In addition, the weighing-in aid can be configured so that the drying process cannot be started if the weight of sample is outside the set tolerance. You are therefore compelled to weigh in the correct quantity of sample („Weighing-in aid active“).

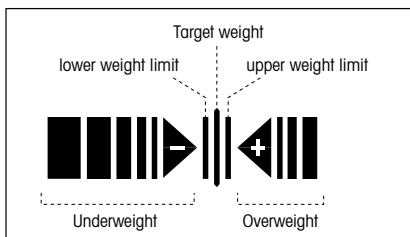

The weighing-in aid in the bottom right corner of the display comprises two opposite facing bars and triangles with a minus or plus symbol.

**The weighing-in aid is available only if it has been activated in the menu.** If the minus or plus symbol is visible after taring, the weighing-in aid is activated. You will find information on how to activate and preset the weighing-in aid in section 6.13.

The procedure for **setting the target weight** depends on the model:

- **HG53:** Place sample with the desired target weight on the pan and then press the «Accept entry» key. The target weight will be adopted.
- **HR73:** Press the «Target weight» key, enter the desired target weight using the numeric keypad (factory setting: 2.5 grams) and confirm with the «Accept entry» key.

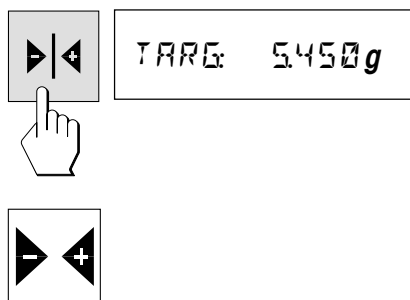

The upper and lower limits for the sample weight are entered in the menu (section 6.13). The factory setting is  $\pm 10\%$  of the target weight.

The symbols of the weighing-in aid appear in the display after you have tared the balance.

### How the weighing-in aid operates

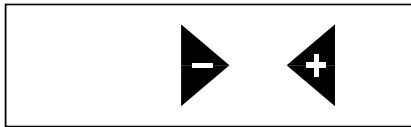

before the start of weighing (standby mode)

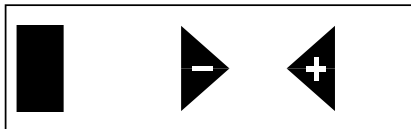

start of weighing (sample weight too low)

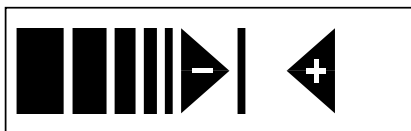

lower weight limit reached (sample weight within tolerance). The status display (user guide) indicates with its flashing 'rising bubble' graphic that the instrument is ready to run.

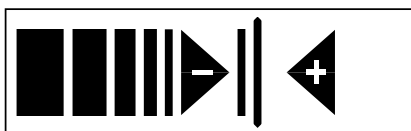

target weight reached (sample weight within tolerance). The status display (user guide) indicates with its flashing 'rising bubble' graphic that the instrument is ready to run.

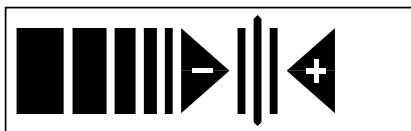

upper weight limit reached (sample weight within tolerance). The status display (user guide) indicates with its flashing 'rising bubble' graphic that the instrument is ready to run.

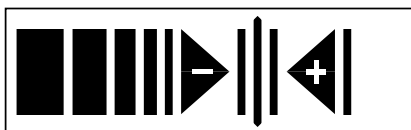

upper weight limit exceeded (sample weight too high)

After initiation of the measurement with the «Start» key, the bars of the weighing-in aid disappear.

## 4.8 Performing a measurement

You are now familiar with all the parameters of your Moisture Analyzer and have defined all values for your sample. The instrument is now ready for the determination of your own samples. In this section you will learn how to perform measurements, print out the measurement results and stop the measurement process.

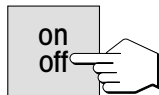

Switch the instrument on with «on/off» key.

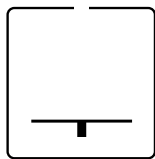

The status display (user guide) symbolizes the initial status of the instrument when the automatic sample chamber is closed.

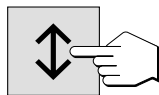

Press the «Open/close auto sample chamber» key and ...

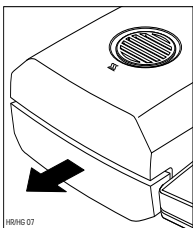

... the automatic sample chamber opens.



Always ensure **sufficient free space in front of the instrument** since the emerging sample chamber could knock over objects in its path or push them off the bench.

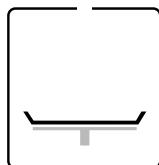

The status display (user guide) now prompts you to load the empty sample pan and tare the balance.

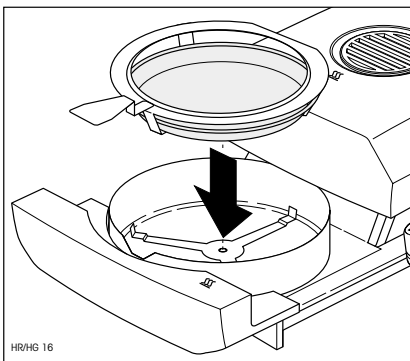

Position the empty sample pan in the sample pan handler. Place the sample pan handler in the automatic sample chamber. Ensure that the tongue of the pan handler lies exactly in the slot of the draft shield element. The pan must lie flat in the pan holder.

**Note:** We advise you to work with the sample pan handler at all times. The pan handler is ergonomic, safe and provides protection against burns due to the hot sample pan.

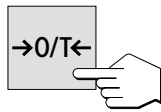

Press the «Tare/zero» key. This sets the integral balance to zero. For taring the automatic sample chamber closes briefly then opens again.

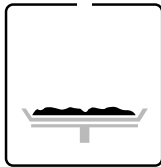

Following taring, the status display prompts you to add the sample to the sample pan.

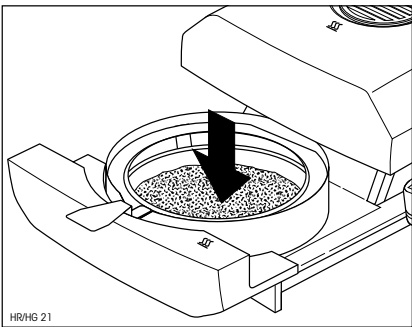

Add the sample to the sample pan. If you are working with the weighing-in aid, weigh the sample (minimum weight 0.1 g) using the bar display as explained in the previous section.

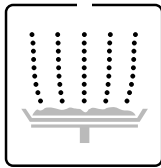

The status display now prompts you to start the drying process.

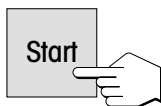

Press the «Start» key and ...

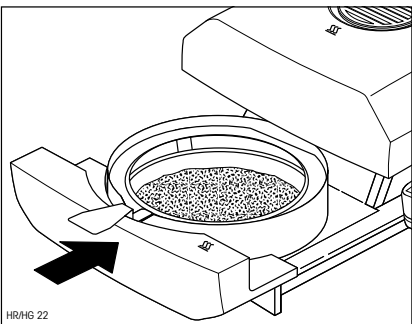

... the motorized, automatic sample chamber closes. The instrument starts the drying and measurement.

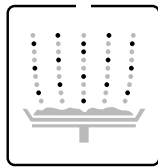

You can follow the measurement process in the display: The status display uses ascending bubbles to symbolize the drying process with the following values being continuously updated and displayed:

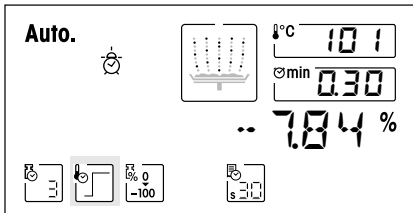

- **current temperature** in the dryer unit  
 Note: You can use the «Drying temperature» key to display the preselected drying temperature (current set temperature) for 2 seconds .
- **elapsed time** since the start of the measurement process  
 Note: If you have selected the switch-off criterion “Timed switch-off”, the elapsed drying time will be displayed. You can display the preselected drying time for 2 seconds with the «Drying time» key.
- **current result** in the preselected display mode.  
 You can select a different display mode with the function key at any time even during the measurement.



If your instrument has the built-in printer and this has been activated, the measured values are printed out at the preselected intervals. You can use the «Print» key to output the intermediate result manually on the printer at any time. The units of the intermediate result are as defined in the preselected display mode and can therefore be changed during the drying process by pressing the «Display mode» function key. You will find an explanation of the measurement record in the next section.

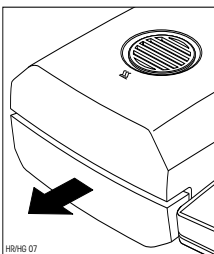

As soon as the preselected switch-off criterion is met (or the selected drying time has elapsed), an audio signal sounds. The measurement process is now ended and the sample chamber automatically opens.



**Warning: Pan and sample may still be hot! Allow them to cool before you remove the pan from the handler!**

**Note:** You can also manually **stop** the measurement process **prematurely** at any time by pressing the «Stop» key. With a measurement time of minimum 30 seconds or more, the result will be printed out at the time of the stop, transferred to the journal (see section 5.5) and incorporated in the statistics (see section 5.6). If you **abort** a measurement process earlier or by using the «Reset» key, the measurement result will not be displayed and also not transferred to the journal or incorporated in the statistics.

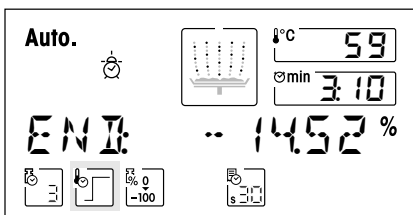

You can now read off the measurement result in the display. You will find information on the interpretation of the measurement results in section 9.1. The result and time display remain at their final values, whereas the temperature continues to be updated.

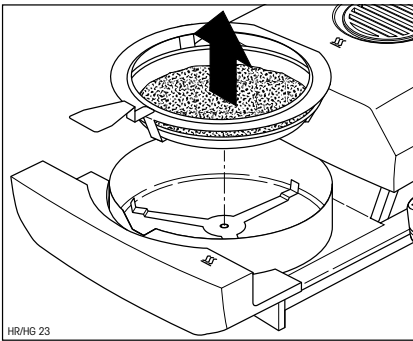

Carefully remove the sample pan handler from the automatic sample chamber.

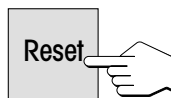

Press the «Reset» key to delete the final result and the time display. The display can also be cleared with the «Tare» key. This facilitates efficient working if the next empty sample vessel has already been loaded.

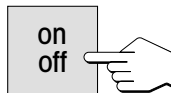
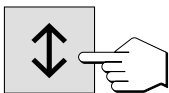

If you do not wish to perform another measurement, switch the instrument off with the «on/off» key. After this operation, the sample chamber automatically closes.

## 4.9 Information on the measurement record

If your instrument has a built-in printer and this is activated in the menu, the intermediate values will be printed out at the preselected intervals and the final result recorded on completion of the measurement.

### The layout of the measurement record

The length and hence the extent of detail of the record depend on the settings selected in the menu (see section 6.16). In the factory, the output of the record is preset to the normal form on which the following description is based.

The illustration on the following page shows a measurement record (example). If you have not worked with the factory settings (e.g. for the print interval, display mode, etc.), your record may differ slightly from that shown.

A	ID	MARGARINE 1
B	BATCH	10.10.95-1
C	Switchoff mode	3
D	Drying temp.	120 °C
E	Weight	2.543 g
F		0...-100 %MC
G	0:00 min	-0.73 %MC
	0:30 min	-1.96 %MC
G	5:30 min	-12.23 %MC
	6:00 min	-15.54 %MC
G	7:30 min	-24.38 %MC
	8:00 min	-24.55 %MC
H	Total time	9:27 min
I	End result	-24.80 %MC
		1.912 g
J		

The record contains the following data (from top to bottom):

- A** name of the selected method (see section 5)
  - B** Comment of the record (see section 4.9)
  - C** selected switch-off criterion (or set drying time)
  - D** drying temperature (set temperature)
  - E** sample weight at start of drying
  - F** selected display mode
  - G** measured value at each print interval (the number of recorded measured values depends on the selected print interval and the measurement time)
  - H** total time of drying
  - I** final result in the selected display mode and the residual weight of the sample in grams
  - J** date and time at the end of the measurement
- Note:** You will find information on the dimensions of the results (%MC, %DC, %AM and %AD) in section 4.5.

**Special events** are recorded in the measurement record as follows:

↕	0:20 min	-0.73 %MC
	0:24 min	--->
	0:28 min	<---
	0:30 min	-0.86 %MC

In the manual operating mode of the automatic sample chamber, the sample chamber was opened and closed during the drying operation. When the automatic sample chamber is open, drying is interrupted and then continued when the chamber is closed.

Reset	7:30 min	-24.38 %MC
	8:00 min	-24.55 %MC
	>>>>>> ABORT <<<<<<<< ----10.10.95---16:26----	

The «Reset» key has been pressed. The drying process is **aborted** and the measurement result at the time of the abort is not evaluated as it could be wrong.

Stop	Total time	8:47 min
	End result	-24.67 %MC
		1.916 g
>>>>>> MANUAL <<<<<<<< ----10.10.95---16:27----		

The drying process has been **stopped manually** with the «Stop» key. The elapsed drying time at the time of the stop and the measurement result are recorded. Please note that with manual stop the final result may possibly be wrong.



## You can add comments to the records

You have the possibility to precede the measurement records with a freely selectable comment, which is printed in the record header.

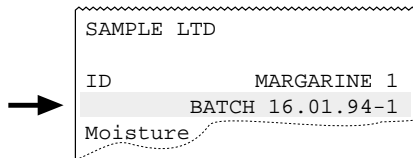

For instance, you can note the name of the user or the number of the batch, the sample, the production machine or the filling head in the record.

The comment can have maximum 20 characters and comprise both letters and figures. Proceed as follows to enter a comment:

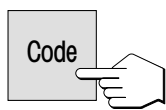

Press the «Code» key. The input field for the comment appears.

If a comment has been entered previously, it appears in the display. The procedure for changing existing comments (e.g. increasing a serial number) is described below. If you want to enter a new comment, or completely overwrite an old one, proceed as follows:

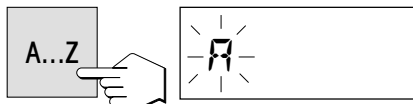

Press the «A...Z» key. A flashing "A" appears at the first input position on the extreme left and signals that the instrument is ready for your entry.

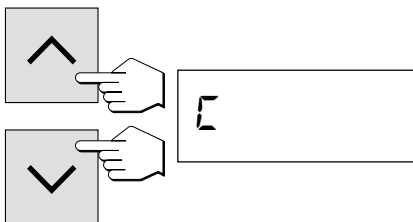

You can now use the «Scroll up» and «Scroll down» keys to select the first letter of the comment (uppercase letters only) or a special character (+, -, etc.) .

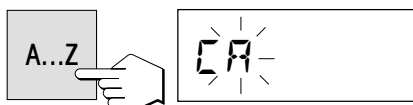

Confirm your selection with the «A...Z» key. The flashing "A" again appears, but at the second position.

Enter a further character of the desired comment as described above.

### Notes

- A space is symbolized by an underline character " \_ " .
- You can remove wrong characters with the «Delete» key and then correct your entry.

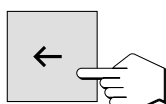

7	8	9
4	5	6
1	2	3
0	.	←

You enter numbers directly using the numeric keypad. Following entry via the numeric keypad, the instrument remains in the numeric input mode and a flashing dash appears at the next input position instead of the flashing "A". To switch back to the text mode, press the «A...Z» key again.

If you want to change an existing comment (e.g. increasing a sample number, entering a serial number), proceed as follows:  
Press the «Code» key. The most recently saved comment appears.

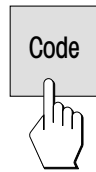

Press the «Delete» key. A flashing dash appears after the last character, indicating input mode.

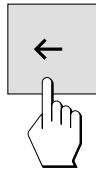

Further characters can now be added directly using the «A...Z» key or the numeric keypad.



By pressing the «Delete» key a second time you can delete the last character. The second last character flashes and can be changed using the numeric keypad or the «Scroll up» and «Scroll down» keys, or confirmed with the «A...Z» key. Further characters can then be added as described above.

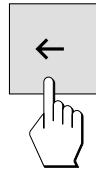

BATCH 15.0

As soon as you have finished entering your comment, press the «Accept entry» key to quit the input mode (the flashing character will also be accepted). From now on your comment will be automatically printed out on each measurement record.

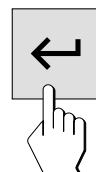

**Note:** By pressing the «Code» key you can display the current comment during the drying for 2 seconds.

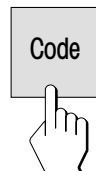

You can delete an existing comment by pressing the «Code» key and then immediately pressing the «Delete» key. Confirm the deletion with the «Accept entry» key. With immediate effect, your records will now be printed out without a comment.

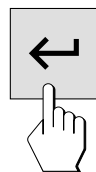
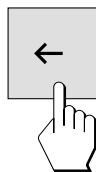
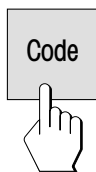

## 5. Methods facilitate your work

Methods simplify and accelerate your daily work. In this section you will learn how you compile, print out and change methods and how to use them. You will also become acquainted with the journal function and the statistics.

### 5.1 What is a method?

Perhaps you remember: In section 4 you became acquainted with all the parameters and setting possibilities you can use to match your Moisture Analyzer to a particular measurement task. If you have to change samples frequently during your work, the methods save you having to reenter the parameters and preclude wrong settings. Methods thus make it easier for you to switch between different types of samples.

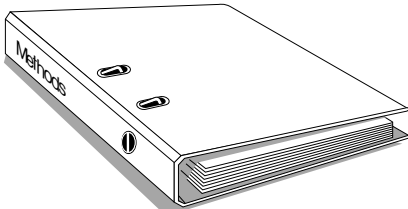

Methods	1
	2
	3
	4
	5
	6
	7
	8
	9
	10
	11
	12
	13
	14
	15
	16
	17
	18
	19
	20

Margarine 1	4
Drying prog.: Standard drying	
Drying temp.: 70 °C	
Switch-off criterion: Loss < 1 mg/50 sec.	
Drying time: -----	
Display mode result: MC (moisture content)	
Print interval: 30 sec.	
Target weight: 2.500 g	

A method contains all **settings** for a particular sample. It can be recalled at a keystroke and your instrument immediately operates with the corresponding settings. You have 20 methods freely available.

The following parameters, which you have already learned in section 4, form part of a method:

- Drying program
- Drying temperature
- Switch-off criterion
- Drying time (depends on switch-off criterion)
- Display mode
- Print interval
- Target weight for weighing-in aid

Each method has its own measured value journal and its own measured value statistics.

You will find information on the journal and statistics in sections 5.5 and 5.6.

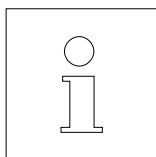

Work with methods is divided into two stages: in the **setting stage** you define the parameters of the method and name the method. In the **utilization stage** you perform routine measurements with different samples. When switching from one sample to the next, you do not have to change any settings, you need simply select the method suitable for the sample. You will find information on how to use and set up of methods in the following sections.

## 5.2 Recalling a method

To activate all settings for a particular sample, simply call up the associated method. After recall of the method, all appropriate settings become immediately active.

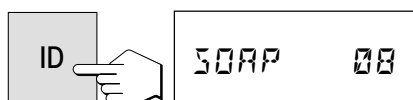

To recall an existing method (consult the next section for information on how to compile methods), proceed as follows:

Press the «ID» key. The designation of the method currently active appears in the display.

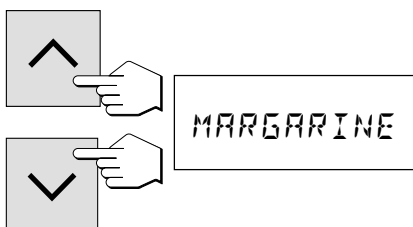

Now use the «Scroll up» and «Scroll down» keys to select the method. Then press the «Accept entry» key.

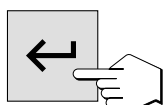

All settings of the selected method are now active and you can immediately perform your measurement. If you press the «ID» key during the measurement, the designation of the active method will be displayed for 2 seconds. This designation will also be printed out in the header of the measurement record.

## 5.3 Naming, compiling or changing methods

When you put your Moisture Analyzer into operation for the first time, all 20 methods are identical and are allotted the factory setting for all parameters. You can change the parameters of a method at any time (except when a measurement is running or the settings are protected against change as described in section 6.11).

The compilation of a new or the modification of an existing method comprises 3 steps:

- Selection of the method
- Entry of the method name
- Selection of the settings

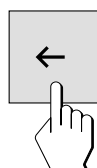
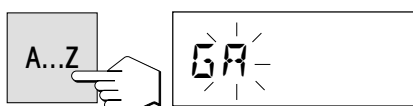
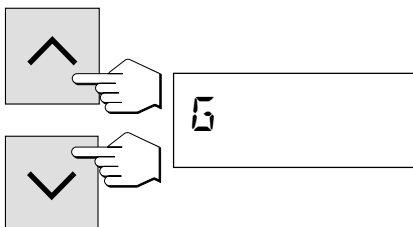
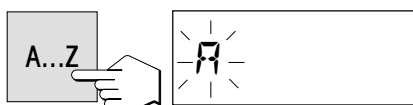
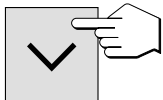
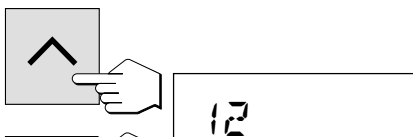
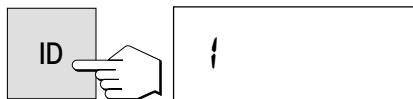

### Selecting a method

Press the «ID» key. The designation of the method currently active appears in the display. The methods have been designated the numbers 1 to 20 in the factory and these can be replaced by a name.

Now use the «Scroll up» and «Scroll down» keys to select the method you wish to name, recompile or change. The illustrations show the method for naming and compiling a new method which should be assigned the name "Glue type B" .

### Naming a method

To name a method press the «A...Z» key. A flashing "A" appears at the first input position on the extreme left and signals that the instrument is ready for your entry. The procedure for changing an existing method name, without needing to enter the new name completely, is described later.

You can now use the «Scroll up» and «Scroll down» keys to select the first letter of the designation (uppercase letters only) or a special character (+, -, etc.).

Confirm your entry with the «A...Z» key. The flashing "A" reappears, but at the second position. Enter the additional characters of the desired method name as described above.

#### Notes:

- A space is symbolized by the underline character " \_ " .
- You can remove wrong characters or numbers with the «Delete» key and then correct your entry.
- You enter numbers directly using the numeric keypad. After entry via the numeric keypad, the instrument remains in the numeric input mode and a flashing dash appears at the next input position instead of the flashing "A" . To switch back to the text mode, press the «A...Z» key again.

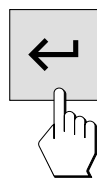
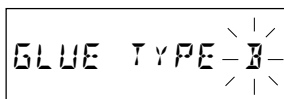
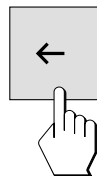
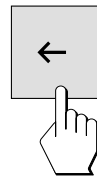
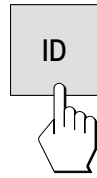

If you want to change an existing method name (e.g. entering a serial number), proceed as follows:

Press the «ID» key. The designation of the currently active method flashes in the display.

Press the «Delete» key. A flashing dash appears after the last character, indicating input mode.

Further characters can now be added directly using the «A...Z» key or the numeric keypad.

By pressing the «Delete» key a second time you can delete the last character. The second last character flashes and can be changed using the numeric keypad or the «Scroll up» and «Scroll down» keys, or confirmed with the «A...Z» key. Further characters can then be added as described above.

As soon as you have finished entering the designation, press the «Accept entry» key to quit the input mode (the flashing character is also accepted).

### Selecting the settings

The selected method is now ready for the entry or change of the parameters.

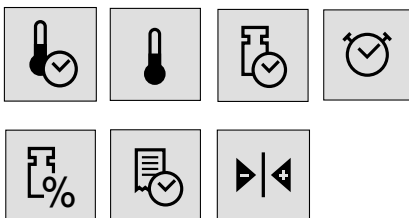

Now use the appropriate keys to match the following parameters to your measurement task:

- Drying program
- Drying temperature
- Switch-off criterion
- Drying time (dependent on switch-off criterion)
- Display mode
- Print interval
- Target weight for weighing-in aid

Please consult section 4 for the meaning of the individual parameters and details on how to proceed.

All settings are assigned to the selected method and **automatically stored**.

After you have completed all settings, your instrument is ready for measurement with the new or changed method.

**Notes:**

- The methods can be protected in the menu against changes (see section 6.11).
- We advise you to define a special method for test purposes, e.g. with the name "Test". You can always change the settings of this method to test the individual parameters without altering the methods you have already defined.

## 5.4 Printing out methods

To ensure you do not lose your overview of the 20 methods, you can:

- print out a list of all methods or
- record the parameters of a particular method.

**Please note that these print functions are available only in the standby mode of the instrument and not during a measurement.**

### How to print out a list of all methods



Press the «ID» key.

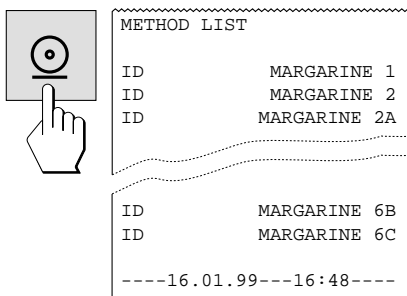

Press the «Print» key. The list with the designations of all methods will be printed out.

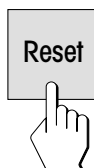

After the list has been printed out, press the «Reset» key to return the instrument to the standby mode.

### How to print out the settings of a particular method

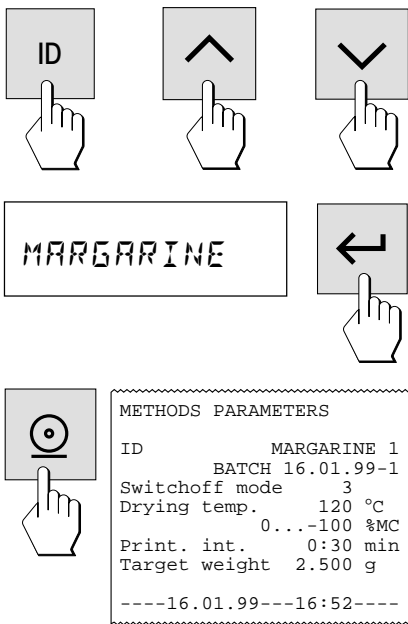

Call up the desired method (if not already active): Press the «ID» key and select the method with the «Scroll up» and «Scroll down» keys.

Confirm your selection with the «Accept entry» key.

Press the «Print» key. A list of all parameters of the active method will be printed out. Please consult section 4 for the meaning of the individual parameters and settings.

## 5.5 Measured value journal

The journal function always provides you with an overview of the last 20 final results of each method.

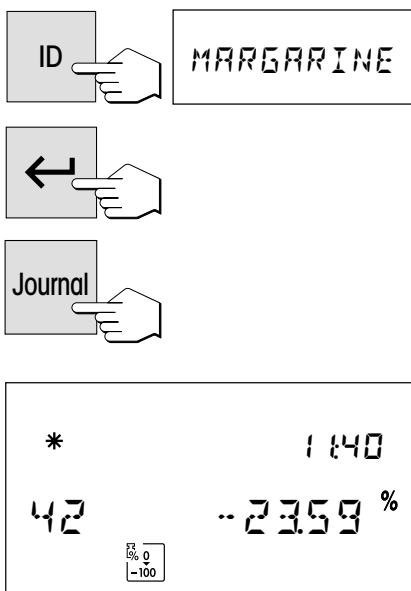

Select the method whose measured value journal you wish to view.

Confirm your selection with the «Accept entry» key.

Press the «Journal» key and ...

... the display shows the data of the measurement last performed. The following data are shown for every measurement:

- the time of the measurement
- the consecutive number of the measurement (serial number)
- the final result (the asterisk symbol in the top left corner of the display signals that the result has been calculated)
- the selected display unit, which can be changed. If “grams” have been selected as the display unit, the dry weight is displayed.



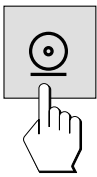
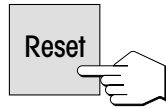
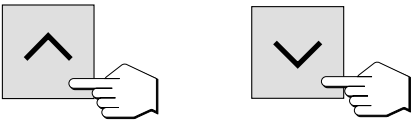

JOURNAL	
ID	MARGARINE 1
14.01.94 / 16:30	
23	-24.83 %MC
14.01.94 / 17:05	
24	-26.21 %MC
15.01.94 / 08:12	
25	-21.65 %MC
-----	
16.01.94 / 11:42	
42	-23.59 %MC
-----10.10.95---16:54-----	

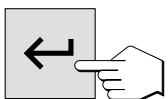

You can use the «Scroll up» and «Scroll down» keys to view the data of the other recorded measurements in turn.

**Note:** With the «Reset» key you can terminate the display of the measured value journal at any time (the measured values will not be deleted).

If your instrument is equipped with a built-in printer, you can print out the entire journal on the printer with the «Print» key. In addition to the data in the display, the date of every measurement will be printed out.

After pressing the «Accept entry» key you are asked if you wish to clear the measured value journal.

The suggested answer is "NO". If you do not wish to clear the measured value journal, press the «Accept entry» key now to confirm your selection and quit the journal display. The journal will continue to be kept with the measured values already recorded.

If you wish to clear the journal, use the «Scroll up» or «Scroll down» key to select the response "YES".

Then press the «Accept entry» key to confirm your selection. The existing journal will be cleared and a new journal created.

## 5.6 Measured value statistics

Your Moisture Analyzer keeps measured value statistics for each of the 20 methods. The measurement results of each method are continuously recorded and transferred to the statistics. The statistics are updated until they are cleared. After clearance, a new set of measured value statistics is created.



Select the method whose measured value statistics you wish to view.

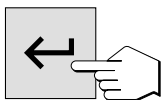

Confirm your selection with the «Accept entry» key.



Press the «Stat.» key and ...



... the display shows the first value of the statistics (the number of measurement results).

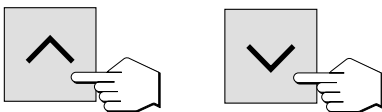

You can use the «Scroll up» and «Scroll down» keys to view the additional data of the measured value statistics in turn.

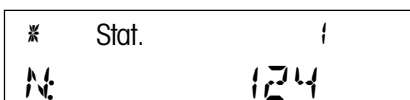

The individual values have the following meaning:

**Number of measurement results** recorded in the statistics (maximum 9999). The run number on the full records (see section 6.16) corresponds to the number of measurement results (sample size).

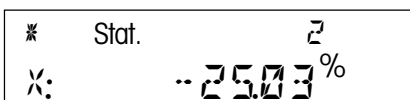

**Mean value of all measurements** in the selected display unit:

$$\bar{x} = \frac{1}{n} \sum_{i=1}^n x_i$$



**Standard deviation** in the selected display unit:

$$s = \sqrt{\frac{1}{n-1} \sum (x_i - \bar{x})^2}$$

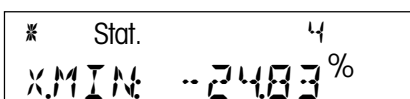

**Lowest recorded measurement result.**

```
* Stat.      5
X.MAX:  -25.16 %
```

```
* Stat.      6
DIFF:    0.33 %
```

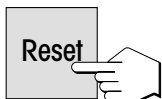

```

STATISTICS
ID          MARGARINE 1
1.N Number      124
2.X̄ Mean val.  -25.03 %MC
3.S Std. dev.   0.35 %MC
4.X min        -24.83 %MC
5.X max        -25.16 %MC
6.Difference    0.33 %MC
----10.10.95---16:58----
```

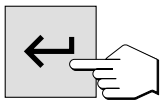

```
CLEAR:  NO
```

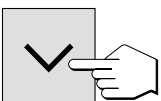

```
CLEAR: VALUE
```

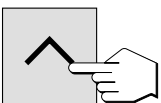

```
CLEAR:  YES
```

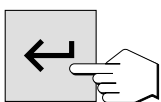

### Highest recorded measurement result.

**Absolute difference** between highest and lowest result.

**Note:** You can press the «Reset» key to terminate the display of the measured value statistics at any time (the measured values will not be deleted).

If your instrument is equipped with a built-in printer, you can print out all statistical data of the current method on the printer with the «Print» key.

After pressing the «Accept entry» key, you are asked if you wish to clear the measured value statistics.

The «Scroll up» or «Scroll down» key offers the following possibilities:

“NO”: The measured value statistics will not be cleared, but continued with the measured values already recorded.

“Value”: The measured value last recorded in the statistics will be deleted and the statistics will be continued with the remaining values. This allows you to delete wrong measurements. The deletion must be performed before the next value is recorded as only the last value is deleted!

“YES”: All the existing measured value statistics will be completely cleared and a new set of statistics created.

Select the desired option and then press the «Accept entry» key to confirm your selection and quit the statistics display.

## 6. The menu (basic settings of the instrument)

In this section you will learn how to use the menu to define the settings your instrument uses for operation. You will also learn how to calibrate the built-in balance and the dryer unit.

### 6.1 Menu operation

The menu is a list of selection possibilities which you can use to preselect the **basic setting** of your instrument. The menu comprises various items (you will find a graphical overview of all menu items in sections 6.21 and 6.22). In addition to the **settings**, which are numbered for the sake of clarity, certain **functions** (e.g. the weight adjustment and the temperature adjustment) can also be implemented in the menu. All menu settings are retained even on power failure.

Using the menu is simple:

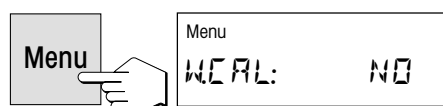

Press the «Menu» key to call up the menu. You are now directly in the first menu item (adjustment of the balance). As long as you are working in the menu, the word "Menu" is lit up in the display.

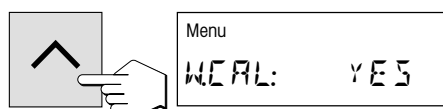

You can use the «Scroll up» and «Scroll down» keys to switch between the selection possibilities within the current menu items and hence select the desired setting or execute the particular function.

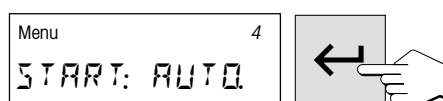
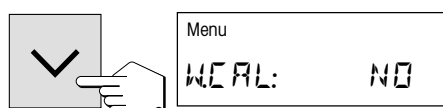

When you have set your desired option in a menu item, press the «Accept entry» key to store the setting and call up the next menu item.

**Note:** After a weight or temperature adjustment has been performed, the instrument automatically quits the menu and returns to the standby mode.

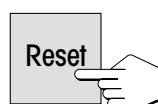
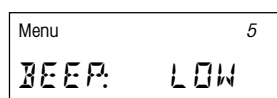

When you have set all desired options, press the «Reset» key to quit the menu. All settings which you have confirmed with the «Accept entry» key are now active.

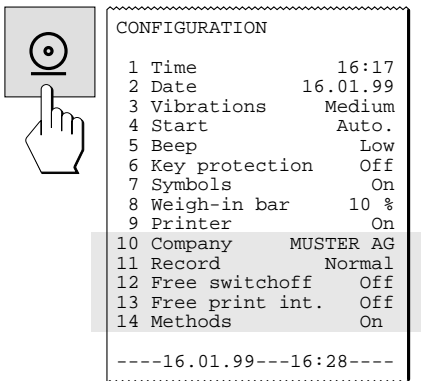

If your instrument is equipped with a built-in printer, you can record all menu settings. Simply press the «Print» key at any position in the menu.

The following sections will acquaint you with the individual menu items. The order corresponds exactly to that in the menu.

## 6.2 Adjusting the balance

In this menu item you can adjust the balance of your instrument. Consult section 3.2 to learn when an adjustment is necessary. Before selecting the adjustment function, ensure that the sample pan is in position. Following a drying, you should wait at least 30 minutes before undertaking an adjustment.



**The factory setting in this menu item is "NO"** (no weight adjustment).

**Note:** The number above the word "NO" shows the number of adjustments performed to date.



If you wish to adjust the integral balance, select "YES" (using the «Scroll up» or «Scroll down» key).

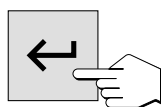

Press the «Accept entry» key to start the adjustment process. The sample chamber automatically opens.

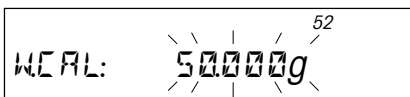

The display now requests the required adjustment weight by flashing its value.

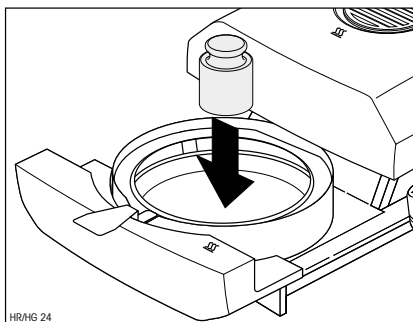

Place the requested adjustment weight in the middle of the sample pan. The weight is automatically recorded.

**Note:** An adjustment weight of 50 grams is used for adjustment. The adjustment weight is available as optional equipment (see section 9.7).

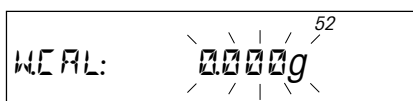

The instrument stores the determined weight value and the display prompts you to lift off the adjustment weight.

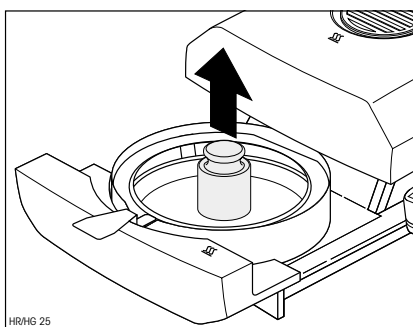

Remove the adjustment weight.

This concludes the adjustment of the balance and the instrument automatically quits the menu and returns to the standby mode. The Moisture Analyzer is now ready for further measurements.

If your instrument is equipped with the built-in printer and this is activated (see section 6.14), on completion of the weight adjustment an adjustment record will be automatically printed out with the following data:

A	WEIGHT CALIBRATION	52
B	Date:	16.01.99
C	Time:	14:37:55
D	METTLER TOLEDO Halogen MoistureAnalyzer Type:	HR73
E	SNR:	1113127068
F	SW:	1.10
G	Reference Weight:.....	
H	Weight:	50.000 g
I	Calibration performed	
J	User signature:	
	.....	
	-----	END

**A** Record title and consecutive number of the weight adjustment

**B** Date of the weight adjustment

**C** Time of the record printout

**D** Designation and type of the instrument

**E** Serial number of the instrument

**F** Version number of the software

**G** Line for entry of the number of the adjustment weight used

**H** Adjustment weight used

**I** Confirmation that the weight adjustment has been performed correctly

**J** Field for signature of the person who performed the adjustment

Please enter the number of the adjustment weight used, sign the record and store it in a safe place. This assures traceability, one of the basic requirements of every quality assurance system.

## 6.3 Adjusting the dryer unit

In this menu item you can adjust the temperature control of the dryer unit. Consult section 3.2 to learn when an adjustment of the dryer unit is necessary. We advise you to wait 30 minutes after a drying before performing the adjustment.

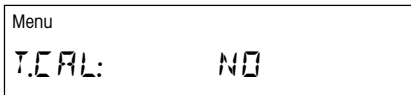

**The factory setting in this menu item is "NO"** (no temperature adjustment).

**Note:** The number above the word "NO" shows the number of adjustments performed to date.

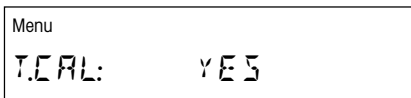

If you wish to adjust the dryer unit, select "YES" (using the «Scroll up» or «Scroll down» key).

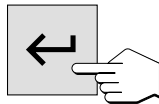

Press the «Accept entry» key to start the adjustment process. The sample chamber automatically opens and you are prompted to insert the adjustment disk.

**Note:** The adjustment disk with its thermometer is available as optional equipment (see section 9.7).

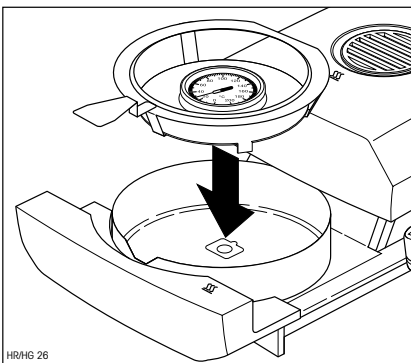

Remove the pan holder from the automatic sample chamber.

Insert the adjustment disk in the sample pan handler.

Place the sample pan handler in the automatic sample chamber.

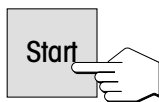

Press the «Start» key to initiate the adjustment process. The automatic sample chamber closes and the temperature adjustment starts.

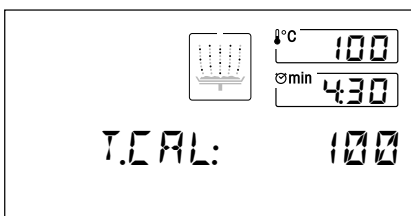

The dryer unit is heated to a temperature of 100 °C . You can follow this process in the temperature display. The instrument now waits 15 minutes until the thermometer of the adjustment disk shows the correct temperature, a continuous audio signal then sounds.

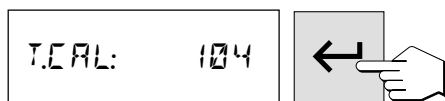

Read the thermometer through the inspection window of the dryer unit and enter this temperature using the «Scroll up» and «Scroll down» keys (or via the numeric keypad) (please note: 1 graduation mark = 2 °C). After entering the value, press the «Accept entry» key. The temperature must be entered within 10 minutes of the audio signal sounding, otherwise the adjustment process will be terminated and an error message outputted

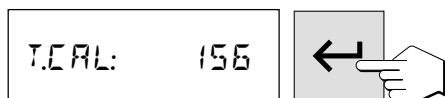

As this adjustment is a two-point adjustment (adjustment of the temperature is defined by two points, namely 100 °C and 160 °C), the dryer unit now heats to the second temperature (160 °C) . Proceed exactly as you did for the first temperature. After you have confirmed your entry with the «Accept entry» key, the adjustment is at an end. On completion of the adjustment, the sample chamber automatically opens and you can remove the sample pan handler with the calibration disk.



Warning: As the thermometer and calibration (adjustment) disk can still be hot, allow them to cool down before you remove them from the handler.

On completion of the temperature adjustment, the instrument automatically quits the menu and returns to the standby mode. It is now ready for further measurements.

If your instrument is equipped with the built-in printer and this is activated (see section 6.14), on completion of the temperature adjustment an adjustment record will be automatically printed out with the following data:

A	TEMPERATURE CALIBN	23
B	Date:	16.01.99
C	Time:	14:37:55
D	METTLER TOLEDO Halogen MoistureAnalyzer Type:	HR73
E	SNR:	1113127068
F	SW:	1.10
G	Temp Reference ID:.....	
H	Temperature 100°C:	102°C
I	Temperature 160°C:	159°C
J	Calibration performed	
K	User signature:	
	.....	
	-----	END

- A** Record title and consecutive number of the temperature adjustment
- B** Date of the temperature adjustment
- C** Time of the record printout
- D** Designation and type of the instrument
- E** Serial number of the instrument
- F** Version number of the software
- G** Line for entry of the number of the temperature adjustment disk used (Serial-Number of thermometer is printed on dial)
- H** Target and actual temperature for the first adjustment point
- I** Target and actual temperature for the second adjustment point
- J** Confirmation of the adjustment
- K** Field for signature of the person who performed the temperature adjustment

Enter the number of the adjustment disk, sign the record and store it in a safe place. This assures traceability, one of the basic requirements of every quality assurance system.



## 6.4 Resetting to the factory settings

In this menu item you have the possibility to reset the basic settings of the instrument to the factory setting.



**Warning! With the exception of the time, date and dialog language, all individual settings (incl. the method memory) you have made in the menu will be lost and replaced by the factory settings!**

**Journal and statistics data will be deleted.**

Menu  
FCT.SET: NO

**The factory setting in this menu item is "NO".** If you really wish to delete your individual menu settings, select "YES" and confirm this with the «Accept entry» key.

Menu  
FCT.SET: YES

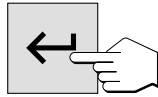

Menu  
ABORT?

For reasons of safety, you are again asked if you really wish to delete your data. You can abort the procedure at this point or delete the data, i.e. reset to the factory settings. Confirm your selection with the «Accept entry» key.

Menu  
SET?

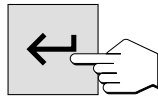

## 6.5 Clearing the method memory

The method memory contains the individual settings for your measurements (switch-off criterion, display mode, print interval, etc.) and the results of your measurements (statistics, journal). This menu item allows the method memory to be cleared. Your settings will be replaced by the factory settings and statistics and journal will be cleared.



**Warning! If the method memory is cleared, you will lose all individual settings with the exception of the settings in the menu!**

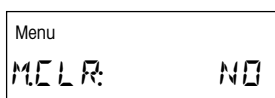

**The factory setting in this menu item is "NO".** If you really wish to clear the method memory, select "YES" and confirm this with the «Accept entry» key.

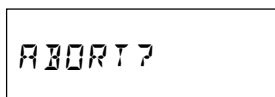
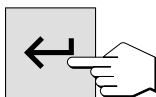
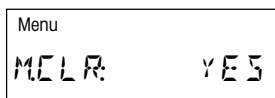

For reasons of safety, you are again asked whether you really wish to clear the method memory. You can abort the procedure at this point or clear the memory. Confirm your selection with the «Accept entry» key.

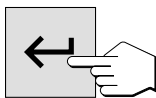
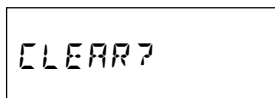

## 6.6 Setting the time

In this menu item you enter the current time. This is necessary when putting your instrument into operation for the first time and for possible corrections (e.g. changeover from summer to winter time).

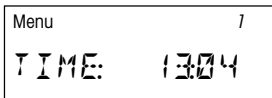

Set the time with the «Scroll up» and «Scroll down» keys (or by using the numeric keypad) (Range 00:00–23:59).

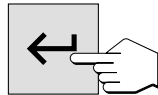
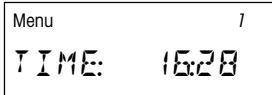

Confirm your setting with the «Accept entry» key and the instrument stores the time.

## 6.7 Entering the date

In this menu item you enter the current date. This is necessary when putting the instrument into operation for the first time and for possible corrections.

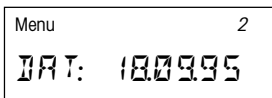

Set the date with the «Scroll up» and «Scroll down» keys (or by using the numeric keypad) in the format “Day – Month – Year” (DD.MM.YY). Confirm your entry with the «Accept entry» key and your instrument stores the date.

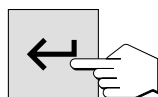
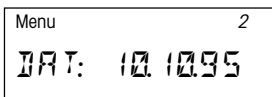

**Note:** If US English is used as the dialog language, the entry has the format “Month – Day – Year” (MM/DD/YY).

## 6.8 Setting the vibration adapter

You can use the vibration adapter to match your instrument to the ambient conditions at its location.

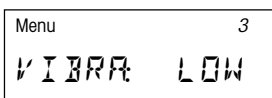

The following settings are available:

Setting for very stable ambient conditions. The instrument operates quickly but is sensitive to vibrations.

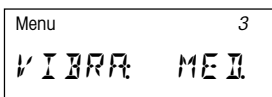

Setting for normal ambient conditions. This is the **factory setting**.

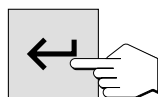
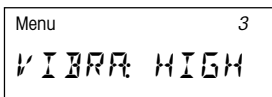

Setting for unstable ambient conditions. The instrument operates more slowly but is less sensitive to vibrations.

Select the appropriate setting and confirm your selection with the «Accept entry» key.

## 6.9 Selecting operating mode of the automatic sample chamber

In this menu item you can choose whether the **automatic sample chamber** should operate **automatically** or **manually**. Your instrument is set in the factory to the automatic operating mode. We advise you to use the manual operating mode for samples which contain readily volatile substances. In contrast to the automatic operating mode, in the manual operating mode the sample chamber does not automatically close when the «Start» key is pressed. However, the initial weight (wet weight) important for the determination of the moisture content is recorded. In the manual operating mode you have time for further preparation of the sample (e.g. mixing with quartz sand or even distribution of the sample) while weight losses due to evaporation during the preparation time are measured from the outset. As soon as the sample is ready for drying, press the key «Open/close auto sample chamber». The automatic sample chamber closes and drying starts. In the manual operating mode you yourself can open the sample chamber during a drying operation. In contrast to the automatic mode, drying will not be stopped but simply interrupted until the automatic sample chamber is closed again.

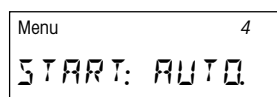

**The factory setting in this menu item is "AUTO."** (automatic operating mode). If you wish to switch to the manual operating mode, select "MAN." and confirm this with the «Accept entry» key.

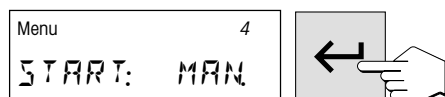

## 6.10 Audio signal

Many processes are signalled by an audio signal (e.g. end of drying, entries, error messages, etc.). In this menu item you can select whether the audio signal should be loud, soft or switched off.

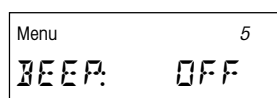

The following settings are available:

no audio signal

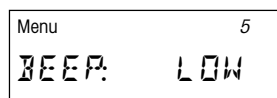

soft signal. This is the **factory setting**

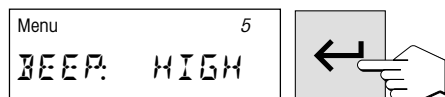

loud signal

Select the desired setting and confirm with the «Accept entry» key.



**Note:** The alarm clock symbol in the display indicates that an audio signal has been activated in the menu.

## 6.11 Protecting your settings against change

You can protect the settings of your operating parameters (e.g. switch-off criterion, drying temperature, etc., see section 4) against change by locking the appropriate keys for entries.

This also protects the statistics and the journal against clearance.

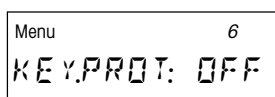

**The instrument is set in the factory to allow the parameters to be changed ("PROT: OFF").**

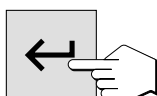
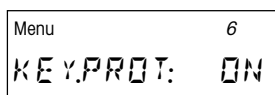

If you wish to protect the settings against change, selection "PROT: ON" and confirm this with the «Accept entry» key.



The display shows the padlock symbol and the following settings can then no longer be changed:

- Switch-off criterion
- Drying program
- Display mode
- Print interval
- Drying temperature
- Drying time
- Target weight of the weighing-in aid

If you press one of the locked keys, an audio signal and an error message (see section 8.2) draw your attention to the nonavailability of the corresponding function.

## 6.12 Superimposing or removing the function symbols

In this menu item you can select whether the function symbols should always be visible or only when needed. In routine operation, the display is easier to survey if the symbols are faded out.

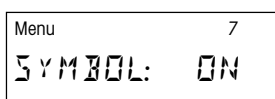

**In the factory the symbols are switched on ("ON").**

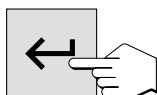
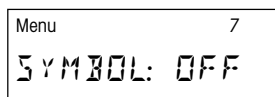
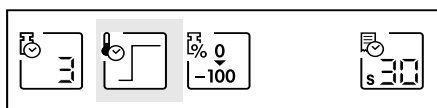

If you wish to switch off the symbols, select "OFF" and confirm this with the «Accept entry» key.

**Note:** If you switch off the function keys, they will be displayed for around 30 seconds when the instrument is switched on and then faded out. If one of the function keys is pressed, the function symbols will be shown immediately and then faded out again 30 seconds after a function key has last been pressed.

## 6.13 Switching the weighing-in aid on or off

In this menu item you can switch the weighing-in aid on or off and define the sample weight limits. You became acquainted with the weighing-in aid in section 4.7.

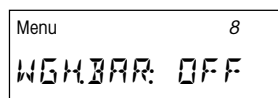

**In the factory the weighing-in aid is switched off ("OFF").**

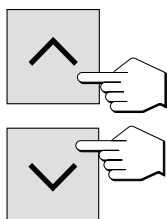

If you want to switch on the weighing-in aid, you can use the «Scroll up» and «Scroll down» keys to select either the "Weighing-in aid passive" or "Weighing-in aid active" setting.

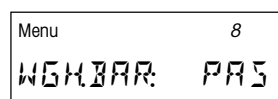

If the "Weighing-in aid passive" setting is selected, the weighing-in aid is switched on and a target weight can be defined (section 4.7). With this setting the drying process can be started even if the sample weight lies outside the set limits. These are defined by the target weight (section 4.7) and the sample weight tolerance as a % of the target weight (see below).

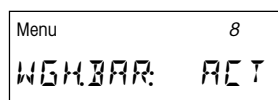

With the weighing-in aid set at "Weighing-in aid active" the drying process cannot be started if the sample weight is outside the set limits. You are therefore compelled to weigh in the correct quantity of sample, and are prevented from inadvertently starting the drying process with the wrong sample weight.

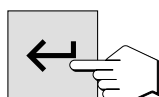

After selecting the desired mode for the weighing-in aid, confirm your selection by pressing the «Accept entry» key.

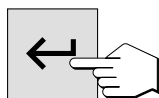
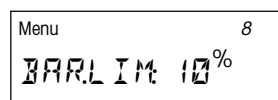

You can now use the «Scroll up» and «Scroll down» keys (or the numeric keypad) to define the sample weight tolerance in the range 1% to 25%. The sample weight tolerance (factory setting: 10%) defines the lower and upper sample weight limits. Confirm your entry with the «Accept entry» key.



When the weighing-in aid is switched on, two triangles with the minus and plus symbol appear in the bottom right corner of the display as soon as the instrument is ready for weighing-in.

## 6.14 Switching the printer on or off

In this menu item you can switch the built-in printer on or off.

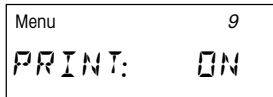

**In the factory this item is switched on ("ON").**

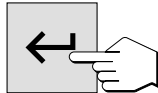
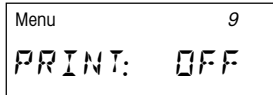

If you wish to switch the printer off, select "OFF" and confirm this with the «Accept entry» key.

## 6.15 Entering company name for printed records

In this menu item you can define whether the name of your company (or any other text, e.g. the name of the department) should appear at the very top of the printout in the record header.

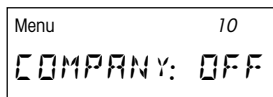

**In the factory this item is switched off ("OFF").**

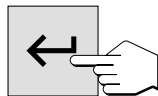
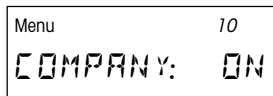

If you wish to print your company name, select "ON" and confirm this with the «Accept entry» key.

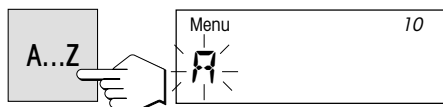

Now enter the name: press the «A...Z» key. A flashing "A" appears at the first input position on the extreme left and signals that the instrument is ready for your entry.

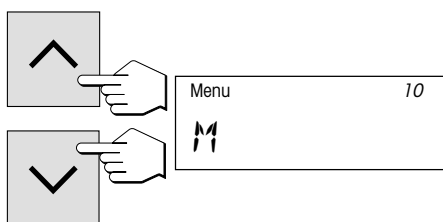

You can now use the «Scroll up» and «Scroll down» keys to select the first letter of the name (uppercase letters only) or special characters (+, -, etc.).

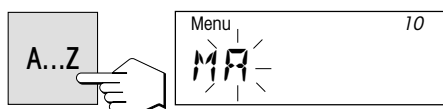

Confirm your selection with the «A...Z» key. The flashing "A" now reappears, but at the second position.

Enter the remaining characters of the desired name (up to 20 characters) as described above.

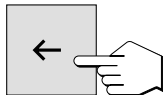

**Notes**

- A space is symbolized by the underline character “\_” .
- You can remove wrong characters with the «Delete» key and then correct your entry.
- You enter numbers directly using the numeric keypad. Following an entry via the numeric keypad, the instrument remains in the numeric input mode and a flashing dash appears at the next input position instead of a flashing “A”. To switch back to the text mode, press the «A..Z» key again.

As soon as you have finished entering the name, press the «Accept entry» key.

The inputted name appears with immediate effect on the record assuming you have selected the full record (see next section).

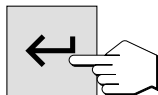
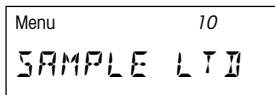

## 6.16 Selecting the type of record

In this menu item you decide the length and hence the extent of detail of the measurement records.

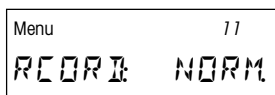

**In the factory setting, normal records (“NORM.”) are printed out.** You will find the normal record explained in section 4.9.

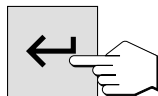
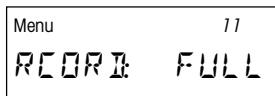

If you wish for more detailed measurement records, select “FULL” and confirm this with the «Accept entry» key.



A	SAMPLE LTD		
	ID	MARGARINE 1	
		BATCH 16.01.99-1	
B	Moisture Analyzer	1.10	
C	SNR:	1113127068	
D	Weight calibration	52	
E	Temperature calibrn	23	
F	Series No.	12	
	Switchoff mode	3	
	Step drying	120 °C	
	Weight	2.543 g	
		0...-100 %MC	
	0:00 min	-0.73 %MC	
	0:30 min	-1.96 %MC	
G	Temperature 1	80 °C	
H	Time	5:00 min	
I	Result	-7.85 %MC	
J		2.343 g	
	5:30 min	-12.23 %MC	
	6:00 min	-15.54 %MC	
G	Temperature 2	100 °C	
H	Time	7:00 min	
I	Result	-22.51 %MC	
J		1.971 g	
	7:30 min	-24.38 %MC	
	8:00 min	-24.55 %MC	
	Total time	9:27 min	
	End result	-24.80 %MC	
		1.912 g	
	----	16.01.99	16:42

In addition to the data provided in the normal records (see section 4.9), the full records contain the following information:

- A** Company name (see previous section)
- B** Designation of the instrument and version number of the software
- C** Serial number of the instrument
- D** Identification (consecutive number) of the weight calibration, allows assignment of the measurement record to the appropriate calibration record
- E** Identification (consecutive number) of the temperature calibration, allows assignment of the measurement record to the appropriate calibration record
- F** Consecutive number of the measurement (corresponds to the sample size or the number of measurement results in the statistics)
- G** Set temperature for every step (only in step drying)
- H** Hold time for every step (only in step drying)
- I** Intermediate result for every step in the selected display unit (only in step drying)
- J** Intermediate result for every step in grams (residual weight of the sample, only in step drying)

## 6.17 Defining the free switch-off criteria

You have already met the preselected switch-off criteria in section 4.4. If none of the five available switch-off criteria "Weight loss per unit of time" is suitable for your application, the Moisture Analyzer allows you to define a free switch-off criterion. The free switch-off criterion is also based on the principle of the mean weight loss per unit of time. As soon as this drops below the preset value, the measurement is automatically ended.

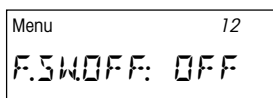

**In the factory the free switch-off criterion is deactivated ("OFF").**

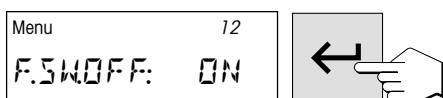

If you wish to define a free switch-off criterion, select "ON" and confirm with the «Accept entry» key.

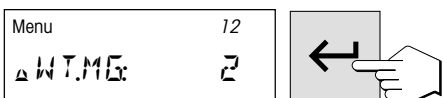

Now enter the weight loss (1 mg to 10 mg) using the «Scroll up» and «Scroll down» keys or the numeric keypad. Confirm your entry with the «Accept entry» key.

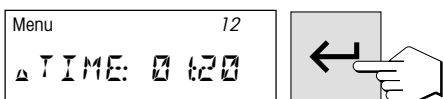

Now enter the time (5 seconds to 3 minutes) to which the weight loss refers. Confirm your entry with the «Accept entry» key.

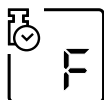
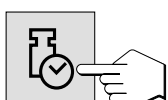

The free switch-off criterion is now available with its own symbol under the function key «Switch-off criterion» (in the example a mean weight loss of 2 mg per 1:20 minutes is defined).

**Note:** You will find additional information on the free switch-off criterion in section 9.4.

## 6.18 Defining the free print interval

You became familiar with the preselected print intervals in section 4.6. If the preselected values are not suitable for your application, you can define a free print interval in this menu item.

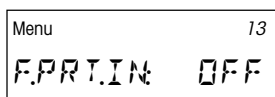

**In the factory the free print interval is deactivated ("OFF").**

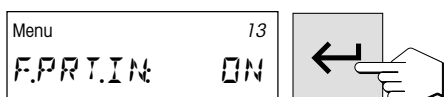

If you wish to define a free print interval, select "ON" and confirm this with the «Accept entry» key.

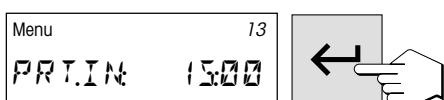

Now enter the desired print interval using the «Scroll up» and «Scroll down» keys or the numeric keypad (between 5 seconds and 60 minutes). Confirm your entry with the «Accept entry» key.



The free print interval is now available with its own symbol under the function key «Print interval».

## 6.19 Switching the method option on or off

If you do not wish to work with methods (see section 5), you can switch off the method options in this menu item. This simplifies operation of the instrument if you work only with one type of sample and consequently do not require the possibilities offered by the methods.

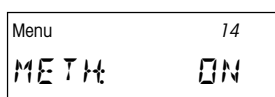

**In the factory the method option is switched on ("METH: ON").**

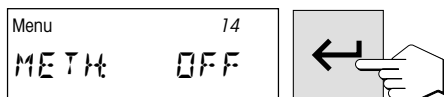

To switch the method option off, select "METH: OFF" and confirm this with the «Accept entry» key. You now no longer have the possibilities of the method option available.

## 6.20 Selecting the dialog language

In this menu item you specify the dialog language.

Menu  
DEUTSCH

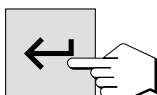

Select the desired dialog language and then confirm your entry with the «Accept entry» key.

Menu  
FRANCAIS

The following languages are available:

- German (“Deutsch”)
- French (“Français”)
- Italian (“Italiano”)
- Spanish (“Español”)
- Russian (“Russian”)
- British English (“English EU”)
- American English (“English US”)

Menu  
ITALIANO

ESPAÑOL

RUSSIAN

Menu  
ENGLISH EU

**Note:** If you select American English (“English US”) as the dialog language, the date format is changed and appears on all records in the American notation (month/day/year).

Menu  
ENGLISH US

### 6.21 Menu overview HR73

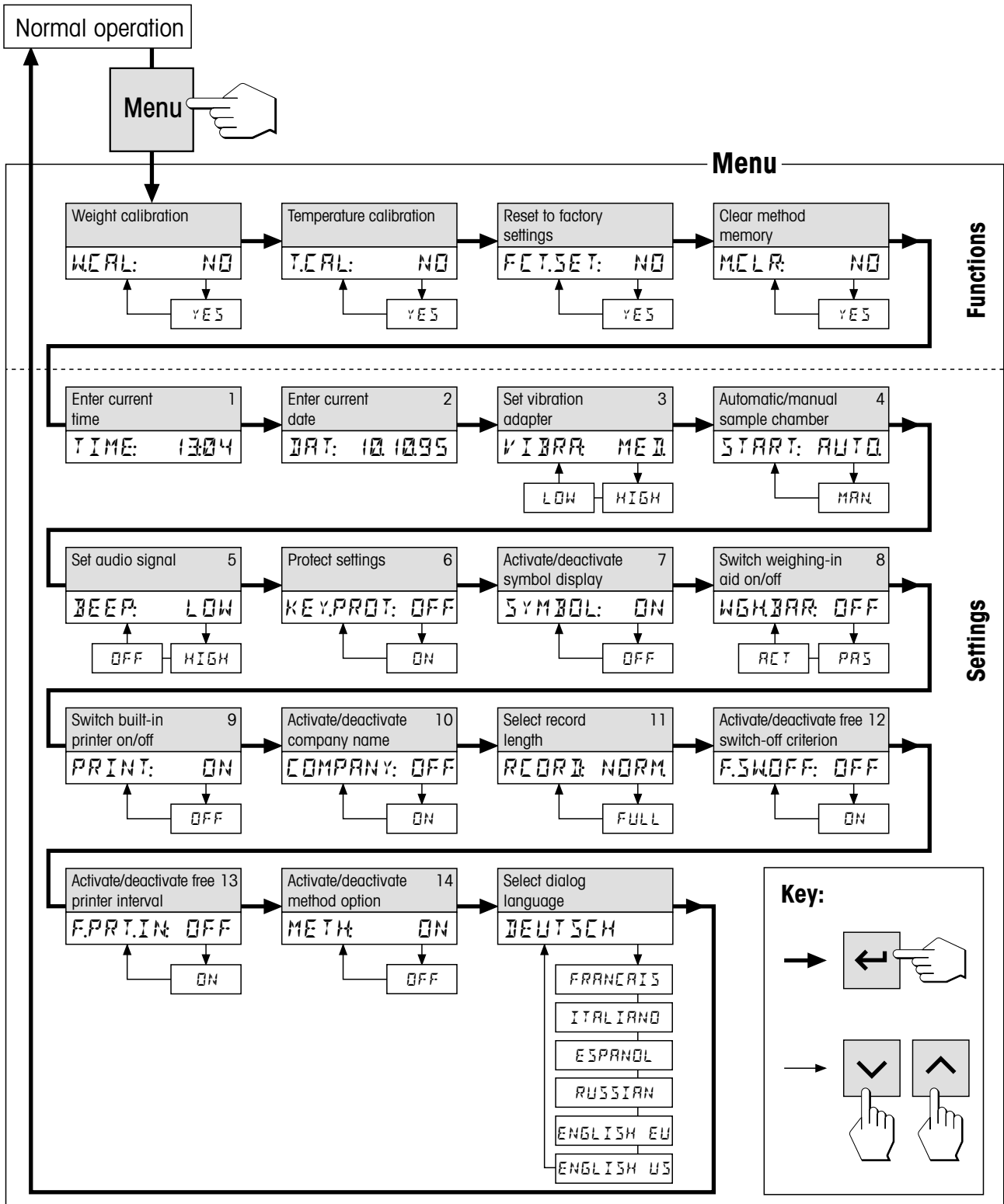

## 6.22 Menu overview HG53

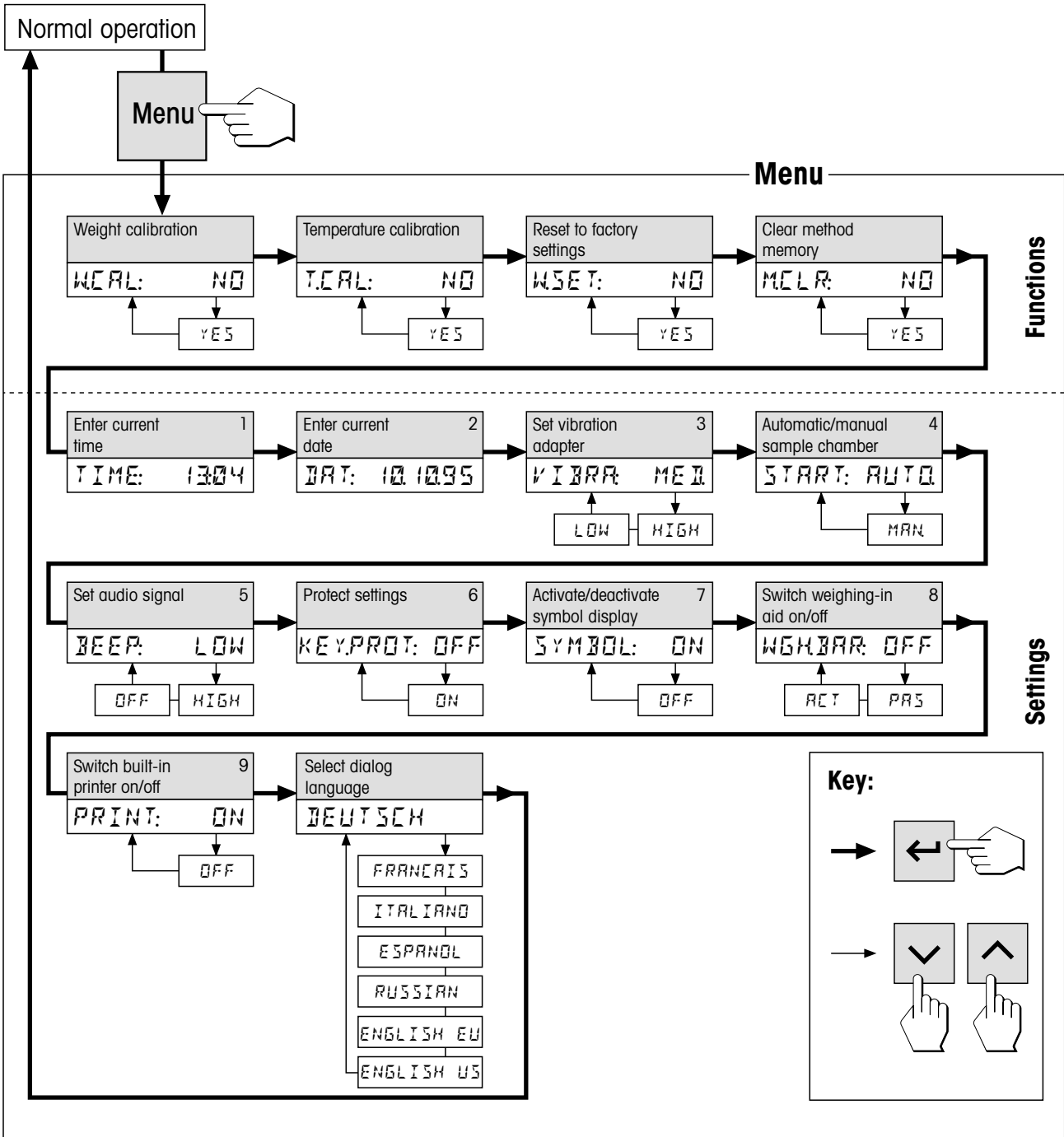

## 7. Servicing and replacing individual parts

In this section you will learn how to keep your Moisture Analyzer in good condition and how to replace expendable parts. You also find information on how to check the printer and change the printer paper and ribbon.

### 7.1 Cleaning

To obtain precise measurement results, we advise you to clean the temperature sensor and the protective glass of the heating component at regular intervals. Please note the following directions for cleaning your instrument:

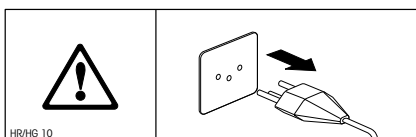

Disconnect the instrument from the power supply before cleaning.

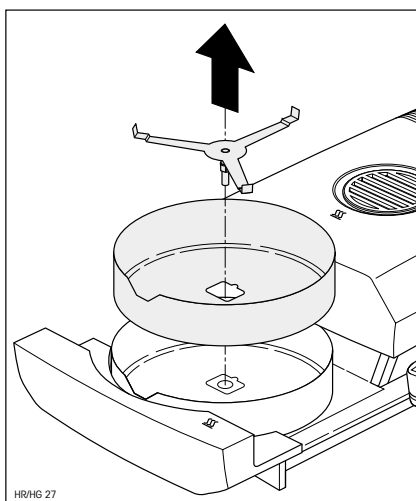

Open the automatic sample chamber by pulling it out.

Remove the draft shield element and the sample pan holder before cleaning.

Use a lint-free cloth for cleaning.

Clean the exterior of the instrument and the drying compartment with a mild cleaning agent. Although the housing is extremely rugged and resistant to solvents, never use abrasive cleaning agents or solvents!

Ensure that no liquid enters the interior of the instrument.

To clean the temperature sensor and the protective glass of the heating component, you should first open the dryer unit as described in section 7.6.

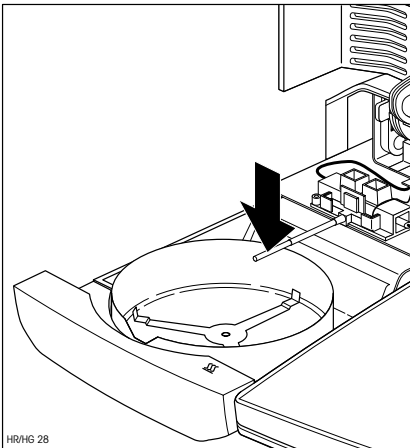

Carefully remove any deposits from the black temperature sensor.

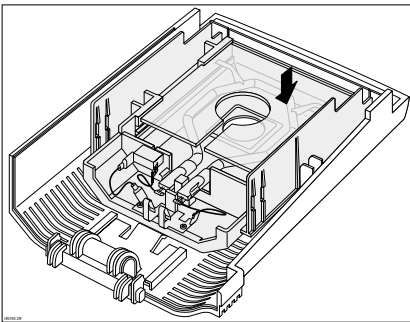

To clean the protective glass of the heating component, dismantle the dryer unit (see section 7.6), place it on a flat work surface and clean the protective glass with a commercial glass cleaner.

The air inlet of the fan is located at the rear of the instrument and its exterior should be cleaned from time to time to free it from any dust deposits.

After the temperature sensor and/or the protective glass have been cleaned, we recommend adjusting the dryer unit (section 6.3).



## 7.2 Changing the printer paper and ribbon

Apart from the need to replace the printer paper and ribbon on occasion, the built-in printer requires no maintenance.

### Changing the printer paper

The printer paper is changed as follows:

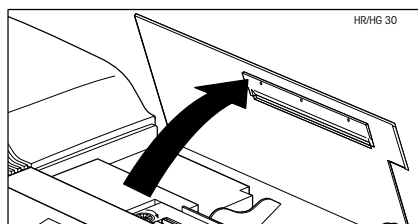

Open the cover of the built-in printer.

Pull any remaining paper upwards out of the printing unit.

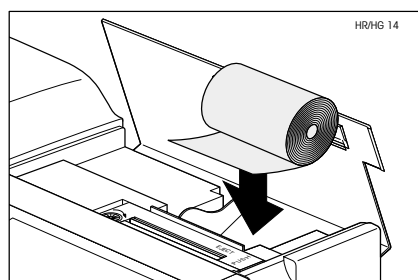

Insert a new roll of paper in the paper compartment and feed the paper horizontally through the slot at the back of the printing unit.



Press the «Paper feed» key until the leading edge of the paper exits the printing unit at the top.

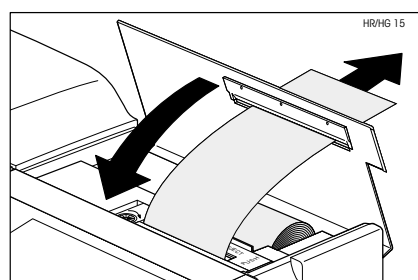

Lead the paper through the slot in the cover of the built-in printer and close the cover.

### Replacing the ribbon

When the print quality deteriorates, replace the ribbon as follows:

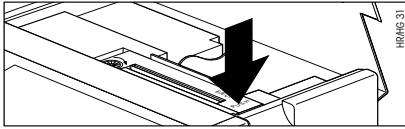

Open the cover of the built-in printer and press the projection marked "PUSH" on the right of the ribbon cassette.

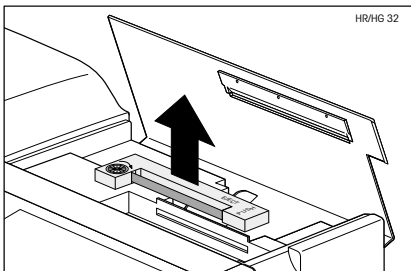

Pull the ribbon cassette up and out of the instrument and insert the new cassette. Thread the paper between the ribbon and the cassette. Press the cassette down as far as it will go until you hear it click into place.

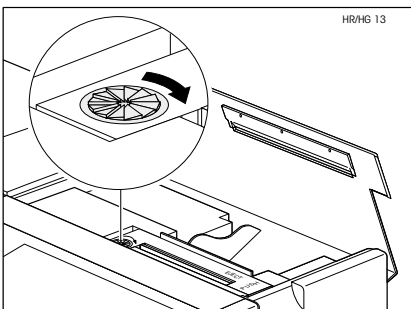

Tension the ribbon by turning the small wheel on the left of the cassette in the direction shown by the arrow. After you have tensioned the ribbon, close the cover of the printer.

## 7.3 Replacing the power line fuses

If the display of your instrument remains “dark” after switching on, in all probability the power line fuses of the instrument are blown.

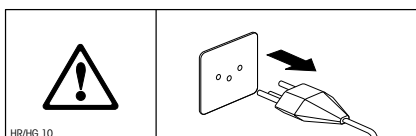

To change the fuses, proceed as follows:

Disconnect the instrument from the power supply.

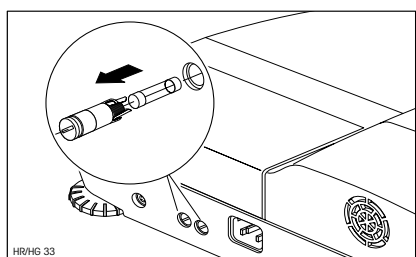

The two power line fuses (for neutral and phase) are located at the rear of the instrument. Turn the two fuse holders with a screwdriver to the left and pull the fuse holders out of the instrument.

Check the condition of **both** fuses. Replace blown fuses by those of the same type with the same rated value (5 x 20 mm, T6, 3H 250 V).



**The use of fuses of a different type or with different values as well as the bridging of fuses is not allowed and can hazard your safety and lead to instrument damage!**

## 7.4 Printer test

Your instrument has a function to check the proper functioning of the built-in printer.

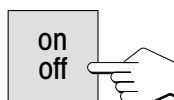
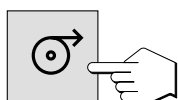

Ensure that the instrument is switched off.

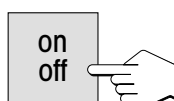

Press and hold the «Paper feed» key while simultaneously switching the instrument on with the «on/off» key. The printer prints out its complete character set.

To stop the test, switch the instrument off with the «on/off» key.

## 7.5 Installing the built-in printer

If your instrument is not already fitted with a built-in printer, you can order a printer as an option and retrofit it at any time. You can also change the built-in printer yourself without any problems should this be necessary. The procedure for installing the built-in printer is described in the **installation instructions** you received with the printer.

## 7.6 Dismantling and replacing the dryer unit

If a fault arises, the complete dryer unit can be replaced. We also advise you to open or dismantle the dryer unit to clean the protective glass of the heating component (see section 7.1).

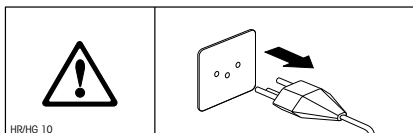

Disconnect the instrument from the power supply and be sure to allow the heating component to cool down for 10 minutes before you start the work!

The dryer unit is released by withdrawing the automatic sample chamber 2-3 cm.

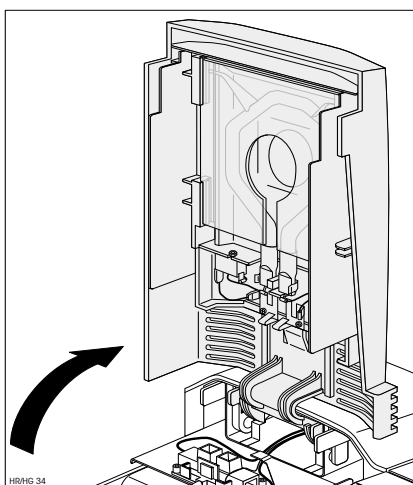

Swing the dryer unit upward.

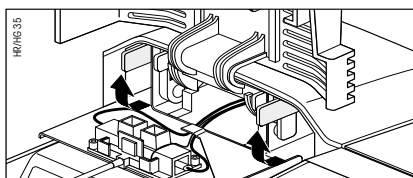

Disengage the hinge of the dryer unit by turning the two yellow levers 90° forward.

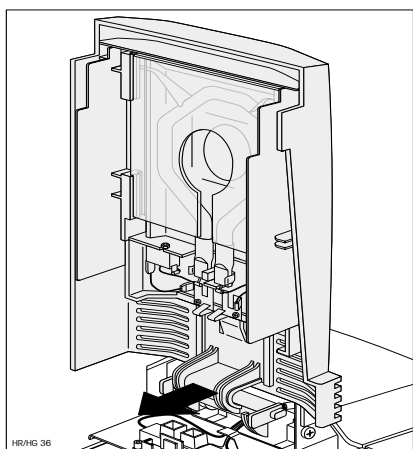

Remove the dryer unit (pull forward).

Install the (new or cleaned) dryer unit in the instrument and lock the hinge with the two yellow levers.

After a heating element has been cleaned or replaced, we recommend readjusting the dryer unit of your Halogen Moisture Analyzer (section 6.3).

## 8. If problems arise on occasion

In this section you will learn how errors can appear during operation of your Moisture Analyzer and how you can rectify these errors.

### 8.1 Notes on the error messages

Your instrument distinguishes between the three different types of errors explained below.



**Input errors** (key not active or can not be pressed in current operating status) are reported by your instrument with a short audio signal (if activated in the menu) without an error message in the display.

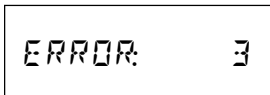

An **application error** occurs when the instrument can not perform a procedure or a corrective action is necessary as the limits of a value range have been violated or because a general operating error exists. Application errors are reported by your instrument with an audio signal. Further, the message "ERROR" appears in the display followed by the error number. You will find a list of all application errors in the next section.

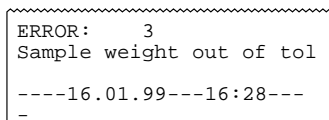
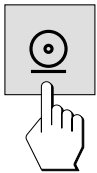

If your instrument is equipped with a built-in printer, you can print the error message **in clear text** with the «Print» key.

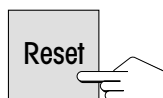
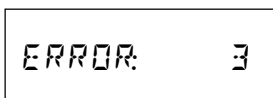

Before you can continue working, you must delete the error message with the «Reset» key.

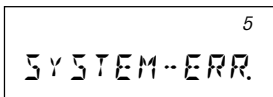

**System errors** indicate that a program or hardware error exists. The message "SYSTEM-ERR." appears in the display and the error number is shown in the top right corner. In such a case, disconnect the instrument from the power supply. Should the error reappear after reconnection to the power supply, contact your METTLER TOLEDO dealer to arrange an appointment for diagnosis and repair, Note the error number in order to facilitate the work of the service engineer.

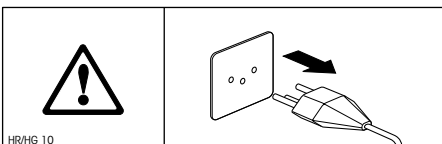

## 8.2 Meaning of the error messages

In this section you will find all error messages which appear in the display, the text of the error record on the printer, the reason for the error message and directions on how to rectify the error.

ERROR: 1

Display: Error: 1  
 Printout: Weighing result unstable  
 Cause: No stability during taring or adjustment  
 Remedy: Ensure stable ambient conditions and an optimum location. Also take care that no part of the sample or the sample pan touch the draft shield element or the sample pan holder. Highly volatile substances in the sample also prevent a stable weighing result being detected

ERROR: 2

Display: Error: 2  
 Printout: Wrong calibration weight  
 Cause: No or wrong adjustment weight loaded  
 Remedy: Load required adjustment weight

ERROR: 3



Display: Error: 3  
 Printout: Sample weight outside limits  
 Cause: Sample weight below 100 mg or outside the set limits with the weighing-in aid active (section 6.13)  
 Remedy: Weigh in a sample of at least 100 mg, adjust the sample weight so that it is within the set limits or deactivate the weighing-in aid in the menu

ERROR: 4

Display: Error: 4  
 Printout: Missing tare weight  
 Cause: Sample vessel has not been tared  
 Remedy: Tare sample vessel

ERROR: 5

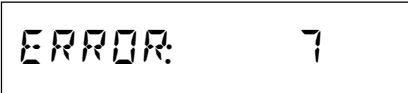
Display: Error: 5  
 Printout: Entry inadmissible  
 Cause: Lower/ upper limit of input range violated, the inputted method name already exists  
 Remedy: Enter value in valid range, use different method name

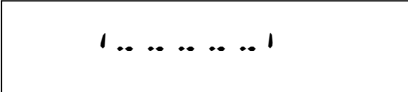
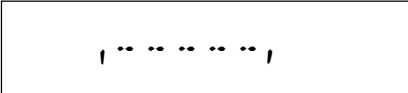
	<p>Display: Error: 6</p> <p>Printout: Not activated in menu</p> <p>Cause: Keypad has been locked in menu, weighing-in aid or printer deactivated in menu</p> <p>Remedy: Remove keypad locking, activate weighing-in aid or printer in menu</p>
	<p>Display: Error: 7</p> <p>Printout: Timer not activated</p> <p>Cause: The selected switch-off criterion does not allow entry of a time</p> <p>Remedy: Select "Timed switch-off" as switch-off criterion</p>
	<p>Display: Error: 8</p> <p>Printout: Entry missing</p> <p>Cause: In the temperature adjustment, the wait time of 5 minutes for entry of the temperature value has been exceeded</p> <p>Remedy: Repeat temperature adjustment and enter temperature values before elapse of the wait time</p>
	<p>Display: Error: 9</p> <p>Printout: Function error</p> <p>Cause: Undefined condition</p> <p>Remedy: Press «Reset» key or briefly switch instrument off then on again with the «on/off» key. If this error appears in the calibration, please contact your METTLER TOLEDO dealer.</p>
	<p>Display:   . . . . .  </p> <p>Cause: Underload</p> <p>Remedy: Load the sample pan holder</p>
	<p>Display:   . . . . .  </p> <p>Cause: Overload</p> <p>Remedy: Decrease the weight of your sample</p>

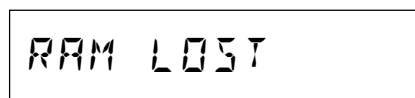

Display: RAM LOST

Cause: The installed battery is discharged (the equipment was disconnected from the mains for a longer period) or the instrument is faulty

Remedy: Charge battery (connect instrument to the power supply for 5 hours) and then reenter all settings. If the error reappears, contact your METTLER TOLEDO dealer.

## 8.3 What if...?

### ... the display remains "dark" after switching on?

- no line voltage
- power cable not connected
- blown power line fuses
- instrument faulty

Ensure that the instrument is connected to the power supply and that power is actually supplied. Check the power line fuses of the instrument and replace if necessary (see section 7.3). If the instrument still refuses to function, contact your METTLER TOLEDO dealer.

### ... after switching on "0.000" flashes in the display?

The sample pan holder is not installed. Install the sample pan holder.

### ... the function symbols disappear from the display after a certain time

You have deactivated the symbols in the menu (see section 6.12).

### ... the symbol of the stability detector is continuously lit up immediately after the start?

As soon as the symbol of the stability detector fades, the weighing result is stable and is accepted as a "wet weight". If the symbol does not fade, your instrument is probably at an unsuitable location (vibrations, shocks, powerful drafts, etc.). Seek a more suitable location.

Samples containing readily volatile substances may never reach stability owing to continuous evaporation. In this case, you must select manual operation for the automatic sample chamber (see section 6.9).

### ... the built-in printer does not print?

Ensure that the printer is activated in the menu (see section 6.14) and that the ribbon and paper are correctly installed. If the printer still refuses to print, perform a printer test (see section 7.4). If the test is unsuccessful, contact your METTLER TOLEDO dealer.



**... no drying time can be entered?**

Entry of the drying time is possible only if you have selected the switch-off criterion "Timed switch-off", with all other switch-off criteria this input possibility is not available (see section 4.4). If you attempt to enter a drying time, the instrument reports "Error: 7" (see section 8.2).

**... certain keys are inactive?**

You have protected the parameters (switch-off criterion, print interval, etc.) in the menu against change (see section 6.1.1). If you attempt to change a parameter, the instrument reports "Error: 6" (see section 8.2).

**... the measurement takes too long?**

You have selected an unsuitable switch-off criterion. The suitable switch-off criterion is simple to determine by a test measurement. You will find information on how to perform a test measurement in section 4.4.

An excessive amount of sample can also be the cause of slow drying, likewise samples which tend to form a skin which hinders vaporization.

Perform experiment at higher temperature.

**... the weighing-in aid is not visible?**

The weighing-in aid is available only if you have activated it in the menu (see section 6.13).

**... the automatic sample chamber does not close after pressing «Start»?**

You have selected the manual operating mode in the menu (see section 6.9).

**... no methods are available?**

You have deactivated the method option in the menu (see section 6.19).

**... the instrument does not heat following the start?**

The dryer unit is overheated and the thermal overload protection has responded. The instrument is equipped with thermal overload protection (bimetallic sensor) which switches off the heating tube if overheating occurs. If this happens, the device must be reset. To do this, proceed as follows:

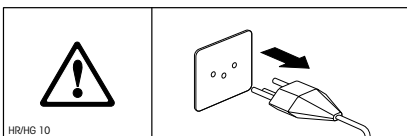

Disconnect the instrument from the power supply and be sure to allow the heating component to cool down for 10 minutes before you start the work!

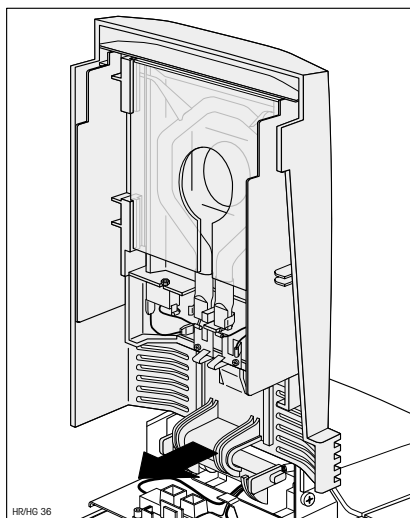

The dryer unit is released by withdrawing the automatic sample chamber 2-3 cm.

Swing the dryer unit upward.

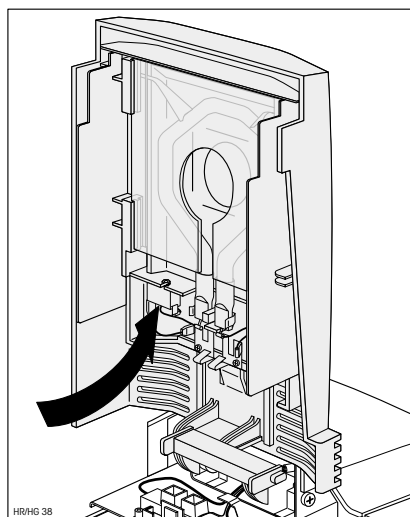

The thermal overload protection is reset by pressing the rear part of the white temperature switch.

The Analyzer can be restarted after closing the cover and connecting the instrument to the power supply.

If this is not possible, there may be a fault (e.g. a faulty halogen heating element). In such a case, contact your METTLER TOLEDO dealer.

After the temperature switch is reset or a heating element replaced (section 7.6) we recommend that you readjust the dryer unit of your Halogen Moisture Analyzer (section 6.3).

### ... the measurement results are not repeatable?

- The samples are not homogeneous, i.e. they have different compositions. The more inhomogeneous a sample, the larger the amount of sample needed to obtain a repeatable result.
- You have selected a drying time that is too short. Extend the drying time or select a suitable switch-off criterion "Weight loss per unit of time".
- The sample does not become completely dry (e.g. owing to skin formation). Dry the sample with the aid of glass fiber discs (section 3.3).
- You have selected a temperature that is too high and the sample has oxidized. Lower the drying temperature.
- The sample boils and the splashed drops continuously change the weight. Lower the drying temperature.
- Insufficient heating power as the protective glass is dirty. Clean the protective glass (section 7.1).
- The temperature sensor is contaminated or faulty. Clean the temperature sensor (see section 7.1) or have it replaced by a service engineer.
- The support on which the instrument is standing is not sufficiently stable. Use a stable support.
- The instrument is not stable on its 4 feet.
- The surroundings are very unstable (vibrations etc.).

## 9. Further useful information

### 9.1 Notes on interpretation of the measurement results and the ideal sample weight

The accuracy of the measurement results depends on the wet weight and the original moisture content of the sample. The relative accuracy of the measurement result improves with increasing wet weight. While the moisture content of the sample is fixed, the weight of the sample can frequently be determined by the user. However, with increasing weight the drying process is lengthened. **We thus advise you to select the weight of your sample to obtain the repeatability you require.** You can use the following table to determine the ideal weight for your sample. The table does not include the scatter due to the sample and its preparation.

An example will suffice: A result with a repeatability of  $\pm 0.1\%$  is expected. As the following table shows, your sample should have a minimum weight of 2 grams.

Repeatability of the result	Minimum sample weight
$\pm 0.02\%$	10 g
$\pm 0.05\%$	4 g
$\pm 0.1\%$	2 g
$\pm 0.2\%$	1 g

### 9.2 LocalCAN universal interface

Your Moisture Analyzer is fitted with a modern LocalCAN universal interface. This universal interface allows your instrument to interchange data with a computer or a control system. METTLER TOLEDO LC-P43 and LC-P45 printers can also be operated via this interface. The content and format of the printouts are the same as those produced by the optional built-in printer HA-P43.

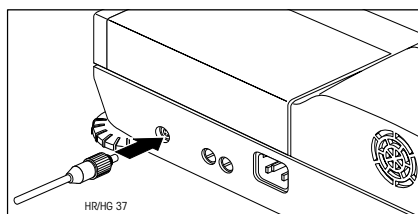

Devices (e.g. a computer) with an RS232 serial interface (with a DB9 or DB25 connector of the type usually found with PCs and laptops/notebooks) can be attached with the optional interface cables (LC-RS9 or LC-RS25, see section 9.7).

For interface commands please refer to the METTLER TOLEDO Standard Interface Command Set Reference Manual 11780131 supplied with your instrument.

**Data of the LocalCAN universal interface**

- Cable length between two devices maximum 10 m
- Total of cable lengths of all attached devices maximum 15 m

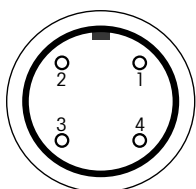
**Pin assignment**

Pin No.	Signal
1	negative signal line (-CAN)
2	positive signal line (+CAN)
3	plus pin of supply (V CAN) for peripherals
4	minus pin of supply (0 V) for peripherals

### 9.3 Application brochure

The application brochure for moisture determination from METTLER TOLEDO (order number: 11795011) contains a great deal of useful information for optimum utilization of your Moisture Analyzer. To order your personal copy, please contact your METTLER TOLEDO dealer.

### 9.4 Switch-off criterion “Weight loss per unit of time”

With the switch-off criterion “Weight loss per unit of time”, drying is automatically ended as soon as the **mean** weight loss ( $\Delta g$  in mg) per unit of time ( $\Delta t$  in seconds) drops below a preset value. 5 levels are preprogrammed in the factory each with a fixed weight loss per unit of time.

Further, a “Free switch-off criterion” allows you to define the weight loss per unit of time yourself.

The following applies to the individually selectable levels:

	$\Delta g$ in mg	$\Delta t$ in seconds
Switch-off criterion 1	1 mg	10 seconds
Switch-off criterion 2	1 mg	20 seconds
Switch-off criterion 3	1 mg	50 seconds
Switch-off criterion 4	1 mg	90 seconds
Switch-off criterion 5	1 mg	140 seconds
Switch-off criterion “F” (free)	1 mg to 10 mg	5 seconds to 3 minutes

The graph below exemplifies the mode of operation of the switch-off operation (not to scale)

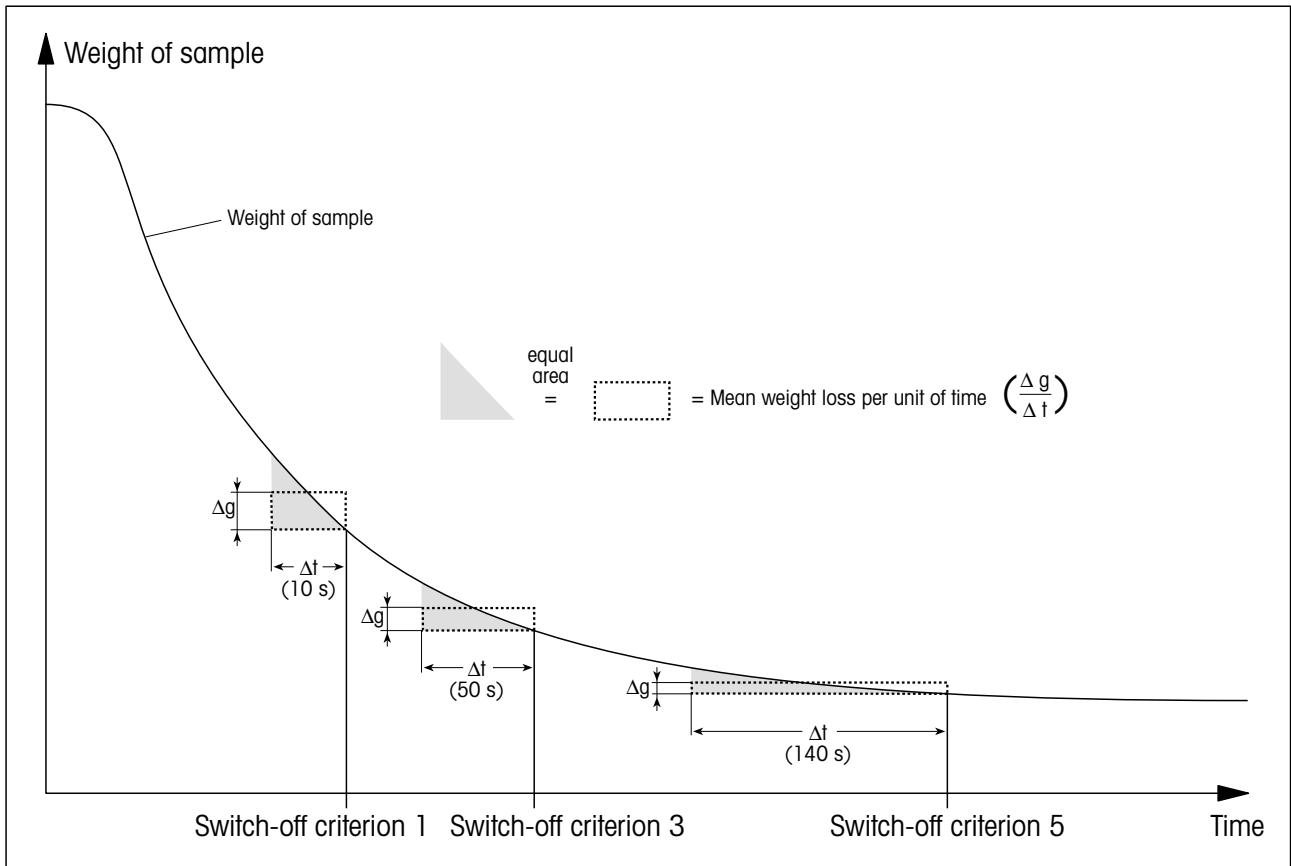

**Key:**

Switch-off criterion 1 (rapid availability of the result, suitable for determination of a trend)

Switch-off criterion 3

Switch-off criterion 5 (suitable for precision measurement)

## 9.5 Comments on certified version

Approval of the built-in balance is to EN45501 (OIML R76) requirements. When the heating part is switched off, the balance meets the applicable requirements of accuracy class 1. The metrological data are given on the certification plate (rear panel of instrument).

### **Adjustment of the built-in balance**

Before adjustment of the balance, a wait time of 15 min. (following completion of the last heating cycle) assures compliance with the calibration tolerance limits following EN45501 (OIML R76).

## 9.6 Technical data

Please note that the Moisture Analyzer will undergo continuous further development in the interest of the users. METTLER TOLEDO thus reserves the right to change all technical data at any time and without prior notification. The technical data basically apply to the two models (HG53 and HR73). Data which apply only to the HR73 are specially highlighted in grey.

---

### Dryer

Heating element:	Halogen ring-shaped radiator
Temperature range:	50–200 °C
Temperature step:	5 °C (HR73: 1 °C)
Temperature adjustment:	with temperature adjustment set HA-TC or HA-TCC

---

### Balance

Minimum sample weight:	0.1 g
Maximum sample weight: <sup>1)</sup>	51 g (HR73: 71 g)
Weight adjustment :	with external weight, 50 g ± 0.1 mg
Units:	g, % moisture content, % dry content, ATRO moisture content, ATRO dry content
Stability detector:	with symbol in display
Readability of the balance:	1 mg
Readability of the result:	0.01%
Repeatability with 1 g sample <sup>2)</sup> :	±0.2%
Repeatability with 10 g sample <sup>2)</sup> :	±0.02%

---

### Data

Time, date	system clock, fail safe
Drying time:	manual, 30 seconds to 480 minutes
Operational settings:	read-only memory, fail safe
Switch-off criteria:	5 levels, manual, timed, test, free
Method memories (fail safe):	20
Drying programs:	standard, fast, gentle, steps (3)
Sample identification :	alphanumeric, 20 characters
Company name:	alphanumeric, 20 characters
Reset protection:	by locking the keypad
Weighing-in aid (target weight):	0.1–51 g (HR73: 0.1–71 g) in 0.1 g steps
Limit values weighing-in aid:	1–25% (1% steps)

---

---

## Evaluation

Display modes:	5 modes (moisture, dry content, weight, ATRO moisture content, ATRO dry content = MC, DC, g, AM, AD)
Journal (fail safe):	last 20 measurement results per method
Statistics (fail safe)	continuous, per method
Records:	via built-in printer (Option)

---

## Hardware

Audio signal:	adjustable (soft, loud, off)
Data interface:	LocalCAN universal interface built in, RS232C option
Inspection window:	in dryer unit
Leveling:	3 leveling screws and level indicator
Display:	LCD, supertwist LCD with backlighting
Status display (user guide):	integrated in display
Alphanumeric entry key:	integrated in keypad
Numeric entry keys:	integrated in keypad
Sample pan, $\varnothing$ :	90 mm
Thermal overload protection:	bimetallic-element switch in dryer unit
Dimensions (w x h x d):	36 x 11 x 34 cm
Weight, ready to measure:	7.7 kg (with built-in printer)

---

## Admissible ambient conditions

	Use only in closed rooms
Height up to:	4000 m NN
Temperature range:	5 °C to 40 °C
Atmospheric humidity:	80% rh @ to 30 °C
Voltage fluctuations:	-15%+10%
Installation category:	II
Pollution degree:	2
Power load:	Max. 450 W during drying process
Current consumption:	4 A or 2 A, according to the heating element
Power supply voltage:	100 V – 120 V or 200 V – 240 V, 50/60 Hz (the voltage is given by the heating element)
Power line fuse:	2 (in each conductor), 5 x 20 mm, T6.3H 250 V

---

<sup>1)</sup> Data for standard sample pan (diameter 90 mm), with the reusable sample pan the maximum sample weight is 30 g (HR73: 50 g).

<sup>2)</sup> Instrument acclimatized in room and connected to power supply for 30 minutes, drying temperature 160 °C.



## 9.7 Optional equipment, expendable material and spare parts

Designation	Order No.	Notes
<b>Optional equipment</b>		
Adjustment weight 50 g (Class F1)	15865	Adjustment of balance
Temperature adjustment set HA-TC	214455	Adjustment of dryer unit
Certified temperature adjustment set HA-TCC (including test certificate)	214528	Adjustment of dryer unit
HA-TCCRe Recertification from HA-TCC	214534	Recertification with certificate
Interface cable LC-RS25 (RS232/25-pin)	229050	
Interface cable LC-RS9 (RS232/9-pin)	229065	
Built-in printer HA-P43	214456	
Reusable sample vessel HA-DR1	214462	Set of 3
Transport case HA-CASE	214515	
Weighing-in aid HA-PH	214526	Set of 3
Chemically resistant protective cover HA-COVER	214533	Set of 2
Textile sample pan for bulky samples HA-CAGE	214695	1 piece
<b>Expendable material</b>		
Printer paper for HA-P43	72456	Set of 5 rolls
Ribbon (cassette, black) for printer HA-P43	65975	Minimum order quantity 2
Standard sample pan HA-D90 (Al) Ø 90 mm	13865	Set of 80
Glass fiber discs HA-F1	214464	Fiber disk for liquids set of 100
<b>Spare parts</b>		
Dryer unit 110 V HA-HM110	214468	
Dryer unit 230 V HA-HM230	214469	

If you require other spare parts for your Moisture Analyzer, please contact your METTLER TOLEDO dealer.

# 10. Index

## A

A...Z 49  
Accuracy 91  
Adjusting balance 61  
Adjusting dryer unit 63  
Adjustment weight 61, 97  
Adjustment 27  
Alarm clock symbol 68  
Application error 85  
ATRO moisture/dry content 40  
Audio signal 68, 85  
Automatic sample chamber 48, 68

## B

Built-in printer 71, 83, 89, 97

## C

Code 49  
Comment (record) 49  
Computer 91

## D

Date 20  
Draft shield element 17, 19, 23, 29  
Dry content 39, 40  
Dryer unit 26, 63, 84  
Drying program 30  
Drying time 89

## E

Error messages 85  
Expendable material 97

## F

Free print interval 41, 75  
Free switch-off criterion 37, 92  
Function symbol 69, 88

## G

Gentle drying 31  
Glass fiber disc 28  
GLP 27  
GMP 27

## H

Heating component 97

## I

ID 52  
Input error 85  
Inspection window 64  
Interface 91  
ISO 9001 27

## L

Language 76, 77, 78, 79, 83, 89  
LocalCAN universal interface 91  
Location 14, 86, 88  
Locking keypad 69

## M

Manual printout 41  
Manual switch-off criterion 37  
Measured value in grams 39  
Measured value journal 56  
Measured value statistics 58

Measurement record 72  
Measurement 44  
Menu 77, 78  
Method 30, 51, 89  
Method memory 66  
Moisture content 39, 40

## N

Numeric entry 29

## P

Personnel qualification 10  
Power line fuses 83, 88  
Print interval 41  
Printer 97  
Printer paper 19, 97  
Printer test 83  
Protecting settings 69

## Q

Quality assurance system 27

## R

Ramp 31, 33  
Rapid drying 31  
Record comment 49  
Record 38  
Repeatability 91  
Reset 21, 25, 47, 55, 59, 60  
Ribbon 97

## S

Sample pan handler 97  
Sample pan holder 79, 88

Sample pan 28, 97  
Sample weight limit 70  
Sample weight tolerance 70  
Sample weight 91  
Series number 73  
Servicing 79  
Set temperature 32, 42  
Signal 85  
Spare parts 97  
Special characters 49, 53, 71  
Specimen sample 22  
Stability detector 88  
Standard drying 31, 32  
Start 24, 45, 63  
Statistics 58  
Step drying 31, 34  
Stop 37, 38, 46, 48  
Switch-off criterion 36, 74, 87,  
89, 92  
Symbol 69  
System error 85

**T**

Technical data 95  
Temperature adjustment set 97  
Temperature adjustment 63  
Temperature limitation 35  
Temperature sensor 80  
Test measurement 38, 89  
Thermogravimetric principle 8,  
9, 10  
Thermometer 64  
Time limit 35  
Time 20

Timed switch-off 37

**U**

User guide 22

**V**

Vibration adapter 67

**W**

Weighing-in aid 42, 89

Weight adjustment 61

Weight in grams 39, 40

Weight loss per unit of time 36,  
74, 92

**To protect your METTLER TOLEDO product's future:  
METTLER TOLEDO service assures you of quality, measuring accuracy  
and preservation of value of the METTLER TOLEDO products for years  
to come.**

**Please send for details of our attractive terms of service.**

**Thank you.**



\*P706011\*

Subject to technical changes and to the availability  
of the accessories supplied with the instruments.

© Mettler-Toledo GmbH 2001      706011D Printed in Switzerland 0101/2.12

**Mettler-Toledo GmbH, Laboratory & Weighing Technologies**, CH-8606 Greifensee, Switzerland  
Phone +41-1-944 22 11, Fax +41-1-944 30 60, Internet: <http://www.mt.com>