

Operating Instructions

METTLER TOLEDO WeighCom Application for AX and UMX Mass Comparators

Version 1.0x

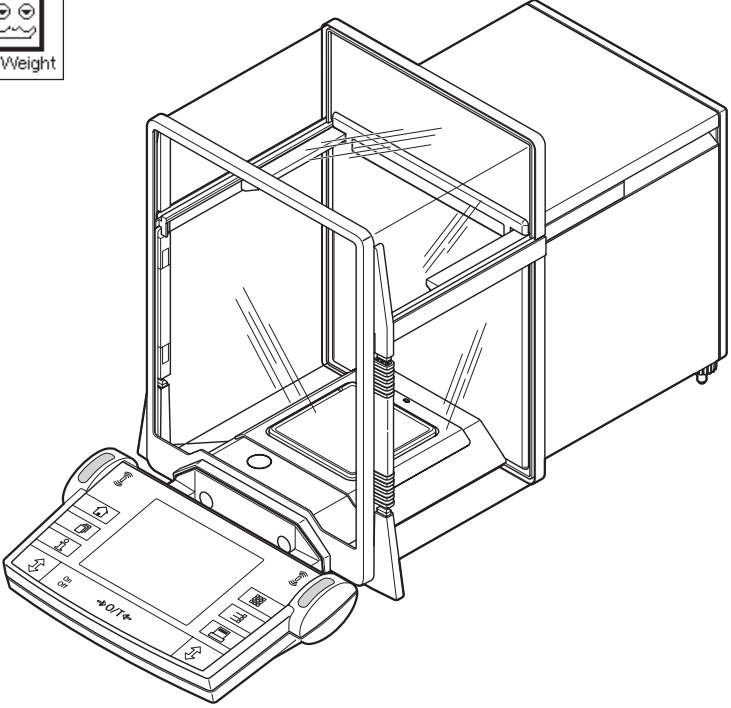
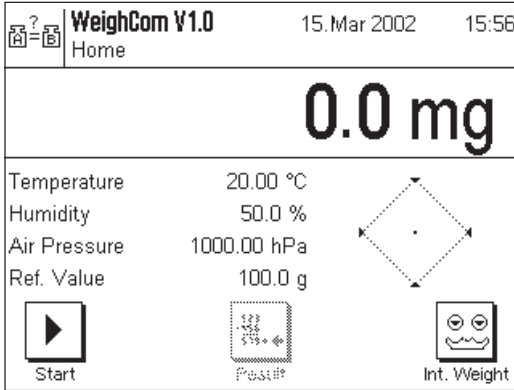

Contents

1	Introducing the “WeighCom” application	3
2	Important notes	3
3	Selecting the “WeighCom” application	3
4	System settings	4
4.1	Deactivate SmartSens	4
4.2	Set beep	4
5	Settings for the “WeighCom” application	5
5.1	Overview	5
5.1.1	Select method	6
5.1.2	Environment	6
5.1.3	Select reference weight (A)	6
5.1.4	Select test weight (B)	7
5.1.5	Define reference weight “Reference 1-10”	7
5.1.6	Define “Test Weight 1-10”	7
5.1.7	Specify number of comparative weighings	8
5.1.8	Stabilization time	8
5.1.9	Define report	8
5.2	Special function keys for WeighCom	10
5.3	Special information fields for WeighCom	11
6	Working with the “WeighCom” application	11
6.1	Preparatory tasks	11
6.2	Performing WeighCom	12
6.3	Displaying and printing the result	14
6.3.1	Example of a report	14
6.4	Calculation of the mean of the weight differences	15
6.4.1	Calculation of the mean value of the drift-corrected differences ABA or ABBA (“Mean Diff.”)	15
6.4.2	Calculation of the standard deviation of the drift-corrected differences (“Std Dev.”)	15
6.4.3	Calculation of the conventional mass value of the test weight (“Error of Test Weight”)	15

1 Introducing the "WeighCom" application

To ensure the traceability of weights to the prototype kilogram, the mass of the weights to be determined must be compared with the mass of the reference weight. This procedure requires great care on the part of the operator to avoid confusing the weights. The procedure is made certain and reliable by the "WeighCom" application, which enables a guided mass comparison of weights of any manufacturer to be performed on the AX26, UMX5, AX106, AX206, AX1005, AX2005 and AX1004 mass comparators.

2 Important notes

These instructions only describe

- «guided» mass comparison using the "WeighCom" application.

These instructions assume that you know how to use an AX or MX/UMX balance. You will find corresponding information in the Operating Instructions for the AX and MX/UMX balances or AX106, AX206, AX1005 and AX2005, AX1004 mass comparators, and it is assumed that you have already read these.

In the operating instructions you are now reading, you will find information about practical work with the "WeighCom" application and the application-specific settings for this application. You will find information about the non-application-specific system settings in Chapter 5 of the operating instructions for the AX and MX/UMX balances, or in those for the AX106, AX206, AX1005, AX2005 and AX1004 mass comparators.



Note: Use of the internal dialing weights (on AX106, AX206, AX1005, AX2005 and AX1004 mass comparators only) is explained in the operating instructions for the respective mass comparators.

3 Selecting the "WeighCom" application

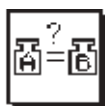
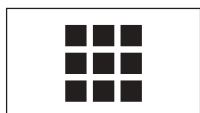

WeighCom

If the "WeighCom" application is not already active, touch the  key. In the selection window, touch the symbol for the application.

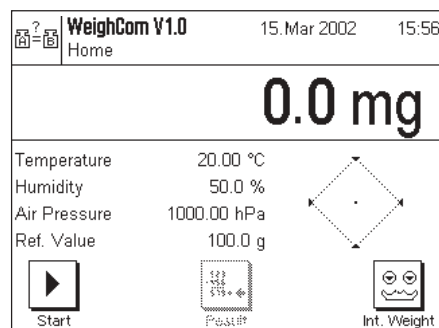

After you have selected the application, the display shown at left appears. You can adjust the settings to your needs as described in the Sections that follow.

4 System settings

4.1 Deactivate SmartSens

Switch off the "SmartSens" function to avoid unintentional opening of the draft shield.



System

Touch the «» key and select "System".



Select "SmartSens".

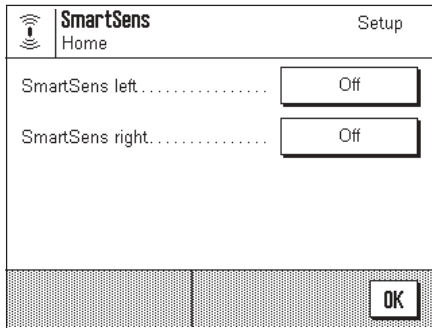

Set SmartSens left and right to "Off" to avoid unintentional actions.

Note: The draft shield can always be opened with the «» key.

4.2 Set beep

Set the "Beep" volume to suit your needs (between 25% and 100%).

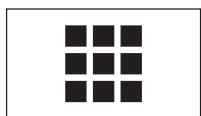

System

Touch the «» key and select "System".



Select "Terminal".

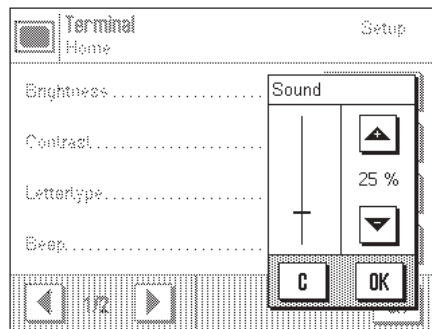
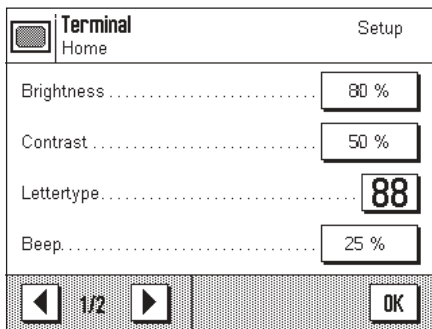

Activate the sound (25%-100%) to enable acoustic guidance.

5 Settings for the "WeighCom" application

A range of application-specific settings are available for "WeighCom", which you can use to adjust the application to your needs.

Note: Your settings are valid for the active user profile. Because of this, make sure the desired profile has been selected before you make the settings.

5.1 Overview

The application-specific settings can be accessed with the «≡» key. After you touch this key, the first of 4 menu pages appears with the application-dependent settings for "WeighCom".

"Method"

Select the method to be used for comparative measurements (Section 5.1.1).

"Environment"

This is used to enter the current ambient conditions (Section 5.1.2).

"Select Reference (A)"

Select the reference weight (Section 5.1.3).

"Select Test Weight (B)"

Select the test weight (Section 5.1.4).

"Reference 1-10"

Enter the parameters of the reference weights (Section 5.1.5).

"Test Weight 1-10"

Enter the definition of the test weights (Section 5.1.6).

"No. of Comparison"

Enter the number of the desired measurement cycle (Section 5.1.7).

"Stabilization Time"

This is used to enter the time to elapse between loading the weight and reading the mass value (Section 5.1.8).

"Report"

Specifies the information to appear on the measurement reports (Section 5.1.9).

"Function keys"

Here you can specify which function keys should appear at the bottom edge of the display. These allow direct access to certain functions (Section 5.2).

"Info field"

Here you can specify which information fields should be displayed (Section 5.3).

5.1.1 Select method

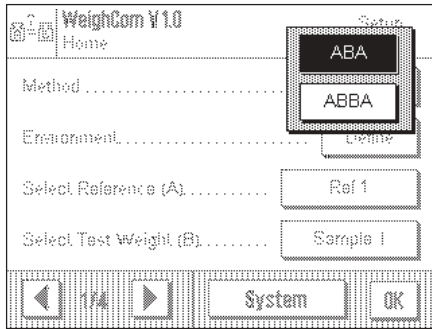

This menu is used to specify the method to be used for performing the measurements. Two methods are available, defined by the sequence in which the weights are measured. The methods are "ABA" and "ABBA" where:

- A is the reference weight
- B is the test weight

5.1.2 Environment

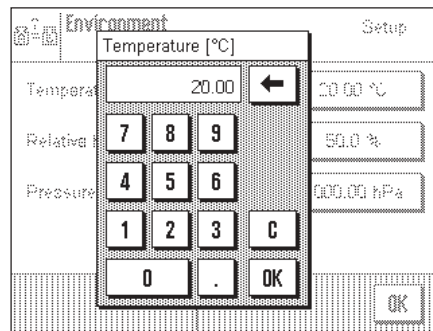
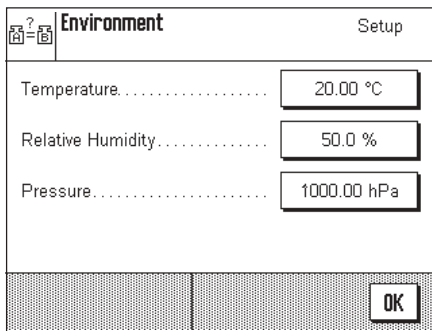

- "Temperature" Enter the ambient temperature.
- "Relative Humidity" Enter the relative humidity.
- "Pressure" Enter the air pressure.

Note: These data must be entered manually. The air density is not calculated.

5.1.3 Select reference weight (A)

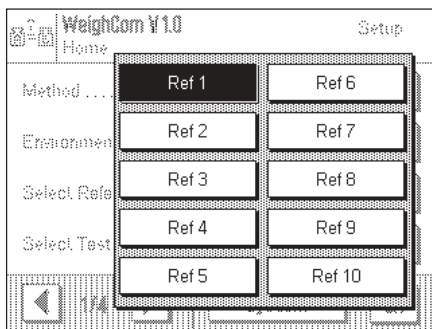

Select the reference weight. There is a choice of 10 references. The details are input under "Reference 1-10" (Section 5.1.5).

5.1.4 Select test weight (B)

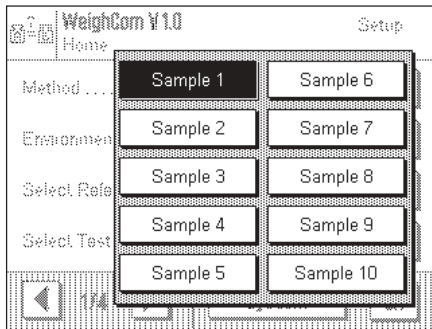

This is used to specify the test weight to be used for the measurement.

The designations of the test weights are entered under "Test Weight 1-10" (Section 5.1.6).

5.1.5 Define reference weight "Reference 1-10"

Enter the parameters for the reference weight. Up to 10 different reference weights can be defined.

– Select references

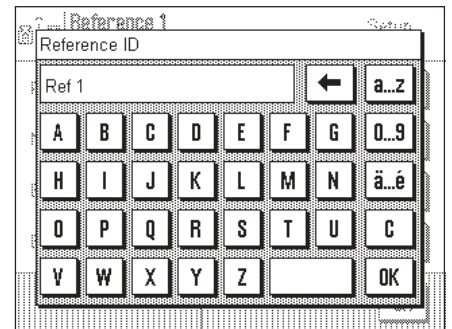
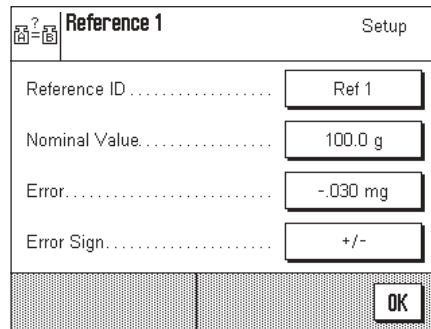
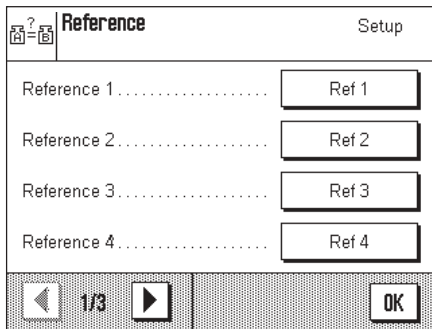

"Reference ID"

Define the designation for the reference weight.

"Nominal Value"

Enter the nominal value for the reference weight.

"Error"

Enter the error of the reference weight (conventional mass value from the calibration certificate).

Note: The minus sign is activated with the "Error Sign → «+/-»" key.

"Error Sign"

«+/-» inserts or deletes a leading minus sign.

5.1.6 Define "Test Weight 1-10"

Select a test weight and assign a designation to it. Up to 10 test weights can be defined.

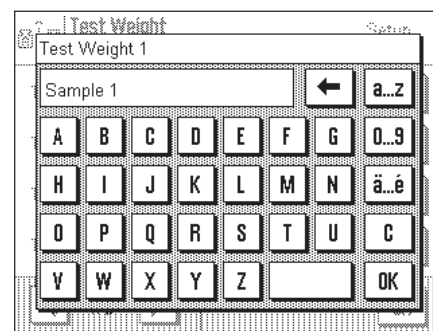
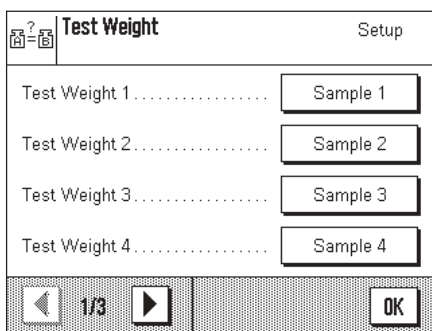

5.1.7 Specify number of comparative weighings

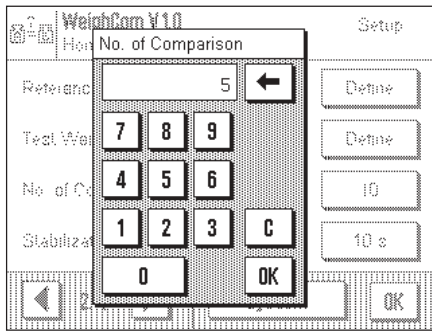

The number of comparative weighings (measurement cycles) is entered here.

5.1.8 Stabilization time

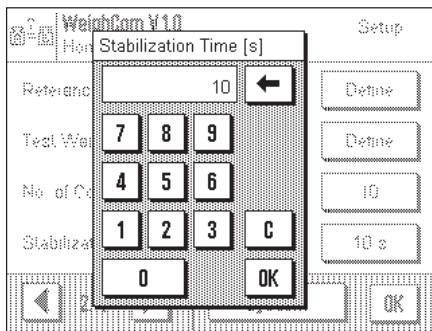

Enter the time to elapse between loading the weight and reading the mass value.

Note: The time must be selected so as to ensure stabilization of the material being measured. Determination of the stabilization time must take account of the ambient conditions.

5.1.9 Define report

In this menu you specify the information to appear on the reports.

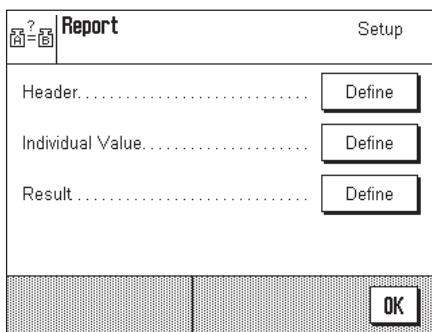

To make it clearer, this menu is divided into 3 submenus in which you can specify the options for the title of the report, reporting the individual values, and the result.

Options for the report titles

By touching the corresponding box, you activate or deactivate the desired information. The checked information will be printed on the record. You can use "STD" to reset to the factory settings, or touch "C" to quit the input window without saving the changes. If you wish to save your changes, touch "OK".

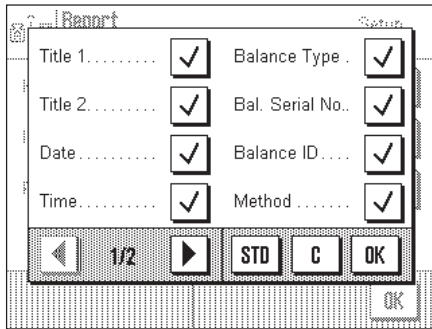

On the first page of the menu, the following title options are available:

- "Title 1" & "Title 2"** The name & version of the application and test report are printed out.
- "Date" & "Time"** The current date and time are printed out.
- "Balance Type" & "Bal. Serial No."** This information is read from the type data of the balance and cannot be changed by the user.
- "Balance ID"** The specified balance identification is printed out.
- "Method"** The specified measurement method is printed out.

Factory setting: All header information is activated.

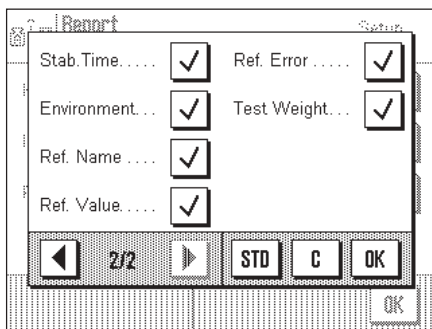

On the second page of the menu, the following title options are available:

- "Stab. Time"** The specified stabilization time is printed out.
- "Environment"** The specified ambient conditions are printed out.
- "Ref. Name"** The designation of the selected reference weight (A) is printed out.
- "Ref. Value"** The nominal value of the reference weight (A) is printed out.
- "Ref. Error"** The error of the reference weight (conventional mass value from the calibration certificate) is printed out.
- "Test Weight"** The designation of the selected test weight (B) is printed out.

Factory setting: All header information is activated.

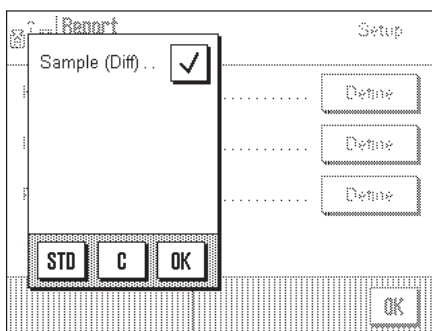

Individual value

- "Sample (Diff)"** The difference value of each completed measurement cycle (e.g. ABA) is printed out.

Factory setting: Difference value activated.

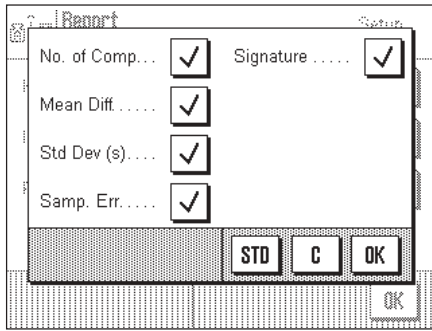

Result

"No. of Comp."

The number of measurement cycles is printed out.

"Mean Diff."

The mean value of the differences [between reference (A) and test weight (B)] is printed out.

"Std Dev (s)"

The relative (%) and absolute (value) standard deviation of all measurement cycles is printed out.

"Samp. Err."

The calculated value of the test weight is printed out.

"Signature"

Adds an extra line to the report for a signature.

Factory setting:

All result information is activated.

5.2 Special function keys for WeighCom

The function key menu contains additional settings for WeighCom.

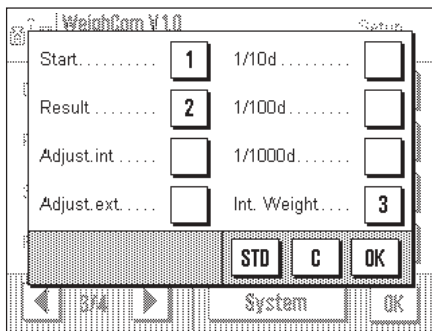

"Start"

Starts the WeighCom application.

"Result"

Displays the data of the last measurements.

"Int. Weight"

Internal weights are used as switching weights.



Note: Use of the internal switching weights (AX106, AX206, AX1005, AX2005 and AX1004 mass comparators only) is explained in the operating instructions of the respective mass comparators.

Factory setting:

"Start", **"Result"**, and **"Int. Weight"** are activated.

5.3 Special information fields for WeighCom

The information field menu contains additional settings for WeighCom.

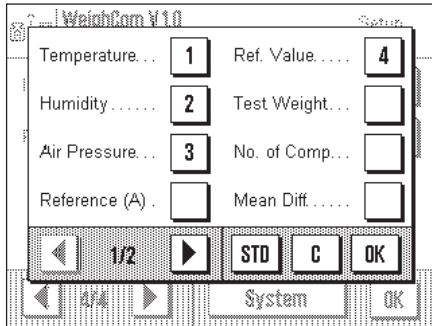

The following information fields for WeighCom can be selected on the first page:

- "Temperature"** The value entered for the temperature.
- "Humidity"** The value entered for the relative air humidity.
- "Air Pressure"** The value entered for the air pressure.
- "Reference (A)"** The selected reference weight.
- "Ref. Value"** The nominal value of the selected reference weight.
- "Test Weight (B)"** Designation of the selected test weight.
- "No. of Comp."** Selected number of comparative weighings.
- "Mean Diff."** Mean of the differences [between reference (A) and test weight (B)].

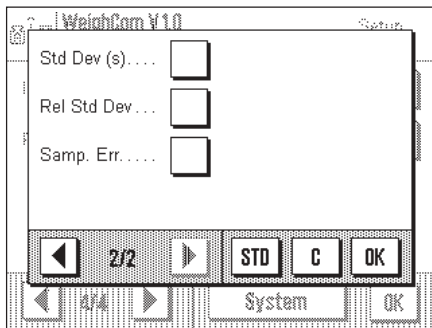

The following information fields for WeighCom can be selected on the second page:

- "Std Dev (s)"** Calculated value for the absolute standard deviation.
- "Rel Std Dev"** Calculated value for the relative standard deviation (in %).
- "Samp. Err."** Calculated error of the standard weight.

Factory setting: "Temperature", "Humidity", "Air Pressure" and "Ref. Value" are activated.

6 Working with the "WeighCom" application

This Section explains how to work with the "WeighCom" application in practice. It is assumed that the "WeighCom" application has been selected and the application-specific settings have been made (Section 5).

The application guides you with the display and also acoustically (audible signal) from one step to the next.

6.1 Preparatory tasks

Before starting measurements the following tasks must be performed:

- Select the measurement method (Section 5.1.1)
- Enter the ambient conditions (Section 5.1.2)
- Select the reference weight (Section 5.1.3)
- Enter the parameters for the reference weight (Section 5.1.5)
- Select the test weight (Section 5.1.4)
- Specify the designation for the test weight (Section 5.1.6)
- Specify the number of comparative measurements (Section 5.1.7)
- Specify the stabilization time (Section 5.1.8)
- Define the report (Section 5.1.9)

6.2 Performing WeighCom



Touch the "Start" function key to start WeighCom.

Note: The glass draft shield opens and closes automatically.

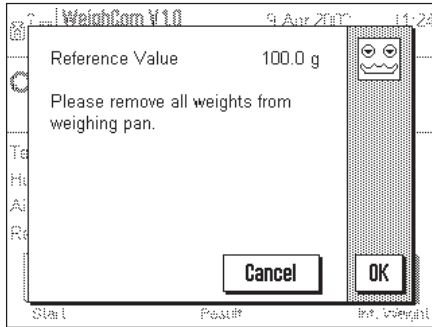

You are prompted to remove all the weights from the weighing pan.

When the weighing pan is empty, touch the "OK" key to continue the operation.

If you wish to quit the operation, touch the "Cancel" key.

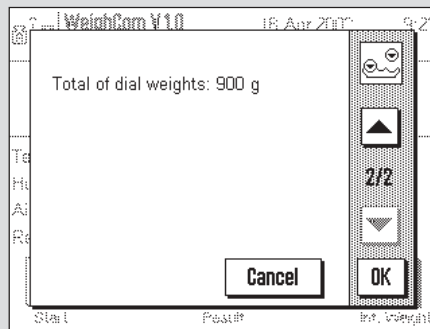
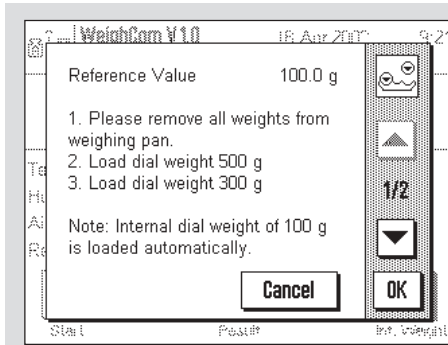

 If you are using a mass comparator of the type AX106, AX206, AX1005, AX2005 and AX1004 it prompts you to use the dial weights. The necessary settings are shown on the display.

Note: You will find the settings in the operating instructions of your mass comparator.

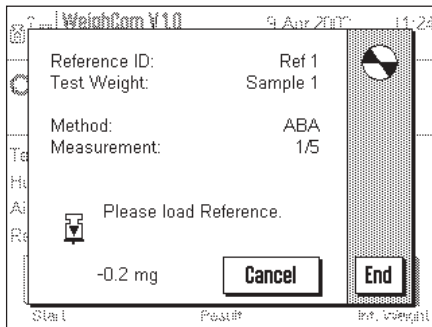

You are prompted to load the reference weight (A).

The following settings are shown on the display:

- "Reference ID" The selected reference weight "Ref 1"
- "Test Weight" The selected test weight "Sample 1"
- "Method" The selected measurement method "ABA"
- "Measurement" "1/5" indicates that you are in measurement cycle 1 of 5.

Note: You can terminate a measurement series by touching the "End" key. All measurement series completed up to this point are displayed.

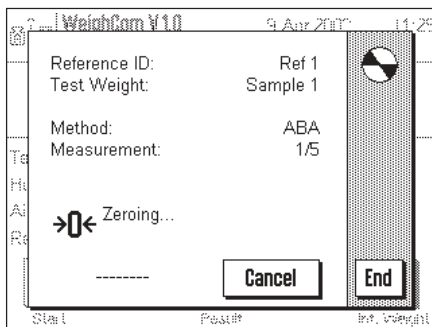

After the reference weight (A) has been loaded, the display is set to "Zeroing".

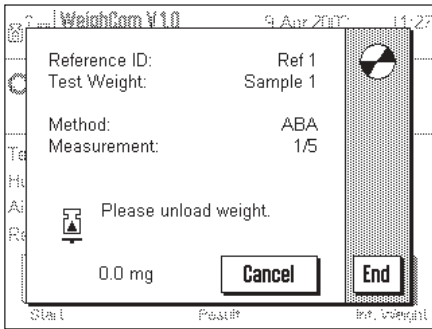

You are prompted to remove the weight.

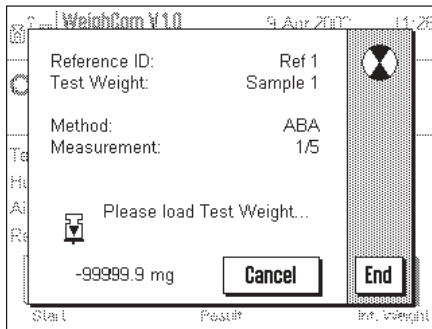

You are prompted to load the test weight (B).

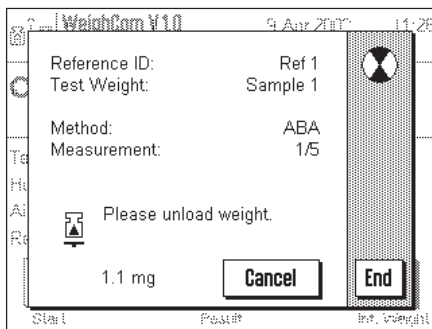

You are prompted to remove the weight.

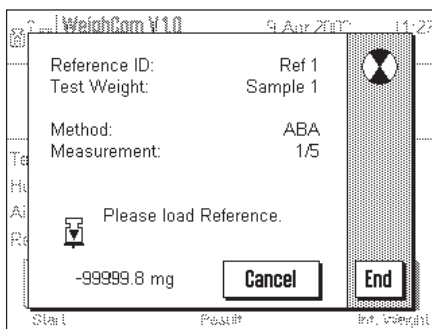

You are prompted to load the reference weight (A).

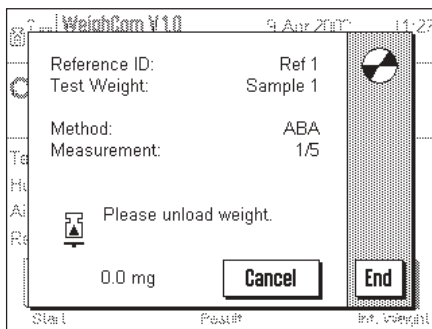

You are prompted to remove the weight.

This cycle of operations is repeated until the number of measurement cycles you entered is completed.

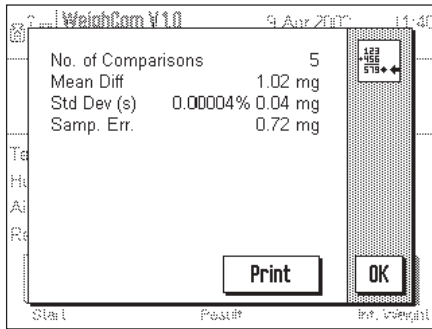

When the comparative measurements are complete, the result is shown on the display.

The results window contains the following results:

- "No. of Comparisons" Number of comparative weighings completed
- "Mean Diff." Mean value of the differences ABA or ABBA
- "Std Dev (s)" Standard deviation in %, and as value
- "Samp. Err." Calculated error of the test weight

By touching the "Print" key you can print the report. Touching the "OK" key completes the operation and closes the results window.

6.3 Displaying and printing the result

When you have completed the operation, you can call up the result with the "Result" function key and touch the "Print" key (or the  key on the terminal).

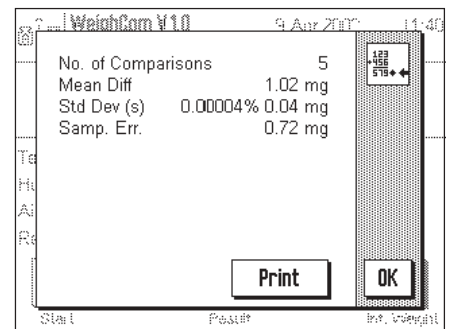
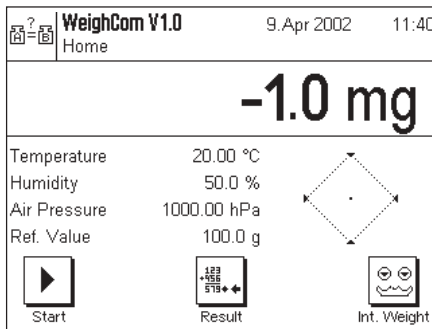

6.3.1 Example of a report

```

METTLER TOLEDO GmbH
----- WeighCom V1.0 -----
----- TEST REPORT -----
15.Apr 2002          12:49
Type                AX106
SNR                 1128489
Balance             Lab WC/1A

Setup
Method              ABA
Stabilization Time  10s
Temperature         20.00 °C
Humidity             50.0 %
Pressure            1000.00 hPa

Reference
ID                  Ref 1
Nominal             100.0 g
Error               -0.3 mg
    
```

```

Test Weight
Name                Sample 1

Diff 1              1.05 mg
Diff 2              1.05 mg
Diff 3              1.05 mg
Diff 4              1.00 mg
Diff 5              0.95 mg

No. of Comp.       5
Mean Diff.         1.05 mg
s 0.00005%         0.04 mg
Samp. Err.         0.72 mg

Signature

.....
    
```



6.4 Calculation of the mean of the weight differences

6.4.1 Calculation of the mean value of the drift-corrected differences ABA or ABBA ("Mean Diff.")

Note: (A = reference weight, B = test weight)

Calculation for method "ABA"

$$\text{Diff1} = B1 - \frac{(A1 + A2)}{2}$$

$$\text{Diff2} = \frac{(B2 + B3)}{2} - A3$$

$$\text{Diff3} = B4 - \frac{(A4 + A5)}{2}$$

$$\text{Mean Diff.} = \left(\frac{\text{Diff1} + \text{Diff2} + \text{Diffn}}{n} \right)$$

Calculation for method "ABBA"

$$\text{Diff1} = \frac{(B1 + B2)}{2} - \frac{(A1 + A2)}{2}$$

$$\text{Diff2} = \frac{(B3 + B4)}{2} - \frac{(A3 + A4)}{2}$$

$$\text{Diff3} = \frac{(B5 + B6)}{2} - \frac{(A5 + A6)}{2}$$

$$\text{Mean Diff.} = \left(\frac{\text{Diff1} + \text{Diff2} + \text{Diffn}}{n} \right)$$

6.4.2 Calculation of the standard deviation of the drift-corrected differences ("Std Dev.")

Standard deviation in % =

$$\frac{\text{Standard deviation}}{\text{Weight of test weight (nominal value of reference weight + error of reference + mean value of differences)}}$$

Standard deviation as value =

$$\sqrt{\frac{1}{n-1} \sum_{i=1}^n (\text{Diff}_i - \text{Mean Diff.})^2}$$

6.4.3 Calculation of the conventional mass value of the test weight ("Error of Test Weight")

Error of test weight = reference error (ref. error) + mean value of the differences (Mean Diff.)

**To protect your METTLER TOLEDO product's future:
METTLER TOLEDO Service assures the quality, measuring accuracy and
preservation of value of all METTLER TOLEDO products for years to
come.
Please send for full details about our attractive terms of service.
Thank you.**



P11780477

Subject to technical changes and to changes in
the accessories supplied with the instruments.

© Mettler-Toledo GmbH 2003 11780477A Printed in Switzerland 0312/2.12

Mettler-Toledo GmbH, Laboratory & Weighing Technologies, CH-8606 Greifensee, Switzerland
Phone +41-1-944 22 11, Fax +41-1-944 30 60, Internet: <http://www.mt.com>