

Operating instructions

METTLER TOLEDO

SG Balances

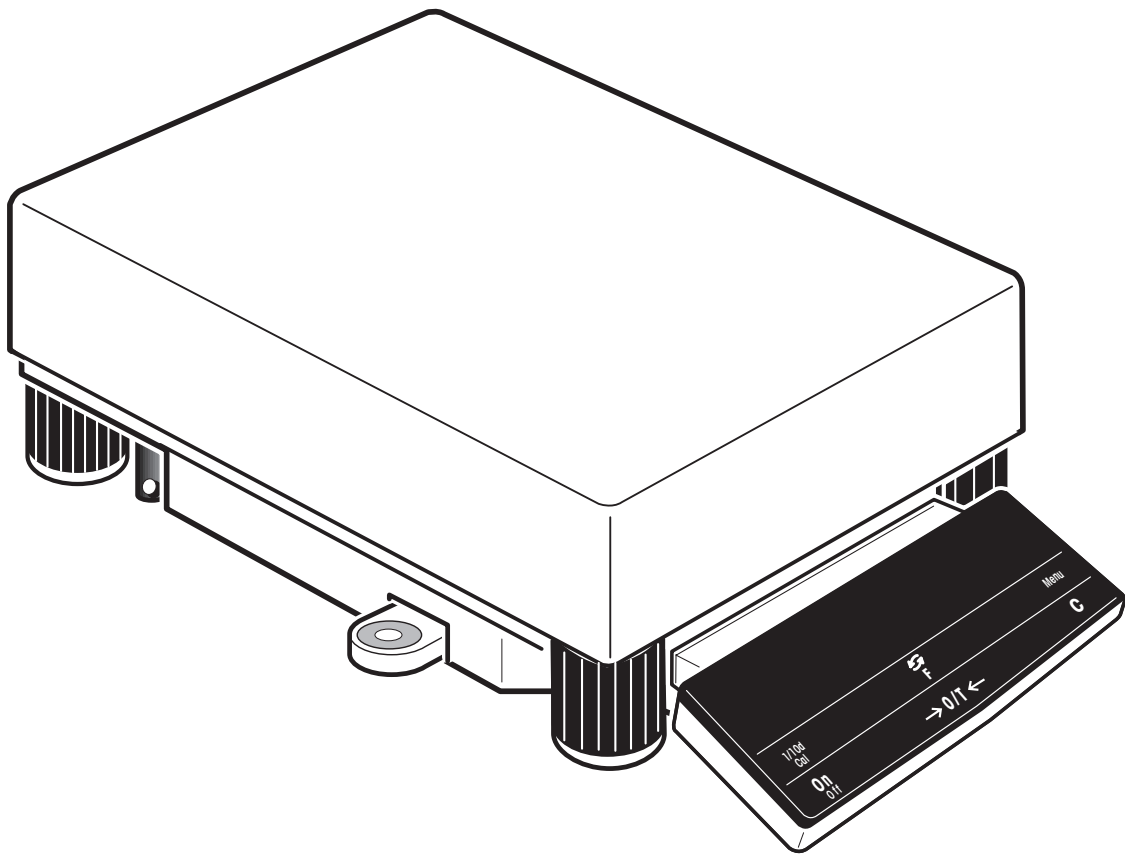

Overview of your SG balance

Front view SG

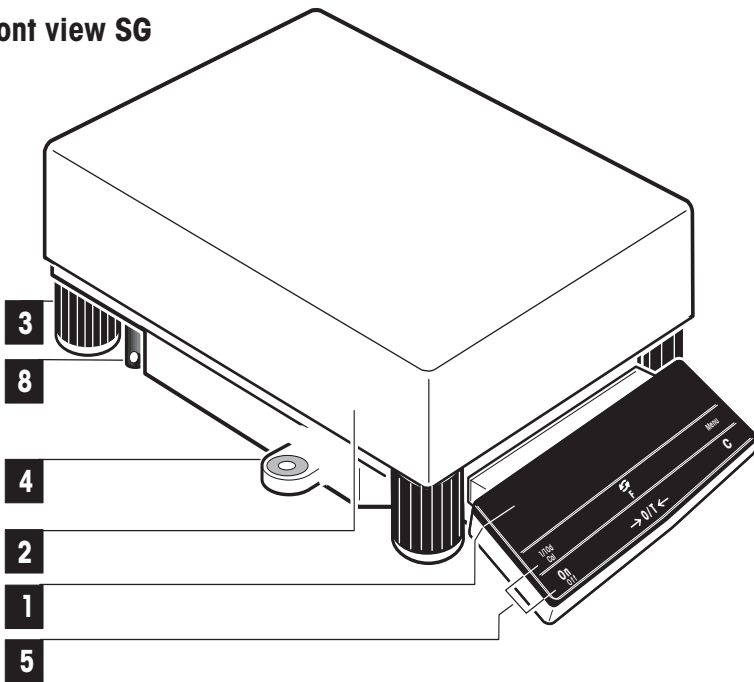

Rear view SG

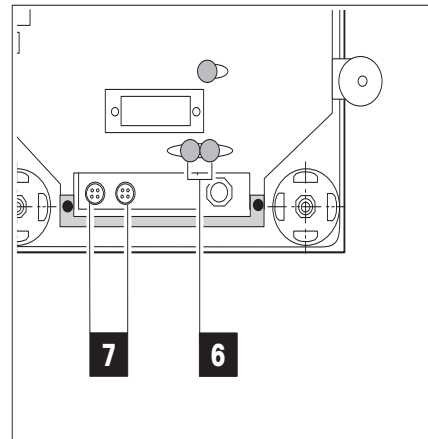

Display SG

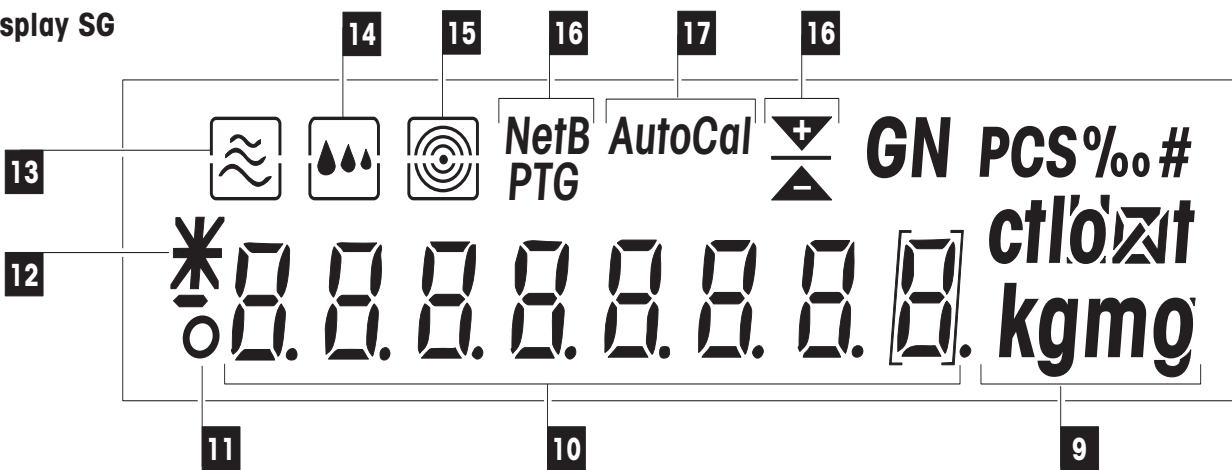

Display, controls and connections of your SG balance

Front

No.	Designation
1	Display
2	Weighing pan
3	Leveling foot
4	Level check
5	Control keys

Rear

No.	Designation
6	Fuses
7	LocalCAN interface connection
8	Fastening for steel wire antitheft device

Display

No.	Designation
9	Weighing units
10	Alphanumeric display (result, menu, etc.)
11	Symbol of the stability detector
12	Symbol for calculated result
13	Status indicator of the vibration adapter

No.	Designation
14	Status indicator of the weighing process adapter
15	Status indicator of the repeatability
16	Function displays for special applications
17	Display of adjustment mode

Contents

1.	Getting to know your SG balance	6
1.1	Introduction	6
1.2	Overview of the SG balances	6
1.3	What you should know about these instructions	7
1.4	Safety has priority	8
2.	Putting the balance into operation	9
2.1	Unpacking and checking the standard equipment	9
2.2	Selecting or changing the location	10
2.3	Leveling the balance	11
2.4	Power supply	11
2.5	Adjusting (calibrating) the balance	12
3.	Weighing made simple	14
3.1	Switching the balance on and off	14
3.2	Taring the balance	15
3.3	Performing a simple weighing	16
3.4	Faster weighing with lower readability	16
3.5	Switching weighing units	17
3.6	DeltaRange balances with movable fine range	18
3.7	Printing out the weighing result and transferring data	18
4.	The menu	19
4.1	What is the menu?	19
4.2	Menu operation	20
4.3	Reset	22
4.4	Selection of the calibration and test function	22
4.5	Switching automatic adjustment call-up on or off	23
4.6	Preselecting a function	24
4.7	Setting the vibration adapter	25
4.8	Setting the weighing process adapter	26
4.9	Selecting the repeatability	27
4.10	Selecting weighing unit 1	28

4.11	Selecting weighing unit 2	29
4.12	Switching the automatic zero-point correction (Auto Zero) on or off	30
4.13	Preselecting the automatic shutdown	31
4.14	Selecting the switch-on mode	32
4.15	Setting display of the icons	32
4.16	Printing out or saving menu settings	33
5.	Special applications and functions	34
5.1	Piece counting	34
5.2	Percent weighing	36
5.3	Formula weighing	37
5.4	Dynamic weighing of unstable weighing samples	41
5.5	Below-the-balance weighings	43
5.6	Adjustment (calibration) with internal weights	44
5.7	Adjustment (calibration) with external weights (VariCal)	46
5.8	Test of the balance with internal or external weight	48
6	Error messages	51
6.1	Preventive maintenance and care	53
6.2	Changing the fuses	54
6.3	Changing the protective cover	54
6.4	LocalCAN universal interface	55
7.	Technical data and optional equipment	56
7.1	General technical data of the SG balances	56
7.2	Dimensions	58
7.3	Optional equipment	59
8.	Appendix	61
8.1	Overview of menu	61
8.2	Conversion table for weight units	62
8.3	SOP (Standard Operating Procedure)	63
8.4	Index	65

1. Getting to know your SG balance

The section provides you with detailed information on your SG balance. Please read this section through carefully even if you already have experience with METTLER TOLEDO balances and scales and be sure to familiarize yourself with the safety notes!

1.1 Introduction

Thank you for deciding to purchase a balance from METTLER TOLEDO.

The precision balances of the SG line combine a wide range of weighing functions and setting possibilities with exceptional ease of operation.

Please read through these operating instructions thoroughly so that you can exploit all the possibilities offered by your balance to the full. As soon as you are familiar with the functions of your balance, you will find the short-form operating instructions supplied as standard useful in your daily work.

These operating instructions apply to all balances of the SG line. However, the various models have different equipment and performance features. Where this is important for the operation, special mention is made in the text.

1.2 Overview of the SG balances

The SG balance family comprises various precision balances which differ according to their weighing range, resolution and equipment features.

The models of the SG line have the following features:

- Extremely rugged and chemically resistant construction.
- Convenient keypad for one-hand operation and large size, easily readable display.
- Internal, motorized adjustment (calibration) or test with built-in weight or external weights.
- Built-in functions for piece counting, percent weighing, formula weighing and dynamic weight determination.
- Built-in interface of the latest generation (LocalCAN universal interface) allows the attachment of up to 5 peripheral devices. Devices with an RS232 interface can also be attached via an adapter cable.

A brief word regarding standards, directives and procedures for quality assurance: Your SG balance conforms with all common standards and directives. It supports standard procedures, handicaps, work techniques and records as required by **GLP** (**G**ood **L**aboratory **P**ractice) and **SOP** (**S**tandard **O**perating **P**rocedure). Recording of the sequences of operations and adjustment work is highly important in this connection; we recommend use of the METTLER TOLEDO LC-P45 Printer here. Your SG balance has a CE declaration of conformity and METTLER TOLEDO as the manufacturer has been awarded ISO 9001 certification.

Certified versions of SG balances are also available, please ask your METTLER TOLEDO dealer.

1.3 What you should know about these instructions

These instructions contain orientation aids which facilitate your search for the desired information.

Work steps are marked by “•”, whereas enumerations are preceded by a “–”.
Key designations are enclosed in double angle brackets (e.g. «**On/Off**» or «**↔**»).



The keys of your SG balance have two assignments: The first function of a key (e.g. “**1/10d**”) is always available by pressing the key briefly, whereas the second function (e.g. “**Cal.**”) is called up by pressing and holding the key.



This symbol indicates a brief keystroke.



This symbol indicates a long, sustained keystroke (approx. 2 seconds).



This representation symbolizes the current display of your balance.

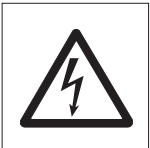

These symbols indicate safety and hazard instructions which must be complied with. Noncompliance with such instructions can lead to personal injuries to the user, damage to the balance or other tangible assets or to malfunctions.

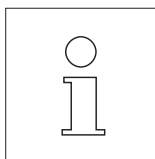

This symbol indicates additional information and instructions which facilitate your handling of the balance and contribute to proper and economical use.

1.4 Safety has priority



Please note the following instructions for safe and problem-free operation of your SG balance.

Read through these operating instructions carefully, even if you already have experience with METTLER TOLEDO balances and scales.

It is essential to note the instructions in section 2 when putting your new balance into operation.

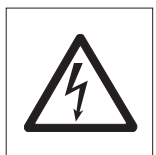

Use SG balances only in closed rooms.

They may not be operated in hazardous areas and must be connected only to a receptacle-outlet with grounding connection.

Ensure that the printed voltage value matches the local line voltage.

Operate and use your SG balance only according to the directions in these operating instructions or the short-form operating instructions.

Use only optional equipment and peripherals supplied by METTLER TOLEDO with your SG balance; these have been optimally matched to your balance.

Your SG balance has a very rugged construction, but it is still a precision instrument. Treat it with the appropriate care and it will thank you with years of trouble-free operation.

Never open the balance, it contains no parts which can be maintained, repaired or replaced by the user. Should you have problems with your balance on the odd occasion, please contact your responsible METTLER TOLEDO dealer.

2. Putting the balance into operation

In this section you will learn how you unpack and set up your new balance and prepare it for operation. On completion of the steps described in this section, your balance is ready for operation.

2.1 Unpacking and checking the standard equipment

SG balances are supplied in an environmentally harmless package.
Please check the standard equipment of your balance for completeness:

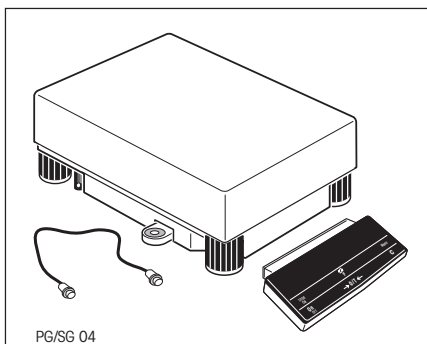

SG balances

- Operating instructions
- Short-form operating instructions
- Weighing pan
- Terminal with holder
- Terminal connection cable
- Protective cover over terminal

2.2 Selecting or changing the location

Your balance is a precision instrument and will thank you for an optimum location with high accuracy and dependability.

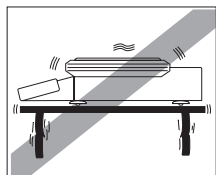

Firm, vibration-free position as horizontal as possible.

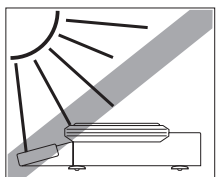

No direct sunlight.

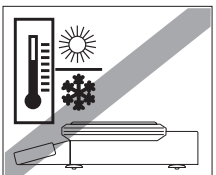

No excessive temperature fluctuations.

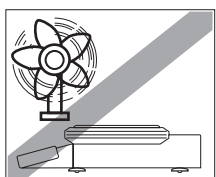

No excessive drafts (powerful air conditioning systems can also cause drafts).

You will find further tips for an optimum location in section 6.1.

2.3 Leveling the balance

Procedure with SG balances

- Screw one of the four leveling feet in completely.

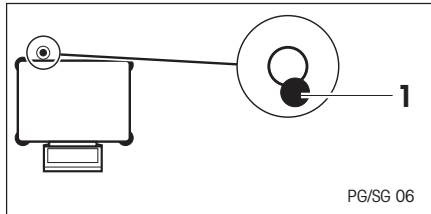

Level balance using the **three** remaining leveling feet, which should all be at the same level.

Unscrew the leveling foot you first screwed in until it touches the support.

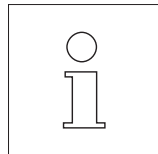

- The balance must be leveled each time its location is changed.

2.4 Power supply

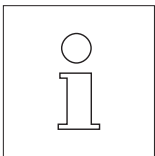

SG balances adapt themselves **automatically to a line voltage** between 100 V and 240 V 50/60 Hz.

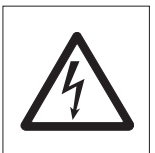

SG balances can be made dead only by disconnecting the power plug. The receptacle-outlet must therefore be in the vicinity of the balance and easily accessible. SG balances may be operated only with a power supply with grounding conductor.

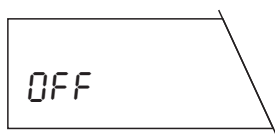

The balance now performs a self-test in which all display segments light up briefly. "OFF" then appears in the display ("OFF" indicates that the balance has been disconnected from the power supply).

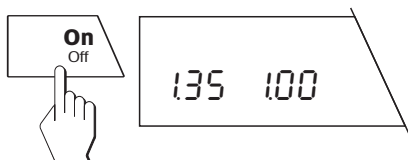

Press the «**On/Off**» key. The display briefly provides information on the installed software version and the normal weight display then appears.

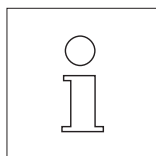

Allow your balance to warm up for 30 minutes to enable it to adapt itself to the ambient conditions.

2.5 Adjusting (calibrating) the balance

An adjustment (i.e. adjustment to the acceleration due to gravity) is needed when putting into operation for the first time and after every location change. In colloquial language, this operation is frequently also referred to as "calibration" (to avoid misunderstandings, this term is enclosed in brackets when necessary). You should also adjust (calibrate) your balance

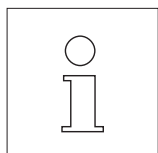

at regular intervals in weighing operation to obtain precise results. If you work according to **GLP** (Good Laboratory Practice) and **SOP** (Standard Operating Procedure), please note the stipulated intervals for the adjustment (calibration).

Your balance is equipped with an automatic adjustment or test procedure. If it is outside the adjustment tolerance, the balance uses a flashing display «**Cal**» to prompt you to adjust (calibrate) with the internal weight at a keystroke or with an external weight. With certified balances, the adjustment (calibration) is performed automatically with the internal weight in compliance with the relevant national weights and measures legislation. Adjustment (calibration) with external weights is not allowed under weights and measures legislation. You can also choose between the internal and an external weight when checking the adjustment. In the factory, the balance is set for adjustment with the built-in adjustment weight. You will find information on how to select the type of adjustment and how to perform the adjustment with an external weight in sections 4.4 and 5.7.

When putting your new balance into operation for the first time, we recommend adjusting (calibrating) it with the **internal weight** after the warm-up phase. Proceed as follows:

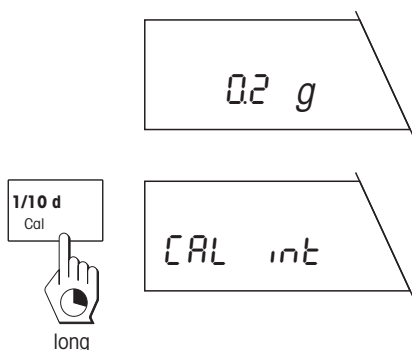

Ensure that the weighing pan is unloaded. There is no need to tare the balance before adjustment (calibration).

Initiate the adjustment operation by pressing and holding the «**Cal**» key. The balance shows briefly that adjustment (calibration) is being performed with the internal weight.

The following displays appear during the adjustment:

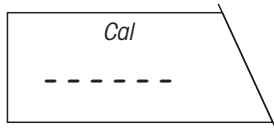

The internal weight is loaded.

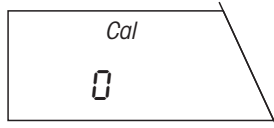

The internal adjustment weight is raised.

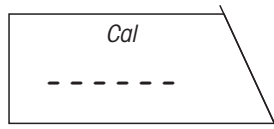

The balance processes the adjustment results.

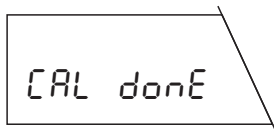

The balance reports successful completion of the adjustment (calibration).

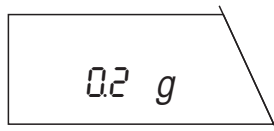

The balance automatically returns to the weighing mode.

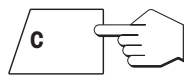

You can abort an ongoing adjustment (calibration) at any time by briefly pressing the «C» key.



If the adjustment (calibration) can not be performed properly (e.g. owing to vibrations), the balance stops the adjustment process and the display shows "Abort". Press the «C» key to clear this message and restart the adjustment operation.

```

--BALANCE CALIBRATION--
18.01.94      11:23:34

METTLER TOLEDO
Balance
Type:         SG32000
SNR:         1105238536

Int. calibration done

Signature:

.....
----- END -----
    
```

If your balance is connected to a printer, the adjustment (calibration) is recorded automatically. The record opposite is a specimen printed out using the METTLER TOLEDO LC-P45 Printer. In this case, the internal adjustment (calibration) has been initiated by the printer. Depending on the attached printer, the printout may differ somewhat from the example shown.

3. Weighing made simple

This section shows you how to perform simple weighings, how you can accelerate the weighing process and print out the weighing result and transfer data.

3.1 Switching the balance on and off

Your balance is set in the factory so that it automatically switches to the weighing mode when you load a weight in the standby mode.

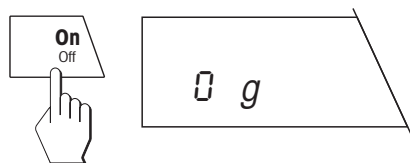

To **switch the balance on**, press the «**On/Off**» key **briefly**. As soon as the normal weight display appears, your balance is ready to weigh.

Note

In section 4 you will learn how to perform a display test in which all segments of the display light up briefly when you switch on the balance.



To **switch the balance off**, press the «**On/Off**» key and keep it pressed until the message "OFF" appears in the display.

After it has been switched off, your balance is in the standby mode. If you wish to perform a weighing, you need now only place the sample on the weighing pan and your balance immediately displays the result. There is no need to switch it on with the «**On/Off**» key.

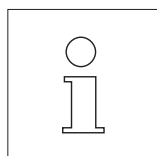

As your balance needs no warm-up time when in the standby mode and is immediately ready for weighing, we advise you to switch off the instrument only by use of the «**On/Off**» key and not to disconnect it from the power supply. This also ensures that the balance is always in thermal equilibrium.

3.2 Taring the balance

The weight of any weighing container can be "tared" at a keystroke to set the display to zero. The taring range covers the entire weighing range of your balance.

If you wish to tare a container, place it on the weighing pan.

Close all draft shield doors.

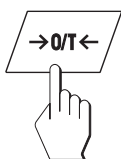

Press the « $\rightarrow 0/T \leftarrow$ » key **briefly** to start the taring operation.

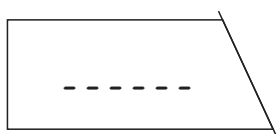

Taring runs automatically. If you tare the balance when it is unstable, the taring procedure will be shown in the display by horizontal segments.

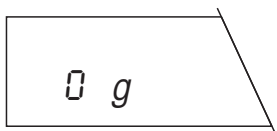

On completion of taring, the zero display appears and your balance is ready for weighing.

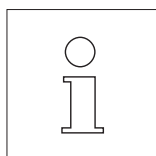

Taring can be aborted by pressing the « $\rightarrow 0/T \leftarrow$ » key again when the balance is in an unstable (not yet tared) condition.

3.3 Performing a simple weighing

Performing a simple weighing is described only for the sake of completeness as this operation comprises only two work steps.

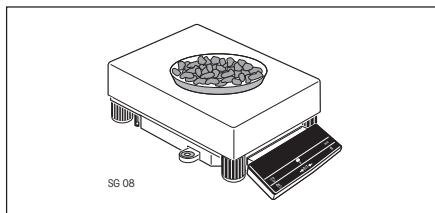

After you have tared the balance, place the weighing sample on the pan.



Wait until the circular symbol of the stability detector fades. Fading of the symbol indicates that the weighing result is stable.



Now read off the weight in the display.

3.4 Faster weighing with lower readability

Your balance allows you to lower the readability (number of decimal places) at any time and thus accelerate the weighing process.



The balance is operating with **normal readability and speed**.

Note

The number of decimal places which are displayed with normal readability depends on the balance model, the weighing range and the selected weighing unit.

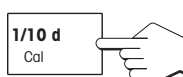

Press the «**1/10d**» key briefly and ...



... the balance operates with **lower readability** (one decimal place less), but displays the result appreciably **quicker**. By pressing the «**1/10d**» key again briefly, you can return to normal readability.

3.5 Switching weighing units

Your balance can display the weighing result in two different weighing units. How you preselect the two weighing units is described in sections 4.10. and 4.11.

You can switch between the two weighing units at a keystroke:

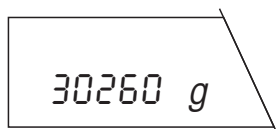

The balance shows the result in **weighing unit 1**.

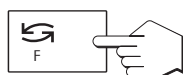

Press the «**G**» key briefly.

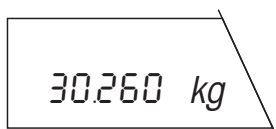

The balance shows the result in **weighing unit 2**. By pressing the «**G**» key again, you can return to weighing unit 1.

Notes

If an additional unit (e.g. “%” or “PCS”) is displayed when switching between the two weighing units, you have preselected a function in the menu. You will find further information on the functions in sections 4.6 and 5.1 through 5.4.

The following weighing units are set in the factory:

For SG balances with 0.1/1 g readability

Weighing unit 1: g (grams)

Weighing unit 2: kg (kilograms)

You will find a table of the conversion factors between the various weighing units in section 8.2.

3.6 DeltaRange balances with movable fine range

METTLER TOLEDO DeltaRange balances have a **movable** fine range with 10 times higher readability. An additional decimal place always appears in the display in this fine range.

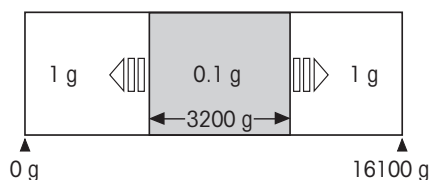

The illustration opposite shows the principle of the movable fine range in which one extra decimal place is shown (in this example, the movable fine range encompasses 3200 grams).

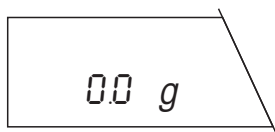

After the balance has been switched on, DeltaRange balances operate in the fine range as standard.

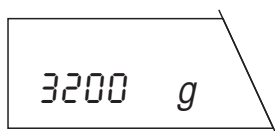

If the fine range in the display is exceeded, the balance display automatically switches to the lower readability.

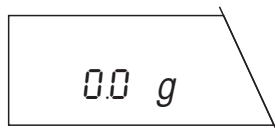

However, the fine range can always be recalled by taring the balance again.

3.7 Printing out the weighing result and transferring data

If your balance is connected to a printer via the LocalCAN universal interface, you can transfer current weighing results, identifications and other data to the attached device with a single keystroke.

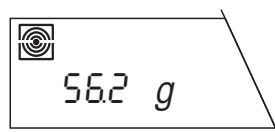
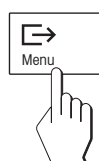

Press the « \rightarrow » key briefly. As soon as the weighing result is stable, the status indicator of the readability fades and the result is transferred to the attached device.

You will find additional information on the attachment of a printer in section 6.4 and in the documentation accompanying your printer.

4. The menu

4.1 What is the menu?

The menu allows you to adapt your balance to your specific weighing needs. You can use the menu to change the settings of your balance and activate functions.

The menu contains **14 different menu options**, each of which offers various selection possibilities.

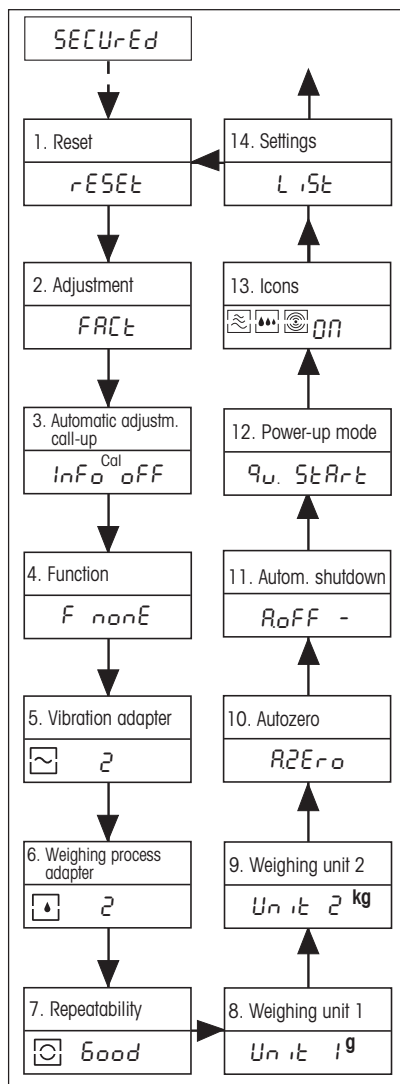

1. **Reset:** Call-up of the factory setting.
2. **Calibration:** Presettings for the type and test of the calibration.
3. **Automatic adjustment**^{1), 3)}: Switch adjustment call-up to the display **call-up** on or off.
4. **Function**²⁾: Preselection of the function which should be available at a keystroke in weighing operation.
5. **Vibration adapter:** Matching the balance to the ambient conditions.
6. **Weighing process adapter:** Matching the balance to different types of weighing.
7. **Repeatability:** Selection of the repeatability of the weighing results.
8. **Weighing unit 1**¹⁾: Definition of the 1st weighing unit in which the balance should show the result.
9. **Weighing unit 2**²⁾: Definition of the 2nd weighing unit in which the balance should show the result.
10. **Zero-point correction:** Switch automatic zero-point correction (Auto Zero) on or off.
11. **Automatic shutdown:** Preselection of the time after which the balance should be switched off automatically.
12. **Switch-on mode**¹⁾: Start without or with display test.
13. **Icons:** On or off switching of the icons.
14. **Settings:** Saving or printing out all menu settings.

¹⁾ With certified balances, these menu options have a fixed setting and can not be changed.

²⁾ With certified balances, only those weighing units/functions allowed by national weights and measures legislation can be selected.

³⁾ This menu option is shown only if "FACT" or "CAL OFF" has **not** been selected in menu option 2.

Note: You will find an overview diagram of the entire menu with all setting options in section 8.1.

4.2 Menu operation

In the section you will learn how to work with the menu. You will find information on the individual menu options and the available settings in the following sections.

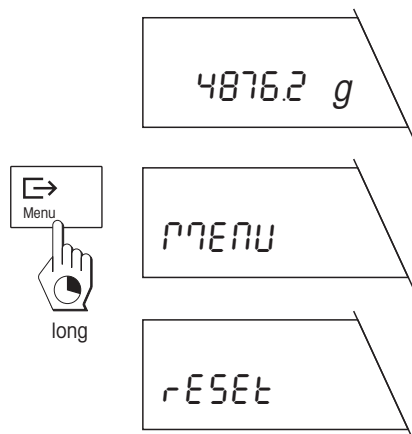

How to switch from the weighing mode to the menu

The balance operates in the normal weighing mode.

Press and hold the **«Menu»** key until the balance switches to the menu.

After release of the **«Menu»** key, the balance shows the first menu option ("Reset") directly with the current setting.

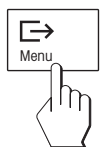

How to select the menu options

Briefly press the **«Menu»** key.

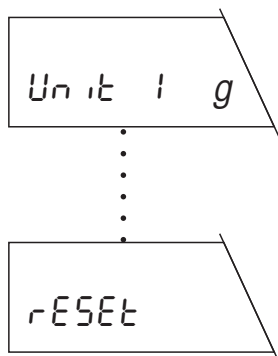

The next menu option appears in the display. Each time the **«Menu»** key is pressed, the balance switches to the following menu option.

After the fourteenth and last menu option ("Settings"), the first menu option ("Reset") is again shown.

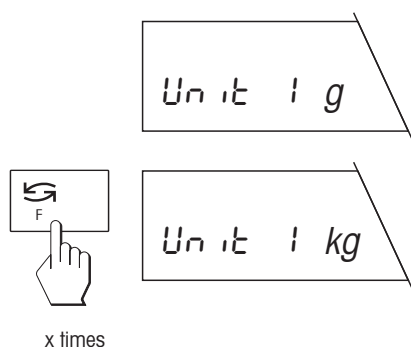

How to select the desired setting in a menu option

Briefly press the «**F**» key. The display shows the next setting available in the selected menu option. Each time the «**F**» key is pressed, the balance switches to the next setting. After the last setting, the first is shown again.

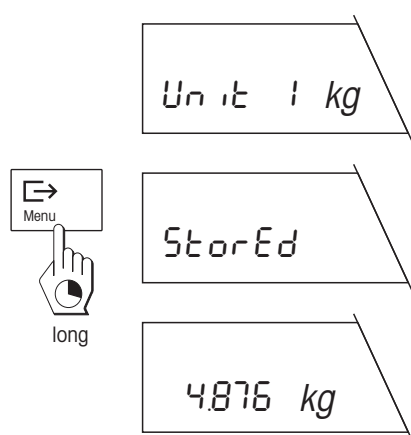

How to save your settings and quit the menu

After you have made all settings in the individual menu options, press and hold the «**Menu**» key until the balance returns to the weighing mode.

Before the normal weighing result display appears, the balance briefly confirms storage of the settings.

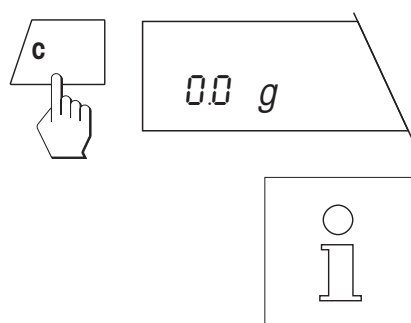

How to quit the menu without saving your settings

By briefly pressing the «**C**» key, you can return to the weighing mode at any time **without changing the stored settings.**

If you do not press a key for 45 seconds, the balance **automatically** returns to the weighing mode. Changes you have made in the menu will **not be stored!**

4.3 Reset

In this menu option you have the possibility to reset all menu settings to the factory setting.

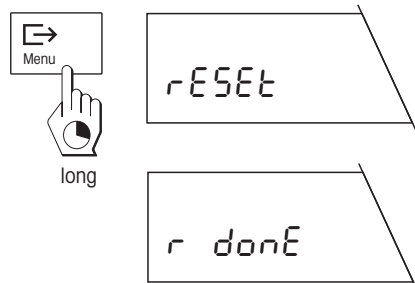

Resetting settings to factory setting

If you select this option and then save and quit the menu, all menu settings are reset to the values set in the factory.

Before the return to the weighing mode, the resetting is briefly confirmed in the display.

4.4 Selection of the calibration and test function

Your balance can be calibrated with internal or external weights. Further, the balance can also be checked by a test with internal or external weights. If you have attached a printer to your balance, the data of the calibration and results of the test are printed out following GLP recommendations.

The following settings are available:

Fully automatic internal adjustment (calibration) FACT (Fully Automatic Calibration Technology)

This is the factory setting. The balance adjusts (calibrates) itself fully automatically. With certified versions of the balances, this function is always active even if a different setting has been preselected in the menu; FACT does thus not appear at all here.

- after the warm-up phase following connection to the power supply,
- when a change in the ambient conditions, e.g. the temperature could lead to a noticeable measurement deviation.

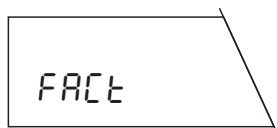

No adjustment function preselected.

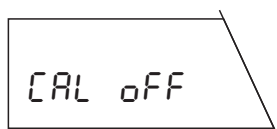

Internal calibration

The balance is calibrated at a keystroke with the built-in weight.

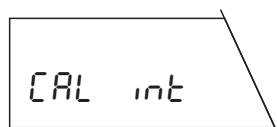

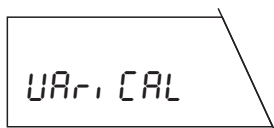

Calibration with external weights (VariCal)

The balance is calibrated with a selectable* external weight.

* With certified versions of the balances, the weight is preallocated and can not be changed.

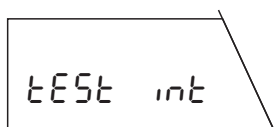

Test of the balance with internal weight

In this setting the accuracy test of the balance is performed with the internal weight.

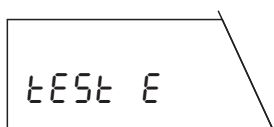

Test of the balance with external weights

The accuracy of the balance can be checked with any external weight.

You will find information on how to perform the calibration and test function in sections 2.5, 5.6 and 5.7.

4.5 Switching automatic adjustment call-up on or off

In this menu option you can switch the call-up of the automatic adjustment or test on or off.

Note: If you have set «FACT» in the menu option Adjustment (calibration), the automatic adjustment call-up is always active and will thus be skipped in the menu. It becomes active again as soon as «FACT» is switched off.

The following settings are available:

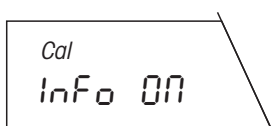

Automatic adjustment or test call-up switched on

This is the **factory setting**. The balance uses a flashing «Cal» in the display to prompt you to adjust (calibrate) or test it with the internal weight or external weights.

The call-up is initiated by, e.g. ambient temperature changes.

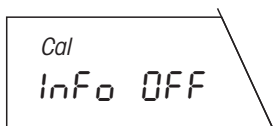

Automatic adjustment or test call-up switched off

The automatic adjustment or test call-up is switched off.

Note

With certified balances, the automatic adjustment or test call-up can not be switched off.

4.6 Preselecting a function

In this menu option you can preselect a function which you will then have available in the weighing mode at a keystroke.

The following functions are available.

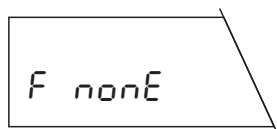

No function preselected

You have no function available in the weighing mode (**factory setting**).

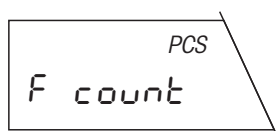

Piece counting

Your balance counts the pieces you add to or remove from the weighing container.



Percent weighing

Your balance allows you to weigh in to a preset value or determines percentage weight deviations.

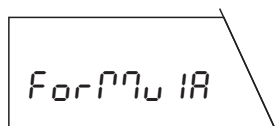

Simple formulation

The formulation function allows you to weigh in up to 255 individual components, store their weights and totalize. If your balance is attached to a printer, all individual weights and the total weight of all components are printed out. Further, up to 99 weighing containers can be tared. Your balance can store and print out the total weight of all weighing containers.

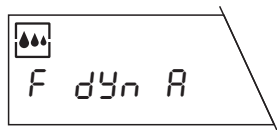

Dynamic weighing with automatic start

Your balance determines an average weighing result over a preset time interval. This setting is suitable for unstable weighing samples (e.g. animals). With this setting, the dynamic weighing starts automatically.

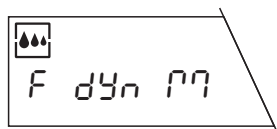

Dynamic weighing with manual start

Analogous to dynamic weighing with automatic start, but the weighing cycle must be started manually.

You will find information on working with the functions in section 5.

4.7 Setting the vibration adapter

The vibration adapter can be used to match your balance to the ambient conditions (vibrations, drafts at location).

The following settings are available:

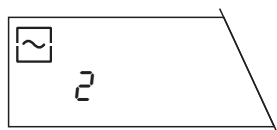

Setting for normal ambient conditions

This is the **factory setting**. The balance operates at moderate speed.

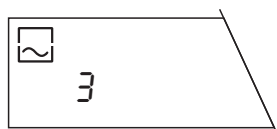

Setting for unstable surroundings

The filter setting of the balance is higher than in the factory setting, but the balance is less sensitive to external influences.

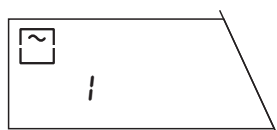

Setting for virtually disturbance-free, stable surroundings

The filter setting of the balance is lower than in the factory setting, but the balance is more sensitive to external influences.

4.8 Setting the weighing process adapter

The weighing process adapter can be used to match your balance to the different types of weighing (absolute weighing, fine dispensing, etc.).

The following settings are available:

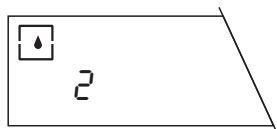

Universal setting

This is the **factory setting**, it is suitable for all types of weighing. The display always corresponds to the current weight.

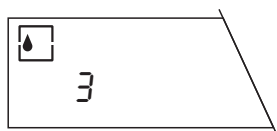

Absolute weighing

This setting is suitable for checkweighing and for the weight determination of samples.



Special applications

In this setting there is a fixed time relationship between the displayed weight value and the weight change.

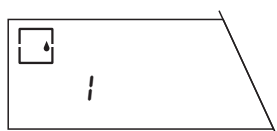

Fine dispensing

This setting is suitable for the weighing-in of fine powder, small amounts of liquids, etc.

4.9 Selecting the repeatability

The circular symbol of the stability detector can be found in the bottom left corner of the display. As soon as the weighing result is within preset limits for a certain period of time, the weighing result is considered stable and the symbol for the stability detector fades. You can use the setting of the repeatability ("Repro-Set") to determine the time period during which the result must lie within the limits for it to be considered stable. The better the repeatability, the longer the weighing operation.

The following settings are available:

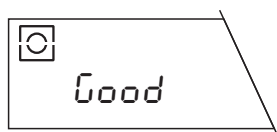

Good repeatability

Fast release of the weight display as stable, this is the **factory setting**.

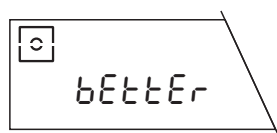

Very good repeatability

Slower release of the weight display as stable.

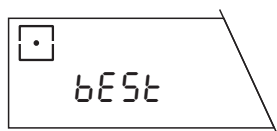

Best possible repeatability

Weight display not released as stable until several seconds have elapsed without change.

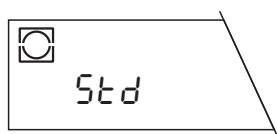

Normal repeatability

The weight display is released very quickly as stable, in other words: The display of the stability detector fades very fast.

4.10 Selecting weighing unit 1

In this menu option you determine the **unit*** in which the weighing result should be displayed.

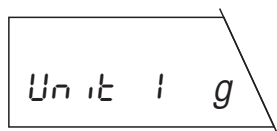

The following units* are available:

Display	Designation
g	gram
kg	kilogram
lb	pound
oz	ounce
ozt	Troy ounce
dwt	pennyweight
ct	carat
mo	momme
m	mesghal

You will find a table with the conversion factors for the different units in section 8.2 of these operating instructions.

* With certified balances, the weighing unit 1 has the fixed setting and can not be changed.

4.11 Selecting weighing unit 2

In this menu option you determine the **additional unit*** in which the weighing result should be displayed.

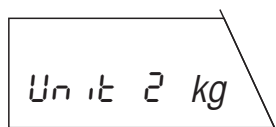

Unit 2 kg

The following units* are available:

Display	Designation
kg	kilogram
lb	pound
oz	ounce
ozt	Troy ounce
dwt	pennyweight
ct	carat
mo	momme
m	mesghal
H tl	Hong Kong tael
S tl	Singapore tael
t tl	Taiwan tael
g	gram

You will find a table with the conversion factors for the different units in section 8.2 of these operating instructions.

* With certified versions of the balances, only the weighing units approved by the national weights and measures legislation may be selected.

4.12 Switching the automatic zero-point correction (Auto Zero) on or off

In this menu option you can switch the automatic zero-point correction on or off. If switched on (factory setting), the zero point is automatically corrected for drift or contamination of the weighing pan.

The following settings are available:

Auto Zero switched on

This is the **factory setting**. The zero point is automatically corrected.



Auto Zero switched off

The zero point is not automatically corrected. This setting is advantageous for special applications (e.g. evaporation measurements).

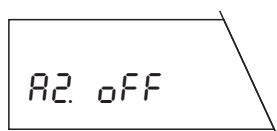

4.13 Preselecting the automatic shutdown

When the automatic shutdown is active, the balance switches itself off automatically after a preselected time (time elapsed after the last operation). When operated from the power supply, the balance is switched to the standby mode after elapse of the shutdown time.

The following settings are available:

No automatic shutdown

The automatic shutdown is deactivated (**factory setting**).

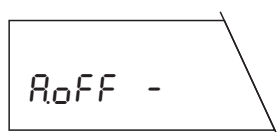

Automatic shutdown after 2 minutes

If the balance has not been operated for 2 minutes, it switches itself off automatically.

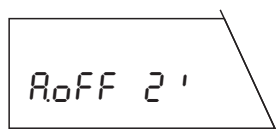

Automatic shutdown after 5 minutes

If the balance has not been operated for 5 minutes, it switches itself off automatically.

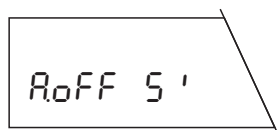

Automatic shutdown after 10 minutes

If the balance has not been operated for 10 minutes, it switches itself off automatically.



4.14 Selecting the switch-on mode

You can set your balance so that it starts immediately from standby when a weight is placed on the pan or so that it must be switched on with the «On/Off» key and then performs a display test.

The following settings are available:

Quickstart*

This is the **factory setting**. The balance can be started directly from standby and is immediately ready for weighing. You can place the weight on the pan in the standby mode and the balance immediately displays the weighing result.

*Quickstart is not possible with certified balances.

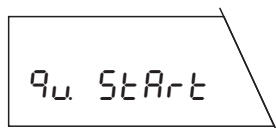

Start with display test

You must switch on the balance with the «On/Off» key. After the balance has been switched on, it performs a display test during which all display segments light up briefly. On completion of the test, the balance is ready for weighing.

Note: If the balance has been separated from the power supply, it always performs a display test after switching on, even if the "Quickstart" setting has been selected.

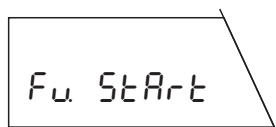

4.15 Setting display of the icons

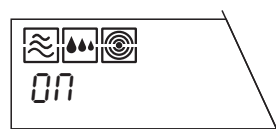

All icons appear in the display.



If desired, you can also switch off the icons. They disappear after about 10 seconds after you have quit the menu or after about 3 min. after the balance has been switched on.

4.16 Printing out or saving menu settings

In this menu option you have the possibility to save all menu settings. You can also print out the current settings of the menu, presupposing your balance is connected to a printer.

Lst

SECURE 1

SECURE 2

Printing out settings

As soon as you save your settings and quit the menu, all settings specified in the menu will be printed out on the attached printer.

With "secure 1" you can protect the menu settings against inadvertent changes.

With "secure 2" you can protect both the menu settings and also the «1/10d» key, which lowers the readability of the display against inadvertent changes.

Note

If the adjustment function "FACT" is set in the menu option, the SG balance also automatically performs an internal adjustment in the setting "secure 2".

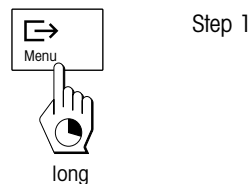

SECUREd



OPEN

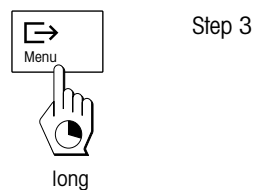

Canceling secure function

If "secure" is selected in the menu, "secure" appears when it is reentered (initiated by the menu key). If you do not press the «G» key for more than 3 seconds, the balance automatically returns to the weighing mode (menu remains blocked).

After the «G» key has been pressed, "Open" appears. Confirm this within 3 seconds by pressing and holding the menu key, entry into the menu is then possible again (menu open).

Note

The release applies to "SECURE 1" and "SECURE 2".

5. Special applications and functions

Your balance can do more than just weigh. Built-in applications and functions expand the possibilities of your balance and facilitate your daily work. The following sections will acquaint you with these applications and functions.

5.1 Piece counting

Piece counting presupposes that you have preselected the function "F count" in the menu (see section 4.6).

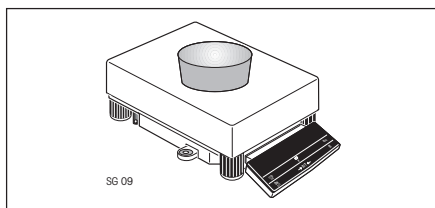

Load the empty container.

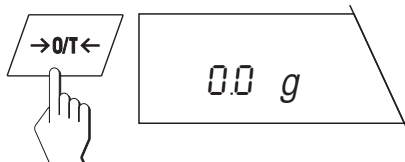

Press the «→0/T←» key to tare the balance.

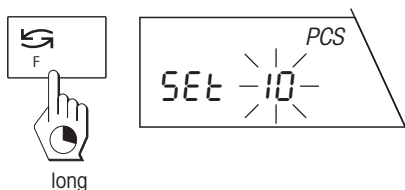

Your balance now needs the weight of a **reference piece number**. Press and hold the «F» key until you are prompted to load the reference piece number.

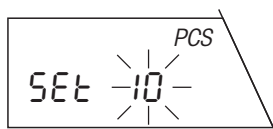

Your balance suggests "10" as reference piece number. You can accept this suggestion or select one of the other available reference piece numbers (20, 30, 50, 100 or 5 pieces) by briefly pressing the «↻» key.

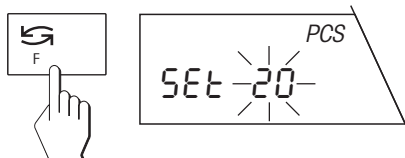

Note

We advise you to select a reference piece number as large as possible as the balance determines the average weight per piece and saves it as the reference weight. As it is seldom the case that all pieces have exactly the same weight, the accuracy of the reference weight increases with increasing reference piece number.

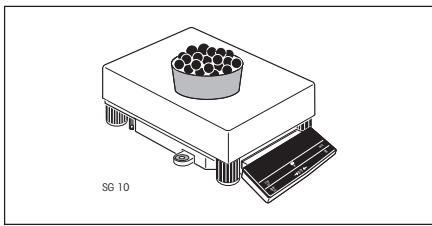

Now load the selected number of reference pieces.

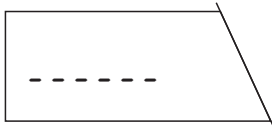

Then briefly press the «Menu» key. As long as the horizontal dashes are displayed, the balance is calculating the reference weight.

Note

If you do not press a key for 45 seconds, the balance returns to the weighing mode.

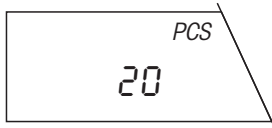

After your balance has determined the reference weight, it shows the correct piece number and is now ready for piece counting.

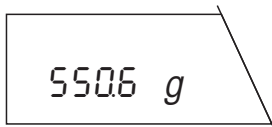
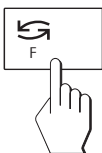

You can use the «F» key at any time to switch the display between the piece number display, weighing unit 1 and weighing unit 2.

Note

The current set weight remains stored until it is redetermined or the power supply of the balance is interrupted.

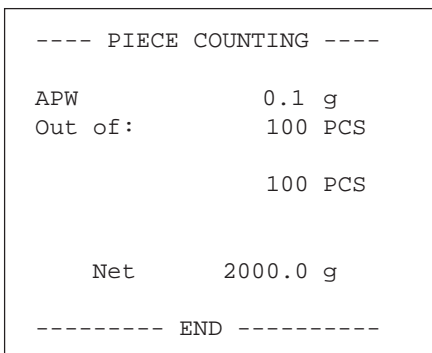
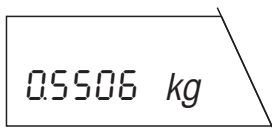
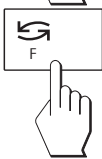

If a printer is connected to your balance, the reference weight, the reference piece number, the total piece number as well as the net weight of the total piece number are printed out.

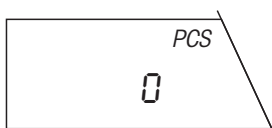
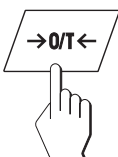

Note

If a printer is attached, start a new piece counting with the «→O/T←» key.

5.2 Percent weighing

The “Percent weighing” function allows you to weigh in to a preset value (100%) and determine the deviations from this target value.

Percent weighing presupposes that you have preselected the function “F 100%” in the menu (see section 4.6.).

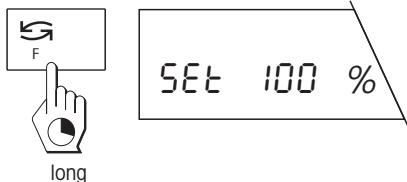

Your balance needs a reference weight that should correspond to 100 %. Press and hold the «F» key until you are prompted to load the reference weight.

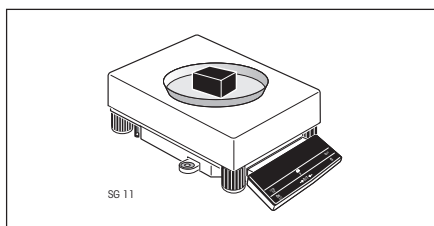

Now load the reference weight.

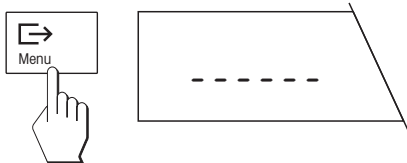

Then briefly press the «Menu» key. As long as the horizontal dashes are shown, your balance is calculating the reference weight.

Note

If you do not press a key for 45 seconds, the balance returns to the weighing mode.

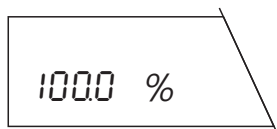

On completion of the weighing-in procedure, your balance is ready for percent weighing.

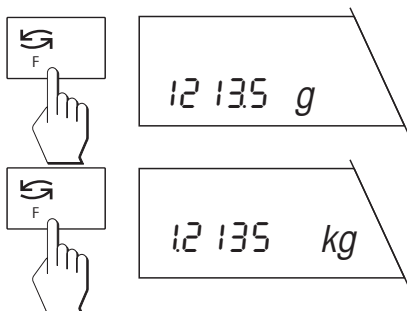

You can use the «F» key at any time to switch the display between percent display, weighing unit 1 and weighing unit 2.

Note

The current piece weight remains stored until it is redetermined or the power supply of the balance is interrupted.

5.3 Formula weighing

With the formula weighing function you can weigh and totalize individual weights (components). Your balance processes up to 255 components per formula weighing operation. In addition, you can tare up to 99 weighing containers for each formula weighing operation. If your balance is connected to a printer, the entire formula weighing operation can be recorded.

Formula weighing presupposes that the function "Formula" has been preselected in the menu (see section 4.6).



Switch the balance and the printer (if used) on.

Unload the weighing pan.

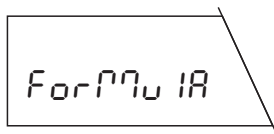
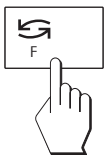

Press the «**F**» key briefly and the display confirms that the formula weighing function is active.

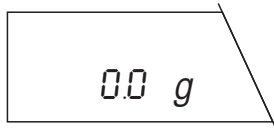

After 2 seconds, the normal weight display appears.

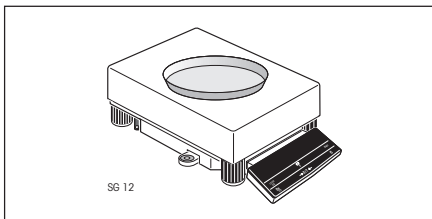

If you wish to tare a weighing container, place this on the pan.

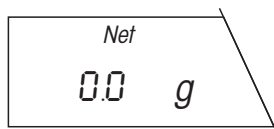

Then press the «**→0/T←**» key briefly.

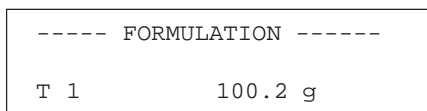

If your balance is connected to a printer, the tare weight is printed out.

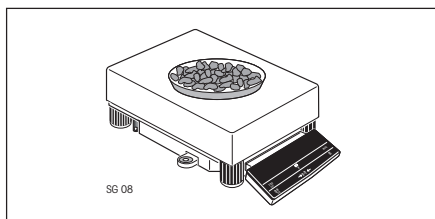

Add the first component to the weighing container.

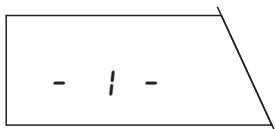
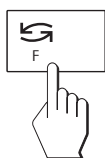

Then press the «» key briefly. The display shows “- 1 -” briefly to confirm the weighing in of the first component.

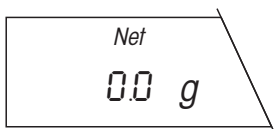



After weighing in of the first component, the display is reset to zero and the balance is now ready for weighing in of the second component.

----- FORMULATION -----		
T 1		100.2 g
1	Comp.	12.0 g

If a printer is attached, the weight of the components is printed out.

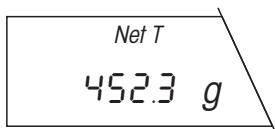
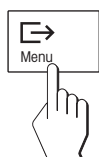
Now weigh in the additional components as described above.



As soon as you have weighed in all components, press the «» key briefly to end the formula weighing operation. The total weight of all individual components is displayed briefly.

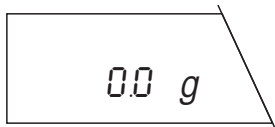

The balance then returns to the normal weighing mode.

The weight memories for tare and net total are now cleared and the balance is ready for the next formulation.

----- FORMULATION -----		
T 1		100.2 g
1	Comp.	12.0 g
2	Comp.	2.5 g
3	Comp.	3.3 g
T total		100.0 g
G		117.8 g
N total		17.8 g
----- END -----		

If a printer is attached to your balance, a record with the net total weight of all components, the tare weight (weight of the weighing container) and the gross total weight (total weight of all components plus tare weight) is printed out.

During the formula weighing operation you can increase the net total weight to a desired value

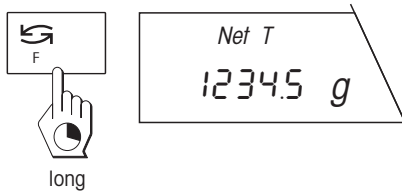

Press and hold the «F» key until the net total weight of all components weighed in so far is displayed.

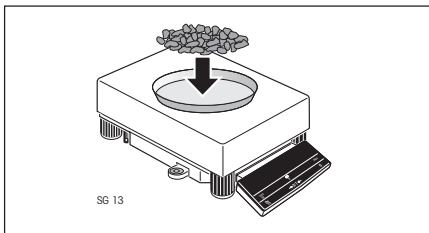

Now add the component to the container until the desired net total weight is reached.



Press the «G» key briefly and the desired weight is confirmed as an additional component.

During the formula weighing operation you can always display the totalized total weight and the number of the components weighed in so far

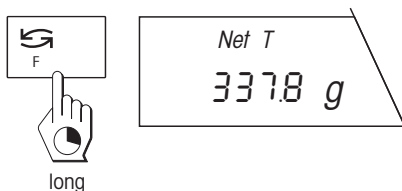

Press and hold the «F» key until the total weight of all components weighed in so far is displayed.

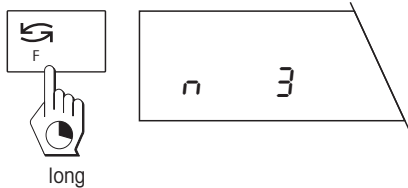

Press and hold the «F» key again until the number "n" of all components weighed in so far is displayed.

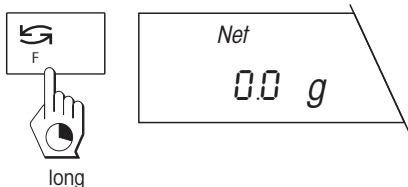

Press and hold the «F» key again until the balance switches back to the weight display. You can now weigh in additional components.

During the formula weighing operation you can always tare additional weighing containers

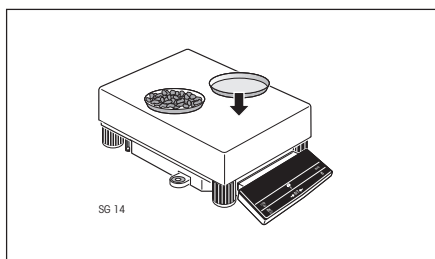

Place the additional weighing container on the weighing pan next to weighing containers already tared.

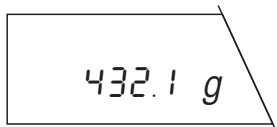

Press the «>0/T<» key briefly. The balance is now tared with the additional weight of the new weighing container. If your balance is connected to a printer, the tare weight of the new container is printed out. You can now weigh in additional components.

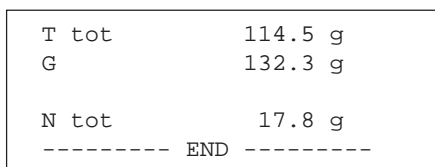

If you print out the results at the end of the formula weighing operation, all tare weights are totalized and the total weight of all tare containers ("T tot") is recorded.

5.4 Dynamic weighing of unstable weighing samples

The functions "Dynamic weighing with automatic start" and "Dynamic weighing with manual start" facilitate your weighing of unstable weighing samples (e.g. animals). With this type of weighing, your balance determines the weight over a particular time period and calculates a representative mean value.

Dynamic weighing presupposes that you have preselected the function "F dyn A" or "F dyn M" in the menu (see section 4.6).

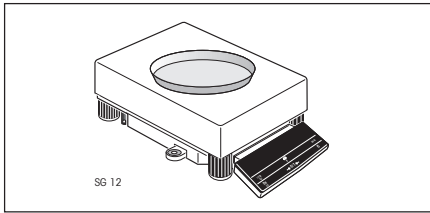

If you are working with a weighing container, place it on the weighing pan in the normal weighing mode.

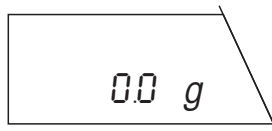
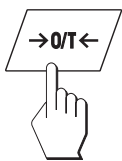
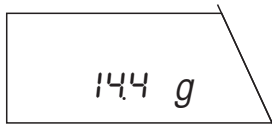

Press the «→0/T←» key to tare the balance.

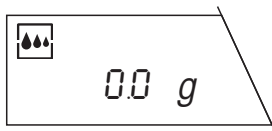
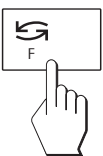

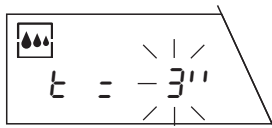
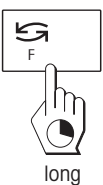

Press the «» key briefly. The symbol of the weighing process adapter in the display confirms that dynamic weighing has been activated.

Your balance is set in the factory so that the weight is determined over a period of 3 seconds. You need perform the following 3 steps only if you wish to change this time interval.

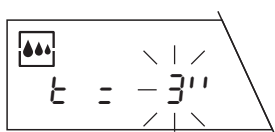

Press and hold the «F» key until the time display appears.



By pressing the «» key briefly you can select one of the available time intervals (1, 2, 3, 5, 10 or 20 seconds).

Notes

The more unstable the weighing sample, the longer the time interval which should be selected.

If you do not press a key for 45 seconds, the balance quits the display without changing the inputted value.

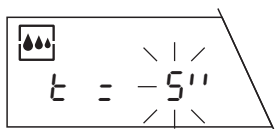
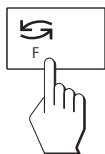

Then press the «» key briefly to confirm the selected time interval.

Your balance is now ready for dynamic weighing.

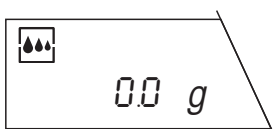
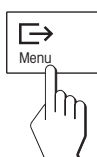

Load the weighing sample.

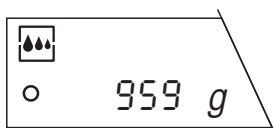

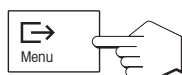

If you have selected the function "Dynamic weighing **with automatic start**" in the menu, the weighing starts automatically on relative stability. However, the **weighing sample must weigh at least 5 grams.**

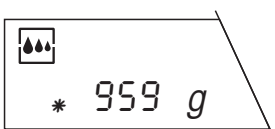
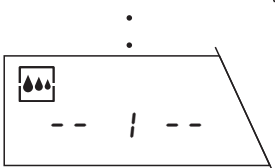
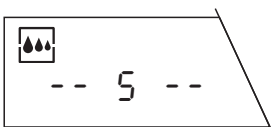

If you have selected the function "Dynamic weighing with **manual start**" in the menu, press the «» key briefly to start the weighing.

The remaining weighing time is displayed continuously.



On elapse of the weighing time, read off the result. The asterisk symbol "*" lights up in the lower left corner of the display. This symbol indicates that the value is the mean value of the performed weighings, in other words a **calculated result**. The result remains in the display unit the weighing sample is removed. If you wish to weigh the same weighing sample again, press the «» key briefly.

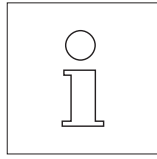

The set weighing time (time interval) remains stored until it is changed or the power supply of the balance is interrupted.

By **briefly pressing** the «» key, you can switch between the normal weighing mode and dynamic weighing at any time.

By **pressing and holding** the «**F**» key when in the dynamic weighing mode, you can recall the preselected time interval to the display and change it.

5.5 Below-the-balance weighings

Your balance is fitted with a hanger for below-the-balance weighings.

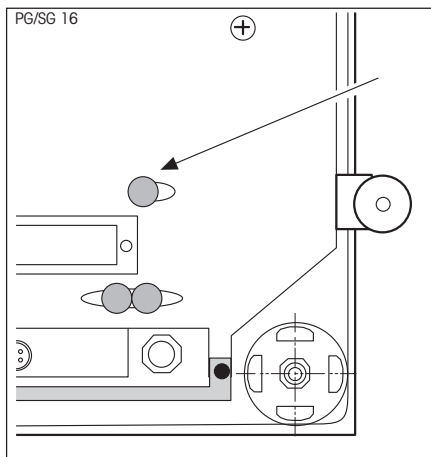

For SG balances

Remove plastic cover on the underside of the balance.

5.6 Adjustment (calibration) with internal weight

Depending on the setting selected in the menu (see section 4.4), the adjustment (calibration) can be performed with the built-in, internal weight fully automatically (FACT) or semi-automatically.

Fully automatic internal adjustment (calibration) FACT

Your balance is set in the factory for the fully automatic adjustment with the internal adjustment weight. You are already familiar with this setting from sections 2.5 and 4.4.

Semi-automatic adjustment (calibration)

If your balance is outside the adjustment tolerance and depending on whether you have set the automatic adjustment call-up in the menu (see section 4.6), the balance uses a flashing «**Cal**» in the display to prompt you to adjust (calibrate) with the internal weight at a keystroke. With certified balances, the adjustment (calibration) with the internal weight is performed automatically in accordance with the national weights and measures legislation.

If you wish to adjust your balance with the internal weight, proceed as follows:

Make sure that "FACT" or the "Adjustment (calibration) with internal weight (Cal int)" is selected in the menu (see section 4.4).

Ensure that the weighing pan is unloaded and close the doors of the draft shield (if used). There is no need to tare the balance before the adjustment (calibration).

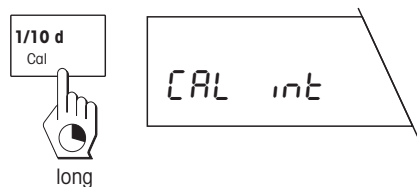

Start the adjustment operation by pressing and holding the «**Cal**» key. The balance briefly shows that adjustment (calibration) is being performed with the internal weight.

Note

If "SECURed 2" is switched on in the menu, the  key is blocked.

The following displays appear during the adjustment (calibration):

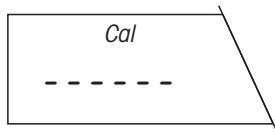

The internal adjustment weight is being loaded.

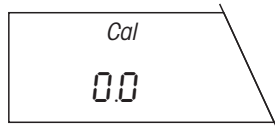

The internal adjustment weight is being raised.

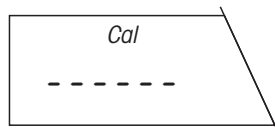

The balance is processing the adjustment results.

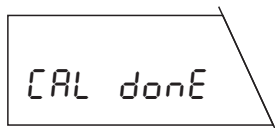

The balance reports successful completion of the adjustment (calibration).

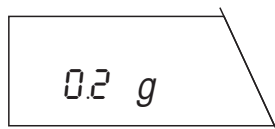

The balance automatically returns to the weighing mode.

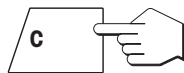

You can always abort an ongoing adjustment (calibration) by briefly pressing the «C» key.



If the adjustment (calibration) can not be performed properly (e.g. as a result of vibrations), the balance aborts the adjustment operation and "Abort" appears in the display. Press the «C» key to clear this message and restart the adjustment operation.

```

--BALANCE  CALIBRATION--
03.02.97      11:23:34

METTLER TOLEDO
Balance
Type:          SG32000
SNR:           23001222

Int. calibration done

Signature:

.....
-----  END  -----
  
```

If your balance is connected to a printer, the adjustment (calibration) is recorded automatically in conformance with GLP. The record shown opposite is a specimen printed with the METTLER TOLEDO LC-P45 Printer. Depending on the attached printer, the printout may differ somewhat from the example shown.

5.7 Adjustment (calibration) with external weights (VariCal)

Depending on the setting selected in the menu (see section 4.4), the adjustment (calibration) can be performed with the built-in weight or with an external weight. In the factory setting, the balance is set to adjustment with the internal weight, which you are already familiar with from section 2.5.

If you wish to adjust your balance with an external weight, proceed as follows (the adjustment (calibration) with external weights is not possible with certified balances):

Make sure that "Adjustment (calibration) with external weights (VariCal)" is selected in the menu (see section 4.4).

Ensure that the weighing pan is unloaded and close the doors of the draft shield. There is no need to tare the balance before the adjustment (calibration).

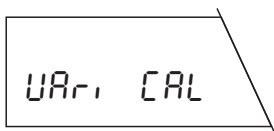
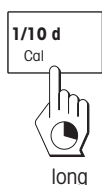

Start the adjustment operation by pressing and holding the «**Cal**» key. The balance shows briefly that adjustment is performed with an external weight.

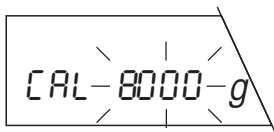

The balance now prompts you to select the desired weight.

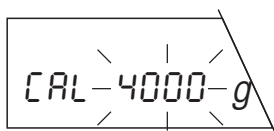
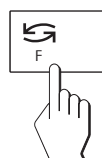

If you do not wish to adjust with the suggested weight, you can select a different weight by pressing the «» key briefly. The available weights depend on the balance model.

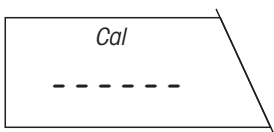
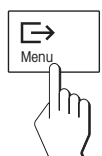

Confirm the selected weight with the «» key. This initiates the adjustment process. The balance determines the zero point.



You are then prompted to load the weight.

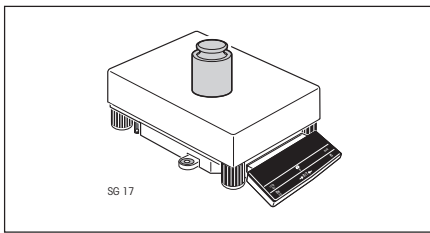

Place the requested weight in the middle of the weighing pan.

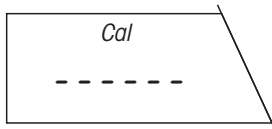

During the adjustment, the horizontal segments are displayed.

Note

You can abort the ongoing adjustment at any time by pressing the «C» key briefly.



On completion of the adjustment operation, you are prompted to remove the weight. Lift off the weight.

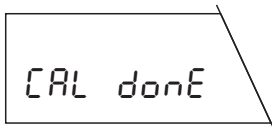

After the removal of the weight, the balance shows the end of the adjustment operation and then returns to the weighing mode.

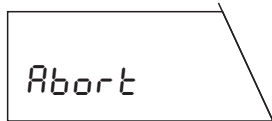
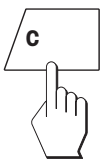

Note

If the adjustment (calibration) can not be performed properly (e.g. as a result of vibrations), the balance aborts the adjustment operation and "Abort" appears in the display. Press the «C» key to clear this message and restart the adjustment operation.

```

--BALANCE  CALIBRATION--
26.01.94      11:34:23

METTLER TOLEDO
Balance
Type:         SG32000
SNR:         1105238536

Weight ID:.....
Weight:       4000 g

Ext. calibration done

Signature:

.....
-----  END  -----
    
```

If your balance is connected to a printer, the adjustment is recorded automatically. The record shown opposite is a specimen printed with the METTLER TOLEDO LC-P45 Printer. In this case, the external adjustment was initiated by the printer. Depending on the attached printer, the printout may differ somewhat from the example shown.

5.8 Test of the balance with internal or external weight

You can always test the accuracy of your balance. This test is performed either with the built-in weight or with external weights, depending on your setting in the menu (see section 4.4).

Test the balance with the internal weight

Make sure that the "Test of the balance with the internal weight" is selected in the menu (see section 4.4).

Ensure that the weighing pan is unloaded and close the doors of the draft shield. There is no need to tare the balance before the test.

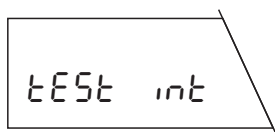
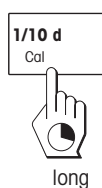

Initiate the test procedure by pressing and holding the «Cal» key. The balance briefly confirms that the test is being performed with the internal weight.

The following displays appear during the test:

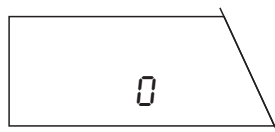

The balance determines the zero point.

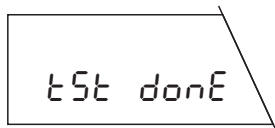

The balance confirms that the test has been performed.

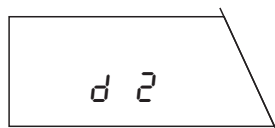

Over a period of 10 seconds, the balance now shows the difference (deviation) between the adjustment (calibration) and the current test weighing.

On completion of the test, the balance automatically returns to the weighing mode.

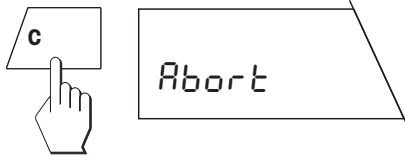

Notes

You can always abort an ongoing test by pressing the «C» key briefly.

If the test can not be performed properly (e.g. as a result of vibrations), the balance aborts the operation and "Abort" appears in the display. Press the «C» key to clear this message and restart the test.

```

----- BALANCE TEST -----
26.01.94      11:34:23

METTLER TOLEDO
Balance
Type:         SG32000
SNR:         1105238536

Target:      4000
Actual:      4002
Diff:        2

Internal test done

Signature:

.....
----- END -----
  
```

If your balance is connected to a printer, the measured difference is recorded automatically. The record shown opposite is a specimen printed with the METTLER TOLEDO LC-P45 Printer. In this case, the internal test was initiated by the printer. Depending on the attached printer, the printout may differ somewhat from the example shown.

Test of the balance with external weights

Make sure that the "Test of the balance with the external weights" is selected in the menu (see section 4.4).

Ensure that the weighing pan is unloaded and close all doors of the draft shield. There is no need to tare the balance before the test.

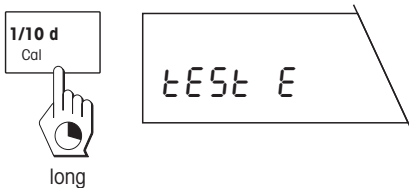

Initiate the test procedure by pressing and holding the «Cal» key. The balance briefly confirms that the test is being performed with an external weight.

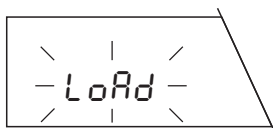

The balance prompts you to load the external weight. Place your weight on the pan.

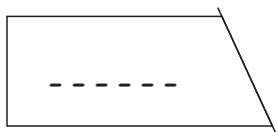

During the test, the horizontal segments are displayed.

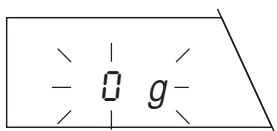

The balance now prompts you to remove your weight. Lift off the weight.

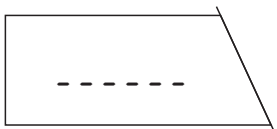

After removal of the weight, the balance processes the results of the test.

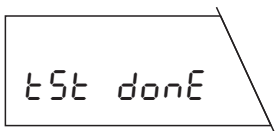

The balance confirms that the test has been performed and then automatically returns to the weighing mode.

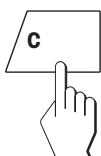

Notes

You can always abort an ongoing test by pressing the «C» key briefly.

If the test can not be performed properly (e.g. as a result of vibrations), the balance aborts the operation and "Abort" appears in the display. Press the «C» key to clear this message and restart the test.

```

----- BALANCE TEST -----
28.01.94      15:21:17

METTLER TOLEDO
Balance
Type:          SG32000
SNR:           1105238536

Weight ID:.....

Target:  .....
Actual:   4000 g
Diff:     .....

External test done

Signature:



.....
----- END -----
    
```

If your balance is connected to a printer, the measured weight of the external test weight is recorded automatically. You can now enter the target weight ("Target") and the difference ("Diff") in the record by hand. The record shown opposite is

6 Error messages

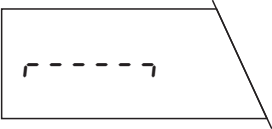
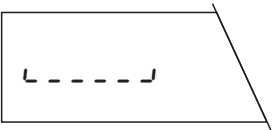
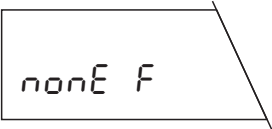
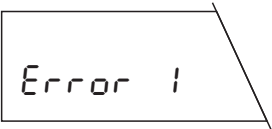
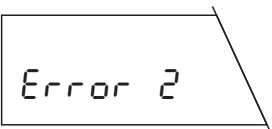
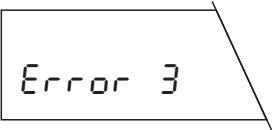
Error messages in the display draw your attention to incorrect operation or that the balance could not execute a procedure properly.

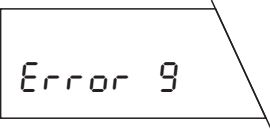
Error message	Cause	Rectification
	Overload	Unload weighing pan.
	Underload	Check that the weighing pan is positioned correctly.
	No function preselected	Preselect desired function in the menu.
	No stability – On taring or adjustment (calibration) – On loading the reference weight for the functions "Piece counting" or "Percent weighing"	Ensure more stable ambient conditions. If not possible, check settings of the repeatability and vibration adapter (see sections 4.9 and 4.7).
	No or wrong adjustment weight	Load requested weight.
	Faulty reference (Reference weight or reference piece number too low)	Increase reference weight or reference piece number.

Error message	Cause	Rectification
 <p>Error 9</p>	Internal fault	Perform in order: Switch balance off then on with the « On/Off » key. Disconnect balance from power supply and reconnect. Adjust (calibrate) balance. If rectification not possible: Inform customer service.
 <p>0.0</p>	Wrong or missing weighing pan	Mount correct weighing pan. Unload weighing pan.
 <p>Abort</p>	Adjustment (calibration) or test could not be performed properly. The balance aborts the procedure. This error message is caused by external disturbing influences (e.g. vibrations or powerful draft).	Press « C » key to clear the error message. Close all draft shield doors. Possibly select a more suitable location for the balance.

6.1 Preventive maintenance and care

SG balances

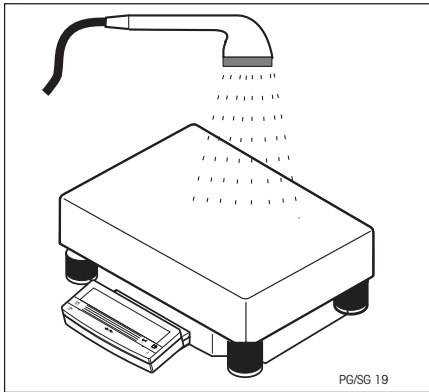

Servicing

Regular servicing of your balance by an authorized service engineer ensures constant accuracy for years to come and prolongs the lifetime of the instrument. Ask your METTLER TOLEDO dealer for details of the available service options.

Cleaning

The balance housing and the weighing pan are made of high-grade, resistant materials. All commercially available cleaning agents may thus be used for cleaning.

- SG balances have an increased degree of housing protection. They can be washed off with running water with the weighing pan mounted as long as the power plug is protected against the wet conditions. With the weighing pan removed, the SG balance can be cleaned with a damp cloth.

Cautionary note

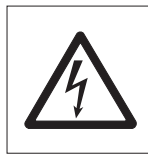

Before washing down, the SG balance must be isolated from the power supply, i.e. disconnect power plug.

Protective covers

Soiled protective covers of all balance models can be changed, see optional equipment in section 7.3.

6.2 Changing the fuses

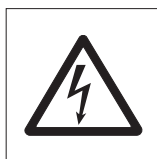

Cautionary note

Before changing the fuse, isolate the balance from the power supply, i.e. disconnect

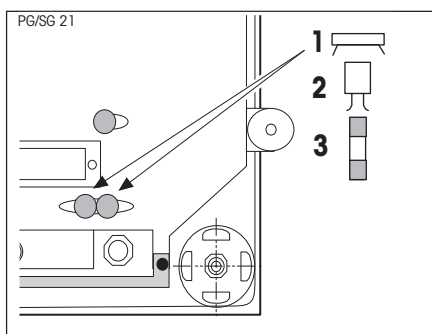

SG balances

- Turn balance with mounted weighing pan over and rest on weighing pan.
- Remove the two plastic covers (1).
- Unscrew the fuse links (2) with a screwdriver in a counterclockwise direction.
- Replace fuses (3) by new fuses of same rating and type: 1 A slow-blow, IEC 127.
- Insert fuse links (2) in the holder and engage by turning in a clockwise direction, press on plastic covers (1).
- Place balance in weighing position and level (section 2.3).

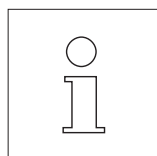

If the fuses used for replacement again blow after a short time, there is a fault in the power supply. In such a case, please isolate the balance from the power supply and have the instrument repaired by an authorized service engineer. On no account attempt to repair the balance yourself.

6.3 Changing the protective cover

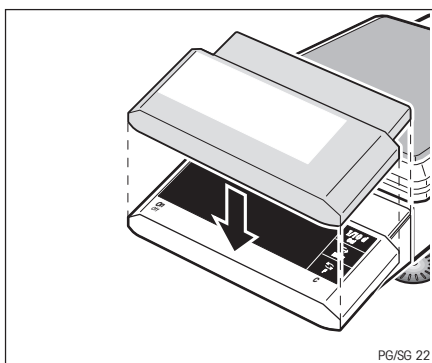

If you operate your balance in an environment liable to cause contamination, we recommend you cover it with the supplied transparent protective cover for the keypad and display.

6.4 LocalCAN universal interface

Each SG balance is equipped with the LocalCAN universal interface. As you can attach up to five peripheral units at the same time, it offers you a high degree of flexibility in data interchange.

Peripherals units (see section 7.3) from METTLER TOLEDO which have the connection cable as part of their standard equipment can be attached in a simple manner to the balance.

You can also attach your computer via an RS232C interface to the SG balance with an appropriate cable (see section 7.3). The communication is particularly well supported by the commands of the standard and extended command set. The reference manual (705184) you receive with the LC-RS or LC-CL cable describes the functioning of these commands in an easily surveyed manner.

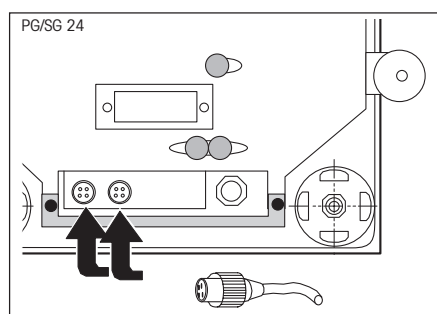

The features of the LocalCAN universal interface can be summarized as follows:

- Attachment of up to five peripheral units to a balance at the same time.
- Support of standard interfaces, such as RS232C or CL.
- Rugged, 4-pin connector with reversed voltage and pullout protection.
- Dependable data transfer thanks to built-in CAN controller.
- Open cabling system, i.e. each peripheral unit except displays have an additional connection.
- Simple configuration of the parameters without recourse to the operating instructions of the SG balance.

The versatile features of the SG balances regarding documentation of the results can not be utilized to the full until a printer, e.g. the LC-P45 from METTLER TOLEDO is attached. The printed results make a decisive contribution to a simple working procedure following GLP/GMP.

Technical data of the LocalCAN universal interface

Cable length between two devices, maximum 10 m.

Total cable lengths of all attached devices, maximum 15 m

Pin assignment (balance end)

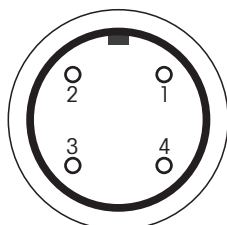

Pin No.	Signal
1	negative signal line (–CAN)
2	positive signal line (+CAN)
3	plus pin of power supply (V CAN) for peripherals
4	minus pin of power supply (0 V) for peripherals

7. Technical data and optional equipment

7.1 General technical data of the SG balances

Power supply connection SG balances

Built-in power supply unit 100–240V, –15%+10%, 50/60Hz, 350mA

Fuse SG balances

Built-in power supply unit T1L250V (2x)

Admissible ambient conditions

height up to 4000m above sea level

temperature range 5°C to 40°C

atmospheric humidity, 80% rh at +30°C

overvoltage category II

pollution degree 2

Use SG balances only in closed rooms

Standard equipment

- LocalCAN universal interface
- Protective cover for the terminal
- Device for theft protection
- Device for stand fastening

Technical data	SG8001	SG16001	SG32001	SG16001 Delta Range
Readability	0.1 g	0.1 g	0.1 g	0.1 g/1 g
Maximum capacity	8100 g	16100 g	32100 g	3200 g/16100 g
Taring range	0 ... 8100 g	0 ... 16100 g	0...32100 g	0...16100 g
Repeatability (s)	0.05 g	0.05 g	0.1 g	0.05 g/0.3 g
Linearity ¹⁾	±0.2 g	±0.2 g	±0.2 g ⁴⁾	±0.2 g/±0.5 g
Stabilization time (typical)	1...2 s	1...3 s	1...3 s	1...3 s
Adjustment • with internal weight • with external weights	internal, motorized, initiated at a keystroke test possibility for checking the sensitivity ≥4000 g			
Preload max. ³⁾	1 kg	2 kg	0.3 kg	2 kg
Sensitivity • Temperature drift ^{1) 2)} • Long-term drift ^{1) 4)}	±6 ppm/°C ±0.005 %	±6 ppm/°C ±0.003 %	±5 ppm/°C ±0.0015 %	±6 ppm/°C ±0.003 %
Dimensions (w/h/d) • Platform • Terminal	360 x 280 x 130 mm, weight: 12.7 kg 205 x 125 x 50 mm (for fastening on the long or short side of the platform)			

Technical data	SG32001 DeltaRange	SG16000	SG32000
Readability	0.1 g/1 g	1 g	1 g
Maximum capacity	6400 g/32100 g	16100 g	32100 g
Taring range	0 ... 32100 g	0 ... 16100 g	0...32100 g
Repeatability (s)	0.1 g/0.3 g	0.3 g	0.3 g
Linearity ¹⁾	±0.2 g/±0.5 g	±0.5 g	±0.5 g
Stabilization time ⁴⁾	1...3 s	1...2 s	1.5...3 s
Adjustment • with internal weight • with external weights	internal, motorized, initiated at a keystroke test possibility for checking the sensitivity ≥8000 g		
Preload max. ³⁾	0.3 kg	2 kg	0.3 kg
Empfindlichkeit • Temperature drift ^{1) 2)} • Long-term drift ¹⁾	±5 ppm/°C ±0.0015 %	±10 ppm/°C ±0.006 %	±5 ppm/°C ±0.003 %
Dimensions (w/h/d) • Platform • Terminal	360 x 280 x 130 mm, weight: 12.7 kg 205 x 125 x 50 mm (for fastening on the long or short side of the platform)		

¹⁾ In the temperature range 15 ... 30 °C

²⁾ 1 ppm = 1/1 000 000 (referred to the current weight display)

³⁾ Admissible load without loss of weighing range when balance switched on

⁴⁾ Values when adjustment performed according to call-up in the display (see section 4.5)

7.2 Dimensions

SG with stand

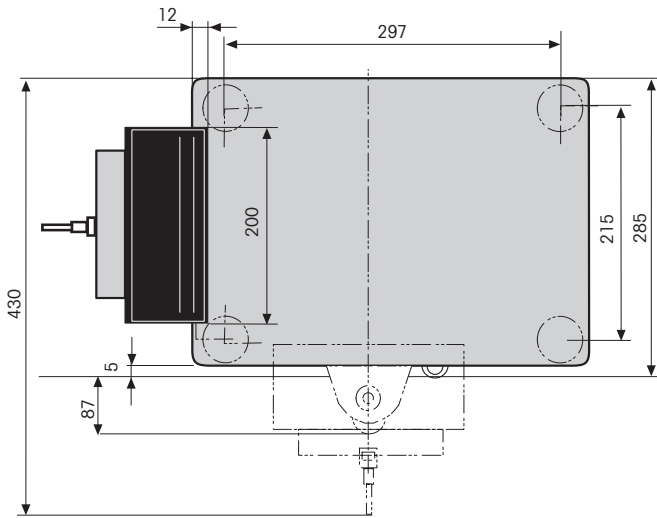
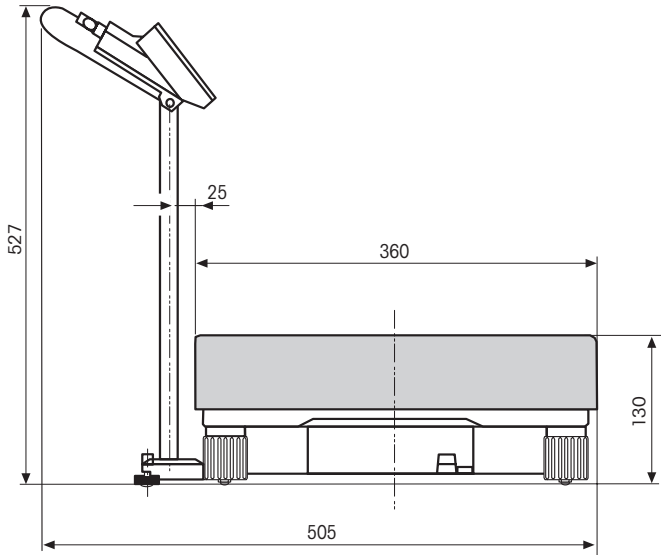

SG without stand

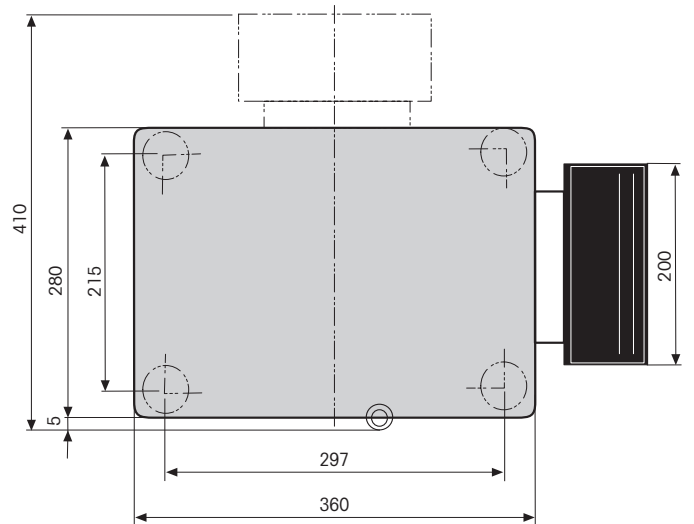
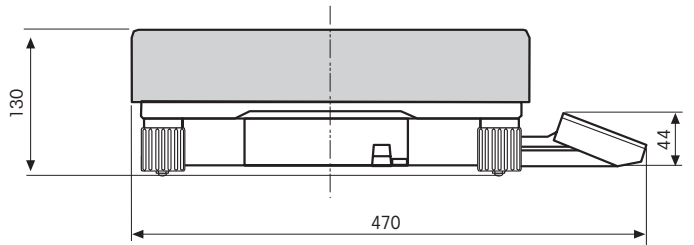

7.3 Optional equipment

With optional equipment from the METTLER TOLEDO product range, you can enhance the functionality of your SG balance. You have the following options available:

<p>Normal paper printers</p> <p>LC-P45 Printer: Printer with built-in applications (calibration and adjustment records conforming to GLP, statistical evaluations, totalization functions, etc.)</p> <p>LC-P43 Printer: Printer for recording the results</p>	<p>LC-P45</p> <p>LC-P43</p>
<p>Auxiliary displays</p> <p>LC-AD: Auxiliary display, active, with bench stand</p> <p>LC-PD: LCD auxiliary display, passive, with bench stand</p>	<p>229140</p> <p>229100</p>
<p>Foot switch</p> <p>LC-FS: Foot switch with adjustable function</p>	<p>229060</p>
<p>Cables and cabling accessories</p> <p>LC-RS25: Cable for the attachment of a printer or computer with RS-232C, 25-pin (m/f), such as IBM XT or compatibles</p> <p>LC-RS9: Cable for the attachment of a computer with RS-232C, 9-pin, such as IBM AT or compatibles</p> <p>LC-CL: Cable for the attachment of a device with METTLER TOLEDO CL interface (5-pin)</p> <p>LC-LC03: Extension cable for LocalCAN, 0.3 m</p> <p>LC-LC2: Extension cable for LocalCAN, 2 m</p> <p>LC-LC5: Extension cable for LocalCAN, 5 m</p> <p>LC-LCT: T-piece for LocalCAN</p>	<p>229050</p> <p>229065</p> <p>229130</p> <p>239270</p> <p>229115</p> <p>229116</p> <p>229118</p>
<p>Antitheft device</p> <p>Steel cable with lock, for SG</p>	<p>590101</p>
<p>Differential weighing</p> <p>Application software for differential weighing</p>	<p>238494</p>

<p>Stand Stand for LC-G terminal, appropriate for S platforms, incl. cable</p>	<p>239268</p>
<p>Wall bracket Wall bracket for LC-G terminal, incl. 2 m cable</p>	<p>239278</p>
<p>Below-the balance weighing device Below-the balance weighing device for SG and S platforms</p>	<p>230034</p>
<p>Protective covers Protective cover for control unit for SG (set of 2)</p>	<p>239305</p>
<p>Transport case For SG balances with control unit and for LC-P4x Printer</p>	<p>239277</p>
<p>Weights Available as OIML weights (E2 and F1, with certificate) or as adjustment (calibration) weights (not OIML): 20 g, 50 g, 100 g and 200 g</p>	<p>on request</p>

Operating or installation instructions are enclosed with many of the options. For further information and for details on how to order the optional equipment, please contact your METTLER TOLEDO dealer.

8.2 Conversion table for weight units

Unit	Gram g	Milligram mg	Ounce oz (avdp)	Troy ounce ozt	Pound lb	Pennyweight dwt
1 g	1	1000	0.03527396	0.03215075	15.43236	0.6430149
1 mg	0.001	1	0.0000352740	0.0000321508	0.01543236	0.000643015
1 oz	28.34952	28349.52	1	0.9114585	437.500	18.22917
1 ozt	31.10347	31103.47	1.097143	1	480	20
1 lb	453.59237	453592.37	16.00000	14.583336	1	291.66663
1 dwt	1.555174	1555.174	0.05485714	0.05	24	1
1 ct/C.M.	0.2	200	0.007054792	0.006430150	3.086472	0.1286030
1 mo	3.75	3750	0.1322774	0.1205653	57.87134	2.411306
1 m	4.608316	4608.316	0.1625536	0.1481608	71.11718	2.963216
1 tl (HK)	37.429	37429	1.320269	1.203370	577.6178	24.06741
1 tl (SGP/Mal)	37.79937	37799.37	1.333333	1.215278	583.3334	24.30556
1 tl (Taiwan)	37.5	37500	1.322773	1.205653	578.7134	24.11306

Unit	Carat ct/C.M. (metr.) koil	Momme mo	Mesghal m	Tael tl (Hong Kong)	Tael tl (Singapore) (Malaysia)	Tael tl (Taiwan)
1 g	5	0.2666667	0.216999	0.02671725	0.02645547	0.02666667
1 mg	0.005	0.000266667	0.000216999	0.0000267173	0.0000264555	0.0000266667
1 oz	141.7476	7.559873	6.151819	0.7574213	0.75	0.7559874
1 ozt	155.5174	8.294260	6.749423	0.8309993	0.8228570	0.8294261
1 lb	2267.9618	120.95796	98.42909	12.118741	11.9999	12.095796
1 dwt	7.775869	0.4147130	0.3374712	0.04154997	0.04114285	0.04147131
1 ct/C.M.	1	0.05333333	0.04339980	0.005343450	0.005291094	0.005333333
1 mo	18.75	1	0.8137461	0.1001897	0.09920800	0.1
1 m	23.04158	1.228884	1	0.1231215	0.1219152	0.1228884
1 tl (HK)	187.1450	9.981068	8.122056	1	0.9902018	0.9981068
1 tl (SGP/Mal)	188.9968	10.07983	8.202425	1.009895	1	1.007983
1 tl (Taiwan)	187.5	10	8.137461	1.001897	0.9920800	1

8.3 SOP (Standard Operating Procedure)

In the documentation of a GLP test, the SOPs represent a relatively small but none the less very important part.

Practical experience has confirmed that SOPs produced in-house can be followed much better than those produced by an external, anonymous source.

In what follows, you will find a brief overview of the responsibilities in regard to SOPs, as well as a check list for the production of an SOP.

Responsibilities in regard to SOPs

Head of the inspection and test equipment	arranges the production of SOPs approves SOPs with date and signature
Test director	ensures that SOPs are available approves SOPs on behalf of the management
Personnel	follow the SOPs and other directives
GLP quality assurance	checks that valid SOPs are available checks that SOPs are followed checks whether and how modifications are documented

Check list for the production of SOPs

Administrative matters	Yes	No
1. Use of SOP blank forms		
2. Name of the inspection and test equipment		
3. Date (production date of the SOP)		
4. Filing identifier (code plan) for SOPs		
5. Number of pages (1 of n)		
6. Title		
7. Date of putting into force		
8. Modification information		
9. Names of people (departments) responsible for implementation		
10. Date and signatures: a) author(s) b) checker c) person authorized for approval		
11. Distribution list		

Contents of the SOP	Yes	No
1. Introduction and aim		
2. Required material		
3. Description of the work steps		
4. Description of the documentation		
5. Data processing and evaluation		
6. Documentation, samples, etc. to be stored		
7. Archiving direction		

8.4 Index

A

AC adapter 8, 9, 11
Adjusting 12
Adjustment 22
Ambient conditions 12, 19, 25, 51, 56
Antitheft device 56, 59
Asterisk symbol 42
Automatic adjustment call-up 23
Automatic shutdown 31
Automatic zero correction 30

B

Below-the-balance weighings 43

C

Care 53
Changing fuses 54
Changing the protective cover 54
Conversion table for weight units 62

D

Decimal places 16
DeltaRange balances 18
Dimensions 58
Display test 14, 19, 32
Dynamic weighing 41

E

Error messages 51

F

Factory setting 32
Fine range 18
Formula weighing 37

G

GLP 6, 12, 22, 55, 59, 63
Good Laboratory Practice 6, 12

I

Interface 6, 55, 59

L

Leveling the balance 11
LocalCAN universal interface 55
Location change 10
Location selection 10

M

Menu 19, 61
Moisture 56

O

On/off switching 14
Optional equipment 56, 59
Overload 51

P

Percent weighing 36
Piece counting 34
Power supply 11, 35, 36, 43, 54
Power-up mode 32
Preventive maintenance 53
Printer 18, 33
Printing settings 33

Q

Quickstart 32

R

Readability 17, 18, 56, 57
Reference piece number 34, 51
Reference weight 34, 35, 36, 51
Repeatability 27
Resolution of the weighing result 16

S

Safety 8
Short-form operating instructions 6, 8, 9
Stability 42
Stability detector 16, 27

Standard equipment 9
Standard Operating Procedure 6, 12, 63
Standby 14, 31, 32
Storing the settings 21

T

Taring 15
Technical data 56
Test of the balance 22, 48, 49

U

Underload 51
Unstable weighing samples 24

V

VariCal 22, 46
Vibration adapter 25

W

Weighing process adapter 26
Weighing unit 28, 29
Weighing units 17

Printed on 100 % chlorine-free Paper, for the sake of our environment.

**To protect your METTLER TOLEDO product's future:
METTLER TOLEDO Service assures the quality, measuring accuracy and
preservation of value of all METTLER TOLEDO products for years to
come.**

**Please send for full details about our attractive terms of service.
Thank you.**



P11780369

Subject to technical changes and to the availability
of the accessories supplied with the instruments.

© Mettler-Toledo GmbH 1999 11780369 Printed in Switzerland 9906/2.12

Mettler-Toledo GmbH, Laboratory & Weighing Technologies, CH-8606 Greifensee, Switzerland
Phone +41-1-944 22 11, Fax +41-1-944 30 60, Internet: <http://www.mt.com>