

METTLER TOLEDO

Operating Instructions
METTLER TOLEDO
Viper SW weighing scale

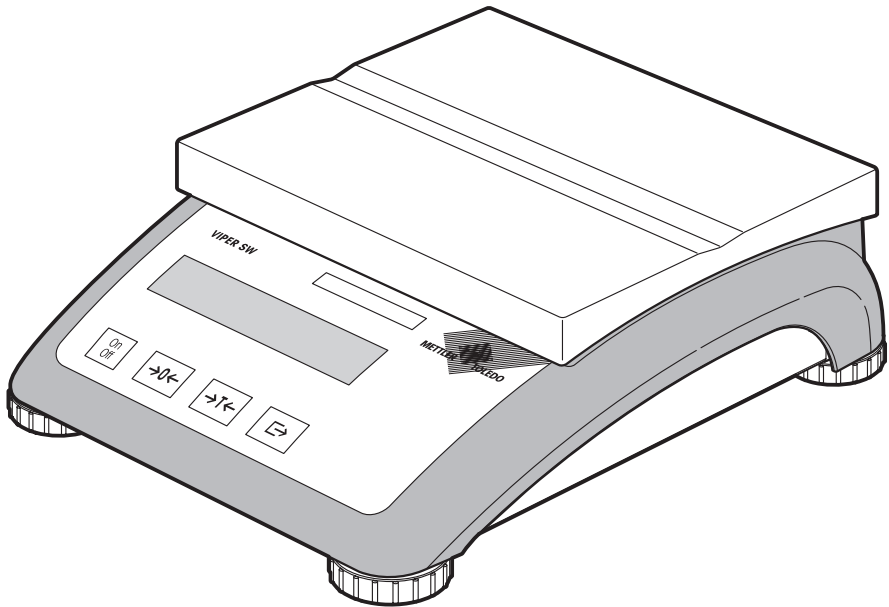

Overview

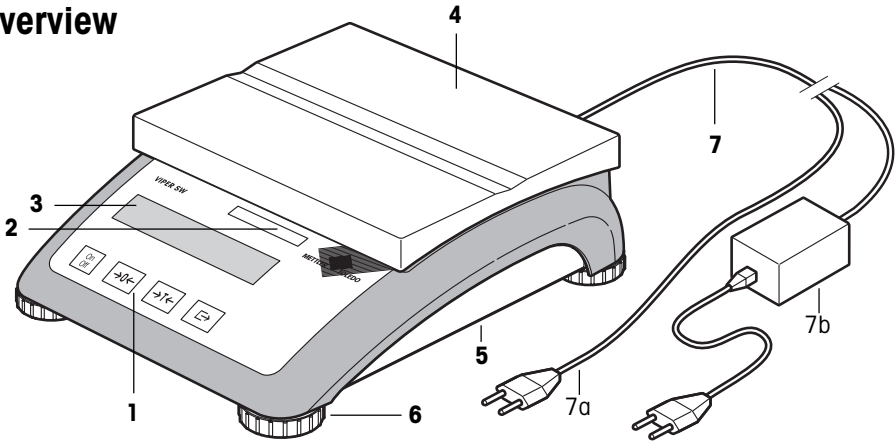

Rear of scale

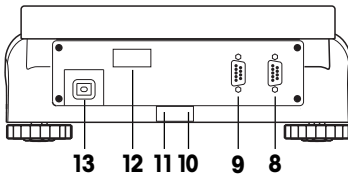

Scale specifications (example)

	14	15	16	17
Max1:	3kg	Min1: 20g	e1: 1g	d1: 1g
Max2:	6kg	Min2: 40g	e2: 2g	d2: 2g

Display



- | | |
|-------------------------------------------------------------------------------------------------------------------------------------------------------------------------------------------------------------------------------------------------------------------------------------------------------------------------------------------------------------------------------------------------------------------------------------------------------------------------------------------------------------------------------------------------------------------------------------------------------------------------------------------|-----------------------------------------------------------------------------------------------------------------------------------------------------------------------------------------------------------------------------------------------------------------------------------------------------------------------------------------------------------------------------------------------------------------------------------------------------------------------------------------------------------------------------------------------------------------------------------------------------------------------------------------------------------------------------|
| <ul style="list-style-type: none"> 1 keypad 2 scale specifications 3 display 4 weighing pan 5 adhesive label for MonoBloc version 6 adjustable feet 7 power supply: <ul style="list-style-type: none"> 7a: power cord(scale w/o battery) 7b: AC adapter (scale with battery) 8 RS232C interface 9 second interface RS232C (optional) 10 spirit level (only on certified scales and those with MonoBloc weighing cells) 11 hole for antitheft device 12 model plate | <ul style="list-style-type: none"> 13 power cord or jack for AC adapter 14 maximum loads (ranges 1/2) 15 minimum loads (ranges 1/2) 16 verification scale interval (certified scale) (ranges 1/2) 17 max. resolutions (ranges 1/2) 18 dynamic weighing symbol 19 net symbol when weighing with tare 20 weighing unit 21 stability detector 22 changed resolution (only certified scales) 23 certification brackets (certified scales e=10d) 24 active interface (for master mode) 25 weighing range display 26 battery discharge status |
|-------------------------------------------------------------------------------------------------------------------------------------------------------------------------------------------------------------------------------------------------------------------------------------------------------------------------------------------------------------------------------------------------------------------------------------------------------------------------------------------------------------------------------------------------------------------------------------------------------------------------------------------|-----------------------------------------------------------------------------------------------------------------------------------------------------------------------------------------------------------------------------------------------------------------------------------------------------------------------------------------------------------------------------------------------------------------------------------------------------------------------------------------------------------------------------------------------------------------------------------------------------------------------------------------------------------------------------|

Contents

1	Putting into service	4
1.1	Unpacking and checking contents	4
1.2	Safety and environmental protection	4
1.3	Positioning and leveling the scale	5
1.4	Connecting to power supply	6
1.5	Battery operation	6
2	Weighing	7
2.1	Switching on and off and zeroing	7
2.2	Simple weighing	7
2.3	Weighing with tare	7
2.4	Recording weighing results	8
2.5	Special functions (master mode)	8
3	Master mode	9
3.1	Overview and operation	9
3.2	Scale calibration (adjustment)	9
3.3	Scale settings	10
3.4	Interface configuration	11
3.5	Printing master mode settings	13
3.6	Saving settings and exiting master mode	13
3.7	Making a typical setting in master mode	13
4	Other important information	14
4.1	Error messages	14
4.2	Cleaning instructions	15
4.3	Declaration of conformity	16
4.4	Technical data	18
4.5	Accessories	20
4.6	Interface commands	20

Putting into service

Please read through these operating instructions carefully and adhere to them at all times. If you discover that materials are missing or that the wrong ones have been supplied, or if you have any other problems with your scale, please refer to the dealer or salesperson concerned, or if necessary to the METTLER TOLEDO representative responsible.

1.1 Unpacking and checking contents

- Remove the scale and accessories from the packaging.
- Check for completeness. The basic scope of supply comprises:
 - scale
 - weighing pan
 - AC adapter (only for models with integrated battery)
 - operating instructions (this booklet)
 - any special accessories as per packing list

1.2 Safety and environmental protection

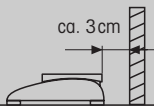

- Do not use the scale in **hazardous areas** (unless it is clearly identified as being approved for these areas).
- For service in **wet areas or dusty environments**, or if **wet cleaning** is necessary, scales with **IP 65 ingress protection** must be used. But even these scales must not be used in environments where there is a risk of corrosion. The scales must never be drenched or immersed in a liquid.
- If the **power cord** is damaged, the scale must no longer be operated. Therefore check the cable regularly and ensure that a free space of about 3 cm is left at the rear of the scale, so that the cable is not kinked too severely.
- Never tamper with the **retaining screws for the load plate support** underneath the weighing pan.
- When the weighing pan is removed, **never insert a solid object underneath the load plate support**.
- It is not permitted to open the scale by removing the **screws in its base**.
- Only use **approved accessories and peripherals**.



- Handle the scale **carefully**; it is a precision instrument. Blows on the weighing pan must be avoided, and heavy overloads must not be placed on it.
- Important instructions when using Viper scales in the **food sector**: those parts of the scale can come into contact with food products have smooth surfaces and are easy to clean. The materials used do not splinter and are free from contaminants. In food processing areas it is recommended that a **protective cover** (Section 4.5) is used. This must be cleaned regularly, just like the scale itself. Damaged or heavily contaminated protective covers must be replaced immediately.
- When the scale is finally **taken out of service**, observe the current environmental regulations. If the scale is equipped with a **battery**, this contains heavy metals and therefore must not be treated as normal refuse! Local regulations for disposing of environmentally hazardous substances must be complied with.

1.3 Positioning and leveling the scale

The correct location is a decisive factor in ensuring accurate weighing results.



- Choose a stable and vibration-free location (particularly important for high-resolution scales using Mettler Toledo MonoBloc technology). Place the scale on a surface that is as horizontal as possible and strong enough to bear its weight when fully loaded.
- Check the ambient conditions (Section 4.4).
- Avoid:
 - direct sunlight
 - strong drafts (e.g. from fans or air conditioning systems)
 - excessive temperature fluctuations.
- Turn the adjustable feet so that the scale is horizontal. If a spirit level is fitted, the bubble must be located within the inner circle.

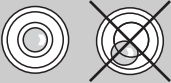

Major changes in geographical location:

Every scale is set by the manufacturer to suit the local gravitational conditions (geographical adjustment value) in the geographical zone to which the instrument is supplied. If a major change of geographical location takes place, this setting must be adjusted by a service technician or a new setting made. Certified scales must in addition be recalibrated in accordance with national certification regulations.

1.4 Connecting to power supply

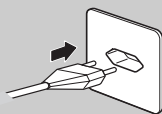

0.000 kg

- Before connecting the power supply plug or AC adapter (AccuPac version), verify that the voltage stated on the model plate is the same as the local power line voltage.
- Connect the power cord plug or the AC adapter plug to the supply, then connect the AC adapter (AccuPac version) via the jack at the rear of the scale.

Powering up the scale initiates a display test in which all the segments and then the software version are briefly displayed. Once the decimal zero appears in the display, the scale is ready to operate.

For maximum possible precision, adjust/calibrate the scale after installing it (Section 3.2). **Note:** Certified scales must be adjusted by an authorized organization. Please consult your dealer.

1.5 Battery operation



Scales with a built-in battery (AccuPac) can under normal operating conditions work independently of the AC power line for about 20 hours (MonoBloc version) or about 30 hours (strain gauge version). Immediately the AC power supply is interrupted (by withdrawing the power cord plug or if there is a power failure), the scale switches automatically to battery operation. Once the AC power supply is restored, the scale reverts automatically to AC operation.

The battery symbol indicates the current discharge status of the battery (1 segment corresponding to about 25% capacity). If the symbol flashes, the battery must be recharged.

A discharged battery requires at least 8 hours until it is recharged. During the charging process work with the scale can continue, but under these conditions a longer charging time is needed.

The battery is protected against overcharging, and the scale can therefore remain permanently connected with the AC power line without any problems.

2

Weighing

This section describes how to switch the scale on and off, zero and tare it, weigh materials and record the results.

2.1 Switching on and off and zeroing

On
Off

0.000 kg

→0←

- Briefly pressing the «**On/Off**» key switches the scale on or off.

The scale carries out a display test (Section 1.4). Once the weight display appears, the scale is ready to operate and automatically zeroed.

Note: When necessary, the scale can be zeroed at any time with the «**→0←**» key.

2.2 Simple weighing

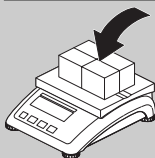

◦ 2.416 kg

2.420 kg

- Place the object to be weighed on the scale.

- Wait until the stability detector (a small ring in the bottom left corner of the display) disappears, then ...

- ... read the indicated weight.

2.3 Weighing with tare

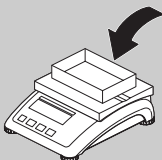

→T←

0.000 kg^{NET}

- Place the **empty** weighing container or packaging on the scale.

- Press the «**→T←**» key briefly to tare the scale. The zero display and the "NET" (net weight) symbol appear. **Note:** If the automatic tare function has been activated in master mode (Section 3.3), there is no need to press the «**→T←**» key.

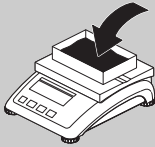

4.216 kg^{NET}

- Place the material to be weighed in the container, then ...
- ... read the indicated net weight.

2.4 Recording weighing results



- Press the «» key to send the current weighing result to the peripheral device (printer, computer) via the interface. Factory default configures interface 1 for connection to a printer. Please refer to Section 3.4 for instructions on configuring the interface(s).

2.5 Special functions (master mode)

MASTER

In addition to simple weighing functions, the scale also has additional options and settings that can be activated in master mode (Section 3).

3

Master mode

In master mode the scale settings can be changed and the various functions activated – to adapt the scale for individual weighing needs.

3.1 Overview and operation

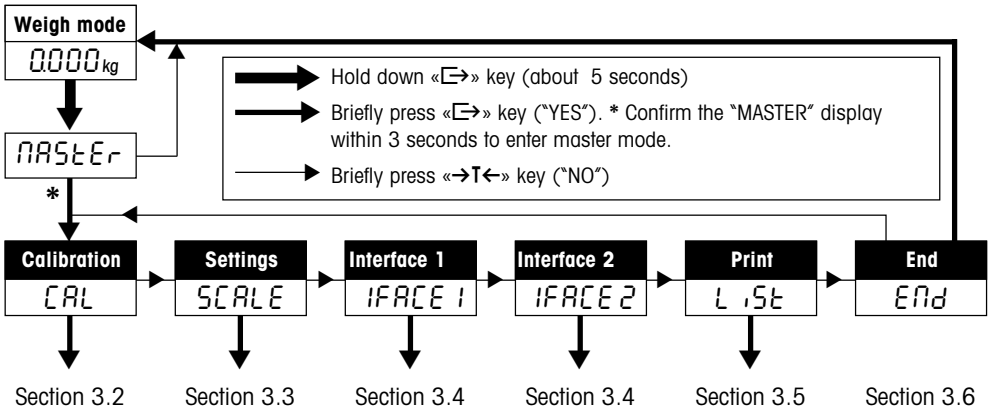

3.2 Scale calibration (adjustment)

CAL



15000

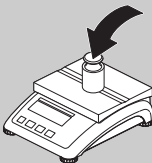

15.000 kg

This master mode block is not available with certified scales.

- Remove the load from the weighing pan and then press the «E» key to start the calibration procedure.
- The flashing display shows the calibration weight. If desired, the «T» key can be used to select other calibration weights.

- Place the indicated calibration weight on the scale and confirm with «E».

Note: The calibration procedure can be canceled at any time with the «On/Off» key.

- Wait until the calibration has been successfully completed (confirmed by the message "done" in the display) and the scale reverts to weighing mode.

3.3 Scale settings

SCALE

The second master mode block contains a total of **11 subblocks** for setting the scale and activating its functions.

Function/Display	Settings	Remarks
Resolution RESOLU	Depends on model, example: 0.01kg/0.02kg/.../0.005kg Certified scales: changed settings indicated with "*" and with no weighing unit. After re-start the standard setting (see certification label) is active.	The symbol "1<—>1 1/2" appears when set for 2 weighing ranges: Example: 15 kg scale: 1. Range 0 – 6 kg Resolution 2 g 2. Range 0 – 15 kg Resolution 5 g In order to switch from the 2nd range back to the 1st range, the load must first be removed from the scale or it must be zeroed.
Weighing unit Unit	"g" ¹⁾ , "kg" ¹⁾ , "oz" ¹⁾ , "lb" ¹⁾	Factory setting as per model plate. "oz" and "lb" not available for certified scales.
Automatic zero correction A-ZERO	On ¹⁾ Off	Corrects the scale zero automatically. Not available for certified scales.
Automatic tare function A-TARE	On Off ¹⁾	Tares the scale automatically as soon as the empty weighing container is placed on the pan ("T" flashes in the display).
Automatic shutoff PII-OFF	On ("Yes") Off ("No") ¹⁾	If function is activated ("Yes" = factory setting for scales with battery), the scale switches off automatically after some 3 minutes of inactivity.
Backlighting b.LIGHT	On ¹⁾ Off	"On" in battery operation = backlit for about 5 seconds.
Auto memory function RES-TARE	On Off ¹⁾	Last tare and zero are saved when scale switched off. Not available for certified scales.
	¹⁾ factory setting	(continued on next page)







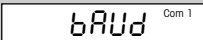
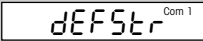
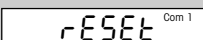

Function/Display	Settings	Remarks
Vibration adapter UibrAt	`Med` ¹⁾ `Low` `High`	normal environment very tranquil environment (immediate stop for display) high vibration levels
Weighing process adapter ProcES	`Univer` ¹⁾ `Dosing` `Dynamic`	normal weighing samples dispensing (e.g. of liquid or powders) restless load, e.g. animals
Reset rESEt	Resets all "SCALE" settings to the factory settings.	Confirm reset by pressing « \rightarrow » or cancel with « \rightarrow T \leftarrow ». Note: To reset the adjustments, the prompt "Std On" must be confirmed with « \rightarrow ».
End settings. End SC	Exit the "SCALE" block.	Press « \rightarrow » to exit the "SCALE" block, or « \rightarrow T \leftarrow » to make further settings.
1) factory setting		

3.4 Interface configuration

IFACE 1
IFACE 2

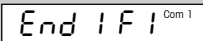
The scale interfaces can be configured in this block. **Note:** Settings in "IFACE 2" can only be made if the second interface is fitted.

Function/Display	Settings	Remarks
Mode Mode ^{Com 1}	`Print` (printer) ^{1) 5)} `Cycle` (series weighing) ^{2) 5)} `Dialog` (computer) ^{3) 4) 5)} `2nd Display` ⁵⁾	2400 bd, 7b even, Xon/Xoff 2400 bd, 7b even, Xon/Xoff 9600 bd, 8b no parity, Xon/Xoff 9600 bd, 8b no parity, Xon/Xoff
Transmission protocol Protol ^{Com 1}	`HONOFF` ¹⁾ `No`	Xon/Xoff protocol no protocol
Bits and parity PAR ity ^{Com 1}	`7 Even` ¹⁾ `7 No P` `8 No P` `7 Odd`	7 data bits with even parity 7 data bits with no parity 8 data bits with no parity 7 data bits with odd parity
(continued on next page)		

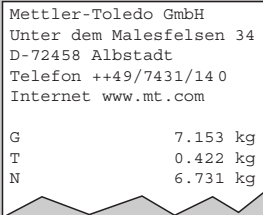
Function/Display	Settings	Remarks						
Data transfer rate 	300, 600, 1200, 2400 ¹⁾ , 4800, 9600, 19200 baud	Note: For older Sprinter 1 printers select 300 baud						
Data and formatting to be transferred 	"Header" (On ¹⁾ /Off) ⁶⁾ "Gross" (On ¹⁾ /Off) "Net" (On ¹⁾ /Off) "Tare" (On ¹⁾ /Off) "4 LinF" (On ¹⁾ /Off) "F Feed" (On/Off ¹⁾) "Ln for" (Single ¹⁾ /Multi)	Report heading gross weight net weight tare 4 empty lines form feed "Single" = 1 result per line, "Multi" = all results on 1 line						
Reset 	Resets all settings of selected interface to factory settings.	Reset with «  » key (confirming "Std On" query by pressing «  » again) or cancel with «  T  ». </td						
End settings 	Exit the interface block.	Press «  » to exit interface block or «  T  » to make further set- tings.						
<div style="display: flex; justify-content: space-between;"> <div style="width: 30%;"> <p>1) Factory setting for connection to "Sprinter 1" printer.</p> <p>2) Data printout when weight changes.</p> <p>3) The "Dialog" mode is used for bidirectional communication of the scale with an external device (e.g. a computer). Further information is given in Section 4.6.</p> <p>4) For using the Viper scale as the reference scale in 2-scale systems.</p> <p>5) If this operating mode is selected, the associated default settings (see "Remarks" column) are automatically adopted.</p> <p>6) This setting specifies whether a record header is to appear on the printouts. This consists of up to 5 lines, each with a maximum of 24 characters (e.g. company name and address). The record header is created and formatted by means of SICS commands via the interface (see Section 4.6). A typical record with a header is shown opposite.</p> </div> <div style="width: 65%; border: 1px solid black; padding: 10px;">  <p>Mettler-Toledo GmbH Unter dem Malesfelsen 34 D-72458 Albstadt Telefon ++49/7431/14 0 Internet www.mt.com</p> <table border="0"> <tr> <td>G</td> <td>7.153 kg</td> </tr> <tr> <td>T</td> <td>0.422 kg</td> </tr> <tr> <td>N</td> <td>6.731 kg</td> </tr> </table> </div> </div>			G	7.153 kg	T	0.422 kg	N	6.731 kg
G	7.153 kg							
T	0.422 kg							
N	6.731 kg							

3.5 Printing master mode settings

L 1St



In this block all master mode settings can be recorded with a printer.



- Press «» key to print out the settings.
(Recommended printer: "Sprinter 1", see Section 4.5 "Accessories")

3.6 Saving settings and exiting master mode

End



In the last master mode block you can save your settings and revert to weighing mode.

- Press the «» key to exit master mode.
- Press the «» key to save the settings or the «» key to cancel them. The scale then reverts to weighing mode.

3.7 Making a typical setting in master mode

You want to set the readability (resolution) at 0.01kg.

MASTER



CAL



SCALE



RESOLU



00 1kg













End



Store ?



000kg

- Hold down the «» key for about 5 seconds to access master mode, and confirm that you really want this by briefly pressing «» ("Yes") within 3 seconds.
- Skip the first master mode block "CAL" (Calibration, not available with certified scales) by pressing «» ("No").
- Activate the block for scale settings ("Scale") and then the subblock for resolution ("Resolution") by pressing «» ("Yes") twice.
- Press «» ("No") repeatedly until the desired resolution (0.1 kg) is displayed, then confirm by pressing «» ("Yes").
- Answer the prompt "End" with «» ("Yes") as you do not want to make more settings. If you press «» ("No"), however, you can make further settings.
- Answer the prompt "Store?" (Save in memory) with «» ("Yes"). The scale reverts to weighing mode and operates with the new settings. If you reply with «» ("No"), the changes will not be saved.

4

Other important information

This section gives information on error messages and instructions for cleaning your scale. It also includes the declaration of conformity and technical data.

4.1 Error messages

Overload

Reduce the load on the scale or the preload.

Underload

Place weighing pan on the scale and ensure that it can move freely.

Weight reading does not stabilize.

1. Ensure a tranquil environment.
2. Ensure that the weighing pan is free to move.
3. Change the setting of the vibration adapter (Section 3.3).
4. If necessary use the dynamic weighing function (Section 3.3).

Not possible to zero scale

Ensure that zeroing is only carried out in the permissible range and not under overload or underload conditions.

No calibration/adjustment

Disconnect the power cord plug and then plug it in again. (If operating on the battery, switch the scale off and then on again.) If the error message reappears, calibrate/adjust the scale (Section 3.2). If this does not help, contact your dealer or local representative.

EAROM checksum error

Disconnect the power cord plug and then plug it in again. (If operating on the battery, switch the scale off and then on again.) If the error message reappears, contact your dealer or local representative.

4.2 Cleaning instructions



- Disconnect the scale from the power supply before cleaning it!
- Use a damp cloth (do not use acids, alkalis or strong solvents).
- Wet cleaning is only allowable on scales with IP65 ingress protection.
- If heavily contaminated, the weighing pan, protective cover (if fitted) and adjustable feet must be removed and cleaned separately.
- With the weighing pan removed, never use a solid object to clean underneath the load plate support!
- Observe your organization's internal rules and industry-specific regulations for cleaning intervals and permissible cleaning agents.

4.3 Declaration of conformity

We, **Mettler-Toledo (Albstadt) GmbH, Unter dem Malesfelsen 34, D-72458 Albstadt** declare under our sole responsibility that the product

Viper SW from serial no. 2487843, to which this declaration relates is in conformity with the following directives and standards.

Directive	Applicable standard
relating to electrical equipment designed for use within certain voltage limits (73/23/EEC; amended by directive 93/68/EEC)	EN61010-1 (Safety Regulations)
relating to electromagnetic compatibility (89/336/EEC; amended by directive 93/68/EEC; 92/31/EEC)	EN55022 Emission Class B EN50082-2 Immunity EN61000-3-2 (Harmonic Oscillations) EN61000-3-3 (Voltage Fluctuations)
relating to non-automatic weighing instruments (90/384/EEC; amended by directive 93/68/EEC) ¹⁾	EN45501 ¹⁾ (Metrological Aspects) 

¹⁾ Applies only to certified scales (approval/test certificate no: T5508 for scales with strain gauge cells, T5627 for scales with "MonoBloc" cells).

Albstadt, May 2002



Roland Schmider, General Manager

Mettler-Toledo GmbH



Heiko Carls, Quality Manager

Important notice for verified weighing instruments in EC countries



Weighing instruments verified at the place of manufacture bear the preceding mark on the packing label and a green "M" sticker on the descriptive plate. They may be set to work immediately.



Weighing instruments which are verified in two steps have no green "M" on the descriptive plate and bear the preceding identification mark on the packing label. The second step of the verification must be carried out by the approved Mettler-Toledo service or by the W & M authorities. Please contact your Mettler-Toledo organization.

The first step of the verification has been carried out at the manufacturing plant. It comprises all tests according to EN45501-8.2.2.

If national regulations in individual countries limit the period of validity of the certification, the operator of such a scale is himself responsible for its timely re-certification.

USA/Canada

This equipment has been tested and found to comply with the limits for a Class A digital device, pursuant to both Part 15 of the FCC Rules and the radio interference regulations of the Canadian Department of Communications. These limits are designed to provide reasonable protection against harmful interference when the equipment is operated in a commercial environment. This equipment generates, uses and can radiate radio frequency energy and, if not installed and used in accordance with the instruction manual, may cause harmful interference to radio communications. Operation of this equipment in a residential area is likely to cause harmful interference, in which case the user will be required to correct the interference at his own expense.

Cet appareil a été testé et s'est avéré conforme aux limites prévues pour les appareils numériques de classe A et à la partie 15 des règlements FCC et à la réglementation des radio-Interférences du Canadian Department of communications. Ces limites sont destinées à fournir une protection adéquate contre les interférences néfastes lorsque l'appareil est utilisé dans un environnement commercial. Cet appareil génère, utilise et peut radier une énergie à fréquence radioélectrique; il est en outre susceptible d'engendrer des interférences avec les communications radio, s'il n'est pas installé et utilisé conformément aux instructions du mode d'emploi. L'utilisation de cet appareil dans les zones résidentielles peut causer des interférences néfastes, auquel cas l'exploitant sera amené à prendre les dispositions utiles pour palier aux interférences à ses propres frais.

4.4 Technical data

Functions	4 weighing units, vibration adapter, weighing process adapter, automatic tare function, automatic zero correction, power-saving shutoff, display backlighting, automatic saving of tare and zero															
Display	LCD (liquid crystal display), 16mm high, backlit															
Ambient conditions	The accuracy is guaranteed in the following ranges: Temperature range: –10 to +40 °C (strain gauge cells) +10 to +30 °C (MonoBloc cells) Relative humidity: 15 to 85% RH (no condensation) Overvoltage category: II Pollution degree: 2 Maximum altitude 4000m above sea level															
Power supply	Direct connection to AC power line or via AC adapter: 240 V, 50 Hz, 70 mA 120 V, 60 Hz, 90 mA 230 V, 50 Hz, 70 mA 100 V, 50/60 Hz, 90 mA With extra AC adapter for battery operation: feed for the scale 18 VDC, 0.6 A															
Total weight	<table style="width: 100%; border-collapse: collapse;"> <thead> <tr> <th></th> <th style="text-align: center;">Strain gauge</th> <th style="text-align: center;">MonoBloc</th> </tr> </thead> <tbody> <tr> <td>Small platform: line-voltage scale:</td> <td style="text-align: center;">4.6 kg</td> <td style="text-align: center;">4.7 kg</td> </tr> <tr> <td style="padding-left: 20px;">AccuPac scale:</td> <td style="text-align: center;">5.2 kg</td> <td style="text-align: center;">5.3 kg</td> </tr> <tr> <td>Large platform: line-voltage scale:</td> <td style="text-align: center;">8.2 kg</td> <td style="text-align: center;">10.5 kg</td> </tr> <tr> <td style="padding-left: 20px;">AccuPac scale:</td> <td style="text-align: center;">8.8 kg</td> <td style="text-align: center;">11.1 kg</td> </tr> </tbody> </table>		Strain gauge	MonoBloc	Small platform: line-voltage scale:	4.6 kg	4.7 kg	AccuPac scale:	5.2 kg	5.3 kg	Large platform: line-voltage scale:	8.2 kg	10.5 kg	AccuPac scale:	8.8 kg	11.1 kg
	Strain gauge	MonoBloc														
Small platform: line-voltage scale:	4.6 kg	4.7 kg														
AccuPac scale:	5.2 kg	5.3 kg														
Large platform: line-voltage scale:	8.2 kg	10.5 kg														
AccuPac scale:	8.8 kg	11.1 kg														
Ingress protection	IP43 (optional IP65 (EN 60529) for scales with strain gauge cells. These scales are identified with an IP65 adhesive label.)															
Standard scope of supply	Scale complete, operating instructions, AC adapter (AccuPac scale only)															

Dimensions

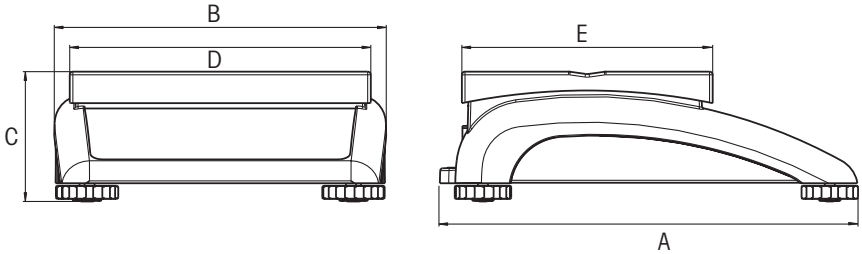

	A	B	C*	D	E
Small platform	335	265	100	240	200
Large platform	370	360	115	350	240

All dimensions in millimeters

* with adjustable feet fully screwed in

Interface technical data

The scale is provided with an EIA RS-232C (CCITT V24/V.28) voltage-controlled interface as standard. Maximum cable length is 15 m. All interfaces are in the form of a 9-pin D-sub female connector. Instructions for configuring the interfaces are given in Section 3.4.

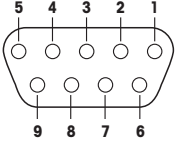
Interface		1 (standard)	2 (optional)
Type		RS232C	RS232C
Pin assignment 	Pin 1	VCC 1	VCC 2
	Pin 2	TxD 1	TxD 2
	Pin 3	RxD 1	RxD 2
	Pin 4	(1)	(1)
	Pin 5	GND	GND
	Pin 6	(1)	(1)
	Pin 7	(1)	(1)
	Pin 8	(1)	(1)
	Pin 9	(1)	(1)

TxD: transmit data

RxD: receive data

GND: signal ground

VCC: power supply

(1): pin must not be connected!

4.5 Accessories

	Article No.
Auxiliary display RS-PD/PASM	21302875
RS232 cable for auxiliary display 1.8 m (9-pin D-Sub, m/m, parallel)	21302921
Protective cover for small platform scale	21203207
Protective cover for large platform scale	21203206
Antitheft device	00229175
"Sprinter 1" printer, EURO version	21253399
"Sprinter 1" printer, UK version	21253745
RS232 cable for printer 1.8 m (25/9-pin D-Sub, m/m, crossover)	21253677
RS232 cable for 2nd scale 1.8 m (9-pin D-Sub, m/m, crossover)	21252588
RS232 cable for PC 1.8 m (9-pin D-Sub, m/f, parallel)	00410024

4.6 Interface commands

Your scale can be configured, interrogated and operated from a PC via an RS232C interface.

Preconditions

The following preconditions must be fulfilled to achieve communication between the scale and a PC:

- The scale must be connected to the RS232C interface of the PC by a suitable cable (see Section 4.5) .
- The scale interface must be set at "Dialog" mode (see Section 3.4).
- A terminal program must be available on the PC (e.g. "Hyper Terminal").
- The communications parameters (protocol, bits and parity, data transfer rate) must be set at the same values in the terminal program and in the scale (see Section 3.4).

SICS command set

Your scale supports the **Mettler Toledo Standard Interface Command Set (MT SICS)**, the SICS commands as per "Level 0" and "Level 1" being implemented:

Commands MT-SICS Level 0

I0	Inquiry of all implemented MT-SICS commands
I1	Inquiry of MT-SICS level and MT-SICS versions
I2	Inquiry of balance data
I3	Inquiry of balance SW version and type definition number
I4	Inquiry of serial number
S	Send stable weight value
SI	Send weight value immediately
SIR	Send weight value immediately and repeat
Z	Zero
ZI	Zero immediately
@	Reset

Commands MT-SICS Level 1

D	Balance display
DW	Weight display (Display show Weight)
K	Key control
SR	Send weight value on weight change (Send and Repeat)
T	Tare
TA	Inquiry/setting of tare weight value
TAC	Clear tare value
TI	Tare immediately

Detailed information on the interface commands is given in the "MT SICS Reference Manual" (No. 705184, only available in English).

In addition to the standard commands, scale-specific **SICS commands also exist to support product-specific characteristics. These commands** are not given in the "MT SICS Reference Manual", but in the documentation supplied with the individual scale. At the present time the Viper scale supports one single specific command for specifying the record header. This command is described below.

Specifying the record header

With this command you can define up to 5 lines, each with a maximum of 24 characters, which is printed out at the head of every record. Normally, the company name and address are printed on the record in this way. Specify the record header as follows:

- Ensure that the communication between the scale and the PC is in good working order.
- The command for defining the record header is **I31_x**, where "x" is the line number. Specify the desired record header as shown in the following example (only the required lines need be entered):

```
I31_1_"Mettler-Toledo GmbH"      <CR><LF>
I31_2_"Unter dem Malesfelsen 34" <CR><LF>
I31_3_"D-72458 Albstadt"        <CR><LF>
I31_4_"Telefon ++49/7431/14 0"  <CR><LF>
I31_5_"Internet www.mt.com"     <CR><LF>
```

Please observe the following:

- Every command line must be terminated with **<CR><LF>** (corresponding to the "Enter", "Return" or "↵" key on the PC keyboard). The command is then executed immediately. To correct a line, this needs to be entered again completely.
 - The "_" symbol signifies an empty space, and in the above example serves solely to clarify the syntax. The quotation marks must be entered, as they indicate to the scale that they enclose a text string and not a command.
 - You can insert empty lines by entering an empty space instead of text.
Example: **I31_2_" " <CR><LF>** . This defines line 2 as an empty line.
 - By entering **I31_x <CR><LF>** (x = line number) you can interrogate the appropriate line.
 - With the command **I31_x_" " <CR><LF>** (x = line number) you can delete the individual line again.
- Once the record header has been completely specified (and you do not want to give any further SICS commands), you can break the connection between the scale and the PC. **Important:** for the scale to actually print out the record, the interface mode must be reset at "Print", and the setting "Header" must be activated ("On") for the data to be transferred ("defStr"). A description of these settings and a specimen record corresponding to the above example are to be found in Section 3.4.

**To give your METTLER TOLEDO products an assured future:
METTLER TOLEDO Service preserves the quality, measurement
accuracy and value of METTLER TOLEDO products for years to
come.**

**Incidentally, the scale can be adjusted to suit your needs. Ask
your METTLER TOLEDO salesperson or specialist scales dealer
for more details.**

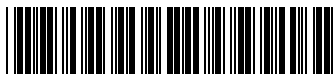

P21203186

Subject to technical changes and to the availability of the
accessories supplied with the instruments.

Design registered.
Printed on 100 % chlorine-free paper,
for the sake of our environment.

© Mettler-Toledo (Albstadt) GmbH 2003 21203186D Printed in Germany 0310/2.12

Mettler-Toledo (Albstadt) GmbH, D-72423 Albstadt, Tel. +49-7431 14-0, Fax +49-7431 14-371, Internet: <http://www.mt.com>

AT Mettler-Toledo Ges.m.b.H., A-1100 Wien, Tel. (01) 604 19 80, Fax (01) 604 28 80
AU Mettler-Toledo Ltd., Port Melbourne, Victoria 3207, Tel. (03) 9644 5700, Fax (03) 9645 3935
BE n.v. Mettler-Toledo s.a., B-1932 Zaventem, Tel. (02) 334 02 11, Fax (02) 378 16 65
BR Mettler-Toledo Indústria e Comércio Ltda., São Paulo, CEP 06465-130, Tel. (11) 421 5737, Fax (11) 725 1962
CH Mettler-Toledo (Schweiz) AG, CH-8606 Greifensee, Tel. (01) 944 45 45, Fax (01) 944 45 10
CN Mettler-Toledo Changzhou Scale Ltd., Changzhou City, Jiangsu 213001, Tel. (519) 664 20 40, Fax (519) 664 19 91
CZ Mettler-Toledo, s.r.o., CZ-100 00 Praha 10, Tel. (2) 72 123 150, Fax (2) 72 123 170
DE Mettler-Toledo GmbH, D-35353 Giessen, Tel. (0641) 50 70, Fax (0641) 52 951
DK Mettler-Toledo A/S, DK-2600 Glostrup, Tel. (43) 27 08 00, Fax (43) 27 08 28
ES Mettler-Toledo S.A.E., E-08908 Hospitalet de Llobregat (Barcelona), Tel. (93) 223 76 00, Fax (93) 223 76 01
FR Mettler-Toledo s.a., F-78222 Viroflay, Tél. (01) 309 717 17, Fax (01) 309 716 16
HK Mettler-Toledo (HK) Ltd., Kowloon HK, Tel. (852) 2744 1221, Fax (852) 2744 6878
HR Mettler-Toledo, d.o.o., CR-10000 Zagreb, Tel. (1) 29 20 633, Fax (1) 29 58 140
HU Mettler-Toledo Kft, H-1173 Budapest, Tel. (1) 257 9889, Fax (1) 257 7030
IN Mettler-Toledo India Pvt Ltd, Mumbai 400 072, Tel. (22) 857 08 08, Fax (22) 857 50 71
IT Mettler-Toledo S.p.A., I-20026 Novate Milanese, Tel. (02) 333 321, Fax (02) 356 29 73
JP Mettler-Toledo K.K., Shiomi, J-Osaka 540, Tel. (6) 949 5901, Fax (6) 949 5945
KR Mettler-Toledo (Korea) Ltd., Seoul (135-090), Tel. (82) 2 518 20 04, Fax (82) 2 518 08 13
MY Mettler-Toledo (M) Sdn.Bhd., 40150 Selangor, Tel. (603) 7845 5773, Fax (603) 7845 8773
MX Mettler-Toledo S.A. de C.V., Mexico CP 06430, Tel. (5) 547 5700, Fax (5) 541 2228
NL Mettler-Toledo B.V., NL-4000 HA Tiel, Tel. (0344) 638 363, Fax (0344) 638 390
NO Mettler-Toledo A/S, N-1008 Oslo, Tel. (22) 30 44 90, Fax (22) 32 70 02
PL Mettler-Toledo, Sp. z o.o., PL-02-929 Warszawa, Tel. (22) 651 92 32, Fax (22) 651 71 72
RU Mettler-Toledo AG, 10 1000 Moskau, Tel. (095) 921 68 12, Fax (095) 921 63 53
SE Mettler-Toledo AB, S-12008 Stockholm, Tel. (08) 702 50 00, Fax (08) 642 45 62
SEA Mettler-Toledo (SEA), 40150 Selangor, Tel. (603) 7845 5373, Fax (603) 7845 3478
SG Mettler-Toledo (S) Pte. Ltd., Singapore 139959, Tel. (65) 890 0011, Fax (65) 890 0012
SK Mettler-Toledo, service s.r.o., SK-83103 Bratislava, Tel. (7) 525 2170, Fax (7) 525 2173
SI Mettler-Toledo, d.o.o., SI-1236 Trzin, Tel. (016) 162 18 01, Fax (061) 162 17 89
TH Mettler-Toledo (Thailand), Bangkok 10310, Tel. (662) 723 0300, Fax (662) 719 6479
TW Mettler-Toledo Pac Rim AG, Taipei, Tel. (886) 2 2579 5955, Fax (886) 2 2579 5977
UK Mettler-Toledo Ltd., Leicester, LE4 1AW, Tel. (0116) 235 0888, Fax (0116) 236 5500
US Mettler-Toledo, Inc., Columbus, Ohio 43240, Tel. (614) 438 4511, Fax (614) 438 4900

For all other countries: Mettler-Toledo GmbH, PO Box VI-400, CH-8606 Greifensee, Tel. (01) 944 22 11, Fax (01) 944 31 70