

Instruction manual

Transmitter Cond 7100 e

Order number: 52 121 152

METTLER TOLEDO



Warranty

Defects occurring within 1 year from delivery date shall be remedied free of charge at our plant (carriage and insurance paid by sender).

Subject to change without notice.

Return of products under warranty

Please contact METTLER TOLEDO's Customer Service Dept. before returning a defective device. Ship the cleaned device to the address you have been given. If the device has been in contact with process fluids, it must be decontaminated/disinfected before shipment. In that case, please attach a corresponding certificate, for the health and safety of our service personnel.



Disposal (Directive 2002/96/EC of January 27, 2003)
Please observe the applicable local or national regulations concerning the disposal of "waste electrical and electronic equipment".



Mettler-Toledo GmbH, Process Analytics, Industrie Nord,
CH-8902 Urdorf, Tel. +41 (1) 736 22 11, Fax: +41 (1) 736 26 36
Subject to technical changes. Mettler-Toledo GmbH, 05/04.
Printed in Germany.

Safety information5
Intended use6
Trademarks6
EC Declaration of Conformity7
Overview of Transmitter Cond 7100 e9
Assembly10
Package contents10
Mounting plan11
Pipe mounting, panel mounting12
Installation and connection14
Information on installation14
Terminal assignments14
Typical wirings16
Cond measurement with 4-electrode sensor16
Cond measurement with 2-electrode sensor17
Cond measurement with Mettler-Toledo 2-electrode sensor via VP plug ..	.18
Cond measurement with Mettler-Toledo 4-electrode sensor via VP plug ..	.19
Protective wiring of relay outputs20
User interface and display22
Operation: Keypad24
Safety features25
Sensoface, Sensoface sensor monitoring25
GainCheck device self test25
Automatic device self-test25
Hold mode26
Mode codes27
Configuration28
Menu structure of configuration29
Overview of configuration steps30
Output 132
Output 246
Temperature compensation52
Alarm settings54
Limit function58
Controller60
Setting of relays for USP function62
Controlling a rinsing probe or signaling parameter set 264

Selecting parameter set 1/266
External switchover of parameter sets67
Default settings of parameter sets69
Parameter set, individual settings70
Calibration72
Calibration by entry of cell constant74
Calibration with calibration solution76
Product calibration78
Adjusting temp probe80
Diagnostics functions83
Display of output currents81
Display of calibration data (Cal info)81
Sensor monitor81
Display of last error message81
Specify current at output 1 (current source 1)82
Specify current at output 2 (current source 2)82
Relay test (manual test of contacts)82
Controller test (manual specification of controller output)83
Controller functions84
PID controller84
Pulse length / pulse frequency controller86
Error messages (error codes)88
Operating states90
Sensoface92
USP function94
Appendix97
Product line and accessories97
Specifications98
Explosion protection104
Warnings and notes to ensure safe operation105
Control Drawing CSA106
Calibration solutions110
Concentration curves112
Glossary118
Index120

Safety information

Be sure to read and observe the following instructions!

The device has been designed in accordance with the state of the art and complying with the applicable safety regulations. When operating the device, certain conditions may nevertheless lead to danger for the operator or damage to the device.

Caution!

Commissioning may only be carried out by trained experts. Whenever it is likely that protection has been impaired, the device shall be made inoperative and secured against unintended operation.

The protection is likely to be impaired if, for example:

- the device shows visible damage
- the device fails to perform the intended measurements
- after prolonged storage at temperatures above 70 °C
- after severe transport stresses

Before recommissioning the device, a professional routine test in accordance with EN 61010-1 must be performed. This test should be carried out by the manufacturer.

Caution!

Before commissioning it must be proved that the device may be connected with other equipment.

Intended use

The Transmitter Cond 7100 e is used for measurement of electrical conductivity and temperature in liquids.

Fields of application are: biotechnology, chemical industry, environment, food processing, water/waste-water treatment.

The rugged molded enclosure can be fixed into a control panel or mounted on a wall or at a post. The protective hood provides additional protection against direct weather exposure and mechanical damage.

The Transmitter has been designed for 2- and 4-electrode sensors.

It provides a second current output for temperature measurement, a PID controller (making use of the relay contacts), and a universal power supply for 24 ... 230 V AC/DC.





For CIP applications, you can switch between two parameter sets.

Trademarks

The following names are registered trademarks. For practical reasons they are shown without trademark symbol in this manual.

InPro®
EasyClean®

EC Declaration of Conformity

Mettler-Toledo GmbH Process Analytics			
Address: Im Hackacker 15, (Industrie Nord) 8902 Urdorf, Switzerland Mail address: Postfach, CH-8902 Urdorf Phone: 01-7386 22 11 Fax: 01-738 26 36 Internet: www.ttl.com Bank: Credit Suisse, 8070 Zurich, Clearing 4835 Account No.: 370501-21-90 CHF/IBAN CH11 0483 5037 0501 2109 0			
		Declaration of conformity Konformitätserklärung  Déclaration de conformité	
Wir/Wir/Nous	Mettler-Toledo GmbH, Process Analytics Im Hackacker 15 8902 Urdorf Switzerland declare under our sole responsibility that the product, erklären in alleiniger Verantwortung, dass dieses Produkt, déclarons sous notre seule responsabilité que le produit,		
Description Beschreibung/Description	Cond 7100e to which this declaration relates is in conformity with the following standard(s) or other normative document(s), auf welches sich diese Erklärung bezieht, mit der/den folgenden Norm(en) oder Richtlinie(n) übereinstimmt, auquel se réfère cette déclaration est conforme à la (aux) norme(s) ou au(x) document(s) normatif(s).		
Low-voltage directive/ Nieder-spannungs-Richtlinie/ Directive basse tension	73/23/EWG		
Norm/Standard/Standard	EN 61010-1 / VDE 0411 Teil 1: 2002-08		
EMC directive/EMV-Richtlinie Directive concernant la CEM	89/336/EWG		
Norm/Standard/Standard	DIN EN 61326 / VDE 0843 Teil 20 1998-01 DIN EN 61326/A1 / VDE 0843 Teil 20/A1: 1999-05		
Place and Date of Issue Ausstellungsort / - Datum Lieu et date d'émission	Urdorf, 26.11.2002		
Mettler-Toledo GmbH, Process Analytics  Waldemar Rauch General Manager PO Urdorf  Christian Zwicky Head of Marketing			
Nr.: 52 999 999C FL Artikel Nr.: 52960284 KE		52960284KE-7100e.doc  Version a	
Corporate headquarters Mettler-Toledo GmbH, Im Langgacher, CH-8606 Greifensee			

Overview of Transmitter Cond 7100 e

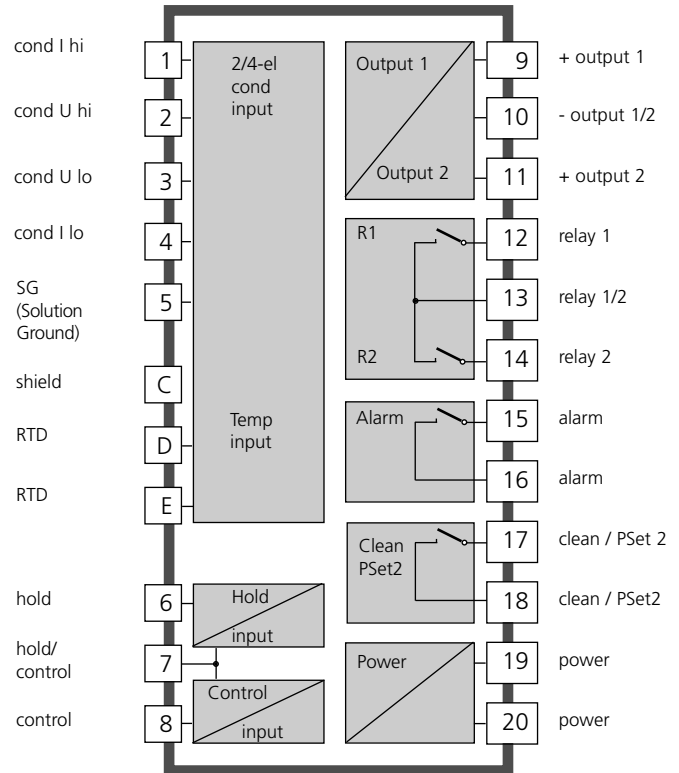

Package contents

Check the shipment for transport damage and completeness.

The package should contain:

- Front unit
- Lower case
- Bag containing small parts
- Instruction manual
- Specific test report

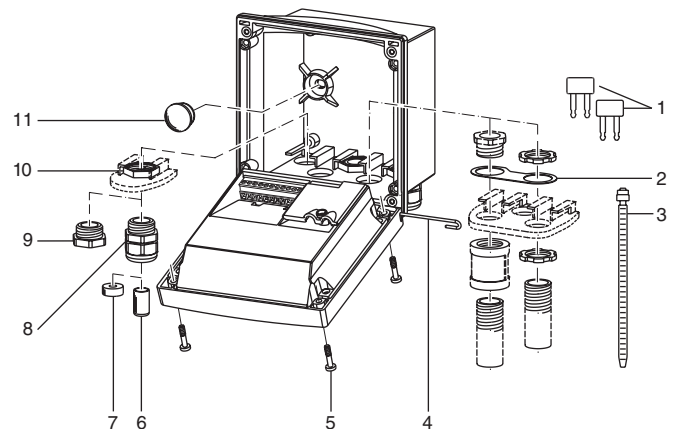

- | | |
|--|---|
| 1 Jumper (2 piece) | 6 Sealing inserts (1 piece) |
| 2 Washer (1 piece), for conduit mounting: place washer between enclosure and nut | 7 Rubber reducer (1 piece) |
| 3 Cable ties (3 pieces) | 8 Cable glands (3 pieces) |
| 4 Hinge pin (1 piece), insertable from either side | 9 Filler plugs (3 pieces) |
| 5 Enclosure screws (4 pieces) | 10 Hexagon nuts (5 pieces) |
| | 11 Sealing plugs (2 pieces), for sealing in case of wall mounting |

Fig.: Assembling the enclosure

Mounting plan

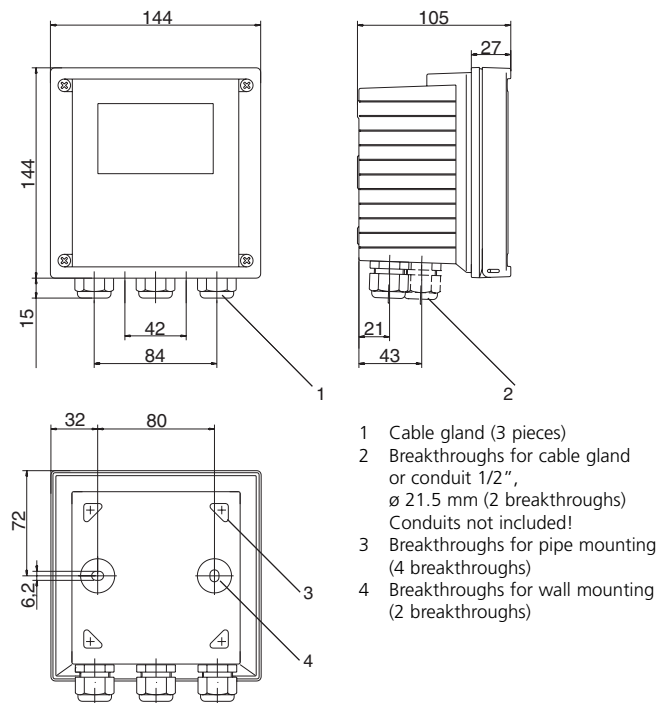
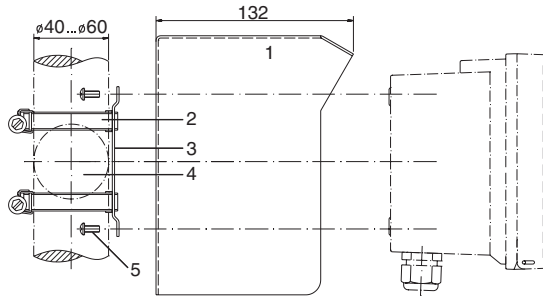

Fig.: Mounting plan



- 1 Protective hood (if required)
- 2 Hose clamps with worm gear drive to DIN 3017 (2 pieces)
- 3 Pipe-mount plate (1 piece)
- 4 For vertical or horizontal posts or pipes
- 5 Self-tapping screws (4 pieces)

Fig.: Pipe-mount kit

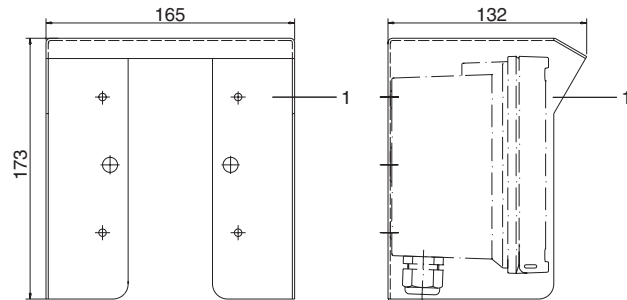
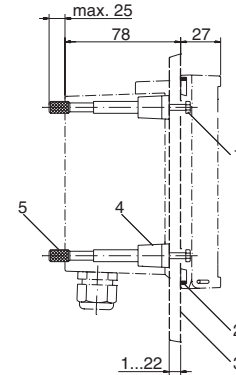

Fig.: Protective hood for wall and pipe mounting



- 1 Screws (4 pieces)
- 2 Gasket (1 piece)
- 3 Panel
- 4 Span pieces (4 pieces)
- 5 Threaded sleeves (4 pieces)

Fig.: Panel-mount kit

Information on installation

Caution!

- The Transmitter may only be installed by trained experts in accordance with this instruction manual and as per applicable local and national codes.
- Be sure to observe the technical specifications and input ratings.
- Be sure not to notch the conductor when stripping the insulation.
- Before connecting the device to the power supply, make sure that its voltage lies within the range 20.5 to 253 V AC/DC.
- When commissioning, a complete configuration must be carried out by the system administrator.

The terminals are suitable for single wires and flexible leads up to 2.5 mm² (AWG 14).

Warning!

Additional safety precautions have to be taken for applications in hazardous locations to CSA (CLI DIV2 GPA,B,C,D T4, Ex nA IIC T4)! (See Pg 105)

Terminal assignments

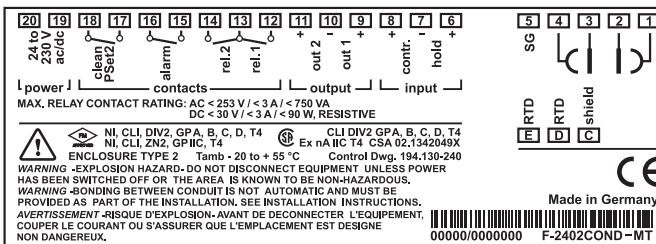
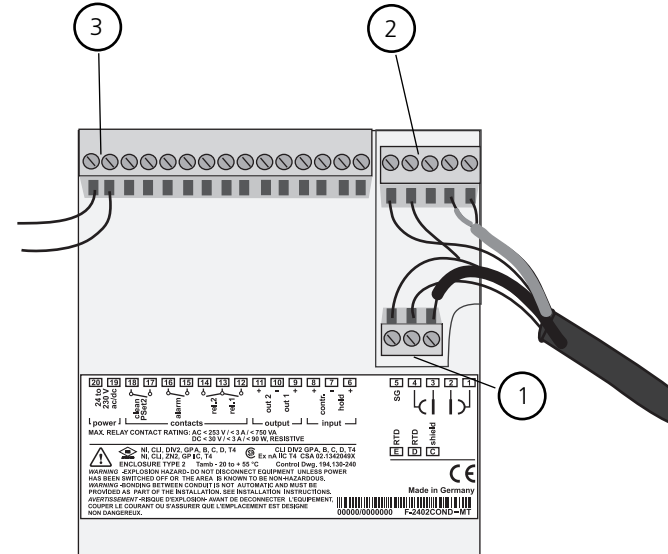

Fig.: Terminal assignments Cond 7100 e



- 1 Terminals for temperature probe and outer shield
- 2 Terminals for conductivity sensor
- 3 Terminals for power supply

Fig.: Information on installation, rear side of device

Division 2 wiring



The connections to the Transmitter must be installed in accordance with the National Electric Code (ANSI-NFPA 70) Division 2 hazardous (classified) location, non-incendive wiring techniques.

Cond measurement with 4-electrode sensor

Cond 7100 e

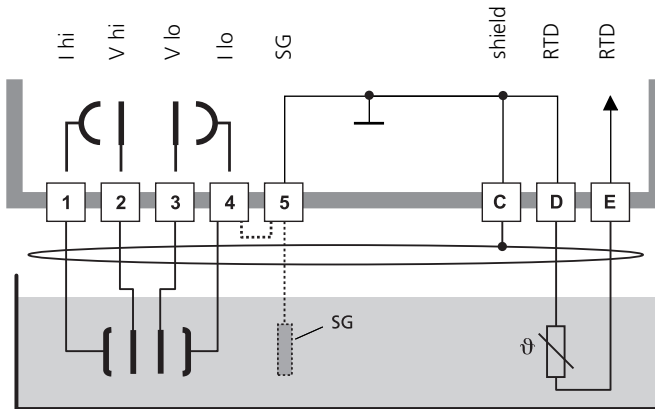

Caution!

Place jumper across terminals 4 and 5!
 When using a sensor with Solution Ground connection (SG) or a separate SG connection, the jumper is not required!

Cond measurement with 2-electrode sensor (coaxial electrodes)

Cond 7100 e

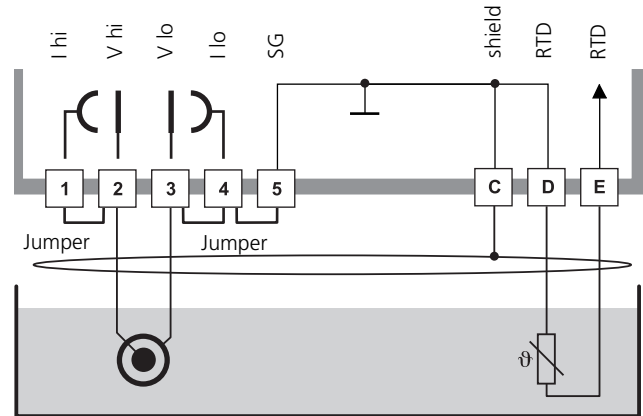

Caution!

Place jumpers: across terminals 1 and 2
 across terminals 3 und 4
 across terminals 4 and 5

Cond measurement with Mettler-Toledo 2-electrode sensor via VP plug

Cond 7100 e

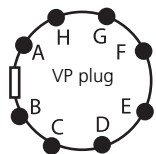
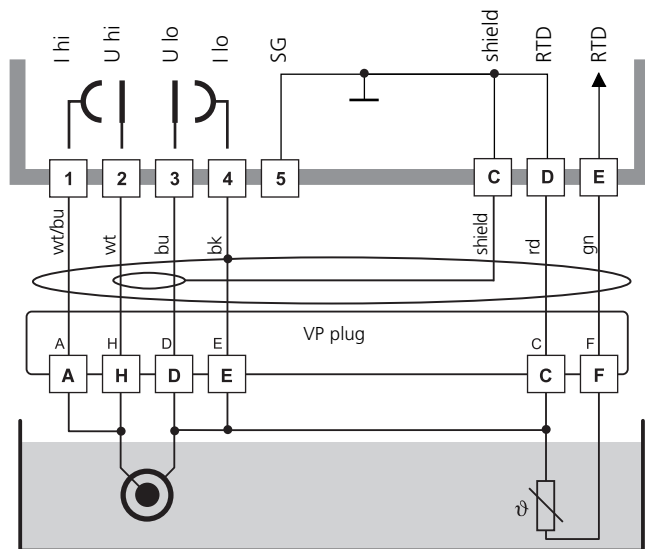

Cond measurement with Mettler-Toledo 4-electrode sensor via VP plug

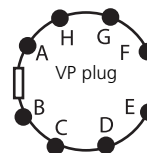
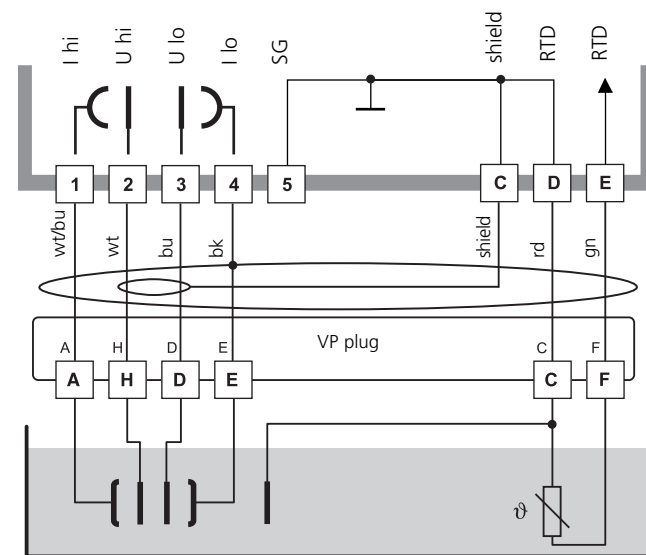

Protective wiring of relay contacts

Relay contacts are subjected to electrical erosion. Especially with inductive and capacitive loads, the service life of the contacts will be reduced. For suppression of sparks and arcing, components such as RC combinations, nonlinear resistors, series resistors and diodes should be used.

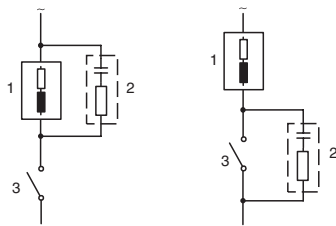

Typical AC applications with inductive load

- 1 Load
- 2 RC combination, e.g. RIFA PMR 209
Typical RC combinations for 230 V AC:
Capacitor 0.1 μ F / 630V,
Resistor 100 Ohms / 1 W
- 3 Contact

Typical protective wiring measures

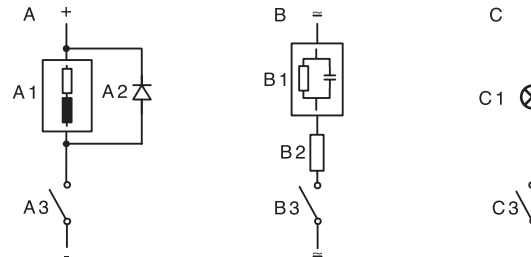

A: DC application with inductive load

B: AC/DC applications with capacitive load

C: Connection of incandescent lamps

- | | |
|----|--|
| A1 | Inductive load |
| A2 | Free-wheeling diode, e.g. 1N4007
(Observe polarity) |
| A3 | Contact |
| B1 | Capacitive load |
| B2 | Resistor, e.g. 8 Ohms/1W at 24V/0.3A |
| B3 | Contact |
| C1 | Incandescent lamp, max 60W/230V, 30W/115V |
| C3 | Contact |

Warning!

Make sure that the maximum ratings of the relay contacts are not exceeded even during switching!

User interface

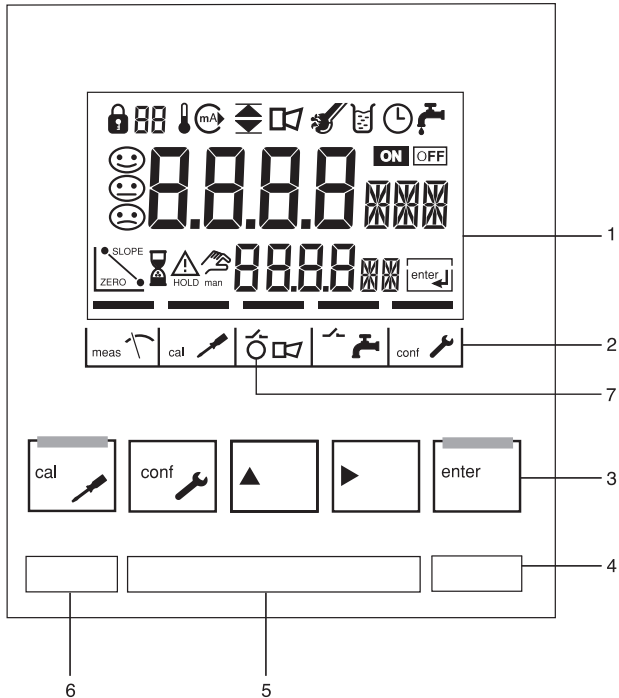





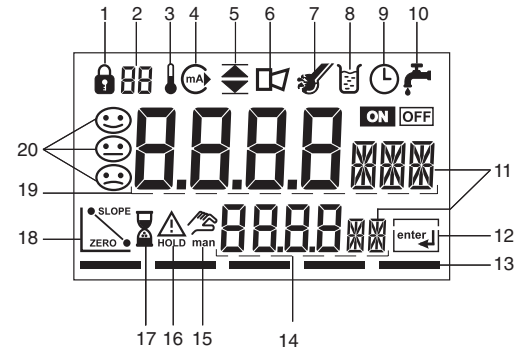





- | | |
|--|---------------------|
| 1 Display | 3 Keypad |
| 2 Mode indicators (no keys), from left to right: | 4 Coding |
| - Measuring mode | 5 Rating plate |
| - Calibration mode | 6 Model designation |
| - Alarm | 7 Alarm LED |
| - Wash contact | |
| - Configuration mode | |

Display



- | | |
|---|--------------------------|
| 1 Mode code entry | 14 Lower display |
| 2 Parameter set 2 selected | 15 Manual temp indicator |
| 3 Temperature | 16 Hold mode active |
| 4 Current output | 17 Waiting time running |
| 5 Limit values | 18 Electrode data |
| 6 Alarm | 19 Main display |
| 7 Sensocheck | 20 Sensoface |
| 8 Calibration | |
| 9 Interval/response time | |
| 10 Wash contact | |
| 11 Measurement symbols | |
| 12 Proceed with enter | |
| 13 Bar for identifying the device status, above mode indicators from left to right: | |
| - Measuring mode | |
| - Calibration mode | |
| - Alarm | |
| - Wash contact | |
| - Configuration mode | |

	Start, end calibration
	Start, end configuration
	Select digit position (selected position flashes)
	Edit digit
	<ul style="list-style-type: none"> • Calibration: Continue in program sequence • Configuration: Confirm entries, next configuration step • Measuring mode: Display output current

 ➔ 	Cal Info, display of cell constant
 ➔ 	Error Info, display last error message
 + 	Start GainCheck device self-test

Safety functions

Sensocheck, Sensoface sensor monitoring

Sensocheck continuously monitors the sensor and lines. Sensocheck can be switched off (Configuration, Pg 55).





Sensoface provides information on the conductivity sensor condition. Significant sensor polarization effects or an excessive cable capacitance are indicated.



GainCheck device self-test

A display test is carried out, the software version is displayed and the memory and measured value transfer are checked.

Start GainCheck device self-test:  + 

Automatic device self-test

The automatic device self-test checks the memory and measured-value transfer. It runs automatically in the background at fixed intervals.

Hold mode

Display:



The Hold mode is a safety state during configuration and calibration. Output current is frozen (Last) or set to a fixed value (Fix). Alarm and limit contacts are disabled.

If the calibration or configuration mode is exited, the Transmitter remains in the Hold mode for safety reasons. This prevents undesirable reactions of the connected peripherals due to incorrect configuration or calibration. The measured value and "HOLD" are displayed alternately. The Transmitter only returns to measuring mode after **enter** is pressed and 20 seconds have passed.

To activate the Hold mode from outside

The Hold mode can be activated from outside by sending a signal to the Hold input (e.g. from the process control system).

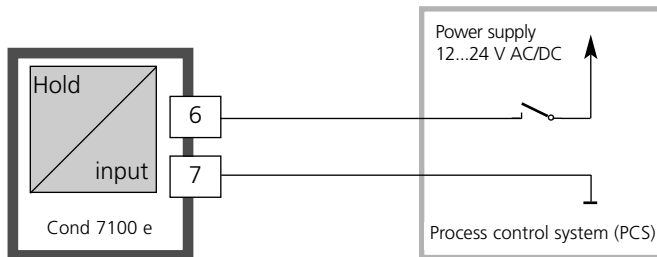

Hold active	Hold inactive
10 ... 30 V AC/DC	0 ... 2 V AC/DC

Mode codes

The mode codes allow fast access to the functions

Calibration

Key + Code	Description
0000	Cal Info Display of cell constant
0110	Calibration by entry of solution
1100	Calibration by entry of cell constant
1105	Product calibration
1015	Adjusting temp probe

Configuration



Key + Code	Description
0000	Error Info Display of last error
1200	Configuring parameter set 1
1288	Configuring parameter set 2
2222	Sensor monitor Display resistance and temp
7654	Parameter set 1/2 Switchover internal / external
5555	Current source 1 Output current 1 specified
5556	Current source 2 Output current 2 specified
5557	Relay test Manual test of contacts
5559	Manual controller Manual specification of controller output

In the Configuration mode you set the device parameters. The Transmitter can store two different parameter sets and switch between them. Sensor data and "Clean/PSEt2" output are edited in parameter set 1 only. They are valid for both parameter sets.



Configuring  Press **conf**.

Parameter set 1
Configure:  Enter mode code "1200":
Edit parameter set 1 with **▶** and **▲**, confirm/proceed with **enter**.

Parameter set 2
Configure:  Enter mode code "1288":
"88" appears in the display.
Edit parameter set 2 with **▶** and **▲**, confirm/proceed with **enter**.

Hold  During configuration the Transmitter remains in the Hold mode.
 The output current is frozen (at its last value or at a preset fixed value, depending on the configuration), limit and alarm contacts are inactive. The controller is in the configured state, Sensoface is off, mode indicator "Configuration" is on.

Input errors  The configuration parameters are checked during the input. In the case of an incorrect input "Err" is displayed for approx. 3 s. The incorrect parameters cannot be stored. Input must be repeated.

End   End with **conf**. The measured value and Hold are displayed alternately, "enter" flashes. End Hold mode with **enter**. The display shows the measured value. The output current remains frozen for another 20 s (HOLD icon on, "hourglass" flashes).

Menu structure of configuration

The configuration steps are assigned to different menu groups. With the arrow keys you can jump between the individual menu groups. Each menu group contains menu items for setting the parameters. Pressing **enter** opens a menu item. The values are edited using the arrow keys. Pressing **enter** confirms/stores the settings. Return to measurement: Press **conf**.

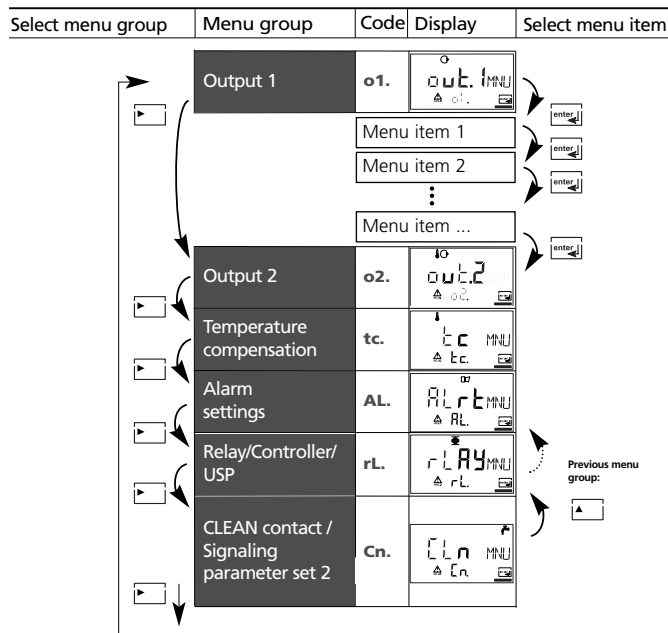

Overview of configuration steps

Code	Menu	Selection / Default
out1	Output 1	
o1.	Sensor selection *	2-electrode, 4-electrode
	Select measured variable	μ S, mS/cm, M Ω -cm, SAL, Conc, USP
	Select solution (Conc) see Pg 112	NaCl HCl NaOH H ₂ SO ₄ HNO ₃
	Codes:	-1- -2- -3- -4- -5-
	Select current range	0-20 mA / 4-20 mA
	Characteristic (not for SAL, Conc, USP)	Linear / Logarithmic
	LIN: Enter current beginning	xxxx
	Enter current end	xxxx
	LOG: Enter current beginning	in decades: 0.001 ... 1000
	Enter current end	in decades: 0.001 ... 1000
Time constant of output filter	xxxx SEC	
22 mA signal for error messages	ON / OFF	
Signal behavior during HOLD	Last / Fix	
Fix: Enter fixed value	xxx.x mA	
out2	Output 2	
o2.	Select temperature unit	°C / °F
	Selection of temperature probe *	Pt100; Pt1000; NTC 8.55k NTC 30k
	Select current range	0-20 mA / 4-20 mA
	Enter current beginning	xxx.x
	Enter current end	xxx.x
	Time constant of output filter	xxxx SEC
	Temp error signaled by 22 mA	ON / OFF
	Signal behavior during HOLD	Last / Fix
Fix: Enter fixed value	xxx.x mA	
tc	Temperature compensation	
tc.	Temperature compensation selection	OFF / Lin / nLF / NaCl / HCl / NH ₃
	Lin: Input of temp coefficient	xx.xx %/K
ALrt	Alarm settings	
AL.	Select Sensocheck	ON / OFF
	Enter alarm delay	xxxx SEC
	LED in HOLD mode	ON / OFF

Cond 7100 e

Code	Menu	Selection / Default	
rLAY	Relay 1/2: Limits, controller, USP function		
rL.	Select limit function / Controller / USP	LiMIT / CtROL / USP	
	L1.	Select contact function	Lo / Hi
		Select contact response	N/O / N/C
		Enter switching point	xxxx
		Enter hysteresis	xxxx
	Enter delay	xxxx SEC	
	L2.	Select contact function	Lo / Hi
		Select contact response	N/O / N/C
		Enter switching point	xxxx
		Enter hysteresis	xxxx
Enter delay	xxxx SEC		
Enter controller setpoint	xxxx		
Ct.	Enter neutral zone	xxxx	
	(P) Controller gain Kc	xxxx %	
	(I) Reset time Tr	xxxx SEC	
	(D) Rate time Td	xxxx SEC	
	Controller	PLC / PFC	
	PLC: Pulse length	xxxx SEC	
	PFC: Pulse frequency	xxxx /min	
Select HOLD behavior	Y Last / Y Off		
U1.	Enter reduced USP factor	xxxx %	
	Select contact response	N/O / N/C	
Enter delay	xxxx SEC		
U2.	Select contact response	N/O / N/C	
	Enter delay	xxxx SEC	
CIn	Contact CLEAN / PSEt2		
Cn.	Select as cleaning contact / Signal for parameter set 2 *	rinse / PSEt2	
	rinse	Rinsing interval	xxx.x h
		Rinse duration	xxxx SEC
Contact response		N/O / N/C	

*) These parameters are only edited in parameter set 1.
They are valid for both parameter sets.

Configuration

Output 1

Select sensor type

Menu group	Code	Display	Select menu item
Output 1	01.		Sensor selection
			Select measured variable
			Select solution (Conc)
			Select 0-20 / 4-20 mA
			Characteristic: LIN / LOG
			Enter current beginning
			Enter current end
			Set output filter
			22 mA in the case of error
			Hold mode

End:
Press **conf**, then **enter**

Code	Display	Action	Choices
01.		Select configuration (Press conf .)	
		For parameter set 1: Enter mode code "1200" (Select position using ► arrow key and edit number using ▲. When the display reads "1200", press enter to confirm.)	
		For parameter set 2: Enter mode code "1288" (Select position using ► arrow key and edit number using ▲. When the display reads "1288", press enter to confirm.)	
		The Transmitter is in HOLD mode (HOLD icon is on).	
		Select sensor * 2-electrode sensor / 4-electrode sensor	2-EL (2-El/ 4-El)
		Select with arrow key Proceed with enter	

Note: Characters represented in gray are flashing and can be edited.

*) These parameters are only edited in parameter set 1.
They are valid for both parameter sets.

Configuration

Output 1

Select measured variable

Menu group	Code	Display	Select menu item
Output 1	o1.		Sensor selection
			Select measured variable
			Select solution (Conc)
			Select 0-20 / 4-20 mA
			Characteristic: LIN / LOG
			Enter current beginning
			Enter current end
			Set output filter
			22 mA in the case of error
			Hold mode

End:
Press **conf**, then **enter**

Code	Display	Action	Choices
o1.		Select measured variable:	000.0 mS
		Select with arrow key Proceed with enter	(0.000 μS 00.00 μS (USP) 000.0 μS 0000 μS 0.000 mS 00.00 mS 000.0 mS
		Conductivity:	0.000 S/m 00.00 S/m 000.0 S/m
		<ul style="list-style-type: none"> • 0.000 ... 9.999 μS/cm • 00.00 ... 99.99 μS/cm • 000.0 ... 999.9 μS/cm • 0.000 ... 9.999 mS/cm • 00.00 ... 99.99 mS/cm • 000.0 ... 999.9 mS/cm • 0.000 ... 9.999 S/m • 00.00 ... 99.99 S/m 	0.000 S/m 00.00 S/m 00.00 MΩ 0.00 SAL 00.00 % USP)
		Resistivity:	0.00 MΩ-cm
		Salinity (SAL):	0.0 % (0 ... 35 °C)
		Concentration (Conc):	0.00 % by wt
		USP – automatic range	00.00 ... 99.99 μS/cm

Note: Characters represented in gray are flashing and can be edited.

Configuration

Output 1

Concentration measurement:

Select process solutions

Menu group	Code	Display	Select menu item
Output 1	o1.		Sensor selection
			Select measured variable
			Select solution (Conc)
			Select 0-20 / 4-20 mA
			Characteristic: LIN / LOG
			Enter current beginning
			Enter current end
			Set output filter
			22 mA in the case of error
			Hold mode

End:
Press **conf**, then **enter**

Code	Display	Action	Choices
o1.		<p>Only with 00.00 % Conc, you can select the process solution:</p> <p>Select with ► key</p> <p>-01- NaCl (0.00 ... 9.99 % by wt) (0 ... 120 °C) -02- HCl (0.00 ... 9.99 % by wt) (-20 ... 50 °C) -03- NaOH (0.00 ... 9.99 % by wt) (0 ... 100 °C) -04- H₂SO₄ (0.00 ... 9.99 % by wt) (-17 ... 110 °C) -05- HNO₃ (0.00 ... 9.99 % by wt) (-17 ... 50 °C)</p> <p>Proceed with enter</p>	<p>-01-SOL (-01-SOL -02-SOL -03-SOL -04-SOL -05-SOL)</p>

Concentration measurement

For the solutions listed above, the Transmitter can determine the substance concentration from the measured conductivity and temperature values in % by wt. The measurement error is made up of the sum of measurements errors during conductivity and temperature measurement and the accuracy of the concentration curves stored in the Transmitter (see Pg 112).

We recommend to calibrate the Transmitter together with the sensor. For exact temperature measurement, you should perform a temperature probe adjustment. For measuring processes with rapid temperature changes, a separate temperature probe with fast response should be used. When measuring processes such as dilution or intensification of CIP solutions (Clean-In-Place), it is helpful to switch between the parameter sets for measuring the process medium and for measuring the CIP solution.

Configuration

Output 1

Output current range. LIN/LOG curve

LIN curve: Current beginning / end

Menu group	Code	Display	Select menu item
Output 1	o1.		Sensor selection
			Select measured variable
			Select solution (Conc)
			Select 0-20 / 4-20 mA
			Characteristic: LIN / LOG
			Enter current beginning
			Enter current end
			Set output filter
			22 mA in the case of error
			Hold mode

End:
Press **conf**, then **enter**

Code	Display	Action	Choices
o1.		Set output current range Select with ► key Proceed with enter	4-20 mA (0 - 20 mA/ 4 - 20 mA)
		Select output characteristic Select with ► key Proceed with enter (Step omitted for % (Conc) or SAL)	LIN (LIN / LOG)
		With LIN selected: • Enter current beginning Enter lower end of scale Select with ► key, edit number with ▲ key, proceed with enter key.	000.0 mS (depending on selected range)
		• Enter current end Enter upper end of scale Proceed with enter	100.0 mS (depending on selected range)

Assignment of measured values: Current beginning and current end

Example 1: Range 0...200 mS/cm

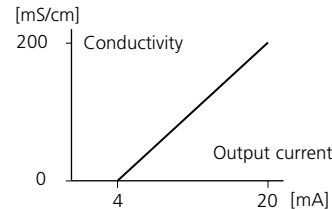

Example 2: Range 100...200 mS/cm
Advantage: Higher resolution in range of interest

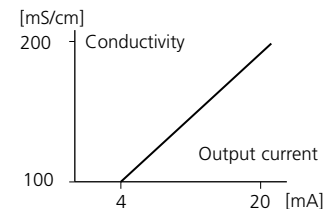

Configuration

Output 1

Output current range. LOG curve

Current beginning/end

Menu group	Code	Display	Select menu item
Output 1	o1.		Sensor selection
			Select measured variable
			Select solution (Conc)
			Select 0-20 / 4-20 mA
			Characteristic: LOG
			Enter current beginning
			Enter current end
			Set output filter
			22 mA in the case of error
			Hold mode

Code	Display	Action	Choices
o1.		With LOG selected: • Enter lower end of scale (= current beginning) Select with ► key, edit number with ▲ key, proceed with enter key.	0.1 mS (depending on selected range, in decades: 0.001 ... 1000)
		• Enter upper end of scale (= current end) Select with ► key, edit number with ▲ key, proceed with enter key.	100 mS depending on selected range, in decades: 0.001 ... 1000)

Example: Measurement range over 3 decades

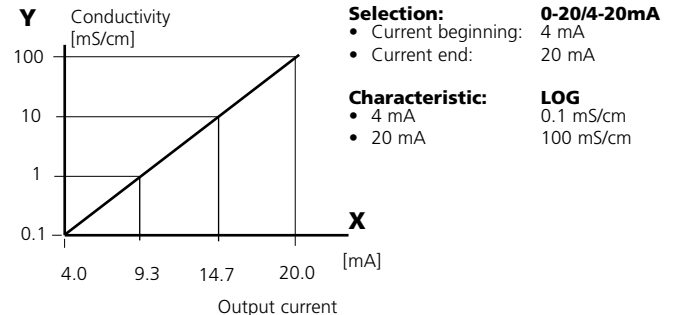



End:
Press **conf**, then **enter**

Configuration

Output 1

Time constant of output filter

Menu group	Code	Display	Select menu item
Output 1	01.		 Sensor selection
			Select measured variable
			Select solution (Conc)
			Select 0-20 / 4-20 mA
			Characteristic: LIN / LOG
			Enter current beginning
			Enter current end
			Set output filter
			22 mA in the case of error
			Hold mode

End:
Press **conf**, then **enter**

Code	Display	Action	Choices
01.		Time constant of output filter Default setting: 0 s (inactive). To specify a time constant: Select with ► key, edit number with ▲ key, proceed with enter key.	0000 SEC (0000 ... 0120 SEC)

Time constant of output filter (attenuation)

To smoothen the current output, a low-pass filter with adjustable filter time constant can be switched on. When there is a jump at the input (100 %), the output level is 63 % after the time constant has been reached.

The time constant can be set from 0 to 120 s.

If the time constant is set to 0 s, the current output follows the input.

Note:

The filter only acts on the current output, not on the display, the limit values, or the controller!

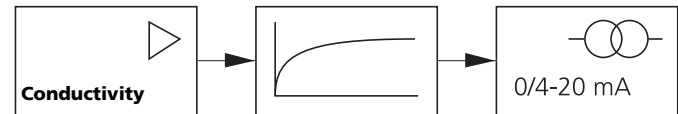

Time constant 0 to 120 s

Configuration

Output 1

Output current during Error and HOLD.

Menu group	Code	Display	Select menu item
Output 1	01.		<p>Sensor selection</p> <p>Select measured variable</p> <p>Select solution (Conc)</p> <p>Select 0-20 / 4-20 mA</p> <p>Characteristic: LIN / LOG</p> <p>Enter current beginning</p> <p>Enter current end</p> <p>Set output filter</p> <p>22 mA in the case of error</p> <p>Hold mode</p>

End:
Press **conf**, then **enter**

Code	Display	Action	Choices
01.		22 mA signal for error message Select with ► arrow key. Proceed with enter	OFF (OFF / ON)
		Output signal during HOLD LAST: During HOLD the last measured value is maintained at the output FIX: During HOLD a value (to be entered) is maintained at the output Select with ► arrow key. Proceed with enter	LAST (LAST / FIX)
	 	Only with FIX selected: Enter current which is to flow at the output during HOLD Select position with ► key, edit number with ▲ key, proceed with enter key.	021.0 mA (000.0 - 022.0 mA)

Output signal for HOLD:

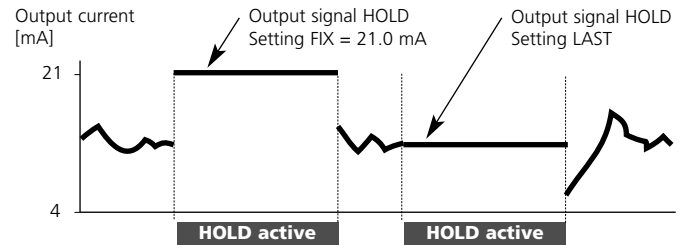





Configuration

Output 2

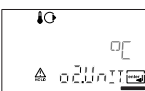
Temperature unit and probe, output current.

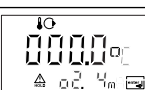
Menu group	Code	Display	Select menu item
Output 2	o2.		Select °C/°F
			Select temp probe
			Select 0-20 / 4-20 mA
			Enter current beginning
			Enter current end
			Set output filter
			22 mA for temp error
			Hold mode

Code	Display	Action	Choices
o2.		Specify temperature unit Select with ► arrow key Proceed with enter	°C (°C / °F)
		Select temperature probe * Select with ► arrow key Proceed with enter	100 PT 1000 PT 8.55 NTC 30 k NTC
		Set output current range Select with arrow key Proceed with enter	4-20 mA (4 - 20 mA/ 0 - 20 mA)
		Current beginning: Enter lower end of scale. Select with ►, edit number with ▲, proceed with enter .	000.0 °C (xxx.x °C)
		Current end: Enter upper end of scale. Select with ►, edit number with ▲, proceed with enter .	100.0 °C (xxx.x °C)

Process temperature: Current beginning and end

Example 1: Range 0 to 100 °C

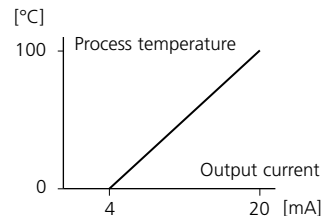

Example 2: Range 50 to 70 °C.

Advantage: Higher resolution in range of interest

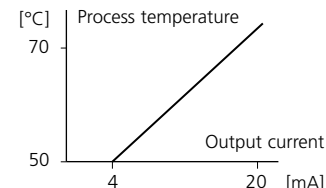

End:
Press **conf**, then **enter**

*) These parameters are only edited in parameter set 1. They are valid for both parameter sets.

Configuration

Output 2

Time constant of output filter.

Menu group	Code	Display	Select menu item
Output 2	o2.		Select °C/°F
			Select 0-20 / 4-20 mA
			Enter current beginning
			Enter current end
			Set output filter
			22 mA for temp error
			Hold mode

End:
Press **conf**, then **enter**

Code	Display	Action	Choices
o2.		Time constant of output filter Default setting: 0 s (inactive). To specify a time constant: Select position with ► key, edit number with ▲ key, proceed with enter key.	0000 SEC (0000 - 0120 SEC)

Time constant of output filter (attenuation)

To smoothen the current output 2, a low-pass filter with adjustable filter time constant can be switched on. When there is a jump at the input (100 %), the output level is 63 % after the time constant has been reached.

The time constant can be set from 0 to 120 s.

If the time constant is set to 0 s (default), the current output follows the input.

Note:

The filter only acts on the current output, not on the display!

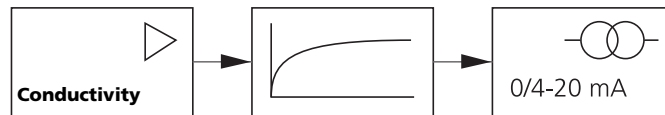

Time constant 0 to 120 s

Configuration

Output 2

Temperature error. Output current during HOLD.

Menu group	Code	Display	Select menu item
Output 2	o2.		Select °C/°F
			Select 0-20 / 4-20 mA
			Enter current beginning
			Enter current end
			Set output filter
			22 mA for temp error
			Hold mode

End:
Press **conf**, then **enter**

Code	Display	Action	Choices
o2.		22 mA signal for error message Select with ► arrow key. Proceed with enter	OFF (OFF / ON)
		Output signal during HOLD LAST: During HOLD the last measured value is maintained at the output FIX: During HOLD a value (to be entered) is maintained at the output Select with ► arrow key. Proceed with enter	LAST (LAST / FIX)
		Only with FIX selected: Enter current which is to flow at the output during HOLD Select position with ► key, edit number with ▲ key, proceed with enter key.	021.0 mA (000.0 ... 022.0 mA)

Output signal during HOLD:

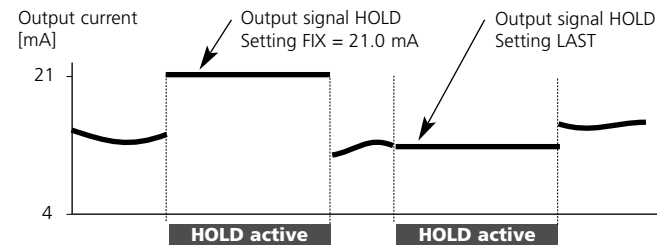







Configuration

Temperature compensation

Selecting temperature compensation

Menu group	Code	Display	Select menu item
Temperature compensation	tc.		Selecting temperature compensation

End:
Press **conf**, then **enter**

Code	Display	Action	Choices
tc.		Select temp compensation (not for USP) OFF: Temperature compensation switched off Select with ► key. Proceed with enter	OFF (OFF LIN nLF nACL HCL nH3)
		LIN: Linear temperature compensation with entry of temperature coefficient and reference temperature	
		nLF: Temperature compensation for natural waters to EN 27888	
		NaCl (nACL): Temperature compensation for ultrapure water with NaCl traces	
		HCl (HCL): Temperature compensation for ultrapure water with HCl traces	
		NH3 (nH3): Temperature compensation for ultrapure water with NH ₃ traces	
		Only with linear temperature compensation (LIN) selected: Enter temperature coefficient. Select with ► key, edit number with ▲ key, proceed with enter key.	02.00%/K (XX.XX %/K)

Menu group	Code	Display	Select menu item
Alarm settings	AL.		Select Sensocheck
			Delay
			LED in HOLD mode
			End: Press conf , then enter

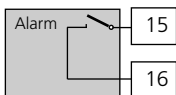



Alarm contact

The alarm contact is closed during normal operation (N/C). It opens in the case of alarm or power outage. As a result, a failure message is provided even in the case of line breakage (fail-safe behavior). For contact ratings, see Specifications.

Error messages can also be signaled by a 22 mA output current (see Pg 45, 51, 88).

The operating behavior of the alarm contact is shown on Pg 90.

The **alarm delay** acts on the LED, the 22 mA signal and the alarm contact.

Code	Display	Action	Choices
AL.		Select Sensocheck (Continuous monitoring of sensor properties) Select with ► key. Proceed with enter .	OFF (ON / OFF)
		Alarm delay Select with ►, edit number with ▲, proceed with enter .	0010 SEC (0000 - 0600 SEC)
		LED in HOLD mode Select with ► key. Proceed with enter .	OFF (ON / OFF)
	LED state:		
	Configuration	Alarm	HOLD
	ON	on	flashes
	OFF	flashes	off

Configuration

Limit function

Use of relays. Settings of relay 1

Menu group	Code	Display	Select menu item
Relay/Controller/ USP	rL.		Use of relays
	L1.		Contact function
			Contact response
			Enter switching point
			Enter hysteresis
			Delay
	L2.		Relay 2 menu group
	Ct.		Controller menu group
	U1		USP: Relay 1
	U2		USP: Relay 2

End:
Press **conf**, then **enter**

Code	Display	Action	Choices
rL.		Use of relays: <ul style="list-style-type: none"> Limit function (LiMIT) Controller (CtROL) USP function Select with ► key. Proceed with enter . Note: Selecting <ul style="list-style-type: none"> CtROL leads to Controller menu Ct. USP leads to relay for USP menu U1 U2 	LiMIT (LiMIT CtROL USP)
L1.		Limit 1 function , see Page 59. Select with ► key. Proceed with enter .	Lo (Lo/Hi)
		Limit 1 contact response N/O: normally open contact N/C: normally closed contact Select with ► key. Proceed with enter .	N/O (N/O N/C)
		Limit 1 switching point Select with ►, edit number with ▲, proceed with enter .	000.0 mS (xxxx)
		Limit 1 hysteresis Select with ►, edit number with ▲, proceed with enter .	001.0 mS (xxxx)
		Limit 1 delay The contact is activated with delay (deactivated without delay) Select with ►, edit number with ▲, proceed with enter .	0010 SEC (xxxx SEC)

Configuration

Limit function

Settings of relay 2

Menu group	Code	Display	Select menu item
Relay/Controller/ USP	rL.		Use of relays
	L1.		Relay 1 menu group
	L2.		Contact function Contact response Enter switching point Enter hysteresis Delay
	Ct.		Controller menu group
	U1		USP: Relay 1
	U2		USP: Relay 2



End:
Press **conf**, then **enter**

Code	Display	Action	Choices
L2.		Select Limit 2 (see Fig. below). Select with ► key. Proceed with enter .	Hi (HI/Lo)
		Limit 2 contact response N/O: normally open contact N/C: normally closed contact Select with ► key. Proceed with enter .	N/O (N/O N/C)
		Limit 2 switching point Select with ►, edit number with ▲, proceed with enter .	100.0 mS (xxxx)
		Limit 2 hysteresis Select with ►, edit number with ▲, proceed with enter .	001.0 mS (xxxx)
		Limit 2 delay The contact is activated with delay (deactivated without delay) Select with ►, edit number with ▲, proceed with enter .	0010 SEC (xxxx SEC)

Limit Lo

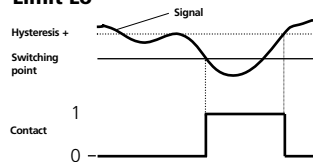

Limit Hi

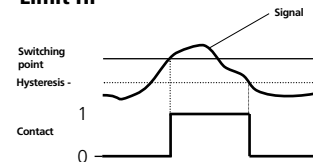

Configuration

Controller (for description see Pg 84)

Setpoint. Neutral zone.

Menu group	Code	Display	Select menu item
Relay/Controller/ USP	rL.		Use of relays
	L1.		Relay 1 menu group
	L2.		Relay 2 menu group
	Ct.		Controller setpoint
			Enter neutral zone
			(P) Controller gain
			(I) Reset time Tr
			(D) Rate time Td
			Pulse length / Pulse frequency
			PLC: Pulse length
			PFC: Pulse frequency
			HOLD behavior
	U1		USP: Relay 1
	U2		USP: Relay 2



End:
Press **conf**, then **enter**

Code	Display	Action	Choices
Ct.		Setpoint Select with ►, edit number with ▲, proceed with enter .	050.0 mS (xxxx)
		Neutral zone (dead band) Select with ►, edit number with ▲, proceed with enter .	001.0 mS (xxxx)
		Controller: Proportional action Select with ►, edit number with ▲, proceed with enter .	0100 % (0010 ... 9999 %)
		Controller: Integral (reset time) Select with ►, edit number with ▲, proceed with enter .	0000 SEC (xxxx SEC)
		Controller: Derivative (rate time) Select with ►, edit number with ▲, proceed with enter .	0000 SEC (xxxx SEC)
		Pulse length /Pulse frequency Select with ► key. Proceed with enter .	PLC (PFC)
		PLC: Pulse length Select with ►, edit number with ▲, proceed with enter .	0010 SEC (0001 ... 0600 SEC)
		PFC: Pulse frequency Select with ►, edit number with ▲, proceed with enter .	0060 /min (0001 ... 0180 /min)
		Behavior during HOLD Select with ► key. Proceed with enter .	Y Last (Y Off/ Y Last)

Configuration

Setting of relays for USP function

Menu group	Code	Display	Select menu item
Relay/Controller/ USP	rL.		Use of relays
	L1.		Relay 1 menu group
	L2.		Relay 2 menu group
	Ct.		Controller menu group
	U1		Enter USP factor
			Contact response relay 1
			Delay relay 1
	U2		Contact response relay 2
			Delay relay 2



End:
Press **conf**, then **enter**

Code	Display	Action	Choices
U1		With USP function selected, relays 1 and 2 are used for USP function (see Pg 94) USP must have been selected as measured variable. For function of relay 1, see Pg 95. Enter reduced USP factor 10 ... 100%	100 % (10 ... 100 %)
		Select: Contact response relay 1 N/O: normally open contact N/C: normally closed contact Select with ► key. Proceed with enter .	N/O (N/O N/C)
		Enter delay. Select with ►, edit number with ▲, proceed with enter .	0000 SEC (xxxxx SEC)
U2		For function of relay 2, see Pg 95. Select contact response N/O: normally open contact N/C: normally closed contact Select with ► key. Proceed with enter .	N/O (N/O N/C)
		Enter delay. Select with ►, edit number with ▲, proceed with enter .	0000 SEC (xxxxx SEC)

Configuration

Control of rinsing probe or Signaling parameter set 2

Menu group	Code	Display	Select menu item
Contact: CLEAN / PSEt2	CIn		Select CLEAN / PSEt2
			Rinsing interval
			Rinse duration
			Contact response

Code	Display	Action (Rinsing probe)	Choices
Cn.		Function selection: • Control of rinsing probe (rinse) • Signaling parameter set 2 active Select with ► key. Proceed with enter .	rinse (rinse / PSEt2) Choices PSEt2: see next page
rinse		Rinsing interval Select with ►, edit number with ▲, proceed with enter .	000.0 h (xxx.x h)
		Rinse duration Select with ►, edit number with ▲, proceed with enter .	0060 SEC (0000 ... 1999 SEC)
		Select contact response N/O: normally open contact N/C: normally closed contact Select with ► key. Proceed with enter .	N/O (N/O N/C)

*) These parameters are only edited in parameter set 1. They are valid for both parameter sets.

Controlling a rinsing probe

The "Clean" contact can be used to connect a simple rinsing probe. Rinse duration and rinsing interval are defined during configuration. Contact response can be set as N/O, N/C.

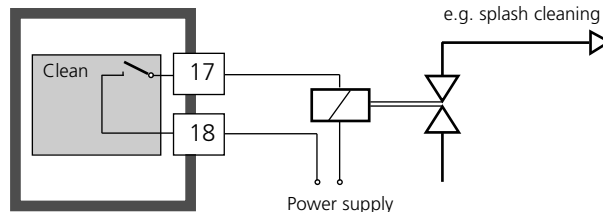

Signaling parameter set 2





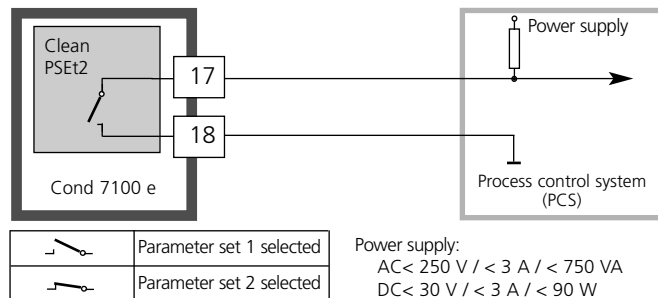



Depending on the selected parameter set, the relay is active or inactive. The signal can be used for superordinated process control systems. Parameter set 2 is indicated by "88" in the upper left corner of the display.

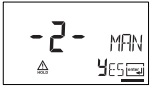

Selecting parameter set 1/2

Manually or via a signal at the Control input

Display	Action	Choices
 <p>After correct input a welcome text (CONF) is displayed for approx. 3 s</p>	<p>Select parameter set</p> <p>Press conf, enter code 7654</p> <p>Select with ▶, edit number with ▲, proceed with enter.</p> <p>Wrong settings change the measurement properties! If an invalid code is entered, the device returns to measuring mode.</p>	
  	<p>Select:</p> <ul style="list-style-type: none"> Parameter set 1 (MAN) Parameter set 2 (MAN) Automatic switchover via Control input (Ctr-XT) <p>Select with ▶ key.</p> <p>Proceed with enter.</p>	<p>-1- (-1- MAN -2-MAN Ctr-EXT)</p> <p>Ctr-EXT: see next page</p>
 	<p>With -1- or -2- selected:</p> <p>Since the complete device configuration is changed in one step, there is a security prompt (No/Yes).</p> <p>Note:</p> <p>When pressing enter directly, the selection is not stored.</p> <p>Activation of parameter set 2 is indicated by "88" in the upper left corner of the display.</p>	

Display	Action	Choices
	<p>With Control input Ctrl-EXT selected:</p> <p>You can switch between the parameter sets by applying an external signal to the Control input see below.</p>	

External switchover of parameter sets

The parameter set can be selected from outside by sending a signal to the Control input (e.g. from the process control system). To do so, **Ctrl-EXT** is set during configuration.

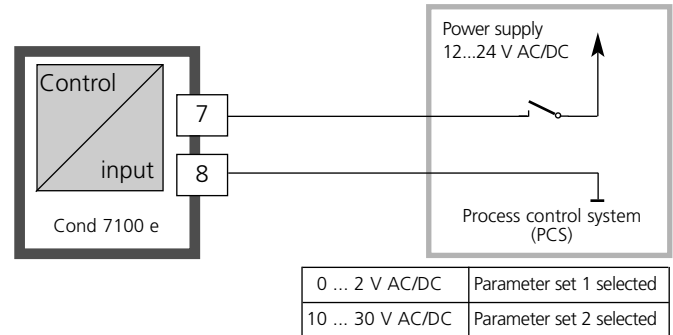

Note:

Parameter set 2 is indicated by "88" in the upper left corner of the display.

Default settings of parameter sets

Two complete parameter sets are stored in the EEPROM. As delivered, the two sets are identical but can be edited.

Note:

Fill in your configuration data on the following pages.

<u>Code.</u>	<u>Parameter</u>	<u>Default setting</u>	<u>Code.</u>	<u>Parameter</u>	<u>Default setting</u>
o1.	Sensor selection *	2-EL	L1.	Contact function	Lo
o1.	Process variable	000.0 mS	L1.	Contact response	N/O
o1.	Conc solution	-01-	L1.	Switching point	000.0 mS
o1.	0/4-20 mA	4-20 mA	L1.	Hysteresis	001.0 mS
o1.	Characteristic	LIN	L1.	Delay	0010 s
o1.	Current start (LIN)	000.0 mS	L2.	Contact function	Hi
o1.	Current end (LIN)	100.0 mS	L2.	Contact response	N/O
o1.	Current start (LOG)	0.1 mS	L2.	Switching point	100.0 mS
o1.	Current end (LOG)	100 mS	L2.	Hysteresis	001.0 mS
o1.	Filter time	0 s	L2.	Delay	0010 s
o1.	22mA signal	OFF	Ct.	Setpoint	050.0 mS
o1.	Hold behavior	Last	Ct.	Neutral zone	001.0 mS
o1.	Fix current	021.0 mA	Ct.	P action	0100 %
o2.	Unit °C / °F	°C	Ct.	I action	0000 s
o2.	Temp probe *	Pt 100	Ct.	D action	0000 s
o2.	0/4...20mA	4-20 mA	Ct.	PLC/PFC controller	PLC
o2.	Current start	000.0 °C	Ct.	Pulse length	0010 s
o2.	Current end	100.0 °C	Ct.	Pulse frequency	0060 /min
o2.	Filter time	0 s	Ct.	Hold behavior	Last
o2.	22mA signal	OFF	U1	USP factor	100 %
o2.	Hold behavior	Last	U1	Contact response	N/O
o2.	Fix current	021.0 mA	U1	Delay	0000 s
tc.	Temp compensation	OFF	U2	Contact response	N/O
tc.	Temp coefficient	02.00%/K	U2	Delay	0000 s
AL.	Sensocheck	OFF	Cn.	Rinse/ PSEt2 *	rinse
AL.	Alarm delay	0010 s	Cn.	Rinsing interval *	000.0 h
AL.	LED Hold	OFF	Cn.	Rinse duration *	0060 s
			Cn.	Contact type *	N/O

Parameter set - user settings







METTLER TOLEDO

Code. Parameter	Setting	
	P1 (conf 1200)	P2 (conf 1288)
o1. Sensor *	_____	*
o1. Process variable	_____	_____
o1. Solution (Conc)	_____	_____
o1. 0/4-20 mA	_____	_____
o1. Characteristic (LIN/LOG)	_____	_____
o1. Current start (LIN)	_____	_____
o1. Current end (LIN)	_____	_____
o1. Current start (LOG)	_____	_____
o1. Current end (LOG)	_____	_____
o1. Filter time	_____	_____
o1. 22mA signal	_____	_____
o1. Hold behavior	_____	_____
o1. Fix current	_____	_____
o2. Unit °C / °F	_____	_____
o2. Temp probe *	_____	*
o2. 0/4...20mA	_____	_____
o2. Current start	_____	_____
o2. Current end	_____	_____
o2. Filter time	_____	_____
o2. 22mA signal	_____	_____
o2. Hold behavior	_____	_____
o2. Fix current	_____	_____
tc. Temp compensation	_____	_____
tc. Temp coefficient	_____	_____
AL. Sensocheck	_____	_____
AL. Alarm delay	_____	_____
AL. LED Hold	_____	_____

Code. Parameter	Setting	
	P1 (conf 1200)	P2 (conf 1288)
rL. Relay function	_____	_____
L1. Contact function	_____	_____
L1. Contact response	_____	_____
L1. Switching point	_____	_____
L1. Hysteresis	_____	_____
L1. Delay	_____	_____
L2. Contact function	_____	_____
L2. Contact response	_____	_____
L2. Switching point	_____	_____
L2. Hysteresis	_____	_____
L2. Delay	_____	_____
Ct. Setpoint	_____	_____
Ct. Neutral zone	_____	_____
Ct. P action	_____	_____
Ct. I action	_____	_____
Ct. D action	_____	_____
Ct. PLC/PFC controller	_____	_____
Ct. Pulse length	_____	_____
Ct. Pulse frequency	_____	_____
Ct. Hold behavior	_____	_____
U1 USP factor	_____	_____
U1 Contact response	_____	_____
U1 Delay	_____	_____
U2 Contact response	_____	_____
U2 Delay	_____	_____
Cn Rinse / PSEt2 *	_____	*
Cn Rinsing interval *	_____	*
Cn Rinse duration *	_____	*
Cn Contact response *	_____	*

Calibration

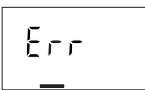
Calibration adjusts the device to the sensor.

Activate		Activate with cal
		<p>Enter mode code:</p> <ul style="list-style-type: none"> • Input of cell constant 1100 • With calibration solution 0110 • Product calibration 1105 • Temp probe adjustment 1015 <p>Select with ▶, edit number with ▲, proceed with enter. (End with cal enter.)</p>
Hold	  HOLD icon	<p>Output current is frozen (last value or preset fixed value, depending on configuration), limit and alarm contacts are inactive. The controller is in the configured state, Sensoface is off, "Calibration" mode indicator is on.</p>
Input errors		<p>The calibration parameters are checked during the input. In the case of an incorrect input "Err" is displayed for approx. 3 s. The incorrect parameters cannot be stored. Input must be repeated.</p>
End	 	<p>End with cal. The measured value and Hold are displayed alternately, "enter" flashes. Press enter to end the Hold mode. The measured value is displayed. The output current remains frozen for another 20 s (HOLD icon on, "hourglass" flashes).</p>

Information on calibration

Calibration adapts the Transmitter to the conductivity sensor.







Calibration can be performed by:

- Input of cell constant (e.g. for ultrapure-water sensors)
- Determining the cell constant with a known calibration solution
- Sampling (product calibration)
- Temperature probe adjustment

Note:





- All calibration procedures must be performed by trained personnel.
- Incorrectly set parameters may go unnoticed, but change the measuring properties.



Input of cell constant with simultaneous display of conductivity and temperature

Display	Action	Remark
	Press cal key, enter code 1100 Select with ▶ , edit number with ▲ , proceed with enter .	Transmitter is in Hold mode. If an invalid code is entered, the Transmitter returns to measuring mode.
	Ready for calibration	Display (3 s)
   	Enter cell constant of connected sensor: Select with ▶ , edit number with ▲ , proceed with enter . A change in the cell constant also changes the conductivity value. Press enter to confirm cell constant.	The lower display shows the conductivity value. (When there has not been an entry for 6 sec, the lower display alternately shows the conductivity and temperature value.)

Display	Action	Remark
	The Transmitter now displays the conductivity and temperature.	
	The measured value is shown in the main display alternately with "Hold". "enter" flashes. End calibration with enter .	After end of calibration, the outputs remain in Hold mode for approx. 20 sec.

Input of temperature-corrected value of calibration solution with simultaneous display of cell constant

Display	Action	Remark
	Press cal key, enter code 0110 Select with ▶ , edit number with ▲ , proceed with enter .	Transmitter is in Hold mode. If an invalid code is entered, the Transmitter returns to measuring mode.
	Ready for calibration Dismount and clean sensor	Display (3 s)
	Immerse sensor in calibration solution. Determine the temperature-corrected conductivity value of the calibration solution from the corresponding table (see Pg 110 and the following).	When there has not been an entry for 6 sec, the lower display alternately shows the cell constant and temperature value.
 	Enter value of calibration solution. Select with ▶ , edit number with ▲ , proceed with enter . Press enter to confirm the calibration data.	The cell constant and temperature are alternately displayed in lower display during the input.

Display	Action	Remark
	The determined cell constant is displayed. Confirm with enter .	
	The Transmitter now displays the conductivity and temperature.	
	Clean sensor and re-place it in the process. The measured value is shown in the main display alternately with "Hold". "enter" flashes. End calibration with enter .	After end of calibration, the outputs remain in Hold mode for approx. 20 sec.

Notes:

- Be sure to use known calibration solutions and the respective temperature-corrected conductivity values. (see "Calibration solutions" Pg. 110 and the following).
- During the calibration procedure the temperature must be kept constant.

Product calibration

Calibration by sampling



For product calibration the measured variable is used as configured: Conductivity ($\mu\text{S}/\text{cm}$, mS/cm , S/m), resistivity ($\text{M}\Omega\cdot\text{cm}$). During product calibration the sensor remains in the process. The measurement is only interrupted briefly.





Calibration is without TC correction.

Procedure: During sampling the currently measured value is stored in the Transmitter. The Transmitter immediately returns to measuring mode. The calibration mode indicator flashes and reminds you that calibration has not been terminated.



The sample is measured in the lab or directly on the site using a portable meter. The lab value is then entered in the Transmitter. The new cell constant is calculated from these two values.

If the sample is invalid, you can take over the value stored during sampling. In that case the old calibration values are stored. Afterwards, you can start a new product calibration.

Display	Action	Remark
	Product calibration 1st step: Press cal key, enter code 1105. (Select position with ▶ key, edit number with ▲ key, proceed with enter key.)	If an invalid code is entered, the Transmitter returns to measuring mode.
		Display (approx. 3 sec)
	Take sample and store value. Proceed with enter	The sample is measured in the lab or directly on the site.

Display	Action	Remark
	Measuring mode: From the flashing CAL mode indicator you see that sample calibration has not been terminated.	While the sample value is determined, the Transmitter is in measuring mode.
	Product calibration 2nd step: When the sample value has been determined, call up the product calibration once more (cal , code 1105).	Display (approx. 3 sec)
	Enter lab value. The new cell constant is calculated.	
	The new cell constant is displayed. Confirm with enter .	New calibration: Press cal .
	The measured value is shown in the main display alternately with "Hold". "enter" flashes. End with enter .	After end of calibration, the outputs remain in Hold mode for approx. 20 sec.





Temperature probe adjustment

Display	Action	Remark
	<p>Activate calibration (Press cal, enter 1015)</p> <p>Select position with ► key, edit number with ▲ key, proceed with enter key.</p>	<p>Wrong settings change the measurement properties!</p> <p>If an invalid code is entered, the Transmitter returns to measuring mode.</p>
	Ready for calibration	Transmitter is in Hold mode (Display for approx. 3 sec)
	<p>Measure the temperature of the process medium using an external thermometer. Enter measured temperature value:</p> <p>Select with ► key, edit number with ▲ key, proceed with enter key.</p> <p>End adjustment with enter. HOLD will be deactivated after 20 sec.</p>	<p>Default:</p> <p>Current value of secondary display.</p>

Measurement

Display	Remark
	<p>In the measuring mode the main display shows the configured process variable (conductivity, resistivity, salinity), the lower display shows the temperature.</p> <p>During calibration you can return to measuring mode by pressing the cal key, during configuration by pressing conf (waiting time for measured-value stabilization approx. 20 sec).</p>

Diagnostics functions

Display	Remark
	<p>Display of output currents</p> <p>Press enter while in measuring mode.</p> <p>The current at output 1 is shown in the main display, the current at output 2 in the secondary display.</p> <p>After 5 sec the Transmitter returns to measuring mode.</p>
	<p>Display of calibration data (Cal Info)</p> <p>Press cal while in measuring mode and confirm code 0000. The current cell constant is shown in the main display. After 20 sec the Transmitter returns to measuring mode (immediate return at pressing enter).</p>
	<p>Sensor monitor</p> <p>for validation of sensor and complete measured-value processing. Press conf while in measuring mode and enter code 2222. The measured resistance is shown in the main display, the measuring temperature in the lower display.</p> <p>Press enter to return to measurement.</p>
	<p>Display of last error message (Error Info)</p> <p>Press conf while in measuring mode and confirm code 0000. The last error message is displayed for approx. 20 sec. After that the message will be deleted. (immediate return to measurement at pressing enter).</p>

Diagnosics functions

These functions are used for testing the connected peripherals.

Display	Action / Remarks
	<p>Specify current for output 1 (current source 1)</p> <ul style="list-style-type: none"> Press conf, enter code 5555 <p>The current indicated in the main display for output 1 can be edited.</p>
	<p>Select with ▶ key, edit number with ▲ key, proceed with enter key.</p> <p>The actually measured current is shown in the secondary display. The Transmitter is in Hold mode.</p> <p>Press conf, then enter to return to measurement (Hold remains active for another 20 sec).</p>
	<p>Specify current for output 2 (current source 2)</p> <ul style="list-style-type: none"> Press conf, enter code 5556 <p>The current indicated in the main display for output 2 can be edited.</p>
	<p>Select with ▶, edit number with ▲, proceed with enter. The actually measured current is shown in the secondary display. The Transmitter is in Hold mode. Press conf, then enter to return to measurement (Hold remains active for another 20 sec).</p>
	<p>Relay test (manual test of contacts)</p> <ul style="list-style-type: none"> Press conf, enter code 5557 <p>The relays are frozen. This state is indicated in the display. The 4 digits in the display correspond to the 4 relays (as on terminal plate):</p>
	<ol style="list-style-type: none"> Digit: R1 Digit: R2 Digit: AL Digit: CLN
<p>Select a relay</p>	
<p>Test 0/1</p>	
<p>Return to measurement</p>	
	<p>Function test using arrow keys – see left column.</p> <p>When exiting the function (enter), the relays are set corresponding to the measured value.</p>

Display	Action / Remarks
	<p>Controller test (manual specification of controller output)</p> <ul style="list-style-type: none"> Press conf, enter code 5559
	<p>After function activation "Ctrl" is displayed for approx. 3 sec. With controller turned off, "OFF" is displayed in addition, then return to measuring mode.</p>
<p>Controller characteristic</p>	<p>The function is used to start up control loops or check the actuators.</p> <p>For bumpless changeover to automatic operation (exiting this function), configure an I-action component (reset time).</p>
<p>The arrows indicate which relay (valve) is active:</p> <ul style="list-style-type: none"> ➤ Relay 2 active (Meas. value > setpoint) ➤ Relay 1 active (Meas. value < setpoint) 	<p>Specify value:</p> <p>Select with ▶, edit number with ▲, proceed with enter.</p>
	<p>The Transmitter is in Hold mode.</p> <p>Press enter to return to measurement (Hold remains active for another 20 sec).</p>
	<p>Controller output -100 to 0 %: Relay 2 active</p> <p>Controller output 0 to +100 %: Relay 1 active</p>
	<p>Momentary controller output (adjusted value has not been stored yet)</p>

PID controller

P controller

Application in integrating systems
(e.g. closed tanks, batch processes).

PI controller

Application in non-integrating systems
(e.g. drains).

PID controller

The additional derivative action compensates for measurement peaks.

Controller characteristic

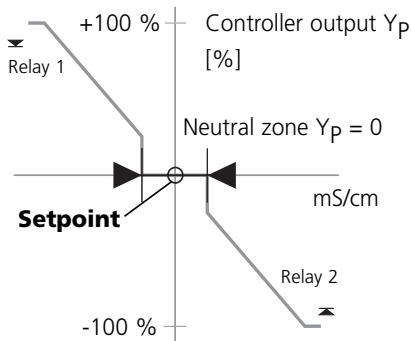

Controller equations

$$\text{Controller output } Y = Y_P + \frac{1}{T_R} \int Y_P dt + T_D \frac{dY_P}{dt}$$

P action I action D action

Proportional action Y_P

with:
 Y_P Proportional action
 T_R Reset time [s]
 T_D Rate time [s]
 K_C Controller gain [%]

$$Y_P = \frac{\text{Setpoint} - \text{Meas. value}}{\text{Meas. range}} * K_C$$

Neutral zone (Y=0)

Tolerated deviation from setpoint.
With the setting "1mS/cm" a deviation of ± 0.5 mS/cm from the desired value does not activate the controller.

Proportional action (Gradient K_C [%])

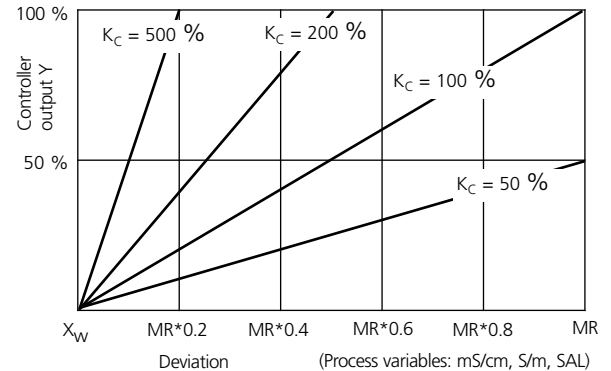

Pulse length / pulse frequency controller

Pulse length controller (PLC)

The pulse length controller is used to operate a valve as an actuator. It switches the contact on for a time that depends on the controller output. The period is constant. A minimum ON time of 0.5 sec is maintained even if the controller output takes corresponding values.

Output signal (switching contact) of pulse length controller

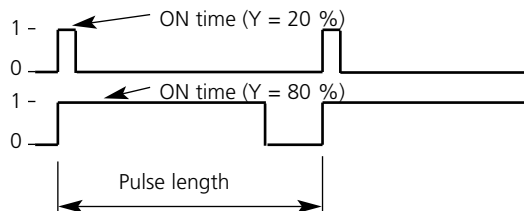



Pulse frequency controller (PFC)





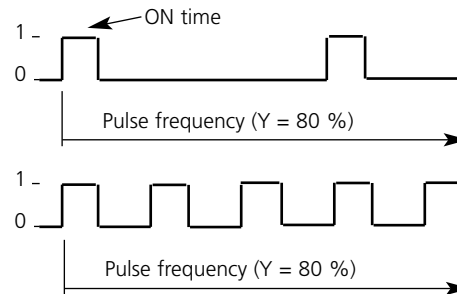







The pulse frequency controller is used to operate a frequency-controlled actuator (metering pump). It varies the frequency with which the contacts are switched on. The maximum pulse frequency [pulses/min] can be defined. It depends on the actuator.

The Contact ON time is constant. It is automatically calculated from the user-defined maximum pulse frequency.

Output signal (switching contact) of pulse frequency controller



Errors	Display	Problem Possible causes	Alarm contact	Red LED	Out 1 (22mA)	Out 2 (22mA)
ERR 01	Measured value flashes	Sensor <ul style="list-style-type: none"> • Wrong cell constant • Measurement range violation • SAL > 45 ‰ • Sensor connection or cable defective 	x	x	x	
ERR 02	Measured value flashes	Unsuitable sensor Conductance range > 3500 mS	x	x	x	
ERR 98	“Conf” flashes	System error Configuration or calibration data defective. Completely reconfigure and recalibrate the device. Memory error in device program	x	x	x	x
ERR 99	“FAIL” flashes	Factory settings EEPROM or RAM defective This error message only occurs in the case of a complete defect. The Transmitter must be repaired and recalibrated at the factory.	x	x	x	x
ERR 03		Temperature probe Open or short circuit Temperature range exceeded	x	x	x	x

Errors	Symbol (flashes)	Problem Possible causes	Alarm contact	Red LED	Out 1 (22mA)	Out 2 (22mA)	
ERR 11		Current output 1 Current below 0 (3.8) mA	x	x	x		
ERR 12		Current output 1 Current above 20.5 mA	x	x	x		
ERR 13		Current output 1 Current span too small / too large	x	x	x		
ERR 21	 	Current output 2 Current below 0 (3.8) mA	x	x		x	
ERR 22	 	Current output 2 Current above 20.5 mA	x	x		x	
ERR 23	 	Current output 2 Current span too small / too large	x	x		x	
ERR 33		Sensocheck: Wrong or defective sensor / Polarization effects at the sensor / cable too long or defective / plug defective	x	x	x		
		 <ul style="list-style-type: none"> • Temperature outside conversion tables (TC, Conc, SAL) 	Sensoface active s. Pg 92				
			Sensoface active s. Pg 92				

Operating state	Out 1	Out 2	Rel. 1/2 Controller	Rel. 1/2 Limit value	Cleaning contact	Alarm contact	LED	Time out
Measurement	■	■	■	■	■	■	■	
Cal Info (cal) 0000	■	■	■	■	■	■	■	20 s
Error Info (conf) 0000	■	■	■	■	■	■	■	20 s
Calibration (cal) 1100	■	■	■					
Calibration (cal) 0110	■	■	■					
Temp adjustment (cal) 1015	■	■	■					
Product cal 1 (cal) 1105	■	■	■	■	■	■	■	
Product cal 2 (cal) 1105	■	■	■					
Conf par set 1 (conf) 1200	■	■	■					20 min
Conf par set 2 (conf) 1288	■	■	■					20 min
Parameter set 1/2 (conf) 7654	■	■	■					20 min

Operating state	Out 1	Out 2	Rel. 1/2 Controller	Rel. 1/2 Limit value	Cleaning contact	Alarm contact	LED	Time out
Sensor monitor (conf) 2222	■	■	■					20 min
Current source 1 (conf) 5555	■	■	■					20 min
Current source 2 (conf) 5556	■	■	■					20 min
Relay test (conf) 5557	■	■	■					20 min
Manual controller (conf) 5559	■	■	■					20 min
Cleaning function	■	■	■		■			
HOLD input	■	■	■					

Explanation:

- active
- as configured (Last/Fix or Last/Off)

The little smiley in the display (Sensoface) provides information about the sensor condition (defects, maintenance required, cable capacitance too high).

It alerts to significant sensor polarization or excessive cable capacitance e.g. caused by an unsuitable cable or a cable that is too long. The permitted calibration ranges and the conditions for a friendly, neutral, or sad Sensoface are summarized in the following chart. Additional icons refer to the error cause.





Sensocheck

Continuously monitors the sensor and its wiring. Sensocheck can be switched off. Critical values make the Sensoface “sad” and the corresponding icon flashes: 

The Sensocheck message is also output as error message Err 33. The alarm contact is active, the red LED is lighted, output current 1 is set to 22 mA (when configured correspondingly). Sensocheck can be switched off during configuration (then Sensoface is also disabled). Exception: After a calibration a Smiley is always displayed for confirmation.

Note

The worsening of a Sensoface criterion leads to the devaluation of the Sensoface indicator (Smiley becomes “sad”). To reset the Sensoface indicator, the defect must be remedied and the Transmitter be calibrated.

Display	Problem	Status
	Sensor defect	 Wrong or defective sensor Significant polarization of sensor Excessive cable capacitance (also see error message Err 33, Pg 89).
 	Temperature error	 Temperature outside range for TC, conc, SAL

Note:

When very fast response times (t_{90}) are required, e.g. when detecting separation layers, Sensocheck should be switched off (see “Specifications” Pg 98).

According to the "USP" directive (U.S. Pharmacopeia), Section 645 "Water Conductivity", the conductivity of pharmaceutical waters can be monitored online. To do so, the conductivity is measured without temperature compensation and is compared with limit values (see "Temperature/conductivity table as per USP" on Pg 95).

The water is usable if the conductivity is below the USP limit. For higher conductivities, further test steps must be performed according to the directive.

To increase safety the USP limit value can be reduced in the Transmitter. To do so, a factor (%) is entered.

Configuration steps

- out1** menu group:
 - When USP function has been selected, the measurement range is fixed to 00.00 ... 99.99 $\mu\text{S}/\text{cm}$. Temperature compensation is switched off. Temperature is monitored (see Pg 35).
- In the **rl.** menu group select USP as limit function. Relays 1 and 2 can now be used as USP limit contacts (see Pg 57).
- Reduced limit contact **U1** (Relay 1):
 - Enter USP factor (reduced limit, configurable in the range 10 % ... 100 %)
 - Set contact response for relay 1.
 - Set delay time (see Pg 63).
- Limit contact **U2**
 - Set contact response for relay 2.
 - Set delay time (see Pg 63).

Temperature/conductivity table as per USP

Temp in °C	Conductivity in $\mu\text{S}/\text{cm}$	Temp in °C	Conductivity in $\mu\text{S}/\text{cm}$
0	0.6	55	2.1
5	0.8	60	2.2
10	0.9	65	2.4
15	1.0	70	2.5
20	1.1	75	2.7
25	1.3	80	2.7
30	1.4	85	2.7
35	1.5	90	2.7
40	1.7	95	2.9
45	1.8	100	3.1
50	1.9		

Limits for USP function

Limit contact response U1 (Relay 1) and U2 (Relay 2)

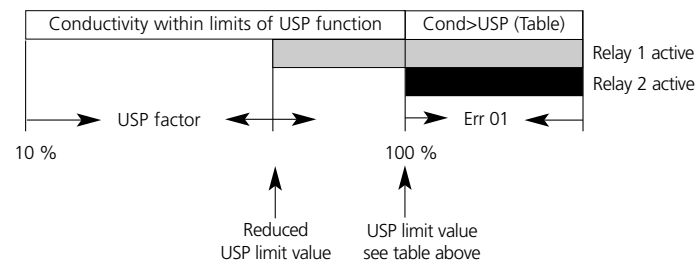

Product line and accessories

Devices	Order No.
Transmitter Cond 7100 e	52 121 126
Mounting accessories	
Pipe-mount kit	52 120 741
Panel-mount kit	52 120 740
Protective hood	52 120 739

Sensors

Mettler-Toledo GmbH, Process Analytics offers a wide range of 2-electrode and 4-electrode sensors for the following fields of applications:

- Chemical process industry
- Pharmaceutical industry
- Food and beverage industry
- Water/waste-water

For more information concerning our sensors and housings program, please refer to <http://www.mt.com>.

Conductivity input

Meas. range	Input for 2-electrode/4-electrode sensors	Conductivity	0.2 $\mu\text{S} \cdot \text{cm}$ to 1000 $\text{mS} \cdot \text{cm}$
Ranges ¹⁾		Conductivity	0.000 ... 9.999 $\mu\text{S}/\text{cm}$ 00.00 ... 99.99 $\mu\text{S}/\text{cm}$ 000.0 ... 999.9 $\mu\text{S}/\text{cm}$ 0000 ... 9999 $\mu\text{S}/\text{cm}$ 0.000 ... 9.999 mS/cm 00.00 ... 99.99 mS/cm 000.00 ... 999.9 mS/cm
			0.000 ... 9.999 S/m 00.00 ... 99.99 S/m
		Resistivity	00.00 ... 99.99 $\text{M}\Omega \cdot \text{cm}$
		Concentration	0.00 ... 9.99 % by wt
		Salinity	0.0 ... 45 ‰ (0 ... 35 °C)
Response time (T_{90})			< 1 s (Sensocheck off) < 3 s (Sensocheck on)
Measurement error ^{1,2,3)}			< 1 % meas. val. +0.4 $\mu\text{S} \cdot \text{cm}$

Concentration determination

Operating modes ¹⁾

- 01-** NaCl 0.00 ... 9.99% by wt (0 ... 60°C)
 - 02-** HCl 0.00 ... 9.99% by wt (-20 ... 50°C)
 - 03-** NaOH 0.00 ... 9.99% by wt (0 ... 100°C)
 - 04-** H₂SO₄ 0.00 ... 9.99% by wt (-17 ... 110°C)
 - 05-** HNO₃ 0.00 ... 9.99% by wt (-17 ... 50°C)
- See graphs on Pg 112 and the following.

Sensor standardization

Operating modes

- Input of cell constant with simultaneous display of conductivity and temperature
- Input of conductivity of calibration solution with simultaneous display of cell constant and temperature
- Product calibration
- Temperature probe adjustment

Adm. cell constant 00.0050 ... 19.9999 cm^{-1}

Sensor monitoring

Sensocheck Polarization detection and monitoring of cable capacitance

Sensoface

Provides information on the sensor condition (Sensocheck)

Sensor monitor

Direct display of measured values from sensor for validation (resistance / temperature)

USP function

Water monitoring in the pharmaceutical industry (USP) with possibility to enter a limit value (%)
Output via relay contact

Temperature input ¹⁾

	Pt100 / Pt1000/ NTC 30 k Ω / NTC 8.55 k Ω (Betatherm)
	2-wire connection, adjustable
Ranges	Pt100 / Pt1000: -20 ... +200 °C (-4 ... +392 °F)
	NTC 30 k Ω -20 ... +150 °C (-4 ... +302 °F)
	NTC 8.55 k Ω -10 ... +130 °C (+14 ... +266 °F)

Resolution	0.1 °C / 1 °F
Measurement error ^{1,2,3)}	0.5 K (<1 K for Pt100; <1 K for NTC >100 °C)

Temperature compensation ¹⁾

(Reference temp 25 °C)

- (OFF)** none
- (Lin)** Linear characteristic 00.00 ... 19.99%/K
- (NLF)** Natural waters to EN 27888
- (nACL)** Ultrapure water with NaCl traces (0 ... 120°C)
- (HCL)** Ultrapure water with HCl traces (0...120°C)
- (nH3)** Ultrapure water with NH₃ traces (0...120°C)

HOLD input	Galv. separated (OPTO coupler)
Function	Switches device to HOLD mode
Switching voltage	0 ... 2 V (AC/DC) inactive 10 ... 30 V (AC/DC) active
CONTROL input	Galv. separated (OPTO coupler)
Function	Switch-over to second parameter set
Switching voltage	0 ... 2 V (AC/DC) Parameter set 1 10 ... 30 V (AC/DC) Parameter set 2
Output 1	0/4 ... 20 mA, max. 10 V, floating (galv. connected to output 2)
Measured variable ^{*)}	Conductivity, resistivity, concentration, or salinity
Characteristic	Linear or logarithmic
Overrange ^{*)}	22 mA in the case of error messages
Output filter ^{*)}	Low-pass, filter time constant 0 ... 120 s
Measurement error ^{*)}	< 0.3 % current value + 0.05 mA
Start/end of scale	As desired within range
Min. span	LIN: 5 % of selected range LOG: 1 decade
Output 2	0/4 ... 20 mA, max. 10 V, floating (galv. connected to output 1)
Process variable	Temperature
Overrange ^{*)}	22 mA in the case of temp error messages
Output filter ^{*)}	Low-pass, filter time constant 0 ... 120 s
Meas. error ^{*)}	< 0.3 % current value + 0.05 mA
Start/end of scale ^{*)}	-20 to 200 °C / -4 ... 392 °F
Adm. span	20 ... 320 K (36 to 608 °F)
Alarm contact	Relay contact, floating
Contact ratings	AC < 250 V / < 3 A / < 750 VA DC < 30 V / < 3 A / < 90 W
Contact response	N/C (fail-safe type)
Alarm delay	0000 ... 0600 s

Limit values	Output via relay contacts R1, R2 (see PID process controller)
Contact ratings	Contacts R1, R2 floating but inter-connected AC < 250 V / < 3 A / < 750 VA DC < 30 V / < 3 A / < 90 W
Contact response ^{*)}	N/O or N/C
Delay ^{*)}	0000 ... 9999 s
Switching points ^{*)}	As desired within range
Hysteresis ^{*)}	0 ... 50 % full scale
PID process controller	Output via relay contacts R1, R2 (see limit values)
Setpoint ^{*)}	As desired within range
Neutral zone ^{*)}	As desired within range
Proportional action ^{*)}	Controller gain K_C : 0010 ... 9999 %
Integral action ^{*)}	Reset time T_R : 0000 ... 9999 s (0000 s = no integral action)
Derivative action ^{*)}	Rate time T_D : 0000 ... 9999 s (0000 s = no derivative action)
Controller type ^{*)}	Pulse length or pulse frequency controller
Pulse period ^{*)}	0001 ... 0600 s, min. ON time 0.5 s (pulse length controller)
Max. pulse frequency ^{*)}	0001 ... 0180 min ⁻¹ (pulse frequency controller)

Cleaning function / Parameter set 2 ^{*)}

Clean / PSEt2	Relay contact, floating, for controlling a rinsing probe or signaling that 2nd parameter set is active
Contact ratings	AC < 250 V / < 3 A / < 750 VA DC < 30 V / < 3 A / < 90 W
Contact response	N/O when signaling parameter set 2 N/O or N/C when used as cleaning contact ^{*)}
Rinsing interval ^{*)}	000.0 ... 999.9 h (000.0 h = cleaning function switched off)
Rinse duration ^{*)}	0000 ... 1999 s

Display	LC display, 7-segment with icons
Main display	Character height 17 mm, unit symbols 10 mm
Secondary display	Character height 10 mm, unit symbols 7 mm
Sensoface	3 status indicators (friendly, neutral, sad Sensoface)
Mode indicators	5 status bars "meas", "cal", "alarm", "cleaning", "config"
	18 further icons for configuration and messages
Alarm indication	Red LED in case of alarm or HOLD, user defined
Keypad	5 keys: [cal] [conf] [▶] [▲] [enter]
Service functions	
Current source	Current specifiable for output 1 and 2 (00.00 to 22.00mA)
Manual controller	Controller output entered directly (start of control process)
Device self-test	Automatic memory test (RAM, FLASH, EEPROM)
Display test	Display of all segments
Last Error	Display of last error occurred
Sensor monitor	Display of direct sensor signal (resistance/temperature)
Relay test	Manual control of the four switching contacts
Parameter sets *)	Two selectable parameter sets for different process phases Switchover via CONTROL input or manually Signaling via relay contact PSet2
Data retention	Parameters and calibration data > 10 years (EEPROM)

Protection against electrical shock Protective separation of all extra-low-voltage circuits against mains by double insulation as per EN 61010-1

Power supply 24 (-15%) to 230 V AC/DC (+10%); approx. 5 VA, 2.5 W
AC: 45 to 65 Hz; Overvoltage category II, Class II

Nominal operating conditions

Ambient temperature -20 to +55 °C
Transport/Storage temp -20 to +70 °C
Relative humidity 10 to 95 % not condensing
Power supply 24 (-15%) to 230 V AC/DC (+10%)
Frequency for AC 45 to 65 Hz

EMC EN 61326
Emitted interference Class B (residential environment)
Class A for mains supply > 60 V DC

Immunity to interference Industrial environment

Explosion protection

FM: NI Class I Div 2 Group A, B, C & D, T4 Ta = 55 °C; Type 2
NI Class I Zone 2 Group IIC, T4 Ta = 55°C; Type 2

CSA: Class I Div 2 Groups A, B, C and D, T4
Ex nA IIC T4

Enclosure Molded enclosure made of PBT (polybutylene terephthalate)
Color Bluish gray RAL 7031
Assembly • Wall mounting

• Pipe mounting: dia 40 to 60 mm, □ 30 to 45 mm
• Panel mounting, cutout to DIN 43 700
Sealed against panel

Dimensions H 144 mm, B 144 mm, T 105 mm

Ingress protection IP 65 / NEMA 4X

Cable glands 3 breakthroughs for cable glands M20x1.5

2 breakthroughs for NPT 1/2 " or Rigid Metallic Conduit

Weight Approx. 1 kg

*) User-defined

1) To IEC 746 Part 1, at nominal operating conditions

2) ± 1 count

3) Plus sensor error

Hazardous Location

Class I Division 2, Groups A, B, C, D T4
 Ex nA IIC T4 CSA 02.1342049X
 Enclosure Type 2, Tamb = - 20 °C to + 55 °C
 Installation category II, pollution degree 2

pH/ORP measuring circuit or
 CO₂ measuring circuit
 (Terminals KL. 1, 2, 3, KL. C)

maximum values: $V_{oc} = 10 \text{ V}$ $C_a = 20 \mu\text{F}$
 $I_{sc} = 12 \text{ mA}$ $L_a = 1 \text{ H}$
 $P_o = 15 \text{ mW}$

DF supply circuit
 (Terminals KL. 3, 4, 5)

maximum values: $V_{oc} = 10 \text{ V}$ $C_a = 20 \mu\text{F}$
 $I_{sc} = 14 \text{ mA}$ $L_a = 1 \text{ H}$
 $P_o = 35 \text{ mW}$

or DO measuring circuit or
 DO measuring circuit (trace elements)
 (Terminals KL. 1, 2, 3, 4, 5, KL. C)

maximum values: $V_{oc} = 10 \text{ V}$ $C_a = 20 \mu\text{F}$
 $I_{sc} = 17 \text{ mA}$ $L_a = 1 \text{ H}$
 $P_o = 22 \text{ mW}$

or Cond measuring circuit
 (Terminals KL. 1, 2, 3, 4, 5)

maximum values: $V_{oc} = 10 \text{ V}$ $C_a = 20 \mu\text{F}$
 $I_{sc} = 112 \text{ mA}$ $L_a = 8 \text{ mH}$
 $P_o = 14.0 \text{ mW}$

or CondI measuring circuit
 (Terminals KL. 1, 2, 3, 4, 5)

maximum values: $V_{oc} = 7.1 \text{ V}$ $C_a = 100 \mu\text{F}$
 $I_{sc} = 72 \text{ mA}$ $L_a = 20 \text{ mH}$
 $P_o = 128 \text{ mW}$

Temp measuring circuit
 (Terminals KL. D, KL. E)

maximum values: $V_{oc} = 5 \text{ V}$ $C_a = 1000 \mu\text{F}$
 $I_{sc} = 10 \text{ mA}$ $L_a = 1 \text{ H}$
 $P_o = 13 \text{ mW}$

OK inputs HOLD, CONTROL
 (Terminals KL. 6, 7 and 8, 7)

maximum values: $V_{max} = 30 \text{ V}$ $C_1 = 0$
 $I_{max} = \text{no limitation}$ $L_1 = 0$

TERMINALS 1, 2, 3, 4, 5, C, D, E:
 NON-INCENDIVE FIELD WIRING CONNECTIONS FOR CLASS I, DIVISION 2, GROUPS A, B, C, D
 THIS EQUIPMENT IS SUITABLE FOR USE IN CLASS I, DIVISION 2, GROUPS A, B, C, D
 OR NON-HAZARDOUS LOCATIONS ONLY

WARNING - EXPLOSION HAZARD - SUBSTITUTION OF COMPONENTS MAY
 IMPAIR SUITABILITY FOR CLASS I, DIVISION 2

AVERTISSEMENT - RISQUE D'EXPLOSION - LA SUBSTITUTION DE COMPOSANTS
 PEUT RENDRE CE MATERIEL INACCEPTABLE POUR LES EMPLACEMENTS DE
 CLASSE I, DIVISION 2

WARNING - EXPLOSION HAZARD - DO NOT DISCONNECT EQUIPMENT UNLESS POWER
 HAS BEEN SWITCHED OFF OR THE AREA IS KNOWN TO BE NON-HAZARDOUS

AVERTISSEMENT - RISQUE D'EXPLOSION - AVANT DE DECONNECTER L'EQUIPEMENT,
 COUPER LE COURANT OU S'ASSURER QUE L'EMPLACEMENT EST DESIGNÉ NON DANGEREUX.

WARNING - CLEAN ONLY WITH A MOISTENED ANTISTATIC CLOTH AS POTENTIAL ELECTROSTATIC HAZARD
 MAY EXIST. SERVICE EQUIPMENT ONLY WITH CONDUCTIVE CLOTHING, FOOTWEAR AND
 PERSONAL GROUNDING DEVICES TO PREVENT ELECTROSTATIC ACCUMULATION.

WARNING - INTERNAL GROUNDING PROVISIONS SHALL BE PROVIDED FOR FIELD WIRING.
 BONDING BETWEEN CONDUIT SHALL BE PROVIDED DURING INSTALLATION, AND ALL EXPOSED
 NON-CURRENT CARRYING METALLIC PARTS SHALL BE BONDED AND GROUNDING.

THE EQUIPMENT SHALL BE INSTALLED AND PROTECTED FROM MECHANICAL IMPACT AND ULTRAVIOLET (UV) SOURCES.

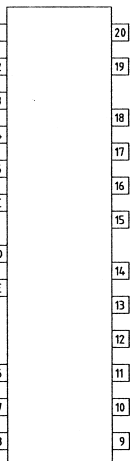

Transmitter 2100 e, 4100 e, 4100 ppb, 5100 e, 7100 e

pH 2100 e one pH/ORP input with DF supply circuit
 CO₂ 5100 e one CO₂ input
 O₂ 4100 e one DO input
 O₂ 4100 ppb one DO input (measurement of trace elements)
 Cond 7100 e one Conductivity input for 2-/-4-electrode sensors
 Cond Ind 7100 e one Conductivity input for electrodeless conductivity sensors

Power supply circuit
 (Terminals KL. 19, 20)
 24 to 230 V AC/DC -15% / +10%
 45 to 65 Hz

Switching circuits
 ALARM and CLEAN
 (Terminals KL. 15, 16 and 17, 18)
 maximum values:
 AC: < 250 V / < 3 A / < 750 VA / resistive load
 DC: < 30 V / < 3 A / < 90 W / resistive load

Switching circuits
 REL. 1 and REL. 2
 (Terminals KL. 12, 13 and 14, 13)
 maximum values:
 AC: < 250 V / < 3 A / < 750 VA / resistive load
 DC: < 30 V / < 3 A / < 90 W / resistive load

Output circuits
 OUT 1 and OUT 2
 (Terminals KL. 9, 10 and 11, 10)
 maximum values:
 $V_{oc} = 10 \text{ V}$ $C_a = 10 \mu\text{F}$
 $I_{sc} = 22 \text{ mA}$ $L_a = 100 \text{ mH}$
 $P_o = 220 \text{ mW}$

Conduit mounting:

Place washer between enclosure and nut

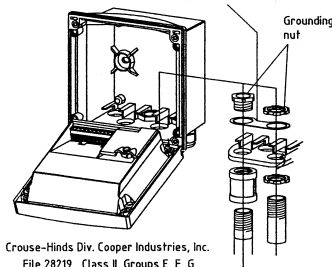

Crouse-Hinds Div. Cooper Industries, Inc.
 File 28219 Class II, Groups E, F, G
 HUB BASIC SCRU-TITE: ST-1, STA-1
 GROUND HUB: SSTG-1, STG-1, STAG-1
 GROUND NUT: STGN-1, STAGN-1
 FILE 13046 Class I, Zone 1, Ex e II, IP 66
 GROUND HUB BASIC SCRU-TITE: STGK-1, SSTGK-1

Apleton
 FILE 208042 Class II, Groups E, F, G
 HUBG-50D, HUBL-50D
 Thomas & Betts Corporation
 FILE 23086 Class I, Div 2
 Hub: 370AL, 370
 Grounding Bushing: 3870

Installation in a Class I, Division 2 or Class I, Zone 2
 hazardous locations shall be in accordance with the
 Canadian Electrical Code C22.1 Section 18
 Division 2 wiring methods.

Version: METTLER TOLEDO

Verteiler: FOR (2x)	Zul. Abweichungen für Maße ohne Toleranzangabe	Oberfläche	Maßstab	Blatt 1/2
	ISO 2768 - m		Halbzeug	
	Datum	Name	Bezeichnung	
	07.03.03		control drawing CSA	
	Gepr. IKON	Freigeber(FG)	Transmitter 2100, 4100, 5100, 7100	
			Zeichnungsnummer	
	Schulzweck nach DIN 34 beachten		194.130-240	
Nr. AE	Datum	Berechnet/FG. KON	Ungültig ab	Ersetzt durch

pH sensor group InPro 3xxx

- InPro3200

pH sensor group InPro 4xxx

- InPro4250/120/P11000

terminal assignment

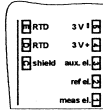

O₂ sensor group InPro 6xxx

- InPro6900/12
- InPro6910/12
- InPro6800/12
- InPro6800/25

terminal assignment

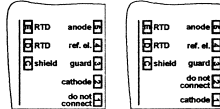

CO₂ sensor group InPro 5xxx

- CO₂-sensor

terminal assignment

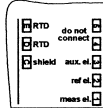

Cable: VP6-HT/XM, VP6-ST/XM

Cable type X	Coax+4L	A	B	C	D	E	F	Shield
measuring system	Core/ transparent	Shield/ red	grey	blue	white	green	yellow/ green	
pH + BE + Temp	pH	BE	(T3)		T1	T2		
ORP + BE + Temp	ORP	BE	(T3)		T1	T2		
pH + BE + Temp + ORP/HE	pH	BE	(T3)	HE/ORP	T1	T2		
pH + BE + Temp (CO ₂ -sensor)	pH	BE	(T3)		T1	T2	Shaft	
OX (2P) + Temp (InPro6100/6800)	Kathode	Anode			T1	T2	Shaft	
OX (2P) + Guard +Temp (InPro6900)	Kathode	Anode	Guard		T1	T2	Shaft	

- Legende:
- pH: pH-Lead-off
 - BE: reference electrode
 - HE: solution ground, auxiliary electrode
 - ORP: Redox electrode
 - Kathode: cathode of O₂-sensors
 - Anode: anode of O₂-sensors
 - Guard: guard-electrode of O₂-sensors
 - T1: temperature device
 - T2: temperature device (zero)
 - T3: temperature device (compensation lead)

Cond sensor group
InPro 70xx-VP

- InPro7000-VP
- InPro7005-VP
- InPro7001/120-VP
- InPro7001/225-VP
- InPro7002/15^oTC-VP
- InPro7002/2^oTC-VP

Cond sensor group
InPro 71xx-VP

- InPro7108-VP/CPVC
- InPro7108-VP/PEEK
- InPro7108-VP/PEEK/HA-C22
- InPro7108-25/40-VP
- InPro7108-25/40/HA-C22-VP
- InPro7108-26/65-VP
- InPro7108-25/65/HA-C22-VP
- InPro7108/15^oTC-VP
- InPro7108/2^oTC-VP

terminal assignment

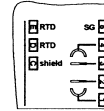

Wire color Patch cord	VP connector pin (on sensor)	Transmitter Cond 7100 e
bare	G	unused
blue	D	3
black	E	4
red	C	D
green	F	E
white	H	2
clear	B	C
white/blue	A	1

Cond sensor group InPro 72xx

- InPro7200
- InPro7201
- InPro7202

terminal assignment

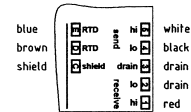

Version: METTLER TOLEDO

Verteiler: FKL (Zd)	Zul. Abweichungen für Maße ohne Toleranzangabe ISO 2768 - m	Oberfläche	Maßstab Halbzeug	Blatt 2/2
	Datum	Name	Benennung	
	Bearb.	07.03.03	dam	control drawing CSA
	Gepr. DOKNO	g	g	Transmitter 2100, 4100, 5100, 7100
	Freigebe(FGL)			Zeichnungsnummer
	Schutzvermerk nach DIN 34 beachten			194.130-240
Nr. AE	Datum	Bearbeiter/FRL KON	Ungültig ab:	Ersetzt durch:

Calibration solutions

Potassium chloride solutions

(Conductivity in mS/cm)

Temperature	Concentration *		
[°C]	0.01 mol/l	0.1 mol/l	1 mol/l
0	0.776	7.15	65.41
5	0.896	8.22	74.14
10	1.020	9.33	83.19
15	1.147	10.48	92.52
16	1.173	10.72	94.41
17	1.199	10.95	96.31
18	1.225	11.19	98.22
19	1.251	11.43	100.14
20	1.278	11.67	102.07
21	1.305	11.91	104.00
22	1.332	12.15	105.94
23	1.359	12.39	107.89
24	1.386	12.64	109.84
25	1.413	12.88	111.80
26	1.441	13.13	113.77
27	1.468	13.37	115.74
28	1.496	13.62	
29	1.524	13.87	
30	1.552	14.12	
31	1.581	14.37	
32	1.609	14.62	
33	1.638	14.88	
34	1.667	15.13	
35	1.696	15.39	
36		15.64	

*) Data source: K. H. Hellwege (Editor), H. Landolt, R. Börnstein:
Zahlenwerte und Funktionen ..., volume 2, part. volume 6

Sodium chloride solutions

(Conductivity in mS/cm)

Temperature	Concentration		
[°C]	0.01 mol/l ¹⁾	0.1 mol/l ¹⁾	saturated ²⁾
0	0.631	5.786	134.5
1	0.651	5.965	138.6
2	0.671	6.145	142.7
3	0.692	6.327	146.9
4	0.712	6.510	151.2
5	0.733	6.695	155.5
6	0.754	6.881	159.9
7	0.775	7.068	164.3
8	0.796	7.257	168.8
9	0.818	7.447	173.4
10	0.839	7.638	177.9
11	0.861	7.831	182.6
12	0.883	8.025	187.2
13	0.905	8.221	191.9
14	0.927	8.418	196.7
15	0.950	8.617	201.5
16	0.972	8.816	206.3
17	0.995	9.018	211.2
18	1.018	9.221	216.1
19	1.041	9.425	221.0
20	1.064	9.631	226.0
21	1.087	9.838	231.0
22	1.111	10.047	236.1
23	1.135	10.258	241.1
24	1.159	10.469	246.2
25	1.183	10.683	251.3
26	1.207	10.898	256.5
27	1.232	11.114	261.6
28	1.256	11.332	266.9
29	1.281	11.552	272.1
30	1.306	11.773	277.4
31	1.331	11.995	282.7
32	1.357	12.220	288.0
33	1.382	12.445	293.3
34	1.408	12.673	298.7
35	1.434	12.902	304.1
36	1.460	13.132	309.5

1) Data source: Test solutions calculated according to DIN IEC 746-3

2) Data source: K. H. Hellwege (Editor), H. Landolt, R. Börnstein:
Zahlenwerte und Funktionen ..., volume 2, part. volume 6

-01- Sodium chloride solution NaCl

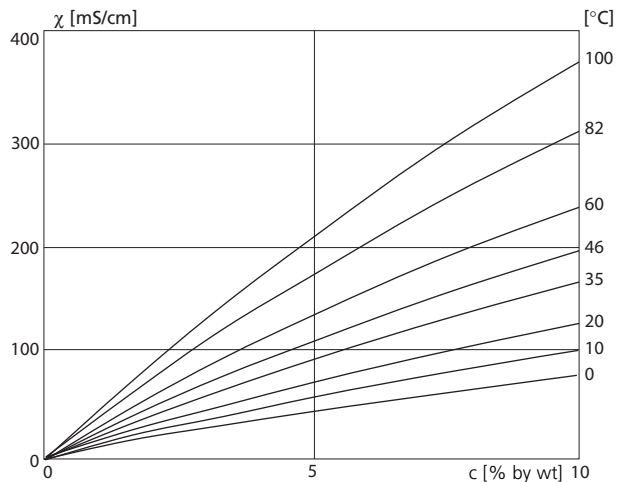

Conductivity in dependence on substance concentration and process temperature for sodium chloride solution (NaCl)

-02- Hydrochloric acid solution HCl

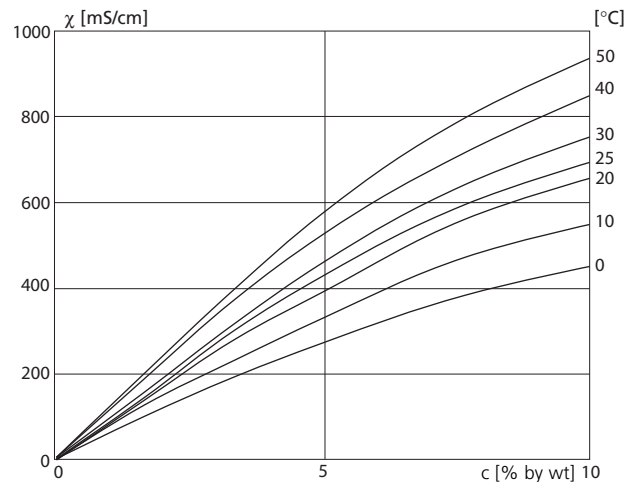

Conductivity in dependence on substance concentration and process temperature for hydrochloric acid (HCl)
 Source: Haase/Sauermann/Dücker; Z. phys. Chem. New Edition, Vol. 47 (1965)

-03- Sodium hydroxide solution NaOH

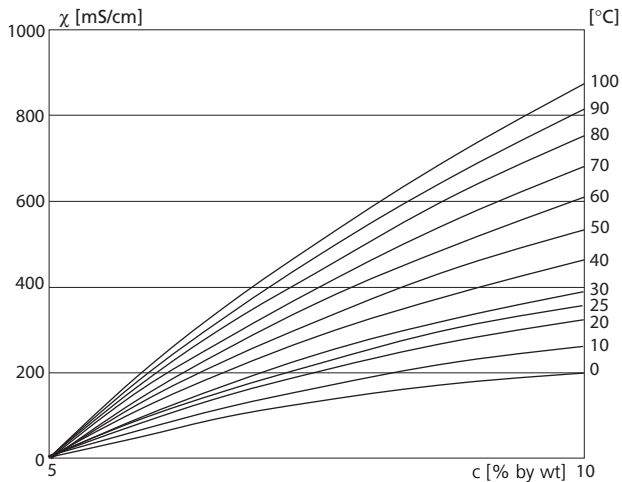

Conductivity in dependence on substance concentration and process temperature for sodium hydroxide solution (NaOH)

-04- Sulfuric acid H₂SO₄

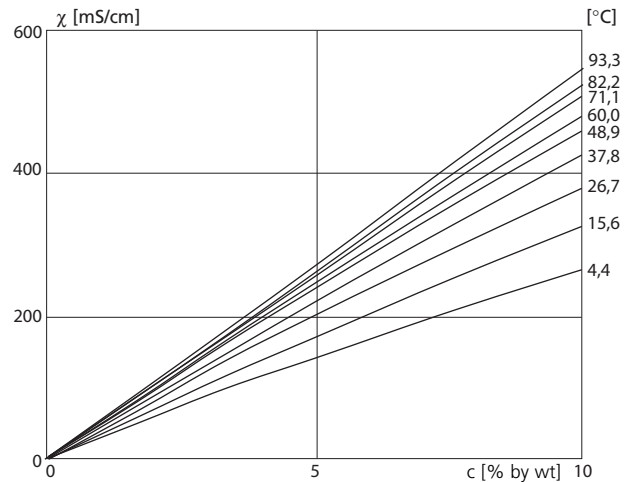

Conductivity in dependence on substance concentration and process temperature for sulfuric acid (H₂SO₄)

Source: Darling; Journal of Chemical and Engineering Data; Vol.9 No.3, July 1964

Concentration curves

-05- Nitric acid HNO_3

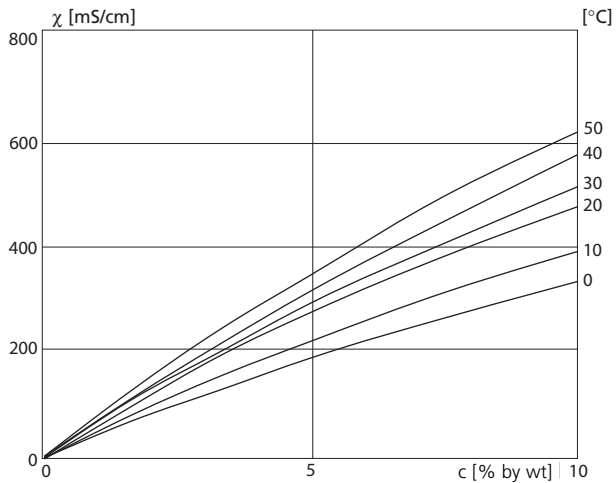

Conductivity in dependence on substance concentration and process temperature for nitric acid (HNO_3)

Source: Haase/Sauermann/Dücker; Z. phys. Chem. New Edition, Vol. 47 (1965)

Conductance Conductance $G [S] = 1 / R [\Omega]$

Conductivity Conductivity $\chi [S/cm] = G [S] \cdot c [1/cm]$

Conductivity sensor Either 2- or 4-electrode sensors can be connected. The cell constant of the sensor in use must be entered or be determined using a calibration solution taking account of the temperature.
A special device variant (Cond Ind 7100 e) is provided for electrodeless sensors.

Temperature coefficient With temperature compensation activated, the measured value is calculated to the value at the reference temperature (25 °C) using the temperature coefficient.

Temperature compensation Calculates the measured conductivity value for a reference temperature.

2-electrode coax sensor	17
with VP plug	18
22 mA signal for error message	45, 51, 54, 88
4-electrode sensor	16
with VP plug	19
Alarm settings	54
Alarm contact	54, 88, 90, 100
Alarm delay	54
Error messages	88
Operating states	90
Assembly	10
Automatic device self-test	25
Calibration	72
by input of cell constant	74
Calibration with calibration solution	76
Calibration solutions	110
Display of calibration data	81
Product calibration	78
“Clean” contact	65
Concentration measurement	37
Concentration curves	112
Configuration	28
Alarm settings	54
Control of rinsing probe	64
Controller	60
Menu structure	29
Overview	30
Relays for USP	62
Signaling parameter set 2	64
Temperature compensation	52
Configuration: Limit function	56
Relay 1	56
Relay 2	58

Use of relays	57
Configuration: Output 1	32
Measured variable	34
Output current during Error	44
Output current range	38
LIN curve	38
LOG curve	40
Output signal during HOLD	45
Process solutions for concentration	36
Sensor selection	33
Time constant of output filter	42
Configuration: Output 2	46
Output current during HOLD	50
Output current range	47
Temperature error	50
Temperature probe	47
Temperature unit	46
Time constant of output filter	48
Connections	14
Control Drawing CSA	106
Controller	60
Configuration	60
Controller equations	85
Controller test	83
Controller types	84
Pulse length / pulse frequency controller	86
CSA Certificate of Compliance	104
Current source 1/2	82
Diagnostics functions	81
Dimension drawings	12
Display	23
Display for diagnostics	81
Disposal	2

Division 2 wiring	15
EC Declaration of Conformity	7
Err	28
Error messages	88
Display of last error message	81
Explosion protection	104
GainCheck device self-test	25
Hold mode	26
External activation	26
LED in HOLD mode	54
Output signal during HOLD	45, 51
Installation	14
Intended use	6
Keypad	24
Limit function (LiMIT)	57
LIN characteristic	39
LOG characteristic	41
Mode codes	27
Mounting plan	11
Operating states	90
Output filter	43, 49
Package contents	10
Panel-mount kit	13
Parameter set 1/2	66
Default settings	69
External switchover	67
Manual selection	66
Signaling parameter set 2	64
User settings	70
PID controller	84
Pipe-mount kit	12
Process temperature	47
Temperature compensation	52

Product calibration	78
Product line and accessories	97
Protective hood	12
Protective wiring	20
Pulse frequency controller (PFC)	87
Pulse length controller (PLC)	86
Relays	56
Relay test	82
Return of products	2
Rinsing probe control	64
Safety functions	25-26
Safety information	5
CSA	105
Division 2 wiring	15
Installation	14
Salinity, settings for measurement	35
Sensocheck, Sensoface sensor monitoring	25
Sensocheck on/off	55
Sensoface	92
Sensor monitor	81
Temperature probe	46
Temperature probe adjustment	80
Terminal assignments	14
Trademarks	6
Typical wirings	16
User interface	22
USP function	94
Warranty	2
Wiring	15
2-electrode coax sensor	17
4-electrode sensor	17
Mettler-Toledo 2-electrode sensor via VP plug	18
Mettler-Toledo 4-electrode sensor via VP plug	19

