

M 700(X)

Instruction manual



Order number: 52 121 216



METTLER TOLEDO

Warranty

Defects occurring within 1 year from delivery date shall be remedied free of charge at our plant (carriage and insurance paid by sender).

©2004 Subject to change without notice

Return of products under warranty

Please contact Mettler Toledo before returning a defective device. Ship the cleaned device to the address you have been given. If the device has been in contact with process fluids, it must be decontaminated/ disinfected before shipment.

In that case, please attach a corresponding certificate, for the health and safety of our service personnel.



Disposal (Directive 2002/96/EC of January 27, 2003)

Please observe the applicable local or national regulations concerning the disposal of "waste electrical and electronic equipment".

Registered trademarks

The following registered trademarks are used in this instruction manual without further marking

CalCheck
Calimatic
Sensocheck
Sensoface
ServiceScope
VariPower

SMARTMEDIA®

is a registered trademark of Toshiba Corp., Japan

InPro®

is a registered trademark of Mettler Toledo GmbH, Switzerland

Mettler-Toledo GmbH, Process Analytics, Industrie Nord,
CH-8902 Urdorf, Tel. +41 (01) 736 22 11 Fax +41 (01) 736 26 36
Subject to technical changes. Mettler-Toledo GmbH, 06/04.
Printed in Germany.



Declaration of conformity Konformitätserklärung Déclaration de conformité



| | | | |
|--|--|--------------------------|---------|
| We/Wir/Nous | Mettler-Toledo GmbH, Process Analytics Im Hackacker 15 8902 Urdorf Switzerland | | |
| Description Beschreibung/Description | declare under our sole responsibility that the product, erklären in alleiniger Verantwortung, dass dieses Produkt, déclarons sous notre seule responsabilité que le produit, M 700 C / M 700 S to which this declaration relates is in conformity with the following standard(s) or other normative document(s). auf welches sich diese Erklärung bezieht, mit der/den folgenden Norm(en) oder Richtlinie(n) ,bereinstimmt. auquel se réfère cette déclaration est conforme à la (aux) norme(s) ou au(x) document(s) normatif(s). | | |
| Low-voltage directive/Nieder- spannungs-Richtlinie/ Directive basse tension | 73/23/EWG | | |
| Norm/Standard/Standard | EN 60529 / 10.91 | / VDE 0470 Teil 1: | 1992-11 |
| | EN 61010 Teil 1 / 03.93 | / VDE 0411 Teil 1: | 1994-03 |
| | EN 61010-1 / A2 / 07.95 | / VDE 0411 Teil 1 / A1: | 1996-05 |
| EMC Directive/EMV- Richtlinie Directive concernant la CEM | 89/336/EWG | | |
| Norm/Standard/Standard | EN 61326 | / VDE 0843 Teil 20: | 1998-01 |
| | EN 61326 / A1 | / VDE 0843 Teil 20 / A1: | 1999-05 |
| Place and Date of issue Ausstellungsort/ - Datum Lieu et date d'émission | Urdorf, August 28, 2003 | | |

Mettler-Toledo GmbH, Process Analytics

Waldemar Rauch
General Manager PO Urdorf

Christian Zwicky
Head of Marketing

Artikel Nr.: 52960320KE

52960320KE-M700-internet.doc

Mettler-Toledo GmbH

Process Analytics

Adresse Im Hackacker 15 (Industrie Nord) CH-8902 Urdorf, Schweiz
Briefadresse Postfach, CH-8902 Urdorf
Telefon 01-736 22 11
Telefax 01-736 26 36
Internet www.mt.com
Bank Cred. Suisse First Boston, Zurich (A/c. 0625-37050-21-90)

Declaration of conformity Konformitätserklärung Déclaration de conformité



We/Wir/Nous

Mettler-Toledo GmbH, Process Analytics

Im Hackacker 15
8902 Urdorf
Switzerland

declare under our sole responsibility that the product;
erklären in alleiniger Verantwortung, dass dieses Produkt,
déclarons sous notre seule responsabilité que le produit,

Description

Beschreibung/Description

M700X C / M700X S

to which this declaration relates is in conformity with the following standard(s) or other normative document(s).

auf welches sich diese Erklärung bezieht, mit der/den folgenden Norm(en) oder Richtlinie(n) übereinstimmt.

auquel se réfère cette déclaration est conforme à la (aux) norme(s) ou au(x) document(s) normatif(s).

Explosion protection

Explosionsschutzrichtlinie

Prot. contre les explosions

94/9/EG

Low-voltage directive

Niederspannungs-Richtlinie

Directive basse tension

73/23/EWG

EMC Directive

EMV-Richtlinie

Directive concernant la CEM

89/336/EWG

Place and Date of issue

Ausstellungsort / - Datum

Lieu et date d'émission

Urdorf, April 22, 2004

Mettler Toledo GmbH, Process Analytics

Waldemar Rauch
General Manager Ingolac

Christian Zwicky
Head of Marketing

METTLER TOLEDO

RE M700X-C M700X-S.doc

Mettler-Toledo GmbH

Process Analytics

Adresse | im Hockacker IS (Industrie Nord), CH-8852 Uetwil, Schweiz
Büroadresse | Postfach CH-8902 Uster
Telefon | 01-735 22 11
Telefax | 01-735 26 36
Internet | www.mt.com
Bank | Credit Suisse für Regionen Zürich (A/c. 0836-3/2501-21-85)

| | | |
|-------------------------------|--------------------|---|
| <u>Norm/Standard/Standard</u> | 94/9/EG: | EN 50014 EN 50019 EN 50020 EN 50028 EN 50281-1-1 |
| | 73/23/EWG: | DIN EN 61010-1 / VDE 0411 Teil 1: 2002-08 |
| | 89/336/EWG: | DIN EN 61326 / VDE 0843 Teil 20: 2002-03 |

METTLER TOLEDO

KE M700X-C M700X-S.doc

Contents

for the M 700(X) modular process analysis system

| | |
|---|----|
| EC Declaration of Conformity..... | 3 |
| Software version | 6 |
| Modular concept and instruction manuals..... | 7 |
| System overview | 8 |
| Latest product information | 10 |
| How to order an additional function | 11 |
| Intended use, package contents..... | 12 |
| Package contents | 12 |
| Safety information (Application in hazardous locations)..... | 13 |
| Information on commissioning/start-up | 14 |
| Conformity with FDA 21 CFR Part 11 | 15 |
| Product line..... | 16 |
| Short description | |
| M 700 FRONT | 18 |
| Menu structure | 19 |
| Opened device, M 700 FRONT: SmartMedia card | 20 |
| Opened device, M 700 BASE: Module equipment | 21 |
| Connection of power supply | |
| M 700 BASE 700 C/S (non-IS) | 23 |
| M 700 BASE 700X (C/S)/VPW (IS) | 24 |
| M 700 BASE 700X (C/S)/24V (IS) | 25 |
| Hazardous-area connection M 700X | |
| Hazardous-area connection, hazardous-area components (examples) | 26 |
| Dimension drawings | |
| Panel mounting..... | 28 |
| Wall mounting, post mounting | 29 |
| Operation | |
| Menu structure | 30 |
| Menu selection..... | 31 |
| Icons | 31 |
| How to enter numbers and text | 32 |
| Configuring the measurement display | 34 |
| Softkey usage (function control)..... | 36 |
| Favorites menu..... | 37 |
| Selected diagnostics functions for quality management..... | 38 |
| Diagnostics functions | |
| Sensoface..... | 39 |
| Message list, logbook, device description | 40 |

Contents

for the M 700(X) modular process analysis system

Parameter setting

| | |
|--|----|
| Operating levels: Viewing level, Operator level, Administrator level | 42 |
| Parameter setting: Lock functions | 43 |
| Function control matrix, time/date..... | 44 |
| Point of measurement, passcodes, release of options..... | 45 |
| Inserting the SmartMedia card | 46 |
| SmartMedia card: Application | 47 |
| System control: Parameter sets A, B | 48 |
| SmartMedia card: Parameter sets | 49 |
| SmartMedia card: Memory card | 51 |
| SmartMedia card: Software update | 52 |
| SmartMedia card: Save firmware..... | 54 |
| SmartMedia card: Format card | 55 |
| SmartMedia card: Remove card..... | 56 |
| Factory setting, logbook..... | 57 |
| Language, measurement display, viewing angle | 58 |
| Current outputs, contacts, OK inputs | 59 |
| Current outputs: Current output curves | 60 |
| Current outputs: Behavior during messages | 63 |
| NAMUR signals (failure, maintenance request, function check)..... | 64 |
| Relay contacts: Protective wiring | 65 |
| Relay contacts: Usage..... | 66 |
| Relay contacts: Limit value, hysteresis, contact type..... | 67 |
| OK1,OK2 inputs: Switching level..... | 68 |
| Switching parameter sets via OK2 | 69 |
| Signaling active parameter set via relay contact..... | 69 |
| Calculation Blocks | 71 |
| pH value calculation by means of dual conductivity measurement..... | 73 |
| USP function | |
| Monitoring of ultrapure water in the pharmaceutical industry..... | 75 |
| Maintenance | |
| Current source, Open/close memory card..... | 76 |
| Specifications | 77 |
| Glossary | 81 |
| Index | 86 |

Software version

Device software M 700(X)

Software version 5.x

Modules supported

For modules which are not listed here, refer to corresponding module instruction manual.

| Module | Software version |
|------------------------|------------------|
| pH 2700 (X) | 2.0 |
| Cond 7700(X) | 2.0 |
| Cond Ind 7700(X) | 2.0 |
| O2 4700(X) | 2.1 |
| O2 4700(X) ppb | 2.1 |
| Out 700(X) | 1.1 |
| PID 700(X) | 1.1 |
| PA 700(X) | 1.x |
| pH 2700(X) / EC 400(X) | 1.x |

Query actual device/module software

When the analyzer is in measuring mode:
Press **menu** key, open Diagnostics menu.

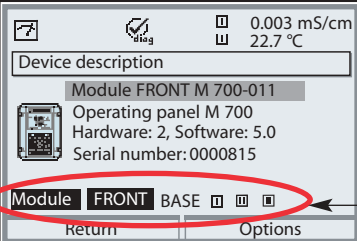
| Menu | Display | Device description |
|---|---|---|
|  |  | <p>Provides information about all modules installed: Module type and function, serial number, hardware and software version and device options. Select the different modules (FRONT, BASE, slots 1 - 3) using the arrow keys.</p> |

Modular concept and instruction manuals

Instruction manuals for basic unit, measuring module, additional functions.

The M 700(X) is an expandable modular process analysis system. The basic unit (M 700(X) FRONT and M 700(X) BASE) provides three slots which can be equipped by the user with any combination of measuring or communication modules. The software capabilities can be expanded by additional functions (options). Additional functions must be ordered separately. They are supplied with a device-specific TAN for function release.

M 700(X) modular process analysis system

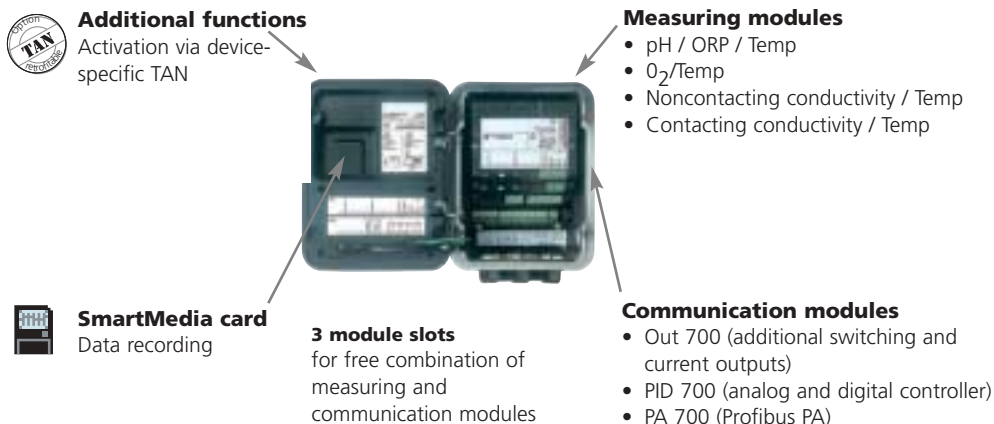

- **The instruction manual for the M 700(X)** describes how to install, commission and operate the basic unit.
- **The instruction manual for the measuring or communication module** describes all functions required for commissioning and working with the respective measuring or communication module.
- **Additional functions** are supplied with a function description.

System overview

M 700(X) modular process analysis system:
Measuring modules and communication modules

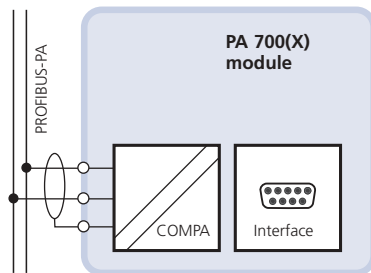
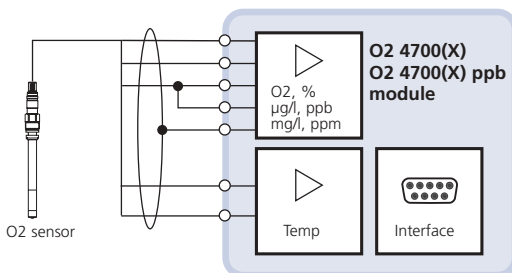
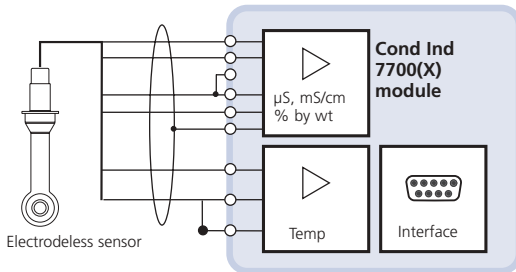
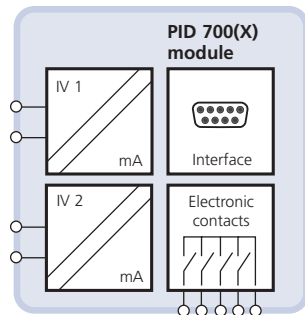
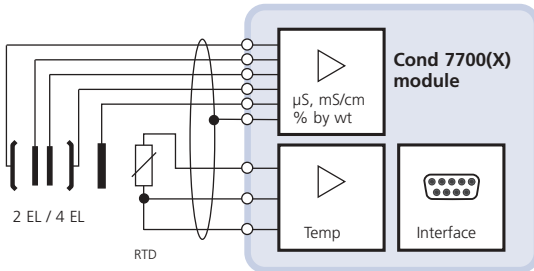
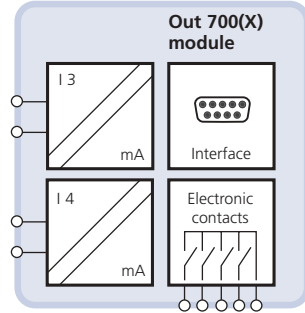
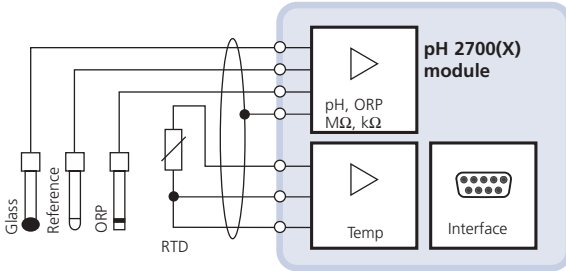

System overview

M 700(X) modular process analysis system:
Basic unit and control module for retractable housings

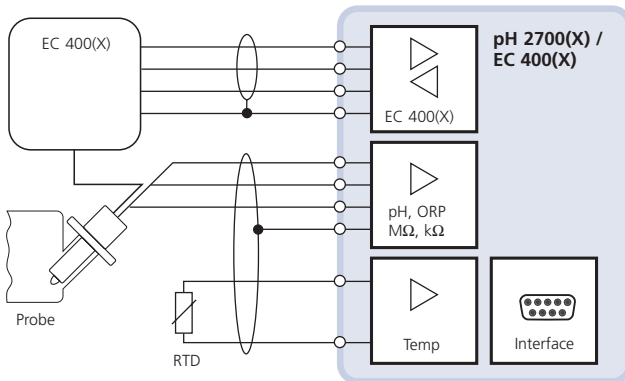
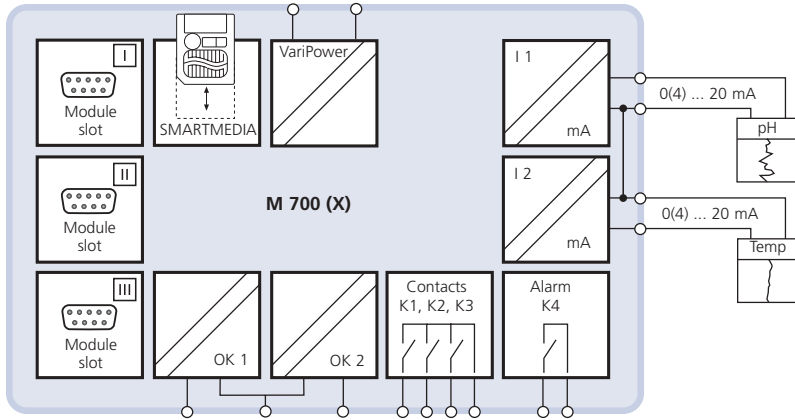

Latest product information

Additional functions

The M 700(X) is an expandable modular process analysis system.
For latest product information, please refer to:

www.mtpro.com

Additional functions

A current version of the respective function description is available as pdf for download.



How to order an additional function

Device-specific TAN (transaction number)

Additional functions expand the device capabilities.

The additional functions are device-specific. When ordering an additional function, you therefore have to specify the serial number and hardware version of your FRONT module in addition to the respective order number. The manufacturer then supplies a TAN (transaction number) to release the additional function.

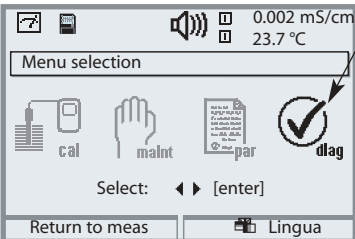
Serial number M 700 FRONT

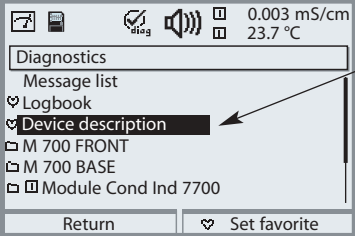
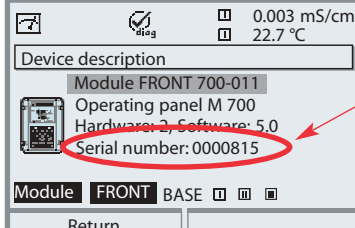
| Menu | Display | Serial number M 700 FRONT |
|---|---|---|
| |  | <p>Menu selection</p> <p>Call up diagnostics. From the measuring mode: Press menu key to select menu. Select diagnostics using arrow keys, confirm with enter.</p> |
|  |  | <p>Diagnostics</p> <p>Select Device description using arrow keys, confirm with enter.</p> |
| |  | <p>Device description</p> <p>Please specify this <u>serial number</u> and the <u>hardware version</u> when ordering an additional function.</p> |

Intended use

The M 700(X) modular process analysis system is preferably used to measure and process electrochemical quantities in liquids. It has a modular design and consists of the BASE power supply unit, the FRONT door and different measuring and communication modules.

The M 700X is intended for operation in locations subject to explosion hazards which require equipment of Group II, device category 2(1), gas/dust.

The M 700(X) is a flexible measuring system for continuous measurements in the field of liquid analysis. Thanks to its modular design, the M 700(X) can easily be adapted to your measuring task. Flexible use of plug-in modules allows combined measurements as well as later expansions or modifications.

The measured variables depend on the measuring modules installed.

Communication modules are available for further processing of the output signals. The rugged enclosure (IP 65) can be wall or pipe mounted or fixed into a control panel. The M 700 version with hygienic, polished stainless steel enclosure allows application in the field of biotechnology, food processing, and in the pharmaceutical industry. The M 700 version with coated steel enclosure – extremely corrosion resistant – has been developed for application in the chemical industry, environmental engineering, water and wastewater treatment, and for application in power plants .

Caution!

Never expose the display to direct sun light! Only operate the display within the temperature range of 0 °C up to 50 °C max.

Package contents

- M 700(X) basic unit (FRONT and BASE)
- Wall-mount kit
- Test Certificate
- This instruction manual
- EC Declaration of Conformity
- EC-Type-Examination Certificate (M 700X)

Modules as ordered (each in a separate package with Instruction Manual, Test Certificate, EC Declaration of Conformity):

Safety information

Application in hazardous locations

M 700X modular process analysis system

The M 700X modular process analysis system is intended for operation in specific environments and specific fields of application. These are listed in the instruction manual as specifications for environment, installation and commissioning, intended use (= application), assembly and dismantling, and maintenance.

Observe the influences of humidity, ambient temperature, chemicals and corrosion. If the specifications in the instruction manual are not sufficient for assessing the safety of operation, e.g. because your specific applications are not described, please contact the manufacturer to make sure that the application is possible and safe.

Prerequisite to safe use of the equipment is the observance of the specified ambient conditions and temperature ranges.

When using the M 700X modular process analysis system, the stipulations for electrical installations in hazardous areas (EN 60079-14) must be observed. When installing the device outside the range of applicability of the 94/9/EC directive, the appropriate standards and regulations in the country of use must be observed.

The module has been developed and manufactured in compliance with the applicable European guidelines and standards. Compliance with the European Harmonized Standards for use in hazardous locations is confirmed by the EC-Type-Examination Certificate. Compliance with the European guidelines and standards is confirmed by the EC Declaration of Conformity. The EC Declaration of Conformity and the EC-Type-Examination Certificate are included in the instruction manual.

There is no particular direct hazard caused by the operation of the device in the specified environment.

Safety information

During operation, the M 700X modular process analysis system may be opened briefly to replace the SmartMedia card. The mains terminal cover must be opened only when the unit is de-energized.

Installation:

The power supply must be disconnectable using a 2-pole disconnect switch installed near the Protos. This switch must meet the requirements of EN 60947-1 and EN 60947-3, be marked as disconnecting device for M 700(X) and be easily accessible by the user.

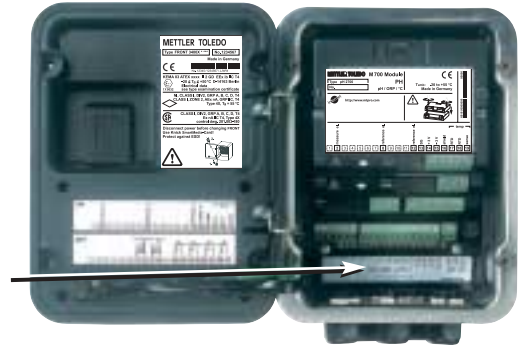

Information on commissioning/start-up

Caution!

- Before commissioning it must be proved that the device may be connected with other equipment.
- Commissioning must only be performed by authorized and trained personnel!
- The combination of hazardous-area and safe-area modules (mixed configuration) is not permitted.

Whenever it is likely that protection has been impaired, the device shall be made inoperative and secured against unintended operation. The protection is likely to be impaired if, for example:

- the device shows visible damage
- the device fails to perform the intended measurements
- after prolonged storage at temperatures above 70 °C
- after severe transport stresses

Before recommissioning the device, a professional routine test in accordance with EN 61010-1 must be performed. This test should be carried out by the manufacturer.

Conformity with FDA 21 CFR Part 11

In their directive “Title 21 Code of Federal Regulations, 21 CFR Part 11, Electronic Records; Electronic Signatures” the US American health agency FDA (Food and Drug Administration) regulates the production and processing of electronic documents for pharmaceutical development and production. This results in requirements for measuring devices used for corresponding applications. The following features ensure that the M 700(X) modular process analysis system meets the demands of FDA 21 CFR Part 11:

Electronic Signature

Access to the device functions is regulated and limited by individually adjustable codes – “Passcodes”. This prevents unauthorized modification of device settings or manipulation of the measurement results. Appropriate use of these passcodes makes them suitable as electronic signature.

Audit Trail Log

Every change of device settings can be automatically recorded and documented in the Audit Trail Log on the SmartMedia card. The recording can be encoded.

Product line

Device (Standard version)

| | | Order No. |
|---------------|---------------------------------------|-----------|
| M 700 S | Basic unit, stainless steel enclosure | 52121174 |
| M 700 C | Basic unit, coated steel enclosure | 52121171 |
| pH 2700 | Module: pH | 52121182 |
| Cond 7700 | Module: Conductivity | 52121184 |
| Cond Ind 7700 | Module: Electrodeless cond. | 52121186 |
| O2 4700 | Module: Oxygen (standard) | 52121188 |
| O2 4700 ppb | Module: Oxygen (traces) | 52121190 |
| Out 700 | Module: Output expansion | 52121177 |
| PA 700 | Module: Profibus PA | 52121210 |
| PID 700 | Module: PID controller | 52121179 |

Device (hazardous-area version)

| | | Order No. |
|----------------|---|-----------|
| M 700X S/VPW | Basic unit, stainless steel enclosure with VariPower power supply unit | 52121175 |
| M 700X S/24V | Basic unit, stainless steel enclosure with 24 V power supply unit | 52121176 |
| M 700X C/VPW | Basic unit, coated steel enclosure with VariPower power supply unit, AC | 52121172 |
| M 700X C/24V | Basic unit, standard enclosure with 24 V power supply unit, AC/DC | 52121173 |
| pH 2700X | Module: pH | 52121183 |
| Cond 7700X | Module: Conductivity | 52121185 |
| Cond Ind 7700X | Module: Electrodeless cond. | 52121187 |
| O2 4700X | Module: Oxygen (standard) | 52121189 |
| O2 4700X ppb | Module: Oxygen (traces) | 52121191 |
| Out 700X | Module: Output expansion | 52121178 |
| PA 700X | Module: Profibus PA | 52121181 |
| PID 700X | Module: PID controller | 52121180 |

Additional functions**Order No.**

| | | |
|-----------------------------------|---------------------------------|----------|
| KI recorder | TAN SW 700-001 | 52121198 |
| Buffer sets to be entered (pH) | TAN SW 700-002 | 52121199 |
| Adaptive cal timer (pH) | TAN SW 700-003 | 52121200 |
| ServiceScope (pH) | TAN SW 700-004 | 52121201 |
| Tolerance band recorder (pH) | TAN SW 700-005 | 52121202 |
| Current characteristic definable | TAN SW 700-006 | 52121203 |
| TC ultrapure water (Cond) | TAN SW 700-008 | 52121204 |
| Concentration determination | TAN SW 700-009 | 52121205 |
| Sensocheck configurable | TAN SW 700-010 | 52121206 |
| High CO ₂ compensation | TAN SW 700-011 | 52121250 |
| 5 loadable parameter sets | TAN SW 700-102 | 52121192 |
| Measurement recorder | TAN SW 700-103 | 52121193 |
| Extended logbook | TAN SW 700-104 | 52121194 |
| Software update | TAN SW 700-106 | 52121195 |
| AuditTrail to FDA 21 CFR Part 11 | AuditTrail card/TAN, SW 700-107 | 52121196 |

Accessories**Order No.**

| | | |
|-----------------|---------|----------|
| SmartMedia card | ZU 0543 | 52121207 |
| Pipe-mount kit | ZU 0544 | 52121208 |
| Panel-mount kit | ZU 0545 | 52121209 |
| VP input socket | | 52201114 |

Short description: M 700 FRONT

M 700

Modular hardware and software system for liquid analysis.

4 captive screws

for opening the analyzer

(Caution! Make sure that the gasket between FRONT and BASE is properly seated and clean!)

Transflective LC graphic display

(240 x 160 pixels)

white backlighting, high resolution and high contrast.

Measurement display

For parameter setting, see Pg 35

User interface

with plaintext menus as recommended by NAMUR.

Menu texts can be switched to: German, English, French, Italian, Swedish, and Spanish.

Intuitively acquirable menu logic, based on Windows standards.

Secondary displays

For parameter setting, see Pg 36

2 softkeys

with context-sensitive functions.

Red LED

signals failure (On) or maintenance request/function check (flashing) according to NE 44.

Green LED

Voltage supply okay

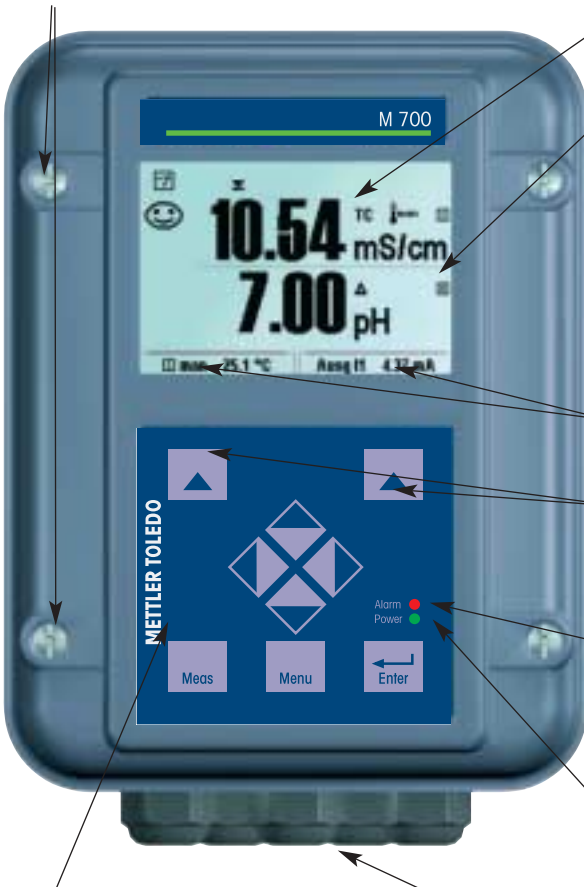

Control panel

3 function keys

(menu, meas, enter)

and 4 arrow keys for menu selection and data entries

5 self-sealing cable glands

M20 x 1.5

for entry of voltage supply and signal lines

Short description: Menu structure

Basic functions: Calibration, maintenance, parameter setting, diagnostics

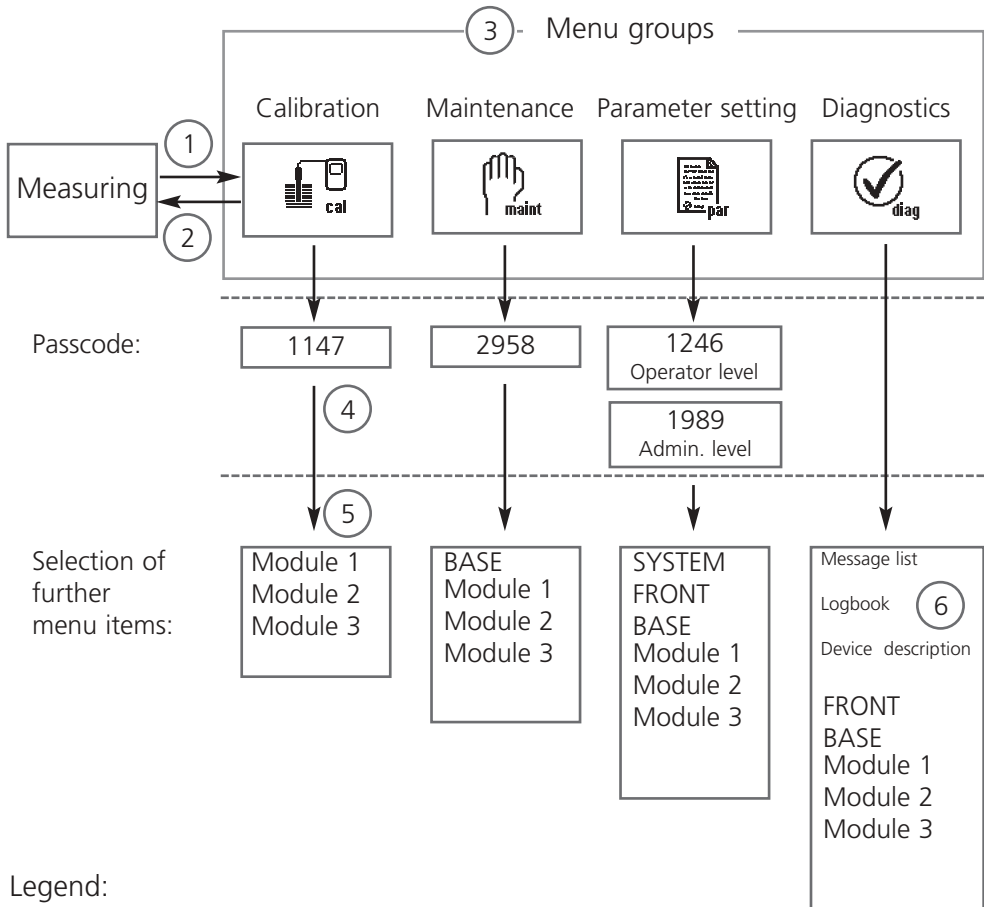

Legend:

- (1) Pressing the **menu** key accesses menu selection
- (2) Pressing the **meas** key returns to measurement
- (3) Menu groups are selected using the arrow keys
- (4) Press **enter** to confirm, enter passcode
- (5) Further menu items are displayed
- (6) Selected functions of the Diagnostics menu can be recalled via softkey even when in measuring mode (Pg 34)

Short description: M 700 FRONT

M 700

View into the open device (M 700 FRONT)

Slot for SmartMedia card

- **Data recording**
The SmartMedia card expands the measurement recorder capacity to > 50000 records.
- **Exchange of parameter sets**
5 parameter sets can be stored on the SmartMedia card, 2 of them can be loaded to the M 700 and switched by remote control. Configurations can be transferred from one M 700 to the other.
- **Function expansions**
are possible with additional software modules which are released using transaction numbers (TAN).
- **Software updates**

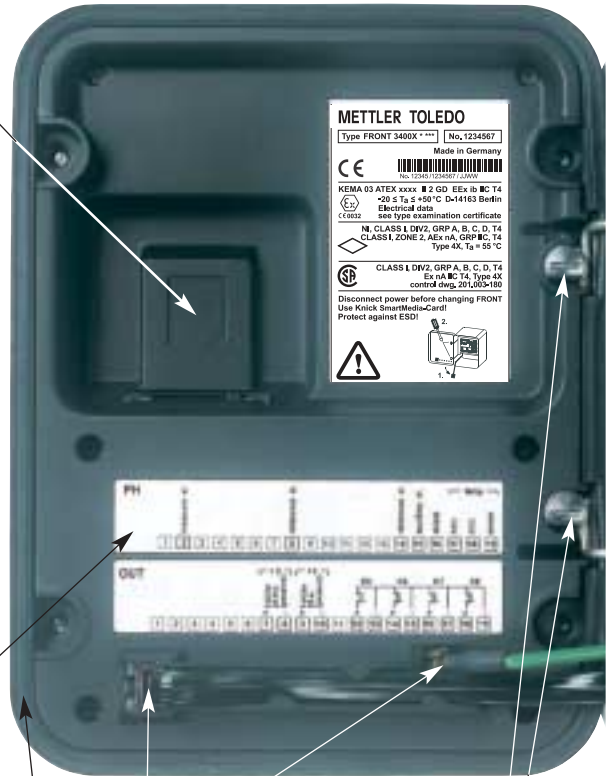

Terminal plates of "hidden" modules

Each module comes with an adhesive label containing the contact assignments. This label should be stuck to the inner side of the front (as shown). Then, the terminal assignments remain visible even if further modules are inserted.

Replacing the front module

Pull off power cord and ground wire. To separate the M 700 FRONT from the M 700 BASE, turn the retaining screws of the pivot hinge by 90°.

The circumferential sealing

guarantees IP 65 protection and allows spray cleaning / disinfection.

Caution! Keep clean!

Short description: M 700 BASE

M 700

View into the open device (M 700 BASE, 3 function modules installed)



Module equipment

*Module identification: Plug & Play
Up to 3 modules can be combined as desired. Several input and communication modules are available
(Overview on Page 16)*

M 700 BASE

2 current outputs (free assignment of process variable) and 4 relay contacts, 2 digital inputs.

VariPower broad-range power supply unit, 20 ... 265 V AC/DC, suitable for all public mains supplies in the world.

Power supply units, IS version:

100 ... 230 V AC or

24 V AC/DC

Warning!

Do not touch the terminal compartment, there may be dangerous contact voltages!

Important note concerning SmartMedia card

The SmartMedia card may be inserted or replaced with the power supply switched on. Before a memory card is removed, it must be "closed" in the maintenance menu. When closing the device, make sure that the sealing is properly seated and clean.

Connection of power supply

Module M 700 C / M 700 S (non-IS)



Connection of power supply (BASE M 700 C / M 700 S, non-IS)

The M 700(X) comes in three different versions.
The terminal plates and wirings are shown on the following pages.

- 1. BASE M 700 C / M 700 S (standard version, non-IS)**
VariPower broad-range power supply unit, 24 (-15 %) ... 230 (+15%) V AC/DC
- 2. BASE M 700X C/VPW / M 700X S/VPW (IS version)**
VariPower broad-range power supply unit
- 3. BASE M 700X C/24V / M 700X S/24V (IS version)**
24 V power supply unit

1. BASE M 700 C / M 700 S (non-IS)

Standard version. Not suitable for hazardous-area applications!

Information on installation

Caution!

- Installation may only be carried out by trained and authorized experts in accordance with this instruction manual and as per applicable local and national codes.
- Be sure to observe the technical specifications and input ratings.
- Be sure not to notch the conductor when stripping the insulation.
- All parameters must be set by the system administrator prior to commissioning.

Connection of power supply

With the VariPower broad-range power supply unit, the analyzer can be operated with a power supply of 24 (-15 %) to 230 (+15 %) V AC/DC making it suitable for all public mains supplies in the world.

The terminals are suitable for single wires and flexible leads up to 2.5 mm² (AWG 14).

Terminal plate BASE M 700

Standard version. Not suitable for hazardous-area applications!

Connection of power supply. Contact assignment of inputs/outputs.

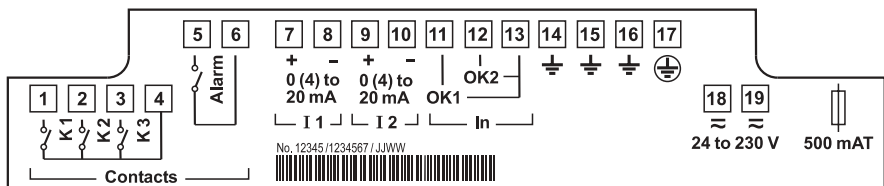

2. BASE M 700X C/VPW / M 700X S/VPW

IS version with VariPower power supply unit

Information on installation

When using the M 700X modular process analysis system, the stipulations for electrical installations in hazardous areas (EN 60079-14) must be observed. When installing the device outside the range of applicability of the 94/9/EC directive, the appropriate standards and regulations in the country of use must be observed.

Caution!

- Installation may only be carried out by trained and authorized experts in accordance with this instruction manual and as per applicable local and national codes.
- Be sure to observe the technical specifications and input ratings.
- Be sure not to notch the conductor when stripping the insulation.
- All parameters must be set by the system administrator prior to commissioning.

Connection of power supply

With the VariPower broad-range power supply unit, the analyzer can be operated with a power supply of 100 to 230 V AC (-15 %, +10 %) (EEx em IIC).

The terminals are suitable for single wires and flexible leads up to 2.5 mm² (AWG 14).

Terminal plate BASE M 700X C/VPW / M 700X S/VPW

(IS version with VariPower power supply unit)

Connection of power supply. Contact assignment of inputs/outputs.

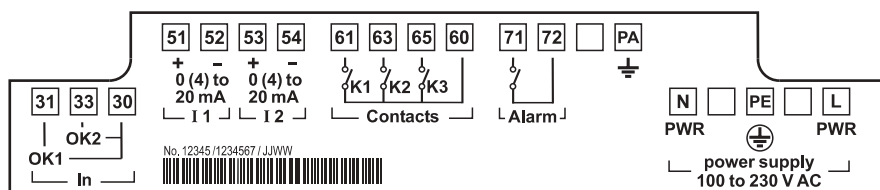

3. BASE M 700X C/24V / M 700X C/24V

IS version with 24 V power supply unit

Information on installation

When using the M 700X modular process analysis system, the stipulations for electrical installations in hazardous areas (EN 60079-14) must be observed. When installing the device outside the range of applicability of the 94/9/EC directive, the appropriate standards and regulations in the country of use must be observed.

Caution!

- Installation may only be carried out by trained and authorized experts in accordance with this instruction manual and as per applicable local and national codes.
- Be sure to observe the technical specifications and input ratings.
- Be sure not to notch the conductor when stripping the insulation.
- All parameters must be set by the system administrator prior to commissioning.

Connection of power supply

With the power supply unit, the analyzer can be operated with a power supply of 24 V AC (-15 %, +10%) or 24 V DC (-15 %, +20%). The terminals are suitable for single wires and flexible leads up to 2.5 mm² (AWG 14).

Terminal plate BASE M 700X (C/S)/24V

(IS version with 24 V power supply unit)

Connection of power supply. Contact assignment of inputs/outputs.

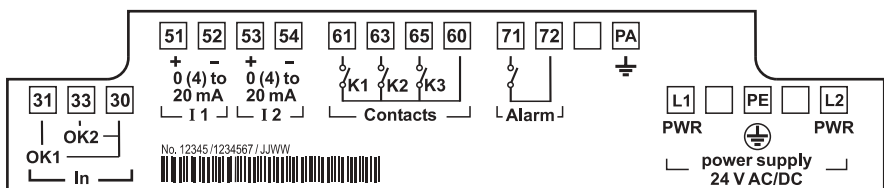

Hazardous-area connection M 700X

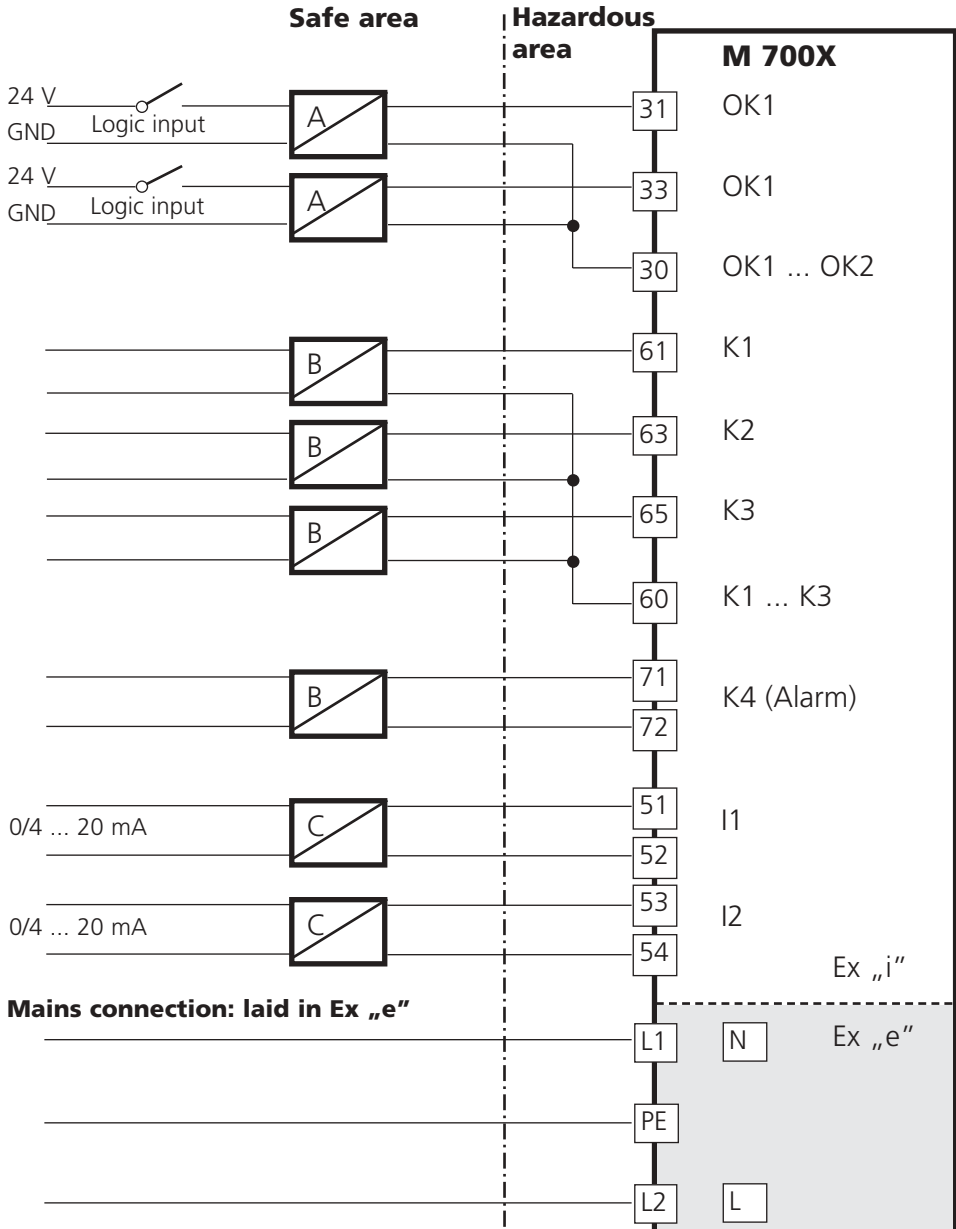

Hazardous-area control modules (examples)

| | Designation | Model | Manufacturer |
|---|-----------------------|---------------------|---------------------|
| A | Valve control module | KFD2-SL-Ex 1.48**** | Pepperl + Fuchs |
| | Valve control module | MK 72-S17-Ex0/24VDC | TURCK |
| B | Switch amplifier | KF**-SR2-Ex1.W.** | Pepperl + Fuchs |
| | Switch amplifier | MK1-22Ex0-R/** | TURCK |
| C | Loop-powered isolator | IsoTrans® 36A7 | Knick |

Panel mounting

Dimension drawings

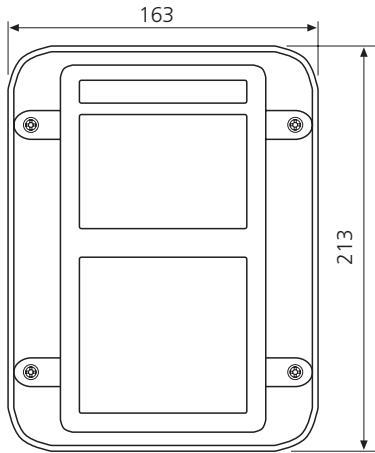

Front view

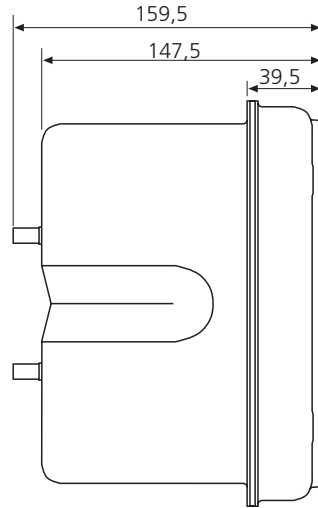

Side view

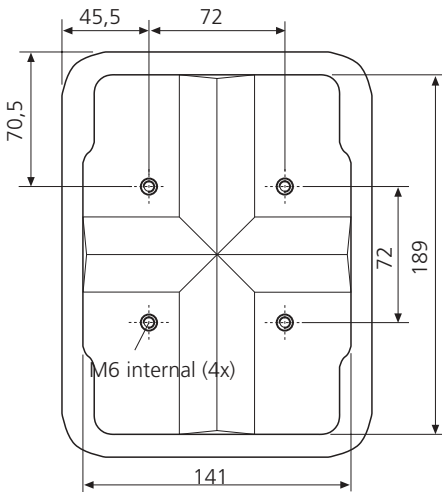

Rear view

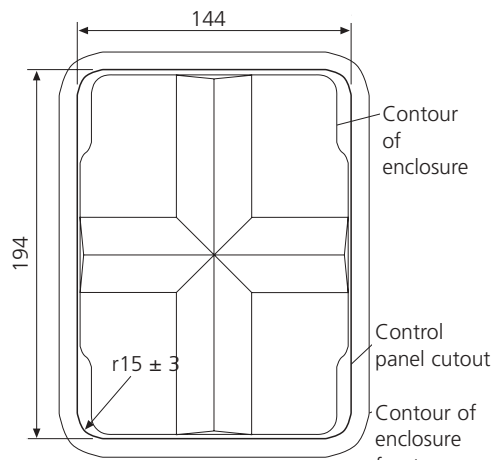

Control panel cutout

Wall mounting, post mounting

Dimension drawings

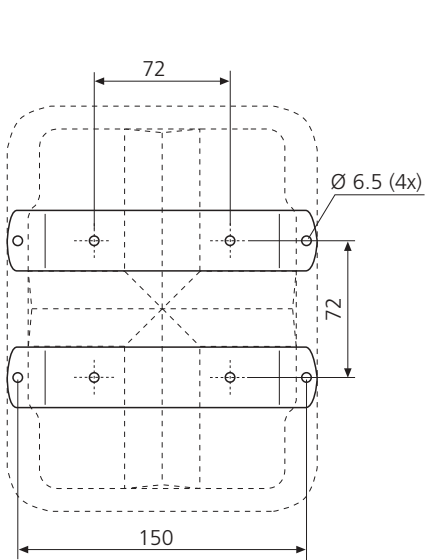

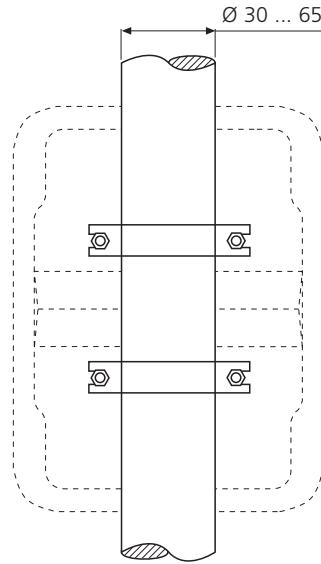

Wall mounting

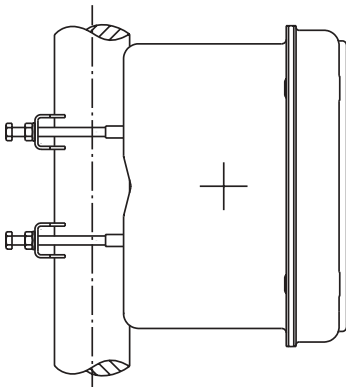

Post mounting

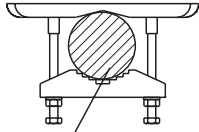

$\varnothing 30 \dots 65$ mm
for vertical or horizontal mounting

| | | |
|---|---|------------------|
|  |  | |
| $\varnothing 30 \dots 65$ mm | M6x50 | M6x70 |
| $\varnothing 30 \dots 40$ mm | X | |
| $\varnothing 40 \dots 62$ mm | | X |
| $\varnothing 62 \dots 65$ mm | | X without nut |

ZU 0544 pipe-mount kit

Menu structure

M 700 FRONT

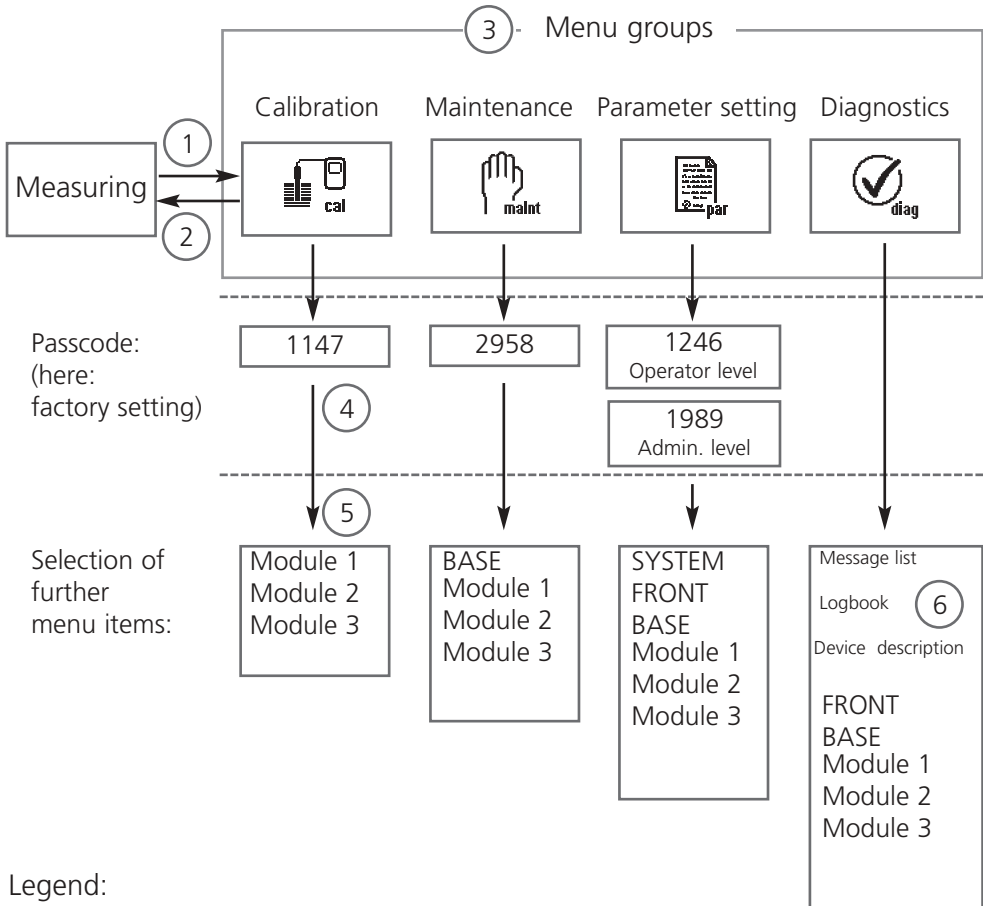

Legend:

- (1) Pressing the **menu** key accesses menu selection
- (2) Pressing the **meas** key returns to measurement
- (3) Menu groups are selected using the arrow keys
- (4) Press **enter** to confirm, enter passcode
- (5) Further menu items are displayed
- (6) Selected functions of the Diagnostics menu can be recalled via softkey even when in measuring mode (Pg 34)

Menu selection

M 700 FRONT

After switching on, the M 700 performs an internal test routine and automatically detects the number and type of modules installed. Then, the M 700 goes to measuring mode (Pg 34).

- Configure measurement display **(7)**
Pg 34
- Secondary displays/softkeys **(8)**
Pg 36

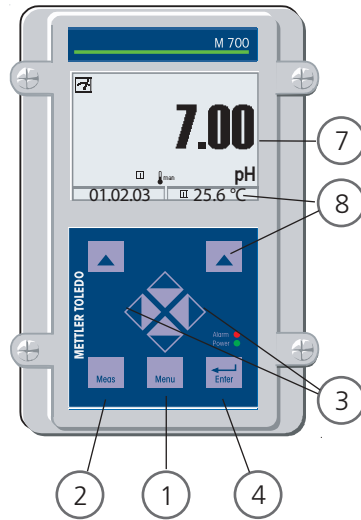

Menu selection

- (1) Pressing the **menu** key accesses menu selection
- (2) Pressing the **meas** key returns to measurement

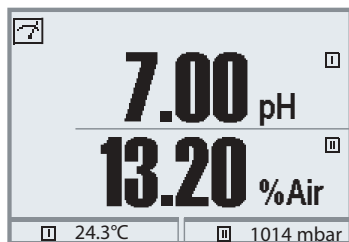

(Measuring mode)

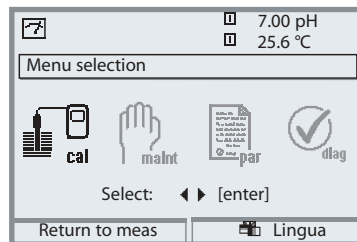
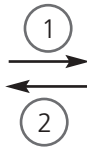

(Menu selection)

Select the desired menu group using the arrow keys **(3)**. Press **enter** **(4)** to confirm your choice. An overview of the menu structure is given on Pg 30.

Mode indicators in the display

Icons

The plain-text user interface is supplemented by icons which provide information on the operating status:

HOLD

Function check is active

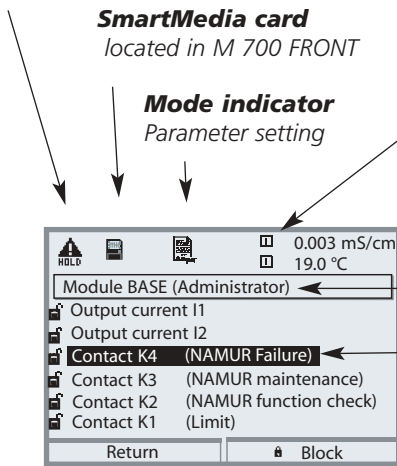

SmartMedia card
located in M 700 FRONT

Mode indicator
Parameter setting

Module identification

After a menu has been called up, the currently measured values of the respective modules are displayed here. (number of module slot, no module designation)

Menu level (Administrator level)

Current selection

is displayed in reverse video. (Parameters represented in gray cannot be edited, they have been blocked at the Administrator level.)

Safety of operation

To ensure increased safety of operation, the M 700 provides three operating levels:

- **Administrator level**
Access to all device parameters.
Settings can be blocked against access from the Operator level.
- **Operator level**
Access to all functions which have been released at the Administrator level.
Blocked functions are displayed in gray and cannot be edited.
- **Viewing level**
Display of all settings.
No editing possible.

How to enter numbers and text

M 700 FRONT: Operation

Select the position using the **left/right** keys, then edit the number or letter using the **up/down** keys. Confirm with **enter**.

Example:

Entering a tag number (point of measurement)

- Open the menu selection (**menu**)
- Select parameter setting
- Administrator level, enter passcode
- Select point of measurement:

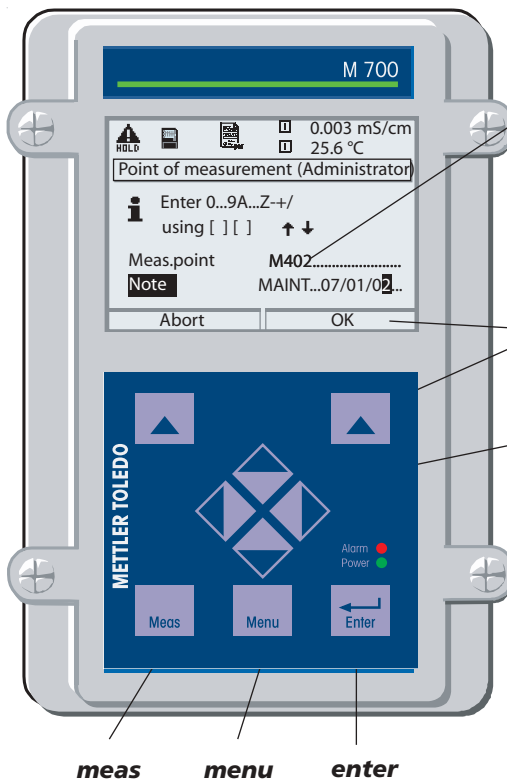

Point of measurement

You can enter a tag number for the measurement point and notes using the arrow keys.

Function

which is assigned to the softkey underneath.

Arrow keys

For selection of menu lines or entry of letters and numbers.

Configuring the measurement display

Select menu: Parameter setting/M 700 FRONT/Measurement display

Pressing **meas (1)** returns the M 700 to the measuring mode from any function. (Pressing **meas** in measuring mode, successively displays the activated special functions such as measurement recorder or KI recorder). All process variables coming from the modules can be displayed. The table on the next page describes how to configure the measurement display.

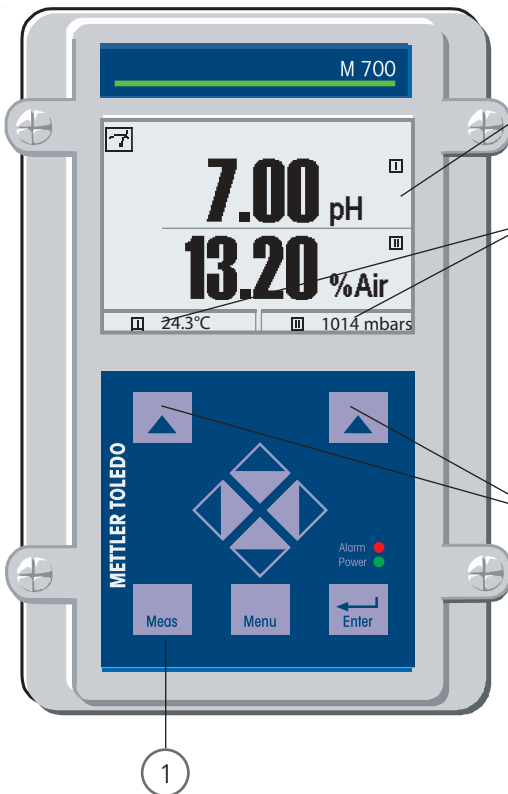

Measurement display

Typical measurement display
(O₂, pH modules)

Secondary displays



Additional values, also date and time, can be displayed depending on the modules installed. They are selected using the softkeys (Pg 36).

Softkeys

The softkeys allow selection of values for the secondary displays. In addition, Diagnostics functions which are set as "Favorites" can be called up. (Pg 37)

If required, you can also change the parameter set via softkey (Pg 37)

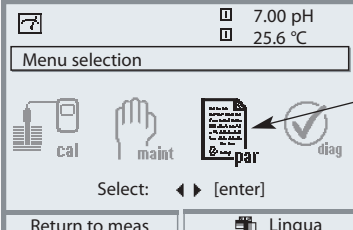
Furthermore, the softkeys include self-explaining, context-sensitive functions, e.g. with measurement or KI recorder activated.

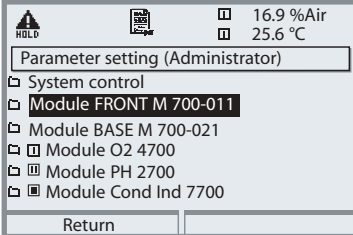
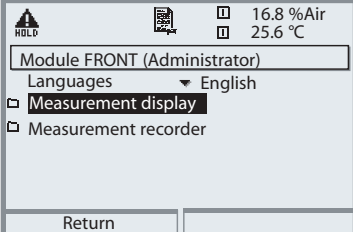
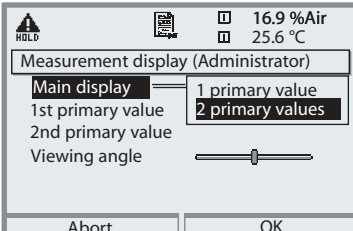
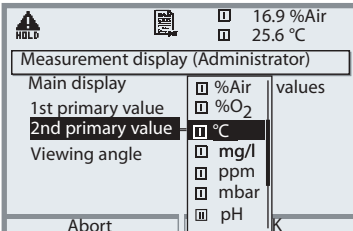
| Menu | Display | Configure measurement display |
|---|---|---|
| |  | <p>Configure meas. display Press menu key to select menu. Select parameter setting using arrow keys, confirm with enter. Select: “Administrator level”: Passcode 1989 (For passcodes, see Pg 55)</p> |
|  |  | <p>Parameter setting: Select “M 700 FRONT”</p> |
| |  | <p>M 700 FRONT: Select “Measurement display”</p> |
| |  | <p>Measurement display: Set the number of primary values (large display) to be displayed</p> |
| |  | <p>Select process variable(s) to be displayed and confirm with enter. Pressing the meas key returns to measurement.</p> |

Softkey function (function control)

Select menu: Parameter setting / System control / Function control matrix

In measuring mode you can use the **softkeys (1)** to control functions. The functions are assigned in the function control matrix (Fig.) (Parameter setting/System control).

Softkeys which have not been assigned to a certain function are automatically used for selecting the secondary displays.

Secondary display (2)

Display of additional values in the measuring mode when the respective softkey is pressed. Always active. You can choose one of the process variables supplied by the modules (and Calculation Blocks) or the date or time.

Favorites menu

Selected Diagnostics functions can be called up directly from the measuring mode using a softkey. The following table (Pg 37) explains how to select favorites.

Further functions which can be controlled via softkey:

- Parameter set
- KI recorder

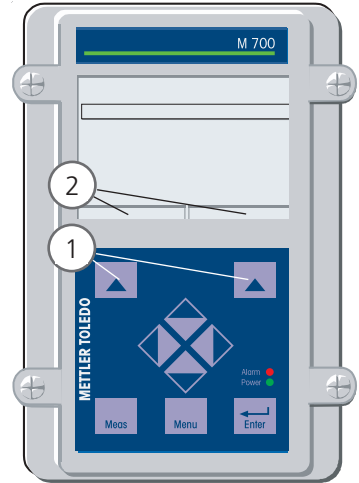

| | | | |
|---|----------------------------------|-----------------------|---------|
| HOLD | Cal | 7.00 pH | 25.6 °C |
| Function control matrix (Administrator) | | | |
| | ParSet | KI rec. | ♥Fav |
| Input OK2 | <input type="radio"/> | <input type="radio"/> | - |
| Left softkey | <input checked="" type="radio"/> | <input type="radio"/> | - |
| Right softkey | <input type="radio"/> | <input type="radio"/> | - |
| Profibus DO 2 | <input type="radio"/> | <input type="radio"/> | - |
| Unical | | | |
| Return | Connect | | |

Example:



"Parameter set" to be selected with "Left softkey"

To select a softkey function:

Select desired function using arrow keys, press "Connect" softkey and confirm with **enter**.

Deselect function:

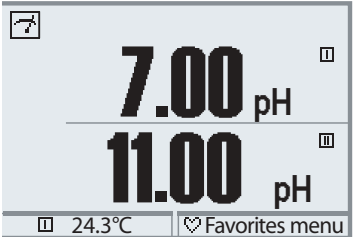
Press "Disconnect" softkey, confirm with **enter**.

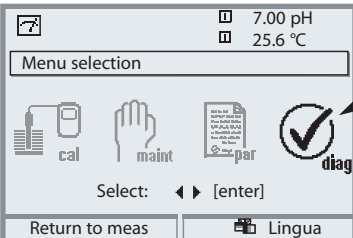
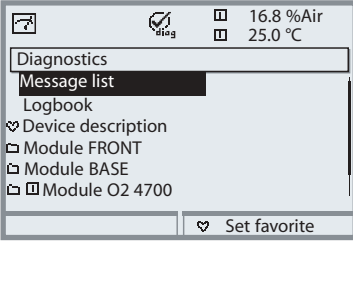
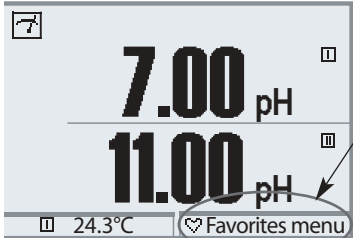
| Menu | Display | Select favorites |
|---|---|--|
| |  | <p>Favorites menu</p> <p>Diagnostics functions can be called up directly from the measuring mode using a softkey.</p> <p>The “Favorites” are selected in the Diagnostics menu.</p> |
|  |  | <p>Select favorites</p> <p>Press menu key to select menu.</p> <p>Select diagnostics using arrow keys, confirm with enter.</p> |
| |  | <p>Set/delete favorite:</p> <p>“Set favorite” allows activation of the selected diagnostic function directly from the measuring mode via softkey. The respective function is marked with a heart icon.</p> <p>(See Softkey usage, Pg 36)</p> |
| |  | <p>Pressing the meas key returns to measurement. When the softkey has been assigned to “Favorites”, “Favorites menu” is read in the secondary display (see Softkey usage, Pg 36).</p> |

Note:

When one of the softkeys has been assigned to the “Favorites menu” function, diagnostic functions which have been set as “Favorite” can be directly called up from the measuring mode.

Diagnostics functions: Overview

Selected diagnostics functions for quality management

Diagnostics functions (quality management, ISO 9000)

To meet the quality management requirements to ISO 9000, the M 700 provides comprehensive diagnostics and safety functions such as Sensocheck sensor monitoring and CalCheck monitoring of calibration ranges, a logbook for time- and date-stamped recording of function activations, warning and failure messages. Further features are:

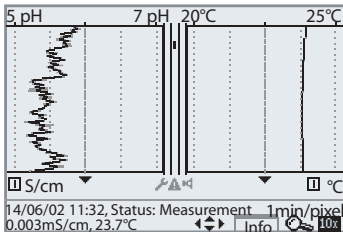

2-channel measurement recorder

Can be called up directly from the measuring mode. Allows detailed evaluation of events by placing the cursor on measured values of interest.

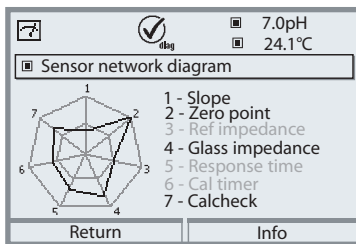

Sensor network diagram

(pH 2700, O2 4700 modules)

Graphical representation of the sensor parameters in a network diagram – with slope, zero, reference impedance, glass impedance, response time, calibration timer, deviation from calibration range (Calcheck).

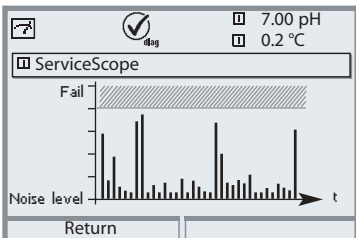

ServiceScope

(PH module)

Displays the noise levels over the time. Allows distinction of individual disturbances, periodic and broadband disturbances, which is helpful for troubleshooting.

An error message is generated if the noise level exceeds the failure limit.

Diagnostics functions: Sensoface 😊

Graphical indication of sensor condition

Sensocheck must have been activated during parameter setting



Sensocheck - Sensor monitoring

| Module | Sensocheck function |
|------------|---|
| O2 4700: | Monitoring membrane/electrolyte |
| Cond 7700: | Information on sensor condition |
| pH 2700: | Automatic monitoring of glass and reference electrode |



The “smileys” provide information on wear and required maintenance of the sensor (“friendly” - “neutral” - “sad”).

| Menu | Display | Activate Sensocheck |
|------|---|---|
| | <p>Menu selection</p> <p>Select: ◀ ▶ [enter]</p> <p>Return to meas Lingua</p> | <p>Open menu selection Select parameter setting Enter passcode (Administrator)</p> |
| | <p>Parameter setting (Administrator)</p> <ul style="list-style-type: none"> System control M 700 FRONT 700-011 M 700 BASE 700-021 Module O2 4700 Module pH 2700 <p>Return</p> | <p>Select module (“pH 2700” or “O2 4700”)</p> <p>Confirm with enter.</p> |
| | <p>Sensocheck Ref el (Administrator)</p> <p>Nominal 005.0 kOhm Min 003.1 kOhm Max 100.0 kOhm</p> <p>Message: Off, Failure, Maint.request</p> <p>Abort OK</p> | <p>Select “Sensor data”. Confirm with enter. Then select “Sensocheck Ref el” (Fig.)</p> <p>Assign function and confirm with enter.</p> |

Diagnostics functions

General status information of the measuring system

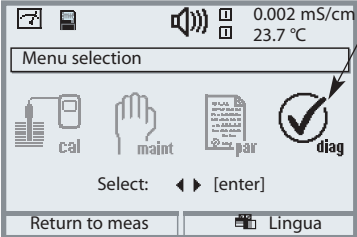
Select menu: Diagnostics

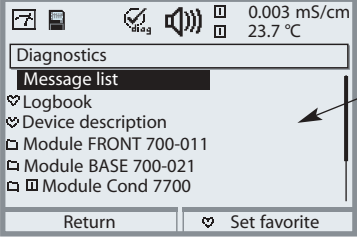
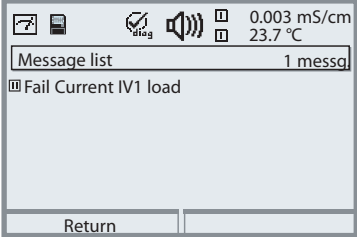
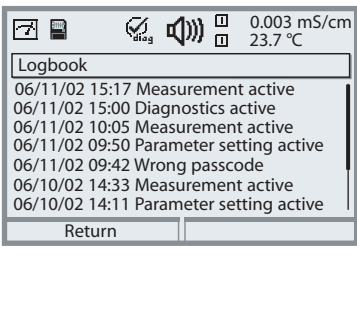
| Menu | Display | Diagnostics functions |
|---|---|--|
| |  | <p>Call up diagnostics</p> <p>From the measuring mode: Press menu key to select menu. Select diagnostics using arrow keys, confirm with enter.</p> |
|  |  | <p>The "Diagnostics" menu gives an overview of all functions available. Functions which have been set as "Favorite" can be directly accessed from the measuring mode (see Pg 37).</p> |
| |  | <p>Message list</p> <p>Shows the currently activated warning or failure messages in plain text.</p> |
| |  | <p>Logbook</p> <p>Shows the last 50 events with date and time, e.g. calibrations, warning and failure messages, power failure etc. This permits quality management documentation to ISO 9000.</p> <p>Extended logbook: SmartMedia card (SW 700-104)</p> |

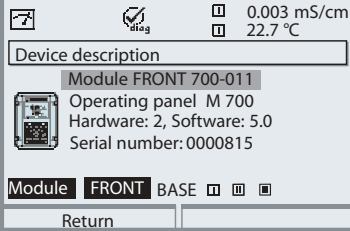
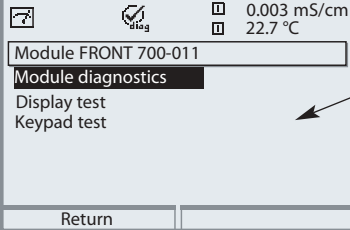
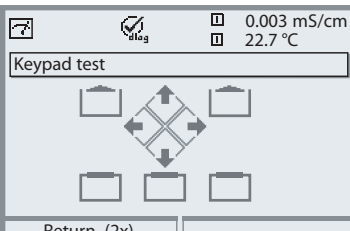
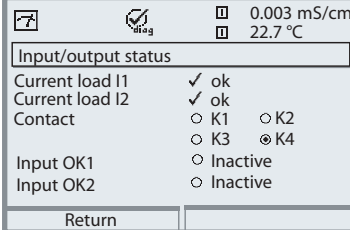
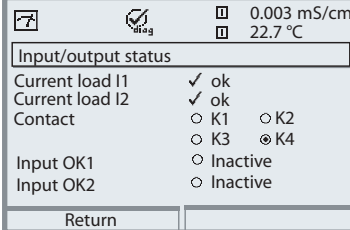
| Menu | Display | Diagnostics functions |
|---|--|---|
|  ddiag |  <p>0.003 mS/cm 22.7 °C</p> <p>Device description</p> <p>Module FRONT 700-011</p> <p>Operating panel M 700 Hardware: 2, Software: 5.0 Serial number: 0000815</p> <p>Module FRONT BASE</p> <p>Return</p> | <p>Device description</p> <p>Provides information about all modules installed: Module type and function, serial number, hardware and software version and device options (Example: FRONT).</p> |
| |  <p>0.003 mS/cm 22.7 °C</p> <p>Module FRONT 700-011</p> <p>Module diagnostics</p> <p>Display test Keypad test</p> <p>Return</p> | <p>M 700 FRONT</p> <p>The module the display and keypad control. Test possibilities:</p> <ul style="list-style-type: none"> • Module diagnostics • Display test • Keypad test <p>Example: M 700 FRONT, keypad test. Correct functioning of each key can be checked by pressing it down.</p> |
| |  <p>0.003 mS/cm 22.7 °C</p> <p>Keypad test</p> <p>Return (2x)</p> | |
| |  <p>0.003 mS/cm 22.7 °C</p> <p>Module BASE 700-021</p> <p>Module diagnostics</p> <p>Input/output status</p> <p>Return Set favorite</p> | <p>M 700 BASE</p> <p>The module generates the standard output signals. Test possibilities:</p> <ul style="list-style-type: none"> • Module diagnostics • Input/output status <p>Example: M 700 BASE, input/output status.</p> |
| |  <p>0.003 mS/cm 22.7 °C</p> <p>Input/output status</p> <p>Current load I1 ✓ ok Current load I2 ✓ ok Contact ○ K1 ○ K2 ○ K3 ● K4 Input OK1 ○ Inactive Input OK2 ○ Inactive</p> <p>Return</p> | |

Parameter setting: Operating levels

Viewing level, Operator level, Administrator level

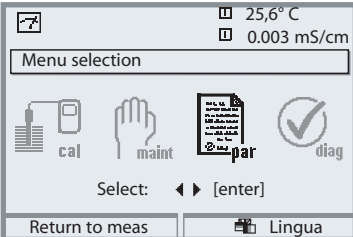
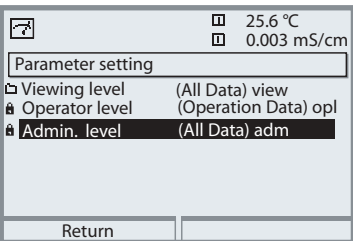
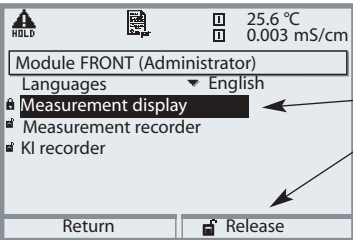
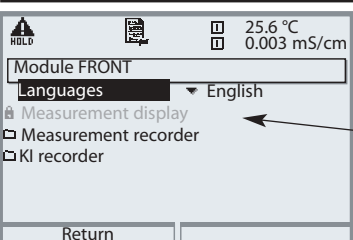

Note: Function check active

| Menu | Display | Viewing level, Operator level, Administrator level |
|---|---|--|
|  |  | <p>Call up parameter setting From the measuring mode: Press menu key to select menu. Select parameter setting using arrow keys, confirm with enter.</p> |
| |  | <p>Administrator level: Access to all functions, also passcode setting. Releasing or blocking a function for access from the Operator level.</p> |
| |  | <p>Functions which can be blocked for the Operator level are marked with the "lock" symbol. The functions are released or blocked using the softkey.</p> |
| |  | <p>Operator level: Access to all functions which have been released at the Administrator level. Blocked functions are displayed in gray and cannot be edited (Fig.).</p> <p>Viewing level Display of all settings. No editing possible!</p> |

Parameter setting: Lock functions

Administrator level: Enable / lock functions for Operator level

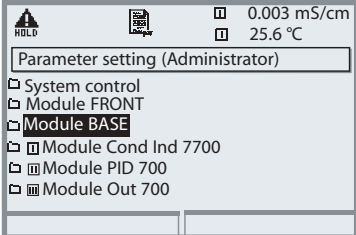
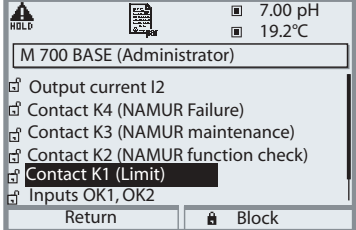
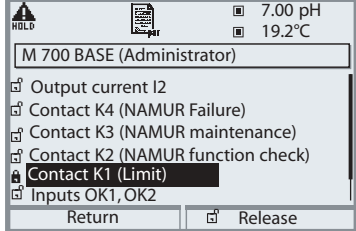
Note: Function check active

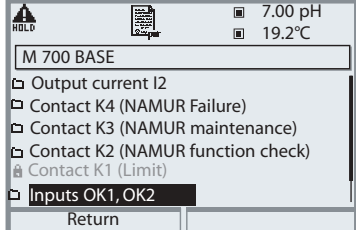
| Menu | Display | Administrator level: Enable / lock functions |
|---|---|--|
|  |  | <p>Example: Blocking access to the configuration of relay contact K1 (M 700 BASE) from the Operator level</p> <p>Call up parameter setting Select Administrator level. Enter passcode (1989). Select "M 700 BASE" with arrow keys, confirm with enter.</p> |
| |  | <p>Select "Contact K1" with arrow keys, "Block" with softkey.</p> |
| |  | <p>Now, the "Contact K1" line is marked with the "lock" icon. This function cannot be accessed from the Operator level any more. The softkey function changes to "Release".</p> |
|  |  | <p>Call up parameter setting Select <u>Operator</u> level, passcode (1246), select "M 700 BASE". The locked "Contact K1" function is displayed in gray and marked with the lock icon.</p> |

Function control matrix, time/date

Select menu: Parameter setting/System control

Note: Function check active

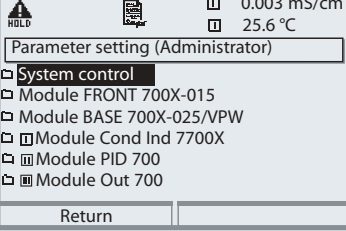
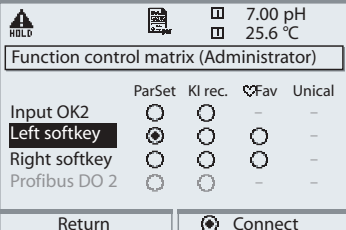
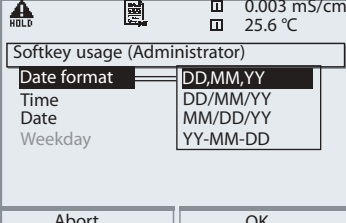
| Menu | Display | Function control matrix, time/date |
|---|---|--|
|  |  | <p>Call up parameter setting Select Administrator level. Enter passcode (1989). Select system control using arrow keys, confirm with enter.</p> <p>Submenus of system control:</p> <ul style="list-style-type: none"> • Parameter sets • Function control matrix • Time/date • Point of measurement • Release of options • Factory setting • Passcode entry • Software update ... more, depending on Options. |
| |  | <p>Function control matrix Clear assignment of function (parameter sets, KI recorder, Favorites menu, Unical control) to control element (optocoupler, softkey or Profibus).</p> |
| |  | <p>Time/date Selection of date format, adjustment of time and date</p> |

Point of measurement, passcodes, release of options

Select menu: Parameter setting/System control

Note: Function check active

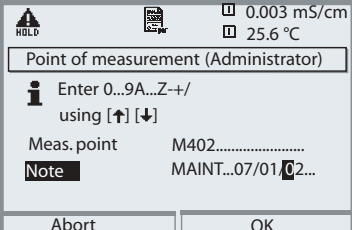
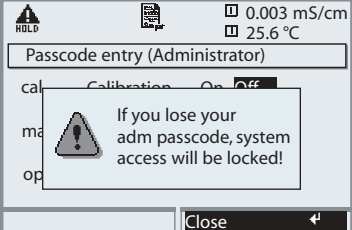
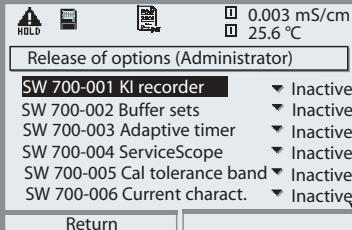
| Menu | Display | Point of measurement, passcode entry, release of options | | | | | | | | | | | | |
|---|---|---|-------------|-------|------|-------------|---------|------|----------------|-------|------|---------------------|-------|------|
|  |  | <p>Point of measurement</p> <p>You can enter a tag number or notes (e.g. date of last maintenance).</p> | | | | | | | | | | | | |
| |  | <p>Passcode entry</p> <p>When this menu is opened, the analyzer displays a warning (Fig.).</p> <p>Passcodes (factory settings):</p> <table border="0"> <tr> <td>Calibration</td> <td>(cal)</td> <td>1147</td> </tr> <tr> <td>Maintenance</td> <td>(maint)</td> <td>2958</td> </tr> <tr> <td>Operator level</td> <td>(opl)</td> <td>1246</td> </tr> <tr> <td>Administrator level</td> <td>(adm)</td> <td>1989</td> </tr> </table> <p>Caution</p> <p>If you lose the Administrator passcode, system access is locked!</p> | Calibration | (cal) | 1147 | Maintenance | (maint) | 2958 | Operator level | (opl) | 1246 | Administrator level | (adm) | 1989 |
| Calibration | (cal) | 1147 | | | | | | | | | | | | |
| Maintenance | (maint) | 2958 | | | | | | | | | | | | |
| Operator level | (opl) | 1246 | | | | | | | | | | | | |
| Administrator level | (adm) | 1989 | | | | | | | | | | | | |
| |  | <p>Release of options</p> <p>When you have purchased an option to be released via TAN:</p> <ul style="list-style-type: none"> • Parameter setting, Administrator • System control • Select "Release of options" <p>Set option to "active". Enter the TAN at the prompt. The option is available after the TAN has been entered.</p> | | | | | | | | | | | | |

Inserting the SmartMedia card

To release an additional function via TAN, see Pg 45, Release of options

Inserting the SmartMedia card

Please note when inserting the SmartMedia card:

The SmartMedia card may be inserted or replaced with the power supply switched on. Protect against electrostatic discharge! When closing the device, make sure that the sealing is properly seated and clean.

Warning!

Do not touch the terminal compartment, there may be dangerous contact voltages!



To open the analyzer

- Loosen the 4 front screws
- Open the M 700 FRONT at its right side (pivot hinge inside at the left)
- The slit for inserting the SmartMedia card is located at the inner side of the M 700 FRONT

To insert the SmartMedia card

- Remove SmartMedia card from its package without touching the contact surface
- Insert card in the slit at the inner side of the M 700 FRONT



Inserting the SmartMedia card:

The label must be facing you.

To remove the SmartMedia card

- "Close memory card" (Maintenance menu)
To avoid data loss, please call up the Maintenance menu.
"Close memory card" to terminate software access to the SmartMedia card.
Now the card can be taken out.

SmartMedia card: Application

Use as memory card in combination with additional functions.
Additional functions must be ordered separately (release via TAN).

Types of SmartMedia cards

The SmartMedia cards are delivered from the manufacturer as

- Software update (SW 700-106, see Pg 52)
- Memory card (additional function SW 700-1xx, see Pg 56)

Using commercially available SmartMedia cards

Commercially available SmartMedia cards can be used as memory card (Software updates are supplied by the manufacturer and are device-specific).

The following types of cards are supported: 8 MB, 16 MB, 32 MB, 64 MB and 128 MB storage capacity. Externally produced files, such as from a digital camera, are tolerated. Long file names can be read. The M 700 generates file names in the 8.3 format (8 characters file name, 3 characters program-specific file name extension).

Formatting a commercial SmartMedia card

Some devices (e.g. digital cameras, scanners) cause a formatting of the SmartMedia card which does not correspond to the SSFDC specification or the SmartMedia Interface Library (SMIL). The manufacturer therefore recommends to format a commercial SmartMedia card as M 700 memory card prior to first use.

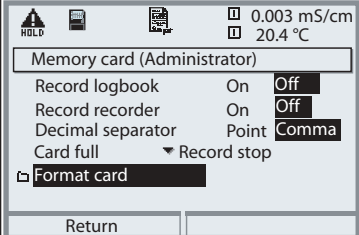
| Menu | Display | Formatting a SmartMedia card |
|---|---|--|
|  |  | <p>Format card</p> <ul style="list-style-type: none"> • Insert SmartMedia card (Pg 46) • Open menu selection • Parameter setting, Admin. level • Enter passcode • System control: Memory card (The "Memory card" function is only available with the SmartMedia Card inserted!) • Format card |

System control: Parameter sets A, B

Parameter setting/System control/Parameter sets

Parameter sets A, B

2 complete parameter sets (A, B) can be stored in the analyzer.

An icon in the measurement display shows which parameter set is active:

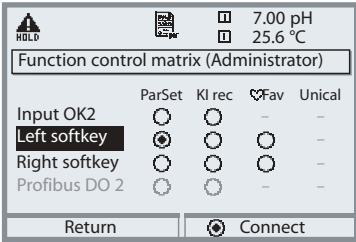
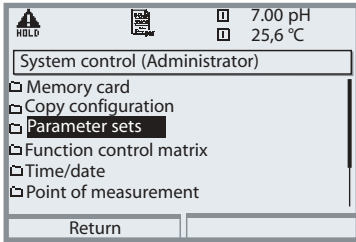
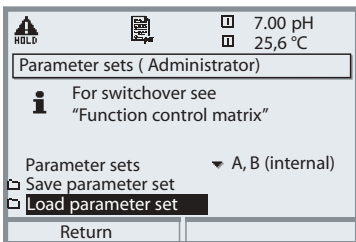

Select "Parameter setting/System control/function control matrix" to select the control element for switching between the parameter sets (optocoupler, softkey or PROFIBUS). The currently activated set can be signaled by a relay contact (see Pg 69).

| Menu | Display | Parameter sets |
|---|---|--|
|  |    | <p>Select control element for switching between the parameter sets</p> <ul style="list-style-type: none"> • Call up Menu selection • Select Parameter setting, Administrator level • Enter passcode • System control • Select "Function control matrix" <p>Parameter sets A, B</p> <ul style="list-style-type: none"> • Call up Menu selection • Select Parameter setting, Administrator level • Enter passcode • System control • Select "Parameter sets", confirm with enter. <ul style="list-style-type: none"> • Save parameter set The active parameter set A overwrites the internal parameter set B • Load parameter set Parameter set B is loaded |

SmartMedia card: Parameter sets

Parameter setting/System control/Parameter sets

Note: Additional function SW 700-102 required.

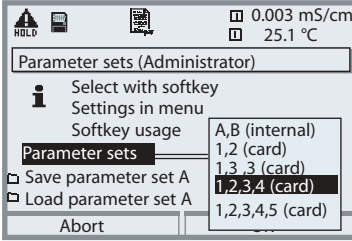
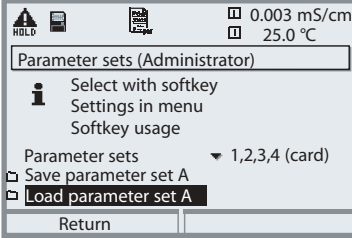
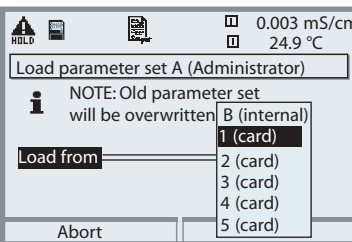
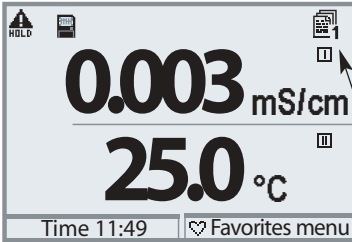
| Menu | Display | Load parameter set from SmartMedia card |
|---|--|---|
|  |     | <h3>Loading a parameter set from SmartMedia card</h3> <ul style="list-style-type: none"> • Call up parameter setting • System control • Call up "Parameter sets" (Fig) <p>The M 700(X) provides 2 complete parameter sets (A, B). 5 parameter sets can be stored on the SmartMedia card. One of those can be saved as parameter set A to the analyzer:</p> <div data-bbox="602 916 1081 1247" data-label="Diagram"> </div> <ul style="list-style-type: none"> • Select parameter set to be loaded <p>Activated parameter set is displayed in measuring mode.</p> <p>Note: Remote switching between A and B is possible via the OK2 input.</p> |

SmartMedia card: Parameter sets

Parameter setting/System control/Parameter sets

Note: Additional function SW 700-102 required.

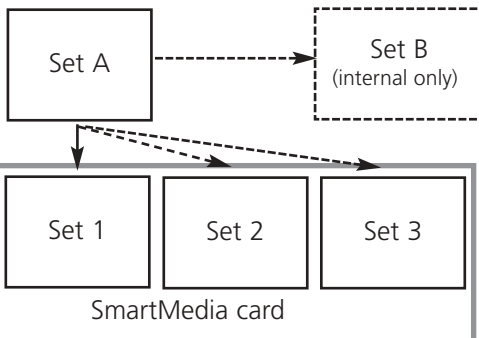
| Menu | Display | Saving parameter set on SmartMedia card |
|---|---|--|
|  | <p>Parameter sets (Administrator)</p> <p>Select with softkey Settings in menu Softkey usage</p> <p>Parameter sets: A,B (internal), 1,2 (card), 1,3,3 (card), 1,2,3,4 (card), 1,2,3,4,5 (card)</p> <p>Save parameter set A Load parameter set A</p> <p>Abort</p> <p>Parameter sets (Administrator)</p> <p>Select with softkey Settings in menu Softkey usage</p> <p>Parameter sets: 1,2,3,4 (card)</p> <p>Save parameter set A Load parameter set A</p> <p>Return</p> <p>Save parameter set A (Administrator)</p> <p>NOTE: Old parameter set will be overwritten</p> <p>Save to: B (internal), 1 (card), 2 (card), 3 (card), 4 (card), 5 (card)</p> <p>Abort</p> | <p>To save a parameter set on SmartMedia card</p> <ul style="list-style-type: none"> • Call up parameter setting • System control • Call up “Parameter sets” (Fig) <p>The M 700(X) provides 2 complete parameter sets (A, B). Up to 5 parameter sets can be loaded to the SmartMedia card. To do so, a parameter set (1, 2, 3, 4, or 5) of the SmartMedia card is overwritten by the M 700(X) parameter set A.</p> <ul style="list-style-type: none"> • Select parameter set on SmartMedia card  <p>The diagram illustrates the relationship between parameter sets. Set A and Set B (internal only) are shown as boxes. Dashed arrows point from Set A to Set 1, Set 2, and Set 3 on the SmartMedia card. A solid arrow points from Set B to Set 1. The SmartMedia card is represented as a container holding Set 1, Set 2, and Set 3.</p> |

SmartMedia card: Memory card

Parameter setting/System control/Memory card

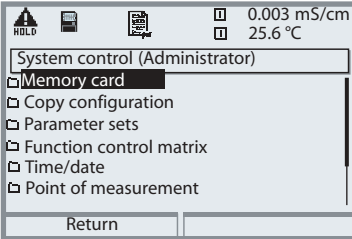
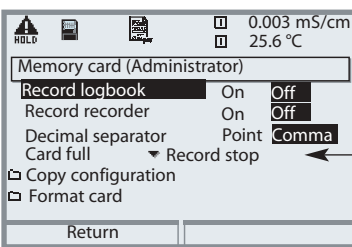
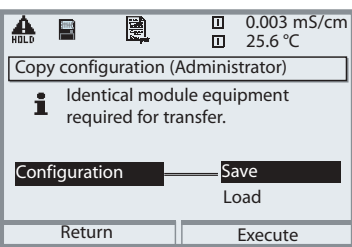
| Menu | Display | Using the memory card |
|---|--|--|
|  |   | <p>To use the memory card</p> <ul style="list-style-type: none"> • Insert SmartMedia card • Open menu selection • Parameter setting, Admin. level • Enter passcode • System control: Memory card <p>With SmartMedia card inserted, the display shown on the left appears (The “Memory card” line is displayed only if there really is a memory card in the slot).</p> <ul style="list-style-type: none"> • Select “Memory card”, confirm with enter. <p>The menu is self-explanatory.</p> <p>Behavior when the memory card is full:</p> <p>Continuous recording (as with a flight recorder) or Stop (card replacement).</p> |
| |  | <p>Copy configuration</p> <ul style="list-style-type: none"> • Save: Saving all data on the memory card • Load: Overwriting all device data with the data from the memory card <p>Caution! “Close” memory card before removing it (Maintenance menu)</p> |

SmartMedia card: Software update

Parameter setting/System control/Release of options

Additional functions must be ordered separately (release via TAN).

Additional function SW 700-106: Software update

For a software update (additional function SW 700-106), the manufacturer supplies a specially formatted SmartMedia card. The M 700 replaces its own firmware (operating program) by the new version ("Update").

Caution!

During a software update the analyzer is not operable!

After a software update you should check the configuration.

This icon indicates that a SmartMedia card is inserted in the slot.



The update card allows loading of new software into the device as well as storing of current device software on the card.

A memory card can be generated by formatting an update card (irreversible!). Formatting erases the update.

SmartMedia-Card: Software update

Parameter setting/System control/Software update/Load firmware

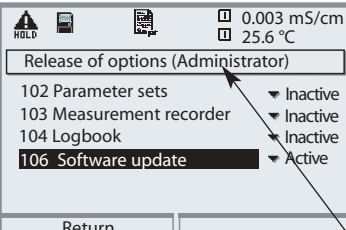
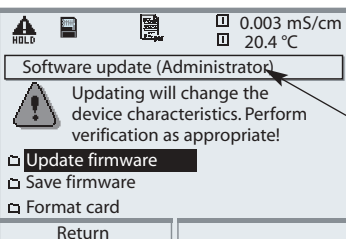
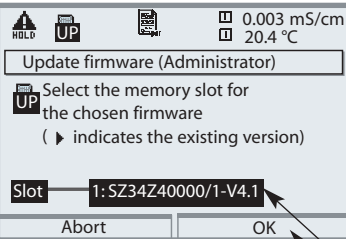
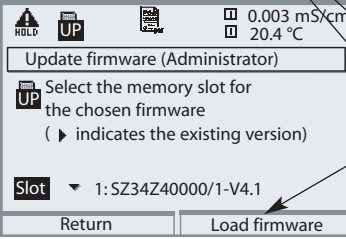

Note: Function check active

| Menu | Display | Software update ("Load firmware") |
|---|---|---|
|  |  | <p>Software update</p> <ul style="list-style-type: none"> • Insert SmartMedia card (Pg 46) • Open menu selection • Parameter setting, Admin. level • Enter passcode • Select System control |
| |  | <p>1: Select "Release of options" (Software update SW 700-106) Set option to "active". Enter the TAN at the prompt. The option is available after the TAN has been entered.</p> <p>2: Select "Software update" Check whether your unit really requires a software update! To read the current software version, select:</p> |
| |  | <p>• Diagnostics</p> <p>• Device description</p> <p>• M 700 FRONT</p> <p>Perform update:</p> <ul style="list-style-type: none"> • Parameter setting • System control • Software update • Select slot • Confirm slot with "OK". |
| |  | <ul style="list-style-type: none"> • Press "Load firmware" softkey to start software update. |

SmartMedia card: Save firmware

Parameter setting/System control/Software update/Save firmware

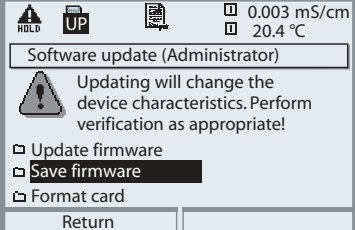
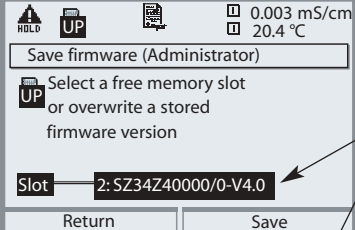
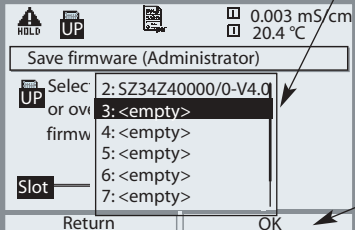
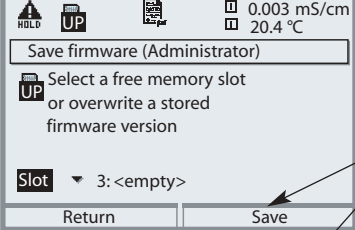
Note: Function check active

| Menu | Display | Save firmware on software update card |
|---|--|---|
|  |  <p>Software update (Administrator)</p> <p>Updating will change the device characteristics. Perform verification as appropriate!</p> <ul style="list-style-type: none"> Update firmware Save firmware Format card <p>Return</p> | <p>Save firmware</p> <ul style="list-style-type: none"> • Insert SmartMedia card (Pg 46) • Open menu selection • Parameter setting, Admin. level • Enter passcode • System control: Software update |
| |  <p>Save firmware (Administrator)</p> <p>Select a free memory slot or overwrite a stored firmware version</p> <p>Slot 2: SZ34Z40000/0-V4.0</p> <p>Return Save</p> | <p>Select a free memory slot on the card:</p> <ul style="list-style-type: none"> • Select slot with ► key • Select free slot with arrow key. |
| |  <p>Save firmware (Administrator)</p> <p>Select or overwrite firmware</p> <ul style="list-style-type: none"> 2: SZ34Z40000/0-V4.0 3: <empty> 4: <empty> 5: <empty> 6: <empty> 7: <empty> <p>Slot 3: <empty></p> <p>Return OK</p> | <ul style="list-style-type: none"> • Confirm slot with "OK". |
| |  <p>Save firmware (Administrator)</p> <p>Select a free memory slot or overwrite a stored firmware version</p> <p>Slot 3: <empty></p> <p>Return Save</p> | <p>Start with "Save" softkey.</p> |
| |  <p>Save successful</p> | <p>Confirm finish message (with "OK" or enter).</p> <p>Remove the SmartMedia card.</p> <p>Close the front door.</p> |

SmartMedia card: Format card

Parameter setting/System control/Format card

Note: Function check active

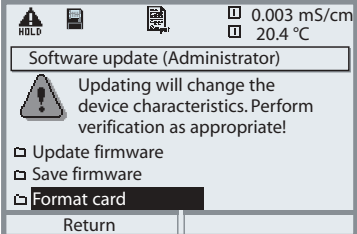
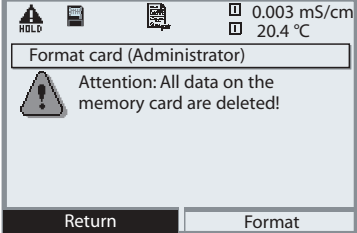
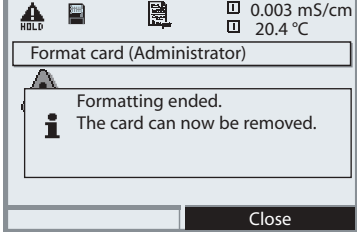
| Menu | Display | Format card (Generate memory card) |
|---|--|--|
|  |  <p>Software update (Administrator)</p> <p>Updating will change the device characteristics. Perform verification as appropriate!</p> <ul style="list-style-type: none"> <input type="checkbox"/> Update firmware <input type="checkbox"/> Save firmware <input checked="" type="checkbox"/> Format card <p>Return</p> | <p>To format the card</p> <ul style="list-style-type: none"> • Insert SmartMedia card (Pg 46) • Open menu selection • Parameter setting, Admin. level • Enter passcode • System control: Format card |
| |  <p>Format card (Administrator)</p> <p>Attention: All data on the memory card are deleted!</p> <p>Return Format</p> | <p>Caution!</p> <p>Formatting an update card generates a memory card. Refer to "SmartMedia card", Pg 47.</p> <p>This process is irreversible!</p> |
| |  <p>Format card (Administrator)</p> <p>Formatting ended. The card can now be removed.</p> <p>Close</p> | <p>Double warning messages protect against faulty operation.</p> <p>Finish message. The memory card is ready for recording.</p> |



- ▼  LOGBOOK
 - L_021000.TXT
- ▼  PARASET
 - SET 1
 - SET 2
- ▼  RECORDER
 - R_031211.TXT
 - R_031212.TXT
 - R_031213.TXT
 - R_031214.TXT
 - R_031215.TXT
 - R_031216.TXT

Figure:

File structure of a memory card (example)

Note:

The SmartMedia card must always be formatted in the M 700.

Correct functioning of a SmartMedia card with different formatting cannot be guaranteed.

SmartMedia card: Remove card

Maintenance/removing memory card

Note: Function check active

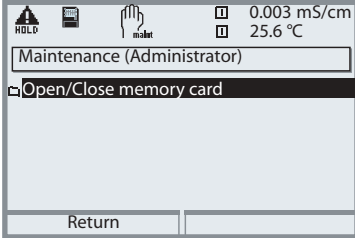
| Menu | Display | Close memory card |
|---|---|--|
|  |  <p>The screenshot shows a maintenance menu with the following elements: a top status bar with 'HOLD', a 'maint' icon, and two data points (0.003 mS/cm and 25.6 °C); a main menu area with 'Maintenance (Administrator)' and 'Open/Close memory card' (highlighted); and a 'Return' button at the bottom.</p> | <p>Caution! “Close” memory card before removing it (Maintenance menu) Otherwise you risk losing data.</p> <p>Remove memory card</p> <ul style="list-style-type: none"> • Insert SmartMedia card (Pg 46) • Open menu selection • Maintenance, Open/close memory card • “Close” memory card <p>Close memory card terminates software access to the SmartMedia card. Must be executed before removing the card from the SmartMedia card slot to prevent data loss.</p> |

Factory setting, logbook

Parameter setting/System control/Logbook

Note: Function check active

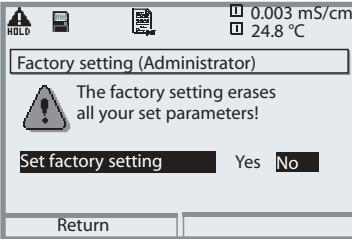
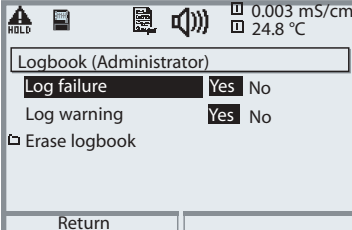
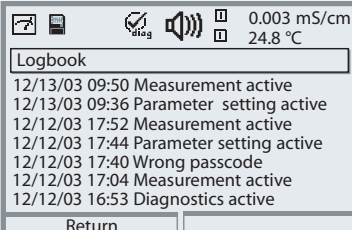
| Menu | Display | Factory setting, logbook |
|---|---|--|
|  |  | <p>Factory setting</p> <p>When this menu is opened, the analyzer displays a warning (Fig.).</p> <ul style="list-style-type: none"> For factory settings, see module description <p>(Free download available at: www.mtpro.com)</p> |
| |   | <p>Logbook</p> <p>Select which messages are to be logged in the logbook. The last 50 events are recorded with date and time.</p> <p>This permits quality management documentation to ISO 9000.</p> <p>The logbook can be called up from the diagnostics menu (Fig.).</p> <p>Additional function SW 700-104: Extended logbook for recording data on SmartMedia card (TAN).</p> |

Language, measurement display, viewing angle

Select menu: Parameter setting/M 700 FRONT

Note: Function check active

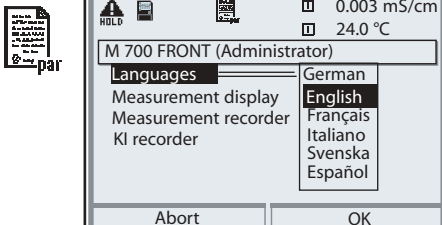
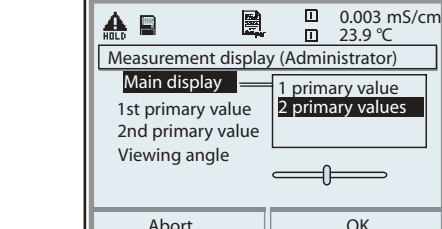
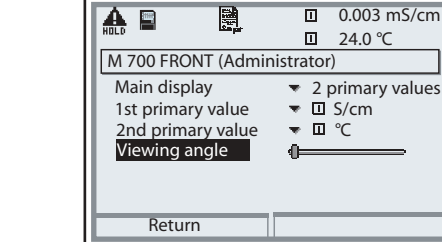
| Menu | Display | Language, measurement display, viewing angle |
|--|---|--|
|  | <p>Language setting</p> <ul style="list-style-type: none"> • Call up parameter setting • Select M 700 FRONT • Call up "Language" | |
|  | <p>Measurement display</p> <ul style="list-style-type: none"> • Call up parameter setting • Select M 700 FRONT • Call up "Measurement display" • Select number and type of values to be displayed | |
|  | <p>Viewing angle</p> <ul style="list-style-type: none"> • Call up parameter setting • Select M 700 FRONT • Call up "Measurement display" • Adjust display to local light conditions • Confirm with enter | |

Current outputs, contacts, OK inputs

Select menu: Parameter setting/M 700 BASE

Note: Function check active

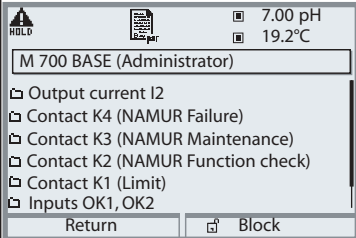
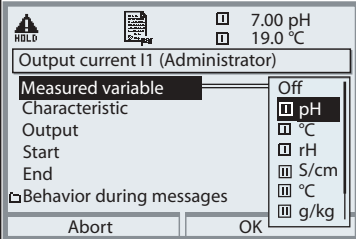
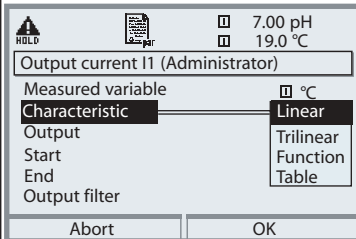
| Menu | Display | Parameter setting M 700 BASE |
|---|--|---|
|  |  | <ul style="list-style-type: none"> • Call up parameter setting • Enter passcode • Select M 700 BASE • Select "Output current ..." |
| |  | <ul style="list-style-type: none"> • Select measured variable |
| |  | <ul style="list-style-type: none"> • Select Characteristic, e.g. "Linear": The measured variable is represented by a linear output current curve. The desired range of the measured variable is specified by the values for "Start" and "End". |

Assignment of measured values: Start (4 mA) and end (20 mA)

Example 1: Range pH 0 - 14

Example 2: Range pH 5 - 7

Advantage: Higher resolution in range of interest

Output current [mA]

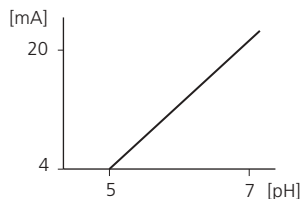
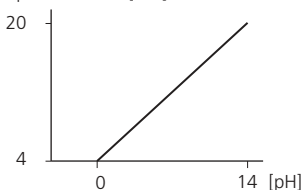

Current outputs: Current output curves

Select menu: Parameter setting/M 700 BASE

- **Linear characteristic**

The measured variable is represented by a linear output current curve.

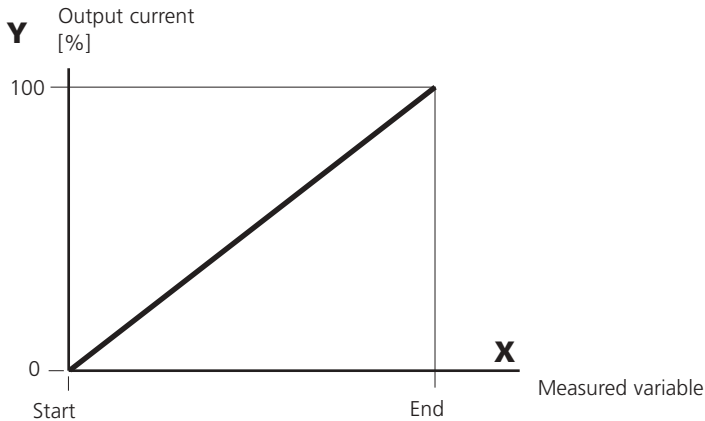

- **Trilinear characteristic**

Two additional corner points must be entered:

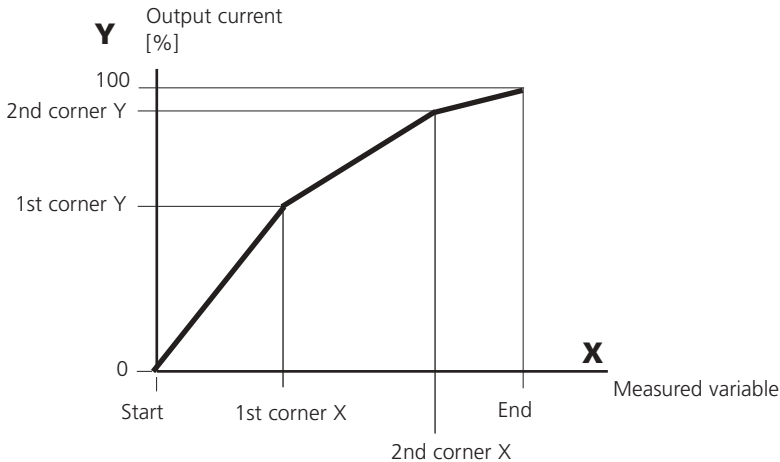

- **Note: Bilinear characteristic**

For a bilinear characteristic, identical parameters are entered for the two corner points (1st corner, 2nd corner).

• **Function characteristic**

Nonlinear output current characteristic: allows measurements over several decades, e.g. for measuring very low values with a high resolution and high values with a low resolution.

Required: Entering a value for 50 % output current.

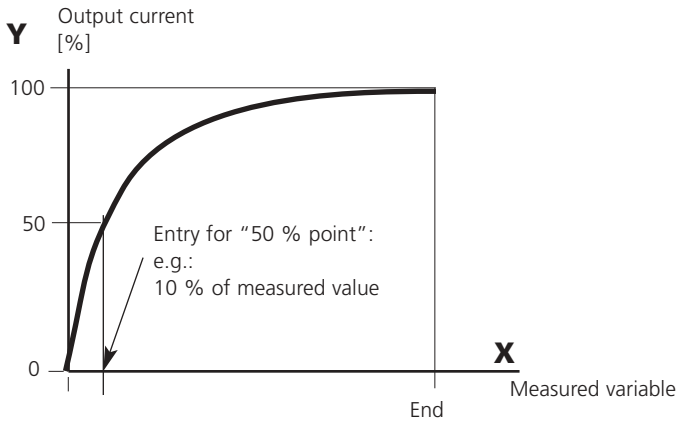

Equation

$$\text{Output current (4 to 20 mA)} = \frac{(1+K)x}{1+Kx} 16 \text{ mA} + 4 \text{ mA}$$

$$K = \frac{E + I - 2 * X50\%}{X50\% - I} \qquad x = \frac{M - I}{E - I}$$

- I:* Initial value at 4 mA
- X50%:* 50% value at 12 mA (output current range 4 to 20 mA)
- E:* End value at 20 mA
- M:* Measured value

Logarithmic output curve over one decade:

- I:* 10 % of maximum value
- X50%:* 31.6 % of maximum value
- E:* Maximum value

Logarithmic output curve over two decades

- I:* 1 % of maximum value
- X50%:* 10 % of maximum value
- E:* Maximum value

Output filter

Time constant.

Time constant of output filter

To smoothen the current output, a low-pass filter with adjustable time constant can be switched on. When there is a jump at the input (100 %), the output level is at 63 % after the time constant has been reached. The time constant can be set from 0 to 120 sec. If the time constant is set to 0 s, the current output follows the input.

Note:

The filter only acts on the current output and the current value of the secondary display, not on the measurement display, the limit values, or the controller!

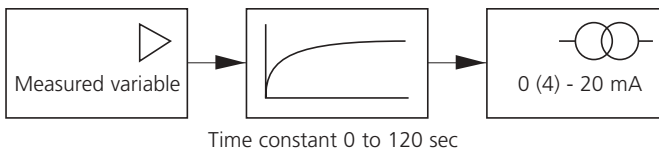

NAMUR signals: Current outputs

Behavior during messages: Function check, 22 mA signal

Behavior during messages

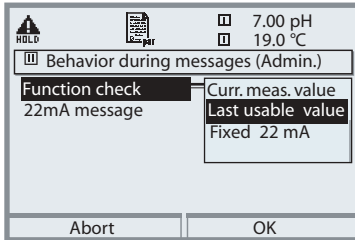

Depending on the parameter setting ("Messages"), the current outputs switch to:

- Currently measured value
- Last measured value (HOLD function)
- Fixed value (22 mA)

In the case of a fault a 22 mA signal can be generated for the selected process variable (1st primary value).

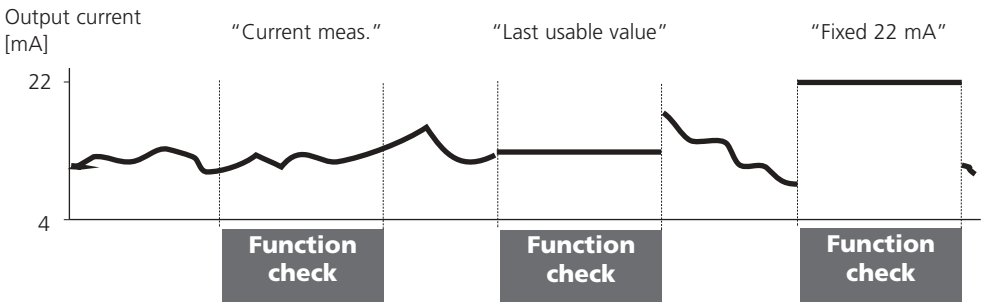

NAMUR signals: Relay contacts

Failure, maintenance request, function check

As delivered, the floating relay outputs of the M 700 BASE are assigned to the NAMUR signals:

- Failure: Contact K4, normally closed contact (signaling current failure)
- Maintenance request: Contact K3, normally open contact
- Function check: Contact K2, normally open contact

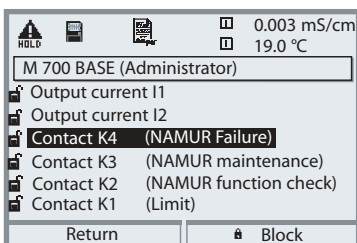

NAMUR signals: Factory setting of contacts

- Select parameter setting
- Select Administrator level
- Select M 700 BASE (Fig.)

You can define a delay time for "Maintenance request" and "Failure", resp.

If an alarm message is released, the contact will only be activated after expiry of this delay time.

Failure is active

when a value has exceeded (or fallen below, resp.) a preset "Failure Limit Hi" or "Failure Limit Lo", when the measured value is out of range or in the event of other failure messages. That means that the equipment no longer operates properly or that process parameters have reached a critical value. Failure is disabled during function check.

Maintenance request is active

when a value has exceeded (or fallen below, resp.) a preset "Warning Limit Hi" or "Warning Limit Lo", or when other warning messages have been activated. That means that the equipment is still operating properly but should be serviced, or that process parameters have reached a value requiring intervention.

Warning is disabled during "Function check".

Function check is active:

- during calibration
- during maintenance (current source, meas. point maintenance)
- during parameter setting at the Operator level and the Administrator level
- during an automatic rinsing cycle.

Relay contacts: Protective wiring

Protective wiring of relay contacts

Relay contacts are subjected to electrical erosion. Especially with inductive and capacitive loads, the service life of the contacts will be reduced. For suppression of sparks and arcing, components such as RC combinations, nonlinear resistors, series resistors and diodes should be used.

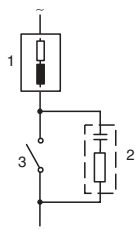
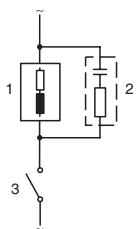

Typical AC applications with inductive load

- 1 Load
 - 2 RC combination, e.g. RIFA PMR 209
- Typical RC combinations
e.g.:
Capacitor 0.1 μF ,
Resistor 100 Ohms / 1 W
- 3 Contact

Warning!

Make sure that the maximum ratings of the relay contacts are not exceeded even during switching!

Information concerning relay contacts

As delivered, the relay contacts are suitable for low signal currents (down to approx. 1mA). If currents above approx. 100 mA are switched, the gold plating is destroyed during the switching process. After that, the contacts will not reliably switch low currents.

Relay contacts

Parameter setting/M 700 BASE/Relay contacts

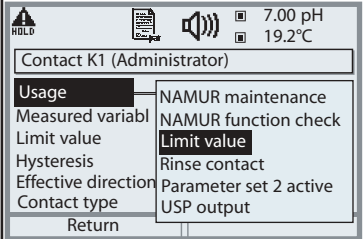
| Menu | Display | Setting the relay contacts |
|---|---|--|
|  |  | <p>Relay contacts, usage</p> <ul style="list-style-type: none"> • Call up parameter setting • Enter passcode • Select M 700 BASE • Select "Contact ..." • "Usage" (Fig.) |

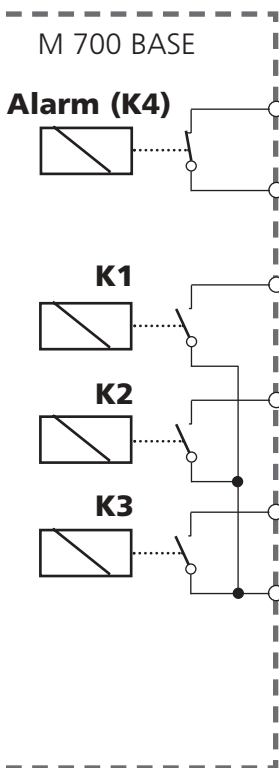

The M 700 BASE provides 4 relay contacts (max. AC/DC rating 30 V / 3 A each). Contact K4 is provided for failure message. The switching behavior (normally open or normally closed), as well as a switch-on or switch-off delay can be defined.

Default settings of the user-definable relay contacts of the M 700 BASE:
 K3: NAMUR maintenance request
 K2: NAMUR function check
 K1: Limit value

The contact assignment K1 - K3 is user defined ("Usage"):

- NAMUR maintenance request
- NAMUR function check
- Limit value
- Rinse contact
- Parameter set 2 active
- USP output (COND 7700 module only)

Contact assignment: See terminal plate M 700 BASE

Limit value, hysteresis, contact type

Parameter setting/M 700 BASE/Relay contacts/Usage

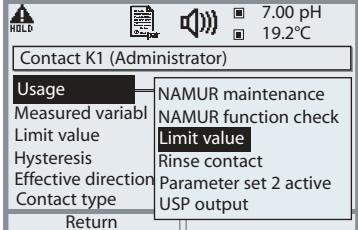
| Menu | Display | Usage as limit value |
|---|---|--|
|  |  | Relay output: Limit value <ul style="list-style-type: none"> • Call up parameter setting • Enter passcode • Select M 700 BASE • Select "Contact ..." • "Usage: Limit value" (Fig.) |

Limit value

Effective direction min

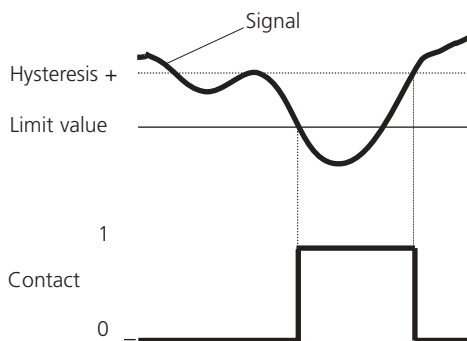

Limit value

Effective direction max

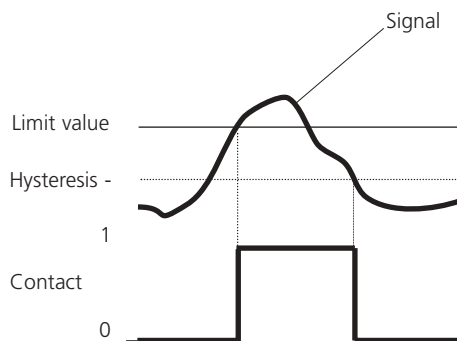

Hysteresis

Tolerance band around the limit value, within which the contact is not actuated. Serves to obtain appropriate switching behavior at the output and suppress slight fluctuations of the measured variable (Fig.)

Contact type

Specifies whether the active contact is closed (N/O) or open (N/C).

OK1, OK2 inputs: Specify level

Parameter setting/M 700 BASE/Inputs OK1, OK2

Note: Function check active

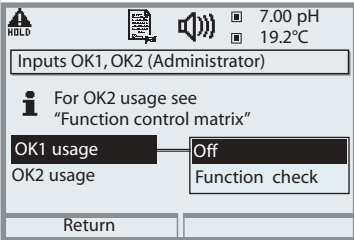
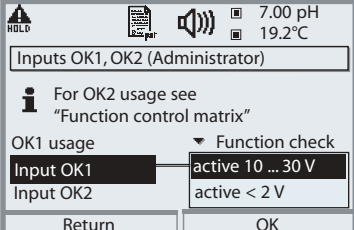
| Menu | Display | Setting the OK inputs |
|---|--|--|
|  |  <p>Inputs OK1,OK2 (Administrator)</p> <p>For OK2 usage see "Function control matrix"</p> <p>OK1 usage: Off</p> <p>OK2 usage: Function check</p> <p>Return</p> | OK1 usage <ul style="list-style-type: none"> • Call up parameter setting • Enter passcode • Select M 700 BASE • Select "Inputs OK1/OK2" • Select "OK1 usage" |
| |  <p>Inputs OK1,OK2 (Administrator)</p> <p>For OK2 usage see "Function control matrix"</p> <p>OK1 usage: active 10 ... 30 V</p> <p>Input OK2: active < 2 V</p> <p>Return OK</p> | OK1/OK2 switching level <ul style="list-style-type: none"> • Call up parameter setting • Enter passcode • Select M 700 BASE • Select "Inputs OK1/OK2" • Specify active switching level |

The M 700 BASE provides 2 digital inputs (OK1, OK2). The following functions (depending on the parameter setting) can be started via a control signal:

- OK1: "Off" or "Function check"
- OK2: For selection, see Pg 36, System control menu/Function control matrix. ("Off", "Parameter set A/B", "Start KI recorder")

The switching level for the control signal must be specified:
(active 10...30 V or active > 2 V).

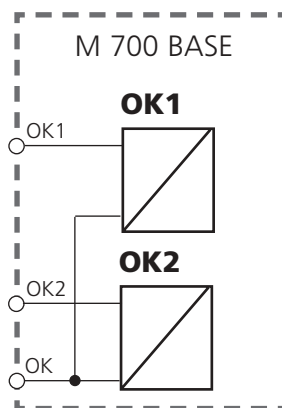

Contact assignment:
See terminal plate
M 700 BASE

Switching parameter sets via OK2

Parameter setting / System control / Function control matrix

Note: Function check active

Parameter sets

2 complete parameter sets (A, B) can be stored in the M 700.

You can switch between the parameter sets using the OK2 input.

The currently activated set can be signaled by a relay contact. An icon in the measurement display shows which parameter set is active:  or 

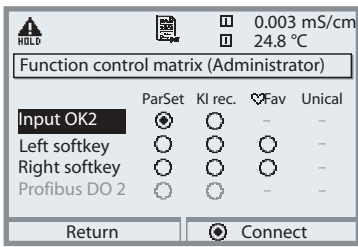
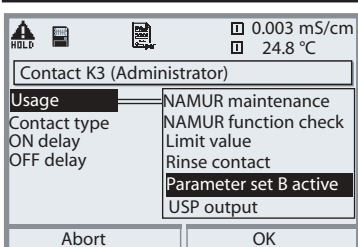
| Menu | Display | Parameter sets |
|---|--|---|
|  |  | <p>Select parameter set (A, B) via input OK2</p> <ul style="list-style-type: none"> • Call up parameter setting • System control • Function control matrix • Select "OK2" • Connect "Parameter set A/B" |
| |  | <p>Signal active parameter set via relay contact</p> <ul style="list-style-type: none"> • Call up parameter setting • M 700 BASE • Select contact • Usage: "Parameter set ...". |

Note

The selection has no effect when working on SmartMedia card with SW 700-102.

Calculation Blocks

Select menu: Parameter setting/System control/Calculation Blocks
Calculation of new variables from measured variables

Calculation Blocks

Two measuring modules with all their measured values serve as input for the calculation block. In addition, the general device status (NAMUR signals) is taken into account. The following variables are calculated from the existing values:

- Ratio
- Pass (passage)
- Reject (rejection)
- Measured-value difference
- Deviation
- pH value calculation by means of dual conductivity measurement

These output variables are then available in the system and can be assigned to the outputs (current, limit values, display ...)

Functionality of measuring module

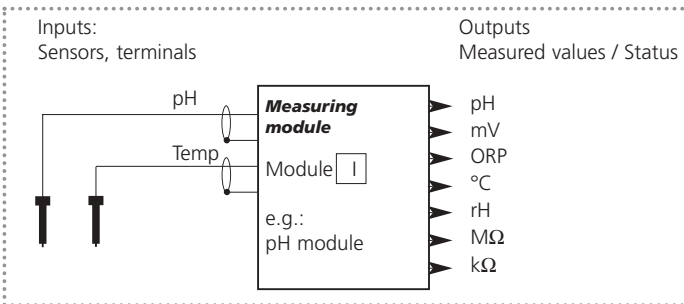

Functionality of Calculation Block

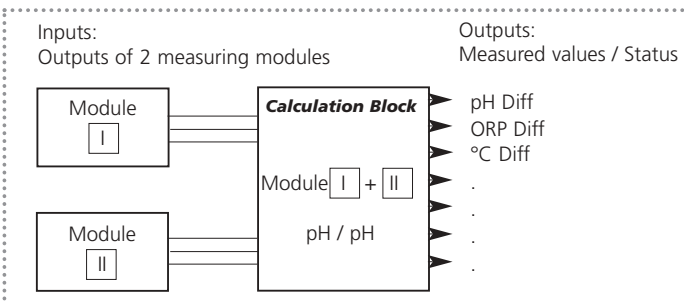

Activating Calculation Blocks

Select menu: Parameter setting/System control/Calculation Blocks
 Combining measuring modules to Calculation Blocks

Combining measuring modules

With three measuring modules the following Calculation Block combinations are possible:  +  ,  +  ,  + 

Two Calculation Blocks can be activated.

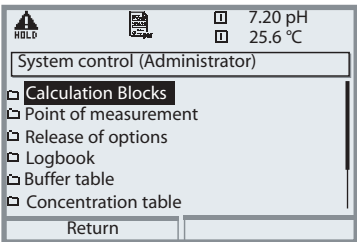
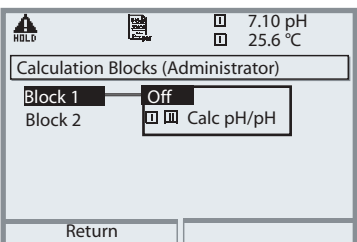
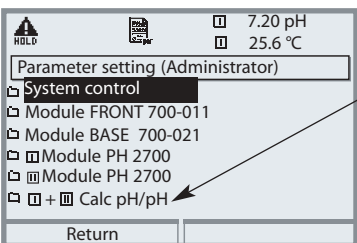
| Menu | Display | Activate Calculation Blocks |
|---|---|---|
|  |  | <p>Calculation Blocks</p> <ul style="list-style-type: none"> • Call up parameter setting • System control • Select "Calculation Blocks" |
| |  | <ul style="list-style-type: none"> • Depending on modules installed, the possible combinations for Calculation Blocks are offered |
| |  | <p>During parameter setting the Calculation Blocks are displayed like modules.</p> |

Calculation Blocks: Overview

Module combinations, Calculation Block, process variables

| Module combination | Calculation Block | Variables calculated by the Calculation Block |
|---|-------------------------------------|---|
| pH + pH | Calc pH/pH | Difference Difference Difference pH ORP °C |
| Cond + Cond Cond Ind + Cond Ind Cond + Cond Ind | Calc Cond/Cond | Difference Difference Difference Ratio Passage (Pass) Rejection (Reject) Deviation (Deviat) c(NaOH) S/cm Ω *cm °C S/cm [] S/cm [%] S/cm [%] S/cm [%] pH |
| O ₂ + O ₂ | Calc O ₂ /O ₂ | Difference Difference Difference Difference Difference %Air % O ₂ g/l ppm °C |

New process variables and signal processing

Current outputs

All current outputs can be set to output the new process variables formed by the Calculation Blocks.

Measurement display

All new process variables can be displayed as primary or as secondary value.

Controller

Controller functions are not supported.

Calculation formulas

Module combinations, Calculation Block, process variables

| Measured variable | Calculation formula | Range | Span |
|------------------------------------|--|------------------|----------------|
| Difference (selectable in menu) | DIFF = A - B or DIFF = B - A | Meas. variable | Meas. variable |
| Ratio (selectable in menu) | RATIO = $\frac{A}{B}$ | 0.00 ... 19.99 | 0.10 |
| Passage | PASS = $\frac{B}{A} \cdot 100$ | 0.00 ... 199.9 | 10 % |
| Rejection | REJECT = $\left(1 - \frac{B}{A}\right) 100 \%$ | -199.9 ... 199.9 | 10 % |
| Deviation | DEVIAT = $\left(\frac{B}{A} - 1\right) 100 \%$ | -199.9 ... 199.9 | 10 % |

pH value calculation by means of dual conductivity measurement

See instruction manual for Cond 7700 module. Principle:

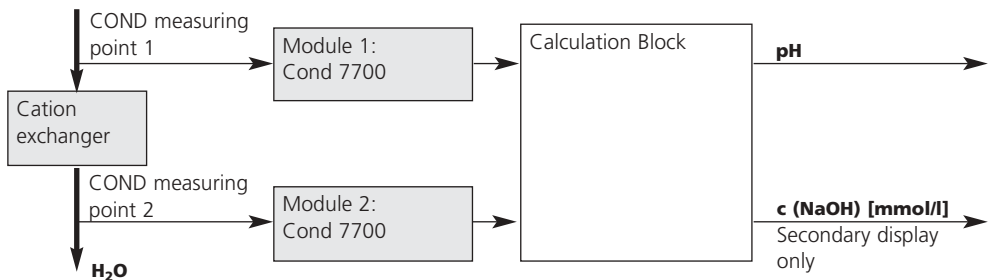

$$c(\text{NaOH}) = \frac{\text{COND1} - 1/3 \text{ COND2}}{243}$$

$$\text{pH} = 11 + \log[c(\text{NaOH})]$$

Configuring a Calculation Block

Select menu: Parameter setting/System control/Select Calculation Block
 Setting the process variable to be calculated

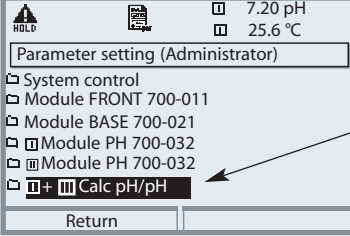
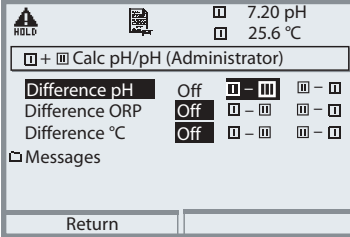
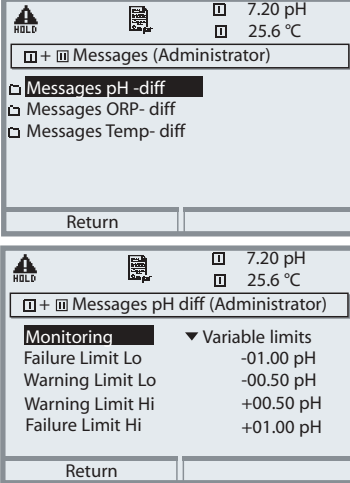
| Menu | Display | Configure Calculation Block |
|---|--|--|
|  |  | <p>Select Calculation Block</p> <ul style="list-style-type: none"> • Call up parameter setting • System control • Select module |
| |  | <ul style="list-style-type: none"> • Depending on modules installed, the possible combinations for Calculation Blocks are offered |
| |  | <p>Messages</p> <p>You can activate messages for the selected variables.</p> <p>Variables which have been set as "Off" cannot be processed further.</p> <p>The measured values which shall release a message are set using the arrow keys (left/right: select position, up/down: edit number). Confirm with enter.</p> |

USP function

Monitoring of ultrapure water in the pharmaceutical industry
(To configure: Select Parameter setting COND 7700 module)

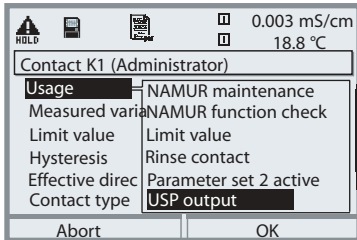

USP function, define switching output

When a COND 7700 module is installed, one of the floating relay outputs of the BASE module (K1, K2 or K3) can be assigned to the USP function.

- Select parameter setting;
- Administrator level (function check active!)
- M 700 BASE
- Define contact "Usage" (Fig.)

According to the "USP" directive (U.S. Pharmacopeia), Appendix 5, Section 645 "Water Conductivity" the conductivity of pharmaceutical waters can be monitored online.

To do so, the conductivity is measured without temperature compensation and compared with limit values. The water is usable without further test steps when the conductivity is below the USP limit.

Reduced limit:

The USP limit can be reduced down to 10 % (Parameter setting).

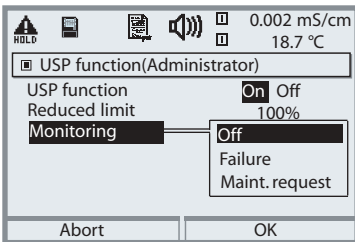

Select USP function

- Select parameter setting;
- Administrator level (function check active!)
- Select "Module COND"
- Select USP function (Fig.)

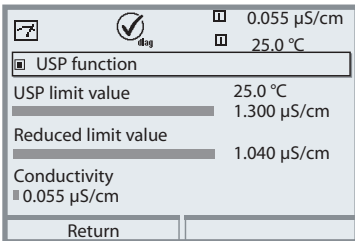

USP function. Diagnostics

- Select diagnostics
 - Select "Module COND"
 - Select USP function:
- Display of USP limit, reduced limit, conductivity

Maintenance

M 700 BASE

Note: Function check active

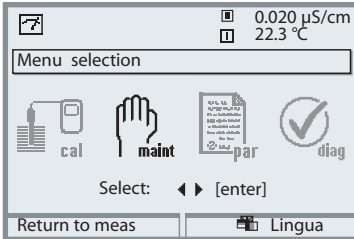
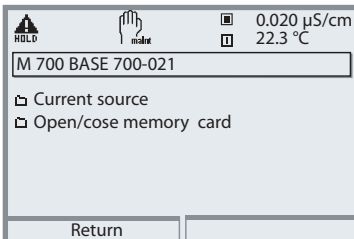
| Menu | Display | Maintenance |
|---|--|--|
|  |   | <p>Call up Maintenance From the measuring mode: Press menu key to select menu. Select maintenance using arrow keys, confirm with enter. Then select M 700 BASE</p> <p>Current source For testing purposes, the output current can be manually specified (range 0 ... 22 mA).</p> <p>Close memory card terminates software access to the SmartMedia card. Must be executed before removing the card from the SmartMedia card slot to prevent data loss.</p> |

Specifications

Specifications

| | |
|----------------------|---|
| Display* | LC graphic display, white backlighting |
| Resolution | 240 x 160 pixels |
| Languages | German, English, French, Italian, Spanish, Swedish |
| Keypad | NAMUR keypad, individual keys, no double assignments [meas] [menu] [↔] [↔] [↔] [↔] [enter] [softkey 1] [softkey 2], NAMUR LEDs red and green. |
| Logbook | Recording of function activations, appearance and disappearance of warning and failure messages with date and time |
| Storage capacity | Approx. 50 entries, without SmartMedia-Card read on display, recording on SmartMedia card |
| Extended logbook | > 50 000 entries, depending on free memory of SmartMedia card |
| Measurement recorder | 2-channel measured value recorder with marking of events (failure, maintenance request, function check, limit values) |
| Recording medium | SmartMedia card |
| Recording capacity | > 50 000 entries, depending on free memory of SmartMedia card |
| Recording method | Process variables and span selectable — Snapshot — Min/Max value — Average |
| Time base | — 10 s to 10 h/pixel |
| Zoom function | — 10fold zoom in the event of high rate of change |
| KI recorder | Adaptive representation of process flow with monitoring and signaling of critical process parameters |

*** Caution!** *Never expose the display to direct, strong sun light!
Only operate the display within the temperature range of
0 °C up to 50 °C max.*

Specifications

| | |
|--|---|
| Device self-test | Test of RAM, FLASH, EEPROM, display, and keypad, Record for QM documentation to ISO 9000 |
| Clock Power reserve | Real-time clock with date Approx. 1 year (lithium battery) |
| Data retention in case of power failure | Parameters and factory settings > 10 years (EEPROM) Logbook, statistics, records > 1 year (lithium battery) Measurement recorder: SmartMedia card |
| Module slots | 3 |
| Power supply (M 700 C/S) Overvoltage category Protection class Pollution degree Wire cross-section | 24 (-15 %) to 230 (+15 %) V AC/DC appr. 10 VA/10 W II I 2 (EN 61010-1) 2.5 mm ² |
| Power supply (M 700 (C/S)/VPW) EEx em IIC or Power supply (M 700 (C/S)/24V) EEx em IIC | 100 (-15 %) ... 230 (+10 %) V AC < 15 VA, 48 ... 62 Hz 24 V AC/DC AC 24 V (- 15 %, + 10 %) < 15 VA, 48 ... 62 Hz DC 24 V (- 15 %, + 20 %) < 8 VA |
| Overvoltage category Protection class Pollution degree Wire cross-section Ground wire connection | II I 2 (EN 61010-1) 2.5 mm ² 2.5 mm ² , M4 screw (EN 61010-1, 6..5.1.2.) |
| Sensor monitor | Direct display of measured values from sensor for validation |
| Protection against electrical shock | Protective connection according to EN 61010-1, 6.5.1 |

Specifications

| | |
|--|--|
| Input OK 1 EEx ib IIC Function | Galv. separated (OPTO coupler) $V_i \leq 30$ V, floating, galvanic isolation up to 60 V Switches device to HOLD mode (function check) |
| Switching voltage | 0 ... 2 V AC/DC inactive 10 ... 30 V AC/DC active (invertible) |
| Input OK 2 EEx ib IIC Function | Galv. separated (OPTO coupler) $V_i \leq 30$ V, floating, galvanic isolation up to 60 V START / STOP KI recorder Switch-over to second parameter set |
| Switching voltage | 0 ... 2 V AC/DC inactive 10 ... 30 V AC/DC active (invertible) |
| Current output I1 EEx ib IIC | 0/4... 20 mA (22 mA), max. 10 V, galvanic isolation up to 60 V (galvanically connected with output I2) |
| Load monitoring Overrange* Measurement error** Current source | Error message if load is exceeded 22 mA in the case of messages < 0.25 % current value + 0.05 mA 0,00 ... 22.00 mA |
| Current output I2 EEx ib IIC | 0/4 ... 20 mA (22 mA), max. 10 V, galvanic isolation up to 60 V (galvanically connected with output I1) |
| Load monitoring Overrange* Measurement error** Current source | Error message if load is exceeded 22 mA in the case of messages < 0.25 % current value + 0.05 mA 0,00 ... 22.00 mA |
| Switching contacts ³⁾ EEx ib IIC | 4 relay contacts K1 to K4, floating galvanic isolation up to 60 V K1, K2, K3 connected on one side |
| Loadability Usage ⁴⁾ | DC: < 30 V / < 500 mA, < 10 W K1 - K3, user definable for NAMUR maintenance request/ function check, limit values, parameter set 2 active, rinsing contact, USP contact, K4 permanently set as alarm contact (NAMUR failure) |

Specifications

General data

Explosion protection

II 2 G D EEx em ib IIC T4 KEMA 04 ATEX 2056

EMC

NAMUR NE 21 and
EN 61326 VDE 0843 Part 20 /01.98
EN 61326/A1 VDE 0843 Part 20/A1 /05.99
Class B
Industry

Emitted interference
Immunity to interference

Lightning protection

EN 61000-4-5, Installation Class 2

Nominal operating conditions

Ambient temperature $-20 \dots +55 \text{ }^\circ\text{C}$ (IS: max. $+50 \text{ }^\circ\text{C}$)
Relative humidity 10 to 95 % not condensing
Power supply 24 (-15%) to 230 ($+15\%$) V AC/DC
Frequency AC 45 ... 65 Hz

Transport/ Storage temperature

$-20 \dots +70 \text{ }^\circ\text{C}$

Enclosure

M 700 C: Steel, coated
M 700 S: Stainless steel, polished, 1.4305
— Wall mounting
— Post/pipe mounting
— Panel mounting
— Sealed against panel
See dimension drawing.
IP 65 / NEMA 4 X
5 times M20 x 1.5
Single wires and flexible leads up to 2.5 mm^2 (AWG 14)
Approx. 3.2 kg plus approx. 150 g per module

Assembly

Dimensions
Ingress protection
Cable glands
Terminals
Weight

* User-defined

** To IEC 746 Part 1, at nominal operating conditions

Glossary

Glossary

Alarm limit

For each process variable, you can define high and low warning and failure limits (NAMUR states: maintenance request, failure). The alarm can be activated individually for each variable.

When an alarm limit is exceeded, an error message appears and the corresponding NAMUR contact is activated.

Calibration/adjustment passcode

Protects access to calibration. Can be set or disabled at the Administrator level.

Cell factor

Mechanical characteristic of electrodeless (toroidal) conductivity sensors.

Cleaning

User-defined time during which the cleaning contact is closed during a rinsing cycle.

Controlled variable

User-defined variable that acts on the controller.

Diagnostics menu

Display of all relevant information on the device status.

Failure

Alarm message and NAMUR contact. Failure means that the equipment no longer operates properly or that a process parameter has reached a critical value. Failure is disabled during "function check".

Feed time alarm

Monitors the time during which the controller output is at 100 %.

Glossary

Glossary

Function check

NAMUR contact. Always active when the unit does not output the configured measured value.

GLP/GMP

Good Laboratory Practice / Good Manufacturing Practice:
Rules for performance and documentation of measurements.

Interval

The interval extends from the start of one rinsing cycle to the start of the next rinsing cycle, user defined.

Isothermal potential

The isothermal intersection point is the point of intersection between two calibration lines at two different temperatures. The potential difference between the electrode zero point and this intersection point is the isothermal potential " V_{ISO} ".

Limit contacts

Are controlled by a user-definable process variable. The limit contact is activated if the measured value falls below or exceeds an alarm limit, depending on the user-defined effective direction.

Logbook

The logbook shows the last 50 events with date and time, e.g. calibrations, warning and failure messages, power failure etc. etc. This permits quality management documentation to ISO 9000. Longer recordings are possible with the additional function "Extended logbook".

Main display

Large measured-value display in the measuring mode. You can select which process variable is to be displayed.

Glossary

Glossary

Maintenance menu

The Maintenance menu provides all functions for sensor maintenance and signal outputs.

Maintenance passcode

Protects access to Maintenance. Can be set or disabled at the Administrator level.

Measuring mode

When no menu function is activated, the unit is in measuring mode. The selected measured value is displayed. Pressing the meas key always returns you to the measuring mode.

Menu structure

The analyzer provides a very clear menu structure. Menu selection is called up by pressing the menu key. Four basic functions can be accessed: Calibration (cal), Maintenance (maint), Parameter setting (par), and Diagnostics (diag). From each of these functions, the individual module blocks (system control, M 700 FRONT (display functions), M 700 BASE (signal outputs) can be accessed, as well as all added measuring and communication modules. See Pg 30.

Message list

The message list shows the number of currently activated messages and the individual warning or failure messages in plain text.

NAMUR

German committee for measurement and control standards in the chemical industry

NAMUR contacts

"Function check", "maintenance request" and "failure".
Indicate status of measured variable and measuring system.

Glossary

Glossary

Operator level

Menu level of the Parameter Setting menu. You can edit the device settings that have been enabled at the Administrator level.

Operator passcode

Protects access to the Operator level. Can be set or disabled at the Administrator level.

Parameter Setting menu

The Parameter Setting menu provides 3 access levels: Viewing, Operator, and Administrator level.

Passcode protection

Access to the Calibration, Maintenance, Operator and Administrator levels is protected by passcodes.

The passcodes can be defined or disabled at the Administrator level.

Point of measurement (Tag number)

Can be defined to identify the unit and can be displayed in the Diagnostics menu.

Reference temperature

With temperature compensation activated, the measured value is calculated to the value at the reference temperature (usually 20 oder 25 °C) using the temperature coefficient.

Second rinsing

User-defined time during which the “Rinsing” contact is closed at the end of the rinsing cycle.

Glossary

Glossary

Secondary displays

Two small displays located below the main display in measuring mode. The process variables to be displayed can be selected using the softkeys underneath.

Sensor coding

Here, internal settings for electrodeless sensors are encoded (Cond Ind module).

Slope

The slope of an electrode is the voltage change per pH unit. For an ideal pH electrode, it lies at -59.2 mV/pH ($25 \text{ }^\circ\text{C}$).

Viewing level

Menu level of the Parameter Setting menu. Display of all device settings, however no editing possible.

Zero point

The zero point is the voltage value delivered by an electrode at $25 \text{ }^\circ\text{C}$ and $\text{pH} = 7.00$. For an ideal pH electrode, it lies at 0 mV . In practice, the real zero point is slightly different.

Index

2-channel measurement recorder38

A

Accessories17

Additional functions10, 17

Audit Trail Log15

B

BASE M 700 C / M 700 S (non-IS)23

BASE M 700X C/24V / M 700X C/24V25

BASE M 700X C/VPW / M 700X S/VPW24

Behavior during messages63

C

Calculation Blocks70

Calculation Blocks: Overview72

Commissioning14

Configuring a Calculation Block74

Conformity with FDA 21 CFR Part 1115

Connection of power supply22

Contact type67

Contacts59

Copy configuration51

Current output curves60

Current outputs59

Currently measured value63

D

Device description41

Diagnostics functions38

Dimension drawings28

Display test41

Disposal2

Index

E

| | |
|---------------------------------|----|
| Effective direction | 67 |
| Electronic Signature | 15 |
| Entering numbers and text | 33 |
| Explosion protection | 80 |

F

| | |
|------------------------------------|--------|
| Factory setting | 57 |
| Failure | 64 |
| Favorites menu | 36 |
| FDA 21 CFR Part 11 | 15 |
| Fixed value (22 mA) | 63 |
| Formatting a SmartMedia card | 47, 55 |
| Function check | 63-64 |
| Function control matrix | 36, 44 |

G

| | |
|-----------------------|----|
| Glossary | 81 |
| Graphic display | 18 |

H

| | |
|---|----|
| Hazardous-area application | 13 |
| Hazardous-area connection M 700X | 26 |
| Hazardous-area control modules (examples) | 27 |
| HOLD function | 63 |
| Hysteresis | 67 |

I

| | |
|-------------------------------------|----|
| Icons | 32 |
| Input/output status | 41 |
| Inserting the SmartMedia card | 46 |
| Intended use | 12 |

K

| | |
|-------------------|----|
| Keypad test | 41 |
|-------------------|----|

Index

L

| | |
|-------------------------|--------|
| Language setting | 58 |
| Last usable value | 63 |
| LED | 18 |
| Limit value | 67 |
| Logbook | 40, 57 |

M

| | |
|-----------------------------|--------|
| M 700 BASE | 21 |
| M 700 FRONT | 20 |
| Maintenance | 76 |
| Maintenance request | 64 |
| Measurement display | 34, 58 |
| Menu selection | 31 |
| Menu structure | 19, 30 |
| Message list | 40 |
| Messages | 63 |
| Modular concept | 7 |
| Module diagnostics | 41 |
| Module equipment | 21 |
| Module identification | 32 |
| Mounting | 28 |

N

| | |
|---------------------|-------|
| NAMUR signals | 63-64 |
|---------------------|-------|

O

| | |
|--------------------------------------|----|
| OK inputs | 59 |
| OK1, OK2 inputs: Specify level | 68 |
| Operating levels | 32 |
| Output filter | 62 |

P

| | |
|------------------------|----|
| Package contents | 12 |
| Panel mounting | 28 |

Index

| | |
|--|--------|
| Parameter sets A, B | 48, 69 |
| Parameter setting: Lock functions | 43 |
| Parameter setting: Operating levels | 42 |
| Passcode entry | 45 |
| pH value calculation by means of dual conductivity measurement | 73 |
| Point of measurement | 45 |
| Post mounting | 29 |
| Power supply | 22 |
| Product line | 16 |

R

| | |
|---|-------|
| Reduced limit | 75 |
| Registered trademarks | 2 |
| Relay contacts | 64-66 |
| Relay contacts: Protective wiring | 65 |
| Release of options | 45 |
| Removing the SmartMedia card | 46 |
| Return of products | 2 |

S

| | |
|---------------------------------------|--------|
| Safety information | 13-14 |
| Secondary displays | 34 |
| Sensocheck, Sensoface | 39 |
| Sensor network diagram | 38 |
| Serial number M 700 FRONT | 11 |
| ServiceScope | 38 |
| Short description | 18 |
| Slot for SmartMedia card | 20 |
| SmartMedia card | 46 |
| SmartMedia card: Application | 47 |
| SmartMedia card: Formatting | 47, 55 |
| SmartMedia card: Memory card | 51 |
| SmartMedia card: Parameter sets | 49-50 |
| SmartMedia card: Remove card | 56 |
| SmartMedia card: Save firmware | 54 |

Index

| | |
|---|-------|
| SmartMedia card: Software update | 52 |
| Softkey function | 36 |
| Softkeys | 34 |
| Software version | 6 |
| Specifications | 77 |
| Start-up | 14 |
| Switching parameter sets via OK2 | 69 |
| System control: Parameter sets A, B | 48 |
| System overview | 78 |
| T | |
| TAN (transaction number) | 11 |
| Terminal plate | 23-25 |
| Terminal plates of "hidden" modules | 20 |
| Time constant of output filter | 62 |
| Time/date | 44 |
| U | |
| USP function | 75 |
| V | |
| Viewing angle | 58 |
| W | |
| Wall mounting | 29 |
| Warranty | 2 |

Menu structure of basic unit

M 700(X): M 700 FRONT, M 700 BASE



| | |
|---------------------------------|----|
| Maintenance | 76 |
| Open/close memory card | 76 |
| M 700 BASE Current source | 76 |



| | |
|--|----|
| Parameter setting M 700 FRONT | 58 |
| Languages | 58 |
| Measurement display | 58 |

| | |
|--|----|
| Parameter setting M 700 BASE | 59 |
| Output current I1, output current I2 | 59 |
| Relay contacts (NAMUR) | 64 |
| Limit contact K1 | 66 |
| Inputs OK1, OK2 | 68 |
| Switch parameter sets via OK2 | 69 |



| | |
|--------------------------|----|
| Diagnostics | 40 |
| Message list | 40 |
| Logbook | 40 |
| Device description | 41 |
| • M 700 FRONT | 41 |
| • M 700 BASE | 41 |

Configuring the system control

| | | |
|----------|---------------------|-------------------|
| Passcode | Administrator level | 1989 (new:) |
| | Operator level | 1246 (new:) |



| | |
|--|----|
| Passcode entry..... | 45 |
| Factory setting..... | 57 |
| Function control matrix (softkey usage)..... | 44 |
| Time/date..... | 44 |
| Point of measurement..... | 45 |
| Release of options (additional functions)..... | 45 |
| Software update (with update card inserted)..... | 53 |
| Logbook..... | 57 |
| Calculation Blocks..... | 70 |
| USP function..... | 75 |

SmartMedia card features

| | | |
|----------|---------------------|-------------------|
| Passcode | Administrator level | 1989 (new:) |
| | Operator level | 1246 (new:) |



| | |
|---|----|
| Inserting the SmartMedia card..... | 46 |
| Application..... | 47 |
| Saving / Loading parameter sets..... | 49 |
| Memory card: Copy configuration..... | 51 |
| Software update..... | 52 |
| Save firmware..... | 54 |
| Formatting (also commercial cards)..... | 55 |
| Removing / Closing the SmartMedia card..... | 56 |