

Measuring Module M 700[®] O₂ 4700i(X)

For Oxygen Measurement in
Liquids and Gases



ISM
INTELLIGENT SENSOR MANAGEMENT

METTLER TOLEDO



71944

Warranty

Defects occurring within 1 year from delivery date shall be remedied free of charge at our plant (carriage and insurance paid by sender). Sensors, fittings, and accessories: 1 year.

©2007 Subject to change without notice

Return of Products Under Warranty

Please contact our Service Team before returning a defective device. Ship the cleaned device to the address you have been given. If the device has been in contact with process fluids, it must be decontaminated/disinfected before shipment. In that case, please attach a corresponding certificate, for the health and safety of our service personnel.

Disposal

Please observe the applicable local or national regulations concerning the disposal of "waste electrical and electronic equipment".

Trademarks

The following registered trademarks are used in this instruction manual without further marking

SMARTMEDIA®

is a registered trademark of Toshiba Corp., Japan

FOUNDATION FIELDBUS™

is a trademark of Fieldbus Foundation, Austin, USA

Mettler-Toledo AG,
Process Analytics, Industrie Nord, CH-8902 Urdorf,
Tel. +41 (44) 729 62 11 Fax +41 (44) 729 26 36
Subject to technical changes.



Adresse Im Hackacker 15 (Industrie Nord), CH-8902 Urdorf, Schweiz
Briefadresse Postfach, CH-8902 Urdorf
Telefon 01-736 22 11
Telefax 01-736 26 36
Internet www.mt.com
Bank Credit Suisse First Boston, Zürich (Acc. 0835-370501-21-90)

Declaration of conformity Konformitätserklärung Déclaration de conformité

**We/ Wir/Nous****Mettler-Toledo GmbH, Process Analytics**Im Hackacker 15
8902 Urdorf
Switzerland

declare under our sole responsibility that the product,
erklären in alleiniger Verantwortung, dass dieses Produkt,
déclarons sous notre seule responsabilité que le produit,

Description**Beschreibung/Description****02 47001**

to which this declaration relates is in conformity with the following standard(s) or
other normative document(s).

auf welches sich diese Erklärung bezieht, mit der/den folgenden Norm(en) oder
Richtlinie(n) übereinstimmt.

auquel se réfère cette déclaration est conforme à la (aux) norme(s) ou au(x)
document(s) normative(s).

EMC Directive/**EMV-Richtlinie/****Directive concernant la CEM****89/336/EWG****Low-voltage directive/****Niederspannungs-Richtlinie/****Directive basse tension****73/23/EWG****Place and Date of issue/****Ausstellungsort/ - Datum****Lieu et date d'émission****Urdorf, September 15, 2005**

Mettler-Toledo GmbH, Process Analytics

Waldemar Rauch
General Manager PO UrdorfThomas Hösl
Head of Operations and R&D**Norm/ Standard/ Standard****EN 61326 / VDE 0843 Teil 20****EN 61010-1 / VDE 0411 Teil 1**

CE_M700_Modul_O2_4700i.doc



Mettler-Toledo GmbH

Process Analytics

Adresse Im Hackacker 15 (Industrie Nord), CH-8902 Urdorf, Schweiz
Briefadresse Postfach, CH-8902 Urdorf
Telefon 01-736 22 11
Telefax 01-736 26 36
Internet www.mt.com
Bank Credit Suisse First Boston, Zürich (Acc. 0835-370501-21-90)

**Declaration of conformity
Konformitätserklärung
Déclaration de conformité****We/ Wir/Nous****Mettler-Toledo GmbH, Process Analytics**Im Hackacker 15
8902 Urdorf
Switzerland

declare under our sole responsibility that the product,
erklären in alleiniger Verantwortung, dass dieses Produkt,
déclarons sous notre seule responsabilité que le produit,

Description**Beschreibung/Description****02 4700I X**

to which this declaration relates is in conformity with the following standard(s) or
other normative document(s).

auf welches sich diese Erklärung bezieht, mit der/den folgenden Norm(en) oder
Richtlinie(n) übereinstimmt.

auquel se réfère cette déclaration est conforme à la (aux) norme(s) ou au(x)
document(s) normative(s).

Explosion protection**Explosionsschutzrichtlinie****Prof. contre les explosions****94/9/EG****KEMA 04 ATEX 2056****NL-6812 AR Arnhem, KEMA 0344****EMC Directive/****EMV-Richtlinie/****Directive concernant la CEM****89/336/EWG****Low-voltage directive/****Niederspannungs-Richtlinie/****Directive basse tension****73/23/EWG****Place and Date of issue/****Ausstellungsort/ - Datum****Lieu et date d'émission****Urdorf, October 31, 2005**

Mettler-Toledo GmbH, Process Analytics

Waldemar Rauch
General Manager PO UrdorfThomas Hösl
Head of Operations and R&D**Norm/ Standard/ Standard****EN 50014 EN 50281-1-1**
EN 50020 EN 50284
EN 61326 / VDE 0843 Teil 20
EN 61010-1 / VDE 0411 Teil 1**METTLER TOLEDO**

CE_M700_Modul_02_4700I_X.doc

Contents

Warranty	2
Disposal	2
Trademarks	2
Intended Use	8
Conformity with FDA 21 CFR Part 11	8
Safety Information	9
Application in Hazardous Locations: Module O ₂ 4700iX	9
Software Version	10
Modular Concept	11
Short Description	12
Short Description: FRONT Module.....	12
Short Description: Menu Structure.....	13
Short Description: BASE Module.....	15
ISM - Intelligent Sensor Management.....	16
ISM - Plug and Measure.....	17
ISM First Calibration.....	18
ISM Parameter Setting	19
ISMPredictive Maintenance	20
ISMDiagnostics	21
CIP (Cleaning in Place) / SIP (Sterilization in Place).....	22
Terminal Plate	23
Inserting the Module.....	24
Wiring Example.....	25
Wiring Example.....	26
Menu Selection	27
Menu Structure	27
Passcode Entry	28
Changing a passcode.....	28
Configuring the Measurement Display	29
Calibration / Adjustment.....	31

Contents

Adjustment.....	32
Recommendations for Calibration.....	33
Selecting a Calibration Method.....	34
Automatic Calibration in Water	36
Automatic Calibration in Air	38
Product Calibration: Saturation (Calibration with Sampling)	40
Product Calibration: Concentration (Calibration with Sampling)	42
Data Entry of Premeasured Sensors	44
Zero Correction.....	45
Parameter Setting: Operating Levels.....	46
Administrator level.....	46
Operator level.....	46
Viewing level	46
Parameter Setting: Lock Functions	47
Activating Parameter Setting.....	48
Documenting Parameter Setting	49
Module Configuration: Operating Mode.....	51
Setting the Sensor Data Parameters	52
Sensoface	54
Calculation Blocks.....	55
Logbook	57
Factory setting	57
Messages: Default settings and selection range	58
Device limits.....	58
To configure current output.....	60
Current Outputs: Characteristics	61
Output Filter	63
NAMUR Signals: Current Outputs	64
NAMUR Signals: Relay Contacts.....	65
Relay Contacts: Protective Wiring	66
Relay Contacts.....	67
Relay contacts, usage.....	67
Rinse Contact	68

Contents

Configuring the rinse contact	68
Limit Value, Hysteresis, Contact Type	69
Icons in the measurement display:	69
OK1, OK2 Inputs: Specify Level	70
Switching Parameter Sets via OK2	71
Selecting parameter set (A, B) via OK2 input	71
Signaling active parameter set via relay contact	71
Maintenance.....	72
Diagnostics Functions	73
Point of meas description	73
Logbook	73
Device description.....	74
FRONT module	74
BASE module.....	74
Module diagnostics.....	75
Sensor monitor	75
Cal record.....	76
Sensor network diagram.....	76
Statistics	76
Call up diagnostics.....	79
Message list	79
Specifications	84
Appendix:	88
Minimum Spans for Current Outputs.....	88
Dissolved Oxygen Measurement in Carbonated Beverages (SW 700-011) ..	89
Index	94

Intended Use

The module is used to measure oxygen in liquids and in gases using Mettler-Toledo sensors of the InPro 6800 / 6900 Series. The module permits simultaneous measurement of oxygen partial pressure, barometric pressure, and temperature. In addition, oxygen saturation or concentration and in gases the volume concentration can be calculated and displayed.

The CO₂ 4700iX module is intended for operation in locations subject to explosion hazards which require equipment of Group II, device category 2(1), gas/dust.

Conformity with FDA 21 CFR Part 11

In their directive "Title 21 Code of Federal Regulations, 21 CFR Part 11, Electronic Records; Electronic Signatures" the US American health agency FDA (Food and Drug Administration) regulates the production and processing of electronic documents for pharmaceutical development and production. This results in requirements for measuring devices used for corresponding applications. The following features ensure that the M 700(X) modular process analysis system meets the demands of FDA 21 CFR Part 11:

Electronic Signature

Access to the device functions is regulated and limited by individually adjustable codes – "Passcodes". This prevents unauthorized modification of device settings or manipulation of the measurement results. Appropriate use of these passcodes makes them suitable as electronic signature.

Audit Trail Log

Every change of device settings can be automatically recorded and documented in the Audit Trail Log on the SmartMedia card. The recording can be encrypted.

Safety Information

Application in Hazardous Locations

Caution!

Never try to open the module! If a repair should be required, return the module to our factory.

If the specifications in the instruction manual are not sufficient for assessing the safety of operation, please contact the manufacturer to make sure that your intended application is possible and safe.

Be sure to observe during installation:

- Switch off power supply before replacing or inserting a module.
- Protect the signal inputs of the modules against electrostatic discharge.
- Before commissioning it must be proved that the device may be connected with other equipment.
- Observe correct shielding: To avoid interferences, the cable shielding must be completely covered by the ESD shielding cap.

Application in Hazardous Locations:

Module O₂ 4700iX

When using the O₂ 4700iX module, the stipulations for electrical installations in hazardous areas (EN 60079-14) must be observed.

When installing the device outside the range of applicability of the 94/9/EC directive, the appropriate standards and regulations in the country of use must be observed. The module has been developed and manufactured in compliance with the applicable European guidelines and standards.

Compliance with the European Harmonized Standards for use in hazardous locations is confirmed by the EC-Type-Examination Certificate.

Compliance with the European guidelines and standards is confirmed by the EC Declaration of Conformity.

There is no particular direct hazard caused by the operation of the device in the specified environment.

Software Version

O₂ 4700i(X) Module

Device Software M 700(X)

The O₂ 4700i(X) module is supported by software version 6.2 or higher.
The O₂ 4700iX module is supported by software version 6.2 or higher.

Module Software O₂ 4700i(X)

Software version 2.2

Query Actual Device/Module Software

When the analyzer is in measuring mode:
Press **menu** key, open Diagnostics menu.

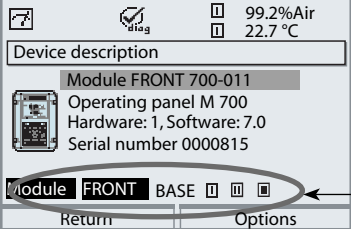
Menu	Display	Device description
 diag		Provides information about all modules installed: Module type and function, serial number, hardware and software version and device options. Select the different modules (FRONT, BASE, slots 1 - 3) using the arrow keys.

Modular Concept

Basic Unit, Measuring Module, Additional Functions

The M 700(X) is an expandable modular process analysis system. The basic unit (FRONT and BASE modules) provides three slots which can be equipped by the user with any combination of measuring or communication modules. The software capabilities can be expanded by additional functions (options). Additional functions must be ordered separately. They are supplied with a device-specific TAN for function release.

M 700(X) Modular Process Analysis System

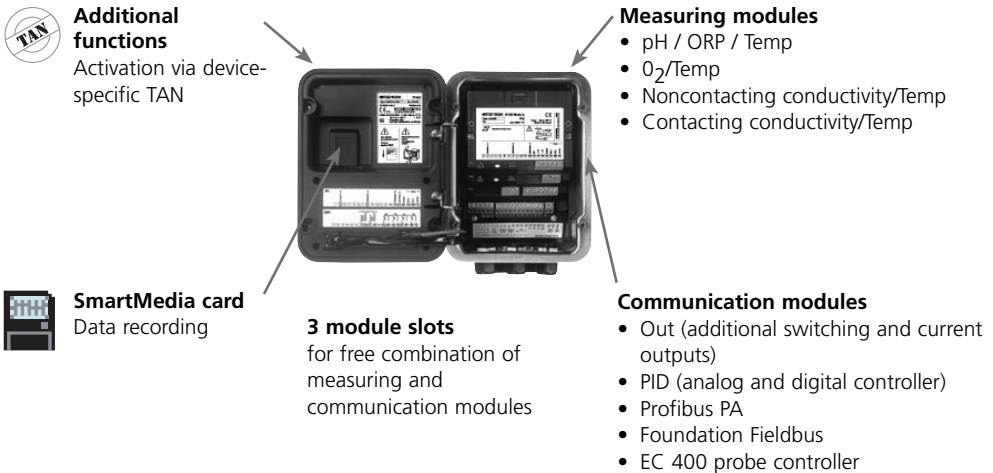

Documentation

The basic unit is accompanied by a CD-ROM containing the complete documentation.

Latest product information as well as instruction manuals for earlier software releases are available at www.mt.com/pro.

Short Description

Short Description: FRONT Module

4 captive screws

for opening the analyzer

(Caution! Make sure that the gasket between FRONT and BASE is properly seated and clean!)

Transflective LC graphic display

(240 x 160 pixels)

white backlighting, high resolution and high contrast.



Measurement display

User interface

with plaintext menus as recommended by NAMUR.

Menu texts can be switched to: German, English, French, Italian, Swedish, and Spanish.

Intuitively acquirable menu logic, based on Windows standards.

Secondary displays

2 softkeys

with context-sensitive functions.

Red LED

signals failure (On) or maintenance request/function check (flashing) according to NE 44.

Green LED

Voltage supply okay

Control panel

3 function keys

(menu, meas, enter)

and 4 arrow keys for menu selection

and data entries

5 self-sealing cable glands

M20 x 1.5

for entry of voltage supply and signal lines

Short Description: Menu Structure

Basic Functions: Calibration, Maintenance, Parameter Setting, Diagnostics

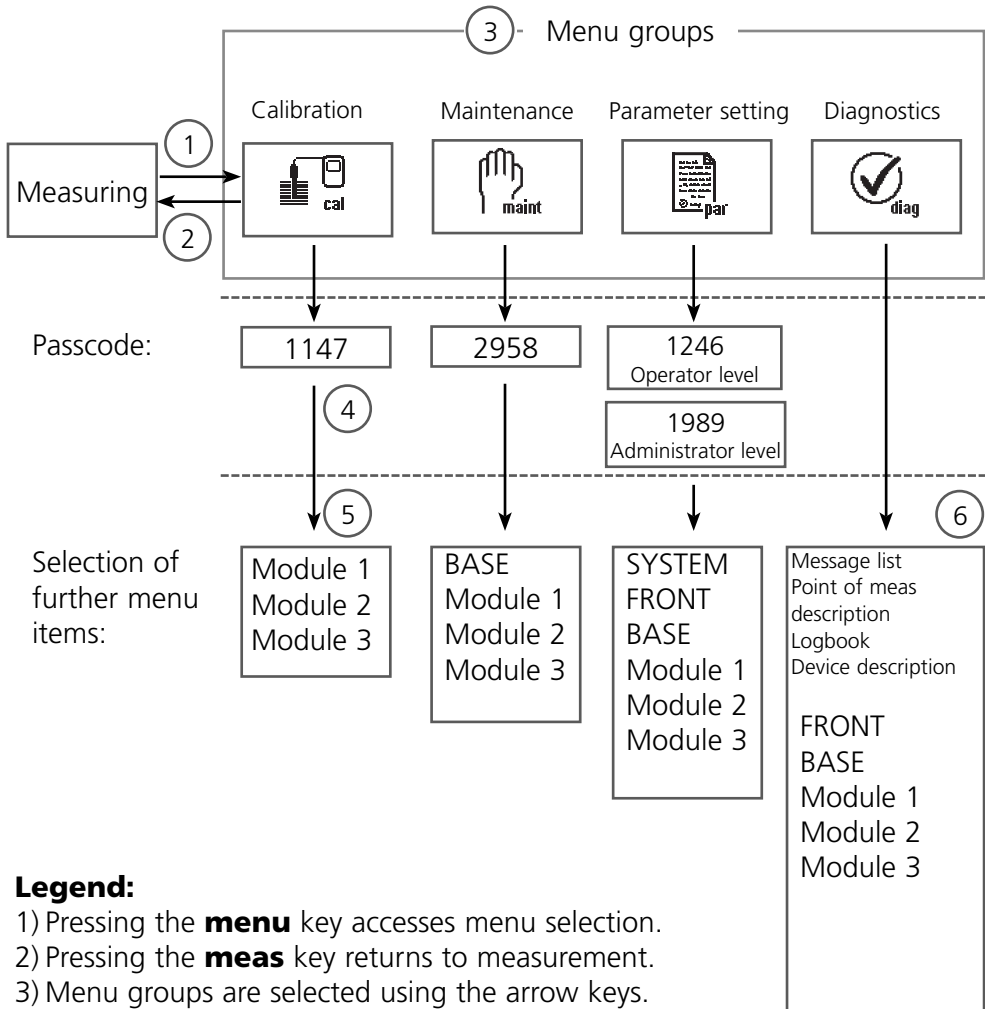

Legend:

- 1) Pressing the **menu** key accesses menu selection.
- 2) Pressing the **meas** key returns to measurement.
- 3) Menu groups are selected using the arrow keys.
- 4) Press **enter** to confirm, enter passcode.
- 5) Further menu items are displayed.
- 6) Selected functions of the Diagnostics menu can be recalled via softkey even when in measuring mode.

Short Description: FRONT Module

View into the open device (FRONT module)

Slot for SmartMedia card

- Data recording
The SmartMedia card expands the measurement recorder capacity to > 50000 records.
- Exchange of parameter sets
5 parameter sets can be stored on the SmartMedia card. The 2 internal parameter sets can be switched by remote control. Configurations can be transmitted from one analyzer to the other.
- Function expansions
are possible with additional software modules, which are released using transaction numbers (TAN)
- Software updates

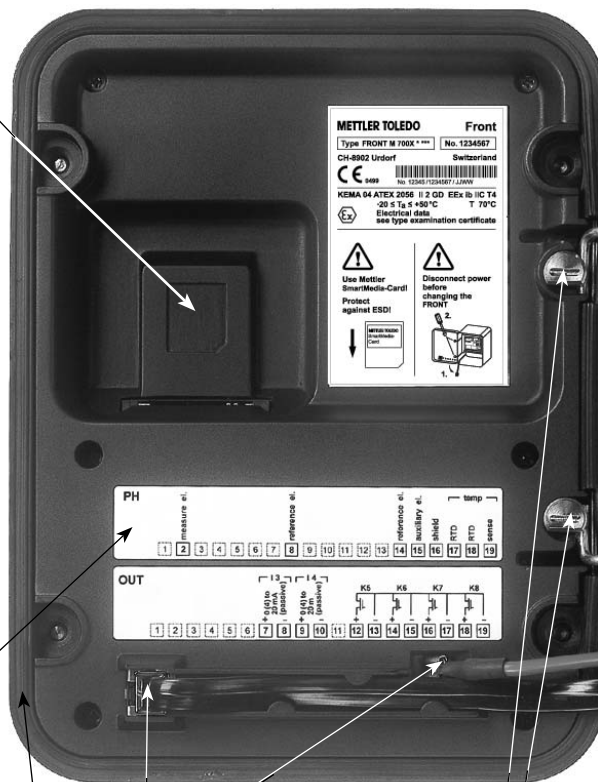

Terminal plates of "hidden" modules

Each module comes with an adhesive label containing the contact assignments. This label should be stuck to the inner side of the front (as shown). Then, the terminal assignments remain visible even if further modules are inserted.

Replacing the front module

Pull off power cord and ground wire. To separate the FRONT module from the BASE module, turn the retaining screws of the pivot hinge by 90°.

The circumferential sealing

guarantees IP 65 protection and allows spray cleaning / disinfection.

Caution! Keep clean!

Short Description: BASE Module

View into the open device (BASE module, 3 function modules installed)

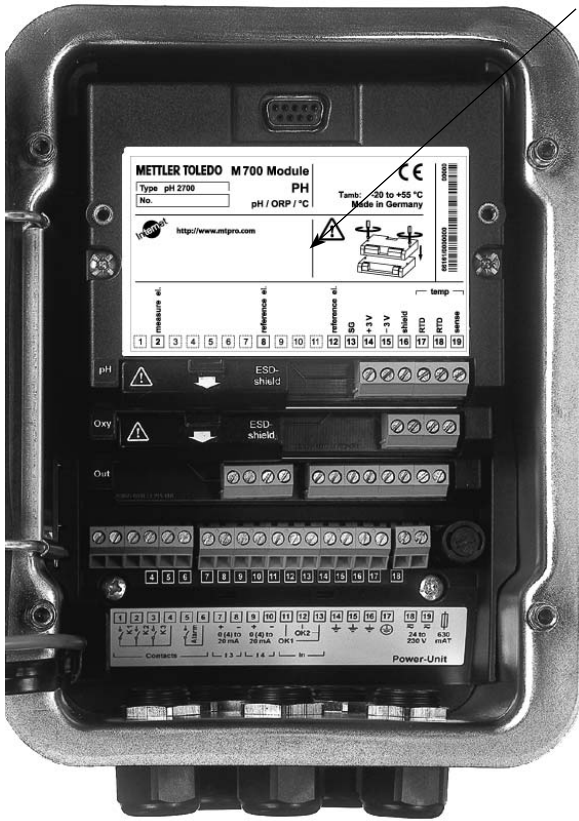

Module equipment

Module identification: Plug & Play.

Up to 3 modules can be combined as desired. Several input and communication modules are available.

BASE module

2 current outputs (free assignment of process variable) and 4 relay contacts, 2 digital inputs.

VariPower broad-range power supply, 20 ... 265 V AC/DC, suitable for all public mains supplies in the world.

Power supply units, IS version:

100 ... 230 V AC or
24 V AC/DC



Warning!

Do not touch the terminal compartment, there may be dangerous contact voltages!

Important Notice Concerning SmartMedia Card

The SmartMedia card may be inserted or replaced with the power supply switched on. Before a memory card is removed, it must be "closed" in the maintenance menu. When closing the device, make sure that the sealing is properly seated and clean.

ISM - Intelligent Sensor Management



The module allows the connection of ISM sensors. ISM is an open system that is compatible to existing connection systems (VP 8) and permits the use of conventional sensors. The system is not restricted to O₂ measurement. Sensors from different manufacturers can be connected.

Continuous monitoring during the O₂ measurement is still possible. ISM sensors have an "electronic datasheet". Additional operating parameters such as calibration date and settings can be stored directly in the sensor. An ISM sensor is immediately identified due to the "Plug & Measure" concept. This ensures the clear assignment of a sensor to a point of measurement. The risk of confusing the sensors is eliminated.

Information Available in the ISM Sensor

Each sensor is clearly identified by the unalterable factory data. They consist of information concerning manufacturer, production date, sensor description, application data, and original calibration data, as well as information on predictive maintenance, such as the maximum load index and maximally permitted number of CIP/SIP cycles.

Statistical data inform on the product life cycle of the sensor: data of the last 3 calibrations, adjustment record, media values, partial pressure, temperature, response time, impedance, barometric pressure.

This allows a comprehensive diagnostic:

- Calculation of the individual load index
- Wear indication
- Membrane changes
- Inner body changes

Taking Over the Minimum/Maximum Temperature

The maximum temperature range is stored in the ISM sensor.

When "Sensor monitoring Auto" has been selected, the value pair for the maximum + minimum temperature is automatically taken over from the sensor.

Thanks to the “Plug & Measure” method, an ISM sensor is immediately identified after being connected:

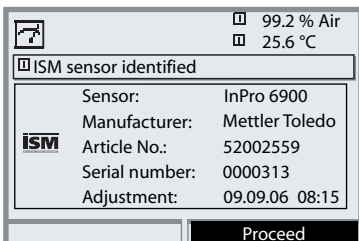

All sensor-typical parameters are automatically sent to the analyzer.

These are, for example, the measurement range, zero and slope of the sensor, but also the type of temperature probe. Without any further parameter setting, measurement starts at once, the measuring temperature is simultaneously detected.

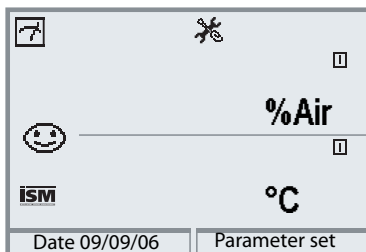

With “Plug&Measure”, premeasured ISM sensors can immediately be used for measurement without previous calibration.

The ISM icon is displayed as long as an ISM sensor is connected.

When the ISM sensor has not been adjusted, the “maintenance request” icon is displayed.

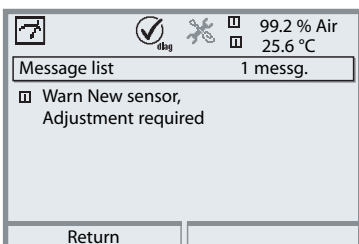

A new entry is added to the message list of the Diagnostics menu:

Warn New sensor, adjustment required

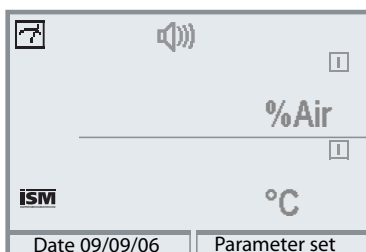

Failure Message (incorrect meas. values)

Measured value, alarm icon, and module slot identifier are flashing.

The flashing means:

Caution! The displayed value is no “valid” measured value!

ISM

First Calibration



Prior to first use, an ISM sensor must be calibrated:

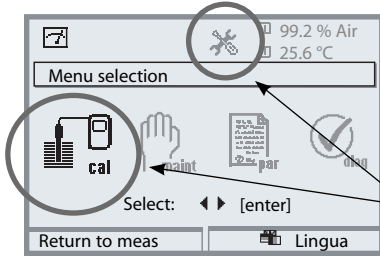

To call up calibration

Press **menu** key to select menu.

The measured values (upper right corner) and the “alarm” and “calibration” icons are flashing. (The analyzer classifies the values as “invalid” because of the missing calibration).

Select calibration using arrow keys, confirm with **enter**. Passcode: 1147.

(To change passcode, select:

Parameter setting / System control / Passcode entry)

After passcode entry, the system is in function check mode: Current outputs and relay contacts behave as configured* and supply either the last measured value or a fixed value until the Calibration menu is exited.

* The current outputs / relay contacts are configured in the BASE module or the communication modules (Out).

The HOLD mode is indicated by the “Hold” icon (upper left of display).

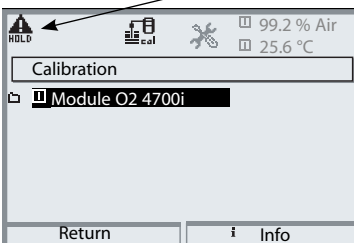

Select module using arrow keys, confirm with **enter**.

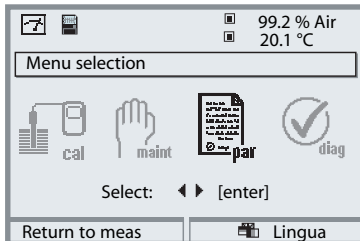

Configuring an ISM sensor is considerably safer and easier than configuring a conventional sensor. Since ISM sensors have an “electronic datasheet”, many parameters are already provided by the sensor and automatically taken over by the analyzer.

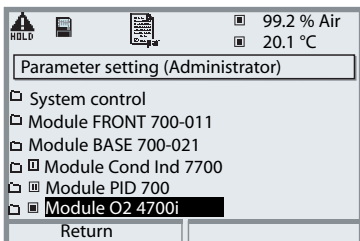

To enter the process-related parameters, select:

- **Parameter setting**
- **Module selection**
- **Sensor data**

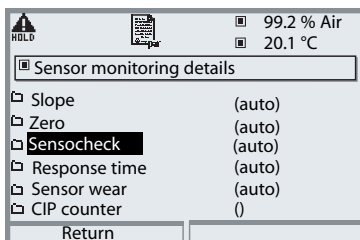
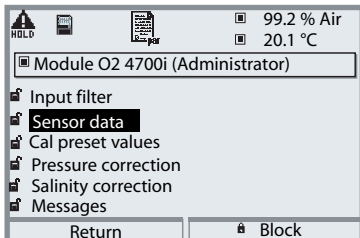

Sensor Monitoring Details

When an ISM sensor is connected, the values for slope, zero, response time, and temperature range are automatically read by the module*. Additional specifications are required for sensor wear, CIP/SIP counter, autoclaving counter, and sensor operating time. The tolerance limits are displayed in gray.

* Individual specifications are not overwritten by ISM sensor data.

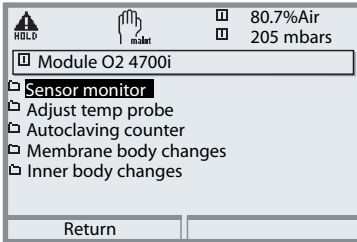

ISM sensors provide important tools for predictive maintenance.

The settings are made in the

- **Maintenance menu / Module selection**

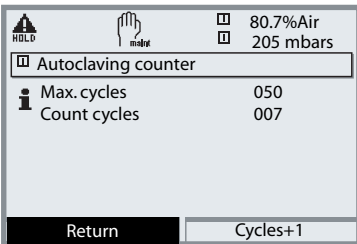

Autoclaving Counter (ISM only)

When setting the sensor data, the maximum number of autoclaving procedures permitted must be specified. Then, each cycle can be recorded in the Maintenance menu. This shows how many autoclaving cycles are still permitted.

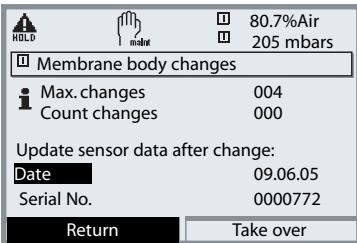

Membrane Body Changes (ISM only)

During parameter setting, the maximum number of membrane body changes permitted must be specified. Then, each cycle can be recorded in the Maintenance menu (date, serial number). This shows how many changes are still permitted.

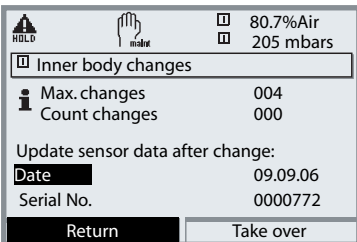

Inner Body Changes (ISM only)

During parameter setting, the maximum number of membrane body changes permitted must be specified. Then, each change of an inner body can be recorded in the Maintenance menu (date, serial number). This shows how many changes are still permitted.

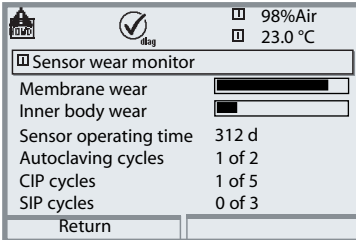

Sensor Wear Monitor (ISM only)

The Diagnostics menu provides single-glance information on the current sensor wear because ISM sensors provide the data for maximum load index of membrane body and inner body.

Generally, the membrane body must be replaced more often than the inner body: The “Membrane wear” bargraph shows how much the membrane is worn out. The inner body wear is not reset when a membrane body has been replaced - here, the load on the inner body is added up and represented as total load on the inner body.

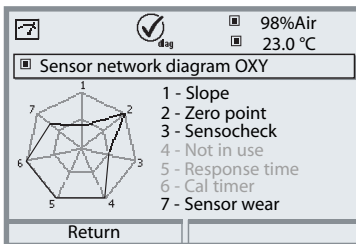

Sensor Network Diagram

- Slope
- Zero
- Sensocheck
- (Not in use)
- Response time
- Cal timer
- Sensor wear

The measured values are continuously monitored during the measurement process. The sensor network diagram provides at-a-glance information about critical parameters. If a tolerance limit has been exceeded, the respective parameter is flashing.

Values in gray: Monitoring switched off.

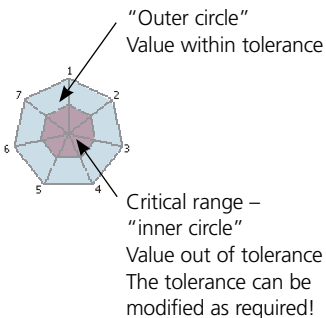

CIP/SIP Cycles

CIP (Cleaning in Place) / SIP (Sterilization in Place)

CIP/SIP cycles are used for cleaning or sterilizing the process-wetted parts in the process. They are performed for biotech applications, for example. Depending on the application, one (alkaline solution, water) or more chemicals (alkaline solution, water, acidic solution, water) are used. The temperatures for CIP are around 80 °C, for SIP around 110 °C. These procedures extremely stress the sensors. ISM sensors can release a message when a preset number of CIP/SIP cycles is exceeded. This allows replacing the sensor in time.

Default Values for the Counters (for Evaluating the Sensor Wear):

CIP = 80

SIP = 700

Autoclaving counter = 750 hours for one cycle

Example of CIP Cycle:

The device automatically recognizes the CIP and SIP cycles and correspondingly increments the counter. The user can specify the max. number of cycles and decide whether a message is to be generated when this number is exceeded.

These data are not overwritten even after sensor replacement.

The number of CIP cycles is shown in the sensor wear monitor of the Diagnostics menu when an individual max value has been specified.

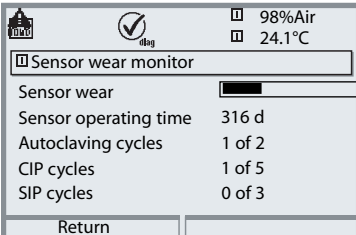

The screenshot shows a diagnostic menu with a 'Sensor wear monitor' section. At the top, there are status indicators: a house icon, a checkmark, and two data points: '98%Air' and '24.1°C'. The 'Sensor wear monitor' section has a title bar and a progress bar for 'Sensor wear'. Below this, a list of metrics is shown:

Sensor wear	██████████
Sensor operating time	316 d
Autoclaving cycles	1 of 2
CIP cycles	1 of 5
SIP cycles	0 of 3

At the bottom of the menu is a 'Return' button.

Notice:

The counters are incremented no earlier than 2 hours after start of the cycle, even if the cycle itself has already been terminated.

Terminal Plate

Terminal Plate O₂ 4700i Module:

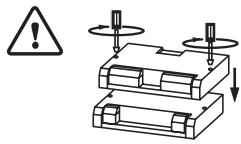
METTLER TOLEDO M 700 Module		ISM O ₂		CE		00000													
Type O ₂ 4700i		O ₂ / °C		Tamb: -20 to +55 °C		00000/0000000													
No. _____				Made in Germany		00000/0000000													
Internet http://www.mt.com																			
Oxy sensor																			
cathode																			
anode																			
guard shield DGND data RTD RTD																			
input																			
- (0) 4 to + 20 mA																			
2		8		12		13		14		15		16		17		18		19	

Terminal Plate O₂ 4700i X Module:

METTLER TOLEDO M 700X Module		ISM OXY		SP FM APPROVED		CE 0049		00000											
Type O ₂ 4700i X		O ₂ / °C		Tamb: -20 to +50 °C		Made in Germany/Kassel		00000/0000000											
No. _____								00000/0000000											
<p>CE KEMA 04 ATEX 2056 Electr. data see type examination certificate II 2 (1) GD EEx ib [ia] IIC T4 T 70 °C CH-8902 Urdorf Switzerland</p> <p>FM APPROVED IS, CLASS I, DIV1, GRP A, B, C, D, T4 Entity, T_a = 50 °C CLASS I, ZONE 1, AEx ib [ia], GRP IIC, T4 control dwg. 201.004-110</p> <p>WARNING: DO NOT USE IN OXYGEN ENRICHED ENVIRONMENTS WITH OXYGEN CONCENTRATION MORE THAN 21% BY VOLUME.</p> <p>SP NI, CI I, DIV 2, GRP A, B, C, D with IS circuits extending into DIV 1 AIS, CI I, Zone 1, Ex ib [ia] IIC T4 control dwg. 201.004-120</p> <p>NI, CI I, Zone 2, Ex na [ia] IIC</p>																			
Oxy sensor																			
cathode																			
anode																			
guard shield DGND data RTD RTD																			
input																			
- (0) 4 to + 20 mA																			
2		8		12		13		14		15		16		17		18		19	

Attaching the Terminal Plates

The terminal plates of the lower modules can be stuck to the inner side of the door. This facilitates maintenance and service.



Inserting the Module

Note: Be sure to connect the shielding properly!

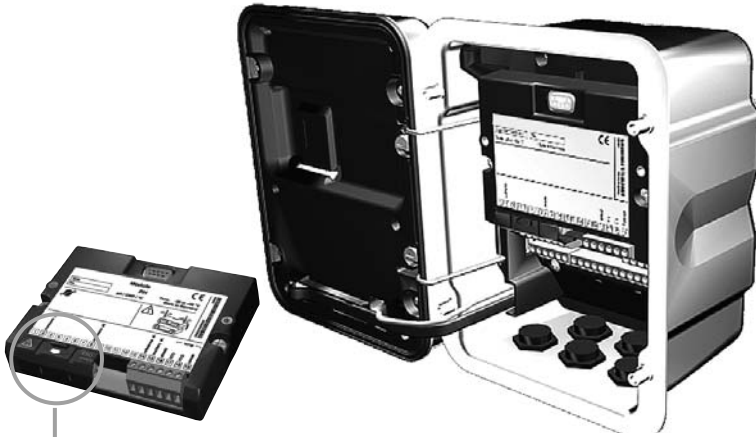

The terminals 2 and 8 are covered by an ESD shield. To connect the sensor cable, just pull it back.

Make sure that the cable glands are tightly closed to protect against humidity.

- 1.** Switch off power supply
- 2.** Open the device (loosen the 4 screws at the front)
- 3.** Place module in slot (D-SUB connector)
- 4.** Tighten fastening screws of the module
- 5.** Open ESD shielding cap (covering terminals 2 and 8)
- 6.** Connect sensor cable.
To avoid interferences, the cable shielding must be completely covered by the ESD shielding cap.
- 7.** Close ESD shielding cap (covering terminals 2 and 8)
- 8.** Close device, tighten screws at the front
- 9.** Switch on power supply
- 10.** Set parameters

Wiring Example

Mettler Toledo InPro 6800 and ISM Sensors
VP8 connection

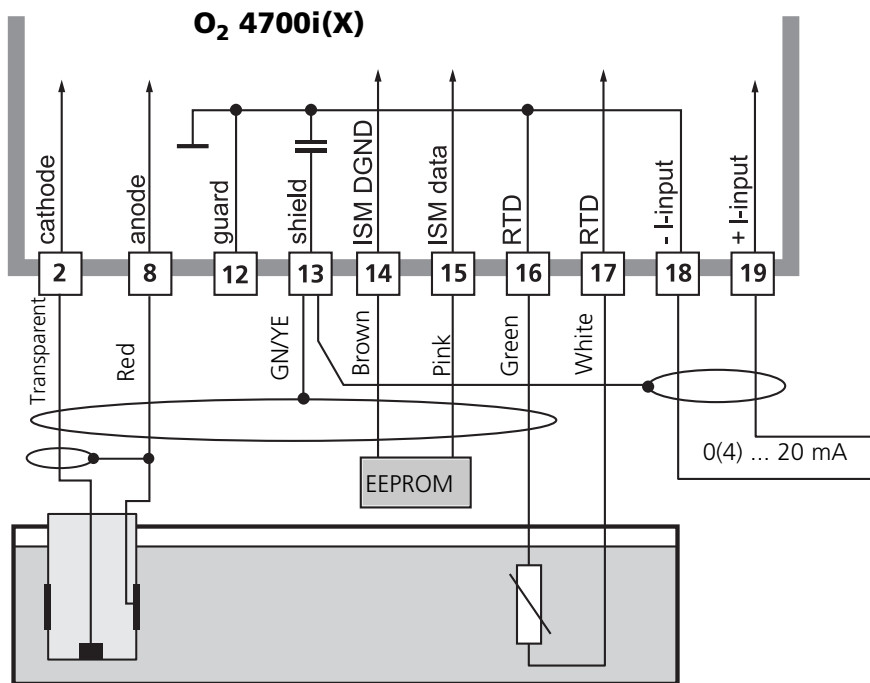

The signal from an external pressure transmitter can be fed in through the external current input. This allows pressure correction of the oxygen measurement.

Notice:

Without ISM functionality compatible to VP6 connection, then terminals 14 and 15 are not connected.

Wiring Example

Mettler Toledo InPro 6850i
digital ISM sensors, K8S connection

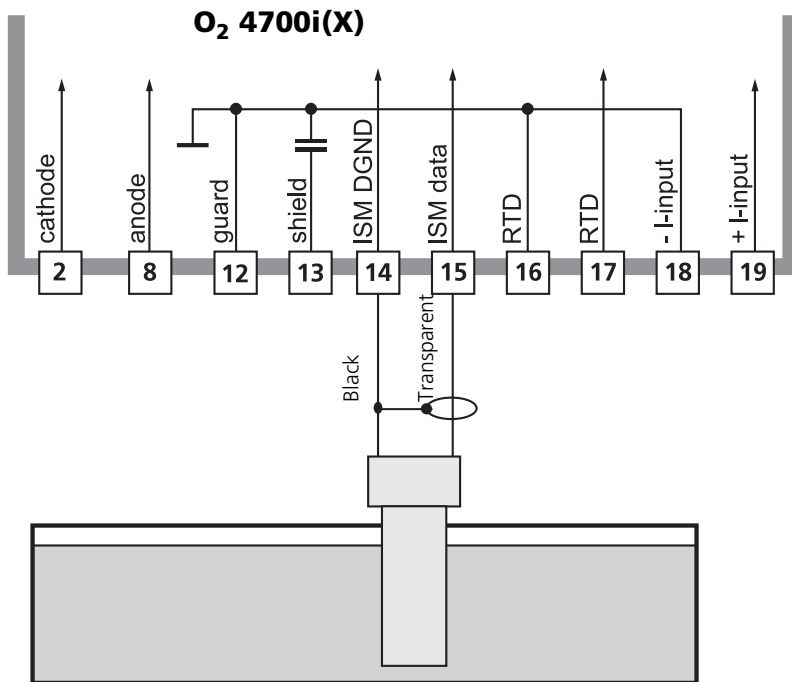

Menu Selection

After switching on, the analyzer performs an internal test routine and automatically detects the number and type of modules installed. Then, the analyzer goes to measuring mode.

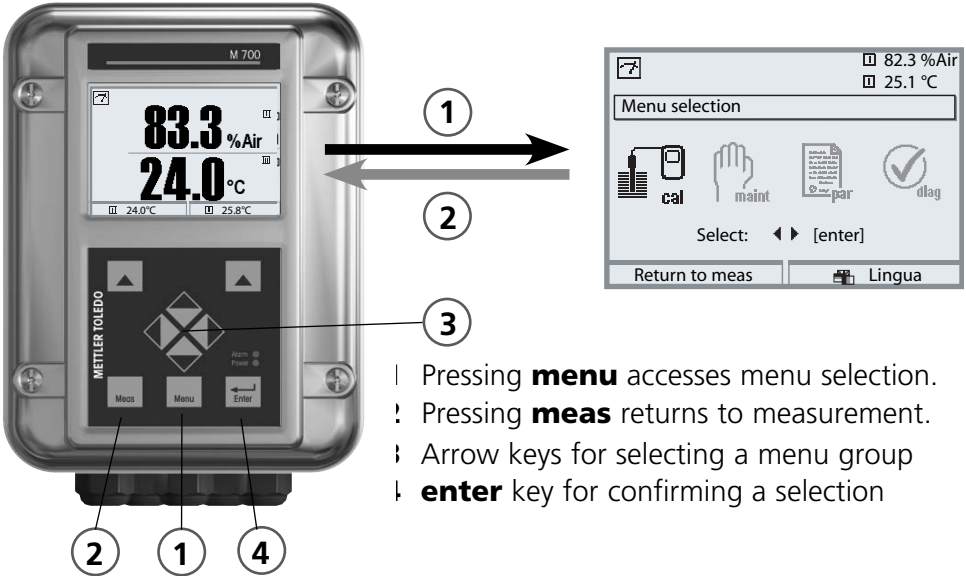

Menu Structure

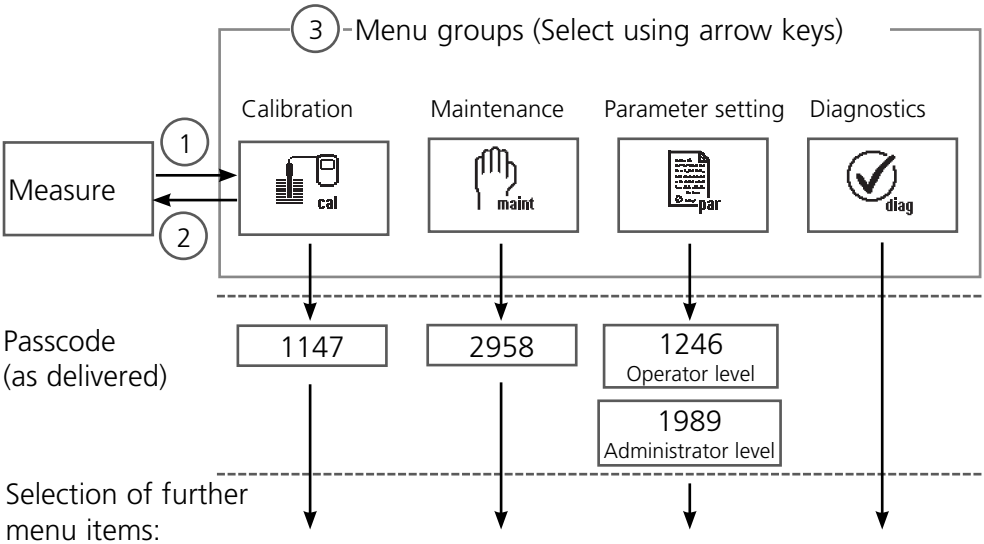

Passcode Entry

To enter a passcode

Select the position using the left/right keys, then edit the number using the up/down keys.

When all numbers have been entered, confirm with **enter**.

To change a passcode

- Open the menu selection (**menu**)
- Select parameter setting
- Administrator level, enter passcode
- Select System control: Passcode entry

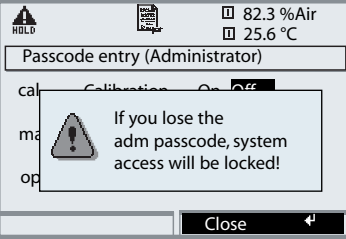
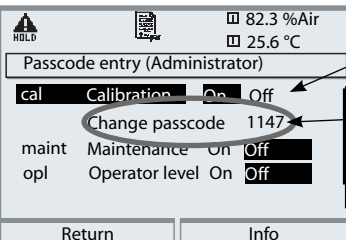
Menu	Display	System control: Passcode entry								
	 	<h3>Changing a passcode</h3> <h4>“Passcode entry” menu</h4> <p>When this menu is opened, the analyzer displays a warning (Fig.). Passcodes (factory settings):</p> <table><tr><td>Calibration</td><td>1147</td></tr><tr><td>Maintenance</td><td>2958</td></tr><tr><td>Operator level</td><td>1246</td></tr><tr><td>Administrator level</td><td>1989</td></tr></table> <h4>If you lose the passcode</h4> <p>for the Administrator level, system access will be locked! Please consult our technical support!</p> <h4>To change a passcode</h4> <p>Select “On” using arrow keys, confirm with enter.</p> <p>Select the position using the left/right keys, then edit the number using the up/down keys.</p> <p>When all numbers have been entered, confirm with enter.</p>	Calibration	1147	Maintenance	2958	Operator level	1246	Administrator level	1989
Calibration	1147									
Maintenance	2958									
Operator level	1246									
Administrator level	1989									

Configuring the Measurement Display

Select menu: Parameter setting/Module FRONT/Measurement display

Pressing **meas** (1) returns the analyzer to the measuring mode from any function.

All process variables coming from the modules can be displayed. The table on the next page describes how to configure the measurement display.



Measurement display



Typical measurement display

Secondary displays

Additional values, also date and time, can be displayed depending on the modules installed.

Softkeys

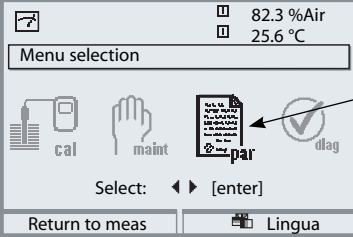
In measuring mode, the softkeys allow selection of values for the secondary displays or control of functions (user defined).

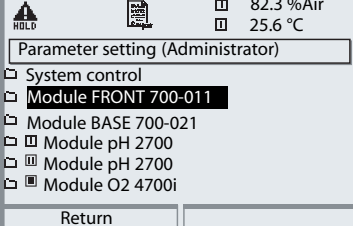
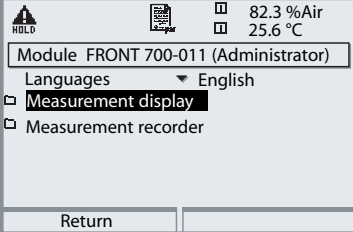
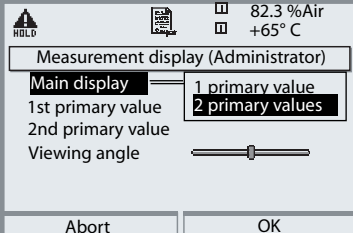
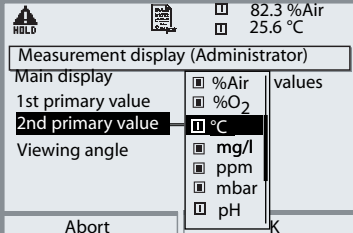
Menu	Display	Configure measurement display
		<p>Configure measurement display Press menu key to Menu selection Select parameter setting using arrow keys, confirm with enter. Select: “Administrator level”: Passcode 1989 (default setting).</p>
		<p>Parameter setting: Select “Module FRONT”</p>
		<p>Front module: Select “Measurement display”</p>
		<p>Measurement display: Set the number of primary values (large display) to be displayed</p>
		<p>Select process variable(s) to be displayed and confirm with enter. Note: Automatic range selection ppm <--> % and ppm <--> ppb; only suitable unit can be selected! To return to measurement: meas</p>

Calibration / Adjustment

Note: HOLD mode active for the currently calibrated module
Current outputs and relay contacts behave as configured

- **Calibration:** Detecting deviations without readjustment
- **Adjustment:** Detecting deviations with readjustment

Attention:

Without adjustment every dissolved oxygen meter delivers an imprecise or wrong output value! After replacing the sensor, the electrolyte, or the sensor membrane, you must perform a calibration.

The resulting values must be taken over by an adjustment for calculating the measured variables (measured value display, output signals)!

Procedure

Every dissolved oxygen sensor has its individual slope and zero point. Both values are altered, for example, by aging. For sufficiently high accuracy of oxygen measurement, the meter must be regularly adjusted for the sensor data (calibration + adjustment).

Sensor Replacement (First Calibration)

After replacement of the sensor, electrolyte or sensor membrane, a "First Calibration" should be performed. During First Calibration, the sensor data are stored as reference values for the statistics.

The "Statistics" menu of Diagnostics shows the deviations of zero, slope, calibration temperature, calibration pressure, and response time of the last three calibrations with respect to the reference values of the First Calibration. This allows evaluation of the drift behavior and aging of the sensor.

Calibration/Adjustment Methods

- Automatic calibration in water/air
- Product calibration (saturation/concentration)
- Data entry
- Zero correction

Adjustment

Adjustment means that the values determined by a calibration are taken over. The values determined for zero and slope are entered in the calibration record. (Cal record can be called up in the Diagnostics menu for the module.)

These values are only effective for calculating the measured variables when the calibration has been terminated with an adjustment.

A passcode ensures that an adjustment can only be performed by an authorized person (Administrator).

The Operator can check the current sensor data by a calibration and inform the Administrator when there are deviations.

You can use the additional function SW 700-107 for granting access rights (passcodes) and for Audit Trail (continuous data recording and backup according to FDA 21 CFR Part 11).

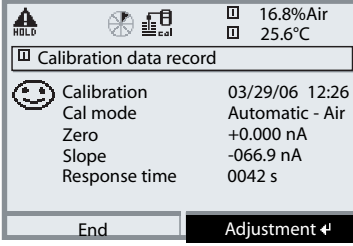
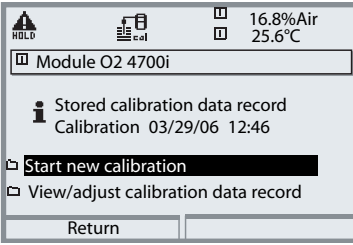
Menu	Display	Adjustment after calibration
		<p>Administrator</p> <p>With the corresponding access rights, the device can immediately be adjusted after calibration. The calibration values are taken over for calculating the measured variables.</p>
		<p>Operator (without administrator rights)</p> <p>After calibration, change to measuring mode. Inform Administrator. When opening the menu (Calibration, respective module), the Administrator sees all data of the last calibration and can take over the values or perform a new calibration.</p>

Adjustment

Recommendations for Calibration

It is always recommended to calibrate in air. Compared to water, air is a calibration medium which is easy to handle, stable, and thus safe. In the most cases, however, the sensor must be dismantled for a calibration in air. In certain processes the sensor cannot be removed for calibration. Here, calibration must be performed directly in the process medium (e.g. with aeration). For applications where concentration is measured, calibration in air has proved to be useful.

Common Combination: Process Variable / Calibration Mode

Measurement	Calibration
Saturation	Water
Concentration	Air

If there is a temperature difference between the calibration medium and the measured medium, the sensor must be kept in the respective medium for several minutes before and after calibration in order to deliver stable measured values. The type of calibration pressure detection is preset during parameter setting.

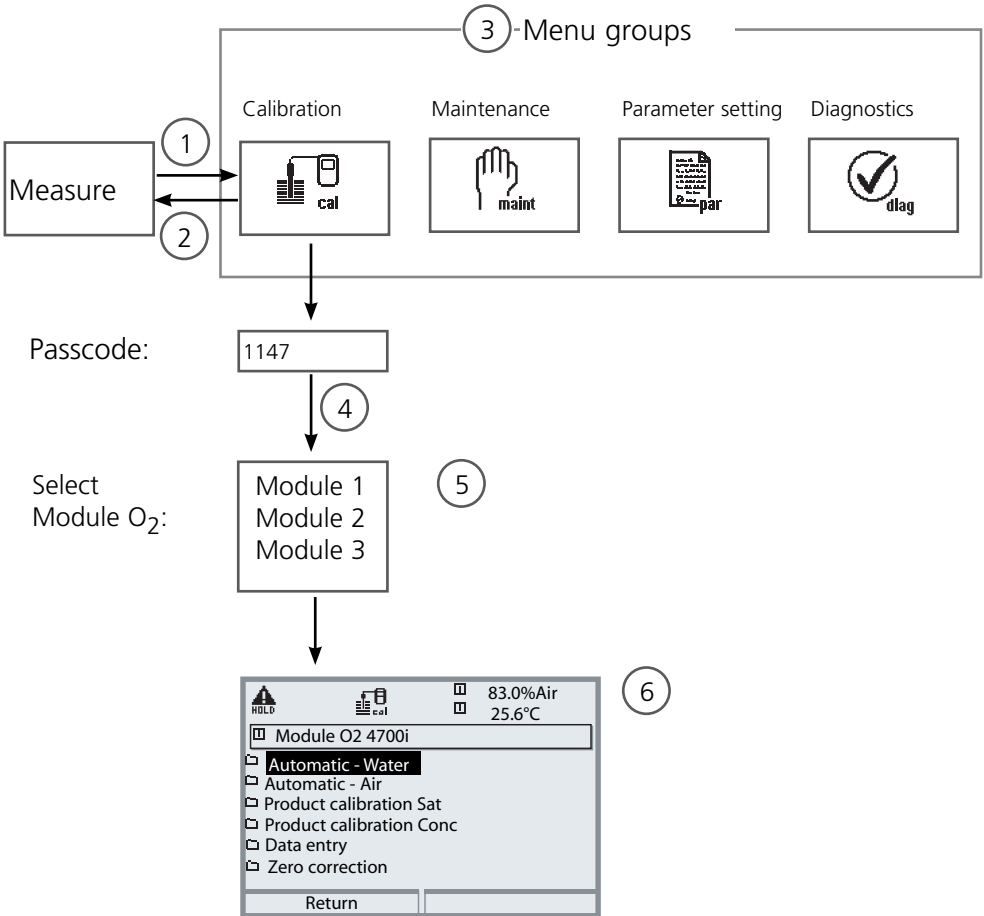

Calibration / Adjustment

Selecting a Calibration Method

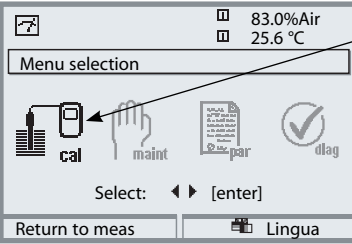

O₂ module calibration: Select a calibration method

- (1) Press **menu** key to access menu selection
- (2) Pressing the **meas** key returns to measurement
- (3) Select Calibration menu group using the arrow keys
- (4) Press **enter** to confirm, enter passcode
- (5) Select O₂ module, confirm with **enter**.
- (6) Select calibration method

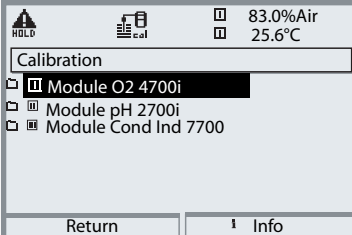
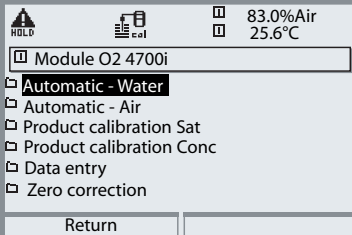
Menu	Display	Select a calibration method
	 <p>83.0%Air 25.6°C</p> <p>Menu selection</p> <p>cal maint pair diag</p> <p>Select: ◀ ▶ [enter]</p> <p>Return to meas Lingua</p>	<p>Call up calibration</p> <p>Press menu key to select menu. Select calibration using arrow keys, confirm with enter, passcode 1147 (To change passcode, select: Parameter setting / System control / Passcode entry).</p> <p>After passcode entry, the module is in HOLD mode: Current outputs and relay contacts of the currently calibrated module behave as configured (BASE) until the Calibration menu is exited.</p>
	 <p>HOLD cal 83.0%Air 25.6°C</p> <p>Calibration</p> <p>Module O2 4700i</p> <p>Module pH 2700i</p> <p>Module Cond Ind 7700</p> <p>Return Info</p>	<p>Calibration:</p> <p>Select "Module O₂"</p>
	 <p>HOLD cal 83.0%Air 25.6°C</p> <p>Module O2 4700i</p> <p>Automatic - Water</p> <p>Automatic - Air</p> <p>Product calibration Sat</p> <p>Product calibration Conc</p> <p>Data entry</p> <p>Zero correction</p> <p>Return</p>	<p>Select a calibration method:</p> <ul style="list-style-type: none"> • Automatic - Water • Automatic - Air • Product calibration: Saturation • Product calibration: Concentration • Data entry • Zero correction <p>When you call up calibration, the analyzer automatically proposes the previous calibration method. If you do not want to calibrate, "Return" with the left softkey.</p>

Calibration / Adjustment

Automatic Calibration in Water

Automatic Calibration in Water

The slope is corrected using the saturation value (100 %) related to air saturation.

During calibration the module is in HOLD mode.

Current outputs and relay contacts of the module behave as configured (BASE module).

Caution!

Ensure sufficient medium flow to the sensor (see Specifications of dissolved oxygen sensors)! The calibration medium must be in equilibrium with air. Oxygen exchange between water and air is very slow. Therefore, it takes a relatively long time until water is saturated with atmospheric oxygen. If there is a temperature difference between calibration medium and measured medium, the sensor must be kept in the respective medium for several minutes before and after calibration.

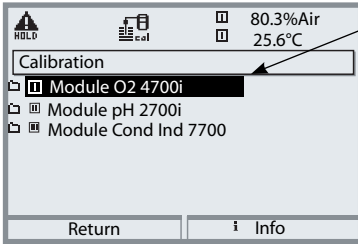
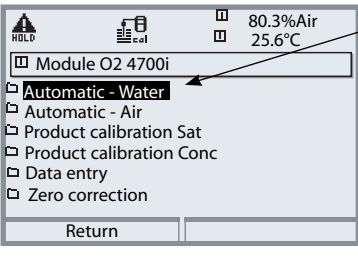
Menu	Display	Select calibration mode
		Select module: O₂ 4700i The module is in HOLD mode. Current outputs and relay contacts of the currently calibrated module behave as configured (BASE). Confirm with enter
		Select "Automatic - Water" calibration method Remove sensor and immerse it in cal medium (air-saturated water), ensure sufficient medium flow to the sensor. Confirm with enter

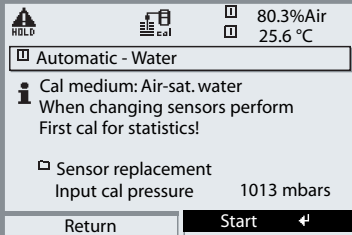
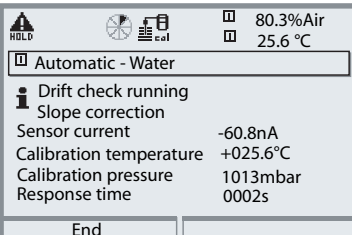
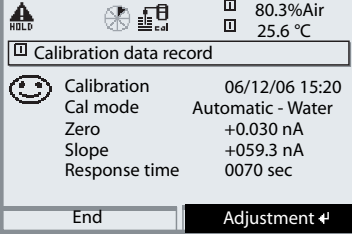
Menu	Display	Automatic calibration in water
	 <p>80.3%Air 25.6 °C</p> <p>Automatic - Water</p> <p>Cal medium: Air-sat. water When changing sensors perform First cal for statistics!</p> <p>Sensor replacement Input cal pressure 1013 mbars</p> <p>Return Start ↵</p>	<p>Display of selected calibration medium (Air-sat. water) Enter cal pressure if "manual" has been configured. Start with softkey or enter</p>
	 <p>80.3%Air 25.6 °C</p> <p>Automatic - Water</p> <p>Drift check running Slope correction Sensor current -60.8nA Calibration temperature +025.6°C Calibration pressure 1013mbar Response time 0002s</p> <p>End</p>	<p>Drift check. Display during calibration</p> <ul style="list-style-type: none"> • Sensor current • Calibration temperature • Calibration pressure • Response time <p>Waiting time can be reduced by pressing enter (without drift check: reduced accuracy of calibration values!). From the response time, you see how long it takes the sensor to deliver a stable signal. If the signal or the measured temperature fluctuate greatly, the calibration procedure is aborted after 2 min. Calibration must be re-started. If successful, place sensor in process, end calibration with softkey or enter</p>
	 <p>80.3%Air 25.6 °C</p> <p>Calibration data record</p> <p>☺ Calibration 06/12/06 15:20 Cal mode Automatic - Water Zero +0.030 nA Slope +059.3 nA Response time 0070 sec</p> <p>End Adjustment ↵</p>	<p>Adjustment Press "Adjust" to take over the values determined during calibration for calculating the measured variables.</p>

Calibration / Adjustment

Automatic Calibration in Air

Automatic Calibration in Air

The slope is corrected using the saturation value (100 %), similar to air saturation of water. Since this analogy only applies to water-vapor saturated air (100 % relative humidity) and often the calibration air is less humid, the relative humidity of the calibration air must also be specified. If you do not know the exact value of the relative humidity of the calibration air, you can take the following reference values for a sufficiently precise calibration:

- Ambient air: 50 % rel. humidity (average)
- Bottled gas (synthetic air): 0 % rel. humidity

Caution!

The sensor membrane must be dry. Be sure to keep temperature and pressure constant during calibration. If there is a temperature difference between calibration medium and measured medium, the sensor must be kept in the respective medium for several minutes before and after calibration.

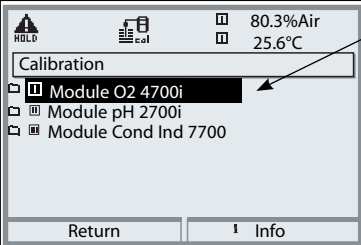
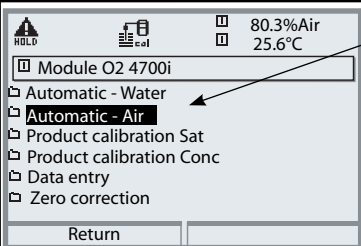
Menu	Display	Select calibration mode
		<p>Select module: O₂ 4700i</p> <p>The module is in HOLD mode. Current outputs and relay contacts of the currently calibrated module behave as configured (BASE). Confirm with enter</p>
		<p>Select "Automatic - Air" calibration method</p> <p>Remove sensor and place it in air.</p> <p>Confirm with enter.</p>

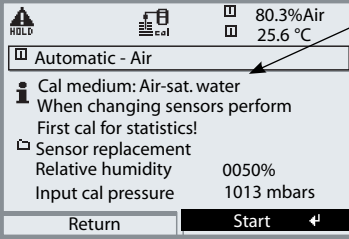
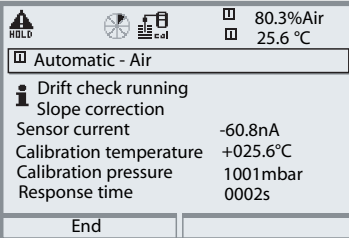
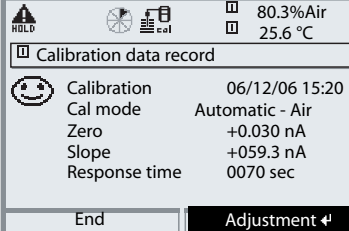
Menu	Display	Automatic calibration in air
	 <p>80.3%Air 25.6 °C</p> <p>Automatic - Air</p> <ul style="list-style-type: none"> Cal medium: Air-sat. water When changing sensors perform First cal for statistics! Sensor replacement <ul style="list-style-type: none"> Relative humidity 0050% Input cal pressure 1013 mbars <p>Return Start ↵</p>	<p>Cal medium: Air</p> <p>Select: First calibration</p> <p>Enter relative humidity, e.g.:</p> <ul style="list-style-type: none"> Ambient air: 50 % Bottled gas: 0 % <p>Enter cal pressure if "manual" has been configured.</p> <p>Start with softkey or enter</p>
	 <p>80.3%Air 25.6 °C</p> <p>Automatic - Air</p> <ul style="list-style-type: none"> Drift check running Slope correction Sensor current -60.8nA Calibration temperature +025.6°C Calibration pressure 1001mbar Response time 0002s <p>End</p>	<p>Drift check.</p> <p>Display during calibration</p> <ul style="list-style-type: none"> Sensor current, calibration temp, cal pressure and response time. <p>Waiting time can be reduced by pressing "End" (without drift check: reduced accuracy of calibration values!). From the response time, you see how long it takes the sensor to deliver a stable signal. If the signal or the measured temperature fluctuate greatly, the calibration procedure is aborted after about 2 min. Calibration must be re-started.</p> <p>If successful, replace sensor in the process. End calibration with softkey or enter</p>
	 <p>80.3%Air 25.6 °C</p> <p>Calibration data record</p> <ul style="list-style-type: none"> Calibration 06/12/06 15:20 Cal mode Automatic - Air Zero +0.030 nA Slope +059.3 nA Response time 0070 sec <p>End Adjustment ↵</p>	<p>Adjustment</p> <p>Press "Adjust" to take over the values determined during calibration for calculating the measured variables.</p>

Calibration / Adjustment

Product Calibration: Saturation

Product Calibration: Saturation (Calibration with Sampling)

When the sensor cannot be removed – e.g. for sterility reasons – its slope can be determined with “sampling”. To do so, the currently measured saturation value of the process is stored by the M 700. Directly afterwards, a reference value is determined using a portable meter, for example. The reference value is entered into the measuring system. From the difference between measured value and reference value, the M 700 calculates the sensor slope. With low saturation values, the M 700 corrects the zero point, with high values the slope.

During calibration the module is in HOLD mode.

Current outputs and relay contacts of the module behave as configured (BASE module).

Caution!

The reference value must be measured at temperature and pressure conditions similar to those of the process.

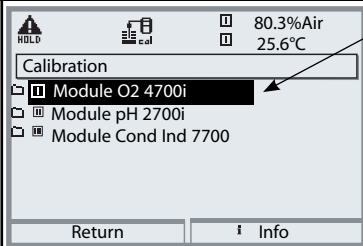
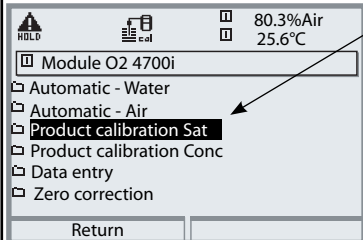
Menu	Display	Product calibration: Saturation
		<p>Select module: O₂ 4700i</p> <p>The module is in HOLD mode. Current outputs and relay contacts of the currently calibrated module behave as configured (BASE). Confirm with enter</p>
		<p>Select “Product calibration Sat” calibration method</p> <p>Confirm with enter.</p>

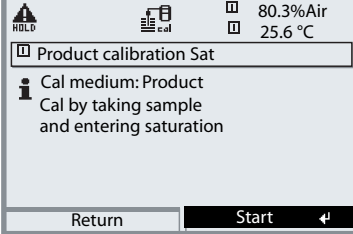
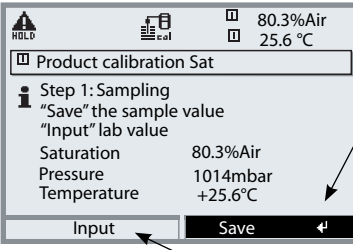
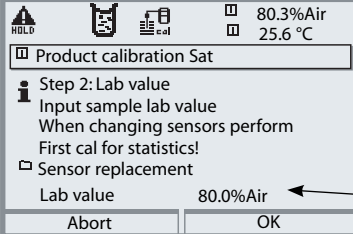
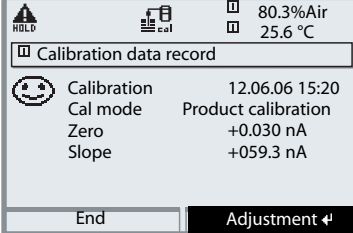
Menu	Display	Product calibration: Saturation
	 	<p>Product calibration Sat</p> <p>Product calibration is performed in 2 steps.</p> <p>Prepare reference measurement (e.g. with portable meter), start with softkey or enter</p> <p>Step 1</p> <p>Take sample.</p> <p>Store measured value and temperature at the moment of sampling ("Save" softkey or enter)</p> <p>Press meas to return to measurement.</p> <p>Exception:</p> <p>Sample value can be measured on the site and be entered immediately. To do so, press "Input" softkey.</p>
		<p>Step 2</p> <p>Lab value has been measured.</p> <p>When you open the Product calibration menu again, the display shown on the left appears:</p> <p>Enter reference value ("Lab value"). Confirm with "OK".</p>
		<p>Adjustment</p> <p>Press "Adjust" to take over the values determined during calibration for calculating the measured variables.</p>

Calibration / Adjustment

Product Calibration: Concentration

Product Calibration: Concentration (Calibration with Sampling)

When the sensor cannot be removed – e.g. for sterility reasons – its slope can be determined with “sampling”. To do so, the currently measured concentration value of the process is stored by the M 700. Directly afterwards, a reference value is determined using a portable meter, for example. The reference value is entered into the measuring system. From the difference between measured value and reference value, the M 700 calculates the sensor slope. With low concentration values, the M 700 corrects the zero point, with high concentrations the slope.

During calibration the module is in HOLD mode.

Current outputs and relay contacts of the module behave as configured (BASE module).

Caution!

The reference value must be measured at temperature and pressure conditions similar to those of the process.

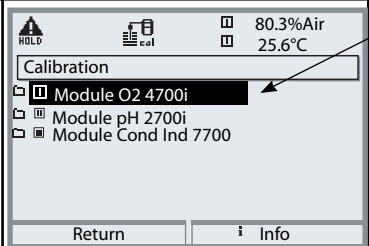
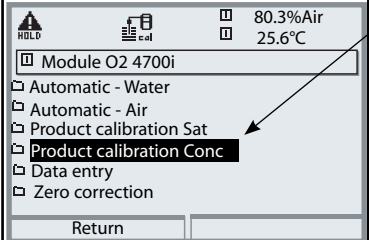
Menu	Display	Product calibration: Concentration
		Select module: O₂ 4700i The module is in HOLD mode. Current outputs and relay contacts of the currently calibrated module behave as configured (BASE). Confirm with enter
		Select “Product calibration Conc” calibration method Confirm with enter

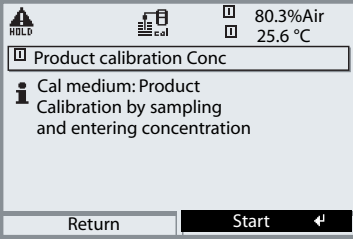
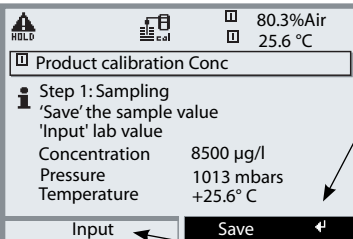
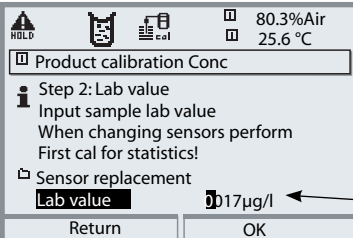
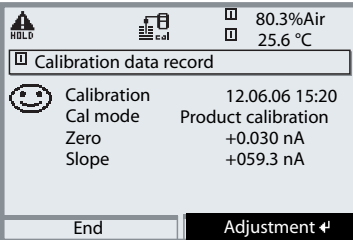
Menu	Display	Product calibration: Concentration
	 	<p>Product calibration Conc</p> <p>Product calibration is performed in 2 steps.</p> <p>Prepare reference measurement (e.g. with portable meter), start with softkey or enter</p> <p>Step 1</p> <p>Take sample.</p> <p>Store measured value and temperature at the moment of sampling ("Save" softkey or enter)</p> <p>Press meas to return to measurement.</p> <p>Exception:</p> <p>Sample value can be measured on the site and be entered immediately. To do so, press "Input" softkey.</p>
	 	<p>Step 2</p> <p>Enter reference value ("Lab value").</p> <p>When you open the Product calibration menu again, the display shown on the left appears:</p> <p>Enter reference value ("Lab value"). Confirm with "OK".</p> <p>Adjustment</p> <p>Press "Adjust" to take over the values determined during calibration for calculating the measured variables.</p>

Calibration / Adjustment

Data Entry of Premeasured Sensors
(not required for ISM sensors)

Data Entry of Premeasured Sensors

Entry of values for slope and zero point of a sensor, related to 25°C, 1013 mbars.

During calibration the module is in HOLD mode.

Current outputs and relay contacts of the module behave as configured (BASE module).

Slope = Sensor current at 100 % atmospheric oxygen, 25 °C, 1013 mbars

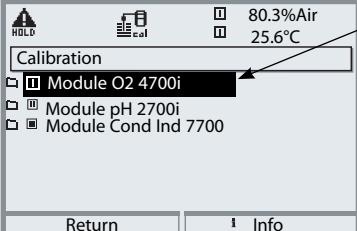
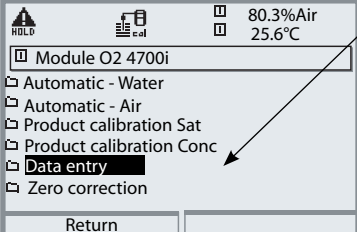
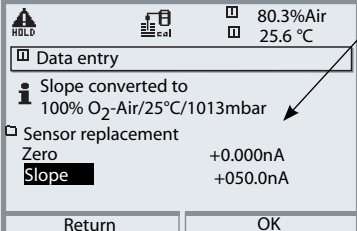
Menu	Display	Data entry of premeasured sensors
	 <p>Calibration</p> <ul style="list-style-type: none"> Module O2 4700i Module pH 2700i Module Cond Ind 7700 <p>Return Info</p>	<p>Select module: O₂ 4700i</p> <p>The module is in HOLD mode. Current outputs and relay contacts of the currently calibrated module behave as configured (BASE). Confirm with enter</p>
	 <p>Module O2 4700i</p> <ul style="list-style-type: none"> Automatic - Water Automatic - Air Product calibration Sat Product calibration Conc Data entry Zero correction <p>Return</p>	<p>Select "Data entry" calibration method</p> <p>Confirm with enter</p>
	 <p>Data entry</p> <p>Slope converted to 100% O₂-Air/25°C/1013mbar</p> <p>Sensor replacement</p> <p>Zero +0.000nA</p> <p>Slope +050.0nA</p> <p>Return OK</p>	<p>Enter the values for</p> <ul style="list-style-type: none"> • Slope • Zero <p>of premeasured sensor</p> <p>Confirm with "OK".</p>

Calibration / Adjustment

Zero Correction

Zero Correction

The series InPro 6xxx sensors have a very low zero current. For trace measurements below 500 ppb, the zero point should be calibrated. If a zero correction is performed, the sensor should remain for at least 10 to 60 minutes in the calibration medium (media containing CO₂ at least 120 min) to obtain stable, non-drifting values. During zero correction, a drift check is not performed.

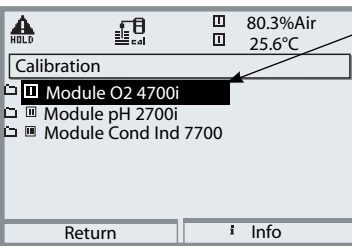
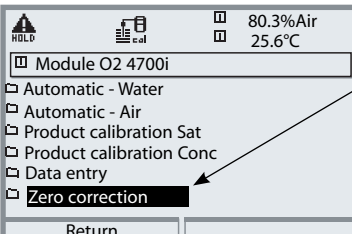
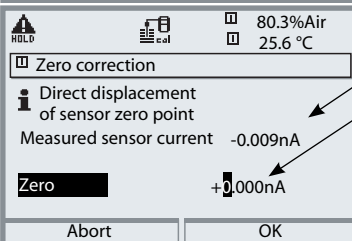
Menu	Display	Zero correction
	 <p>Calibration</p> <ul style="list-style-type: none">Module O2 4700iModule pH 2700iModule Cond Ind 7700 <p>Return Info</p>	<p>Select module: O₂ 4700i</p> <p>The module is in HOLD mode. Current outputs and relay contacts of the currently calibrated module behave as configured (BASE). Confirm with enter</p>
	 <p>Module O2 4700i</p> <ul style="list-style-type: none">Automatic - WaterAutomatic - AirProduct calibration SatProduct calibration ConcData entryZero correction <p>Return</p>	<p>Select "Zero correction" calibration method</p> <p>Confirm with enter</p>
	 <p>Zero correction</p> <p>Direct displacement of sensor zero point</p> <p>Measured sensor current -0.009nA</p> <p>Zero +0.000nA</p> <p>Abort OK</p>	<p>Zero correction: Display of measured sensor current.</p> <ul style="list-style-type: none">Enter input current for zero point <p>Confirm with "OK".</p>

Parameter Setting: Operating Levels

Viewing level, Operator level, Administrator level

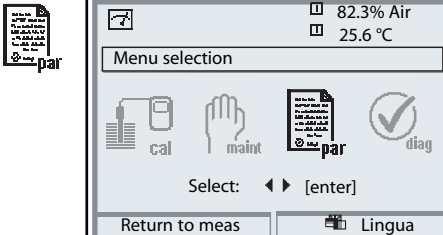
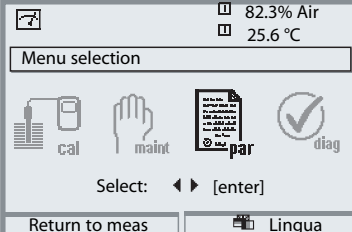
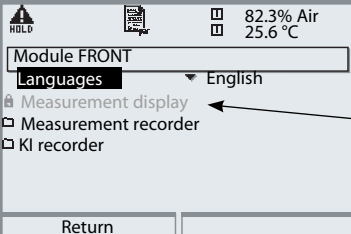
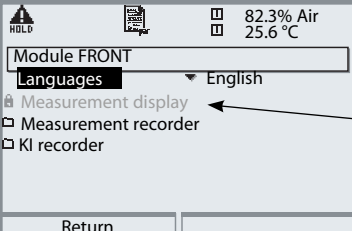
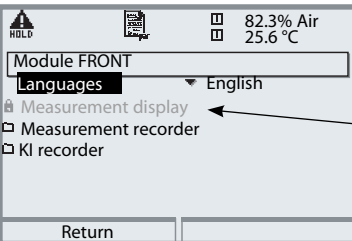

Note: HOLD mode (Setting: BASE module)

Menu	Display	Viewing level, Operator level, Administrator level
		<p>Call up parameter setting</p> <p>From the measuring mode: Press menu key to select menu. Select parameter setting using arrow keys, confirm with enter.</p>
		<p>Administrator level</p> <p>Access to all functions, also passcode setting. Releasing or blocking a function for access from the Operator level.</p>
		<p>Functions which can be blocked for the Operator level are marked with the "lock" symbol. The functions are released or blocked using the softkey.</p>
		<p>Operator level</p> <p>Access to all functions which have been released at the Administrator level. Blocked functions are displayed in gray and cannot be edited (Fig.).</p> <p>Viewing level</p> <p>Display of all settings. No editing possible!</p>

Parameter Setting: Lock Functions

Administrator level: Enable / lock functions for Operator level

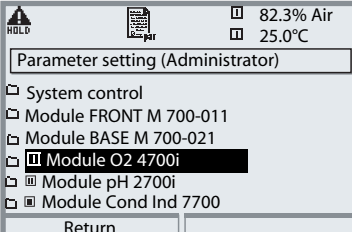
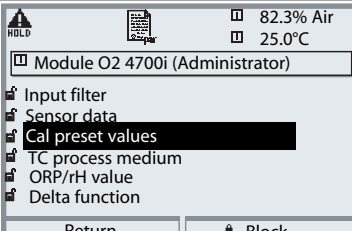
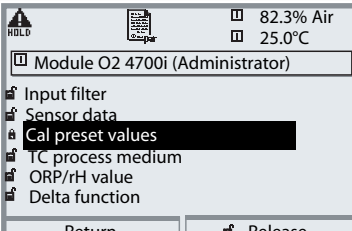
Note: HOLD mode (Setting: BASE module)

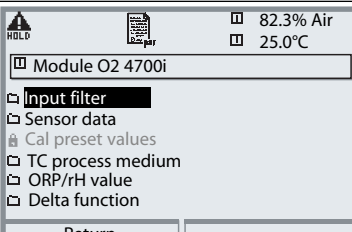
Menu	Display	Administrator level: Enable / lock functions
		<p>Example: Blocking access to the calibration adjustments from the Operator level</p> <p>Call up parameter setting Select Administrator level. Enter passcode (1989). Select "Module O₂" (e.g.) using arrow keys, confirm with enter.</p>
		<p>Select "Cal preset values" using arrow keys. "Block" with softkey.</p>
		<p>Now, the "Cal preset values" line is marked with the "lock" icon. This function cannot be accessed from the Operator level any more. The softkey function changes to "Release".</p>
		<p>Call up parameter setting Select <u>Operator level</u>, passcode (1246). Select "Module O₂". Now, the locked function is displayed in gray and marked with the "lock" icon.</p>

Activating Parameter Setting

Call up parameter setting

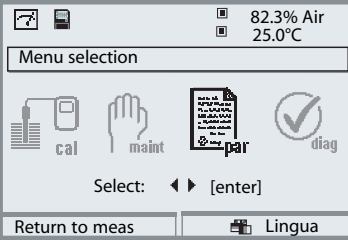
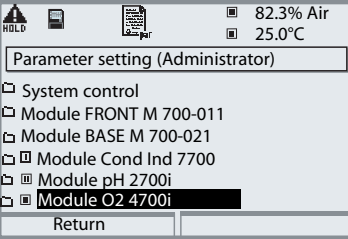
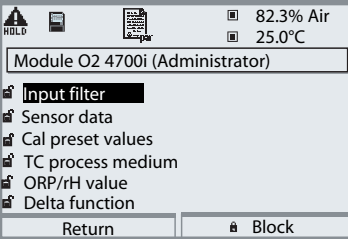
Menu	Display	Parameter setting
		<p>Call up parameter setting</p> <p>From the measuring mode: Press menu key to select menu. Select parameter setting using arrow keys, confirm with enter. Passcode as delivered: 1989</p>
		<p>Select module, confirm with enter.</p> <p>(In the Figure, the Module "O₂" is selected, for example.)</p>
		<p>Select parameter using arrow keys, confirm with enter.</p>

During parameter setting the analyzer is in HOLD mode:

Current outputs and relay contacts behave as configured (BASE module).

Documenting Parameter Setting

You must reproducibly document all parameter settings in the device to achieve a high level of system and device security according to GLP. For that purpose, an Excel file is provided (on the CD-ROM shipped with the basic device or as download at www.mt.com/pro) to enter the parameter settings.

The Excel file provides one worksheet for each module with columns for the following parameters: Factory settings, parameter set A, parameter set B. Enter your settings as parameter set A or B.

The gray cells in the parameter set B column cannot be modified since they contain sensor-specific values which cannot be changed by parameter set switchover. Here, the values listed under parameter set A apply.

Documenting Parameter Setting

	A	B	C	D	E	F
1						
2	1.	Meßstelle:				Zugriff über Menüpunkt:
3		M 700				
4	1.1.	parametrier am / von:				
5						
6						
7	2.	Gerätebeschreibung	Hardware	Software	Seriennummer	Diagnose / Gerätebeschreibung
8	2.1.	Bedienfront 700-011 :				Diagnose / Gerätebeschreibung / Front
9	2.2.	M 700 Base 700-021 :				Diagnose / Gerätebeschreibung / Base
10	2.3.	Modul Steckplatz [I] :				Diagnose / Gerätebeschreibung / I
11	2.4.	Modul Steckplatz [II] :				Diagnose / Gerätebeschreibung / II
12	2.5.	Modul Steckplatz [III] :				Diagnose / Gerätebeschreibung / III
13						
14						
15		M 700 Front				
16	3.	M 700 Front Einstellungen	Werkseinstellung	Parametersatz A	Parametersatz B	
17	3.1.	Sprache:	Deutsch			Parametrierung (Spezialist) / Modul Front ...
18						
19	3.1.1	Meßwertanzeige:				
20		Hauptanzeige	2 Hauptmeßwerte			Parametrierung (Spezialist) / Modul Front ... / Meß
21		1. Hauptmeßwert (Modul/Wert):	modulabhängig			
22		2. Hauptmeßwert (Modul/Wert):	modulabhängig			
23		Anzeigeformat (pH)	xx.xx pH			
24		Blickwinkel	Mitte			
25						
26	3.3.	Nebenanzeige				Einstellung erfolgt über Softkeys, wenn in Matrixfu
27		Anzeigewert, links	-			
28		Anzeigewert, rechts	-			
29						
30	3.4	Meßwertrecorder:	Option SW700-103			Parametrierung (Spezialist) / Modul Front ... / Meß
31		Zeitbasis (t / Pixel)	1 min			
32		Zeitlupe (10x)	Aus			
33		Min / Max anzeigen	Ein			
34	3.4.1	Kanal 1: Meßgröße	modulabhängig			
35		Anfang	0.00			
36		Ende	14.00			
37	3.4.2	Kanal 2: Meßgröße	modulabhängig			
38		Anfang	-50.0			
39		Ende	150.0			

From the application window of the Excel file, select the worksheet for the module the parameter settings of which you want to document. Set the parameters of the respective module and enter the selected values in the corresponding cells of the module worksheet.

Caution!

Display	During parameter setting the "HOLD" mode is active.
	<p>HOLD. The NAMUR "function check" contact is active (factory setting: Module BASE, Contact K2, N/O contact). Current output response is user-defined:</p> <ul style="list-style-type: none"> • Current meas.: The currently measured value appears at the current output • Last usable value: The last measured value is held at the current output • Fixed 22 mA: The output current is at 22 mA

Module Configuration: Operating Mode

Call up parameter setting

Note: HOLD mode

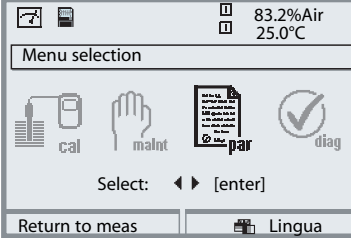
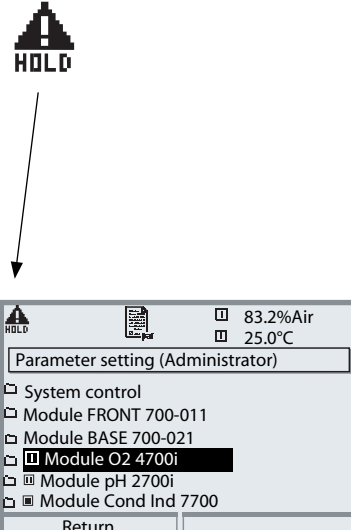
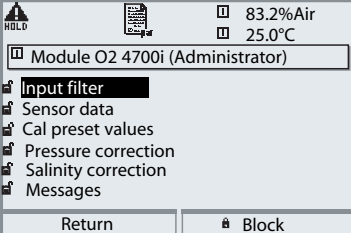
Menu	Display	Parameter setting
		<p>Call up parameter setting</p> <p>From the measuring mode: Press menu key to select menu. Select parameter setting using arrow keys, confirm with enter. Passcode 1989 (To change passcode: Parameter setting/System control/Passcode entry).</p>
		<p>HOLD</p> <p>During parameter setting the analyzer is in "HOLD" mode. Current outputs and relay contacts behave as configured.</p> <p>Select "Module O₂ 4700i". Confirm with enter</p>
		<p>Select "Operating mode" using arrow keys, confirm with enter.</p>

Setting the Sensor Data Parameters

Sensor data: Sensor monitoring details

Note: HOLD mode active

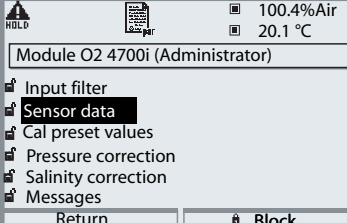
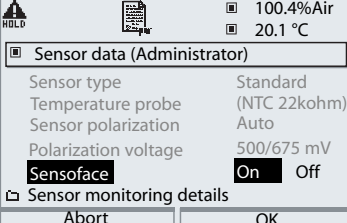
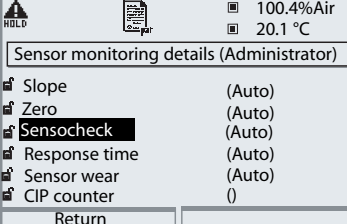
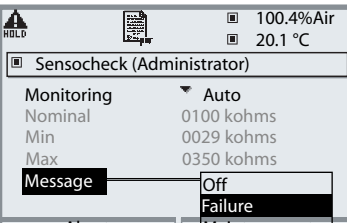
Menu	Display	Parameter selection
	 <p>Module O2 4700i (Administrator)</p> <ul style="list-style-type: none"> Input filter Sensor data Cal preset values Pressure correction Salinity correction Messages <p>Return Block</p>	<p>Sensor data (see following page) Sensor data are preset depending on the sensor type. Gray display lines cannot be edited.</p>
	 <p>Sensor data (Administrator)</p> <ul style="list-style-type: none"> Sensor type Standard Temperature probe (NTC 22kohm) Sensor polarization Auto Polarization voltage 500/675 mV Sensoface On Off <p>Sensor monitoring details</p> <p>Abort OK</p>	<p>Sensoface provides information on the sensor condition (evaluating the sensor data). Great deviations are signaled. Sensoface can be switched off.</p>
	 <p>Sensor monitoring details (Administrator)</p> <ul style="list-style-type: none"> Slope (Auto) Zero (Auto) Sensocheck (Auto) Response time (Auto) Sensor wear (Auto) CIP counter () <p>Return</p>	<p>Sensor monitoring details The following parameters are monitored: Slope, zero, response time, for ISM sensors also sensor wear, CIP/SIP counter, autoclaving counter, and sensor operating time. For "Auto", the tolerance limits are displayed in gray. For "Individual", the settings can be specified by the user.</p>
	 <p>Sensocheck (Administrator)</p> <ul style="list-style-type: none"> Monitoring ▼ Auto Nominal 0100 kohms Min 0029 kohms Max 0350 kohms Message Off Failure <p>Abort Maint.request</p>	<p>ISM ISM sensors automatically provide most of the default settings. Individual settings are <u>not</u> overwritten.</p> <p>Message Sensocheck can generate a message for failure or maintenance request. It can be seen in the Message list of the Diagnostics menu.</p>

Sensor Data Settings

ISM ISM sensors automatically provide most of the default settings. Individual entries are not overwritten by the ISM sensor.

Parameter	Default	Selection / Range
Input filter <ul style="list-style-type: none"> • Pulse suppression • Input filter 	Weak 010 sec	Off, Weak, Medium, Strong xxx sec (entry)
Sensor data <ul style="list-style-type: none"> • Measure in • Sensor type • Monitor sensor type • Temperature probe • Membrane correction • Sensor polarization • Polarization voltage • Sensoface 	Liquids Standard Off NTC 22 kohms 01.00 Auto 0675 mV Off	Liquids, Gases (Vol%), Gases (ppm) Standard, Trace sensor, Other, or defined by ISM Monitoring, Off (for ISM sensors only) NTC 30 kohms, NTC 22 kohms Auto, Individual xxxx mV (entry) Off, Failure, Maint. request
Sensor monitoring Details <ul style="list-style-type: none"> • Slope <ul style="list-style-type: none"> - Message: • Zero <ul style="list-style-type: none"> - Message: • Sensocheck <ul style="list-style-type: none"> - Message: • Response time <ul style="list-style-type: none"> - Message: 	Auto Maint. request Auto Maint. request Auto Maint. request Auto Failure	Auto, Individual Off, Failure, Maint. request Auto, Individual Off, Failure, Maint. request Auto, Individual Off, Failure, Maint. request Auto, Individual Off, Failure, Maint. request
Cal preset values <ul style="list-style-type: none"> • Cal saturation • Cal concentration • Cal timer <ul style="list-style-type: none"> - Monitoring - Cal timer 	%AIR mg/l, µg/l Auto 0000 h	%Air mg/l, µg/l, ppm, ppb Off, Auto, Individual With ISM: Off, Without ISM: xxxx h (entry)
Pressure correction <ul style="list-style-type: none"> • Pressure transmitter I input Start 0(4) mA End 20 mA • Pressure during meas • Pressure during cal 	Difference 4 ... 20 mA 0000 mbar 9999 mbars Air pressure Air pressure	Absolute, Difference 0 ... 20 mA / 4 ... 20 mA xxxx mbars xxxx mbars Air pressure, Manual (default 1013 mbars), External Air pressure, Manual (default 1013 mbars), External
Salinity correction <ul style="list-style-type: none"> • Input 	Salinity	Salinity, Chlorinity, Conductivity (00.00 g/kg or 0.000 µS/cm, depending on selection)

Sensoface 😊

Sensoface is a graphic indication of the sensor condition.

Prerequisite: Sensocheck must have been activated during parameter setting.

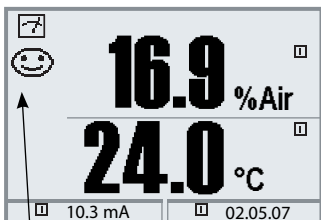

Sensocheck:

Monitoring of membrane and electrolyte

The “smileys” provide information on wear and required maintenance of the sensor (“friendly” - “neutral” - “sad”).

Sensoface Criteria (adjustable - see Sensor monitoring)

Parameter	Critical range	
	Sensor Type A	Sensor Type B
Slope*	< -30 nA or > 110 nA	< -225 nA or > 525 nA
Zero	< -0.6 nA or > 0.6 nA	< -1 nA or > 1 nA
Sensocheck (Ref. impedance)	0.3*R or > 3.5*R however always R < 20 kohms or > 4 Mohms, resp.	
Response time	> 600 sec	
Calibration timer	when 80 % expired	
Sensor wear	as specified (ISM sensors only)	

* “Slope”: Sensor current value with oxygen saturation (referred to air), 25°C, and 1013 mbars normal pressure (nA /100 %) The display only indicates the “nA” symbol. From the technical point of view, it is no “slope” but a calibration point. This value shall allow comparing the sensor with the specifications in the datasheet.

Calculation Blocks

Select menu: Parameter setting/System control/Calculation Blocks
Calculation of new variables from measured variables

Calculation Blocks

Two measuring modules with all their measured values serve as input for the calculation block. In addition, the general device status (NAMUR signals) is taken into account. The difference between the existing values is calculated: These output variables are then available in the system and can be assigned to the outputs (current, limit values, display ...)

Functionality of Measuring Module

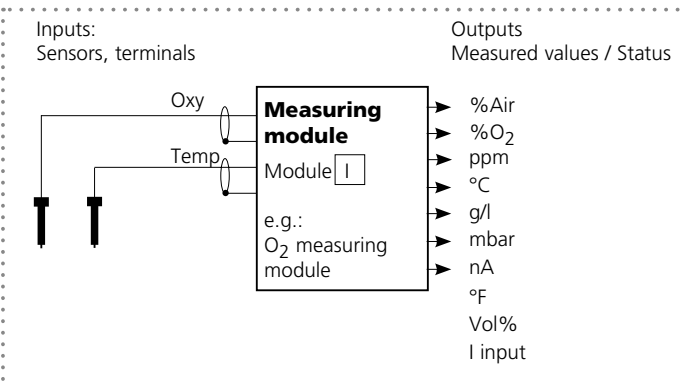

Functionality of Calculation Block

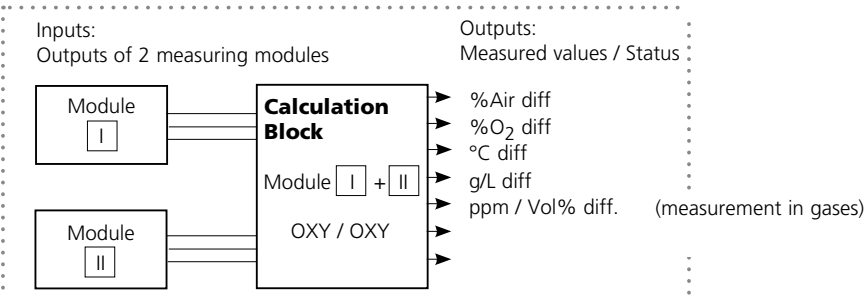

Activating Calculation Blocks

Select menu: Parameter setting/System control/Calculation Blocks
 Combining measuring modules to Calculation Blocks

Combining Measuring Modules

With three measuring modules the following Calculation Block combinations are possible:  +  ,  +  ,  + 

Up to two Calculation Blocks can be activated.

All current outputs can be set to output the new process variables formed by the Calculation Blocks.

All new process variables can be displayed as primary or as secondary value.

Controller functions are not supported.

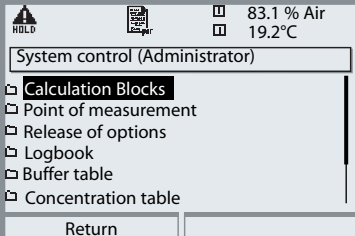
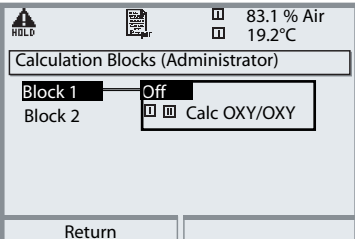
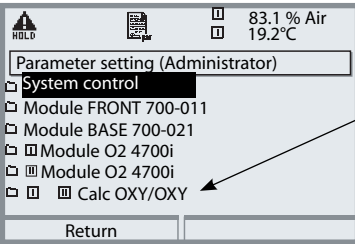
Menu	Display	Activating Calculation Blocks
		<p>Calculation Blocks</p> <ul style="list-style-type: none"> • Call up parameter setting • System control • Select "Calculation Blocks"
		<p>Depending on the modules installed, the possible combinations for Calculation Blocks are offered.</p>
		<p>During parameter setting the Calculation Blocks are displayed like modules.</p>

Logbook, Factory Setting

Parameter setting/System control/Logbook

Note: HOLD mode

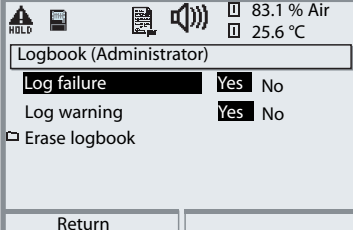
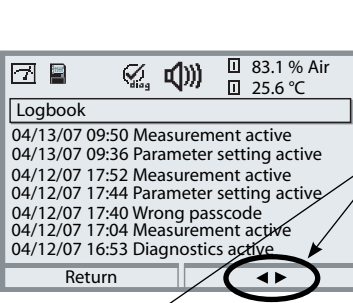
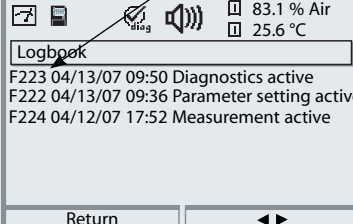
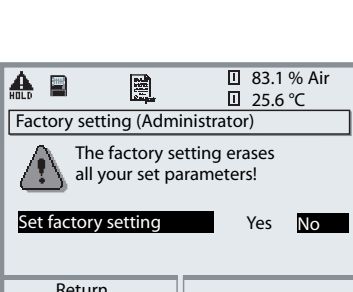
Menu	Display	Logbook, factory setting
		<p>Logbook</p> <p>Select which messages are to be logged in the logbook. The last 50 events are recorded with date and time. This permits quality management documentation to ISO 9000 et seq.</p>
		<p>The logbook can be called up from the diagnostics menu (Fig.). Pressing the right softkey displays the message identifier.</p>
		<p>Additional function SW 700-104: Extended logbook for recording data on SmartMedia card (TAN).</p>
		<p>Factory setting</p> <p>Allows resetting the parameters to their factory setting. When this menu is opened, the analyzer displays a warning (Fig.).</p>

Parameter Setting

Messages: Default settings and selection range

Note: HOLD mode (Setting: BASE module)

Parameter	Default	Selection / Range
Messages Gas <ul style="list-style-type: none"> • Concentration • Partial pressure • Air pressure 	Off Off Off	Off, variable limits* Off, variable limits* Off, device limits max., variable limits*
Messages Liquid <ul style="list-style-type: none"> • Saturation %Air • %O2 saturation • Concentration • Partial pressure • Air pressure 	Off Off Off Off Off	Off, variable limits* Off, variable limits* Off, variable limits* Off, variable limits* Off, device limits max., variable limits*
		* With "Variable limits" selected, the following parameters can be edited: <ul style="list-style-type: none"> • Failure Limit Lo • Warning Limit Lo • Warning Limit Hi • Failure Limit Hi

Device limits

- Device limits max. Maximum measurement range of device
- Variable limits: Range limits specified



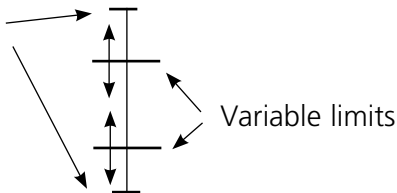

Device limits max.

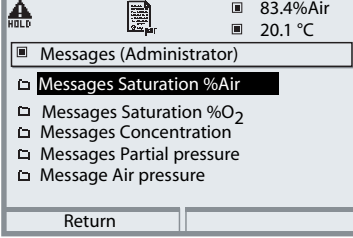
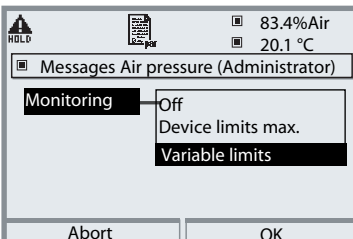
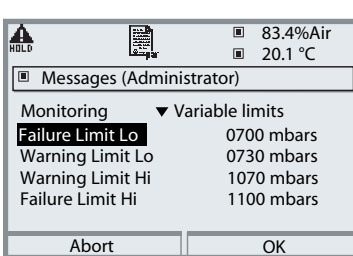

Setting the Message Parameters

Messages

Note: HOLD mode (setting: BASE module)

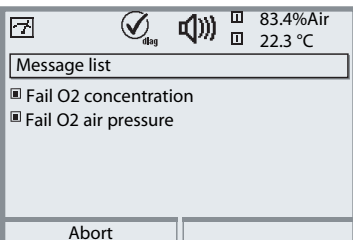
Menu	Display	Messages
	  	<h2>Messages</h2> <p>All parameters determined by the measuring module can generate messages.</p> <ul style="list-style-type: none"> Device limits max: Messages are generated when the process variable (e.g. air pressure) is outside the measurement range. The "Failure" icon is displayed, the NAMUR failure contact is activated (BASE module, factory setting: contact K4, N/C contact). The current outputs can signal a 22 mA message (user defined). Variable limits: For the "failure" and "warning" messages you can define upper and lower limits for message generation. Message icons:  Failure (Failure limit Hi/Hi/Lo/Lo)  Maintenance (Warning limit Hi/Lo)
		<h2>Diagnostics menu</h2> <p>When the "Maintenance" or "Failure" icons are flashing in the display, you should call up the Diagnostics menu. The messages are displayed in the "Message list".</p>

Current Outputs, Contacts, OK Inputs

Select menu: Parameter setting/Module BASE

Note: HOLD mode (Setting: BASE module)

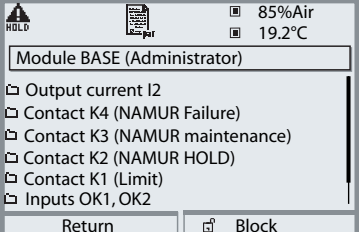
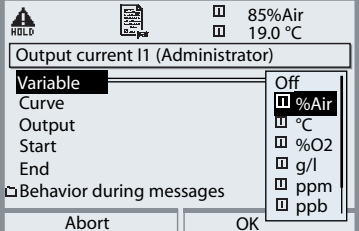
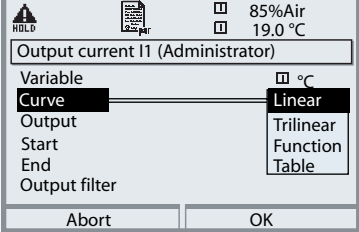
Menu	Display	Parameter setting BASE module
		<p>To configure current output</p> <ul style="list-style-type: none"> • Call up parameter setting • Enter passcode • Select "Module BASE" • Select "Output current ..."
		<ul style="list-style-type: none"> • Select process variable <p>Gas measurement in %/ppm (Liquids: ppm/ppb) Start and end of current output can be set to the other process variable because also the measured value switches automatically. The decimal point can be moved using the arrow keys.</p>
		<ul style="list-style-type: none"> • Select Curve, <p>e.g. "linear": The measured variable is represented by a linear output current curve. The desired range of the measured variable is specified by the values for "Start" and "End".</p>

Assignment of Measured Values: Start (4 mA) and End (20 mA)

Example 1: Range %Air 50 ... 100

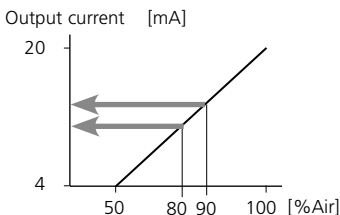

Example 2: Range %Air 80 ... 90

Advantage: Higher resolution in range of interest

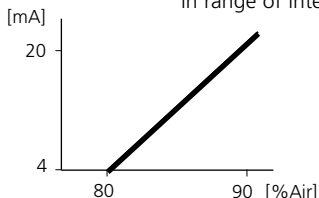

Current Outputs: Characteristics

Select menu: Parameter setting/Module BASE

- **Linear Characteristic**

The measured variable is represented by a linear output current curve.

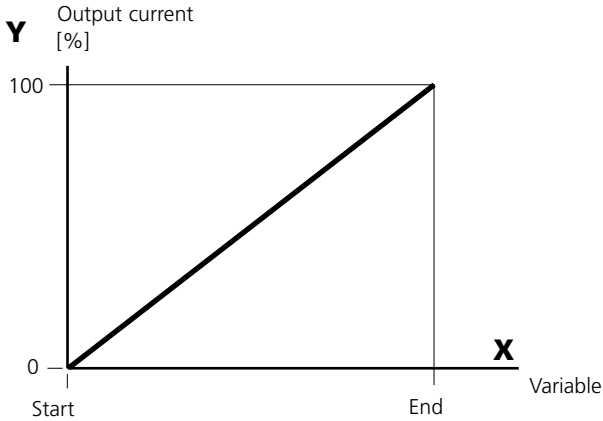

- **Trilinear Characteristic**

Two additional corner points must be entered:

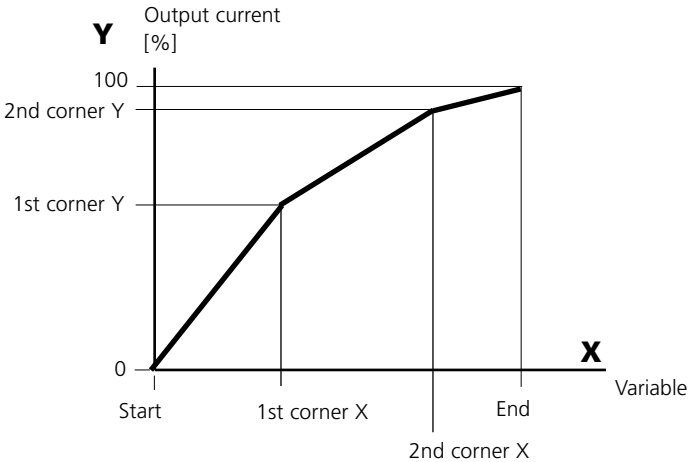

- **Note: Bilinear Characteristic**

For a bilinear characteristic, identical parameters are entered for the two corner points (1st corner, 2nd corner).

• Function Characteristic

Nonlinear output current characteristic: allows measurements over several decades, e.g. measuring very low values with a high resolution and high values with a low resolution.

Required: Entering a value for 50 % output current.

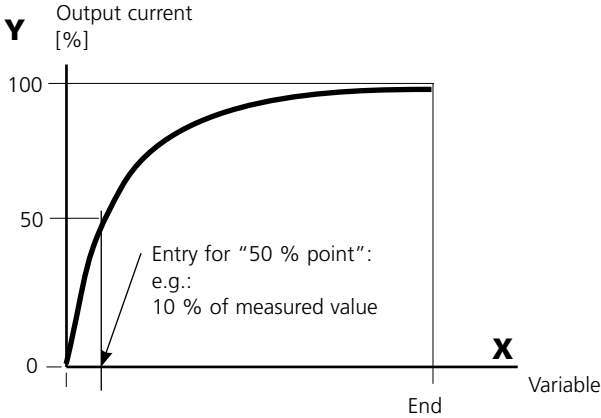

Equation

$$\text{Output current (4 ... 20 mA)} = \frac{(1+K)x}{1+Kx} \cdot 16 \text{ mA} + 4 \text{ mA}$$

$$K = \frac{E + S - 2 \cdot X50\%}{X50\% - S} \qquad x = \frac{M - S}{E - S}$$

- S: Start value at 4 mA
- X50%: 50% value at 12 mA (output current range 4 to 20 mA)
- E: End value at 20 mA
- M: Measured value

Logarithmic Output Curve over one Decade:

- S: 10 % of maximum value
- X50%: 31.6 % of maximum value
- E: Maximum value

Logarithmic Output Curve over two Decades:

- S: 1 % of maximum value
- X50%: 10 % of maximum value
- E: Maximum value

Output Filter

Time Constant

Time Constant of Output Filter

To smoothen the current output, a low-pass filter with adjustable time constant can be switched on. When there is a jump at the input (100 %), the output level is at 63 % after the time constant has been reached. The time constant can be set from 0 to 120 sec. If the time constant is set to 0 sec, the current output follows the input.

Notice

The filter only acts on the current output and the current value of the secondary display, not on the measurement display, the limit values, or the controller!

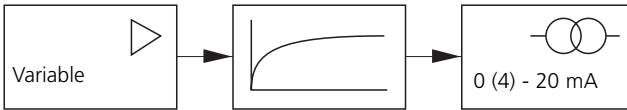

Time constant 0 to 120 s

NAMUR Signals: Current Outputs

Behavior during messages: HOLD, 22 mA signal

Behavior During Messages

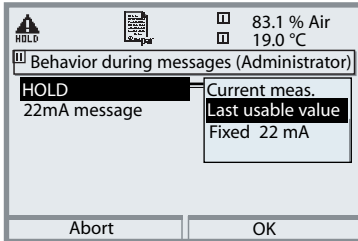

Depending on the parameter setting ("Messages") the current outputs switch to:

- Currently measured value
- Last measured value (HOLD function)
- Fixed value (22 mA)

In the case of a fault a 22 mA signal can be generated for the selected process variable (1st primary value).

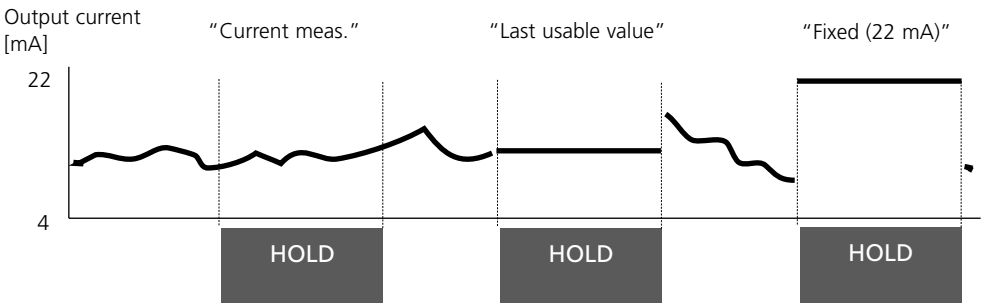

Message when the Current Range is Exceeded

As delivered, the "Maintenance request" (Warn) message is generated when the current range is exceeded ($< 3.8 \text{ mA}$ or $> 20.5 \text{ mA}$).

This setting can be changed in the Parameter setting menu of the respective measuring module at "Messages".

To generate a "Failure" message, the limit value monitoring must be set to "Variable limits":

Parameter setting - <measuring module> - Messages - Variable limits - Failure limit ...

Enter the same values for the failure limits as for the current output:

Parameter setting - Module BASE - Output current - Variable Start / End.

NAMUR Signals: Relay Contacts

Failure, Maintenance Request, HOLD (Function Check)

As delivered, the floating relay outputs of the BASE module are assigned to the NAMUR signals:

Failure	Contact K4, normally closed (signaling current failure)
Maint. request	Contact K3, normally open contact
HOLD	Contact K2, normally open contact

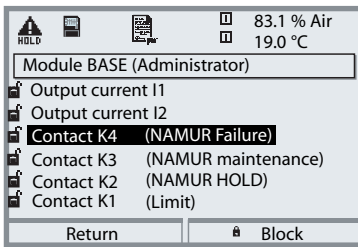

NAMUR signals: Factory setting of contacts

- Select parameter setting:
 - Administrator level
 - Select "Module BASE" (Fig.)
- You can define a delay time for "Maintenance request" and "Failure", resp. If an alarm message is released, the contact will only be activated after expiry of this delay time.

Failure is active

when a value has exceeded (or fallen below, resp.) a preset "Failure Limit Hi" or "Failure Limit Lo", when the measured value is out of range, or in the event of other failure messages. That means that the equipment no longer operates properly or that process parameters have reached a critical value. Failure is disabled during "HOLD" (Function check).

Maintenance request is active

when a value has exceeded (or fallen below, resp.) a preset "Warning Limit Hi" or "Warning Limit Lo", or when other warning messages have been activated. That means that the equipment is still operating properly but should be serviced, (or that process parameters have reached a value requiring intervention).

Failure is disabled during "HOLD" (function check).

HOLD is active:

- during calibration
- during maintenance (current source, meas. point maintenance)
- during parameter setting at the Operator level and the Administrator level
- during an automatic rinsing cycle.

Relay Contacts: Protective Wiring

Protective Wiring of Relay Contacts

Relay contacts are subjected to electrical erosion. Especially with inductive and capacitive loads, the service life of the contacts will be reduced. For suppression of sparks and arcing, components such as RC combinations, nonlinear resistors, series resistors and diodes should be used.

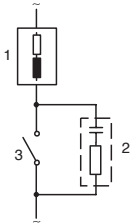
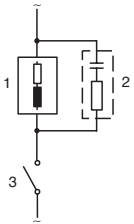

Typical AC applications with inductive load

- 1 Load
- 2 RC combination, e.g. RIFA PMR 209
Typical RC combinations
e.g.
Capacitor 0.1 μ F,
Resistor 100 ohms / 1 W
- 3 Contact

Caution!

Make sure that the maximum ratings of the relay contacts are not exceeded even during switching!

Information Concerning Relay Contacts

As delivered, the relay contacts are suitable for low signal currents (down to approx. 1mA). If currents above approx. 100 mA are switched, the gold plating is destroyed during the switching process. After that, the contacts will not reliably switch low currents.

Relay Contacts

Parameter setting/Module BASE/Relay contacts

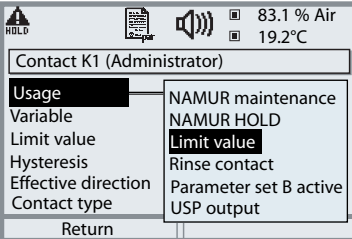
Menu	Display	Setting the relay contacts
		<p>Relay contacts, usage</p> <ul style="list-style-type: none"> • Call up parameter setting • Enter passcode • Select "Module BASE" • Select "Contact ..." • "Usage" (Fig.)

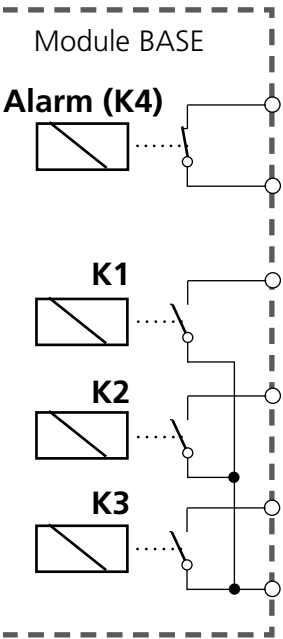

Contact assignment:
See terminal plate of
BASE module

The BASE module provides 4 relay contacts (max. AC/DC rating 30 V / 3 A each). Contact K4 is provided for failure message. The switching behavior (normally open or normally closed), as well as a switch-on or switch-off delay can be defined.

Default settings of the user-definable relay contacts of the BASE module:

- K3: NAMUR maintenance request
- K2: NAMUR HOLD (function check)
- K1: Limit

K1-K3 are user definable ("Usage"):

- NAMUR maintenance
- NAMUR HOLD
- Limit value
- Rinse contact
- Parameter set B active
- USP output (Cond module only)
- K1 rec. active
- Sensoface
- Controller alarm

Rinse Contact

Parameter setting/Module BASE/Relay contacts/Usage/Rinse contact

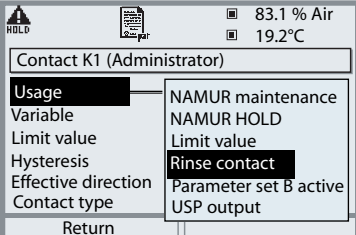
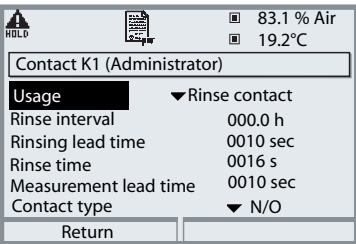
Menu	Display	Configuring the rinse contact
		<h3>Relay contacts, usage</h3> <ul style="list-style-type: none"> • Call up parameter setting • Enter passcode • Select "Module BASE" • Select contact e.g. K1) • "Rinse contact" (Fig.)
		<h3>Configuring the rinse contact</h3> <ul style="list-style-type: none"> • Set rinse interval • Set rinse duration • During the defined "lead time" the "HOLD" mode is active. • Select contact type (e.g. "N/O")

Please note when configuring the "Rinse contact" function

- "HOLD" mode (e.g. during parameter setting) delays the execution of the "Rinse contact" function.
- Up to 3 rinse functions (contacts K1 ... K3) can be configured independently.
- The individual rinse functions are not synchronized with each other.

Time Response

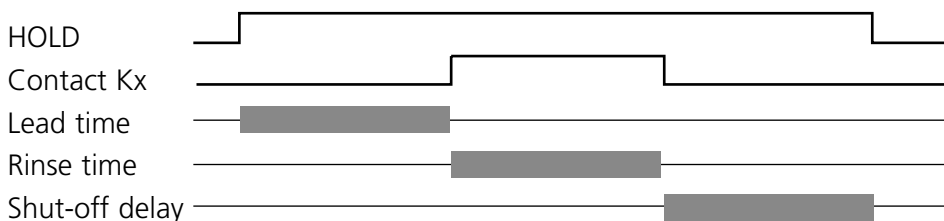

Limit Value, Hysteresis, Contact Type

Parameter setting/Module BASE/Relay contacts/Usage

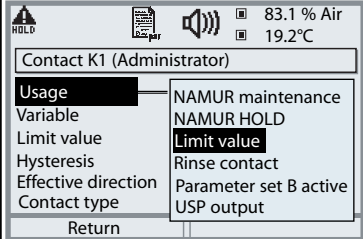
Menu	Display	Usage as limit value
		Relay output: Limit <ul style="list-style-type: none"> • Call up parameter setting • Enter passcode • Select "Module BASE" • Select "Contact ..." • "Usage: Limit" (Fig.)

Limit Value ▾

Effective direction min

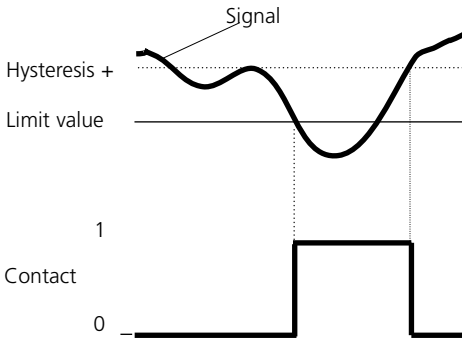

Limit Value ▲

Effective direction max

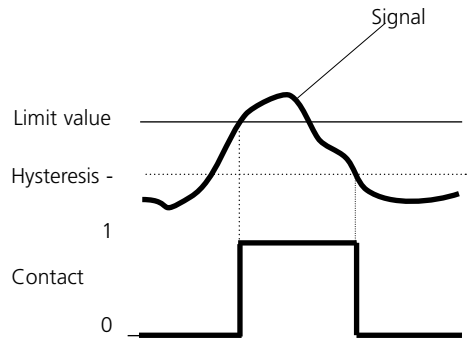

Icons in the measurement display:

Measured value exceeds limit: ▲ Measured value falls below limit: ▾

Hysteresis

Tolerance band around the limit value, within which the contact is not actuated. Serves to obtain appropriate switching behavior at the output and suppress slight fluctuations of the measured variable (Fig.)



Contact Type

Specifies whether the active contact is closed (N/O) or open (N/C).

OK1, OK2 Inputs: Specify Level

Parameter setting/Module BASE/Inputs OK1, OK2

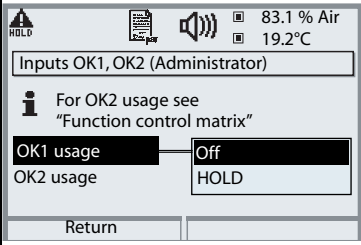
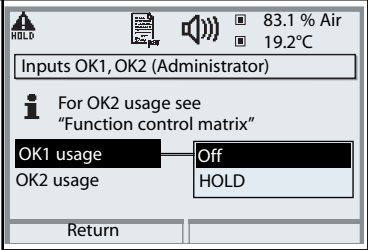
Note: HOLD mode (setting: BASE module)

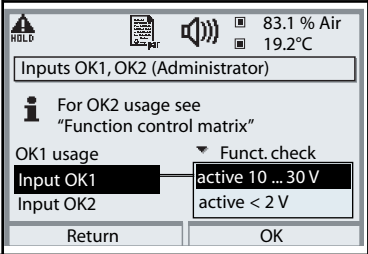
Menu	Display	Setting the OK inputs
		<p>OK1 usage</p> <ul style="list-style-type: none"> • Call up parameter setting • Enter passcode • Select "Module BASE" • Select "Inputs OK1/OK2" • Select "OK1 usage"
		<p>OK1/OK2 switching level</p> <ul style="list-style-type: none"> • Call up parameter setting • Enter passcode • Select "Module BASE" • Select "Inputs OK1/OK2" • Specify active switching level

The BASE module provides 2 digital inputs (OK1, OK2). The following functions (depending on the parameter setting) can be started via a control signal:

- OK1: "Off" or "HOLD" (Function check)
- OK2: Select: System control / Function control matrix ("Off", "Parameter set A/B", "Start KI recorder")

The switching level for the control signal must be specified:
(active 10...30 V or active < 2 V).

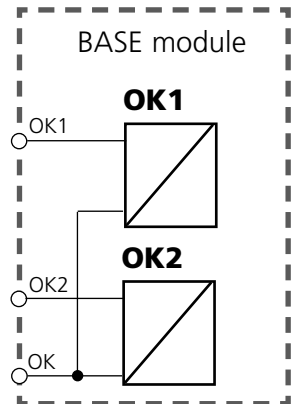

Switching Parameter Sets via OK2

Parameter setting / System control / Function control matrix

Note: HOLD mode (setting: BASE module)

Parameter sets

2 complete parameter sets (A, B) can be stored in the analyzer.

You can switch between the parameter sets using the OK2 input.

The currently activated set can be signaled by a relay contact.

An icon in the measurement display shows which parameter set is active:

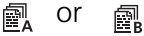

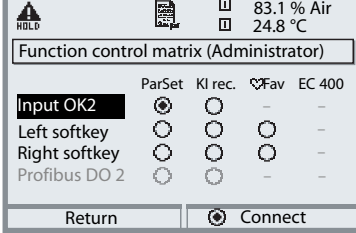
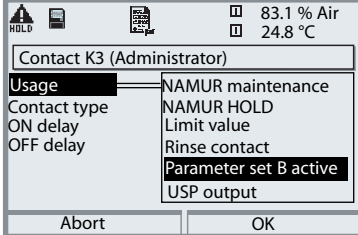
Menu	Display	Parameter sets
		<p>Selecting parameter set (A, B) via OK2 input</p> <ul style="list-style-type: none"> • Call up parameter setting • System control • Function control matrix • Select “OK2” • Connect “Parameter set A/B”
		<p>Signaling active parameter set via relay contact</p> <ul style="list-style-type: none"> • Call up parameter setting • BASE module • Select contact • Usage: “Parameter set ...”.













Notice

The selection has no effect when working on SmartMedia card with SW 700-102.

Maintenance



Sensor monitor / Temp probe adjustment

Note: HOLD mode (setting: BASE module)

Menu	Display	Maintenance
	<div data-bbox="180 363 532 608">  80.7%Air 25.6°C <p>Menu selection</p> <div data-bbox="188 459 524 528">     </div> <p>Select: ◀ ▶ [enter]</p> <p>Return to meas  Lingua</p> </div> <div data-bbox="180 699 532 938">   80.7%Air 25.6°C <p>Sensor monitor</p> <p>Sensor current -60.2 nA Sensor current (25°C) -58.5 nA Air pressure 1014 mbars Ext. pressure transmitter 0 mbars RTD 22.0 kΩ Temperature 25.1 °C</p> <p>Return</p> </div> <div data-bbox="180 949 532 1189">   16.4%Air 25.6°C <p>Adjust temp probe</p> <p> Probe tolerance and lead adjustment Enter measured process temp</p> <p>Installation adjustment On Off Process temperature +025.0°C</p> <p>Abort OK</p> </div>	

Diagnostics Functions

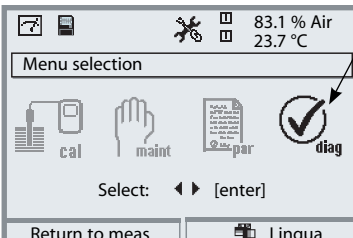

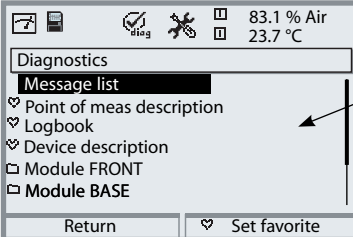
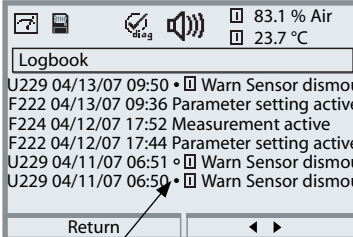
General status information of the measuring system
 Select menu: Diagnostics

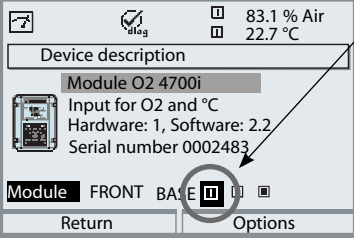
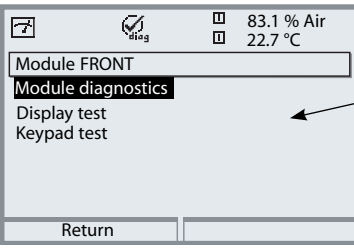
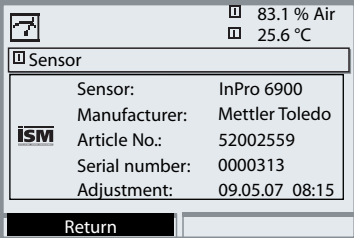
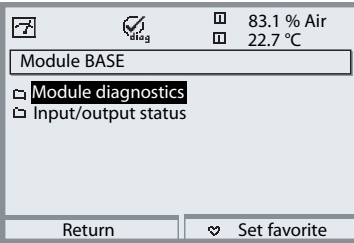
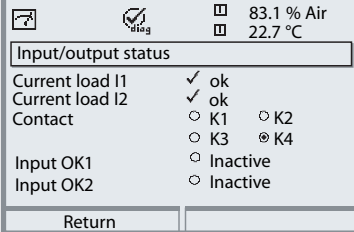
Menu	Display	Diagnostics functions
		<p>Call up diagnostics From the measuring mode: Press menu key to select menu. Select diagnostics using arrow keys, confirm with enter.</p>
		<p>The "Diagnostics" menu gives an overview of all functions available. Functions which have been set as "Favorite" can be directly accessed from the measuring mode.</p> <p>Point of meas description Allows entering a tag number and a note. Select position: left/right arrow key, select character: up/down arrow key. Confirm the entry with enter.</p>
	 <p>◻ Releasing module: • Message activated ◦ Message deactivated</p>	<p>Logbook Shows the last 50 events with message identifier, date, time, module concerned, and plaintext of the message. This permits quality management documentation to ISO 9000 et seq. Extended logbook: SmartMedia card (SW 700-104)</p>

Menu	Display	Diagnostics functions
 diag		<p>Device description</p> <p>Select module using arrow keys: Provides information about all modules installed: Function, serial number, hardware and software version, and device options.</p>
		<p>FRONT module</p> <p>The module contains the display and keypad control. Test possibilities:</p> <ul style="list-style-type: none"> • Module diagnostics • Display test • Keypad test
		<p>ISM sensor description*</p> <p>Information on sensor type, manufacturer, article no., serial number, date of last adjustment</p> <p>* Menu is only displayed for ISM modules when a valid ISM sensor is connected.</p>
		<p>BASE module</p> <p>The module generates the standard output signals. Test possibilities:</p> <ul style="list-style-type: none"> • Module diagnostics • Input/output status
		<p>Example: Module BASE, input/output status.</p>

Module Diagnostics

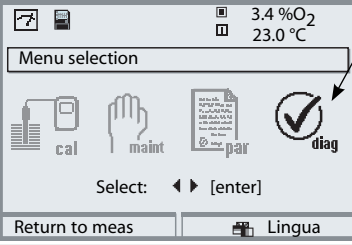
Module diagnostics/Sensor monitor/Cal record/Sensor network diagram/Statistics

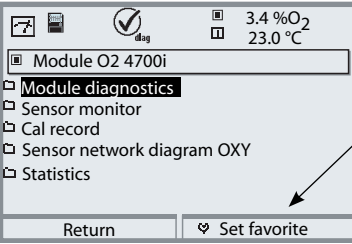
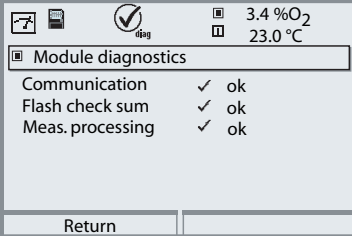
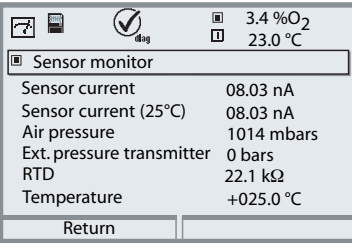
Menu	Display	Module diagnostics / Sensor monitor
		<p>Call up diagnostics</p> <p>From the measuring mode: Press menu key to select menu. Select diagnostics using arrow keys, confirm with enter. Then select "Module O₂".</p>
		<p>The Diagnostics menu gives an overview of all diagnostics functions available. Messages set as "Favorite" can be called up directly from the measuring mode using a softkey. Select: Parameter setting / System control / Function control matrix.</p>
		<p>Module diagnostics</p> <p>Function test of internal components:</p> <ul style="list-style-type: none"> - Internal device communication - Check of firmware (module) - Factory settings, measured value processing
		<p>Sensor monitor</p> <p>Shows the current directly measured by the sensor, the barometric pressure, and temperature. Important function for diagnostics and validation!</p>

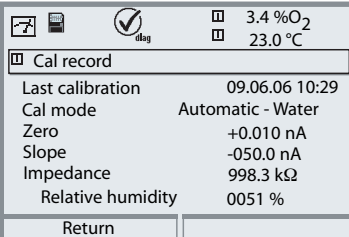
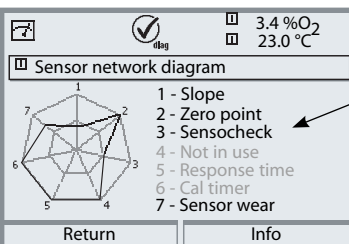
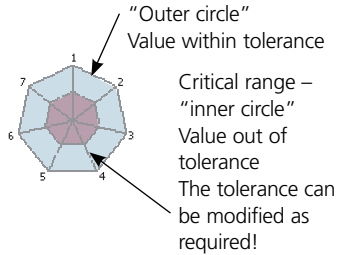
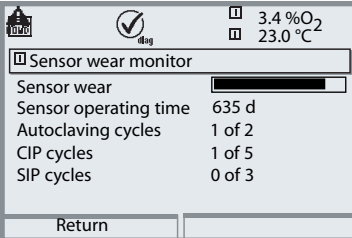
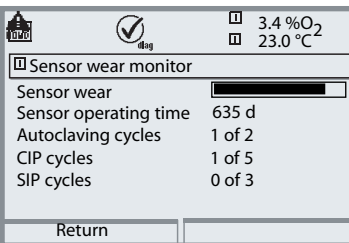
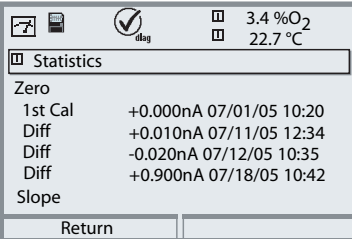
Menu	Display	Cal record / Sensor network diagram / Statistics
	 <p>Cal record</p> <p>Last calibration 09.06.06 10:29 Cal mode Automatic - Water Zero +0.010 nA Slope -050.0 nA Impedance 998.3 kΩ Relative humidity 0051 %</p> <p>Return</p>	<p>Cal record</p> <p>Data of last calibration, suitable for documentation to ISO 9000 and GLP (Date, time, calibration method, sensor zero and slope, rel. humidity for calibration in air)</p>
	 <p>Sensor network diagram</p> <p>1 - Slope 2 - Zero point 3 - Sensocheck 4 - Not in use 5 - Response time 6 - Cal timer 7 - Sensor wear</p> <p>Return Info</p>  <p>“Outer circle” Value within tolerance</p> <p>Critical range – “inner circle” Value out of tolerance</p> <p>The tolerance can be modified as required!</p>  <p>Sensor wear monitor</p> <p>Sensor wear </p> <p>Sensor operating time 635 d Autoclaving cycles 1 of 2 CIP cycles 1 of 5 SIP cycles 0 of 3</p> <p>Return</p>	<p>Sensor network diagram</p> <p>The measured values are continuously monitored during the measurement process. The sensor network diagram provides at-a-glance information about critical parameters. If a tolerance limit has been exceeded, the respective parameter is flashing. Values in gray: Monitoring switched off.</p> <p>Sensor wear monitor (ISM)</p> <p>In addition to the current sensor wear, the sensor operating time as well as the number of executed autoclaving, CIP, or SIP cycles can be seen at a glance.</p> <p>* Menu is only displayed for ISM modules when a valid ISM sensor is connected.</p>
	 <p>Statistics</p> <p>Zero</p> <p>1st Cal +0.000nA 07/01/05 10:20 Diff +0.010nA 07/11/05 12:34 Diff -0.020nA 07/12/05 10:35 Diff +0.900nA 07/18/05 10:42 Slope</p> <p>Return</p>	<p>Statistics</p> <p>Indication of sensor data for the First Calibration and the last 3 calibrations. (Date and time of First Calibration, sensor zero and slope, temperature, pressure, response time)</p>

Setting Diagnostics Messages as Favorite

Select menu: Parameter setting/System control/Function control matrix

Secondary Displays (1)

Here, additional values are displayed in the measuring mode according to the factory setting. When the respective softkey (2) is pressed, the process variables measured by the modules plus date or time are displayed. In addition, you can use the **softkeys (2)** to control functions.

To assign a function to a softkey, select

Parameter setting/System control/ Function control matrix

Function which can be controlled by softkeys:

- Parameter set selection
- KI recorder Start/Stop
- Favorites
- EC 400 (fully automated probe controller)

Favorites

Selected Diagnostics functions can be called up directly from the measuring mode using a softkey.

The table on the next page explains how to select favorites.

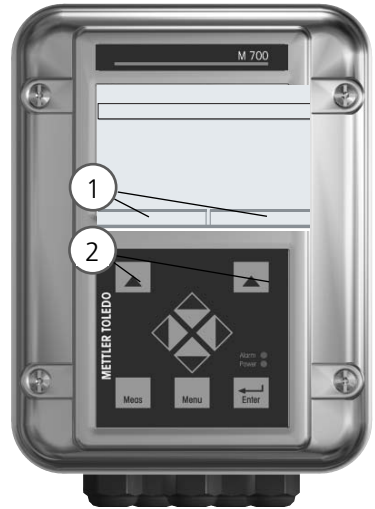

	ParSet	KI rec.	♥Fav	EC 400
Input OK2	<input type="radio"/>	<input type="radio"/>	<input type="radio"/>	-
Left softkey	<input type="radio"/>	<input type="radio"/>	<input type="radio"/>	-
Right softkey	<input type="radio"/>	<input type="radio"/>	<input checked="" type="radio"/>	-
Profibus DO 2	<input type="radio"/>	<input type="radio"/>	<input type="radio"/>	-

Return Connect

Example:



"Favorites" to be selected with "Right softkey"

To select a softkey function:

Select desired function using arrow keys, press "Connect" softkey and confirm with **enter**.

To deselect a function:

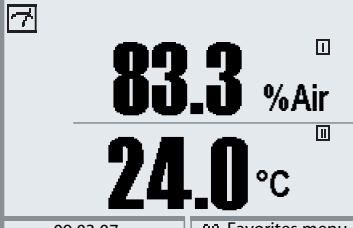
Press "Disconnect" softkey, confirm with **enter**.

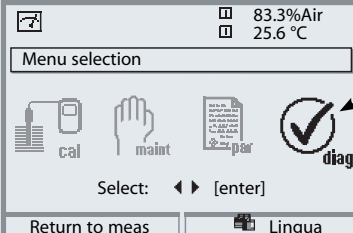
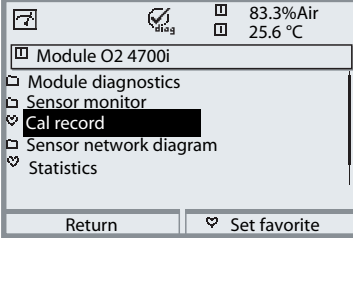
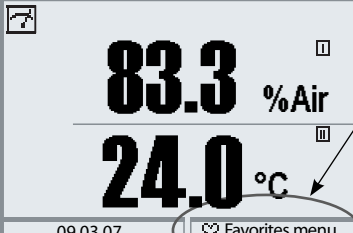

Menu	Display	Select favorites
		<p>Favorites menu</p> <p>Diagnostics functions can be called up directly from the measuring mode using a softkey. The "Favorites" are selected in the Diagnostics menu.</p>
		<p>Select favorites</p> <p>Press menu key to Menu selection. Select diagnostics using arrow keys, confirm with enter. Then select module and confirm with enter.</p>
		<p>Set/delete favorite:</p> <p>"Set favorite" allows activation of the selected diagnostic function directly from the measuring mode via softkey. The menu line is marked with a heart icon.</p>
		<p>Pressing the meas key returns to measurement. When the softkey has been assigned to "Favorites", "Favorites menu" is read in the secondary display (see "Function control matrix").</p>

Notice:

When one of the softkeys has been assigned to the "Favorites menu" function, diagnostic functions which have been set as "Favorite" can be directly called up from the measuring mode.

Diagnostics Functions

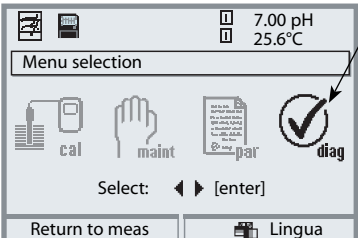
General status information of the measuring system
 Select menu: Diagnostics - Message list

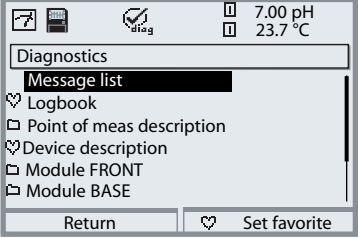
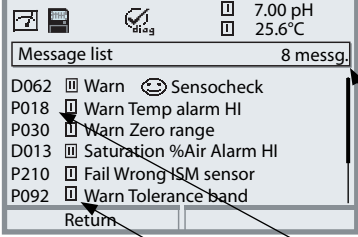
Menu	Display	Diagnostics functions
		<p>Call up diagnostics From the measuring mode: Press menu key to select menu. Select diagnostics using arrow keys, confirm with enter.</p>
		<p>The “Diagnostics” menu gives an overview of all functions available. Functions which have been set as “Favorite” can be directly accessed from the measuring mode.</p>
		<p>Message list Shows the currently activated warning or failure messages in plain text.</p> <p>Number of messages When there are more than 7 messages, a vertical scrollbar appears. Scroll with the up/down arrow keys.</p> <p>Message identifier See message list for description.</p> <p>Module identifier Specifies the module that has generated the message.</p>

Messages

O₂ 4700i(X) Module

No.	%O ₂ Messages	Message type
D008	Meas. processing (factory settings)	FAIL
D009	Module failure (Firmware Flash check sum)	FAIL
D010	Saturation %Air Range	FAIL
D011	Saturation %Air Alarm LO_LO	FAIL
D012	Saturation %Air Alarm LO	WARN
D013	Saturation %Air Alarm HI	WARN
D014	Saturation %Air Alarm HI_HI	FAIL
D015	Temperature range	FAIL
D016	Temperature Alarm LO_LO	FAIL
D017	Temperature Alarm LO	WARN
D018	Temperature Alarm HI	WARN
D019	Temperature Alarm HI_HI	FAIL
D020	Concentration range	FAIL
D021	Concentration Alarm LO_LO	FAIL
D022	Concentration Alarm LO	WARN
D023	Concentration Alarm HI	WARN
D024	Concentration Alarm HI_HI	FAIL
D025	Part. press. range	FAIL
D026	Part. press. Alarm LO_LO	FAIL
D027	Part. press. Alarm LO	WARN
D028	Part. press. Alarm HI	WARN
D029	Part. press. Alarm HI_HI	FAIL
D030	Zero range	WARN
D035	Slope range	WARN
D040	Air pressure range	WARN

Messages

No.	%O₂ Messages	Message type
D041	Air pressure Alarm LO_LO	FAIL
D042	Air pressure Alarm LO	WARN
D043	Air pressure Alarm HI	WARN
D044	Air pressure Alarm HI_HI	FAIL
D045	Saturation %O ₂ Range	FAIL
D046	Saturation %O ₂ Alarm LO_LO	FAIL
D047	Saturation %O ₂ Alarm LO	WARN
D048	Saturation %O ₂ Alarm HI	WARN
D049	Saturation %O ₂ Alarm HI_HI	FAIL
D050	Air pressure Manual range	WARN
D060	⚡ Slope	WARN
D061	⚡ Zero	WARN
D062	⚡ Sensocheck	User-defined
D063	⚡ Response time	WARN
D064	Calibration timer	WARN
D070	⚡ Sensor wear	User-defined
D080	Range (sensor current)	WARN
D090	Vol% range (measurement in gases)	WARN
D091	Vol% Alarm LO_LO (measurement in gases)	FAIL
D092	Vol% Alarm LO (measurement in gases)	WARN
D093	Vol% Alarm HI (measurement in gases)	WARN
D094	Vol% Alarm HI_HI (measurement in gases)	FAIL
D095	ppm range (measurement in gases)	FAIL
D096	ppm Alarm LO_LO (measurement in gases)	FAIL
D097	ppm Alarm LO (measurement in gases)	WARN
D098	ppm Alarm HI (measurement in gases)	WARN
D099	ppm Alarm HI_HI (measurement in gases)	FAIL
D110	CIP counter	User-defined
D111	SIP counter	User-defined
D112	Autoclaving counter	User-defined

Messages

No.	%O ₂ Messages	Message type
D113	Sensor operating time (duration of use)	User-defined
D114	Membrane body changes	User-defined
D115	Inner body changes	User-defined
D120	Wrong ISM sensor	FAIL
D121	ISM sensor (error in factory settings/characteristics)	FAIL
D122	ISM sensor memory (error in cal data records)	WARN
D123	New sensor, adjustment required	WARN
D130	SIP cycle counted	Text
D131	CIP cycle counted	Text
D200	Temp O ₂ conc/SAT	WARN
D201	Cal temp	Text
D203	Cal: Identical media	Text
D204	Cal: Media interchanged	Text
D205	Cal: Sensor unstable	Text
D254	Module reset	Text

No.	Messages Calculation Blocks O ₂ / O ₂	Message type
H010	%AIR-Diff Range	FAIL
H011	%AIR-Diff Alarm LO_LO	FAIL
H012	%AIR-Diff Alarm LO	WARN
H013	%AIR-Diff Alarm HI	WARN
H014	%AIR-Diff Alarm HI_HI	FAIL
H015	Temperature-Diff Range	FAIL
H016	Temperature-Diff Alarm LO_LO	FAIL
H017	Temperature-Diff Alarm LO	WARN
H018	Temperature-Diff Alarm HI	WARN
H019	Temperature-Diff Alarm HI_HI	FAIL
H020	Concentration-Diff Range	FAIL
H021	Concentration-Diff Alarm LO_LO	FAIL

Messages

No.	Messages Calculation Blocks O ₂ / O ₂	Message type
H022	Concentration-Diff Alarm LO	WARN
H023	Concentration-Diff Alarm HI	WARN
H024	Concentration-Diff Alarm HI_HI	FAIL
H045	%O ₂ Diff Range	FAIL
H046	%O ₂ Diff Alarm LO_LO	FAIL
H047	%O ₂ Diff Alarm LO	WARN
H048	%O ₂ Diff Alarm HI	WARN
H049	%O ₂ Diff Alarm HI_HI	FAIL
H090	Vol%-Diff range (measurement in gases)	WARN
H091	Vol%-Diff Alarm LO_LO (measurement in gases)	FAIL
H092	Vol%-Diff Alarm LO (measurement in gases)	WARN
H093	Vol%-Diff Alarm HI (measurement in gases)	WARN
H094	Vol%-Diff Alarm HI_HI (measurement in gases)	FAIL
H095	ppm-Diff range (measurement in gases)	FAIL
H096	ppm-Diff Alarm LO_LO (measurement in gases)	FAIL
H097	ppm-Diff Alarm LO (measurement in gases)	WARN
H098	ppm-Diff Alarm HI (measurement in gases)	WARN
H099	ppm-Diff Alarm HI_HI (measurement in gases)	FAIL

Specifications

Specifications O₂ 4700i(X)

Oxy input (EEx ia IIC)	Standard applications with the Mettler-Toledo InPro 6800 Series sensors Control and evaluation of ISM sensors
Measuring current	0 ... 1800 nA, resolution 30 pA
Saturation (-10 ... 80 °C)	0.0 ... 199.9 / 200 ... 600 % Air 0.0 ... 29.9 / 30 ... 120 % O ₂
Measurement error**	< 0.5 % meas.val. + 0.1 nA + 0.005 nA/K
Concentration (-10 ... 80 °C)	0000 ... 9999 µg/l (overrange during calibration up to 19.99 mg/l) 0000 ... 9999 ppb (overrange during calibration up to 19.99 ppm) 0.00 ... 200.00 mg/l 0.00 ... 200.00 ppm
Measurement error**	< 0.5 % meas.val. +0.05 mg/l or 0.05 ppm
Polarization voltage	0 ... -1000 mV, default -675 mV (resolution 5 mV)
Partial pressure	0 ... 5000 mbars
Air pressure	700 ... 1100 mbars
Manual	0 ... 9999 mbars
External	0 ... 9999 mbars (through current input 0(4) ... 20 mA input)
Salinity correction	0.0 ... 45.0 g/kg
Adm. guard current	≤ 20 µA
Ref voltage	± 500 mV (voltage across ref connection and anode)
Measurement in gases	0 ... 2000 mbars 0 ... 9999 ppm 0.00 ... 29.9 / 30.0 120.0 %vol (display only) 0.00 ... 120.0 %vol (current, limit values) (1 %vol = 10,000 ppm)
Current start / end	As desired within range

Specifications

Calibration methods

Automatic - Air
- with the following default settings:
rH = 50 %, p 0 measured barometric pressure,
calibration medium air (dry air = 20.95 %vol)
Product calibration
(select ppm or Vol%)
Data entry
Zero correction

ISM

Intelligent Sensor Management
Display of sensor data: Manufacturer, serial number,
calibration record, load matrix, a.o.

Sensor monitoring *

Sensocheck
Monitoring of membrane and electrolyte

Sensoface

Sensor network diagram

provides information on the sensor condition
Zero, slope, response time, calibration interval,
Sensocheck, wear (ISM)

Sensor monitor

Direct display of measured values from sensor for validation
of sensor current / barometric pressure / temperature / I input

Wear monitor

Display of wear parameters
Sensor wear / sensor operating time / autoclaving cycles /
CIP cycles

Sensor standardization *

Operating modes
- Automatic calibration in air-saturated water
- Automatic calibration in air
- Product calibration: Saturation
- Product calibration: Concentration
- Data entry zero/slope
- Zero correction

Specifications

Calibration record/statistics

Recording of:
Zero, slope, response time, calibration method,
with date and time of the last three calibrations
and the First Calibration

Temperature input

(Ex ia IIC)

Temperature probe *

NTC 22 k Ω / NTC 30 k Ω , 2-wire connection, adjustable

Measurement range (MR)

-20 ... +150 °C (-4 ... 302 °F)

Resolution

0,1 °C

Measurement error **

0.2 % meas.val. + 0.5 K

Input

Pressure range

0(4) ... 20 mA for absolute or differential pressure transmitter

0 ... 9999 mbars

Current range

0(4) ... 20 mA / 50 ohms

Start / end user-defined within pressure range

Resolution

< 1%

* User-defined

** To IEC 746 Part 1, at nominal operating conditions, ± 1 count, plus sensor error

Specifications

General Data

Explosion protection

(IS module only)

ATEX: See rating plate: KEMA 03 ATEX 2056
II 2 (1) GD EEx ib [ia] IIC T4 T 70 °C

FM: NI, Class I, Div 2, GP A, B, C, D T4
with IS circuits extending into Division 1
Class I, Zone 2, AEx nA, Group IIC, T4
Class I, Zone 1, AEx me ib [ia] IIC, T4

CSA: NI, Class I, Div 2, Group A, B, C, D
with IS circuits extending into Division 1
AIS, Class I, Zone 1, Ex ib [ia] IIC, T4
NI, Class I, Zone 2, Ex nA [ia] IIC

EMC

Emitted interference
Immunity to interference

NAMUR NE 21 and
EN 61326 VDE 0843 Part 20 /01.98
EN 61326/A1 VDE 0843 Part 20/A1 /05.99
Class B
Industry

Lightning protection

EN 61000-4-5, Installation Class 2

Nominal operating conditions

Ambient temperature:
-20 ... +55 °C (Ex: max. +50 °C)
Rel. humidity: 10 ... 95 % not condensing

Transport/Storage temperature

-20 ... +70 °C

Screw clamp connector

Single wires and flexible leads up to 2.5 mm²

Appendix:

Minimum Spans for Current Outputs

The O₂ 4700i(X) module is a measuring module. It does not provide current outputs. Current outputs are provided by the BASE module (basic device) or by communication modules (e.g. Out, PID). The corresponding parameters must be set there.

The minimum current span shall prevent that the resolution limit of the measurement technology (± 1 count) is seen in the current.

O₂ 4700i(X) Module

%Air	10.0
%O ₂	2.0
°C	10.0
mbar	20.0 (barometric pressure)
nA	10 % min. 1.00 nA
mg/l	10 % min. 20.0 µg/l
ppm	10 % min. 20.0 ppb
mbar	20.0 (partial pressure)
Vol%	2.0
ppm	1000
°F	10.0

Calculation Block OXY/OXY

Diff %Air	10.0
Diff-%O ₂	2.0
Diff mg/l	10 % min. 2.0 µg/l
Diff ppm	10 % min. 2.0 ppb
Diff °C	10.0
Diff Vol%	2.0
Diff ppm	1000

Dissolved Oxygen Measurement in Carbonated Beverages (SW 700-011)

Application-specific additional function for breweries

Recommended only for InPro 6900 series sensors!

This additional function simplifies parameter setting since all steps not required for dissolved oxygen measurement in carbonated beverages are omitted. It simultaneously acts on all installed O₂ modules (module software version 2.2 and higher).

Function principle:

The following processes are automated by the additional function, i.e. all parameters required for the respective program step are set automatically.

During the filling process, for example, it must be ensured that as little oxygen as possible is dissolved in the beer to extent its shelf life.

During oxygen trace measurement the sensor is operated with a very low polarization voltage (-500 mV). This results in low cross-sensitivity to CO₂.

For a calibration in air, this polarization voltage is too low.

It must be set to -675 mV and afterwards be reduced again to -500 mV for measuring in the trace range.

Be sure to wait long enough for the sensor to stabilize.

Opening and closing of valves causes pressure variations in the beer pipes which momentarily falsify the O₂ signal. Therefore the input signal must be attenuated correspondingly to suppress transient interferences.

Overview of Parameter Setting

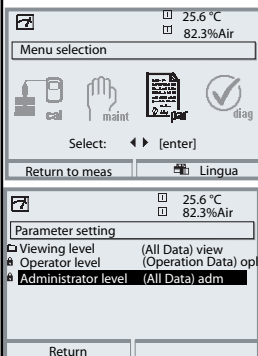

Parameter setting

Activated from measuring mode: Press **menu** key to select menu.

Select parameter setting using arrow keys, confirm with **enter**.

Administrator level

Access to all functions, also passcode setting.

Releasing or blocking a function for access from the Operator level.

Operator level

Access to all functions which have been released at the Administrator level. Blocked functions are displayed in gray and cannot be edited.

Viewing level

Only display, no editing possible!

System Control

Memory card (Option)

- Record logbook
- Register recorder
- Decimal separator
- Card full
- Format

Menu only appears with SmartMedia Card inserted.

Make sure that it is a memory card, not an update card.

Commercially available SmartMedia cards must be formatted before they can be used as memory card.

Copy configuration

The complete configuration of an analyzer can be written on a SmartMedia card. This allows transferring all device settings to other devices with identical equipment (exception: options and passcodes).

Parameter sets

- Load
- Save

2 parameter sets (A,B) are available in the analyzer.

The currently active parameter set is read on the display.

Parameter sets contain all settings except:

Sensor type, Options, System control settings

Up to 5 parameter sets (1, 2, 3, 4, 5) are available when a SmartMedia card (Option) is used.

Function control matrix

- Input OK2
- Left softkey
- Right softkey

Selecting the control element for the following functions:

- Parameter set selection
- KI recorder (Start/Stop)
- Favorites menu (selected diagnostics functions)
- EC 400 (fully automated probe controller)

Time/date

Selecting the display format, entry

Point of meas description

Can be called up in the diagnostics menu.

Release of options

A TAN is required to release an Option.

Software update

Software update from SmartMedia card (update card)

Logbook

Selecting events to be recorded

Buffer table

Entering own buffer set for automatic calibration

Factory setting

Resetting all parameters to factory setting

Passcode entry

Editing the passcodes

Parameter Setting Menu



Display Settings: FRONT Module

Languages

Measurement display <ul style="list-style-type: none"> • Main display • Display format • Viewing angle 	Representation of measured values on the display: <ul style="list-style-type: none"> - Selecting the number of primary values displayed (one or two) - Decimal places
Measurement recorder <ul style="list-style-type: none"> • Time base • Zoom function • Min/Max display 	Option: 2-channel, selection of process variable, start and end
KI recorder	Option: See more detailed "Options" manual

Signal Outputs and Inputs, Contacts: BASE Module

Output current I1, I2 <ul style="list-style-type: none"> • Variable • Curve • Output (0/4 - 20 mA) • Output filter • Behavior during messages <ul style="list-style-type: none"> - HOLD --- Current meas. --- Last meas. value --- Fixed 22 mA - 22 mA message 	2 current outputs, separately adjustable Behavior during messages Output current [mA]
Contact K4 <ul style="list-style-type: none"> • Contact type • ON delay • OFF delay 	NAMUR Failure
Contacts K3, K2, K1 <ul style="list-style-type: none"> • Usage <ul style="list-style-type: none"> - Maintenance request - HOLD (function check) - Limit value (adjustable) - Rinse contact (adjustable) - Parameter set B active - USP output - KI recorder active - Sensoface • Conoller alarm (alarm output EC 400) • Contact type / ON/OFF delay 	Factory setting: K3: Maintenance request, K2: HOLD, K1: Limit <ul style="list-style-type: none"> - Variable, limit value, hysteresis, effective direction, ... - Rinsing interval, lead times, rinse duration, logbook entry, ...
Inputs OK1, OK2 <ul style="list-style-type: none"> • OK1 usage <ul style="list-style-type: none"> - Signal level 	Optocoupler - signal inputs Off, HOLD (function check) active level switchable from 10 to 30 V or < 2 V, resp. For OK2 see System control/Function control matrix

Parameter Setting Menu



O₂ 4700i(X) Module

Input filter

Sensor data

- Sensor type - Representation of measured values on the display:
 - Select
 - Selection for Measurement / Calibration
- Temperature probe
- Sensor polarization
- Polarization voltage
- Sensoface
- Details - Slope, zero, temperature, Sensocheck, response time sensor wear, CIP counter, SIP counter, autoclaving counter, sensor operating time, membrane body changes, inner body changes

Cal preset values

- Cal saturation
- Cal concentration - mg/l, µg/l, ppm, ppb
- Calibration timer

Pressure correction

- Ext. pressure transmitter
- Pressure during meas
- Pressure during cal

Salinity correction

- Entry
- Salinity - Salinity, chlorinity, conductivity

Messages

- Saturation %Air
- Saturation %O₂
- Concentration
- Partial pressure
- Temperature
- Air pressure

Calibration Menu



O₂ 4700i(X) Module

- Automatic - Water
- Automatic - Air
- Product calibration Sat
- Product calibration Conc
- Data entry
- Zero correction

Maintenance Menu



BASE Module

Current source Output current definable 0 ... 22 mA

O₂ 4700i(X) Module

Sensor monitor	Sensor current, air pressure, ext. pressure transmitter, RTD, temperature, impedance, current input
Temp probe adjustment	Compensating for lead length
Autoclaving counter	Shows the number of executed autoclaving cycles as well as the maximally permitted number of cycles
Membrane body changes	Shows the number of executed membrane body changes as well as the maximally permitted number of changes
Inner body changes	Shows the number of executed inner body changes as well as the maximally permitted number of changes

Diagnostics Menu



Message list	List of all warning and failure messages
Point of meas description	
Logbook	
Device description	Hardware version, Serial no., (Module) Firmware, Options

FRONT Module

Module diagnostics
Display test
Keypad test

BASE Module

Module diagnostics
Input/output status

O₂ 4700i(X) Module

Module diagnostics	Internal function test
Sensor monitor	Shows the values currently measured by the sensor
Cal record	Data of last adjustment / calibration
Sensor network diagram Oxy	Graphical representation of the sensor parameters
Sensor wear monitor	Shows the sensor wear
Load diagram	3D representation of sensor wear (sensor current/temperature)
Statistics	Displays first calibration and deviations of last 3 calibrations

Index

A

- Adjustment 32
- Administrator level 46
- Application in hazardous locations 9
- Attaching the terminal plates 23
- Audit Trail Log 8
- Autoclaving counter (ISM only) 20
- Automatic calibration in air 38
- Automatic calibration in water 36

B

- BASE module 15
- Behavior during messages 64

C

- Cable glands 12
- Calculation Block 55
- Calculation Blocks 55
- Calibration 31
- Calibration method 34
- Calibration with sampling 40, 42
- Call up parameter setting 48
- Cal record 76
- Change passcode 28
- CIP (Cleaning in Place) 22
- Configure measurement display 29
- Configuring the module 51
- Contacts 60
- Contact type 69
- Current output curves 61
- Current outputs 60, 64
- Current outputs, minimum spans 88

D

- Data entry of premeasured sensors 44

Index

Device limits max. 59
Diagnostics 73
Diagnostics functions 73
Diagnostics messages as favorite 77
Disposal 2
Dissolved oxygen measurement in carbonated beverages (SW 700-011) 89
Documenting the settings 49

E

Electronic Signature 8
EMC 87

F

Factory setting 57
Failure 65
Favorites 77
FDA 21 CFR Part 11 8
FRONT module 14
Function check 65

G

Graphic display 12

H

Hardware and software version 10
HOLD 65
Hysteresis 69

I

Inner body changes (ISM only) 20
Inserting the module 24
Intended use 8
ISM - Intelligent Sensor Management 16
ISM - Plug and Measure 17

Index

L

- LED 12
- Limit value 69
- Limit value, icons in the measurement display 69
- Linear characteristic 61
- Lock Functions 47
- Lock icon 47
- Logarithmic output curve 62
- Logbook 57, 73

M

- Maintenance 72
- Membrane body changes (ISM only) 20
- Menu selection 27
- Menu structure 13, 27
- Message icons 59
- Message list 79
- Messages 59
- Messages, behavior of current outputs 64
- Messages Calculation Blocks O₂ / O₂ 82
- Messages O₂ 80
- Message when the current range is exceeded 64
- Modular concept 11
- Module diagnostics 75
- Module equipment 15
- Modules 14

O

- OK1,OK2 inputs 70
- OK1/OK2 switching level 70
- OK1 usage 70
- OK2, selecting parameter set (A, B) 71
- OK inputs 60
- Operating levels 46
- Operator level 46

Index

Output filter 63
Overview of parameter setting 90

P

Parameter set selection 71
Parameter setting 49
Parameter setting, overview 90
Parameter setting documentation 49
Passcode entry 28
Passcode lost 28
Product calibration: Concentration 42
Product calibration: Saturation 40
Protective wiring 66

Q

Query actual device/module software 10

R

Relay contacts 65
Relay contacts, usage 67, 68
Release (softkey function) 47
Replacing the front module 14
Return of products 2
Rinse contact 68

S

Safety information 9
Screw clamp connector 87
Sealing 14
Secondary displays 12, 29
Select a calibration method 34
Sensocheck 54
Sensoface 52
Sensoface criteria 54
Sensor data 52
Sensor data parameters 52

Index

Sensor monitor 75
Sensor monitoring details 52
Sensor network diagram 21, 76
Sensor wear monitor (ISM only) 21
Serial No. 10
Shield 24
Short description 12
Signaling active parameter set via relay contact 71
SIP (Sterilization in Place) 22
Slope 54
Slot for SmartMedia card 14
SmartMedia card 14
Softkeys 12, 29
Softwareversion 10
Specifications 84, 87
Start (4 mA) and end (20 mA) 60
Statistics 76
Switching parameter sets via OK2 71

T

Terminal compartment 15
Terminal plate 14
Terminal plates 23
Trademarks 2

V



















Variable limits 59
Viewing level 46

W

Warranty 2
Wiring examples 25, 26

Z

Zero correction 45

Icon	Explanation of Icons Important for this Module
	The device is in measuring mode.
 	The device is in calibration mode. HOLD mode active for currently calibrated module.
 	The device is in maintenance mode. HOLD mode active.
 	The device is in parameter setting mode. HOLD mode active.
	The device is in diagnostics mode.
NAMUR signals   	<p>HOLD. The NAMUR “function check” contact is active (factory setting: Module BASE, Contact K2, N/O contact). Current outputs as configured:</p> <ul style="list-style-type: none"> • Current meas.: The currently measured value appears at the current output • Last usable value: The last measured value is held at the current output • Fixed 22 mA: The output current is at 22 mA <p>Failure. The NAMUR “failure” contact is active (factory setting: Module BASE, Contact K4, N/C contact). To view error message, call up: Diagnostics menu/Message list</p> <p>Maintenance request. The NAMUR contact is active (factory setting: Module BASE, Contact K2, N/O contact). To view error message, call up: Diagnostics menu/Message list</p>
	Limit indication: Lower / upper range limit exceeded
 man	Temperature detection by manual input
	Calibration is performed
	Calibration - Step 1 of product calibration has been executed. The analyzer is waiting for the sample values.
	In the plaintext display in front of a menu line: Access to next menu level with enter
	In the plaintext display in front of a menu line when it has been blocked by the Administrator against access from the Operator level.
	Designates the module slot (1, 2 or 3), allowing the clear assignment of measured-value/parameter displays in the case of identical module types.
 B	Indicates the active parameter set. (The analyzer provides two parameter sets A and B. Up to 5 sets can be added using additional functions and SmartMedia card.)

Menu Selection O₂ 4700i(X) Module



Calibration and Adjustment	31
Automatic calibration in water	36
Automatic calibration in air	38
Product calibration: Saturation	40
Product calibration: Concentration	42
Data entry of premeasured sensors	44
Zero correction	45



Parameter setting	46
Documenting	49
Sensor data	52
Sensoface	54
Calculation Blocks	55
Logbook	57
Factory setting	57
Messages	58
BASE module	60
Current outputs	60
Relay contacts	67
Rinse contact	68
Limit value	69



Maintenance	72
--------------------------	-----------



Diagnostics	73
Message list, Logbook	73
Module diagnostics, Sensor monitor	75
Cal record	76
Sensor network diagram	76
Statistics	76
Diagnostics messages as favorite	77
Message list	79
Logbook	79