

Operating instructions and installation information

METTLER TOLEDO MultiRange ID7-Form-XP application software

METTLER TOLEDO

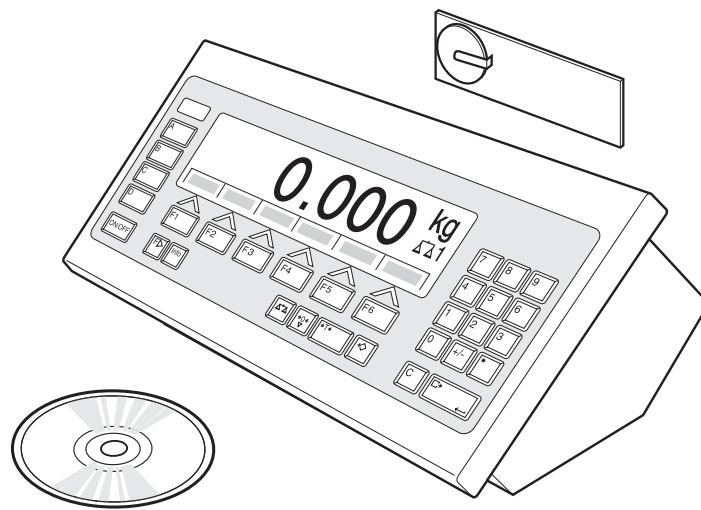

Contents

	Page
1	Introduction and assembly 2
1.1	Introduction 2
1.2	Safety precautions 2
1.3	Installing ID7-Form-XP 2
2	Formulation functions 5
2.1	STORED FORMULATION application 5
2.2	FORMULATION application 15
2.3	PHARMA FORMULATION application 17
2.4	TOTALIZING application 20
3	Settings in the master mode 22
3.1	PAC master mode block 22
4	Application blocks 34
4.1	PAC application blocks 34
5	What to do if ...? 40
6	Technical data 41
7	Appendix 42
7.1	ID7-Form-XP with Interface 4 I/O-ID7 or Relay Box 8-ID7 42
7.2	FormTool-XP 42
8	Index 46

1 Introduction and assembly

1.1 Introduction

ID7-Form-XP is an application software for the METTLER TOLEDO ID7-... weighing terminal. The functions of the ID7-Form-XP can be used after replacing the memory module.

The delivery scope of the ID7-Form-XP also includes the software FormTool-XP, with which you can also display all processes on the ID7-Form-XP on a PC, see section 7.2.

Documentation

The ID7-... weighing terminal is provided with operating instructions and installation information for the original configuration of the weighing terminal. Please see these operating instructions and installation information for basic information on working with the ID7-... weighing terminal.

These operating instructions and installation information contain additional information on installing and using the ID7-Form-XP application software.

1.2 Safety precautions

1.2.1 Installation in explosion protected ID7xx-... weighing terminal



EXPLOSION HAZARD

The ID7xx-... weighing terminal may only be opened by METTLER TOLEDO service technicians.

→ To install the ID7-Form-XP application software, please contact METTLER TOLEDO Service.

1.2.2 Installing in ID7-... weighing terminal



▲ Only authorized personnel may open the weighing terminal and install the ID7-Form-XP application software.

▲ Before opening the terminal, pull the power plug or switch off the power supply for terminals with a fixed connection.

1.3 Installing ID7-Form-XP

1.3.1 Opening ID7-... weighing terminal

Desk unit

1. Unscrew the screws on the underside of the cover.
2. Lay down the cover toward the front. In doing so, make sure that the cables are not damaged.

Wall unit

1. Unscrew the screws on the underside of the cover and fold the cover toward the front. When doing so, make sure that the cables are not damaged.
2. Fold open the mounting plate.

Panel unit

1. Unscrew the 10 hex bolts on cut-out on the inside of the switch cabinet.
2. Remove the cover from the switch cabinet and fold toward the front. When doing so, make sure that the cables are not damaged.
3. Fold open the mounting plate.

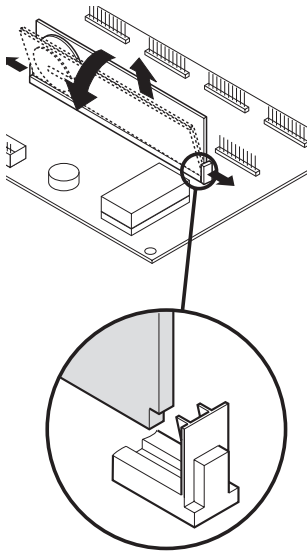
1.3.2 Mounting ID7-Form-XP

1. Bend the bracket of the memory module outward on both sides, tilt the memory module forward and remove.
2. Insert the ID7-Form-XP memory module tilted slightly toward the front and move it into the vertical position until it engages. The empty space of the module must be on the bottom right.

1.3.3 Closing ID7-... weighing terminal**Closing desk unit**

1. Lay device on cover and fix slightly in place with 3 screws.
2. Press unit into cover so that 3 engaging springs engage.
3. Tighten screws.

**CAUTION**

The IP68 protection type can only be guaranteed when the weighing terminal is closed again properly.

- The 3 engaging springs must be completely engaged.
- Make sure that the keypad cable is not pinched.

Closing wall unit

1. Fold in the mounting plate.
2. Position the cover and screw on again. When doing so, make sure that no cables are pinched.

Closing panel unit

1. Fold in the mounting plate and position the cover on the cut-out again.
2. Secure the cover on the switch cabinet from the inside with 10 screws. When doing so, make sure that no cables are pinched.

2 Formulation functions

The ID7-Form-XP offers 4 different formulation applications, which you can select in the master mode:

STORED FORMULATION, FORMULATION, PHARMA FORMULATION and TOTALIZING.

With the FormTool-XP software provided you can operate or monitor all applications from a PC, see section 7.2.

2.1 STORED FORMULATION application

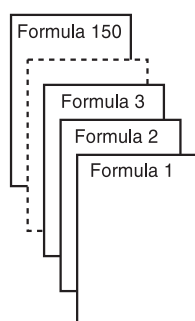

In this application you can call up the stored formulas and use them as the basis for the new formulation. A maximum of 150 formulas can be stored.

Depending on the settings in the master mode,

- you can fill the components into one container consecutively (section 2.1.1) or fill each component of a formulation into a separate container (section 2.1.2) or work through the formulation in the batch mode (section 2.1.3),
- the target weight of the stored formula is adopted or you are asked to enter a target weight,
- an automatic rescaling is offered for a component that was filled outside the tolerance (section 2.1.4),
- you can monitor the adherence of the tolerances with the DELTATRAC when weighing in to a target weight,
- the ID7-Form-XP provides you with support for warehouse management.

Prerequisite

The STORED FORMULATION application is set in the master mode.

Function keys

With the STORED FORMULATION application the function keys have the following assignment at the start:

START STORED FORMULATION
Starts the application

→ Press any function key to start the application.

If the function keys have a different assignment

→ Press the FUNCTION CHANGE key repeatedly until the function key assignment shown above appears.

Assignment of the function keys when working through stored formulas

The assignment of the function keys adjusts to the operating sequence.

Selecting formula

← F	F →	SELECT	COMPO	SUM	STOP
View formulas: Descending	View formulas: Ascending	Select formula	View components of the formula	Call up accumulated sum of the formula	Cancel application

Selecting component

← C	C →	SELECT	INVENT	–	STOP
View components: Descending	View components: Ascending	Select component	Information on stock level and consumption of raw material	–	Park formula, cancel application

Weighing in component

–	–	PLUS	MANUAL	–	STOP
–	–	Add component to formula	Enter weight values manually	–	Return to "Select component"

Information after completing formula

FORMU	← C	C →	–	–	STOP
Call up the actual value for the formula and the deviation from the target weight	View dispensed components: Descending	View dispensed components: Ascending	–	–	Return to "Select formula"

Information after completing batch mode

–	← B	B →	–	–	STOP
–	View dispensed batches: Descending	View dispensed batches: Ascending	–	–	Return to "Select formula"

Messages

Depending on the setting in the master mode, messages appear in the display during formulation.

→ Carry out request and confirm the message with the ENTER key if necessary to continue formulation.

2.1.1 Filling all components into a common container

Prerequisite

VERTICAL FILLING is set in the master mode.

Selecting formula

1. Start the application with the START STORED FORMULATION key.
2. If PASSWORD ON is selected in the master mode, enter your user name and password and confirm with ENTER.
3. Place container on weighing platform.
The container is automatically tared when WORKING SEQUENCE ON is selected in the master mode.
4. Select formula with <-F and F-> keys and confirm with SELECT.
– or –
Enter the number of the stored formula (1 ... 150) with the number block and confirm with SELECT or <-F or F->.
– or –
Press Code A key, enter formula name and confirm with ENTER.
– or –
Press Code A key, enter formula identification and confirm with ENTER.
5. When TARGET WEIGHING ON is set in the master mode, enter the target weight of the formula and confirm with the ENTER key.

The target value and the name of the formula are printed.

Selecting and dispensing component

1. Select component with <-C and C-> keys and confirm with SELECT.
– or –
Enter number of component with the number block and confirm with SELECT or <-C or C->.
– or –
Press Code B key, enter component name and confirm with ENTER.
– or –
Press Code B key, enter component identification and confirm with ENTER.
2. Fill component.
3. Press PLUS key.
Target value, tolerance and actual value of the component are printed.
4. To fill the remaining components into the container, repeat steps 1 to 3.

Notes

- If the weight of a component lies within the tolerance, the value for the deviation is shown in brackets < ... >.
- Components with the unit Pcs. do not contribute to the weight sum of the formula.
- If ORDER OF COMPONENTS FIXED is selected in the master mode, components cannot be selected, but instead must be worked through in the specified order.
- If SELECT BARCODE ON is selected in the master mode, each component must be confirmed with a barcode.
- Prints can be configured in the INTERFACE master mode block.

Finishing formula**Information on formula just dispensed**

1. When the message CLEAR SCALE appears, remove weighing sample from the weighing platform.
The name, actual weight and deviation from the target weight for the formula are printed.
The actual weight and the difference to the target weight for the formula just dispensed appear in the display.
2. Display the actual weight and difference to the target weight for the components with the <-C and C-> keys.

Closing formula

3. Close formulation with the STOP key.
The formula selection appears again.

2.1.2 Filling each component into separate container**Prerequisite**

BATCH FILLING is selected in the master mode.

Selecting formula

1. Start the application with the START STORED FORMULATION key.
2. If PASSWORD ON is selected in the master mode, enter your user name and password and confirm with ENTER.
3. Select formula with <-F and F-> keys and confirm with SELECT.
– or –
Enter the number of the stored formula (1 ... 150) with the number block and confirm with SELECT or <-F or F->.
– or –
Press Code A key, enter formula name and confirm with ENTER.
– or –
Press Code A key, enter formula identification and confirm with ENTER.
4. When TARGET WEIGHING ON is set in the master mode, enter the target weight of the formula and confirm with the ENTER key.

The target value and the name of the formula are printed.

Selecting and dispensing component

1. Select component with <-C and C-> keys and confirm with SELECT.
 – or –
 Enter number of component with the number block and confirm with SELECT or <-C or C->.
 – or –
 Press Code B key, enter component name and confirm with ENTER.
 – or –
 Press Code B key, enter component identification and confirm with ENTER.
2. Place container on weighing platform.
 The container is automatically tared when WORKING SEQUENCE ON is selected in the master mode.
3. Fill component.
4. Press PLUS key.
 Target value, tolerance and actual value of the component are printed.
5. Remove container from weighing platform.
6. To fill the remaining components, repeat steps 1 to 5.

Notes

- If the weight of a component lies within the tolerance, the value for the deviation is shown in brackets < ... >.
- If ORDER OF COMPONENTS FIXED is selected in the master mode, components cannot be selected, but instead must be worked through in the order entered.
- Components with the unit Pcs. do not contribute to the weight sum of the formula.
- If SELECT BARCODE ON is selected in the master mode, each component must be confirmed with a barcode.
- Prints can be configured in the INTERFACE master mode block.

Finishing formula

Information on formula just dispensed

1. When the message CLEAR SCALE appears, remove weighing sample from the weighing platform. The name, actual weight and deviation from the target weight for the formula are printed.
 The actual weight and the difference to the target weight for the formula just dispensed appear in the display.
2. Display the actual weight and difference to the target weight for the components with the <-C and C-> keys.

Closing formula

3. Close formulation with the STOP key.
 The formula selection appears again.

2.1.3 Batch mode

Prerequisite

BATCH MODE is selected in the master mode.

Selecting formula

1. Start the application with the START STORED FORMULATION key.
2. If PASSWORD ON is selected in the master mode, enter your user name and password and confirm with ENTER.
3. Select formula with <-F and F-> keys and confirm with SELECT.
– or –
Enter the number of the stored formula (1 ... 150) with the number block and confirm with SELECT or <-F or F->.
– or –
Press Code A key, enter formula name and confirm with ENTER.
– or –
Press Code A key, enter formula identification and confirm with ENTER.
4. Enter number of batches and confirm with ENTER key.
5. When TARGET WEIGHING ON is set in the master mode, enter the target weight of the formula and confirm with the ENTER key.

The target value and the name of the formula are printed.

Selecting and dispensing component

1. Select component with <-C and C-> keys and confirm with SELECT.
– or –
Enter number of component with the number block and confirm with SELECT or <-C or C->.
– or –
Press Code B key, enter component name and confirm with ENTER.
– or –
Press Code B key, enter component identification and confirm with ENTER.
Then the following display appears for information: ITERATION 1/n.
2. Enter batch ID and confirm with ENTER.
3. Place container on weighing platform.
The container is automatically tared when WORKING SEQUENCE ON is selected in the master mode.
4. Fill component.
5. Press PLUS key.
Target value, tolerance and actual value of the component are printed.
6. Remove container from weighing platform.

7. To fill the remaining batches, repeat steps 2 to 7.
The ITERATION display is counted up until the last batch n/n.
When the component for all batches is filled, the message ITERATION COMPLETE appears.
8. To fill the remaining components, repeat steps 1 to 8. The batch ID need not be entered again.

Notes

- If the weight of a component lies within the tolerance, the value for the deviation is shown in brackets < ... >.
- Components with the unit Pcs. do not contribute to the weight sum of the formula.
- If ORDER OF COMPONENTS FIXED is selected in the master mode, components cannot be selected, but instead must be worked through in the order entered.
- If SELECT BARCODE ON is selected in the master mode, each component must be confirmed with a barcode.
- Prints can be configured in the INTERFACE master mode block.

Completing batch

Information on batch just dispensed

1. When all batches have been filled, the name, actual weight and difference to the target weight are printed.
The batch ID, actual weight and tare for a batch of the formula just dispensed appear in the display.
2. Display the actual weight and tare for the remaining batches with the <-B and B-> key.

Closing batch

3. Close formulation with the STOP key.
The formula selection appears again.

2.1.4 Correcting target value

When a component has been filled above tolerance, all remaining components of the formula can be adjusted accordingly with the rescaling.

Prerequisite

RESCALING ON is selected in the master mode and the dispensed component has exceeded the upper tolerance by a maximum of 50 %.

- When the message RESCALING ? appears, press the ENTER key. Target values of the remaining components are automatically adjusted.

Notes

- If the actual values of components already worked through lie outside the new tolerance, you will be requested to redispense or reenter these components manually.
- A rescaling is only possible once during a formulation process.
- If after rescaling the newly rounded target value for a component with the unit Pcs. lies outside the tolerance, this will result in cancelling.
- With a component that has to be redispensed, a lower and upper limit will be displayed and printed in place of the tolerance.

2.1.5 Accepting known weight value for the formula

1. Press MANUAL key.
2. Enter weight value and confirm with ENTER.
The weight value is stored in the formula memory and the component counter is increased by 1.

Note

With the FUNCTION CHANGE key the weight unit for entering known weight values can be selected.

2.1.6 Displaying, saving or deleting accumulated sum for current formula

Manual If CLEAR SUM MANUALLY is set in the master mode, the sum can be displayed or deleted at any time in the formulation mode.

1. Press the SUM key in the "Select formula" input mask.
The sum appears above the selected formula in the display.
2. To save the sum and return to the formula, press the SAVE function key.
– or –
To clear the accumulated sum and return to the formula, press the CLEAR function key.

Automatic If CLEAR SUM AUTOMATICALLY is set in the master mode, the sum can only be displayed in the formulation mode.

- Press the SUM key in the "Select formula" input mask.
The sum appears for 5 seconds above the selected formula in the display.

2.1.7 Working with lot and batch numbers

Lot number When ENTRY LOT NUMBER ON is selected in the master mode, a request that the lot number for the formula be entered appears when the formula is started.

Batch number When ENTRY BATCH NUMBER ON is selected in the master mode, a request that the batch number be entered appears each time a component is called.

Note

The designations LOT NUMBER and BATCH NUMBER can be changed in the master mode.

2.1.8 Filling components in several steps

If in the VERTICAL FILLING operating mode, INPUT BATCH NUMBER ON, MULTIPLE is selected in the master mode, a component can be dispensed in up to 6 steps. A maximum of 200 steps are possible per formula.

1. Select component and enter batch number.
2. Partially fill component and press PLUS key.
The component still appears in the component selection, however now with a reduced target weight.
3. Select next component and enter batch number.
4. Partially or completely fill component and press PLUS key.
5. Call the component already partially dispensed again and apply the displayed batch number or enter a new batch number.
6. Fill another part of the component or finish dispensing the component and press the PLUS key.
7. Continue until all components are dispensed up to the target weight.

2.1.9 Parking formulas

If a formula cannot be completely dispensed, because, for example, a raw material must first be refilled, this formula can be "parked" and completely dispensed at a later time.

- Parking formula**
1. Press the CANCEL key in the component selection.
The question PARK FORMULA? appears.
 2. Answer the question with YES.
The formula selection appears in the display. A new formula can be dispensed.

- Finishing dispensing parked formula**
1. Call the parked formula again with the formula ID.
In the component selection now only the components not yet dispensed appear.
 2. Fill missing components and end formula.

Note

Only one formula can be parked. If an additional formula is to be parked, then the first parked formula is deleted.

2.1.10 Inventory management with ID7-Form-XP

If the inventory level has been entered when stocking the raw materials, then the inventory level can be displayed when dispensing this raw material.

→ Press the INVENTORY key during component selection.

The inventory level and the consumption since the last inventory receipt are displayed consecutively.

2.1.11 Formulation of STORED FORMULATION on multiple weighing platforms

Up to 3 weighing platforms can be connected to the ID7-Form-XP, see chapter "Basic functions" of the operating and installation instructions for the weighing terminal ID7-...

Note for formulation of stored formulation on multiple weighing platforms

→ Use a separate container on each weighing platform.

2.1.12 Printout example

Date	02/02/02	-----	Component	Sugar
Time	15:16:17		Batch number	ME3612/23.01.02
Formula No.	1		Raw material No.	623
Formula ID	52		1st formulated weight	0.500 kg
Lot number	#1234		2nd formulated weight	0.500 kg
Formula name	Cream toffee		-----	
Component counter	5		Component	Cream
Target	1.620 kg		Batch number	ME3784/18.01.02
Tolerance	0.160 kg		Raw material No.	15
Previous message	1		1st formulated weight	0.100 kg
Previous message	3		2nd formulated weight	0.100 kg
Previous message	5		-----	
Next message	6		Component	Milk
Next message	8		Batch number	ME3234/31.01.02
Target value correction	0		Raw material No.	69
-----			1st formulated weight	0.520 kg
Component	Baking powder		2nd formulated weight	0.500 kg
Batch number	ME5461/01.02.02		-----	
Raw material No.	713		Batch ID	B40
1st formulated weight	0.020 kg		Batch net	1.640 kg
2nd formulated weight	0.020 kg		Gross	1.900 kg
-----			Tare	0.260 kg
Component	Flour		Batch ID	B41
Batch number	ME1667/20.01.02		Batch net	1.600 kg
Raw material No.	52		Gross	1.860 kg
1st formulated weight	0.500 kg		Tare	0.260 kg
2nd formulated weight	0.480 kg		=====	

2.2 FORMULATION application

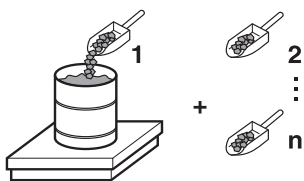

In this application, you can measure out several components into a container one after the other. Each formula and each component can be provided with an identification.

Prerequisite

In the master mode, the FORMULATION application is selected.

Function keys

With the FORMULATION application the function keys are allocated as follows:

MAN	SUM	CONT	PLUS	–	–
Enter weight values manually	Display net sum and print out	Subtotal for current container	Add weight values	–	–

→ Press the relevant function key, in order to select the function.

Example

→ Press the MAN key.
Then you can enter the known weight values manually via the keyboard.

When the function keys have a different allocation

→ Press the FUNCTION CHANGE key until the function keys allocation displayed above appears.

2.2.1 Formulation

1. Press CODE A key and enter the identification for the formula.
2. Place the empty container on the weighing platform and tare.
3. Press CODE C key and enter the identification for the first component.
4. Add first component.
The display indicates the net weight of the current component.
5. Press PLUS key.
The weighing platform tares automatically and the display registers 0.000 kg.
The current net sum in the container is determined and the component counter is increased by 1.
6. In order to add further components in the container, repeat steps 3 to 5.
Max. 15 components per container are possible.
7. If more than 15 components are filled into a container or the container is overfilled: Press CONT key and place a new container on the weighing platform.
The container counter is increased by 1, the component counter is set back to zero for the new container and the tare weight is deleted.

Changing the container

- Closing formulation**
8. When fewer than 15 components have been dispensed into container, press CONT key.
 9. Clear weighing platform.
 10. Press SUM key.
The net sum is displayed and automatically printed out.
 11. If the net sum is to be placed into temporary storage, press the ENTER key.
 12. Press CLEAR key.
The net sum is deleted and the component counter and the container counter are reset.

2.2.2 Carrying over the known weight value to the sum

1. Press MAN key.
2. Enter the weight value and confirm with ENTER.
The weight value is stored in the sum memory and the component counter is increased by 1.

Note

With the FUNCTION CHANGE key you can select the weight unit for entering known weight values.

2.2.3 Tolerance control with DeltaTrac

Using DeltaTrac in the application FILLING you can monitor on weighing in the compliance of the tolerances with the target weight, see chapter "Additional functions" in the operating instructions and installation information ID7-... weighing terminal.

The weight value is only added to the sum when the weight value lies within the tolerance limits.

1. Preset the DeltaTrac target values for the current component.
2. Add the component.
If there is an addition beyond the tolerance limits, remove the container and fill again or delete the target value.
3. Press PLUS key.
The components are only carried over to the sum when they lie within the tolerance limits.

Note

With the FUNCTION CHANGE key you can select the weight unit for entering the DeltaTrac target values.

2.2.4 FORMULATION on multiple weighing platforms

Up to 3 weighing platforms can be connected to the ID7-Form-XP, see chapter "Basic functions" in the operating instructions and installation information ID7-... weighing terminal.

Note for formulation on multiple weighing platforms

→ Use a separate container on each weighing platform.

2.2.5 Recalling information regarding the FORMULATION application

Using the key sequence INFO, FUNCTION key you can recall information regarding the FORMULATION application.

INFO, MAN	Display last entered weight value.
INFO, CONT	Display number and subtotal for the current container.
INFO, PLUS	Display the last weighed components.

2.3 PHARMA FORMULATION application

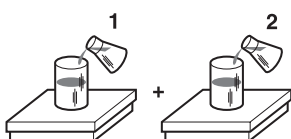

In this application, you can fill each component of a formula in a separate container. Each formula and each component can be individually provided with an identification.

Prerequisite

In master mode, the PHARMA FORMULATION application is selected.

Function keys

With the PHARMA FORMULATION application the function keys are allocated as follows:

MANUAL	SUM	CONTAINER
Enter weight value manually	Display net sum and print out	Close container

→ Press the relevant function key, in order to choose the functions.

Example

→ Press the MANUAL key.
Then you can enter the known weight values manually via the keyboard.

If the function keys have a different allocation

→ Press the FUNCTION CHANGE key until the function keys allocation displayed above appears.

2.3.1 Pharma formulation

1. Press CODE A key and enter the identification for the formula.
2. Place the container on the weighing platform and tare.
The container counter is increased by 1.
3. Press CODE C key and enter the identification of the first component.
4. Add the components.
The display shows the net weight of the current component.
5. Press CONTAINER key.
The tare weight of the container is deleted.
6. In order to add further components, repeat steps 2 to 5.

Closing pharma formulation

7. Press SUM key.
The net sum is displayed and automatically printed out.
8. If the net sum is to be placed into temporary storage, press the ENTER key.
9. Press CLEAR key.
The net sum is deleted, and the component and container counters are reset.

2.3.2 Carrying over the weight values to the sum

1. Press MANUAL key.
2. Enter the weight value and confirm with ENTER.
The weight value is stored in the sum memory and the item counter is increased by 1.

Note

With the FUNCTION CHANGE key you can select the weight unit for entering known weight values.

2.3.3 Tolerance control with DeltaTrac

With DeltaTrac in the application FILLING you can monitor on weighing in the compliance of the tolerances with a target value, see chapter "Additional functions" in the operating instructions and installation information ID7-... weighing terminal. The weight value is only added to the sum when the weight value lies within the tolerance limits. Possible settings in the master mode:

- FILL – A target value applicable to all fillings.
- COMPOUNDING – A target value for each container or each component.

Filling

1. Preset DeltaTrac target values.
2. Add component.
If there is an addition beyond the tolerance limits, remove the container and fill again or delete the target value.
3. Press CONTAINER key.
The components are only then carried over to the sum if they lie within the tolerance limits.
4. For the additional components, repeat steps 2 and 3.
The DeltaTrac target values remain stored until new values are entered or the values are deleted.

Compounding

1. Preset the DeltaTrac target values for the components.
2. Add component.
If there is an addition beyond the tolerance limits, remove the container and fill again or delete the target value.
3. Press CONTAINER key.
The component is only then carried over to the sum if it lies within the tolerance limits.
4. For additional components, repeat steps 1 to 3.
The DeltaTrac target values are deleted after each component.

Note

With the FUNCTION CHANGE key you can select the weight unit for entering the DeltaTrac target values.

2.3.4 PHARMA FORMULATION on multiple weighing platforms

Up to 3 weighing platforms can be connected to the ID7-Form-XP, see chapter "Basic functions" in the operating instructions and installation information ID7-... weighing terminal.

Note for formulation on multiple weighing platforms

→ Use a separate container on each weighing platform.

2.3.5 Recalling information regarding the PHARMA FORMULATION application

Using the key sequence INFO, FUNCTION key you can recall information regarding the PHARMA FORMULATION application.

INFO, MANUAL Display the last entered weight value.

INFO, CONTAINER Display the sum for the current container.

2.4 TOTALIZING application

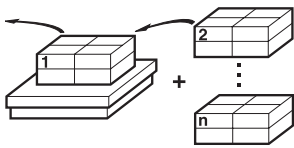

In this application, you can determine the total weight of several items. Each sum and each item can be provided with an identification.

Prerequisite

In the master mode the TOTALIZING application is selected.

Function keys

With the TOTALIZING application the function keys are allocated as follows:

MANUAL	SUM	PLUS
Enter weight values manually	Display gross sum and print out	Add weight values

→ Press the relevant function key in order to select the function.

Example

→ Press the MANUAL key.
Then you can enter the weight values manually via the keyboard.

If the function keys have a different allocation

→ Press the FUNCTION CHANGE key until the function keys allocation displayed above appears.

2.4.1 Totalizing

1. Press CODE A key and enter the identification for the sum.
2. Press CODE C key and enter the identification for the first item.
3. Put the first item on.
4. Press PLUS key.
The item counter is increased by 1 and displayed with the gross sum.
5. Place the additional items on and repeat steps 2 to 4.
6. Press SUM key.
The gross sum is displayed and printed out automatically.
7. In order to place the gross sum into temporary storage, press the ENTER key.
8. In order to delete the gross sum, press the CLEAR key.
The item counter is reset.

Closing totalizing

2.4.2 Transferring the weight value to the sum

1. Press MANUAL key.
2. Enter the weight value and confirm with ENTER.
The weight value is stored in the sum memory and the item counter is increased by 1.

Note

With the FUNCTION CHANGE key you can select the weight unit for entering known weight values.

2.4.3 TOTALIZING on multiple weighing platforms

Up to 3 weighing platforms can be connected to the ID7-Form-XP, see chapter "Basic functions" in the operating instructions and installation information ID7-... weighing terminal.

Changing the weighing platform is always possible when using the TOTALIZING application.

2.4.4 Recalling information regarding the TOTALIZING application

Using the key sequence INFO, FUNCTION key you can recall information regarding the TOTALIZING application.

INFO, MANUAL	Display the last entered weight value.
INFO, PLUS	Display the number of items weighed until now.

3 Settings in the master mode

3.1 PAC master mode block

3.1.1 Overview of the PAC master mode block

In this block, the following settings are possible:

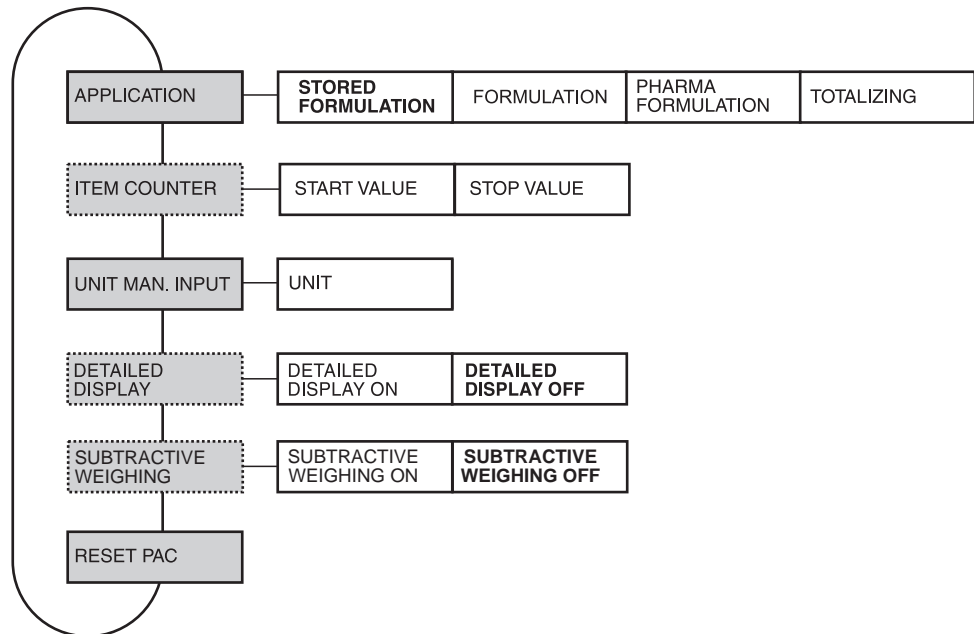

- Legend**
- Blocks on a **grey** background are described extensively in the following.
 - Factory settings are printed in **bold** type.
 - Blocks that appear only under specific conditions are **dotted**.

Note

With the FormTool-XP software provided you can operate or monitor all applications from a PC, see section 7.2.

3.1.2 Settings in the PAC master mode block

APPLICATION	Selecting application
STORED FORMULATION	Store formulas and use as basis for the new formulation. A maximum of 150 formulas with a maximum of 100 components each can be stored. A maximum of 2,000 components are possible for all formulas together.
RAW MATERIALS	<p>Create/edit raw materials database. A maximum of 500 raw materials can be stored.</p> <ul style="list-style-type: none"> • EDIT RAW MATERIALS, see section 3.1.3. • PRINT RAW MATERIALS • DELETE ALL RAW MATERIALS
MESSAGES	<p>Up to 5 messages can be assigned to each formula - two to each component. A total of 200 messages with a maximum of 24 characters can be stored. Create/edit message database, see section 3.1.4.</p> <ul style="list-style-type: none"> • EDIT MESSAGES, see section 3.1.4. • PRINT MESSAGES • MESSAGES ON/OFF – When MESSAGES OFF is selected, no messages are displayed during formulation, even if the formula or the component is provided with messages. • DELETE ALL MESSAGES
FORMULAS	<p>Create/edit formula database.</p> <ul style="list-style-type: none"> • EDIT FORMULAS, see section 3.1.5. • PRINT FORMULAS • CLEAR ALL FORMULAS
OPERATING MODE	<p>Dispensing of the components in a common or a separate container:</p> <ul style="list-style-type: none"> • VERTICAL FILLING – Fill all components into a common container; factory setting • SEVERAL CONTAINER – Fill each component into a separate container • BATCH MODE – The same formula can be dispensed simultaneously up to 100 times, i.e. each component is filled a corresponding number of times.
WORKING SEQUENCE	<p>When WORKING SEQUENCE ON is selected (factory setting), the prompt LOAD CONTAINER appears at the start of formulation and the container is automatically tared.</p>
TARGET WEIGHING	<p>Adjust formula target weight:</p> <ul style="list-style-type: none"> • ON – The formula target weight can be adjusted before each new formulation process • OFF – The stored formula target weight is accepted as the formula target weight; factory setting

APPLICATION	Selecting application
RESCALING	<p>Correct component target value following incorrect dispensing:</p> <ul style="list-style-type: none"> • ON – If the actual value exceeds the upper tolerance by less than 50 %, the operator can carry out a rescaling. Target values and tolerances of the other components are then corrected by the same percentage. If the actual value of components already filled lies outside their new tolerance limits, the operator will be asked to redispense these components. Factory setting. • OFF – The actual value is only accepted when it lies within the tolerance.
DELTATRAC	<ul style="list-style-type: none"> • ON – During weighing in the adherence to the tolerances is monitored. • OFF – Only the weight value is shown in the display; factory setting.
LOT NUMBER	<p>Each formula can be marked with a lot number.</p> <ul style="list-style-type: none"> • ENTER LOT NUMBER – When ENTER LOT NUMBER ON is selected, the entry of the lot number is requested at the start of the formula. • DESIGNATION LOT NUMBER – Change the text "LOT NUMBER".
BATCH NUMBER	<p>Each component can be marked with a batch number.</p> <ul style="list-style-type: none"> • ENTER BATCH NO. – When ENTER BATCH NO. ON is selected, the entry of the batch number is requested for each component. Additional settings: <ul style="list-style-type: none"> – ON Entry of the batch number is requested for each component. <ul style="list-style-type: none"> SINGLE The component must be filled at one time. MULTIPLE The component can be filled in several steps. – ON+ The last batch number entered is displayed each time the component is called up. The batch number can be accepted or a new batch number can be entered. <ul style="list-style-type: none"> SINGLE The component must be filled at one time. MULTIPLE The component can be filled in several steps. – OFF The batch number is not requested. • DESIGNATION BATCH NO. – Change the text "BATCH NUMBER".
CLEAR SUM	<ul style="list-style-type: none"> • AUTOMATIC – Sums are automatically cleared daily at the entered time. • MANUAL – Sums must be cleared manually; factory setting.
SELECT BARCODE	<p>If SELECT BARCODE ON is selected, each component must be confirmed with a barcode during formulation.</p>
PRINTING BEFORE FORMULATION	<p>When PRINTING BEFORE FORMULATION ON is selected, the selected formula is printed out before starting on the GA46 printer.</p>
MANUAL ENTRY	<p>When MANUAL ENTRY OFF is selected, the manual entry function is deactivated during dispensing.</p>

APPLICATION	Selecting application
ORDER OF COMPONENTS	<ul style="list-style-type: none"> • FIXED – The components must be dispensed in the specified order. • VARIABLE – The components can be dispensed in any desired order; factory setting.
PRINTING AFTER FORMULATION	When PRINTING AFTER FORMULATION ON is selected, the dispensed formula is printed out on the GA46 printer after completion. Not possible in the batch mode.
PASSWORD	When PASSWORD ON is selected, the application STORED FORMULATION can only be run after entering a password.
USER LIST	Entry of USER NAMES and related PASSWORDS.
FORMULATION	Fill the formula components one after the other into the container.
PHARMA FORMULATION	Fill the formula components one after the other into separate containers. Possible settings: <ul style="list-style-type: none"> • FILL – Fill all components to the same target value. • COMPOUNDING – Fill each component to a different target value.
TOTALIZING	Totalize several items.

ITEM COUNTER	Setting the item counter with the application TOTALIZING
START VALUE	Possible values: 1 ... 9999 (factory setting: 1)
STOP VALUE	Possible values: 1 ... 9999 (factory setting: 9999)

UNIT MANUAL ENTRY	Selecting preferred unit for weight values, which are entered with the MANUAL key
UNIT	Possible units: g, kg, lb, oz, dwt, oz, Stk, Pcs Factory setting: kg

DETAILED DISPLAY	Switching on/off additional info line in display
	If DETAILED DISPLAY ON is set, an additional line for info appears in the display, e. g. "Item: 2/9999" For FORMULATION, PHARMA FORMULATION and TOTALIZING only. Factory setting: DETAILED DISPLAY OFF.

SUBTRACTIVE WEIGHING	Totalising with subtractive weighing
	<p>If SUBTRACTIVE WEIGHING ON is selected, totalising can also occur with subtractive weighing. For the TOTALISING application only. Factory setting: SUBTRACTIVE WEIGHING OFF.</p>

RESET PAC	Resetting all functions to the factory settings	
	APPLICATION OPERATING MODE WORKING SEQUENCE TARGET WEIGHING RESCALING DELTATRAC LOT NUMBER BATCH NUMBER CLEAR SUM SELECT BARCODE PRINTING BEFORE FORMULATION MANUAL ENTRY ORDER OF COMPONENTS PRINTING AFTER FORMULATION PASSWORD ITEM COUNTER UNIT MANUAL ENTRY DETAILED DISPLAY SUBTRACTIVE WEIGHING	Stored formulation Vertical filling On Off On Off Off Off Manual Off Off Variable Off Off Start value = 1, Stop value = 9999 kg Off Off

3.1.3 Editing raw materials

Input mask The following input masks appear for editing the raw materials database (Example):

ID 001	: H2O
NAME	: WATER
INVENTORY	: 25.0 kg
WARNING	: NO INVENTORY MANAGEMENT

MES. NO.	: 123
CONSUMED	: 2.0 kg
STOCKED	: 02.02.02 07.15.01
QUANTITY USE	: 3

Legend	ID nnn	Identification of raw material, alphanumeric, max. 20 characters								
	NAME	Name of raw material, alphanumeric, max. 30 characters								
	INVENTORY	Quantity of raw material stocked. The inventory quantity is updated with each dispensing								
	WARNING	Warning message for inventory management, The following settings are possible: <table> <tr> <td>NO INVENTORY MANAGEMENT</td> <td>No warning</td> </tr> <tr> <td>NEGATIVE INVENTORY</td> <td>Warning when inventory is 0 or below</td> </tr> <tr> <td>INVENTORY LESS THAN COMP.</td> <td>Warning when the quantity for the currently required component is not long in stock</td> </tr> <tr> <td>INVENTORY BELOW 10 %</td> <td>Warning when inventory is below 10 % of the original value</td> </tr> </table>	NO INVENTORY MANAGEMENT	No warning	NEGATIVE INVENTORY	Warning when inventory is 0 or below	INVENTORY LESS THAN COMP.	Warning when the quantity for the currently required component is not long in stock	INVENTORY BELOW 10 %	Warning when inventory is below 10 % of the original value
NO INVENTORY MANAGEMENT	No warning									
NEGATIVE INVENTORY	Warning when inventory is 0 or below									
INVENTORY LESS THAN COMP.	Warning when the quantity for the currently required component is not long in stock									
INVENTORY BELOW 10 %	Warning when inventory is below 10 % of the original value									
	MES NO.	Message to be displayed when this raw material is dispensed.								
	CONSUMED *	Display of the raw material consumed up to this point. This value is updated with each dispensing.								
	STOCKED *	Display of when the inventory was last added to.								
	QUANTITY USE *	Display of the number of formulas the raw material is used in.								
	* These values are only displayed, and cannot be edited.									

Function keys The function keys are assigned as follows:

<->	<	>	F▶	EDIT	↑
Select parameters	Scroll back in raw materials and warnings	Scroll forward in raw materials and warnings	Select function of function key F5	EDIT DEL SEARCH GO STORE	End raw material, with prompt regarding changes

Example 1 Creating new raw material with the ID 005

1. Select ID 005 in the raw material input mask with the keys < , >.
2. Press the F5 EDIT key and enter the raw material ID, e.g. RS 005. Confirm the entry with the ENTER key.
3. Select the next parameter NAME with the <-> key.
4. Press the F5 EDIT key and enter the raw material name, e.g. Water. Confirm the entry with the ENTER key.
5. Select the next parameter INVENTORY with the <-> key.
6. Press the F5 EDIT key and enter the stocked quantity, e.g. 25.0 (kg). Confirm the entry with the ENTER key.
7. Select the next parameter WARNING with the <-> key.
8. Select the type of warning for inventory management with the keys < , >.
9. Select the next parameter MES. NO. on the second page of the input mask with the <-> key.
10. Press the F5 EDIT key and enter the message number, e.g. 123. Confirm the entry with the ENTER key.
11. End Raw Material with the ↑ key. The question CHANGES ? appears.
12. If the new raw material is to be stored in the database, then press the YES key and otherwise the NO key.

Example 2 Updating inventory of raw material SUGAR

1. Select the parameter NAME in the raw material input mask with the <-> key.
2. Select the function SEARCH for the F5 key with the key F▶.
3. Press the key F5 SEARCH and enter the raw material name SUGAR. Confirm the entry with the ENTER key; the raw material SUGAR is displayed.
4. Select the parameter INVENTORY with the <-> key.
5. Press the key F5 EDIT and enter the new inventory quantity (remaining quantity + received). Confirm the entry with the ENTER key. The CONSUMED parameter is reset to 0, and the STOCKED parameter shows the date and time of the input just made.
6. End raw material with the ↑ key. The question CHANGES ? appears.
7. If the new raw material is to be stored in the database, then press the YES key and otherwise the NO key.

3.1.4 Editing messages

The ID7-Form-XP can store 200 messages of the message database, which can then be assigned to the formulas, components and raw materials.

The message database is divided into 3 areas:

1. Action messages, e.g. LOAD CONTAINER or ZERO-SET SCALE.
As soon as the action is carried out, the ID7-Form-XP switches to the next step.
2. Fixed messages, e.g. WEAR GOGGLES!
Here the ID7-Form-XP expects a confirmation with the ENTER or CLEAR key.
3. Free messages. Only freely definable messages can be edited.

No.	Action messages	No.	Fixed messages
001	LOAD CONTAINER	021	HANDLE WITH CARE !
002	LOAD CONTAINER, <TARE>	022	EXPLOSIVE !
003	CHANGE CONTAINER	023	WEAR GOGGLES !
004	RELIEVE SCALE	024	FLAMMABLE !
005	CHANGE SCALE, <ENTER>	025	FRAGILE !
006	SPECIFY TARE	026	WEAR GLOVES !
007	ZERO-SET SCALE	027	CAUSTIC !
008	ENTER LOT NUMBER	028	WEAR BREATHING PROTECTION !
009	ENTER BATCH NUMBER	029	TOXIC !
010	CONFIRM RAW MATERIAL	030	IRRITATING !
011	<ENTER>		Free messages
012	ENTER FORMULA	031	
013	ENTER COMPONENT	032	
014	ENTER CUSTOMER	033	
015	ENTER ORDER NUMBER	034	
016	SELECT SCALE 1	035	
017	SELECT SCALE 2	036	
018	SELECT SCALE 3	...	
019	CHANGE CONTAINER, <TARE>	...	
020		200	

Message input mask The following input mask appears for editing the messages (example):

MESSAGE : 035/200 FREE MESSAGE
CONTAINER RED

1st line Number of message (035) and type of message

4th line Contents of the message (maximum of 24 characters)

Function keys The function keys are assigned as follows:

<	>	–	F▶	EDIT	↑
Scroll back in messages	Scroll forward in messages	–	Select function of function key F5: EDIT, DEL etc.	EDIT DEL GO SEARCH	End message; settings are accepted as displayed

Example Creating message 036 "CONTAINER GREEN"

1. Select the function GO for the F5 key with the key F▶.
2. Press the key F5 GO and enter the message number 36.
Confirm the entry with the ENTER key.
The message number and the message type (free message) are displayed in the 1st line.
If the message already exists, the current function appears in the 4th line.
3. Select the function EDIT for the F5 key with the key F▶.
4. Press the key F5 EDIT and enter the message text.
Confirm the entry with the ENTER key.
5. End message with the ↑ key.

3.1.5 Editing formulas

Input mask formula header

The following input mask appears for editing the general formula data (example):

F 001	: AX0815B	(10.5 kg)
NAME	: COLA	
MES	: 100 123 150 – 099 101	
COMP	: 001/003 (005)	

Function keys

The function keys are assigned as follows:

<->	<	>	F▶	EDIT	↑
Select parameters	Scroll back in formulas	Scroll forward in formulas	Select function of function key F5	EDIT DEL GO SEARCH	End formula, changes are applied.

Legend

F nnn	Identification of formula, alphanumeric, max. 20 characters
NAME	Name of formula, alphanumeric, max. 30 characters
MES	Message numbers for 3 messages at the start of the formula and 2 messages after working through the formula. 000 means that no message is output.
COMP	Running component in the formula/number of components in the formula (raw material ID of running component)

Input mask for component

The following input mask appears for editing the individual formula components (example):

F 001	: FORMULA 001	
C 001	: RS 001	
	: WATER	
MESSAGES	: 002 – 003	(1/2)

F 001	: FORMULA 001	
C 001	: RS 001	
WEIGHT	: 9 kg	
TOLERANCE	: 0.5 kg	(2/2)

Function keys The function keys are assigned as follows:

<->	<	>	F▶	ADD	↑
Select parameters	Scroll back in components	Scroll forward in components	Select function of function key F5	ADD EDIT DEL GO SEARCH STORE	End component, with prompt regarding changes

Legend	F nnn	Identification of formula
	C nnn	Raw material ID, Raw material name
	MESSAGES	Number of messages that are displayed before the start of the component and after dispensing of the component.
	WEIGHT	Target weight of the component. With the change function key you can change the unit during the entry. The tolerance unit adjusts automatically.
	TOLERANCE	Tolerance of the component

Example 1 Creating new formula with F 005

Formula header

1. Select F 005 in the formula input mask with the keys < , >.
2. Press the F5 EDIT key and enter the formula ID, e.g. FORMULA 005.
Confirm the entry with the ENTER key.
3. Select the next parameter NAME with the <-> key.
4. Press the F5 EDIT key and enter the formula name, e.g. FANTA.
Confirm the entry with the ENTER key.
5. Select the next parameter MES with the <-> key.
6. Press the key F5 EDIT and enter the number of the first message to be displayed at the start of the formula, e.g. 001.
If no message is to be displayed, enter the number 000.
Confirm the entry with the ENTER key.
7. Select the next message with the <-> key and proceed as for the first message.
A total of 3 messages can be selected for the start of the formula and 2 messages for after the end of the formula.

Adding components

1. Select the parameter COMP. in the Formula input mask with the <-> key.
2. Press the key F5 ADD.
The display changes to the input mask for the component.
3. Select the desired raw material in the raw materials database with the keys < , >.
4. Select the parameter MESSAGES with the <-> key.

5. Press the key F5 EDIT and enter the number of the message to be displayed at the start of the component, e.g. 001.
If no message is to be displayed, enter the number 000.
Confirm the entry with the ENTER key.
6. Select the 2nd message to be displayed after dispensing the component with the <-> key.
7. Press the key F5 EDIT and enter the message number.
Confirm the entry with the ENTER key.
8. Switch to the 2nd page of the input mask for the components with the <-> key; the WEIGHT parameter is selected.
9. Press the key F5 EDIT and enter the target weight of the component.
Confirm the entry with the ENTER key.
10. Select the next parameter TOLERANCE with the <-> key.
11. Press the key F5 EDIT and enter the tolerance of the component.
Confirm the entry with the ENTER key.
12. End Component with the ↑ key.
The question CHANGES ? appears.
13. If the new component is to be stored in the formula database, then press the YES key and otherwise the NO key.
14. Create further components in the same way.

Example 2 Changing existing component C 003

1. Select the parameter COMP. in the formula input mask with the <-> key.
2. Select the function GO for the F5 key with the key F▶.
3. Press the key F5 GO and enter the component number 3.
Confirm the entry with the ENTER key; the component C 003 is displayed.
4. Select the parameter to be changed with the <-> key, e.g. WEIGHT.
5. Press the key F5 EDIT and enter the new target weight of the component.
Confirm the entry with the ENTER key.
6. If additional parameters are to be changed, proceed in the same manner.
7. End component with the ↑ key.
The question CHANGES ? appears.
8. If the change component is to be stored in the formula database, then press the YES key and otherwise the NO key.

4 Application blocks

In the following description, the application blocks are shown in the syntax for the MMR command set. When used with the SICS command set, please observe the SICS conventions, see Operating instructions and installation information for ID7-... weighing terminal.

4.1 PAC application blocks

4.1.1 General application blocks

No.	Content	Format
301	Pac version	Response: <code>A,B _ I,D / F,o,r,m,P,a,c _ V,x,x . x,x</code>
302	Program number	Response: <code>A,B _ I,P,7,2,-,0,-,0,x,x,x _</code>
316	Unit manual entry	Response: <code>A,B _ Unit</code> Write: <code>A,W 3,1,6 _ Unit</code>
318 ... 321	Identification data Code A ... Code D	Response: <code>A,B _ Name (text_20) _ _ Identification (text_20)</code> Write: <code>A,W 3,x,x _ Name (text_20) \$,\$ Identification (text_20)</code> Comment: xx = 18 ... 21; the blocks 318 ... 321 contain the same information as blocks 094 ... 097.
341	Conversion factor for the neutral unit with manual entry	Response: <code>A,B _ Weight value _ Unit</code> Write: <code>A,W 3,4,1 _ Weight value _ Unit</code>

4.1.2 Application blocks FORMULATION, PHARMA FORMULATION, TOTALIZING

No.	Content	Format
310	Counter	Response: <input type="text" value="A"/> <input type="text" value="B"/> <input type="text" value="Number_4"/> Comment: Application FORMULATION, PHARMA FORMULATION: Component counter Application TOTALIZING: Item counter
311	Container counter	Response: <input type="text" value="A"/> <input type="text" value="B"/> <input type="text" value="Number_4"/> Comment: only with the application FORMULATION, PHARMA FORMULATION
312	Component counter current container	Response: <input type="text" value="A"/> <input type="text" value="B"/> <input type="text" value="Number_4"/> Comment: only with the application FORMULATION
313	Sum net weight	Response: <input type="text" value="A"/> <input type="text" value="B"/> <input type="text" value="Weight value"/> <input type="text" value="Unit"/>
314	Sum gross weight	Response: <input type="text" value="A"/> <input type="text" value="B"/> <input type="text" value="Weight value"/> <input type="text" value="Unit"/> Comment: only with the application TOTALIZING
315	Manual entry	Response: <input type="text" value="A"/> <input type="text" value="B"/> <input type="text" value="Weight value"/> <input type="text" value="Unit"/>
317	Start value item counter	Response: <input type="text" value="A"/> <input type="text" value="B"/> <input type="text" value="Number_4"/> Write: <input type="text" value="A"/> <input type="text" value="W"/> <input type="text" value="3"/> <input type="text" value="1"/> <input type="text" value="7"/> <input type="text" value="Number_4"/> Comment: only with the application TOTALIZING
322	Sum net weight current container	Response: <input type="text" value="A"/> <input type="text" value="B"/> <input type="text" value="Weight value"/> <input type="text" value="Unit"/> Comment: only with the application FORMULATION
323	Net weight last start weight	Response: <input type="text" value="A"/> <input type="text" value="B"/> <input type="text" value="Weight value"/> <input type="text" value="Unit"/>
324 ... 338	Net weight component 1 ... 15	Response: <input type="text" value="A"/> <input type="text" value="B"/> <input type="text" value="Identification (Text_20)"/> <input type="text" value="Weight value"/> <input type="text" value="Unit"/> Comment: only with the application FORMULATION
339	Tare weight current container	Response: <input type="text" value="A"/> <input type="text" value="B"/> <input type="text" value="Weight value"/> <input type="text" value="Unit"/> Comment: only with the application FORMULATION, PHARMA FORMULATION
340	Stop value item counter	Response: <input type="text" value="A"/> <input type="text" value="B"/> <input type="text" value="Number_4"/> Write: <input type="text" value="A"/> <input type="text" value="W"/> <input type="text" value="3"/> <input type="text" value="4"/> <input type="text" value="0"/> <input type="text" value="Number_4"/> Comment: only with the application TOTALIZING
342	Gross weight last totalizing procedure	Response: <input type="text" value="A"/> <input type="text" value="B"/> <input type="text" value="Weight value"/> <input type="text" value="Unit"/>
343	Tare weight last totalizing procedure	Response: <input type="text" value="A"/> <input type="text" value="B"/> <input type="text" value="Weight value"/> <input type="text" value="Unit"/> Write: <input type="text" value="A"/> <input type="text" value="W"/> <input type="text" value="3"/> <input type="text" value="4"/> <input type="text" value="3"/> <input type="text" value="Weight value"/> <input type="text" value="Unit"/>

4.1.3 Application blocks STORED FORMULATION

No.	Content	Format
344_001 ... 344_500	Messages, write protection	<p>Response: <input type="text" value="A"/> <input type="text" value="B"/> <input type="text" value=""/> Contents (Text_24) <input type="text" value=""/> Write protection (Number_1)</p> <p>Write: <input type="text" value="A"/> <input type="text" value="W"/> <input type="text" value="3"/> <input type="text" value="4"/> <input type="text" value="4"/> <input type="text" value=""/> <input type="text" value="x"/> <input type="text" value="x"/> <input type="text" value="x"/> <input type="text" value=""/> Contents (Text_24) \$ <input type="text" value=""/> \$ <input type="text" value=""/> Write protection (Number_1)</p> <p>Note: 0: Unlock, no write protection (factory setting) 1: Lock, with write protection xxx = 001 ... 500</p>
345	Current formula	<p>Response: <input type="text" value="A"/> <input type="text" value="B"/> <input type="text" value=""/> Formula No. (No_3) <input type="text" value=""/> <input type="text" value=""/> <input type="text" value=""/> Formula ID (Text_30) <input type="text" value=""/> <input type="text" value=""/> <input type="text" value=""/> Lot No. (Text_20) <input type="text" value=""/> <input type="text" value=""/> <input type="text" value=""/> Formula name (Text_30) <input type="text" value=""/> <input type="text" value=""/> <input type="text" value=""/> Number of components (Number_3) <input type="text" value=""/> <input type="text" value=""/> <input type="text" value=""/> Target weight (weight value) <input type="text" value=""/> <input type="text" value=""/> Unit <input type="text" value=""/> <input type="text" value=""/> <input type="text" value=""/> Tolerance (weight value) <input type="text" value=""/> <input type="text" value=""/> Unit <input type="text" value=""/> <input type="text" value=""/> <input type="text" value=""/> Msg. before 1 (No_3) <input type="text" value=""/> <input type="text" value=""/> <input type="text" value=""/> Msg. before 2 (No_3) <input type="text" value=""/> <input type="text" value=""/> <input type="text" value=""/> Msg. after 1 (No_3) <input type="text" value=""/> <input type="text" value=""/> <input type="text" value=""/> Msg. after 2 (No_3) <input type="text" value=""/> <input type="text" value=""/> <input type="text" value=""/> Msg. after 3 (No_3) <input type="text" value=""/> <input type="text" value=""/> <input type="text" value=""/> Flag (Number_1) <input type="text" value=""/></p> <p>Write: <input type="text" value="A"/> <input type="text" value="W"/> <input type="text" value="3"/> <input type="text" value="4"/> <input type="text" value="5"/> <input type="text" value=""/> Formula No. (Number_3) \$ <input type="text" value=""/> \$ <input type="text" value=""/> Lot No. (Text_20) <input type="text" value=""/> <input type="text" value=""/> <input type="text" value=""/> \$ <input type="text" value=""/> \$ <input type="text" value=""/> Target weight (weight value) <input type="text" value=""/> <input type="text" value=""/> Unit \$ <input type="text" value=""/> \$ <input type="text" value=""/> Number of batches (Number_3) <input type="text" value=""/> <input type="text" value=""/> <input type="text" value=""/></p> <p>Comment: The target weight can be changed by the operator when TARGET WEIGHING ON is selected in the master mode. The target weight can only be described while the formula is available for selection. Formula No.: 001 ... 150 No. of components: 001 ... 100 Message No.: 000 ... 200 000: no message Flag: 0: Target values as stored 1: Rescaled</p>

No.	Content	Format
346	Actual values, current component	<p>Response: <input type="text"/> A <input type="text"/> B <input type="text"/> Comp. No. (No_3) <input type="text"/> <input type="text"/> Batch No. (No_3) <input type="text"/> <input type="text"/></p> <p><input type="text"/> Raw mat. ID (T_30) <input type="text"/> <input type="text"/> Raw mat. name (T_30) <input type="text"/> <input type="text"/></p> <p><input type="text"/> Target weight (weight value) <input type="text"/> <input type="text"/> Unit <input type="text"/> <input type="text"/></p> <p><input type="text"/> Tolerance 1 (weight value) <input type="text"/> <input type="text"/> Unit <input type="text"/> <input type="text"/></p> <p><input type="text"/> Tolerance 2 (weight value) <input type="text"/> <input type="text"/> Unit <input type="text"/> <input type="text"/></p> <p><input type="text"/> Msg. before (No_3) <input type="text"/> <input type="text"/> Msg. after (No_3) <input type="text"/> <input type="text"/></p> <p><input type="text"/> Flag (Number_1) <input type="text"/> <input type="text"/> Manual entry (Number_1) <input type="text"/></p> <p>Write: <input type="text"/> A <input type="text"/> W <input type="text"/> 3 <input type="text"/> 4 <input type="text"/> 6 <input type="text"/> Component No. (Number_3) <input type="text"/> <input type="text"/> \$ <input type="text"/> \$ <input type="text"/></p> <p><input type="text"/> Batch No. (Text_20) <input type="text"/></p> <p>Comment: Tolerance_2 is not determined until after rescaling. The target weight can only be described while the component is available for selection. Component No.: 001 ... 100 Message No.: 000 ... 200 000: no message Flag: 0: Target value as stored 1: Rescaled Manual entry: 0: Component weighed 1: Manual entry</p>
347	Inventory, current component	<p>Response: <input type="text"/> A <input type="text"/> B <input type="text"/> Inventory (weight value) <input type="text"/> <input type="text"/> Unit <input type="text"/> <input type="text"/></p> <p><input type="text"/> Inventory receipt (Date_Time) <input type="text"/> <input type="text"/></p> <p><input type="text"/> Consumed (weight value) <input type="text"/> <input type="text"/> Unit <input type="text"/></p>
348_001 ... 348_100	Current target values, Components 1...100, current formula	<p>Response: <input type="text"/> A <input type="text"/> B <input type="text"/> Batch No. (No_3) <input type="text"/> <input type="text"/></p> <p><input type="text"/> Raw mat. ID (T_30) <input type="text"/> <input type="text"/> Raw mat. name (T_30) <input type="text"/> <input type="text"/></p> <p><input type="text"/> Target weight (weight value) <input type="text"/> <input type="text"/> Unit <input type="text"/> <input type="text"/></p> <p><input type="text"/> Tolerance 1 (weight value) <input type="text"/> <input type="text"/> Unit <input type="text"/> <input type="text"/></p> <p><input type="text"/> Tolerance 2 (weight value) <input type="text"/> <input type="text"/> Unit <input type="text"/> <input type="text"/></p> <p><input type="text"/> Msg. before (No_3) <input type="text"/> <input type="text"/> Msg. after (No_3) <input type="text"/> <input type="text"/></p> <p><input type="text"/> Flag (Number_1) <input type="text"/></p> <p>Comment: Batch No.: 001 ... 100 Tolerance 1: Tolerance of stored formula Tolerance 2: Tolerance of stored formula Message No.: 001 ... 200</p>
349	Tare current container	<p>Response: <input type="text"/> A <input type="text"/> B <input type="text"/> Tare (weight value) <input type="text"/> <input type="text"/> Unit <input type="text"/></p>
350	Batch	<p>Response: <input type="text"/> A <input type="text"/> B <input type="text"/> Number of batches (Number_3) <input type="text"/> <input type="text"/></p> <p><input type="text"/> Current batch (Number_3) <input type="text"/> <input type="text"/></p> <p><input type="text"/> Component name (Text_30) <input type="text"/></p>
351	Last batch weight	<p>Response: <input type="text"/> A <input type="text"/> B <input type="text"/> Batch (weight value) <input type="text"/> <input type="text"/> Unit <input type="text"/></p>
352_001 ... 352_100	Batch details	<p>Response: <input type="text"/> A <input type="text"/> B <input type="text"/> Batch ID (Text_20) <input type="text"/> <input type="text"/></p> <p><input type="text"/> Net (weight value) <input type="text"/> <input type="text"/> Unit <input type="text"/> <input type="text"/></p> <p><input type="text"/> Gross weight (weight value) <input type="text"/> <input type="text"/> Unit <input type="text"/> <input type="text"/></p> <p><input type="text"/> Tare (weight value) <input type="text"/> <input type="text"/> Unit <input type="text"/></p>

No.	Content	Format
353	Total weight of current formula	Response: <input type="text" value="A"/> <input type="text" value="B"/> <input type="text" value=""/> Formula net weight (weight value) <input type="text" value=""/> <input type="text" value=""/> Unit <input type="text" value=""/> <input type="text" value=""/> Formula gross weight (weight value) <input type="text" value=""/> <input type="text" value=""/> Unit <input type="text" value=""/> <input type="text" value=""/> Deviation (weight value) <input type="text" value=""/> <input type="text" value=""/> Unit <input type="text" value=""/>
355_001 ... 355_100	Partial weights of component	Response: <input type="text" value="A"/> <input type="text" value="B"/> <input type="text" value=""/> Batch 1 (Text_20) <input type="text" value=""/> <input type="text" value=""/> Partial weight 1 (weight value) <input type="text" value=""/> <input type="text" value=""/> Unit <input type="text" value=""/> <input type="text" value=""/> Batch 2 (Text_20) <input type="text" value=""/> <input type="text" value=""/> Partial weight 2 (weight value) <input type="text" value=""/> <input type="text" value=""/> Unit <input type="text" value=""/> <input type="text" value=""/> ... Batch 6 (Text_20) <input type="text" value=""/> <input type="text" value=""/> Partial weight 6 (weight value) <input type="text" value=""/> <input type="text" value=""/> Unit <input type="text" value=""/> <input type="text" value=""/> Comment: only possible in the operating modes VERTICAL FILLING or BATCH FILLING with the setting BATCH NO. ONE, MULTIPLE
361_001 ... 361_200	Messages	Response: <input type="text" value="A"/> <input type="text" value="B"/> <input type="text" value=""/> Message (Text_24) <input type="text" value=""/> Write: <input type="text" value="A"/> <input type="text" value="W"/> <input type="text" value="3"/> <input type="text" value="6"/> <input type="text" value="1"/> <input type="text" value=""/> <input type="text" value="n"/> <input type="text" value="n"/> <input type="text" value="n"/> <input type="text" value=""/> Message (Text_24) <input type="text" value=""/> Comment: nnn = 001 ... 200
362_001 ... 362_500	Raw materials	Response: <input type="text" value="A"/> <input type="text" value="B"/> <input type="text" value=""/> Raw material ID (Text_20) <input type="text" value=""/> <input type="text" value=""/> Raw material name (Text_30) <input type="text" value=""/> <input type="text" value=""/> Inventory (weight value) <input type="text" value=""/> <input type="text" value=""/> Unit <input type="text" value=""/> <input type="text" value=""/> Message (No_3) <input type="text" value=""/> <input type="text" value=""/> Warning (No_1) <input type="text" value=""/> <input type="text" value=""/> Inventory receipt (Date_Time) <input type="text" value=""/> <input type="text" value=""/> Consumed (weight value) <input type="text" value=""/> <input type="text" value=""/> Unit <input type="text" value=""/> <input type="text" value=""/> Number of dispensing (No_4) <input type="text" value=""/> Write: <input type="text" value="A"/> <input type="text" value="W"/> <input type="text" value="3"/> <input type="text" value="6"/> <input type="text" value="2"/> <input type="text" value=""/> <input type="text" value="n"/> <input type="text" value="n"/> <input type="text" value="n"/> <input type="text" value=""/> Raw material ID (Text_20) <input type="text" value=""/> <input type="text" value="\$"/> <input type="text" value="\$"/> Raw material name (Text_30) <input type="text" value=""/> <input type="text" value="\$"/> <input type="text" value="\$"/> Inventory (weight value) <input type="text" value=""/> <input type="text" value=""/> Unit <input type="text" value=""/> <input type="text" value="\$"/> <input type="text" value="\$"/> Message (No_3) <input type="text" value=""/> <input type="text" value="\$"/> <input type="text" value="\$"/> Warning (No_1) <input type="text" value=""/> Comment: nnn = 001 ... 500 Warning 0: no inventory management Warning 1: Warning if negative inventory Warning 2: Warning if the inventory for the selected component is not reached Warning 3: Warning if < 10 % of original inventory
363_001 ... 363_150	Formula mode	Response: <input type="text" value="A"/> <input type="text" value="B"/> Write: <input type="text" value="A"/> <input type="text" value="W"/> <input type="text" value="3"/> <input type="text" value="6"/> <input type="text" value="3"/> <input type="text" value=""/> <input type="text" value="n"/> <input type="text" value="n"/> <input type="text" value="n"/> <input type="text" value=""/> Mode (Number_1) <input type="text" value=""/> Comment: nnn = 001 ... 100 Mode = 1: read Mode = 2: write Mode = 3: complete

No.	Content	Format
364	Formula header	<p>Response: <input type="text" value="A B _"/> Formula ID (Text_10) <input type="text" value=" _ _"/> <input type="text" value=""/> Formula name (Text_30) <input type="text" value=" _ _"/> <input type="text" value=""/> Target weight (weight value) <input type="text" value=" _"/> Unit <input type="text" value=" _ _"/> <input type="text" value=""/> Tolerance (weight value) <input type="text" value=" _"/> Unit <input type="text" value=" _ _"/> <input type="text" value=""/> Number of components (Number_3) <input type="text" value=" _ _"/> <input type="text" value=""/> Msg. before 1 (No_3) <input type="text" value=" _ _"/> Msg. before 2 (No_3) <input type="text" value=" _ _"/> <input type="text" value=""/> Msg. after 1 (No_3) <input type="text" value=" _ _"/> Msg. after 2 (No_3) <input type="text" value=" _ _"/> <input type="text" value=""/> Msg. after 3 (No_3) <input type="text" value=" _ _"/> <input type="text" value=""/> Formula weight (weight value) <input type="text" value=" _"/> Unit <input type="text" value=" _ _"/> <input type="text" value=""/> Clear sum (Date_Time) <input type="text" value=" _"/> Unit <input type="text" value=" _ _"/> <input type="text" value=""/> Status (Number_1)</p> <p>Write: <input type="text" value="A W 3 6 4 _"/> Formula ID (Text_10) <input type="text" value=" \$, \$"/> <input type="text" value=""/> Formula name (Text_30) <input type="text" value=" \$, \$"/> <input type="text" value=""/> Message before 1 (No_3) <input type="text" value=" \$, \$"/> <input type="text" value=""/> Message before 2 (No_3) <input type="text" value=" \$, \$"/> <input type="text" value=""/> Message after 1 (No_3) <input type="text" value=" \$, \$"/> <input type="text" value=""/> Message after 2 (No_3) <input type="text" value=" \$, \$"/> <input type="text" value=""/> Message after 3 (No_3) <input type="text" value=""/></p> <p>Comment: Writing is only possible when a formula is loaded via AB 363 in the Edit mode</p>
365_001 ... 365_100	Components of current formula	<p>Response: <input type="text" value="A B _"/> Raw mat. ID (T_20) <input type="text" value=" _ _"/> Raw mat.l name (T_30) <input type="text" value=" _ _"/> <input type="text" value=""/> Target weight (weight value) <input type="text" value=" _"/> Unit <input type="text" value=" _ _"/> <input type="text" value=""/> Tolerance (weight value) <input type="text" value=" _"/> Unit <input type="text" value=" _ _"/> <input type="text" value=""/> Message before (No_3) <input type="text" value=" _ _"/> Message after (No_3) <input type="text" value=" "/></p> <p>Write: <input type="text" value="A W 3 6 5 _ n n n"/> Raw material ID (T_30) <input type="text" value=" \$, \$"/> <input type="text" value=""/> Target weight (weight value) <input type="text" value=" _"/> Unit <input type="text" value=" \$, \$"/> <input type="text" value=""/> Tolerance (weight value) <input type="text" value=" _"/> Unit <input type="text" value=" \$, \$"/> <input type="text" value=""/> Msg. before (No_3) <input type="text" value=" \$, \$"/> Msg. after (No_3) <input type="text" value=""/></p> <p>Comment: nnn = 001 ... 100 Messages: 000 ... 200 000 = no message Writing only possible if a formula is loaded via AB 363 in the Edit mode and not until the header is written via AB 364</p>
366	Formula status	<p>Response: <input type="text" value="A B _"/> Formula No. (No_3) <input type="text" value=" _ _"/> Mode (No_1)</p> <p>Comment: Mode = 1: read Mode = 2: write</p>
398	Report No.	<p>Response: <input type="text" value="A B _"/> Serial number (Number_6)</p>

5 What to do if ...?

Error / Display	Possible causes	Remedy
OVERFLOW SUM GROSS OVERFLOW SUM NET	<ul style="list-style-type: none"> Capacity of buffer for gross sum or for net sum exceeded 	→ Delete sum and form sub-sum
OVERFLOW CONTAINER	<ul style="list-style-type: none"> Capacity of buffer for container counter exceeded 	→ Reset counter by deleting sum → Suitably divide sum or recipe
OVERFLOW ITEMCOUNTER	<ul style="list-style-type: none"> Item counter or component counter has reached stop value 	→ Reset counter by deleting sum → Select suitable start and stop value
OVERFLOW MAN. INPUT	<ul style="list-style-type: none"> Manual entry would exceed capacity of sum buffer 	→ Check value of manual entry → Check value of FACTOR FOR NEUTRAL UNIT
WEIGHT TOO LOW	<ul style="list-style-type: none"> Totalizing or formulation with weight which is too low 	→ Place item on platform or fill component; watch 10 d weight threshold.
NEGATIVE COMPONENT	<ul style="list-style-type: none"> Current component negative 	→ Place component removed last on scale again until second display is positive
NO VALUE	<ul style="list-style-type: none"> Manual entry: No value or zero entered 	→ Enter permissible value
CONT. NOT FINISHED	<ul style="list-style-type: none"> Sum key pressed without having formed container sum for all scales used beforehand 	→ Form all container sums
CLEAR SUM	<ul style="list-style-type: none"> Sum not cleared 	→ Clear sum

6 Technical data

Formulation functions	
FORMULATION, PHARMA FORMULATION, TOTALIZING applications	
Sum memory	Up to 8 places including decimal point
Manual entry memory	Up to 6 places including decimal point
Item counter	Up to 9,999 with freely selectable start and stop value, only for TOTALIZING application
Component counter	Up to 9,999, only for FORMULATION and PHARMA FORMULATION applications
Container counter	Up to 9,999, only for FORMULATION and PHARMA FORMULATION applications
STORED FORMULATION application	
Formula database	max. 150 formulas with a maximum of 100 components, max. 2000 components over all formulas
Raw material database	max. 500 raw materials
Message database	max. 200 messages, which can be assigned to raw materials, components and formulas. Thereof 20 action messages and 10 fixed messages, which cannot be changed
Batch operation	max. 100 batches
Partially filling	A component can be dispensed in up to 6 steps. A maximum of 200 steps are possible per formula
Target weighing	The stored formula target value can be adjusted before the start of formulation
Rescaling	If a component has been dispensed over tolerance, the remaining components can be recalculated for the higher formula weight

7 Appendix

7.1 ID7-Form-XP with Interface 4 I/O-ID7 or Relay Box 8-ID7

The following input assignments apply when using the ID7-Form-XP together with an Interface 4 I/O-ID7 or a Relay Box 8-ID7:

Input signals

Input	Key	Function in the application STORED FORMULATION
Input 1	Key F3	SELECT for selection of formula or component PLUS for formulation
Input 2	Key F6	STOP
Input 3	Tare weighing platform	
Input 4	ENTER key	

7.2 FormTool-XP

7.2.1 System requirements

- PC with one of the operating systems Windows 98, Windows 2000 or Windows XP
- ID7-Form-XP with a PC connected via a serial interface or Ethernet

7.2.2 Installing and initialising FormTool-XP

Installing

1. Insert CD and run "formtool.exe".
2. Follow the instructions that appear on the screen in the further course of the installation.
3. Reboot the PC after completing the installation.

Initialising

1. Switch on ID7-Form-XP.
2. Start FormTool-XP ("Start -> Programs -> Mettler-Toledo -> FormTool-XP").
3. Select the interface in the "Interface Settings" window and configure the interface parameters in accordance with the settings on the ID7-Form-XP.

Then the FormTool-XP is ready for operation, the display of the ID7-Form-XP is shown on the PC.

7.2.3 Operation with FormTool-XP

FormTool-XP is operated analogously to operation on the weighing terminal ID7-Form-XP. In addition, FormTool-XP also offers extensive reporting functions for evaluating the formulas.

Additional information on FormTool-XP is contained in the online help.

Several examples of the operating interface are shown on the following pages.

Formulation During formulation weighing and formula data are shown in real time.

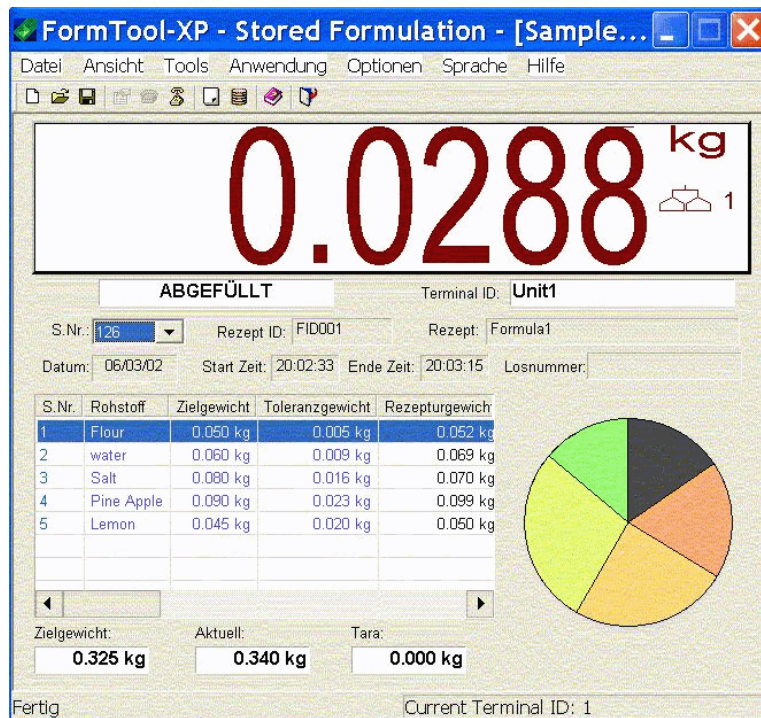

Editing raw materials Raw materials can be easily be created or edited.

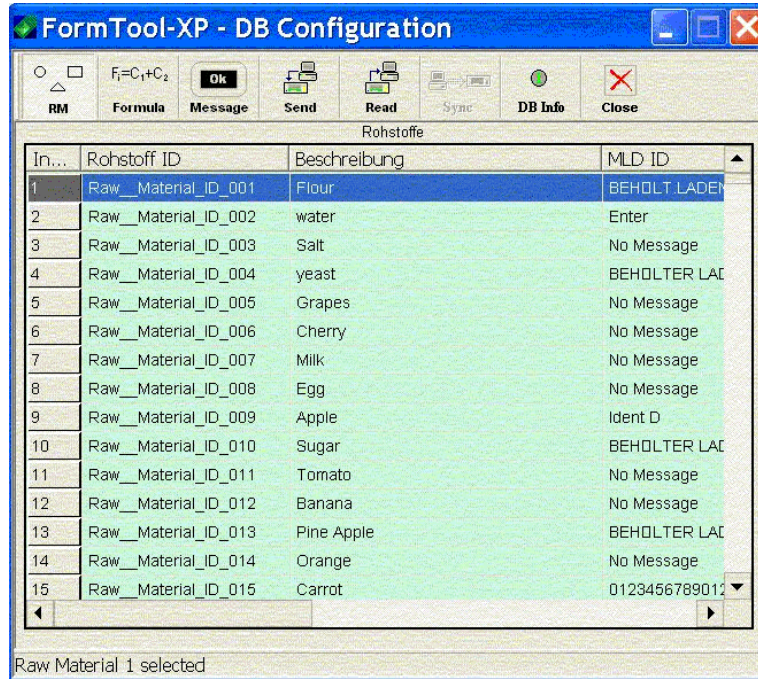

Editing formulas Formulas can be easily be created or edited.

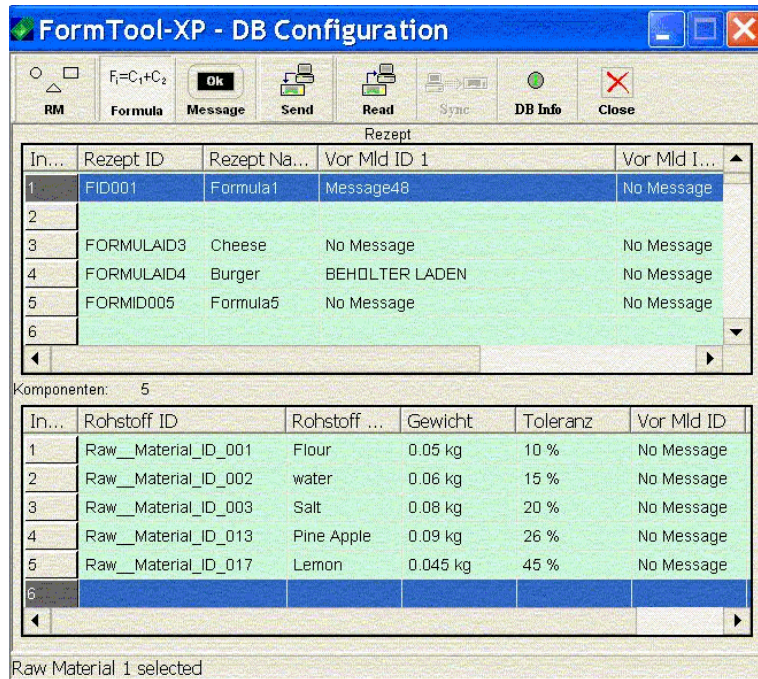

Reporting Extensive reporting functions are available for evaluating the formulas.

FormTool XP ReportWizard - 1/2

Analysis.

Stored formulation

Trend Analysis.

Error Analysis.

Consumption Analysis.

Production Analysis.

Formulation

Pharma formulation

Totalizing

Based On.

Formula Raw material

Terminal ID: Unassigned

Show consolidated values

Report Description

Analysis of production of formula(e). It could be total or date wise production.

Chart / Report

Histogram

Plot Graph

Pie Chart

Text Report

TECHNIK

Sampler

< Zurück Weiter > Abbrechen

8 Index

A

Action messages 29
Adding components 32
Application 15, 17, 20, 23

B

Batch mode 10, 23, 41
Batch number 13, 24

C

Clear sum 24
Clear total 12
Compounding 19

D

DeltaTrac 18, 24
Documentation 2

E

Editing formulas 31
Editing messages 29
Editing raw materials 23, 27
Error messages 40

F

Filling 18, 25
Fixed messages 29
Formula database 41
Formulation functions 5, 41
Free messages 29
Function keys 5, 15, 17, 20

I

Installation 2
Inventory level 28
Inventory management 14
Item counter 25
Iteration 10

L

Lot number 13, 24

M

Manual entry 24
Message database 41
Messages 6, 23, 29

O

Operating mode 23
Order of components 9, 25

P

Parking formulas 13
Printing after formulation 25

Printing before
formulation 24

R

Raw materials database 41
Rescaling 11, 24, 41
Reset Pac 26

S

Safety precautions 2
Select barcode 9, 24
Separate container 8
Stored formulation 5, 23, 41
Subtractive weighing 26

T

Target weighing 7, 8, 10,
23, 41
Technical data 41

U

Unit manual entry 25

V

Vertical filling 7, 23

W

What to do if ...? 40



22005901A

Subject to technical changes © Mettler-Toledo (Albstadt) GmbH 04/10 Printed in Germany 22005901A

Mettler-Toledo (Albstadt) GmbH

D-72458 Albstadt

Tel. ++49-7431-14 0, Fax ++49-7431-14 232

Internet: <http://www.mt.com>