

METTLER TOLEDO

DNB00001000 User Manual



Preface

The data and illustrations found in this document are not binding. METTLER TOLEDO reserves the right to modify our products in line with our policy of continuous product development. The information in this document is subject to change without notice and should not be considered as a commitment by METTLER TOLEDO. METTLER TOLEDO assumes no responsibility for any errors that may appear in this document.

METTLER TOLEDO® is a registered trademark of Mettler-Toledo, Inc. CIRCUIT BD® is a registered trademark of HMS Industrial Networks AB. All other trademarks are the property of their respective holders.

Copyright 2006 Mettler-Toledo, Inc. This documentation contains proprietary information of Mettler-Toledo, Inc. It may not be copied in whole or in part without the express written consent of Mettler-Toledo, Inc.

METTLER TOLEDO reserves the right to make refinements or changes to the product or manual without notice.

CUSTOMER FEEDBACK

Your feedback is important to us! If you have a problem with this product, or just a suggestion on how we can serve you better, please fill out this form and send it to us. If you are in the United States, you can mail this postpaid form to the address on the reverse, or fax it to (614) 438-4355. If you are outside the United States, please apply the appropriate amount of postage before mailing. You can also send your feedback via email to: quality_feedback.mtwt@mt.com.

Your Name:	Date:
Organization Name:	METTLER TOLEDO Order Number
Address:	Part / Product Name:
	Part / Model Number:
	Serial Number:
Phone Number: () Fax Number: ()	Company Name for Installation:
E-mail Address:	Contact Name:
	Phone Number:

How well did this product meet your expectations in its intended use? <input type="checkbox"/> Met and exceeded my needs <input type="checkbox"/> Met all needs <input type="checkbox"/> Met most needs <input type="checkbox"/> Met some needs <input type="checkbox"/> Did not meet my needs	Comments:
---	-------------------------------

PROBLEM:		
UNACCEPTABLE DELIVERY:	OUT OF BOX ERROR:	
<input type="checkbox"/> Shipped late	<input type="checkbox"/> Wrong item	<input type="checkbox"/> Wrong documentation
<input type="checkbox"/> Shipped early	<input type="checkbox"/> Wrong part	<input type="checkbox"/> Missing documentation
<input type="checkbox"/> Shipped to incorrect location	<input type="checkbox"/> Missing equipment	<input type="checkbox"/> Incorrectly calibrated
<input type="checkbox"/> Other (Please Specify)	<input type="checkbox"/> Equipment failure	<input type="checkbox"/> Other (Please specify)
Comments/Questions:		

<i>DO NOT WRITE IN SPACE BELOW; FOR METTLER TOLEDO USE ONLY</i>			
<input type="checkbox"/> Retail	<input type="checkbox"/> Light Industrial	<input type="checkbox"/> Heavy Industrial	<input type="checkbox"/> Systems
RESPONSE: Include Root Cause Analysis and Corrective Action Taken.			

FOLD THIS FLAP FIRST



NO POSTAGE
NECESSARY IF
MAILED IN THE
UNITED STATES

BUSINESS REPLY MAIL
FIRST CLASS PERMIT NO. 414 COLUMBUS, OH

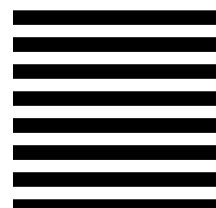

POSTAGE WILL BE PAID BY ADDRESSEE

Mettler-Toledo, Inc.
Quality Manager - MTWI
P.O. Box 1705
Columbus, Ohio 43240
USA



Please seal with tape.

SAFETY NOTICE

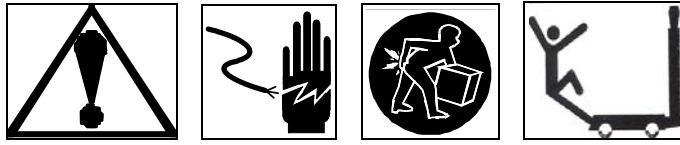

Product safety is a fundamental concern at METTLER TOLEDO. Use common sense and follow the simple precautions listed below to ensure your safety and optimize the use and performance of this product.

- Read this manual before operating or servicing this product. Save this manual for future reference.
- Observe safety warnings located throughout this manual.
- Use caution when lifting or moving heavy equipment.
- Never immerse electronic products in liquids.
- This product should be serviced by qualified personnel. Exercise care when moving, testing, or adjusting this product.
- Disconnect all power to this product before installing, servicing, or cleaning.
- Use only METTLER TOLEDO parts for repair.
- Observe electrostatic handling precautions for electronic components. Allow at least 30 seconds after power disconnection to allow charges to dissipate before servicing any electronic components.
- Allow the product to stabilize at ambient room temperature before applying power.

FAILURE TO FOLLOW THESE PRECAUTIONS COULD RESULT IN DAMAGE TO EQUIPMENT AND/OR BODILY HARM.

Features	Benefits
DeviceNet Node Profile	Slave device
DeviceNet Cabling	Terminal block configuration supports twisted pair trunkline-dropline configuration with signal and 24 VDC power in same cable
DeviceNet Addressing	Supports MAC addresses 0-63
DeviceNet Baud Rate	Selectable baud rates of 125k, 250k, and 500k maximum
DeviceNet Services	Supports polled messaging with four defined assemblies
DeviceNet Data	Provides a single precision floating point number (displayed weight, displayed tare, recorded weight, recorded tare) and scale status bits (motion, gross/net, over capacity, below zero, communication error)
DeviceNet EDS File	Full EDS file support for METTLER TOLEDO profile
Serial Protocol	Supports terminals configured with the "METTLER TOLEDO Continuous" protocol with optional "CTPZ" (including JAGXTREME, JAGUAR, LYNX, PANTHER, PANTHER PLUS, PUMA, and COUGAR terminals and the SPEEDWEIGH/SPEEDWEIGH PLUS and TRIMWEIGH II scales)
Serial Interface	Supports RS232 only
Serial Baud Rate	Supports autobaud ranging from 1200 to 19.2K baud
Serial Cable	1 meter cable included
Flexibility	Compatible with older METTLER TOLEDO scale terminals (such as 8510, 8530, 8146, 8142, and 8140) Small and compact Quick disconnects and easy setup for field replacement in minutes



Produced in a facility that is



CONTENTS

- 1. TERMINOLOGY / DEFINITIONS1**
- 2. INTRODUCTION2**
- 3. SYSTEM OVERVIEW3**
 - 3.1 DEVICE NET CHARACTERISTICS3
 - 3.2 RS-232 INTERFACE3
- 4. INSTALLATION4**
 - 4.1 DEVICE NET4
 - 4.1.1 *Termination*5
 - 4.1.2 *Environment and Specifications*5
 - 4.1.3 *Mounting*6
 - 4.2 RS-232 INTERFACE7
 - 4.2.1 *Wiring Instructions*7
 - 4.2.2 *Serial Data Format and Baud Rate Settings*7
 - 4.3 POWER SUPPLY8
- 5. CONFIGURATION WITH RSNETWORK FOR DEVICENET9**
 - 5.1 REGISTRATION OF EDS FILE9
 - 5.2 SETTING UP AN I/O CONNECTION20
- 6. DATA FORMAT35**
 - 6.1 CONTINUOUS MODE OUTPUT35
 - 6.2 OUTPUT ASSEMBLY36
 - 6.3 INPUT ASSEMBLY37
 - 6.4 INTERNAL ADAPTER REGISTERS38
- 7. OPERATION39**
 - 7.1 INITIAL CONDITIONS39
 - 7.2 AUTOBAUD MODE40
 - 7.3 NORMAL MODE41
 - 7.3.1 *DPRAM IN Area*41
 - 7.3.2 *DPRAM OUT Area*41
- 8. INDICATION LED'S42**

1. Terminology / Definitions

Term	Definition
MSB	Most Significant Byte
LSB	Least Significant Byte
MSD	Most Significant Digit
LSD	Least Significant Digit
NAN	IEEE Not a Number, defined as 0xFF, 0xFF, 0xFF, 0xFF
DPRAM	Dual Port Random Access Memory
RAM	Random Access Memory
ROM	Read Only Memory
LED	Light Emitting Diode
byte	8-bit value
word	16-bit value
dword	32-bit value
big endian format	The most significant byte is stored in the lowest memory address.
little endian format	The most significant byte is stored in the highest memory address. Bytes at lower addresses have lower significance.
EDS	Electronic Data Sheet

2. Introduction

The METTLER TOLEDO DNB00001000 (DeviceNet bridge) allows sharing of weight measurements from a METTLER TOLEDO scale terminal via the continuous mode output to a DeviceNet network.

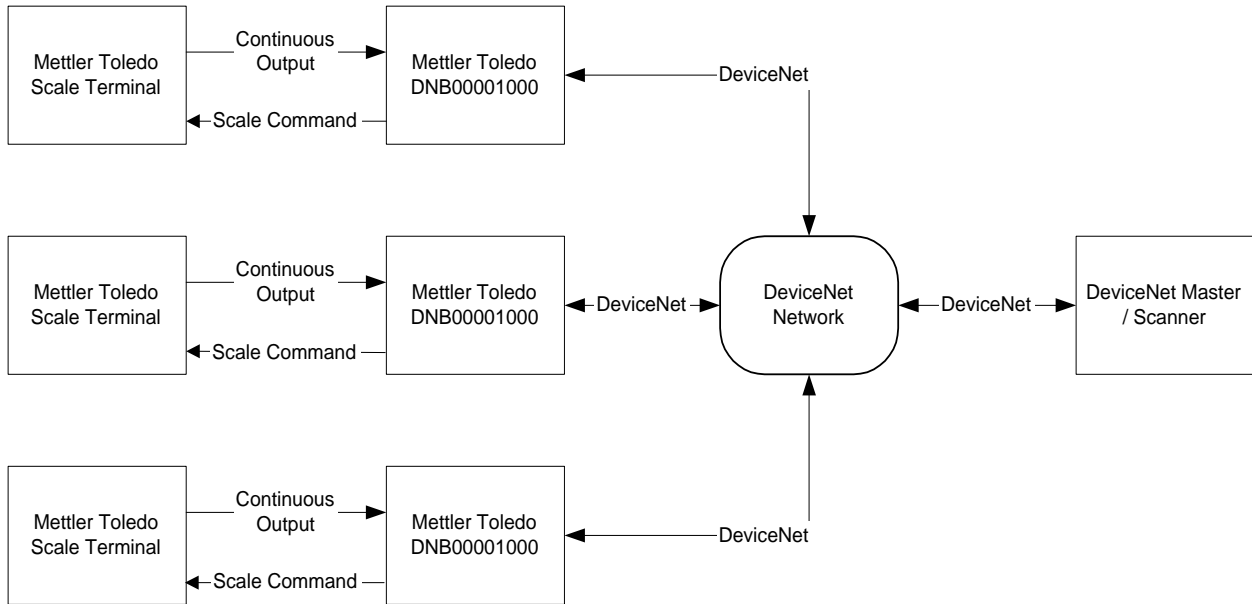

Figure 1 DeviceNet Network with METTLER TOLEDO DNB00001000 DeviceNet Bridges

3. System Overview

3.1 *DeviceNet Characteristics*

- DeviceNet specific cable (twisted pair)
- Access to intelligence present in low-level devices – Master/Slave and Peer-to-Peer capabilities
- Trunkline-dropline configuration
- Support for up to 64 nodes
- Node removal without severing the network
- Simultaneous support for both network-powered (sensors) and self-powered (actuators) devices
- Use of sealed or open-style connectors
- Protection from wiring errors
- Selectable baud rates of 125k baud, 250k baud, and 500k baud. Maximum trunk distance 500 meters and drop length of 156 meters at 125k baud
- Adjustable power configuration to meet individual application needs
- High current capability (up to 8 amps per supply)
- Operation with off-the-shelf power supplies
- Power taps that allow the connection of several power supplies from multiple vendors that comply with DeviceNet standards
- Built-in overload protection
- Power available along the bus: both signal and power lines contained in the trunkline
- Provisions for the typical request/response oriented network communications
- Provisions for the efficient movement of I/O data
- Fragmentation (anything in excess of 8 bytes) for moving larger bodies of information
- Duplicate MAC ID detection

3.2 *RS-232 Interface*

- 2- or 3-wire physical connection (50 ft maximum) terminating to a DB-9 connector
- Supports "METTLER TOLEDO Continuous" protocol (with STX, checksum)
- Supports "CTPZ" command input to scale terminal
- Automatic detection of serial data format and baud rate

4. Installation

4.1 DeviceNet

The DeviceNet connection consists of a device connector (male contacts) connected to a network connector (female contacts) according to Table 1. Baud rates of 125k, 250k or 500k can be selected by setting DIP switches 1 and 2 according to Table 2. The MAC ID address range of 0 to 63 is selected by setting DIP switches 3 through 8 according to Table 3.

Screw Terminal	Description	Color
1	V-	Black
2	CAN_L	Blue
3	Drain	Shield
4	CAN_H	White
5	V+	Red

Table 1 Network Connector (Female Contacts)

Dip Switch Access

The DIP switches are located under the access plate as shown in Figure 4.1. Gently pry open from top with small flat screwdriver.

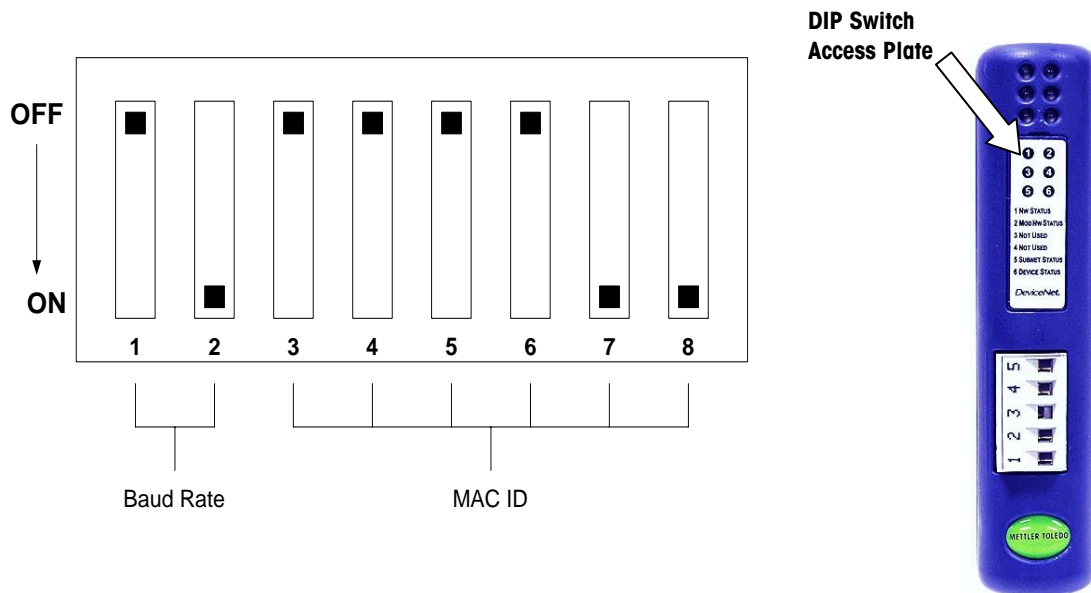

Figure 4.1

Figure 2 DeviceNet Configuration DIP Switch

DIP Switch 1	DIP Switch 2	Baud Rate Selection
OFF	OFF	125k
OFF	ON	250k
ON	OFF	500k
ON	ON	Reserved

Table 2 Baud Rate Selection

DIP Switch 3	DIP Switch 4	DIP Switch 5	DIP Switch 6	DIP Switch 7	DIP Switch 8	MAC ID
OFF	OFF	OFF	OFF	OFF	OFF	0
OFF	OFF	OFF	OFF	OFF	ON	1
OFF	OFF	OFF	OFF	ON	OFF	2
OFF	OFF	OFF	OFF	ON	ON	3
...
ON	ON	ON	ON	ON	OFF	62
ON	ON	ON	ON	ON	ON	63

Table 3 MAC ID Selection

4.1.1 Termination

Termination of the fieldbus requires a terminating resistor at each end of the fieldbus. The resistors should have a value of 121 Ω .

4.1.2 Environment and Specifications

Specifications	DNB00001000
Physical Dimensions	27 x 120 x 76 mm
Operating Temperature	0° to 55° C (32°F to 131°F)
Power	24 VDC @ 150mA
Environment Protection	NEMA 1 / IP20
Mounting	DIN Rail
Approvals	UL/cUL, CSA, CE
Certified	ODVA certified

Minimum Mounting Distances

4.1.3 Mounting

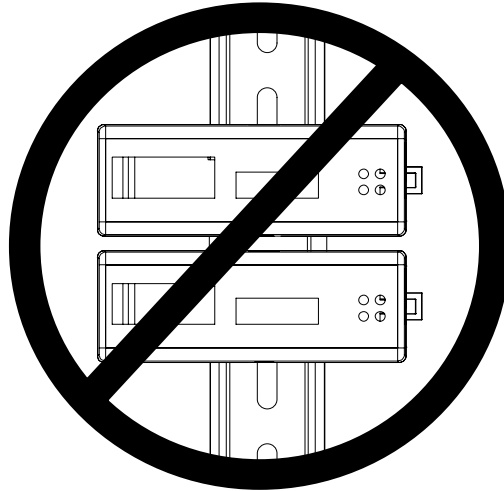

Horizontal mounting on a vertical DIN rail is not recommended due to heat dissipation requirements. Horizontal mounting does not allow proper ventilation and will void warranty. If only one DNB is used, then horizontal mounting is acceptable provided the DNB is not located directly above other equipment.

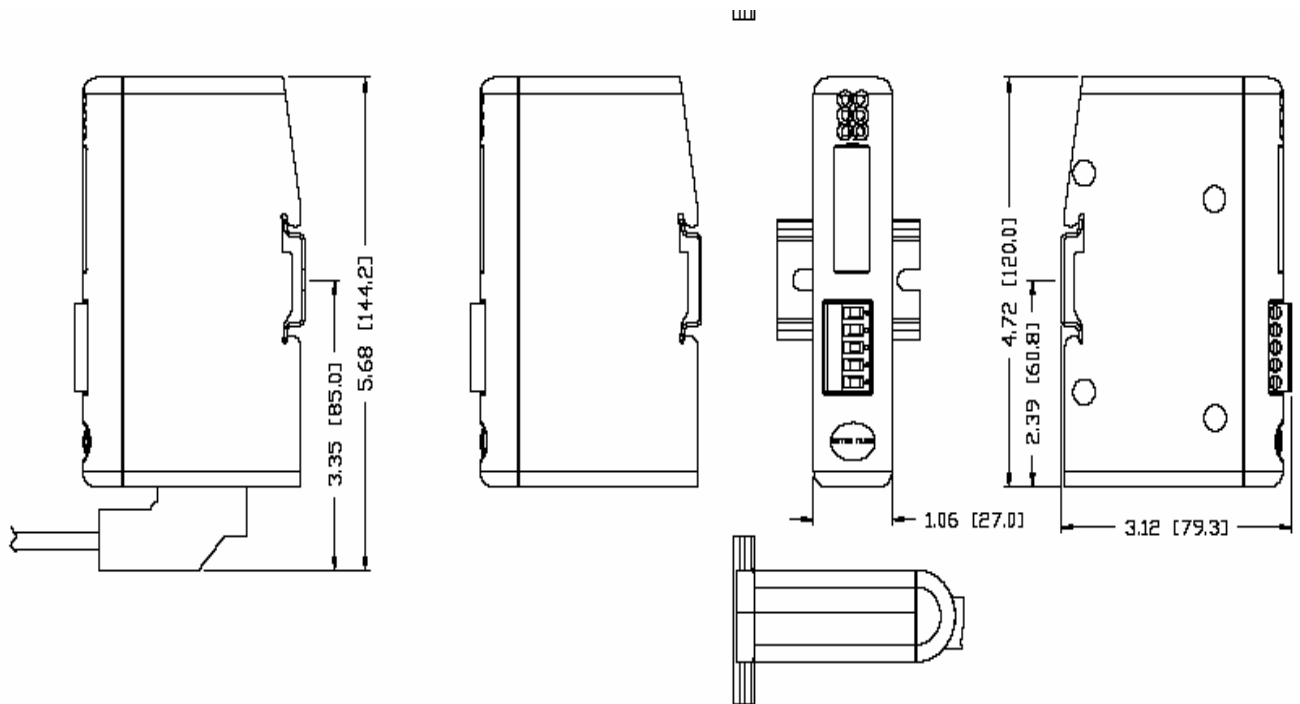

Note: Leave at least 3mm of spacing between when mounting multiple DNB's. Failure to do so will void warranty.

4.2 RS-232 Interface

4.2.1 Wiring Instructions

The RS-232 connection consists of a DB9 connector from the METTLER TOLEDO DNB00001000 to the terminals of a scale terminal according to Table 4. See figure 4.3.1 for pin orientation.

DB9 Pinout to METTLER TOLEDO DNB00001000	Name	Description	METTLER TOLEDO Terminal RS-232 Interface Connection
2 (orange)	RXD	RS-232 Receive	TXD
3 (red)	TXD	RS-232 Transmit	RXD
5 (black)	SGND	Signal Ground	Signal Ground

Table 4 RS-232 Connection

4.2.2 Serial Data Format and Baud Rate Settings

The scale terminal serial output should be configured for METTLER TOLEDO Continuous Protocol (Standard) with **STX and Checksum enabled**. Table 5 lists the possible serial data format and baud rate settings for the METTLER TOLEDO DNB00001000 to successfully autobaud with a scale terminal.

Serial Data Format			Baud Rate					
Stop Bit Length	Parity	Data Length	1200	2400	4800	9600	19.2 k	38.4 k
1	None	7 bits	•	•	•	•	•	•
1	Odd	7 bits	•	•	•	•	•	•
1	Even	7 bits	•	•	•	•	•	•
1	None	8 bits	•	•	•	•	•	•
1	Odd	8 bits	•	•	•	•	•	•
1	Even	8 bits	•	•	•	•	•	•

Table 5 - Possible Serial Data Format and Baudrate Settings

4.3 Power Supply

The METTLER TOLEDO DNB00001000 requires a 24 VDC power source (not included with the unit).

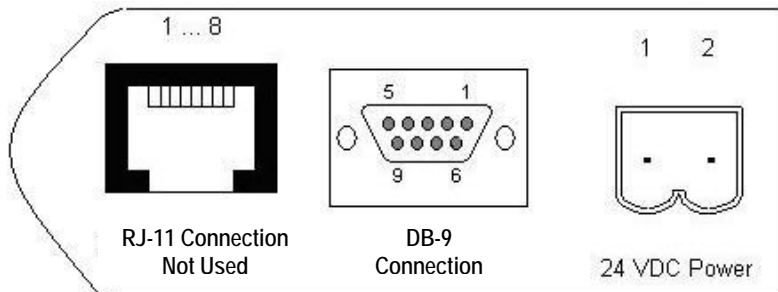

Figure 4.3.1

Figure 3 Power Supply and DB-9 Connection

Pin	Description	Note
1	+24 VDC Power Supply	+ 24 VDC (+/- 20%); max 150 mA @ 24 VDC
2	0 VDC Ground	Power supply ground

Table 6 - Power Supply Wiring

5. Configuration with RSNetWorx for DeviceNet

The EDS file located on the CD-ROM supplied with the DNB00001000 contains configuration information to allow RSNetWorx for DeviceNet to set up a single polled I/O connection between a METTLER TOLEDO DNB00001000 and DeviceNet master/scanner.

5.1 Registration of EDS File

The EDS file must first be registered into RSNetWorx for DeviceNet. This is accomplished using the EDS Wizard.

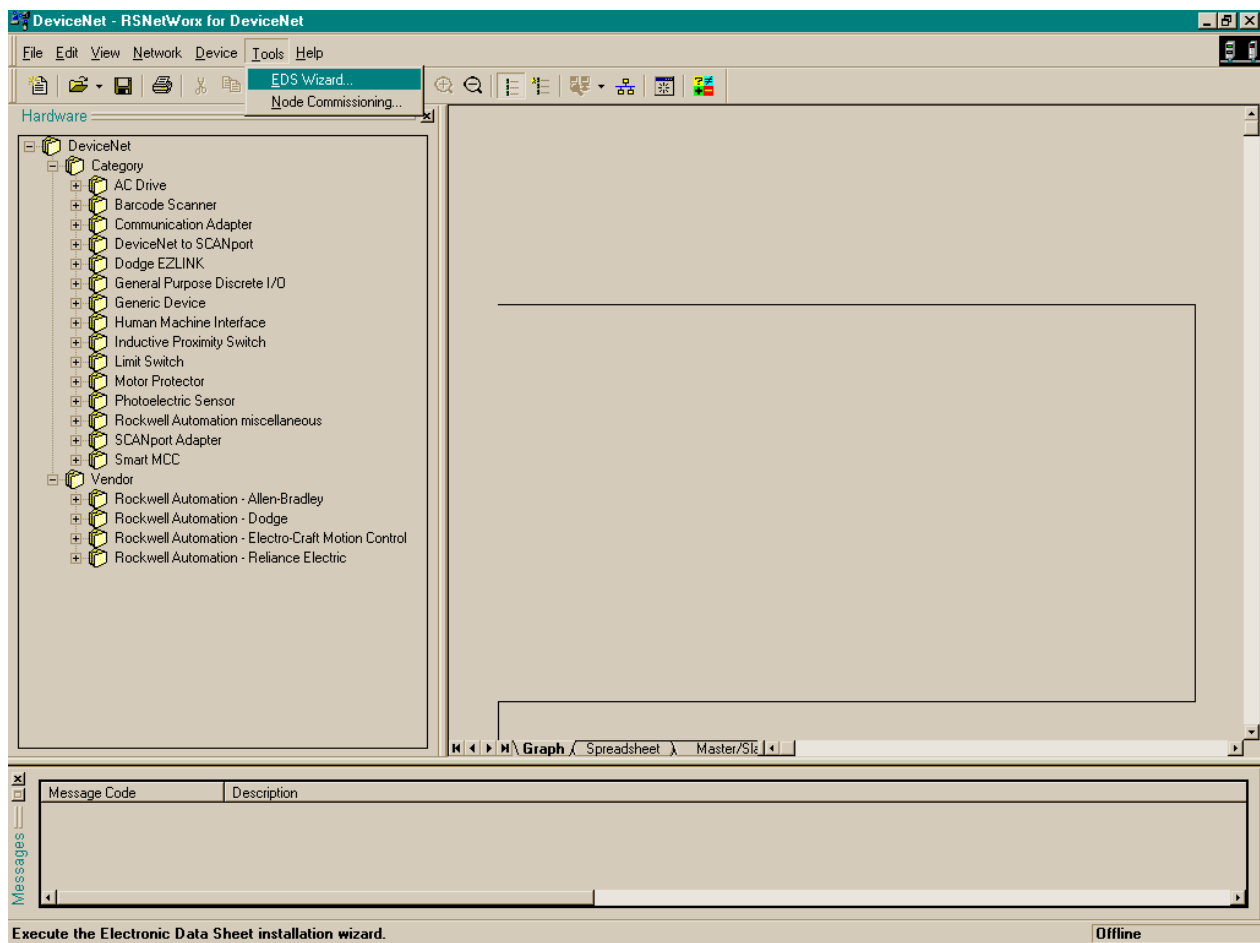

Figure 4 Starting the EDS Wizard

To start the EDS Wizard, select "EDS Wizard..." under the menu option "Tools".

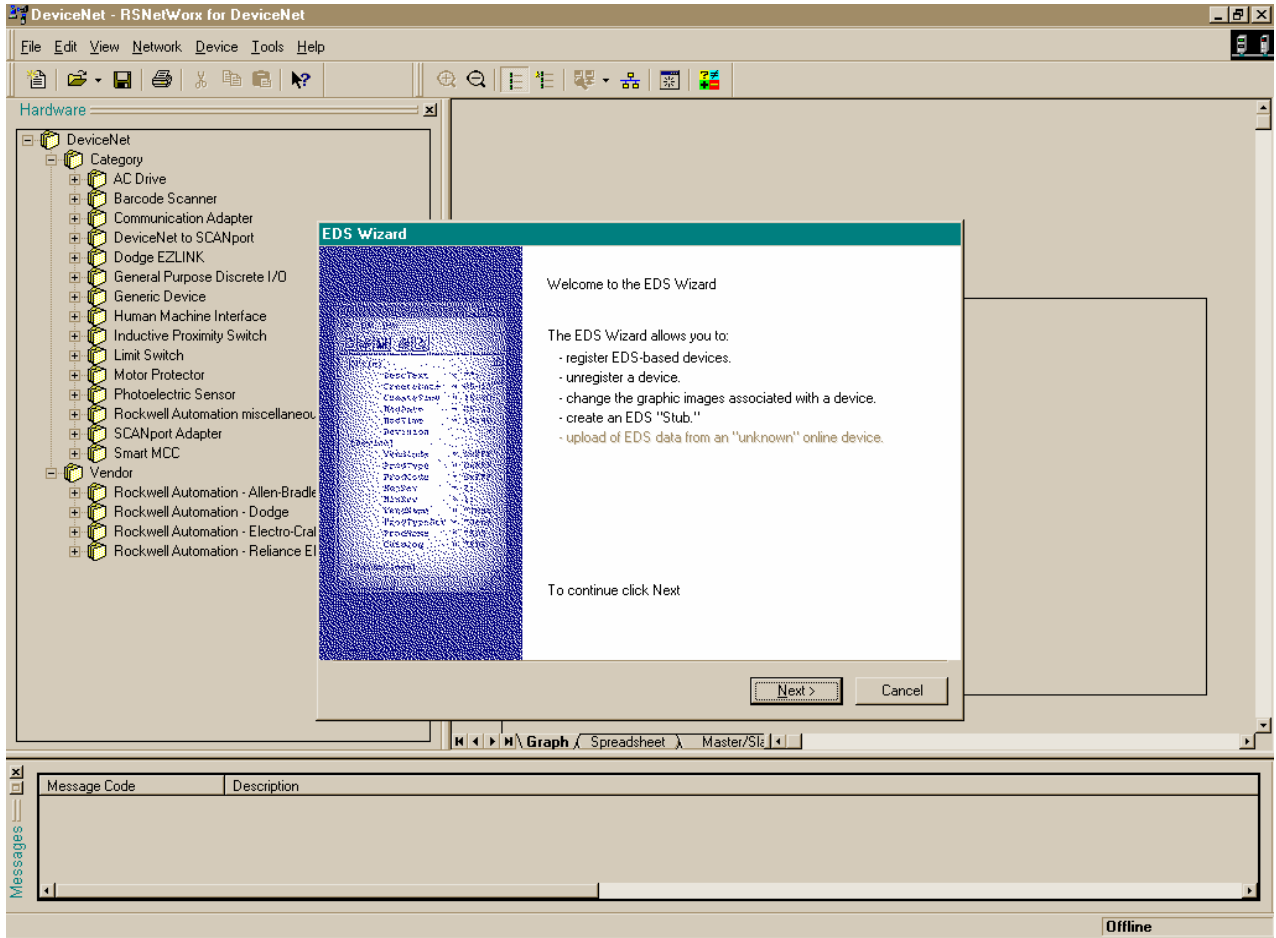

Figure 5 EDS Wizard

Click "Next >" in the "EDS Wizard" window to begin the registration process.

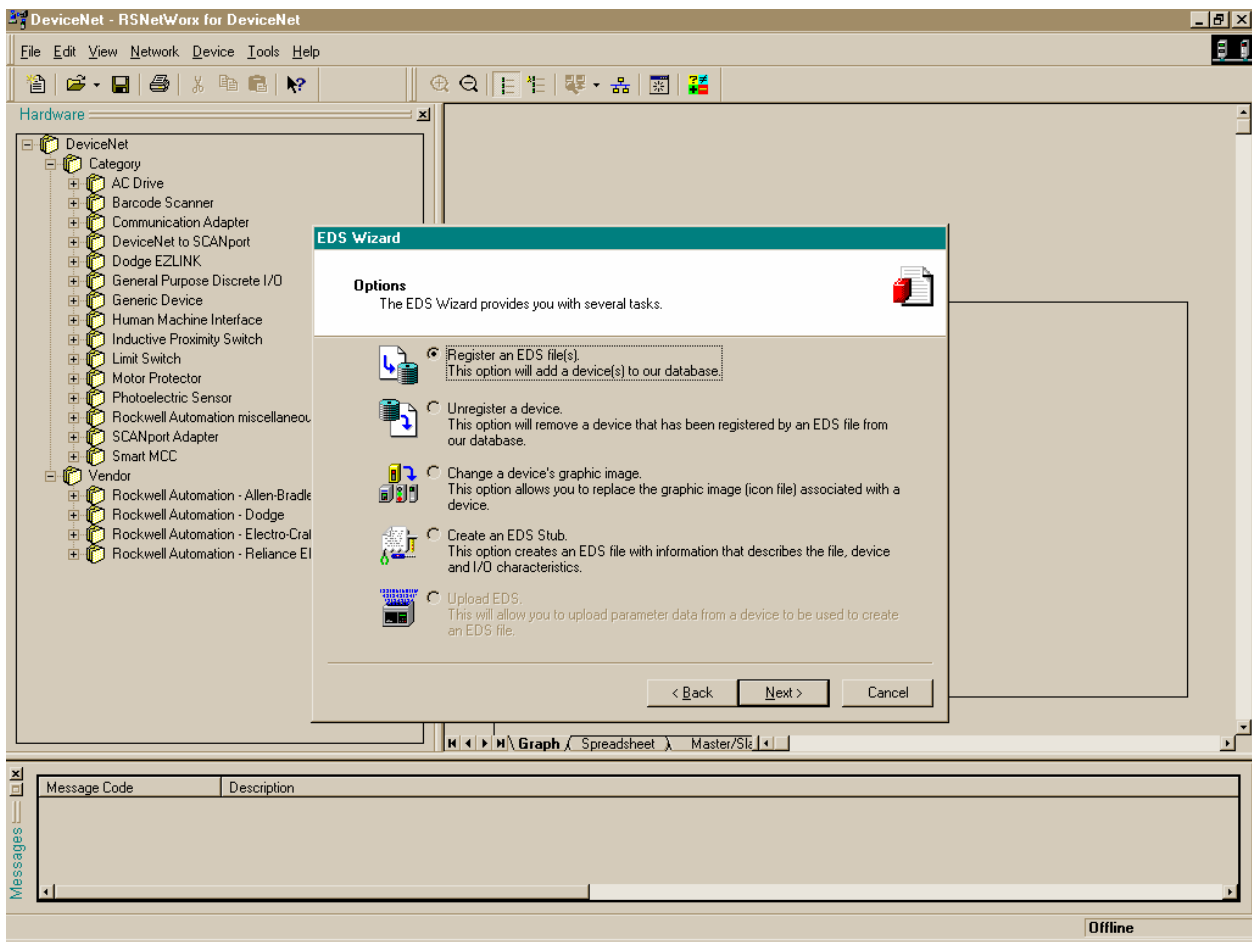

Figure 6 EDS Wizard (cont.)

Make sure "Register an EDS file(s)" is selected and click "Next >".

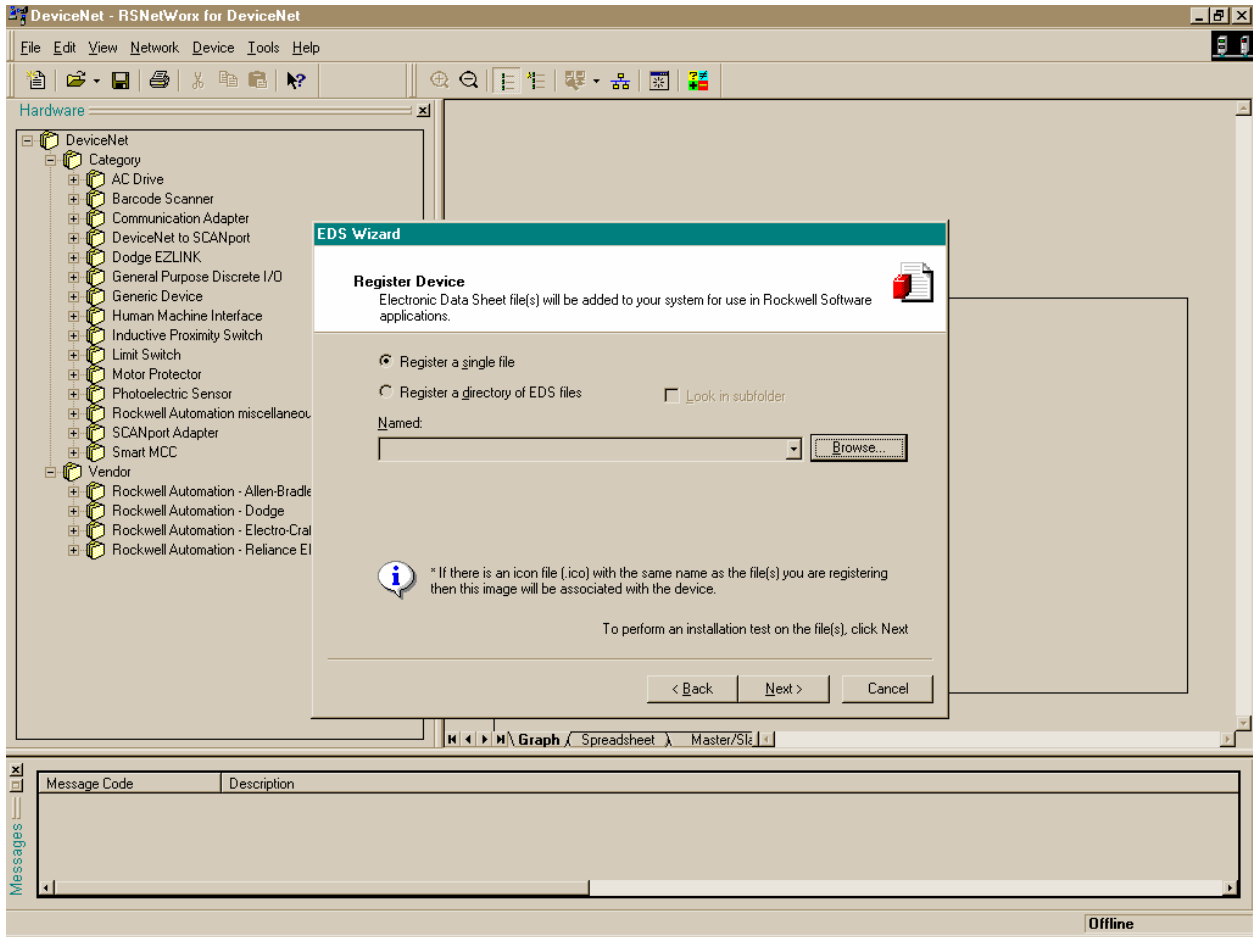

Figure 7 EDS Wizard (cont.)

Click "Browse..." to select the EDS file to be registered.

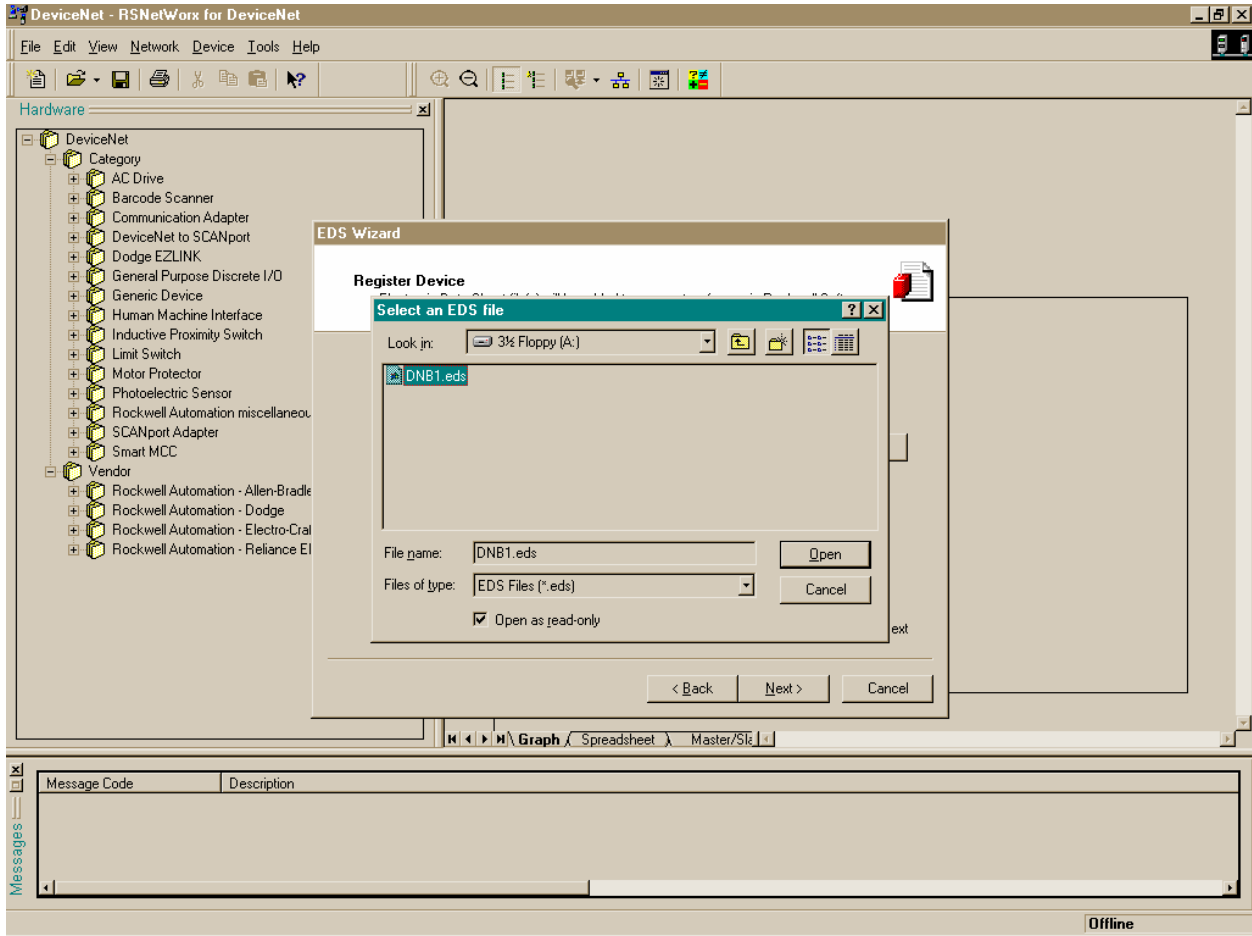

Figure 8 EDS Wizard (cont.)

Select the appropriate location then select file ".EDS_MT_V_2_00_01.EDS". Click "Open". (The EDS file is located on the CD-ROM).

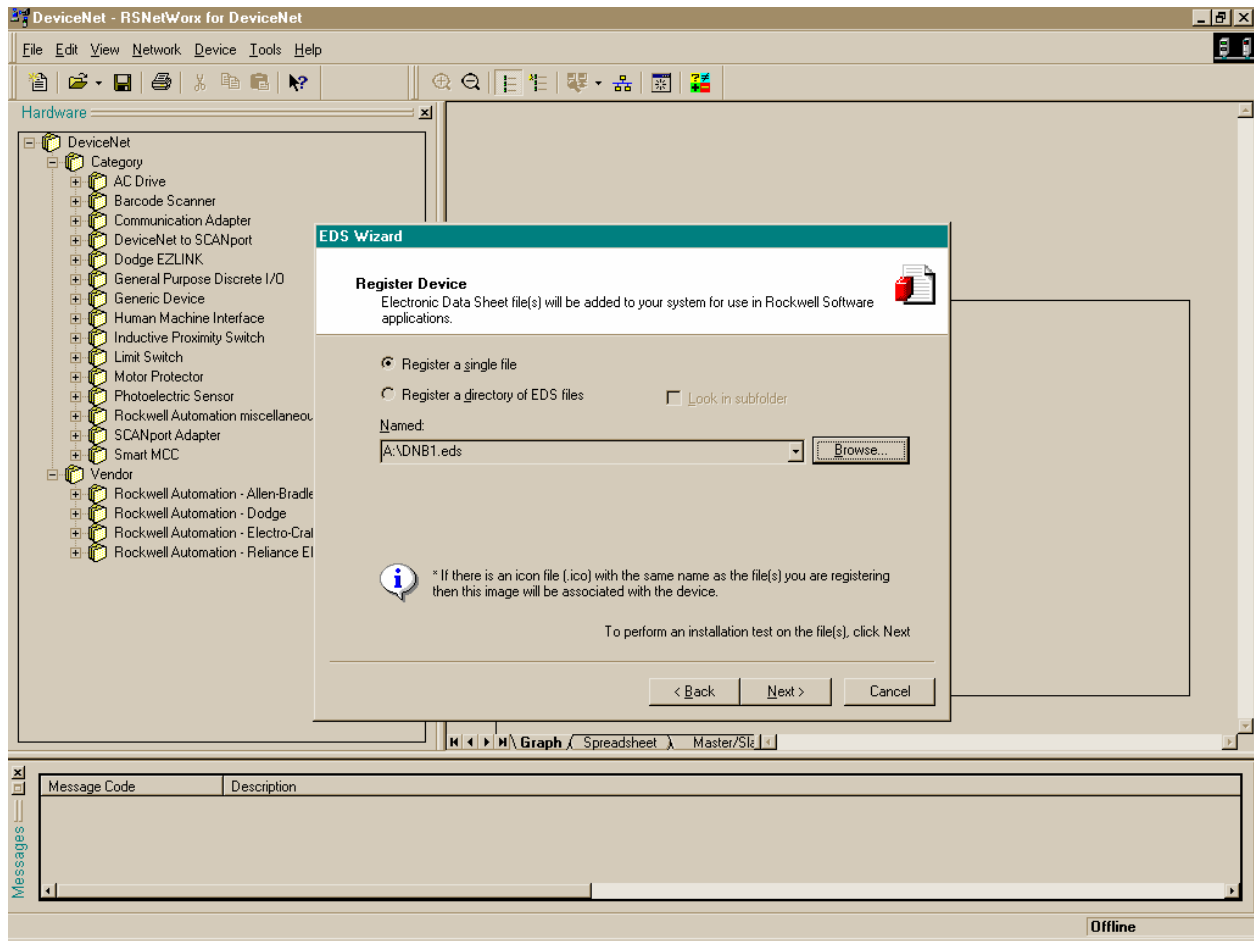

Figure 9 EDS Wizard (cont.)

Click "Next >" in the "EDS Wizard" window.

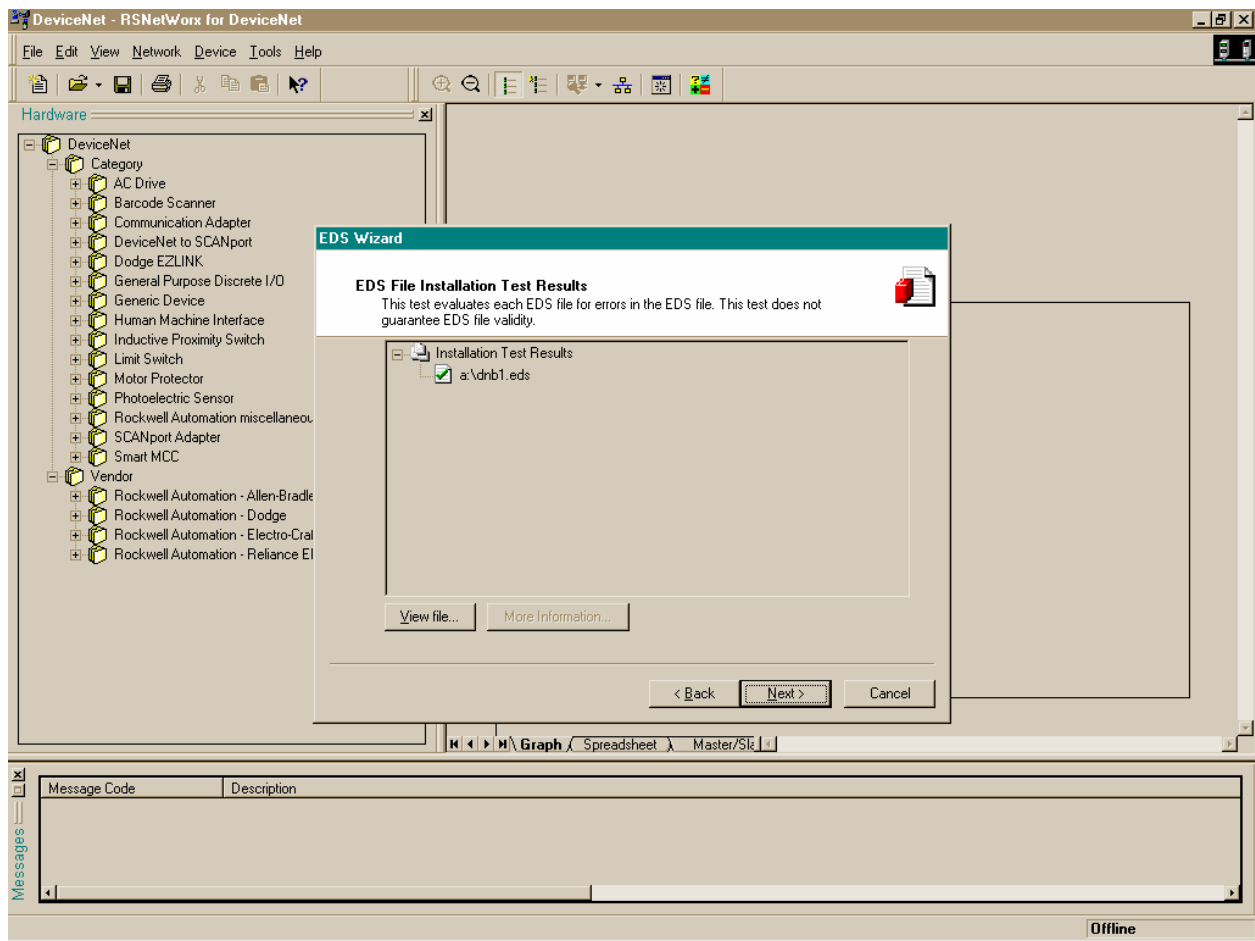

Figure 10 EDS Wizard Test Results

Make sure there is a green check mark (indicating the EDS file is valid) next to "EDS_MT_V_2_00_01.EDS". Click "Next >" to continue.

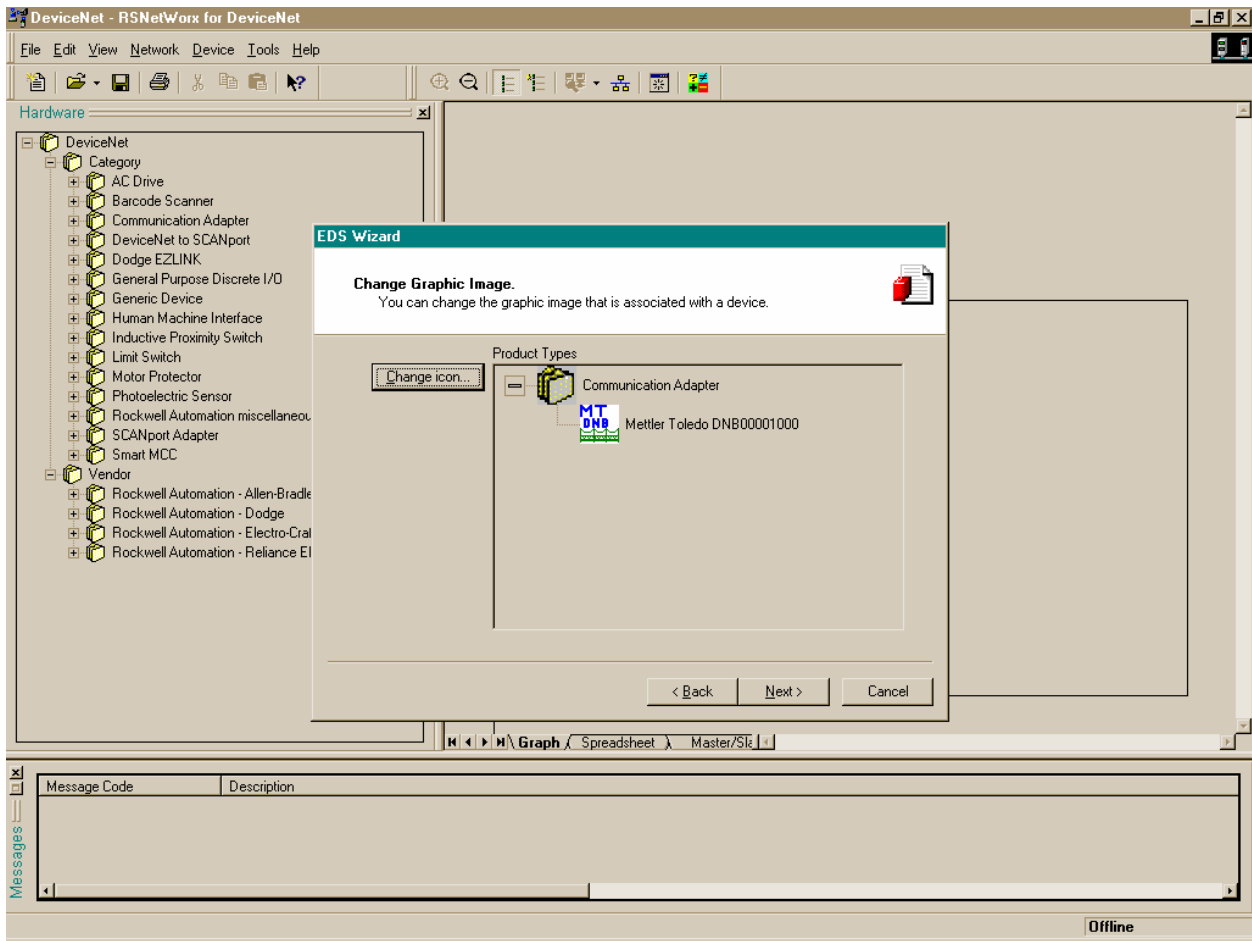

Figure 11 EDS Wizard Graphic Image Selection

Make sure the "METTLER TOLEDO DNB00001000" icon is selected. Note: RSNetWorx for DeviceNet may select a default icon. In this case, click the "Change icon..." button to locate and select the dnb1.ico file.

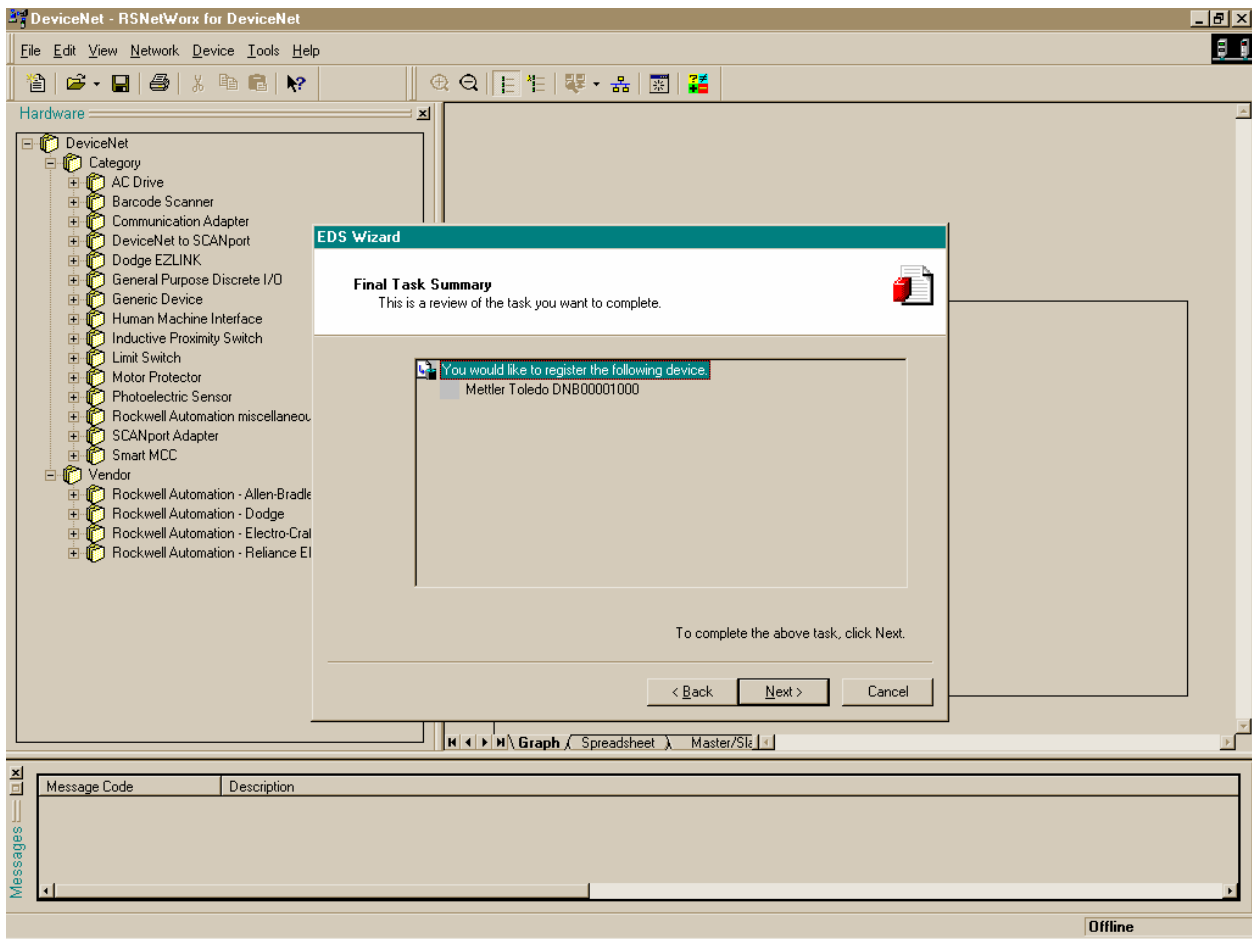

Figure 12 EDS Wizard (cont.)

Click "Next >" in the "EDS Wizard" window to register.

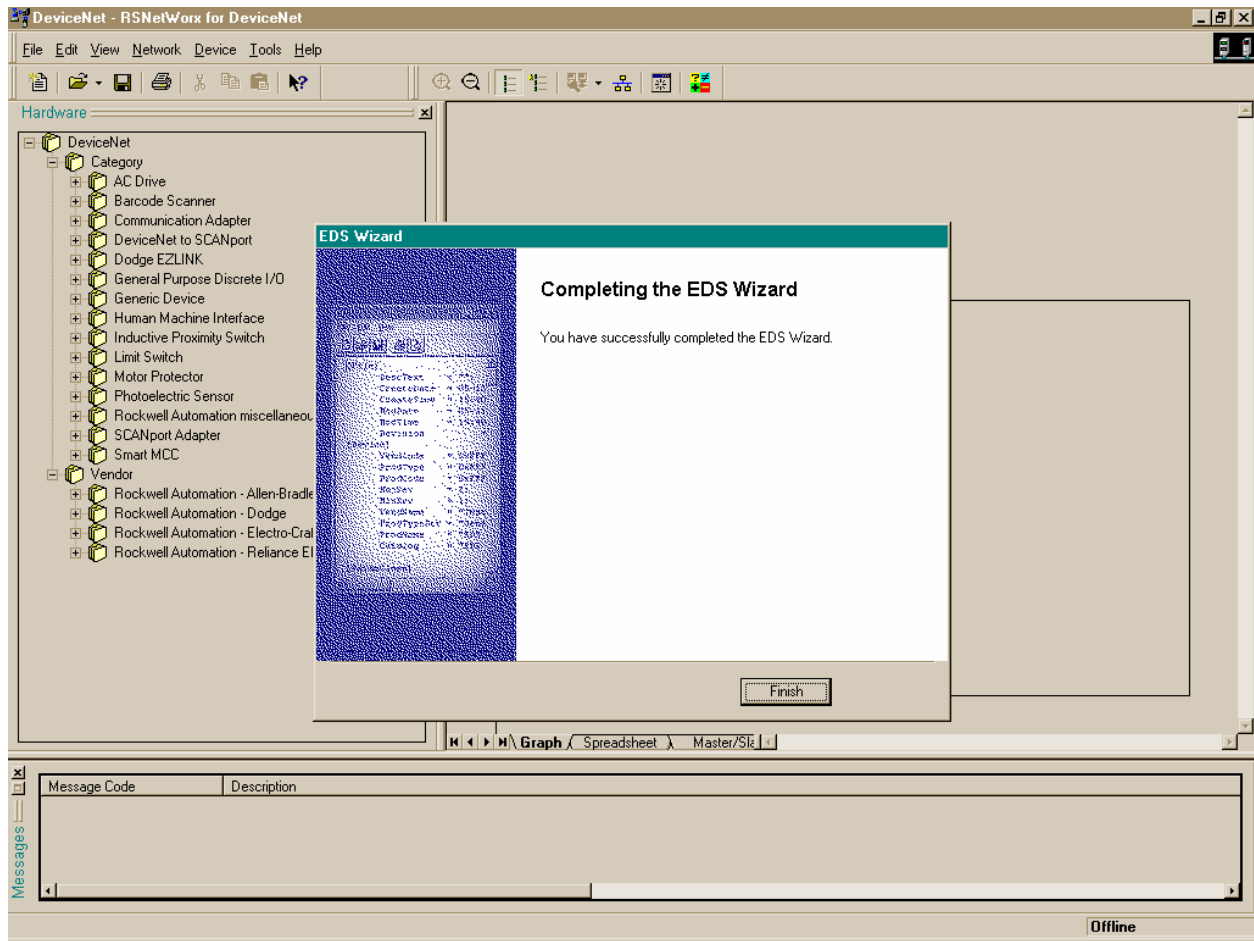

Figure 13 Completing the EDS Wizard
Click "Finish" to exit the EDS Wizard.

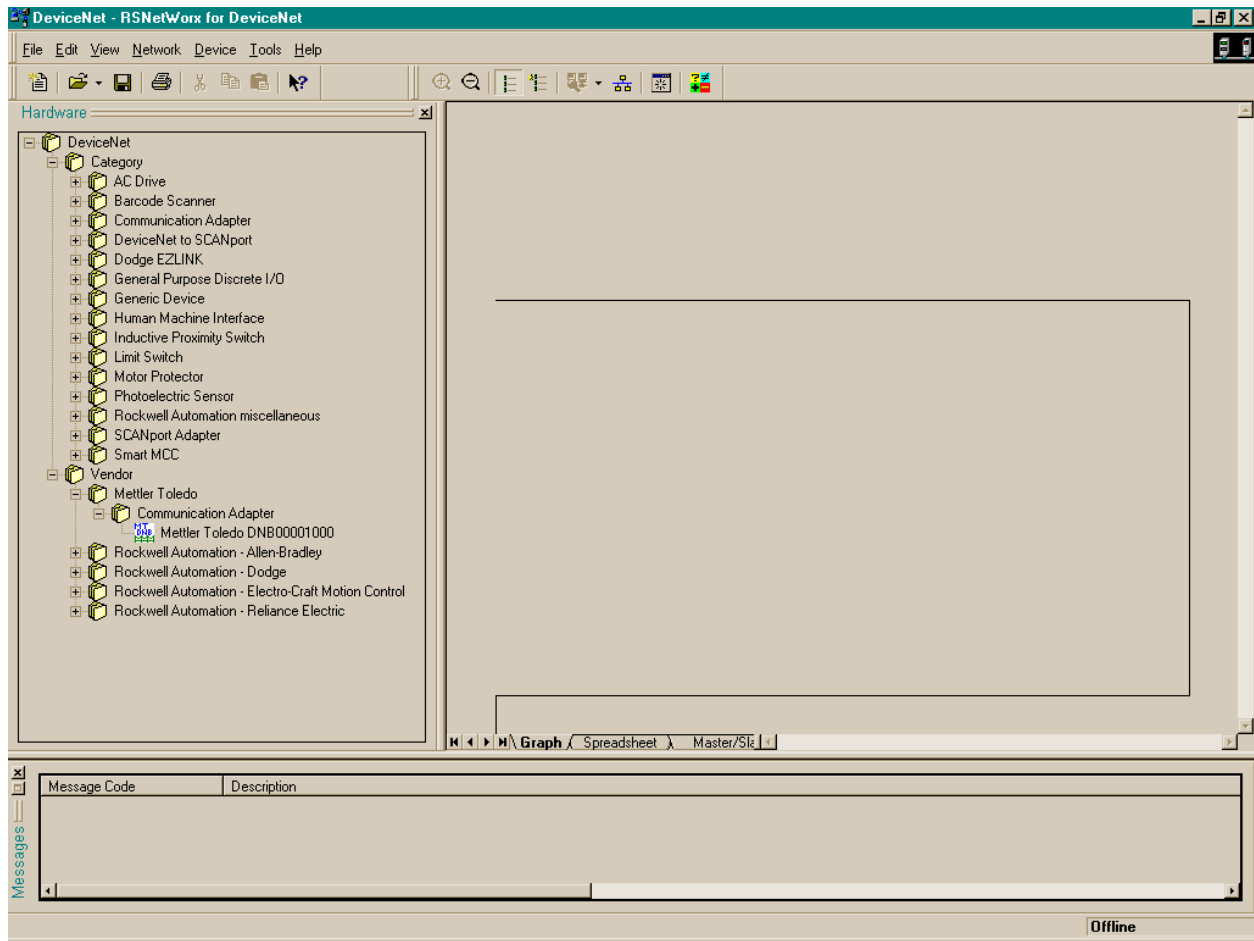

Figure 14 DeviceNet Category and Vendor

When the EDS Wizard is completed, two METTLER TOLEDO DNB00001000 entries are added to: "DeviceNet" -> "Category" -> "Communication Adapter" and "DeviceNet" -> "Vendor" -> "METTLER TOLEDO" -> "Communication Adapter".

5.2 Setting up an I/O Connection

After the EDS file has been registered, RSNetWorx is used to set up a polled connection between the METTLER TOLEDO DNB00001000 and the DeviceNet master/scanner.

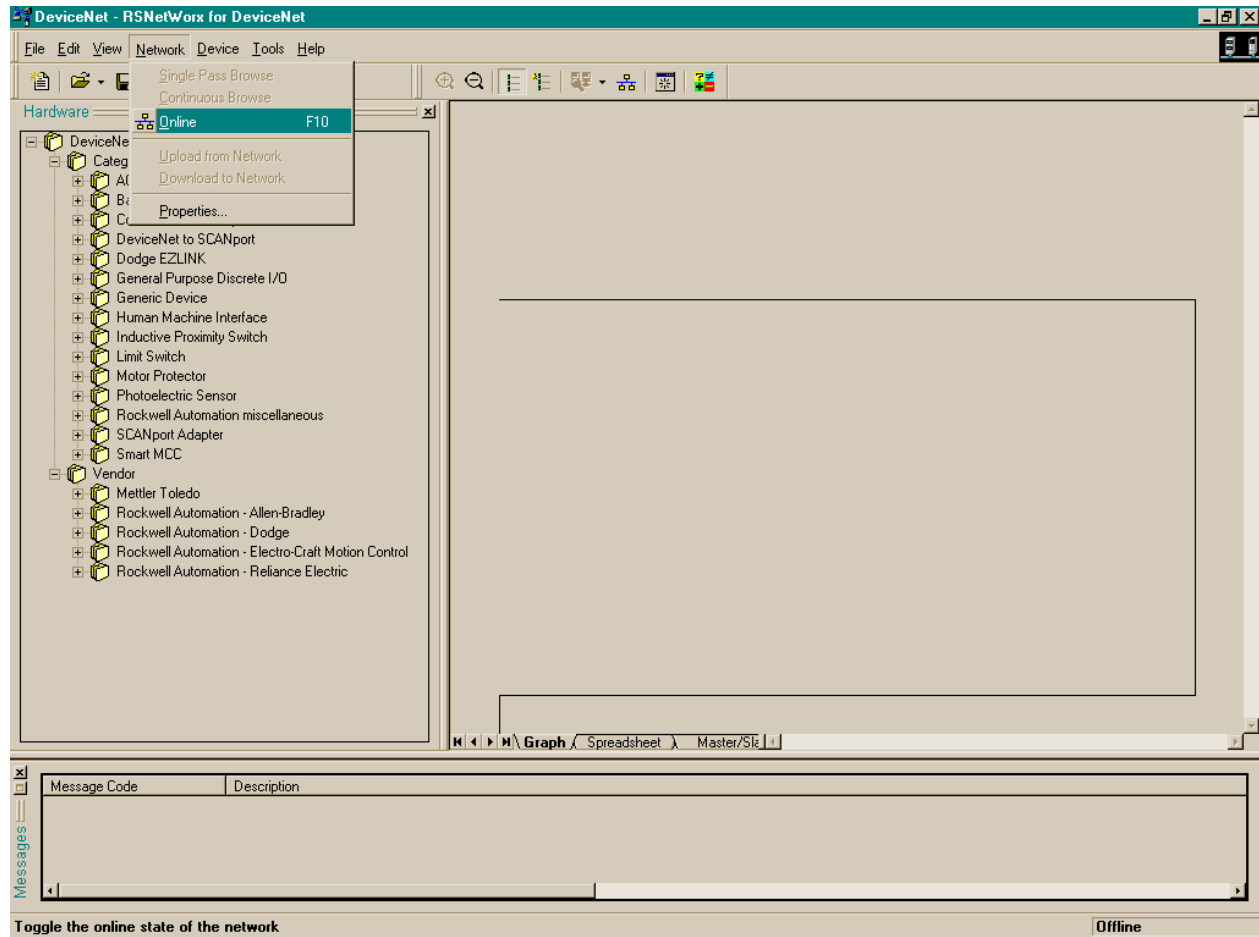

Figure 15 RSNetWorx Online Browse

Select "Network" then "Online" to start a browse of the DeviceNet network.

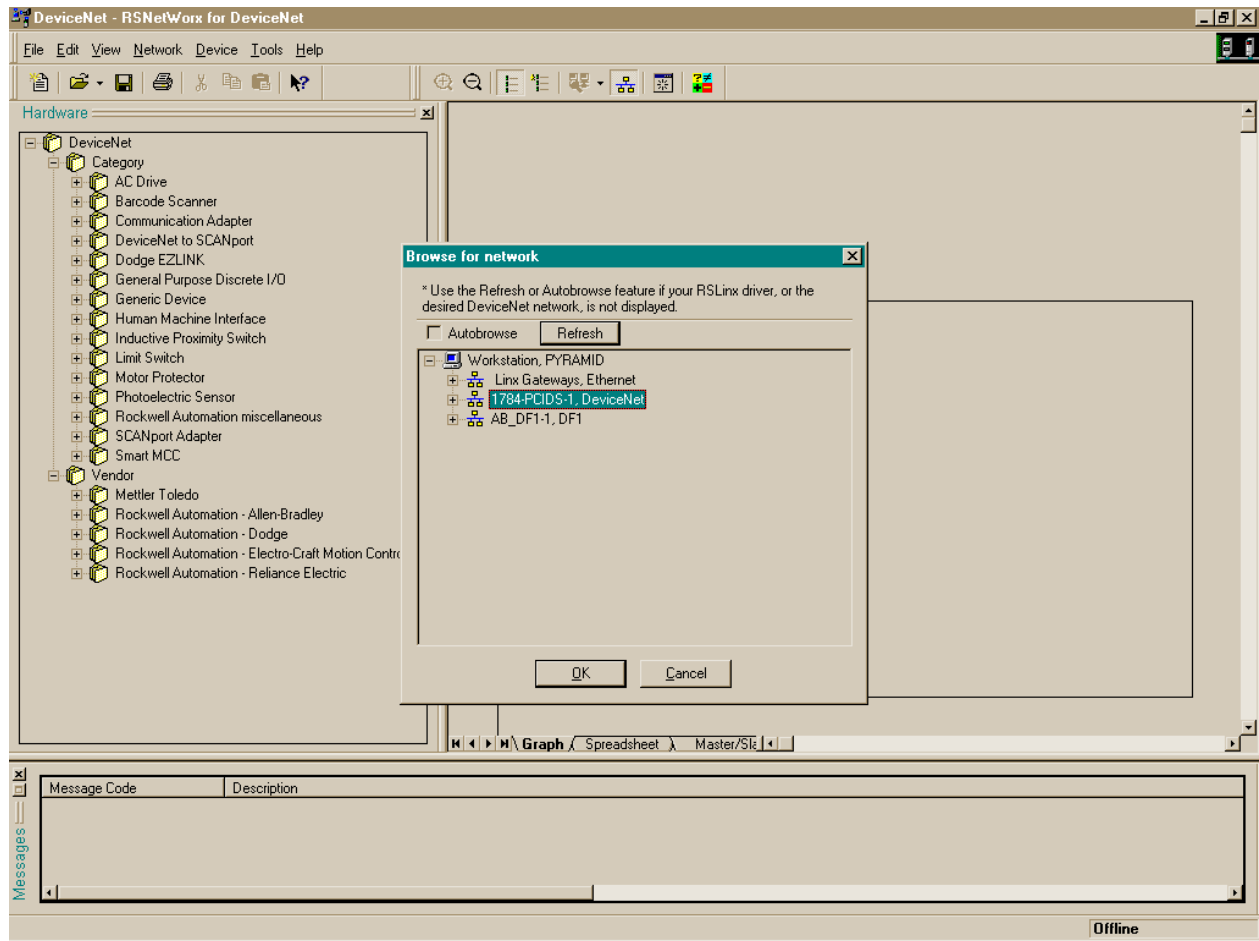

Figure 16 Browse for network

Select the appropriate network path. In this case, "1784-PCIDS-1, DeviceNet" is selected. Click "OK" to continue.

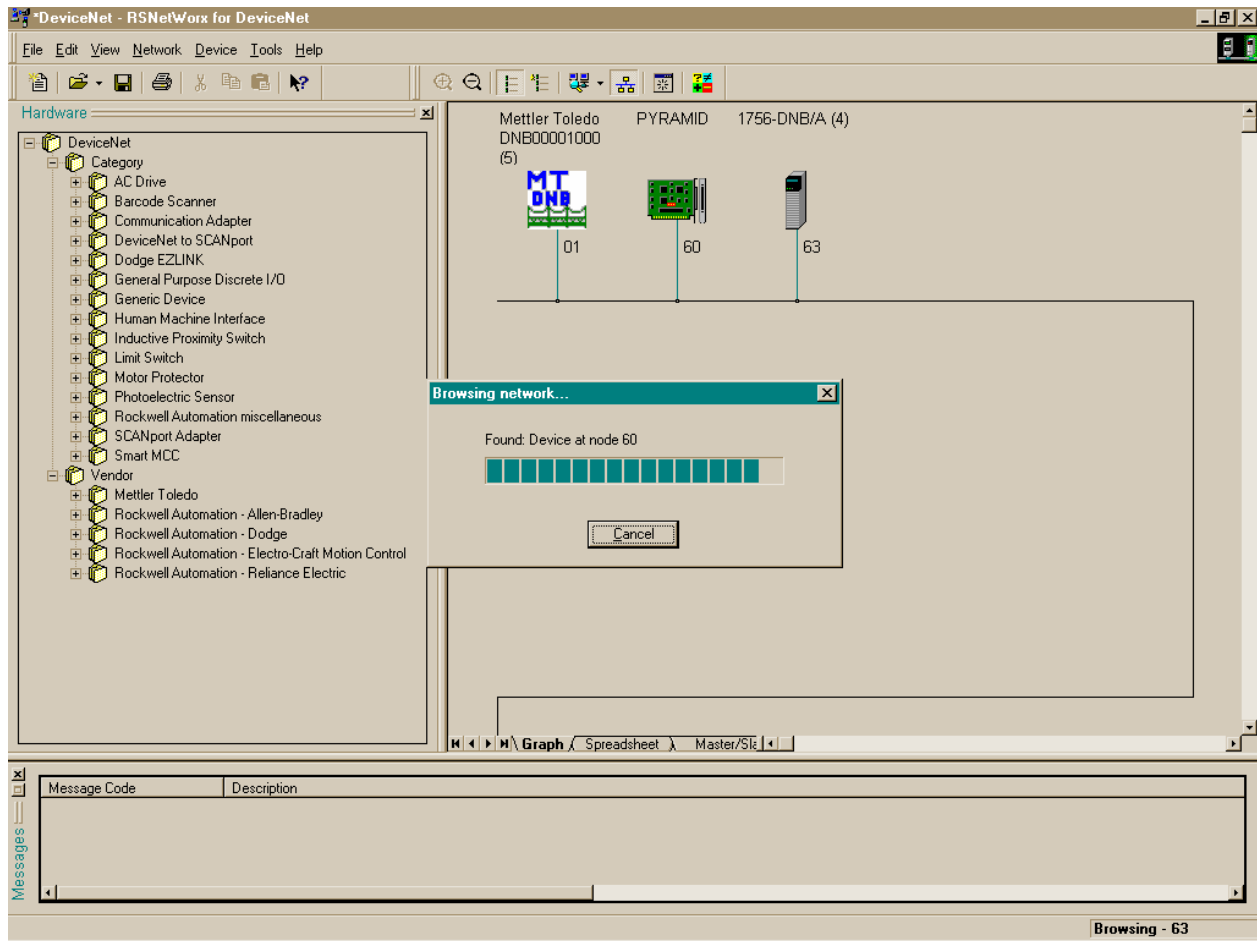

Figure 17 Browsing network...

Wait until the network browse is complete. The METTLER TOLEDO DNB00001000 icon should appear. Other slave devices and/or master/scanner icons should appear for devices on the DeviceNet network. In this case, the 1756-DNB/A is the master/scanner on the DeviceNet network.

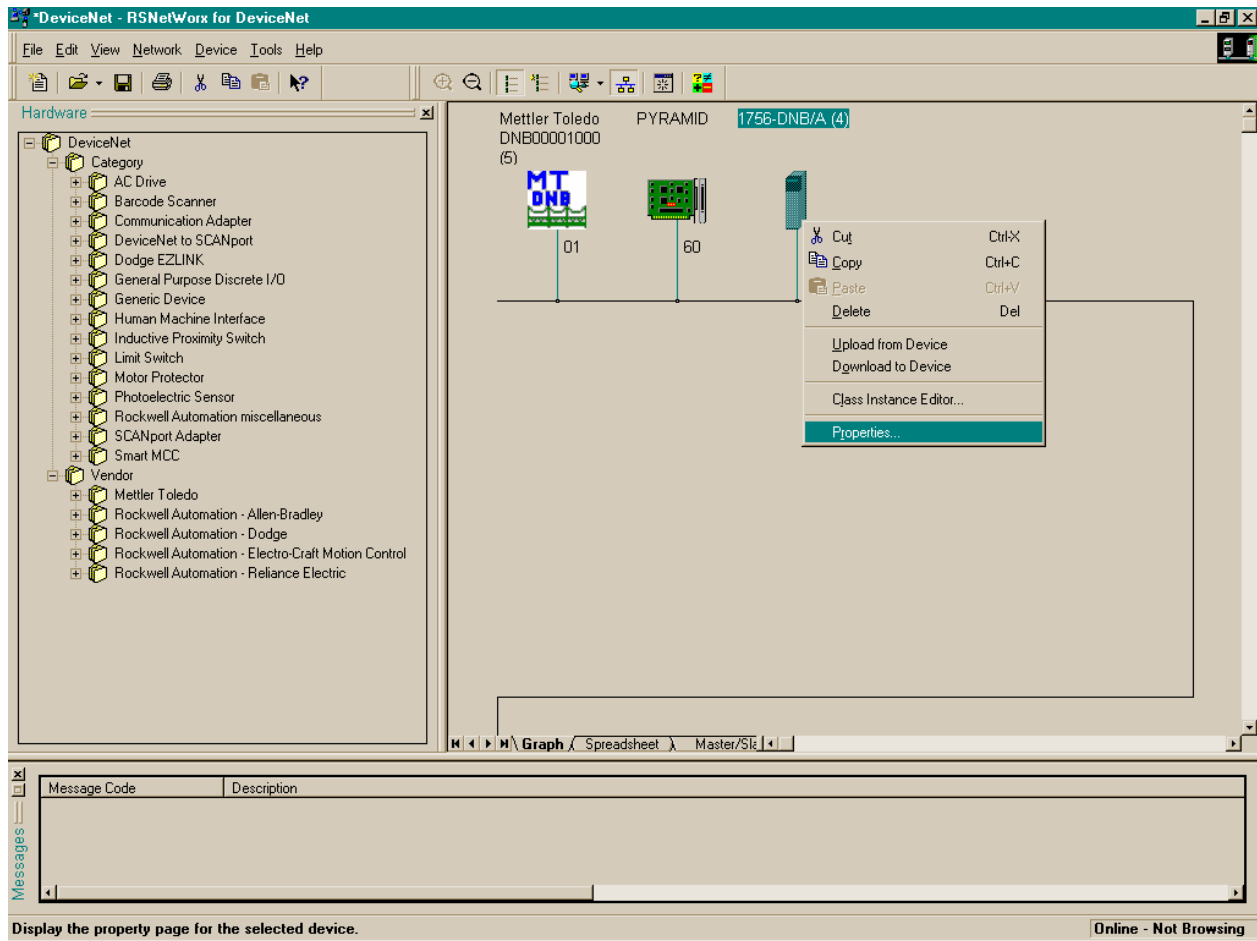

Figure 18 Selection of 1756-DNB/A

The METTLER TOLEDO DNB00001000 needs to be included in the scanlist of the 1756-DNB/A. Right click on the 1756-DNB/A icon in the "Graph" window. Then select Properties..."

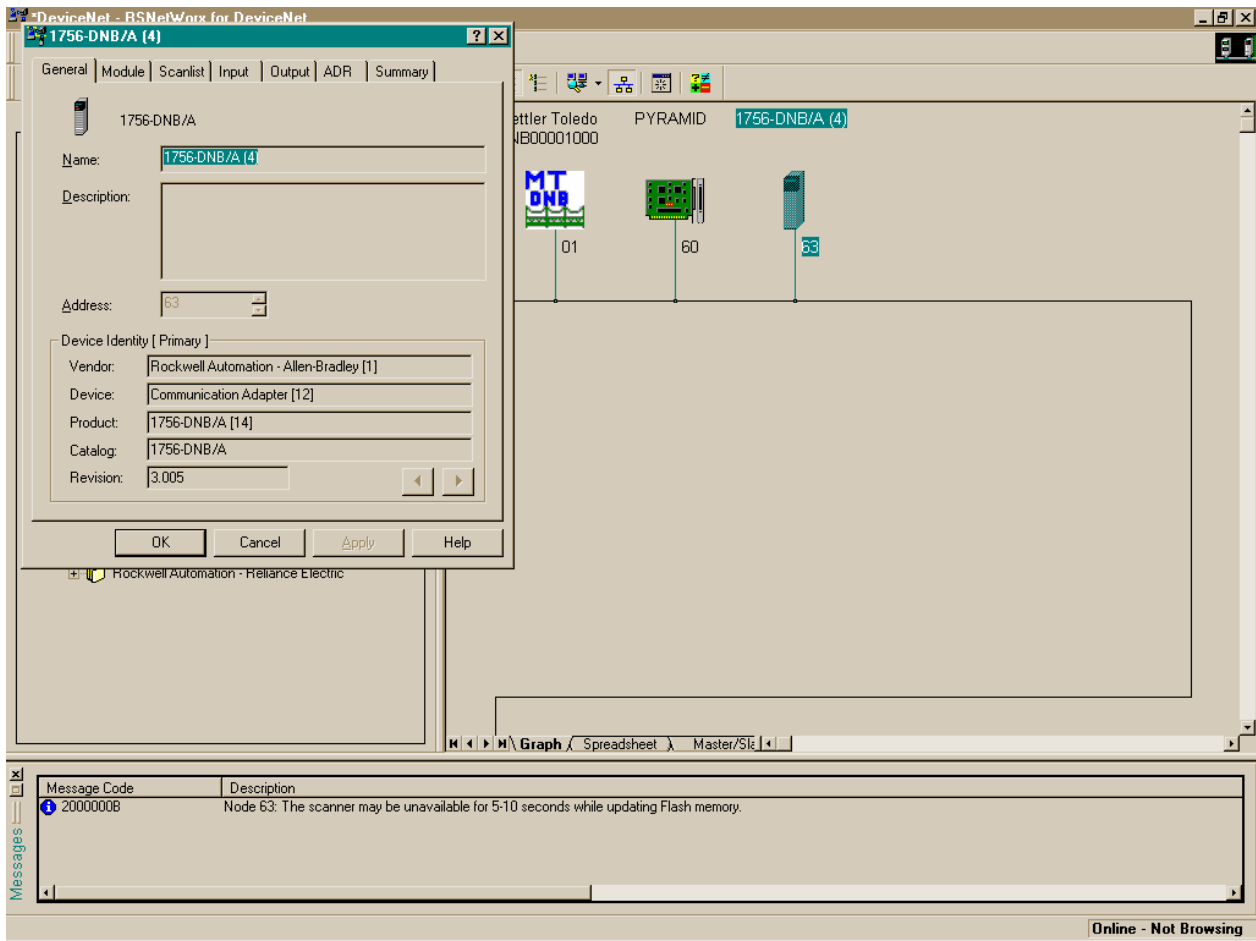

Figure 19 1756-DNB/A Properties

The 1756-DNB/A properties window will be displayed. Click the "Scanlist" tab in the "1756-DNB/A" window.

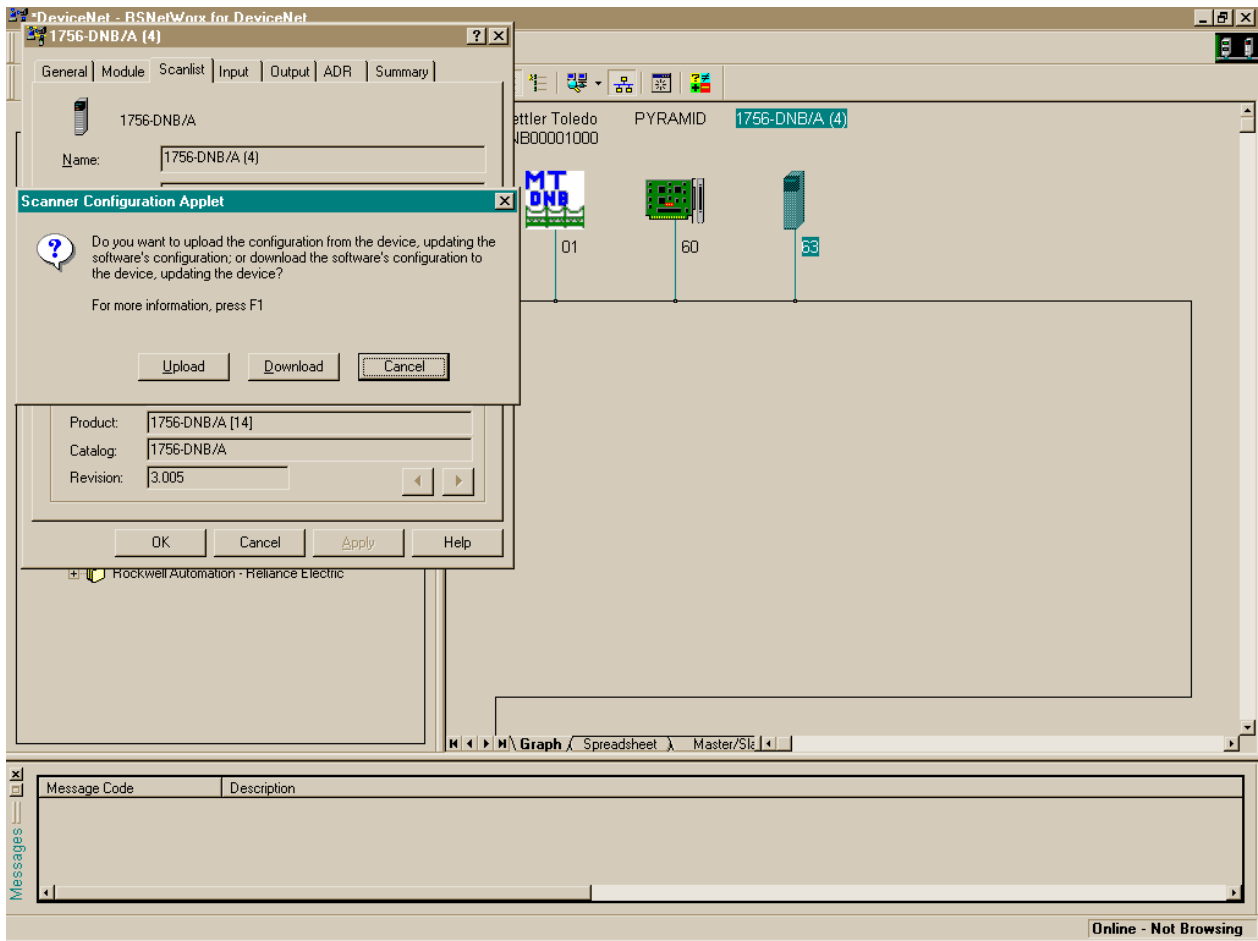

Figure 20 Scanner Configuration Applet

Click the "Upload" button in the "Scanner Configuration Applet" window.

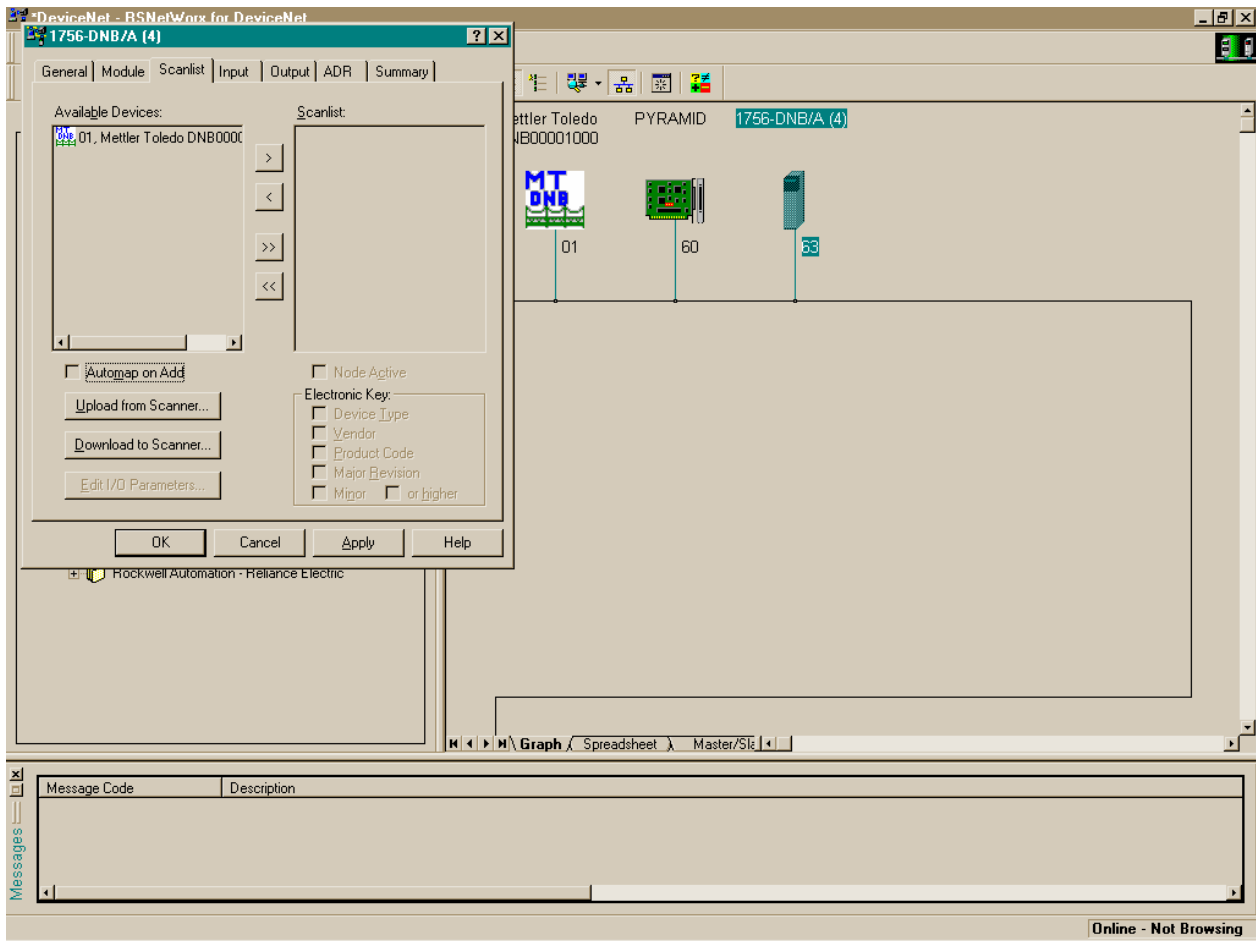

Figure 21 1756-DNB/A Scanlist

De-select the "Automap on Add" option. This allows manual mapping of the input and output files. Click the "METTLER TOLEDO DNB00001000" icon under "Available Devices" then click the ">" button to add the device to the "Scanlist".

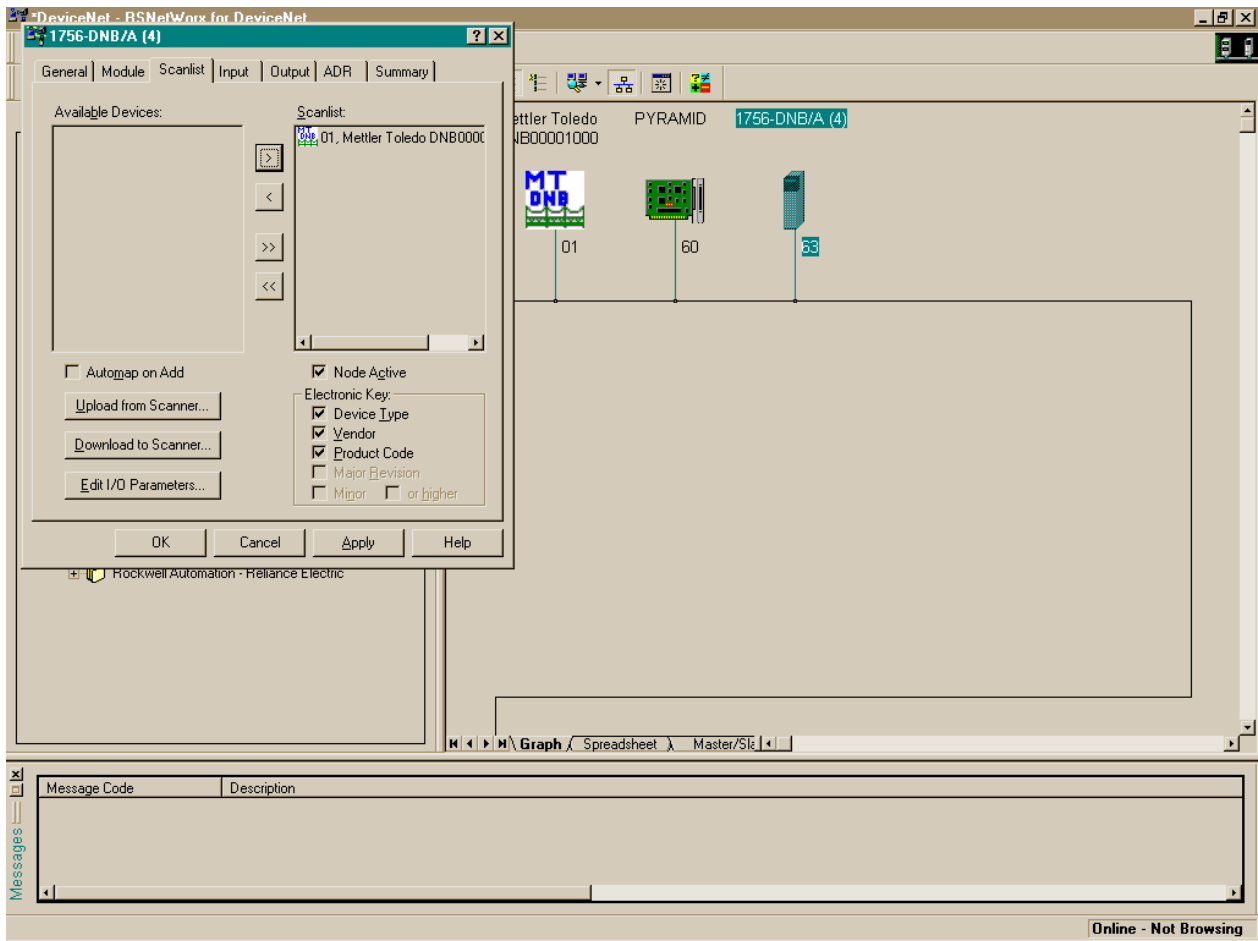

Figure 22 - 1756-DNB/A Scanlist (cont.)

The METTLER TOLEDO DNB00001000 should now be in the 1756-DNB/A scanlist. Click the "Input" tab in the "1756-DNB/A" window.

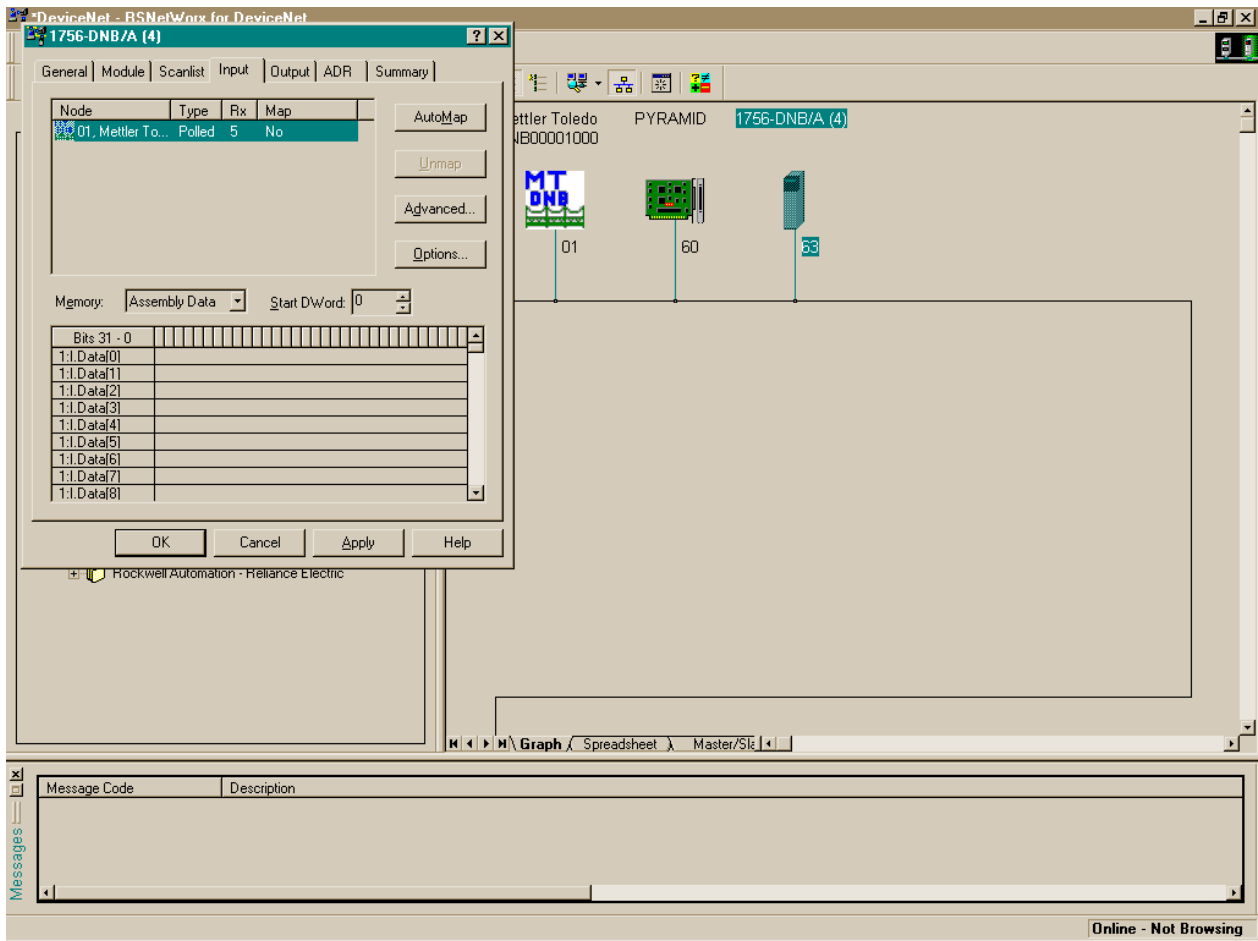

Figure 23 1756-DNB/A Input File

The input file of the 1756-DNB/A is now displayed. In this case, the 1756-DNB/A does not have any devices mapped into the input file. Click the “Advanced” button.

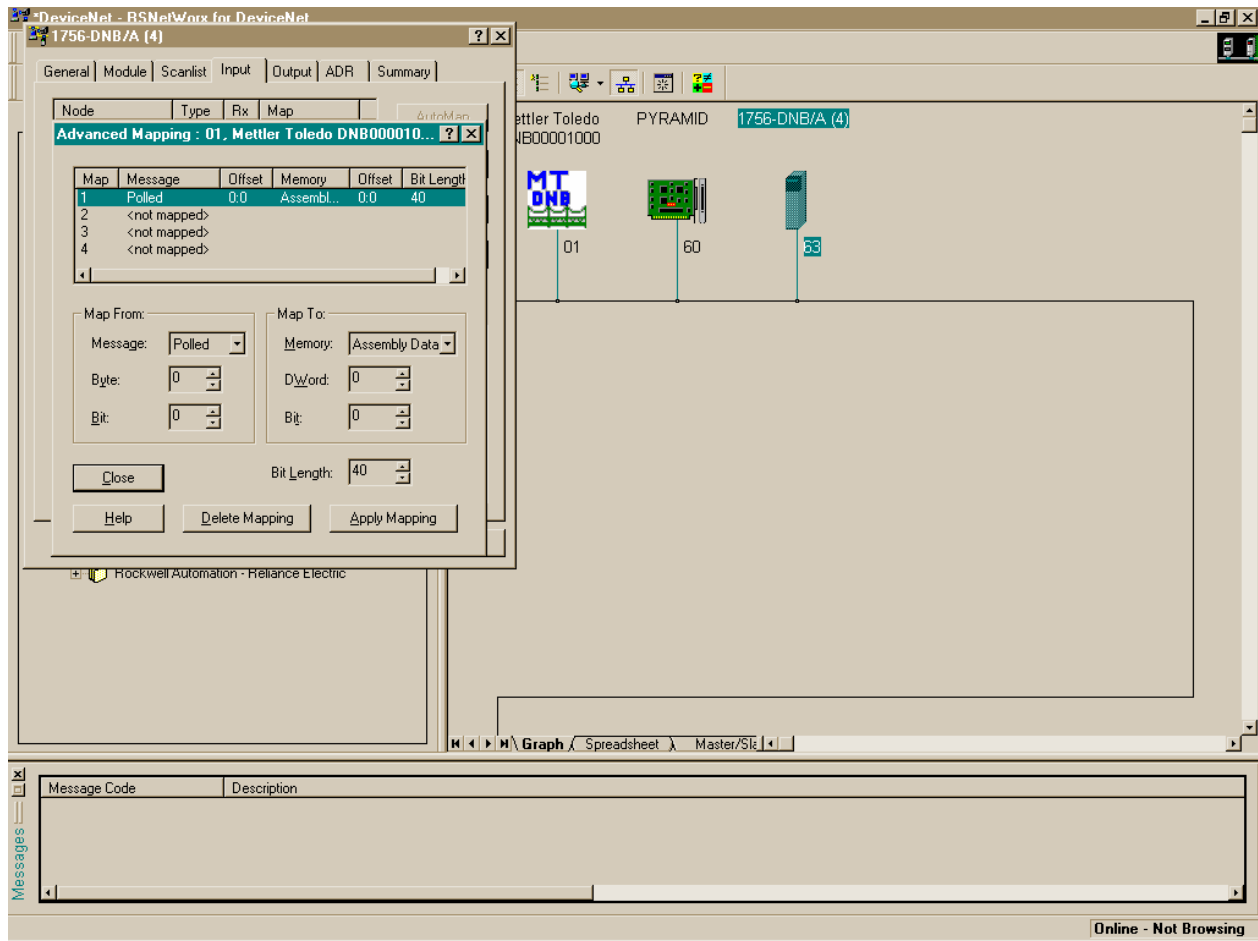

Figure 24 1756-DNB/A Input File Advanced Mapping

Select "Polled" from the "Message:" drop list in "Map From:". Select the appropriate dword offset in "Map To:". In this case, since there are no devices mapped into the input file, the dword offset is set to 0. Click the "Apply Mapping" then "Close" buttons.

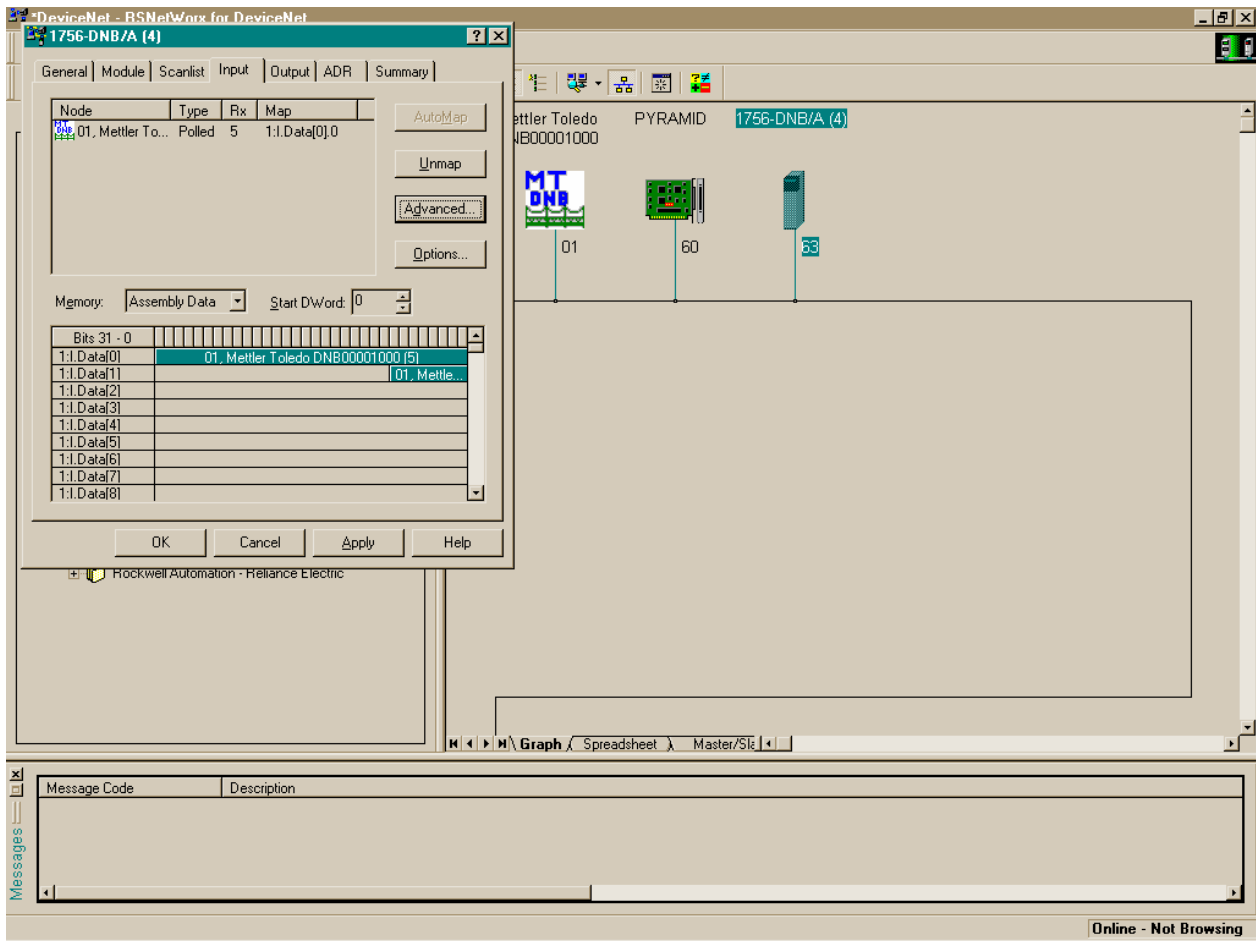

Figure 25 1756-DNB/A Input File (cont.)

The response part of the polled I/O connection has been setup. The 5 byte response from the METTLER TOLEDO DNB00001000 has been mapped into dwords 1:I.Data[0] and 1:I.Data[1] of the 1756 DNB/A scanner.

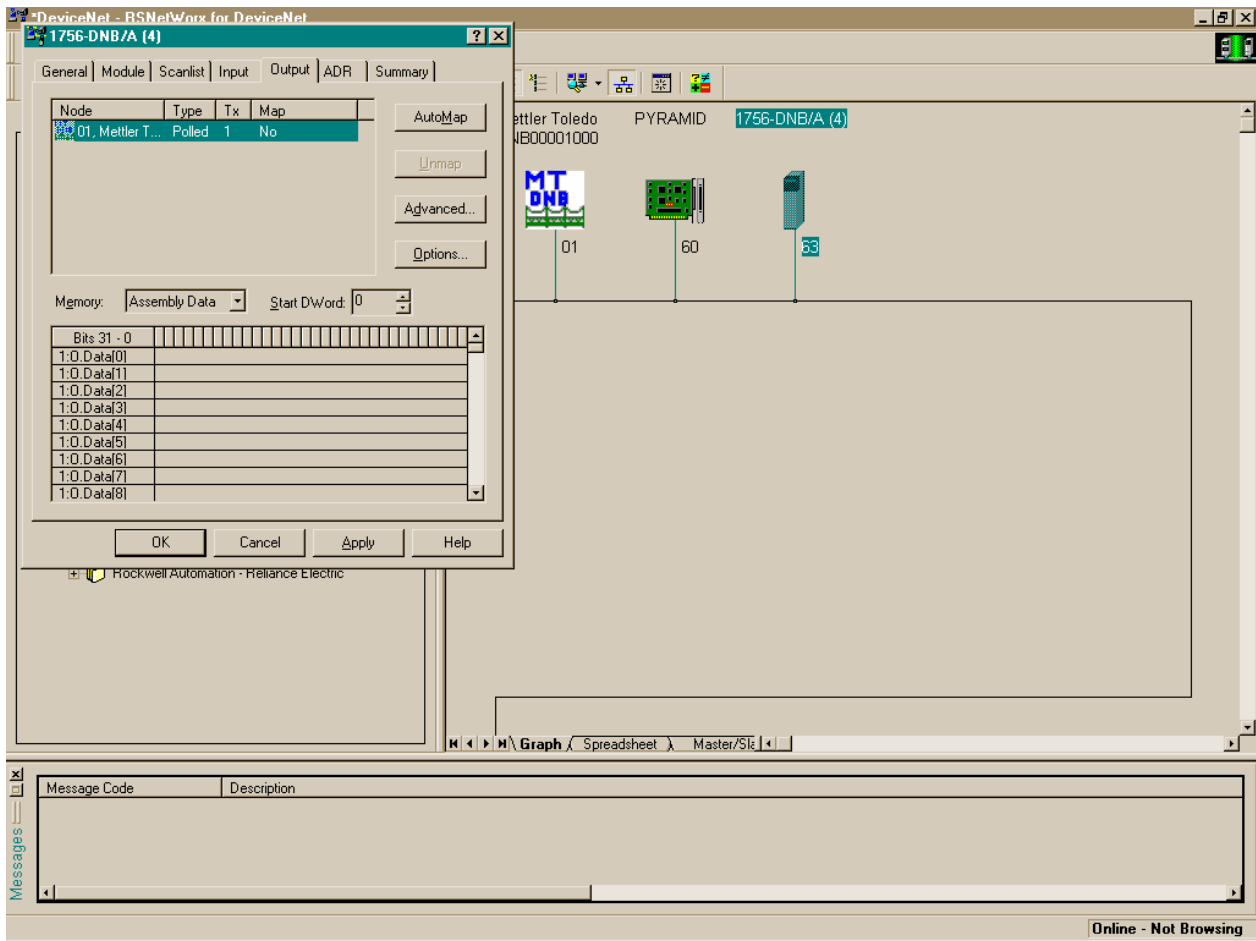

Figure 26 1756-DNB/A Output File

Click the "Output" tab to select the output file. Click the "Advanced" button in the 1756-DNB/A window.

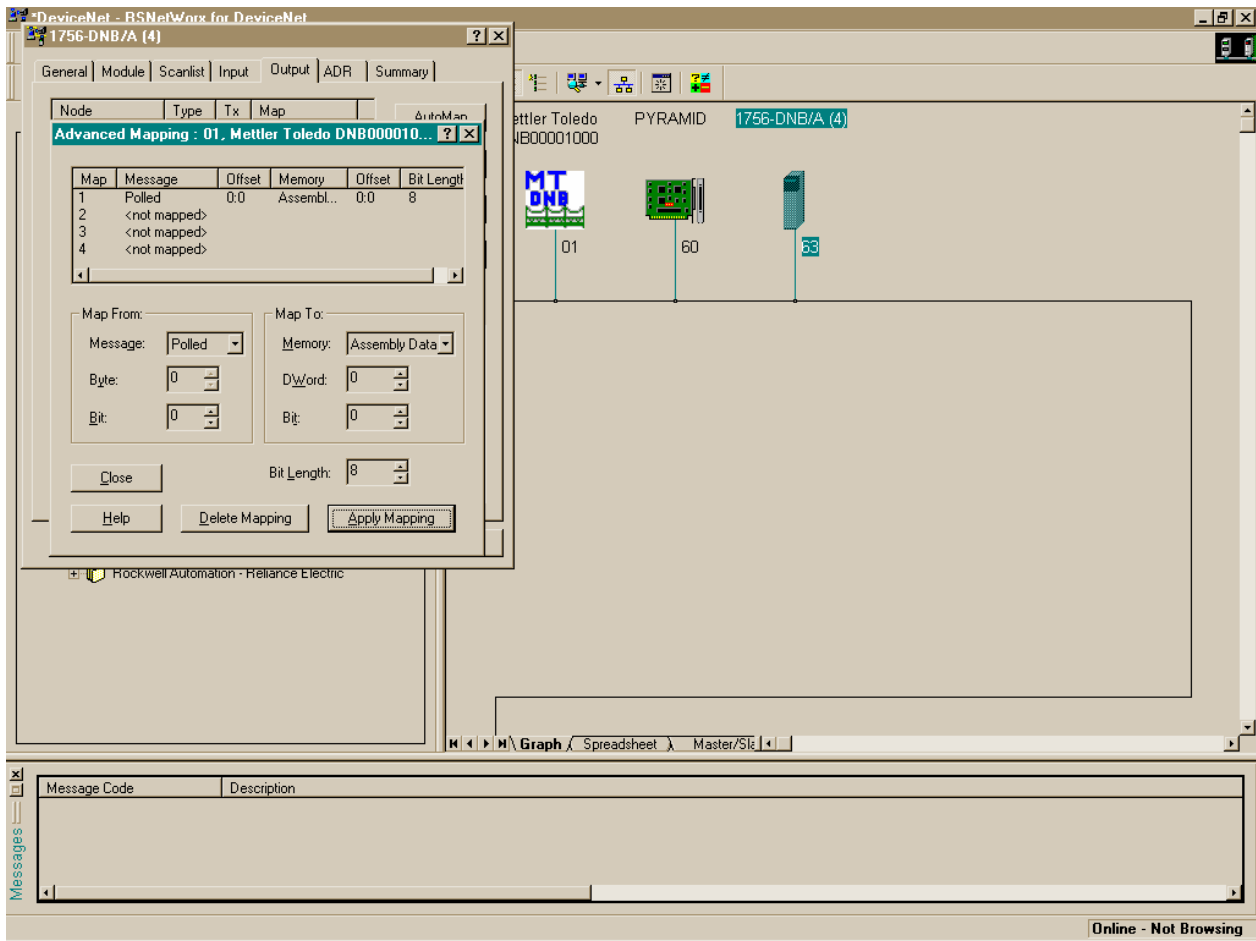

Figure 27 1756-DNB/A Output File Advanced Mapping

Select "Polled" from the "Message:" drop list in "Map From:" Select the appropriate dword offset in "Map To:" In this case, since there are no devices mapped into the output file, the dword offset is set to 0. Click the "Apply Mapping" then "Close" buttons.

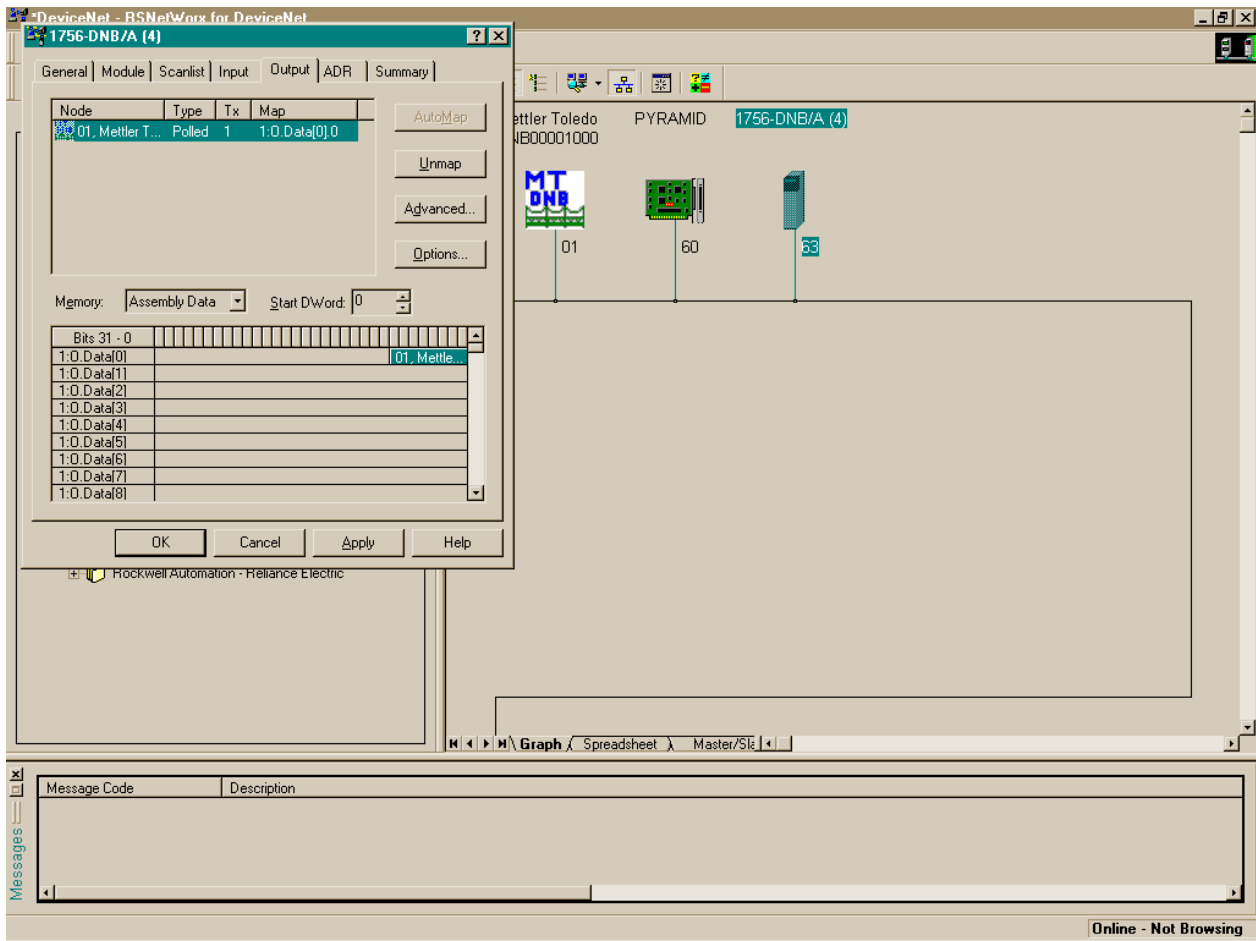

Figure 28 1756-DNB/A Output File (cont.)

The request part of the polled I/O connection has been setup. The 1 byte request to the METTLER TOLEDO DNB00001000 has been mapped into dword 1:0.Data[0] of the 1756 DNB/A scanner.

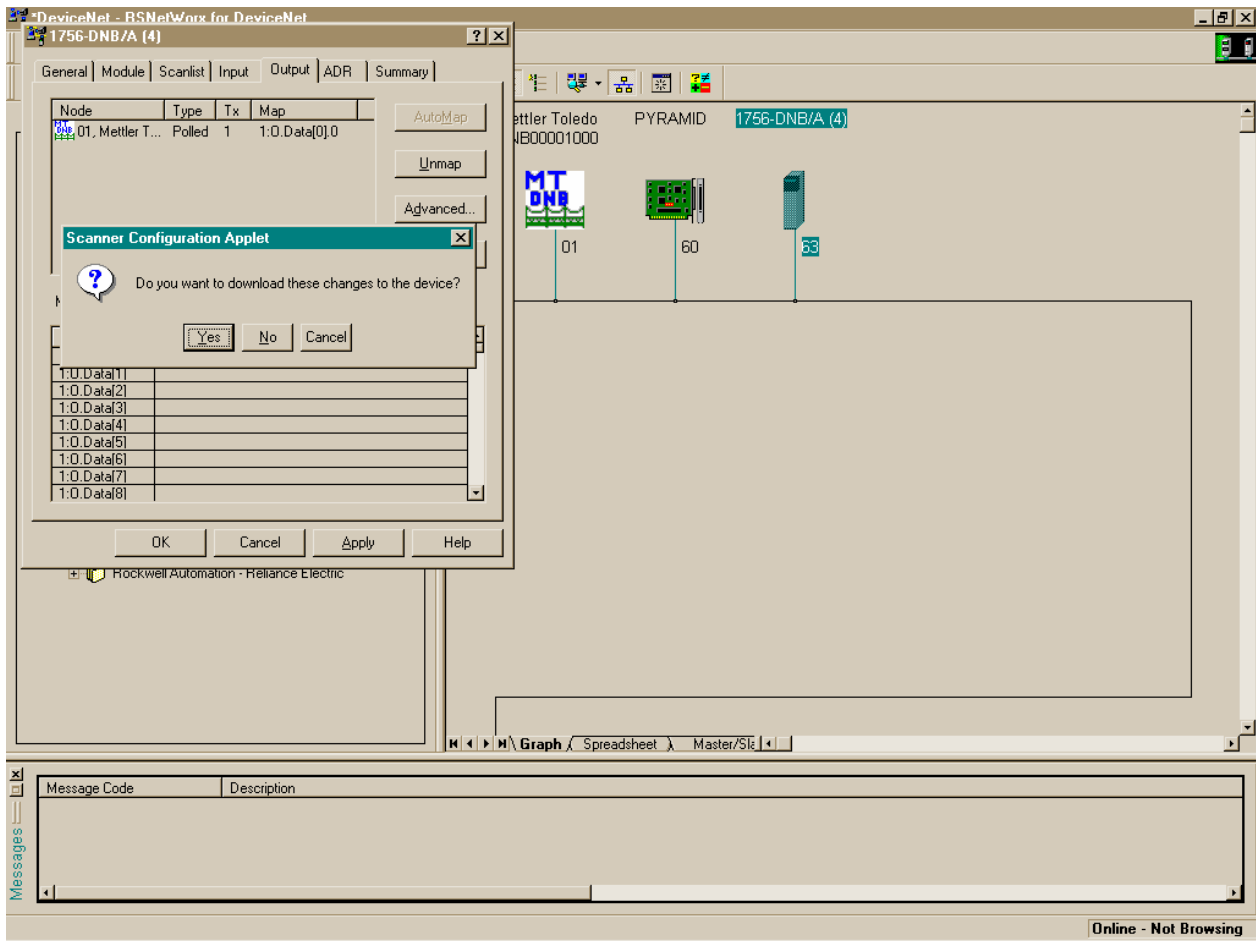

Figure 29 - Scanner Configuration Applet

Click "Yes" in the "Scanner Configuration Applet" window to save the scan table in the 1756-DNB/A. RSNetWorx will display a message indicating that it will take five to ten seconds for the scanner to be updated in the "Message" window. The 1756-DNB/A is now able to send and receive data from the METTLER TOLEDO DNB00001000.

6. Data Format

6.1 Continuous Mode Output

Data from the scale terminal is sent to the METTLER TOLEDO DNB00001000 in continuous mode output format according to Table 7. Note: The STX and CKSM characters are optional in the continuous mode output. However, the continuous mode output must contain the STX and CKSM characters in order for the METTLER TOLEDO DNB00001000 to autobaud and communicate with a scale terminal. For further information on how to set these options, refer to the terminal technical manual.

Character	Function
1	STX – Start of Text
2	Status Byte A
3	Status Byte B
4	Status Byte C
5	Weight MSD
6	Weight
7	Weight
8	Weight
9	Weight
10	Weight LSD
11	Tare Weight MSD
12	Tare Weight
13	Tare Weight
14	Tare Weight
15	Tare Weight
16	Tare Weight LSD
17	CR – Carriage Return
18	CKSM – Checksum

Table 7 Continuous Mode Output Format

6.2 Output Assembly

The output assembly is the response from the METTLER TOLEDO DNB00001000 to the DeviceNet master/scanner and consists of the status byte and floating-point scale value (4 bytes).

Bit 7	Bit 6	Bit 5	Bit 4	Bit 3	Bit 2	Bit 1	Bit 0
Not Used	Not Used	Print	Motion	Over-Capacity	Minus Sign	Gross / Net	Comm Error

Table 8 Scale Status Byte Format

Bit 7 – Not Used

Bit 6 – Not Used

Bit 5 – Print Request

1 – Print request

Bit 4 – Motion

1 – Motion detected

Bit 3 – Over Capacity

1 – Scale is over / under set capacity

Bit 2 – Minus Sign

1 – Negative measurement

Bit 1 – Gross / Net

1 – Net / 0 – Gross

Bit 0 – Communications Error

1 – Communications error* / Timeout or invalid port setup

***Note: If Communications error bit is set, all data should be considered invalid.**

Byte 1	Byte 2	Byte 3	Byte 4
Floating Point Byte	Floating Point Byte	Floating Point Byte	Floating Point Byte

Table 9 Floating Point Scale Value Format

6.3 Input Assembly

The input assembly is a command from the DeviceNet master/scanner to the METTLER TOLEDO DNB00001000 and consists of a single byte. The input assembly selects the internal adapter register or instructs the METTLER TOLEDO DNB00001000 to send a command to the scale terminal according to Table 10.

Bit 7	Bit 6	Bit 5	Bit 4	Bit 3	Bit 2	Bit 1	Bit 0
Not Used	Not Used	Z	P	T	C	Tare Weight	Record Weight

Table 10 Input Assembly Format

Bit 7 – Not Used

Bit 6 – Not Used

Bit 5 – “1” Sends ASCII Z to scale terminal

Bit 4 – “1” Sends ASCII P to scale terminal

Bit 3 – “1” Sends ASCII T to scale terminal

Bit 2 – “1” Sends ASCII C to scale terminal

Bits 0 and 1 select the internal adapter register according to Table 11.

Bit 1	Bit 0	Selects Internal Adapter Register
0	0	Displayed Weight Register
0	1	Recorded Displayed Weight Register
1	0	Tare Weight Register
1	1	Recorded Tare Weight Register

Table 11 Internal Adapter Register Selection

6.4 Internal Adapter Registers

The METTLER TOLEDO DNB00001000 contains four internal adapter registers for storing the status byte and floating point weight value reported from the scale terminal. The format of the internal adapter registers is shown in Table 12.

Internal Adapter Register	Byte 7	Byte 6	Byte 5	Byte 4	Byte 3	Byte 2	Byte 1	Byte 0	
Displayed Weight	Not Used	Not Used	Single Precision Floating Point Value MSB				LSB	Not Used	Status Byte
Tare Weight	Not Used	Not Used	Single Precision Floating Point Value MSB				LSB	Not Used	Status Byte
Recorded Displayed Weight	Not Used	Not Used	Single Precision Floating Point Value MSB				LSB	Not Used	Status Byte
Recorded Tare Weight	Not Used	Not Used	Single Precision Floating Point Value MSB				LSB	Not Used	Status Byte

Table 12 Internal Adapter Register Format

Note: The status byte and floating point scale value are aligned on an even address in the internal adapter registers. The single precision floating point scale value is stored in the internal adapter register in big endian format.

7. Operation

7.1 Initial Conditions

When the METTLER TOLEDO DNB00001000 is power-cycled, the four internal floating point adapter registers are initialized to NAN, and all other status and unused bytes are set to OFFH, according to Table 13.

Internal Adapter Register	Byte 7	Byte 6	Byte 5	Byte 4	Byte 3	Byte 2	Byte 1	Byte 0
Displayed Weight	0xFF	0xFF	NAN 0xFF	NAN 0xFF	NAN 0xFF	NAN 0xFF	0xFF	0xFF
Tare Weight	0xFF	0xFF	NAN 0xFF	NAN 0xFF	NAN 0xFF	NAN 0xFF	0xFF	0xFF
Recorded Displayed Weight	0xFF	0xFF	NAN 0xFF	NAN 0xFF	NAN 0xFF	NAN 0xFF	0xFF	0xFF
Recorded Tare Weight	0xFF	0xFF	NAN 0xFF	NAN 0xFF	NAN 0xFF	NAN 0xFF	0xFF	0xFF

Table 13 Internal Adapter Registers Initial Contents

7.2 AutoBaud Mode

The METTLER TOLEDO DNB00001000 will enter autobaud mode upon initialization or when a communications error has occurred with the scale terminal. A communications error is either a timeout condition (two seconds have elapsed without the METTLER TOLEDO DNB00001000 receiving one packet of continuous mode output from the scale terminal) or two consecutive checksum errors have occurred. When the METTLER TOLEDO DNB00001000 is in autobaud mode, the internal adapter registers are set according to Table 14. Bytes 1 to 7 are set to 0xFF. Byte 0, the status byte, is set to 0x01, indicating a communications error. The METTLER TOLEDO DNB00001000 remains in autobaud mode until the serial data format / baud rate has been determined and one packet of continuous mode output has been received from the scale terminal.

Internal Adapter Register	Byte 7	Byte 6	Byte 5	Byte 4	Byte 3	Byte 2	Byte 1	Byte 0
Displayed Weight	0xFF	0xFF	NAN 0xFF	NAN 0xFF	NAN 0xFF	NAN 0xFF	0xFF	Status Byte 0x01
Tare Weight	0xFF	0xFF	NAN 0xFF	NAN 0xFF	NAN 0xFF	NAN 0xFF	0xFF	Status Byte 0x01
Recorded Displayed Weight	0xFF	0xFF	NAN 0xFF	NAN 0xFF	NAN 0xFF	NAN 0xFF	0xFF	Status Byte 0x01
Recorded Tare Weight	0xFF	0xFF	NAN 0xFF	NAN 0xFF	NAN 0xFF	NAN 0xFF	0xFF	Status Byte 0x01

Table 14 Internal Adapter Register Contents in Autobaud Mode

7.3 Normal Mode

When the METTLER TOLEDO DNB00001000 enters normal mode, the continuous mode output described in section 6.1 is converted to an output assembly format described in section 6.2. The output assembly is then written to the IN area of DPRAM. The METTLER TOLEDO DNB00001000 also accepts commands from a DeviceNet master/scanner via the input assembly (described in section 6.3) by reading the OUT area of DPRAM.

7.3.1 DPRAM IN Area

The output assembly is written to the IN area of DPRAM according to Table 15. Note: The floating-point scale value is placed in the IN area of DPRAM in little endian format.

Byte	Byte Name
0	Scale Status
1	Floating Point Scale Value Byte MSB
2	Floating Point Scale Value Byte
3	Floating Point Scale Value Byte
4	Floating Point Scale Value Byte LSB

Table 15 DPRAM IN Area Contents

7.3.2 DPRAM OUT Area

Commands from the DeviceNet master/scanner are read from the OUT area of DPRAM. The command from the DeviceNet master/scanner follows the input assembly format described in section 6.3.

Byte	Byte Name
0	Command from DeviceNet master/scanner

Table 16 DPRAM OUT Area Contents

8. Indication LED's

The METTLER TOLEDO DNB00001000 has 6 LED's. They are described below.

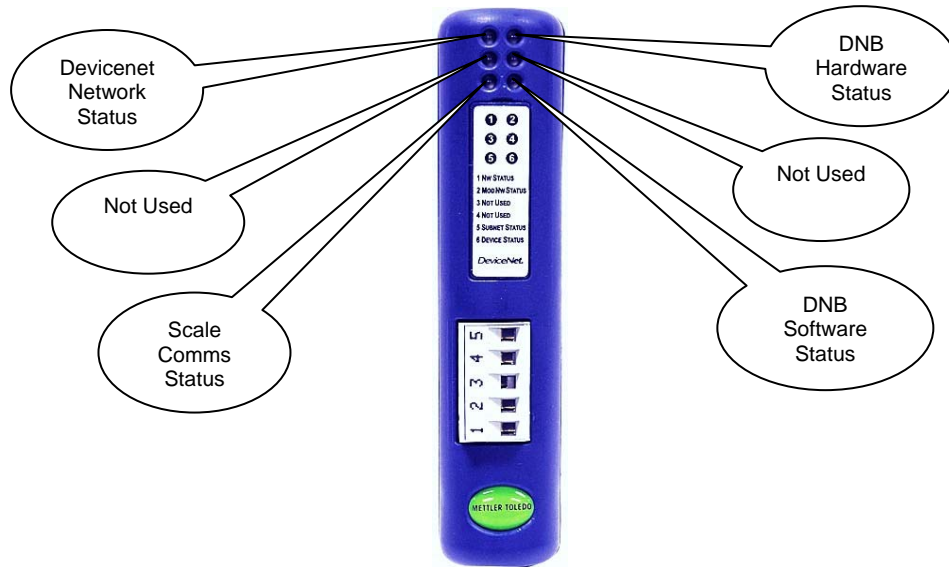

Figure 30 Mother Circuit Bd External LED's

LED	LED Color	Description
DNB Hardware Status	Steady OFF	no power
DNB Hardware Status	Steady Red	DNB unrecoverable hardware fault
DNB Hardware Status	Steady Green	DNB operational hardware-wise
DNB Hardware Status	Flashing Red	minor hardware fault
Devicenet Network Status	Steady OFF	DeviceNet not powered / Not on-line
Devicenet Network Status	Steady Green	link OK, on-line, connected
Devicenet Network Status	Steady Red	Devicenet critical link failure
Devicenet Network Status	Flashing Green	DeviceNet on-line, not connected*
Devicenet Network Status	Flashing Red	connection timeout with scanner
Scale Communication Status	Steady Green	scale communications OK
Scale Communication Status	Steady Red	no scale communications **
DNB Software Status	Steady Green	DNB internal software operational
DNB Software Status	Steady Red	DNB internal software faulted

Table 17 External Module and Network Status Indication LEDs

* Note- DNB may not be in scan list, open network commissioning tool and add to scanlist.

**Note- Refer to table 4.2.2 to confirm terminal port parameters.



METTLER TOLEDO

1900 Polaris Parkway
Columbus, Ohio 43240

Phone: (US and Canada) (800) 786-0038
(614) 438-4511

Phone: (International) (614) 438-4888

www.mt.com/service

**P/N: D16159300A
(05/06).00**

METTLER TOLEDO® is a registered trademark of Mettler-Toledo, Inc.
©2006 Mettler-Toledo, Inc.
Printed in USA

