

# Operating Instructions

METTLER TOLEDO

## METTLER TOLEDO

## Excellence Plus XP Analytical Balances





# Overview of your excellence plus XP analytical balance

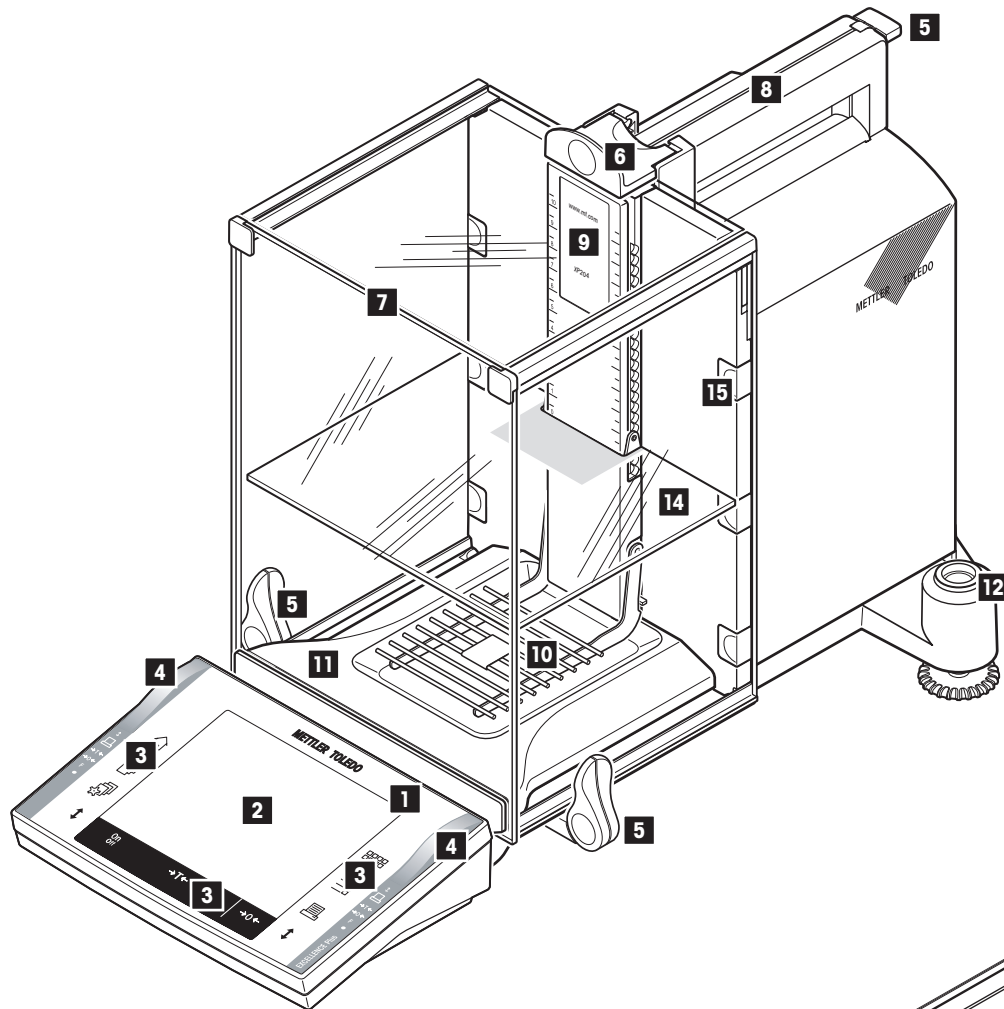

- 1 Terminal (for details s. Section 4)
- 2 Display (Touch-sensitive "Touch Screen")
- 3 Operating keys
- 4 SmartSens sensors
- 5 Handle/Coupling element for the operation of the draft-shield doors
- 6 Handle for operation of the draft-shield top door
- 7 Glass draft shield
- 8 Guide for top door of draft shield and handle for transport
- 9 Type name
- 10 Grid weighing pan
- 11 Drip tray
- 12 Level indicator / Level sensor
- 13 Fastening point for anti-theft device
- 14 Intermediate shelf
- 15 Removable clips for feeding cables or hoses

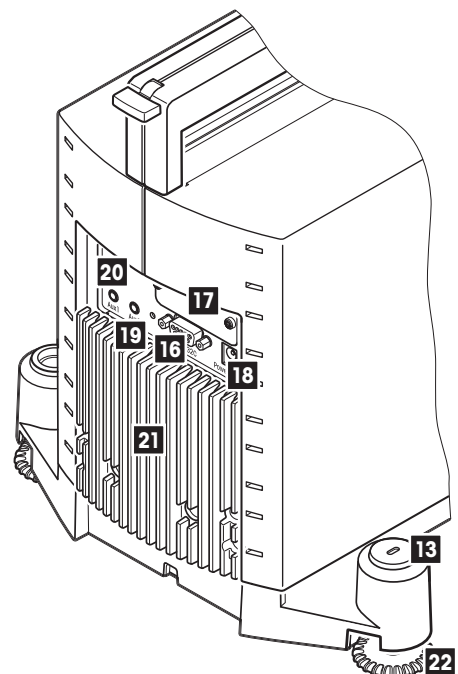

- 16 RS232C serial interface
- 17 Slot for second interface (optional)
- 18 Socket for AC adapter
- 19 Aux 1 (connection for "ErgoSens", hand- or foot-switch)
- 20 Aux 2 (connection for "ErgoSens", hand- or foot-switch)
- 21 Cooling element (based on model)
- 22 Leveling screw

# Contents

<b>1</b>	<b>Getting to know your balance .....</b>	<b>10</b>
1.1	Introduction .....	10
1.2	Introducing the XP analytical balances .....	10
1.3	Conventions and symbols used in these operating instructions .....	10
1.4	Safety first .....	11
<b>2</b>	<b>Setting up the balance .....</b>	<b>12</b>
2.1	Unpacking and checking the delivered items .....	12
2.1.1	Unpacking the balance .....	12
2.1.2	Checking the delivered items .....	14
2.2	Assembling the balance .....	14
2.2.1	Intermediate shelf draft shield .....	17
2.3	Selecting a location .....	18
2.4	Power supply .....	18
2.5	Operating of the glass draft shield .....	19
2.6	Setting the reading angle and location of the terminal .....	20
2.6.1	Setting the reading angle .....	20
2.6.2	Remove terminal and place close to the balance .....	20
2.7	Transporting the balance .....	21
2.7.1	Transporting over short distances .....	21
2.7.2	Transporting over long distances .....	21
2.8	Below-the-balance weighing .....	24
2.9	Installing the single-use aluminum weighing pan .....	24
2.10	Installing the ErgoClip .....	25
2.11	Installing the grid weighing pan cover .....	25
<b>3</b>	<b>Your first weighing .....</b>	<b>26</b>
3.1	Switching the balance on and off .....	26
3.2	Leveling the balance .....	26
3.3	Performing a simple weighing .....	28
<b>4</b>	<b>Basic principles for using the terminal and the software .....</b>	<b>29</b>
4.1	Overview of the terminal .....	29
4.2	The display .....	30
4.3	The software for your balance .....	31
4.4	Typical operating sequence .....	34
4.5	The security system of your balance .....	35
<b>5</b>	<b>System settings .....</b>	<b>36</b>
5.1	Calling up the system settings .....	36
5.2	Overview of the system settings .....	36
5.3	Settings for adjustment and tests .....	37
5.3.1	Specifications for displaying recorded adjustment operations (adjustment history) .....	37
5.3.2	"ProFACT" fully automatic adjustment function .....	38
5.3.3	Automatic adjustment using an external adjustment weight .....	39
5.3.4	Defining external adjustment weights .....	39
5.3.5	Automatic adjustment testing using an external test weight .....	40
5.3.6	Defining external test weights .....	40
5.3.7	Defining adjustment and test reports .....	41
5.4	Balance Information .....	42

5.5	Standby (energy-saving function) .....	42
5.6	Date and time .....	43
5.7	Selecting peripheral devices .....	44
5.8	Configuring the security system .....	46
5.8.1	Changing the administrator ID and password .....	47
5.8.2	Performing a global balance reset .....	47
5.8.3	Defining user access rights .....	47
5.8.4	Recording security-related operations .....	48
5.8.5	Reminder function for changing the password .....	49
5.8.6	Specifying the number of users .....	49
5.9	Settings for the level sensor .....	50
5.10	Printing the system settings .....	51
<b>6</b>	<b>User settings .....</b>	<b>52</b>
6.1	Calling up user-specific settings .....	52
6.2	Overview of the user-specific settings .....	52
6.3	Defining weighing parameters .....	52
6.4	Entering user data .....	54
6.5	Settings for the doors of the glass draft shield .....	55
6.6	Terminal settings .....	56
6.7	Resetting user profile settings .....	58
6.8	Printing user-specific settings .....	58
<b>7</b>	<b>The "Weighing" application .....</b>	<b>59</b>
7.1	Selecting the application .....	59
7.2	Settings for the "Weighing" application .....	59
7.2.1	Overview .....	59
7.2.2	Selecting function keys .....	61
7.2.3	Selecting "SmartTrac" .....	62
7.2.4	Selecting information fields .....	62
7.2.5	Specifications for automatic record printing .....	63
7.2.6	Selecting weighing units .....	63
7.2.7	Defining custom weighing units .....	64
7.2.8	Defining the record .....	64
7.2.9	Specifications for manual record printing .....	67
7.2.10	Formatting the output data .....	68
7.2.11	Defining IDs and record titles .....	70
7.2.12	Specifications for processing bar code data .....	71
7.2.13	Specifications for processing keyboard entries .....	72
7.2.14	Settings for the "MinWeigh" function .....	72
7.2.15	Defining and activating the tare memory .....	73
7.2.16	Settings for the automatic tare function .....	74
7.2.17	Settings for SmartSens and ErgoSens .....	74
7.2.18	Settings for the optional antistatic kit .....	75
7.3	Working with the "Weighing" application .....	75
7.3.1	Changing the resolution of the weighing result .....	75
7.3.2	Tare options .....	76
7.3.3	Working with the item counter .....	77
7.3.4	Working with IDs .....	77
7.3.5	Weighing to a nominal value .....	79

7.3.6	Working with the "MinWeigh" function.....	80
7.4	Adjusting the balance and testing adjustments.....	81
7.4.1	ProFACT fully automatic adjustment .....	81
7.4.2	Adjustment using the internal weight .....	81
7.4.3	Adjustment using an external weight.....	82
7.4.4	Testing adjustments using an internal weight .....	83
7.4.5	Testing adjustments using an external weight.....	84
7.4.6	Adjustment and test printouts (sample printouts).....	84
<b>8</b>	<b>The "Statistics" application.....</b>	<b>86</b>
8.1	Introduction to the "Statistics" application.....	86
8.2	Selecting the application.....	86
8.3	Settings for the "Statistics" application .....	86
8.3.1	Overview.....	86
8.3.2	Special function keys for use with the statistics.....	87
8.3.3	Special information fields for the statistics.....	87
8.3.4	Specifications for automatic weight transfer .....	88
8.3.5	Special record information for the statistics .....	88
8.3.6	Activating additive mode .....	90
8.3.7	Defining plausibility limits.....	90
8.3.8	Settings for the LV11 automatic feeder.....	90
8.4	Working with the "Statistics" application .....	91
8.4.1	Statistical acquisition of series weighing values.....	91
8.4.2	Weighing to a nominal value .....	93
8.4.3	Sample printout with statistical values.....	94
8.4.4	Formulas used for calculating statistical values .....	95
<b>9</b>	<b>The "Formulation" application.....</b>	<b>96</b>
9.1	Introduction to the "Formulation" application.....	96
9.2	Selecting the application.....	96
9.3	Settings for the "Formulation" application.....	96
9.3.1	Overview.....	96
9.3.2	Activating/deactivating automatic zeroing .....	97
9.3.3	Special function keys for Formulation.....	98
9.3.4	Special information fields for Formulation.....	98
9.3.5	Special record information for Formulation.....	99
9.3.6	Special identifications for Formulation.....	101
9.3.7	Special SmartSens and ErgoSens settings for Formulation .....	101
9.4	Defining components .....	102
9.5	Defining and activating formulae .....	103
9.5.1	Formulae with "Fixed Components" (absolute nominal weights) .....	103
9.5.2	Formulae with "% components" (relative nominal value) .....	104
9.5.3	Printing the formula definitions .....	105
9.6	Working with the "Formulation" application .....	106
9.6.1	Presettings.....	106
9.6.2	Free formulation (formulation without using the formula database).....	107
9.6.3	Automatic formula processing with "Fix Components" (absolute nominal weights) .....	108
9.6.4	Automatic formula processing with "% Components" (relative nominal values).....	110
9.6.5	Sample printout of a formulation .....	111
9.7	Notes on changing existing components and formulae.....	112

<b>10</b>	<b>The “Piece Counting” application .....</b>	<b>113</b>
10.1	Introduction to the “Piece Counting” application .....	113
10.2	Selecting the application .....	113
10.3	Settings for the “Piece Counting” application .....	113
10.3.1	Overview.....	113
10.3.2	Specifying the fixed reference piece number .....	114
10.3.3	Special Function Keys for piece counting .....	115
10.3.4	Special information fields for piece counting .....	115
10.3.5	Specifications for automatic weight transfer .....	116
10.3.6	Additional unit for piece counting .....	116
10.3.7	Special printout information for piece counting .....	117
10.3.8	Special SmartSens and ErgoSens settings for piece counting.....	118
10.4	Working with the “Piece Counting” application .....	119
10.4.1	Simple piece counting .....	119
10.4.2	Totaling piece counts and recording them statistically.....	120
10.4.3	Counting to a nominal value.....	122
10.4.4	Reference optimizing .....	123
10.4.5	Sample printout of a piece count with statistical values .....	124
<b>11</b>	<b>The “Percent Weighing” application.....</b>	<b>125</b>
11.1	Introduction to the “Percent Weighing” application .....	125
11.2	Selecting the Application .....	125
11.3	Settings for the “Percent Weighing” application.....	125
11.3.1	Overview.....	125
11.3.2	Special Function Keys for Percent Weighing.....	126
11.3.3	Special Information Fields for Percent Weighing .....	127
11.3.4	Additional Unit for Percent Weighing .....	127
11.3.5	Special Information for Percent Weighing .....	127
11.3.6	Special Settings of SmartSens and ErgoSens for Percent Weighing.....	129
11.4	Working with the “Percent Weighing” Application .....	129
11.4.1	Simple Percent Weighing.....	129
11.4.2	Percent Weighing to a Target Value.....	130
11.4.3	Example of a percent weighing report .....	131
<b>12</b>	<b>The “Density” application .....</b>	<b>132</b>
12.1	Introduction to the “Density” application .....	132
12.2	Selecting the Application .....	132
12.3	Settings for the “Density” application .....	133
12.3.1	Overview.....	133
12.3.2	Selecting the method for density determination.....	133
12.3.3	Selecting the auxiliary liquid.....	134
12.3.4	Activating and deactivating statistics.....	134
12.3.5	Settings for calculating and displaying the result .....	134
12.3.6	Special function keys for density determination .....	135
12.3.7	Special information fields for density determination .....	136
12.3.8	Special report information for density determination.....	136
12.3.9	Special SmartSens and ErgoSens settings for density determination.....	138
12.4	Working with the “Density” application .....	139
12.4.1	Density determination of non-porous solid bodies .....	139
12.4.2	Density determination of liquids using a sinker.....	140
12.4.3	Density determination of pasty substances using a gamma sphere .....	141

12.4.4	Determining the density of liquids using a pycnometer .....	142
12.4.5	Determining the density of porous solid bodies .....	143
12.4.6	Example of a density determination report .....	144
12.5	Using the density statistics.....	145
12.6	Formulae used to calculate density.....	147
12.6.1	Formulae for determining the density of solid bodies .....	147
12.6.2	Formulae for determining the density of liquids and pastes.....	147
12.7	Density table for distilled water .....	148
12.8	Density table for ethanol.....	148
<b>13</b>	<b>The "Differential Weighing" Application .....</b>	<b>149</b>
13.1	Introduction to the "Differential Weighing" Application.....	149
13.2	Selecting the Application .....	149
13.3	Settings for the "Differential Weighing" Application.....	150
13.3.1	Overview.....	150
13.3.2	Specific Function Keys for Differential Weighing .....	151
13.3.3	Specific Information Fields for Differential Weighing.....	151
13.3.4	Specific Protocol Information for Differential Weighing .....	152
13.3.5	Print Key Behavior .....	154
13.3.6	Special setting for processing barcode data .....	154
13.4	Defining, Editing, Deleting, and Selecting a Series .....	155
13.4.1	Defining a New Series .....	155
13.4.2	Editing an Existing Series.....	156
13.4.3	Deleting a Series.....	156
13.4.4	Selecting a Series for Differential Weighing .....	156
13.5	Using the "Differential Weighing" Application .....	157
13.5.1	The Different Methods of Differential Weighing .....	157
13.5.2	Default Settings .....	158
13.5.3	Differential Weighing: Automatic Procedure .....	159
13.5.4	Differential Weighing: Manual Procedure .....	162
13.5.5	Printing the Results of Differential Weighing .....	162
13.5.6	Additional Options.....	163
13.6	Formulae Used for Calculating the Results of Differential Weighing.....	164
<b>14</b>	<b>The "LabX Client" application .....</b>	<b>165</b>
14.1	Introduction to the "LabX Client" application .....	165
14.2	Selecting the application.....	165
<b>15</b>	<b>Software updates.....</b>	<b>166</b>
15.1	Operating principle .....	166
15.2	Requirements .....	166
15.3	Loading software updates from the Internet.....	166
15.4	Loading the new software into the balance.....	167
15.5	Saving and reloading balance settings.....	169
<b>16</b>	<b>Error and status messages .....</b>	<b>170</b>
16.1	Error messages occurring during normal operation .....	170
16.2	Further error messages .....	170
16.3	Status messages.....	171
<b>17</b>	<b>Cleaning and service .....</b>	<b>172</b>



---

<b>18</b>	<b>Technical data and accessories .....</b>	<b>173</b>
18.1	General data.....	173
18.1.1	Explanatory notes for the METTLER TOLEDO AC adapter .....	174
18.2	Model-specific data.....	175
18.2.1	Zero-setting range and switch-on zero range for certified balances.....	177
18.3	Dimensions of the XP analytical balances .....	178
18.4	Specifications of the RS232C interface.....	179
18.5	Specification of the "Aux" connections .....	179
18.6	MT-SICS Interface commands and functions.....	180
18.7	Accessories .....	182
<b>19</b>	<b>Appendix .....</b>	<b>185</b>
19.1	Conversion table for weight units .....	185
19.2	SOPs - standard operating procedures .....	186
<b>20</b>	<b>Index .....</b>	<b>188</b>

# 1 Getting to know your balance

In this Section you will be given basic information about your balance. Please read right through this chapter carefully even if you already have experience with METTLER TOLEDO balances; please pay special attention to the safety warnings!

## 1.1 Introduction

Thank you for choosing a METTLER TOLEDO balance

The analytical balances of the XP line combine a large number of weighing and adjustment possibilities with exceptionally convenient operation. With these balances software updates can be downloaded from the Internet and loaded into the balance.

These operating instructions apply to all analytical balances in the XP lines. However, the different models have different characteristics regarding equipment and performance. Special notes in the text indicate where this makes a difference to operation.

## 1.2 Introducing the XP analytical balances

The XP family of analytical balances comprises a range of analytical balances which differ from each other in relation to their weighing range and resolution.

The following features are common to all models of the XP lines:

- Glass draft shield with motorized opening for precise weighing even in unstable environments.
- Fully automatic adjustment "ProFACT" using internal weights.
- Built-in level sensor, illuminated level indicator and Leveling Assistant for fast and easy leveling.
- Built-in applications for normal weighing, statistics, formulation, piece counting, percent weighing, density, differential weighing and LabX Client.
- Integral RS232C interface.
- Touch-sensitive graphics terminal ("TouchScreen") with color display.
- Two programmable sensors for hands-off operation ("SmartSens") to speed up frequently recurring tasks.

A brief word about standards, guidelines, and methods of quality assurance: The XP analytical balances comply with usual standards and guidelines. They support standard procedures, specifications, working methods, and reports according to **GLP (Good Laboratory Practice)**, and allow the creation of **SOPs (Standard Operating Procedure)**. In this connection, records of working procedures and adjustments become very important; for this purpose we recommend you to use a printer from the METTLER TOLEDO range, since these are optimally adapted to your balance. The XP analytical balances conform to the applicable standards and guidelines and possess a EC declaration of conformity. METTLER TOLEDO is certified as manufacturer according to ISO 9001 and ISO 14001.

## 1.3 Conventions and symbols used in these operating instructions

The following conventions apply throughout these operating instructions:

- Key designations are indicated by double angular parentheses (e.g. «**On/Off**» or «»).

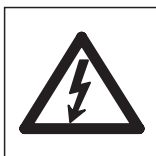

These symbols indicate safety notes and hazard warnings which, if ignored, can cause personal danger to the user, damage to the balance or other equipment, or malfunctioning of the balance.

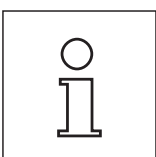

This symbol indicates additional information and notes. These make working with your balance easier, as well as ensuring that you use it correctly and economically.

## 1.4 Safety first

Always operate and use your balance only in accordance with the instructions contained in this manual.

The instructions for setting up your new balance must be strictly observed.

**If the instrument is not used according to the manufacturer's Operating Instructions, protection of the instrument may be impaired.**

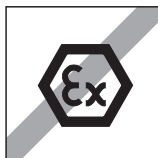

It is not permitted to use the balance in hazardous environments.

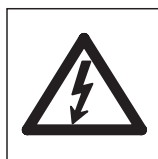

Use only the AC adapter delivered with your balance, and check that the voltage printed on it is the same as your local power supply voltage. Only plug the adapter into a socket which is grounded.



Do not use sharply pointed objects to operate the keyboard of your balance!

Although your balance is very ruggedly constructed, it is nevertheless a precision instrument. Treat it with corresponding care.

Do not open the balance: It does not contain any parts which can be maintained, repaired, or replaced by the user. If you ever have problems with your balance, contact your METTLER TOLEDO dealer.

Use only balance accessories and peripheral devices from METTLER TOLEDO; they are optimally adapted to your balance.

### Disposal



In conformance with the European Directive 2002/96/EC on Waste Electrical and Electronic Equipment (WEEE) this device may not be disposed of in domestic waste. This also applies to countries outside the EU, per their specific requirements.

Please dispose of this product in accordance with local regulations at the collecting point specified for electrical and electronic equipment.

If you have any questions, please contact the responsible authority or the distributor from which you purchased this device.

Should this device be passed on to other parties (for private or professional use), the content of this regulation must also be related.

Thank you for your contribution to environmental protection.

## 2 Setting up the balance

This Section explains how to unpack your new balance, and how to set it up and prepare it for operation. When you have carried out the steps described in this Section, your balance is ready for operation.

### 2.1 Unpacking and checking the delivered items

#### 2.1.1 Unpacking the balance

Use the lifting strap to lift the balance out of the packaging carton.

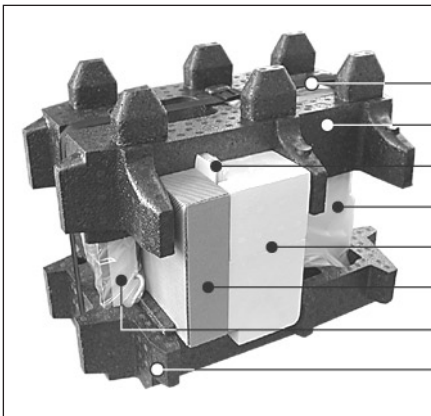

**Overview:**

- a Lifting strap
  - b Top packing cushion
  - c Operating Instructions and other important documents
  - d Balance
  - e Set with draft-shield doors, intermediate shelf and terminal support
  - f Set with AC adapter, power supply cable, drip tray, grid weighing pan, grid weighing pan cover, set of single-use pans and basket
  - g Terminal
  - h Bottom packing cushion
- Note:** The terminal is connected to the balance by a cable!

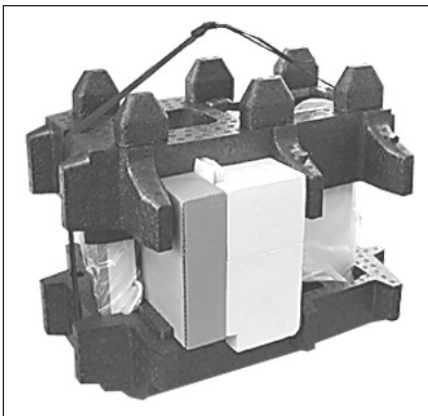

- Unfasten lifting strap (a)
- Remove top packing cushion (b)

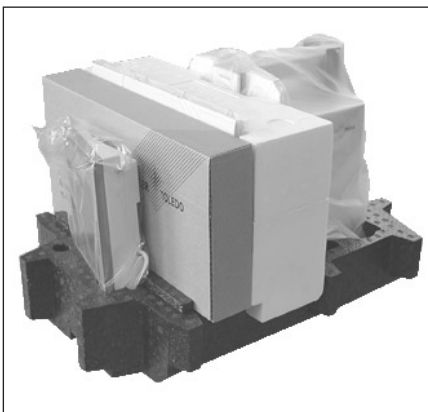

- Pull out Operating Instructions (c)
- Remove set with AC adapter etc. (f)
- Remove set with draft-shield doors etc. (e)



The terminal is connected to the balance by a cable, so only pull the terminal just far enough out of the packing cushion to remove the protective cover.

- Carefully pull the terminal out of the bottom packing cushion and remove the protective cover.



- Place the terminal on the front of the balance.

- Hold the balance by the guide or handle, hold the terminal firmly with your other hand, and pull the balance and terminal together out of the bottom packing cushion.



- Place the balance with the terminal in the place where the balance will be used for weighing.
- Remove the cover from the balance.
- Pull the transport protection (i) of the weighing pan support toward the front and off.



Please keep all parts of the packaging. This packaging guarantees best possible protection of your balance for transportation (Section 2.7).

## 2.1.2 Checking the delivered items

The standard scope of delivery contains the following items:

- XP analytical balance with terminal
- Set with draft-shield doors, intermediate shelf and terminal support
- Grid weighing pan
- Grid weighing pan cover of chrome-nickel steel (attachment for grid weighing pan)
- Set of single-use aluminum weighing pans (10 pans) for mounting on the grid weighing pan
- Basket
- Drip tray
- AC adapter with country-specific power cable
- Protective cover for the terminal
- Cleaning brush
- Production certificate
- EC declaration of conformity
- Operating Instructions (this document)
- Instructions for unpacking, re-packing, and setting up
- ErgoClip "Basket small"

## 2.2 Assembling the balance

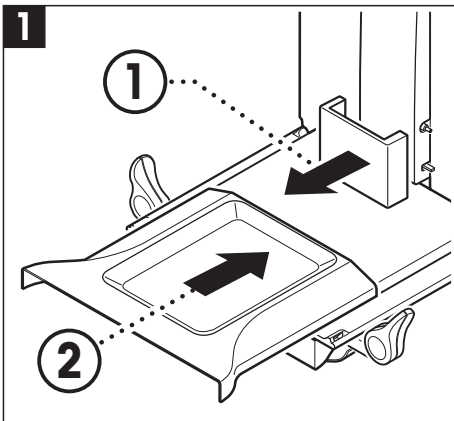

- Remove the transport protection.
- Insert the drip tray.  
Push the tray in from the front over the bottom plate as far as the partition.

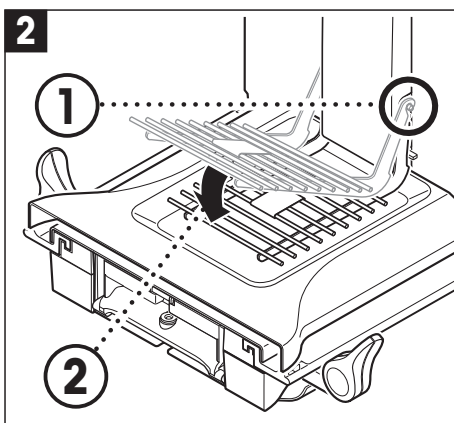

- Insert the grid weighing pan from the front.  
Check that the grid weighing pan is correctly hooked in at both sides.

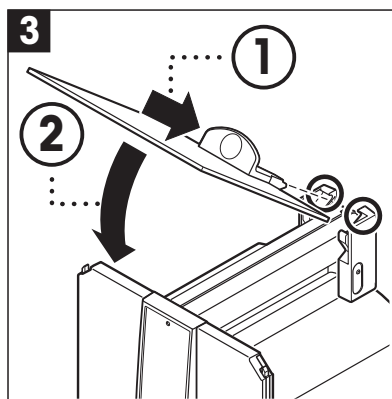

- Insert the top door of the draft shield at an angle (slightly less than 30 degrees) into the guide positioned at the back, and swivel the draft-shield door carefully down (see Fig. 3).



The handles (A) must be turned toward the outside to allow installation of the side draft shield doors!

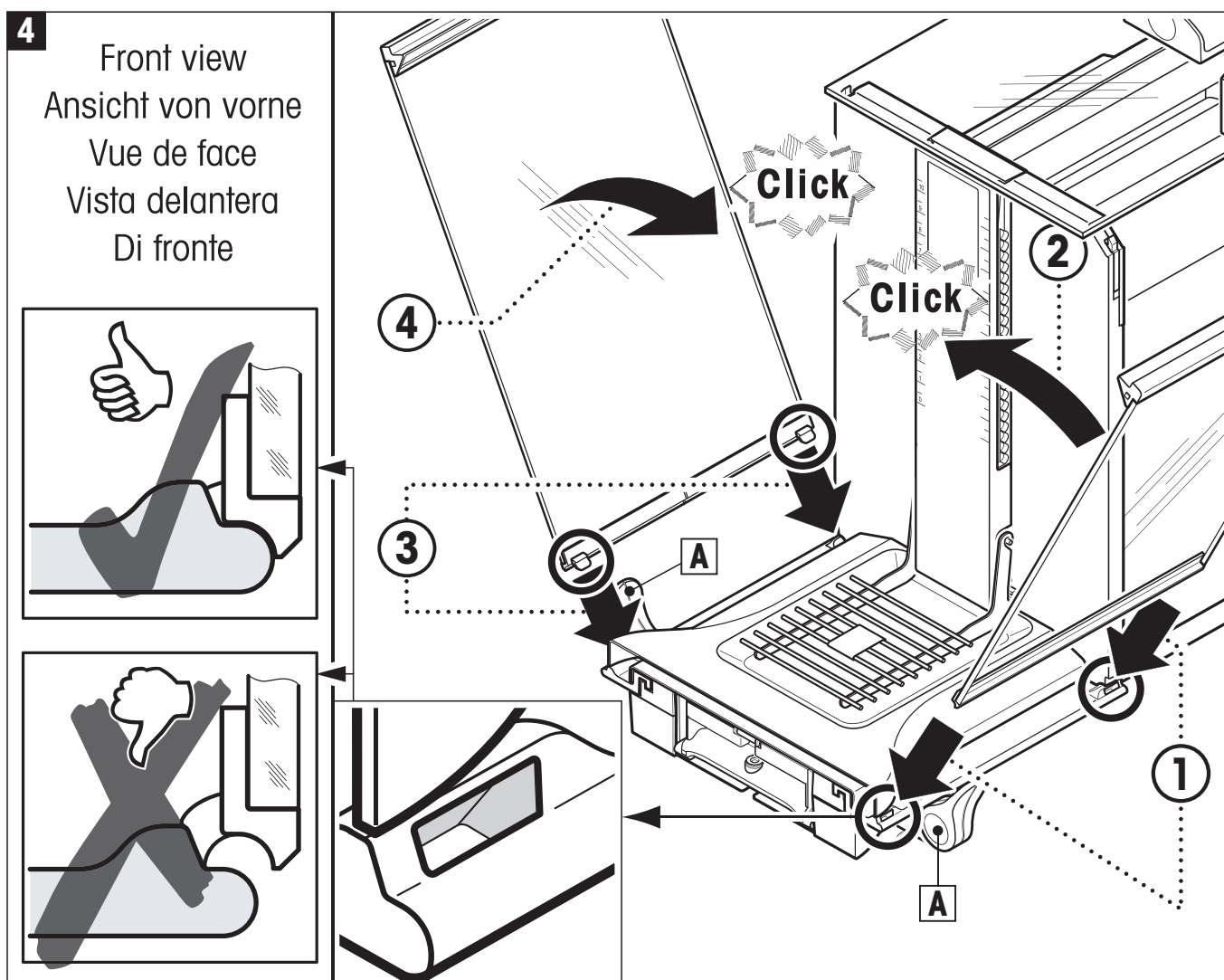

- Insert the side doors of the draft shield according to the following instructions (see Fig. 4):



- Insert the side door at an angle of approx. 30° into the 2 openings (see figure for details). Check that the side door is correctly inserted as shown in the "View from the front"!
- Swivel the side door up against the balance until it engages with a click.
- The side door must run **easily**, otherwise it is not correctly inserted.

- Insert the second side door of the draft shield. The procedure is identical.
- Push the side doors completely to the back.

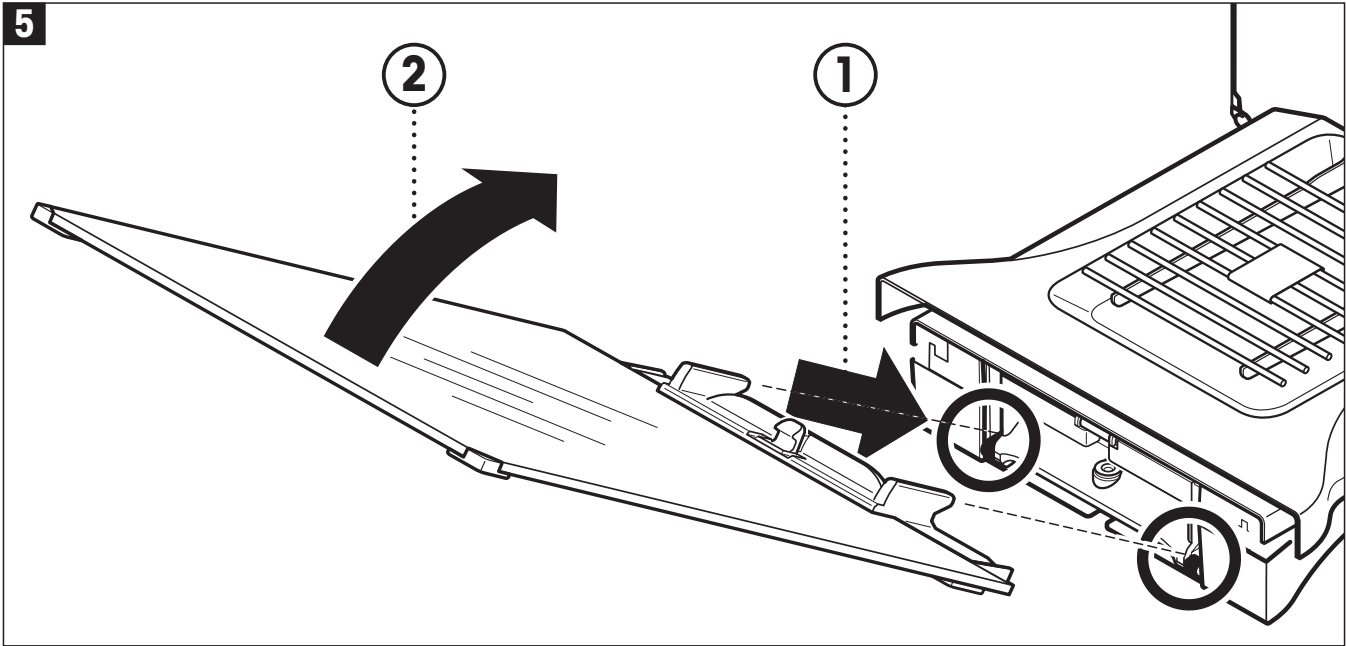

- Insert the front glass of the draft shield:
  - In the bottom part of the balance at the front, move at an angle from the top toward the bottom until the two hooks of the front glass of the draft shield lie on the rollers.
  - Swivel the front glass of the draft shield up until it engages.

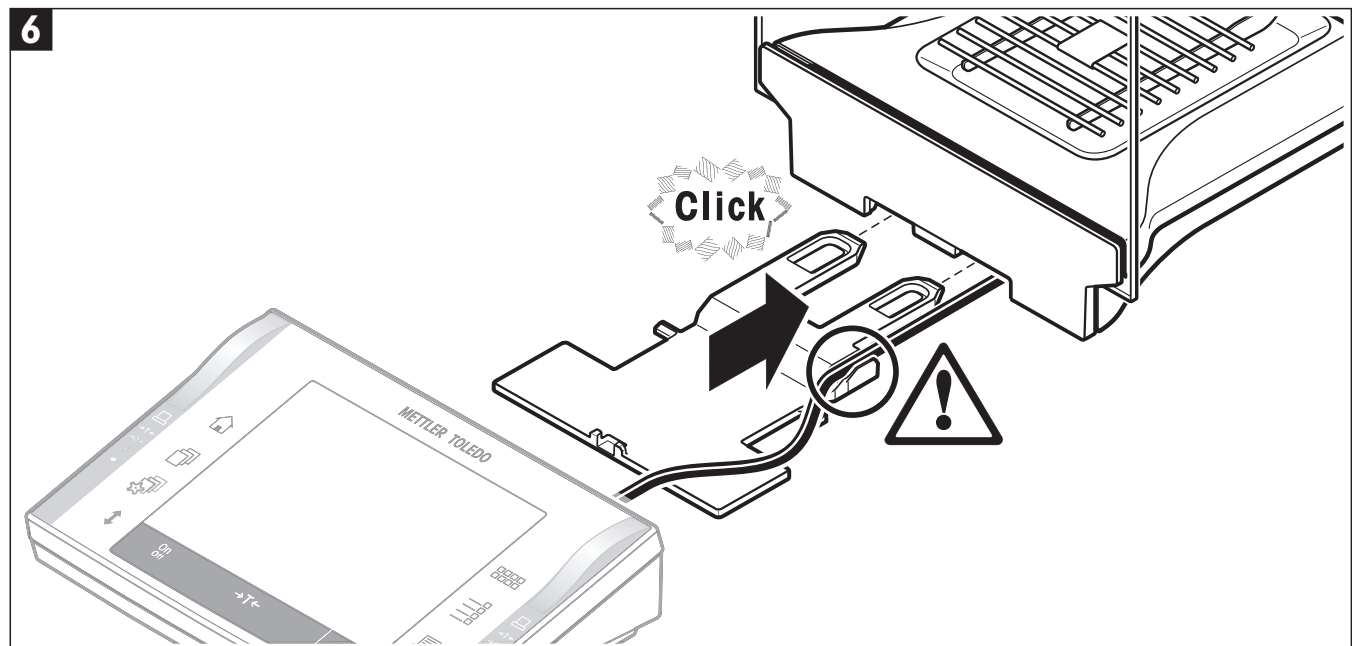

- Insert the terminal support:
  - First lay the cable in the guide by the terminal support.
  - Insert the terminal support into the opening of the front glass of the draft shield.



The terminal support must engage with a click.



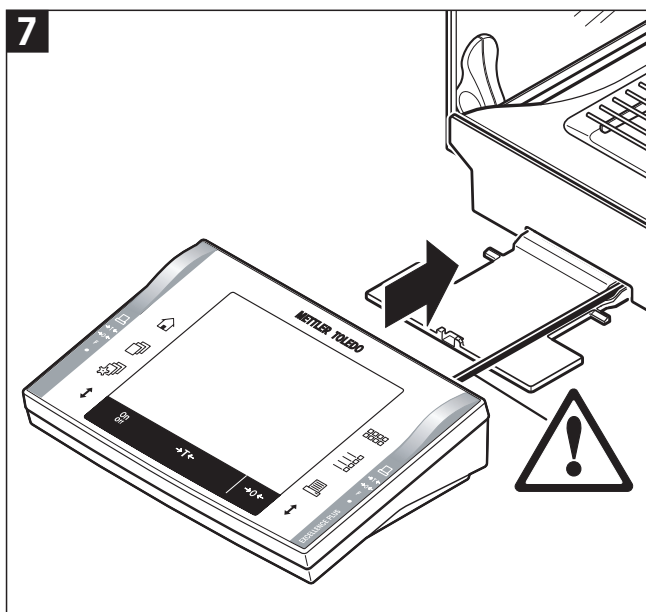

- Mount the terminal:
  - Place the terminal in the center of the support and push it against the balance until it swivels slightly down at the front by the terminal support.

**Note:** You can push the cable into the balance.



The balance and the terminal are not fastened together by the terminal support! When transporting by hand, always hold the balance and the terminal firmly (see Section 2.7).



**Note:** You can also place the terminal free of the terminal support anywhere around the balance where the length of the cable allows.

## 2.2.1 Intermediate shelf draft shield

You can use the intermediate shelf to reduce the volume of the weighing chamber so that the balance shows the result faster. You also have the option of acclimatizing the weighing material on the intermediate shelf.

### Inserting the intermediate shelf:

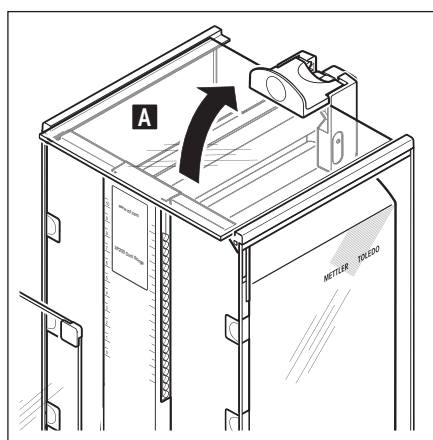

- Open all draft shield doors.
- Raise the front of the top draft shield door (A) and pull it out of the guide. Lay the top draft shield door on a clean surface.

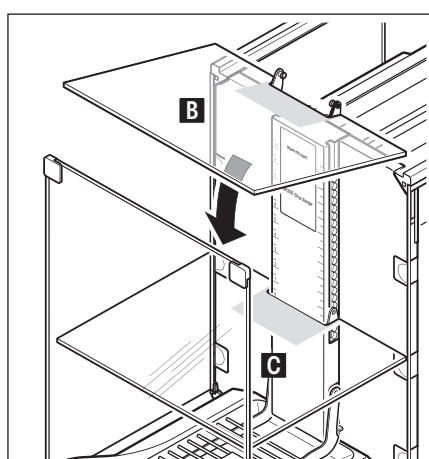
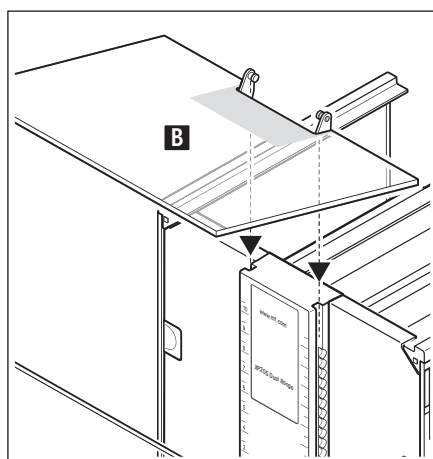

- From the top, guide the intermediate shelf (B) into the guides of the middle guiderail and position it at the desired height (C).
- Re-insert the top draft shield door (A) (Chapter 2.2)

## 2.3 Selecting a location

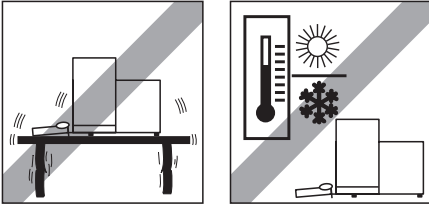

Choose a position which is stable, free from vibration, and as nearly horizontal as possible. The supporting surface must be able to bear the weight of the fully loaded balance safely.

Pay attention to the environmental conditions (Section 18.1).

Avoid:

- Direct sunlight
- Strong drafts (e.g. from fans or air conditioning)
- Excessive fluctuations in temperature.

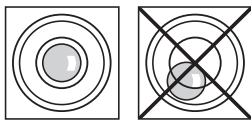
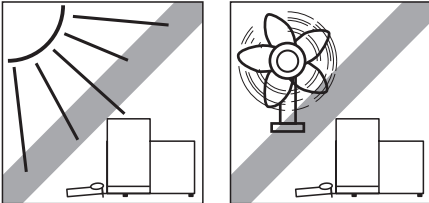

**If the balance is not horizontal from the beginning, it will have to be leveled during initial operation (see Chapter 3.2).**

## 2.4 Power supply

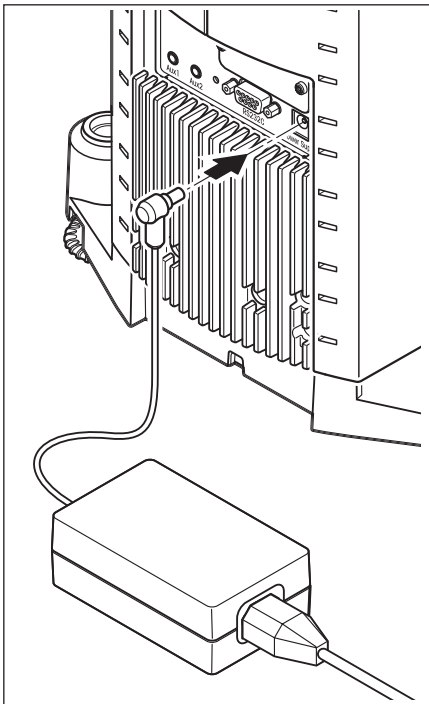

Your balance is delivered complete with an AC adapter and a country-specific power supply cable. The AC adapter is suitable for all power supply voltages in the range:

100 – 240 VAC, 50/60Hz (For exact specifications, see Chapter 18).

Check that the local power supply voltage is in this range. **If it is not, DO NOT connect the balance or the AC adapter to the power supply**, and contact your METTLER TOLEDO dealer.

Plug the AC adapter into the socket in the back of your balance (see illustration) and into the power supply.



**Important: Guide the cables so that they cannot become damaged or interfere with the weighing process! Take care that the AC adapter cannot come into contact with liquids!**

After the balance has been connected to the power supply, it carries out a self test and is then ready for operation.

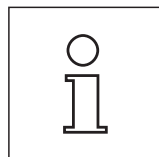
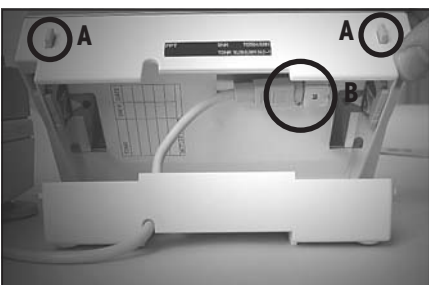

**Note:** If the display field remains dark, even though the power supply connection functions, first disconnect the balance from the power supply. Open the terminal by pressing the two buttons (A), then swivel the upper part of the terminal open and check that the cable (B) is correctly plugged in.

## 2.5 Operating of the glass draft shield

The glass draft shield of your balance can be adapted to the environmental conditions and your weighing style, as well as to the type of weighing and loading.

The doors of the glass draft shield can be opened and closed either by means of the «↕» key, the "SmartSens" sensors, or by hand (Section 4.1 and section 6.5).

Try various different combinations by moving the 3 external handles up/inside and down/outside. We recommend you to set up the glass draft shield so that it only opens on the side where the balance is loaded. Your balance then works faster, because there are fewer troublesome currents of air than when both doors of the draft shield are opened together.

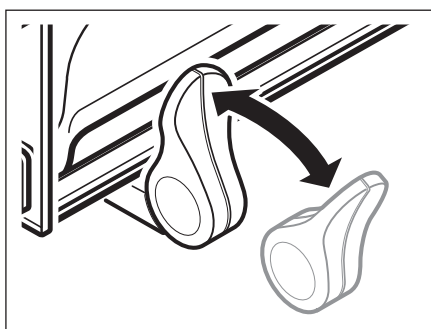

For **motorized door operation** the handles must be connected:

- Side doors: Handles turned toward the inside
- Top door: Handle down in horizontal position

For **manual door operation** the handles must be disconnected:

- Side doors: Handles turned toward the outside
- Top door: Handle up in vertical position

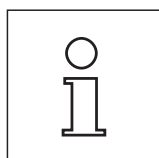

**Note:** It is best to make connections when the draft shield is closed.

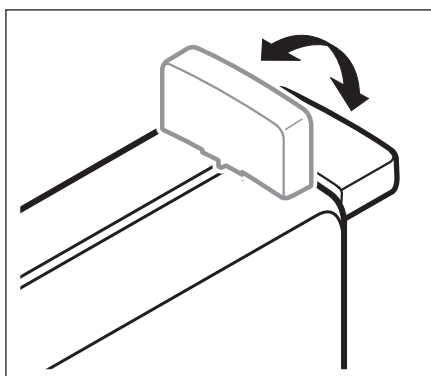

## 2.6 Setting the reading angle and location of the terminal

### 2.6.1 Setting the reading angle

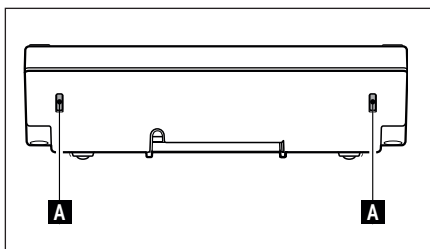

To change the reading angle, press in the two buttons (A) on the back of the terminal. The top of the terminal can then be pulled up or down until it engages in the desired position. A total of 3 setting positions are available.

### 2.6.2 Remove terminal and place close to the balance

The terminal is connected to the balance by a cable. So you can arrange your workplace optimally, the terminal can be removed from the balance and placed separately.

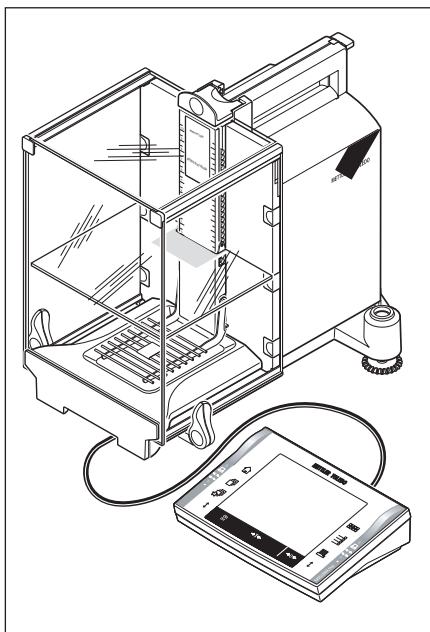

**You can also place the terminal separately** (see illustration).

- Switch the balance off.
- Carefully lift the terminal off the terminal support.  
You can leave the terminal support on the balance or remove it.
- Pull the cable carefully out from the balance as far as possible.
- Place the terminal where you want it to be.

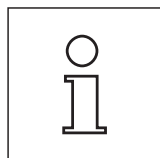

The cable can also be led out of the back of the balance. If working this way would be convenient for you, call your METTLER TOLEDO dealer who will adapt the balance for you.

## 2.7 Transporting the balance

Switch off the balance and unplug the cable of the AC adapter, as well as any interface cables, from the balance.

### 2.7.1 Transporting over short distances

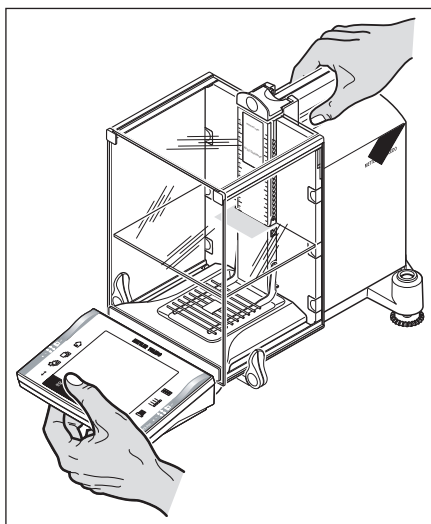

If you wish to move your balance **over a short distance** to a new location, proceed as follows:

With one hand, hold the balance by the guide for the top door of the draft shield. With your other hand, hold the terminal. Carefully lift the balance and carry it to its new location. (Observe the notes in Section 2.3 regarding the choice of an optimal location).



**The terminal is not rigidly fastened to the balance, so you must always hold the balance with one hand and the terminal with the other.**

**Never lift the balance by the glass draft shield or the cooling element, as this can cause damage!**

### 2.7.2 Transporting over long distances

If you want to transport or ship your balance over long distances, or if it is not certain that the balance will be transported upright, use the **complete original packaging**.

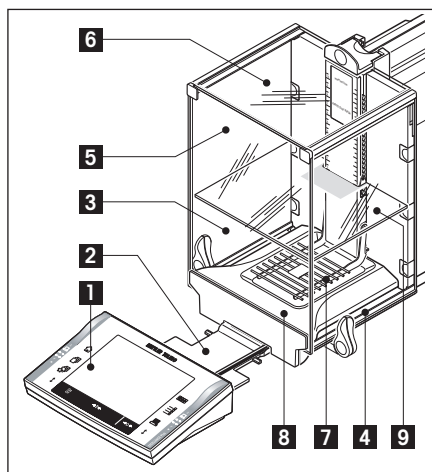

#### Disassemble the following parts:

- Lift the terminal (1) out of the terminal support and place it next to the support.
- Pull the terminal support (2) off the balance.
- Swivel the front glass (3) of the draft shield away from the balance.
- Carefully fold the side doors (4+5) of the draft shield against the respective handles and pull the side doors out of the guide.
- Swivel the front of the top door (6) of the draft shield up and pull the door out of the guide.
- Lift the front of the intermediate shelf (9) and pull it up and out.
- Carefully raise the front of the grid weighing pan (7) and lift it out of the guide.
- Pull the drip tray (8) toward the front and out.

#### Pack the draft shield, the intermediate shelf and the terminal support (Pos. 2-6 and 9)

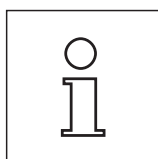

Place these parts in the compartments provided in the original packaging.

**Note:** We advise you to place a sheet of paper between the sides glasses of the draft shield

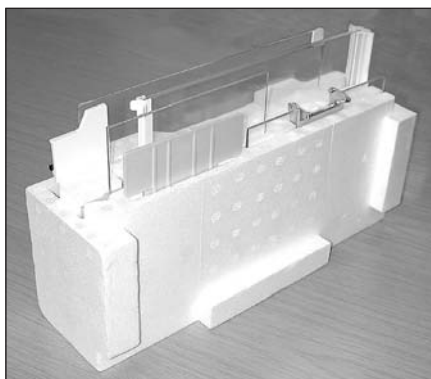



**Pack the AC adapter, the power supply cable, and the individual parts**

- Place the AC adapter and the power supply cable in the packaging.
- Place the drip tray (8) upside down in the packaging.
- Place the grid weighing pan (7) upside down on the drip tray.
- Basket



- Push the transport protection over the weighing pan guide.
- Push the guide of the top draft-shield door completely to the front.
- Swivel the handle of the side door of the draft shield upward, and also push this door completely to the front.



These instructions must be followed exactly, otherwise the balance may be damaged when inserting it into the packing cushions.

**Note:** For packing both the balance and the terminal, you have a protective cover in which they were delivered. These are deliberately not shown in the illustrations so you can see better how the individual items must be positioned. However, we recommend you to use these protective covers.



- Place the terminal on the balance (see illustration) and carefully insert the balance into the bottom packing cushion.
- Take the terminal and place it in front of othe packing cushion on the table.

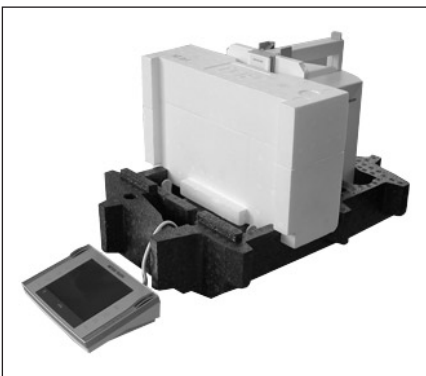

- Insert the packing set with the draft-shield glasses into the packing cushion (see illustration).

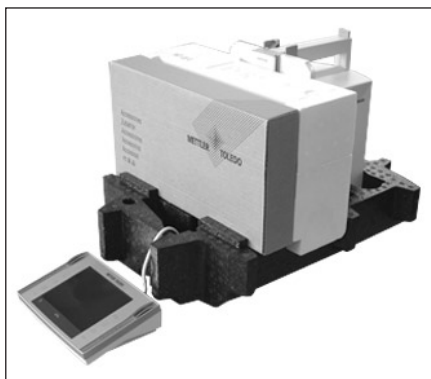

- Place the set with the AC adapter in front of the set with the draft-shield glasses.

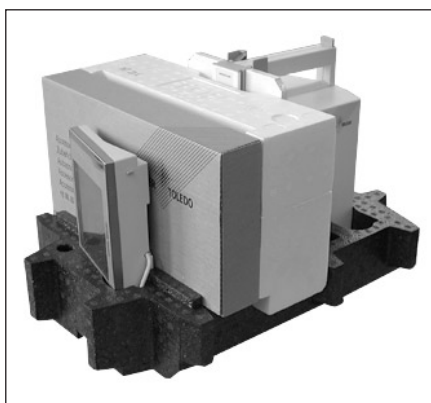

- Insert the terminal into the packing cushion as shown in the illustration.

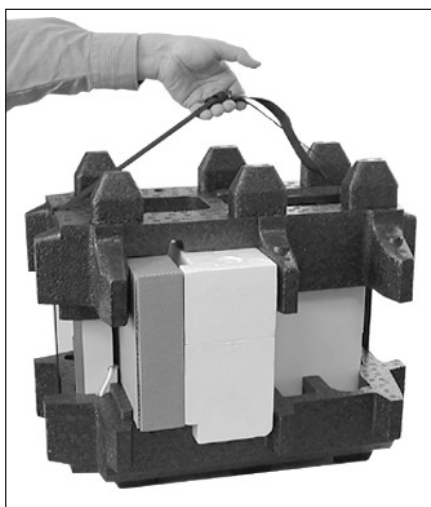

- Now put the top packing cushion in place, taking care to position it correctly.
- Pass the **lifting strap** around both packing cushions (see illustration) and tighten it until it lies close against the packaging.
- You can now lift the packed balance by the lifting strap and insert it into the transport carton.

## 2.8 Below-the-balance weighing

So that weighings can be carried out below the working surface (below-the-balance weighing), your balance is provided with a special hanger.

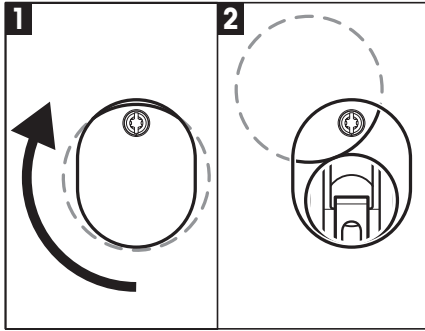

- Switch off the balance and unplug the cable of the AC adapter from the back of the balance.
- Also remove any interface cables.
- Push all the doors of the glass draft shield completely to the back.
- Lift the terminal off the terminal support. Open the terminal (see Section 2.4) and carefully pull the connecting cable out. Put the terminal down at the side of the balance.
- Pull the balance over the table edge just far enough that you see the opening (see Fig. 1) from below.
- Slacken the screw until the cover plate can be turned to the side and the hanger for weighing below the balance is easily accessible. You must now fasten the cover plate in the new position (see Fig. 2) by tightening the screw.

Then return the balance to its normal position and re-install all the components (see Section 2.2), including the terminal cable.

## 2.9 Installing the single-use aluminum weighing pan

To install the single-use aluminum weighing pan, remove the grid weighing pan from the weighing chamber (see Section 2.2).

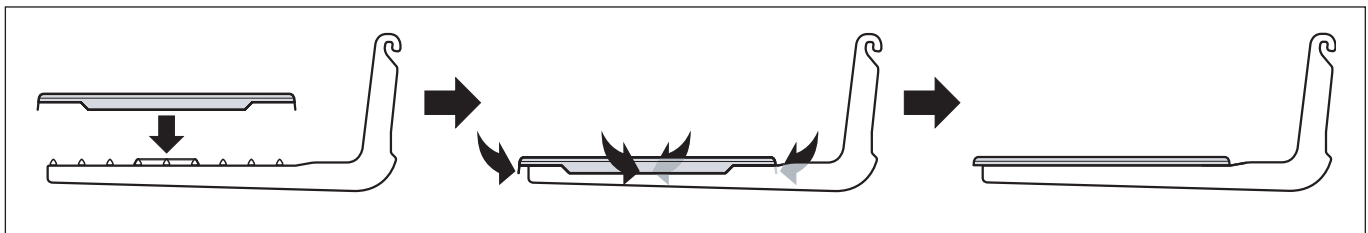

- Place the single-use aluminum weighing pan onto the grid weighing pan from above.
- Fold the 4 side flaps under the bars of the grid weighing pan.



## 2.10 Installing the ErgoClip

To install the ErgoClip included in the delivery, or an optional ErgoClip, please proceed as follows:

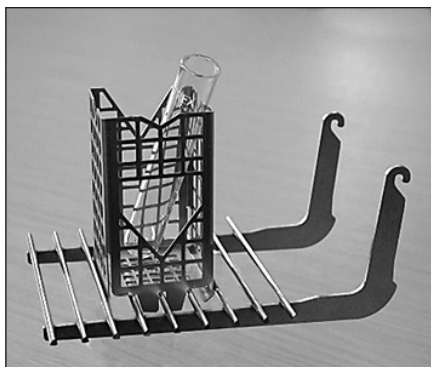

**Before you install an ErgoClip you must switch off the balance ("On/Off" key).**

- Remove the grid weighing pan (SmartGrid) from the balance.
- Snap the ErgoClip onto the grid weighing pan.
- Replace the grid weighing pan (SmartGrid) along with the installed ErgoClip.
  - The optional "flask" or "tube" ErgoClips can be inserted directly.
- Switch the balance on again ("On/Off" key).

### Important to know!

If you do not switch the balance off before you do the installation, the FACT function is not activated.

**Reason:** Addition of the ErgoClip causes the dead-load tolerance range of the balance to be exceeded. The balance therefore does not activate FACT, so as not to interrupt the **assumed** weighing operation.



When this status icon appears in the display, it means: "The balance wants to execute FACT" but cannot.

## 2.11 Installing the grid weighing pan cover

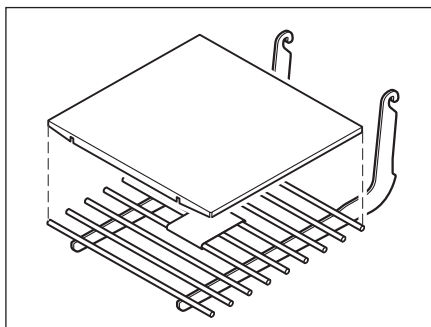

- For the installation, remove the grid weighing pan from the weighing chamber.
- Gently press the cover onto the grid weighing pan.

## 3 Your first weighing

This Section explains how to perform simple weighings using just a few keys.

### 3.1 Switching the balance on and off



**Switching on the balance:** Press the «On/Off» key briefly. The balance carries out a test and is then ready to weigh.

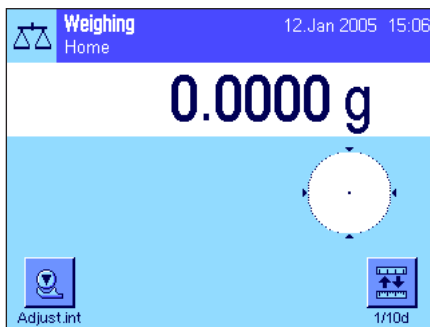

The display opposite appears when the balance is switched on **for the first time**.

**Note:** If the balance has not been set up exactly horizontally, a warning text will appear shortly after the balance is turned on, prompting you to level the balance. This step is described in Chapter 3.2.

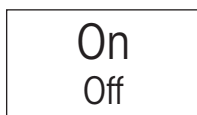

**Switching off the balance:** Press and hold the «On/Off» key until the message "OFF" appears in the display. The display then fades and the balance is switched off.

### 3.2 Leveling the balance

Your balance has a built-in level sensor, that constantly checks the correct horizontal alignment and prompts you to make an adjustment, if necessary.

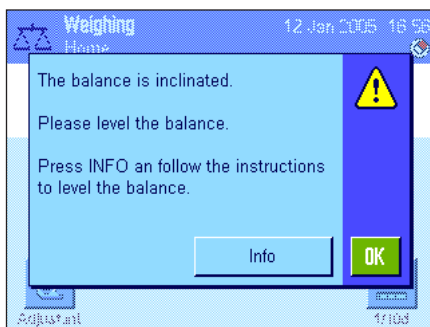

When the level sensor detects that the level is incorrect, the warning text at left will appear and a warning beep will sound. A status icon will also appear in the upper right-hand corner of the display (below the time).

To level the balance, press the "Info" button. This will start the Leveling Assistant. The Leveling Assistant will guide you step by step through the leveling process.

If you press "OK" instead, the balance will return to the weighing operation. The status icon, however, will continue to be displayed, and the warning text will reappear after 15 minutes.

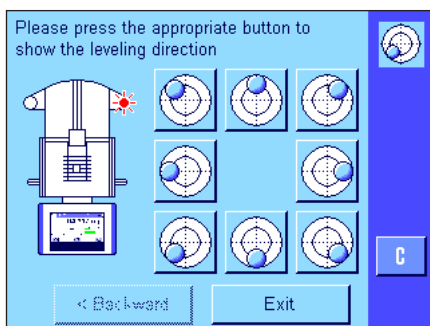

Watch the level indicator on your balance (this will light up when the level sensor is switched on) and press the button that matches the current position of the air bubble in the level indicator.

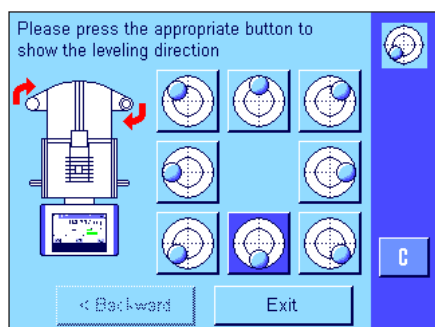

The Leveling Assistant will show you with red arrows which direction you need to turn the two footscrews on the back of the balance.

Turn the footscrew(s) in the direction indicated until the air bubble is in the inner circle of the level indicator. If you are unable to do this on your first attempt, you can press the button again that matches the current position of the air bubble at any time.

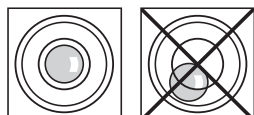

As soon as the air bubble is in the inner circle of the level indicator, the balance has been leveled correctly (left figure = leveled correctly, right figure = leveled incorrectly).

Press the **"Exit"** button to exit the Leveling Assistant.

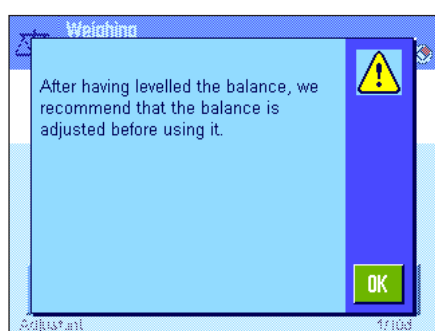

Before the balance returns to Weighing Mode, a message appears that advises you to adjust the balance after you have leveled it. Confirm the message with **"OK"**.

If the balance was leveled correctly, the status icon will no longer appear in the upper right-hand corner of the display.

**Note:** You can also level the balance at any time without using the Leveling Assistant. As soon as the warning message appears, press the **"OK"** button to cancel the dialogue. Level the balance by turning the footscrews as described above. As soon as the level is correct, the status icon in the upper right-hand corner of the display will disappear.

### 3.3 Performing a simple weighing

Just a few keys located in the lower part of the terminal are needed to perform a simple weighing. Your balance has separate keys for zeroing («→0←») and taring («→T←»).



**Zeroing:** A new zero point is set using the «→0←» key and all weight values (including the tare weight) are measured in relation to this zero point. After zeroing, the following values apply: tare weight = 0, net weight (= gross weight) = 0. Always use the «→0←» zeroing keys before you start with a weighing, especially before recording a tare weight (using the «→T←» key). As soon as the zero-setting is complete, the glass draft shield opens automatically, and the balance is ready for weighing.

**Taring:** If you are working with a weighing container, first set the balance to zero. Place the container on the balance and press the «→T←» key to tare the balance. The glass draft shield closes automatically. The weight of the container is set as the new tare weight and the current tare (if available) is overwritten. As soon as the taring is complete, the glass draft shield opens automatically, and the balance is ready for weighing. The "Net" display indicates that all weight values displayed are net values. Note: If you try to tare a negative weight value, an error message appears as this is not permitted. Set the balance to zero and try again.

**Weighing:** Place the weighing sample on the pan. As soon as the stability detector icon (the small ring to the left of the weight display) fades, the display is stable and the weighing result can be read. In the illustration opposite, the stability detector icon is still visible and the weighing result is therefore not yet stable.

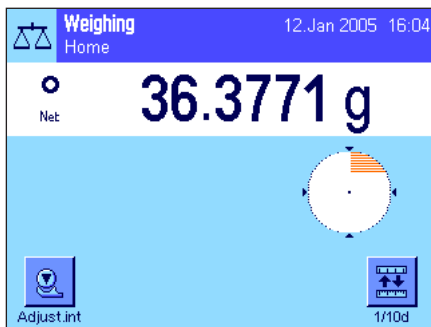

## 4 Basic principles for using the terminal and the software

This Section explains the operating and display elements of your terminal and explains the operating principles of the software for your balance. Please read this Section through carefully. It is the basis for all operating steps, which are referred to in later Sections.

### 4.1 Overview of the terminal

In this Section we start by introducing the operating elements of the terminal (with the exception of the «On/Off», «→0←» and «→T←» keys, which were already described in the previous Section).

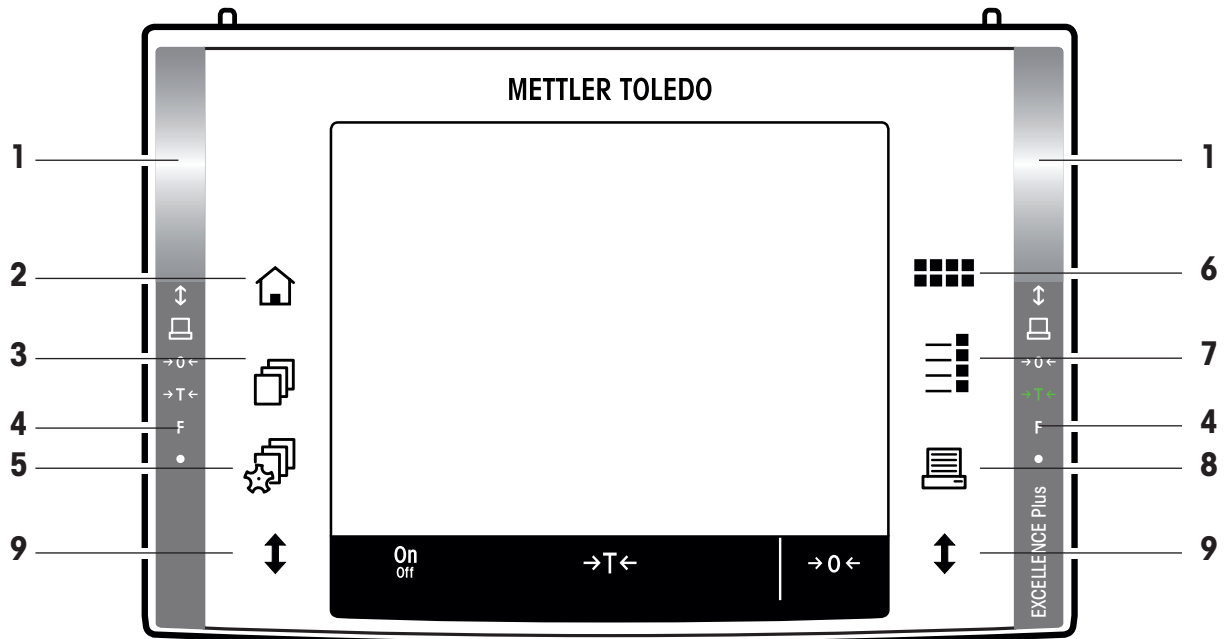

#### 1 SmartSens

Each of these two contact-free sensors can be assigned a key or menu function (e.g. zeroing, printing or changing the display resolution, etc.). To initiate the appropriate function, move your hand over the relevant sensor (maximum distance of approx. 5 cm). The sensor beeps to confirm that it has recognized the command and is carrying it out. Both sensors for the opening/closing of the glass draft shield doors are preset ex works.



#### 2 «Home» key

This key can be used to return to the "Home" user profile from any menu level in any application (additional information on applications and user profiles can be found later in this Section).



#### 3 «User Profile» key

This key can be used to call up the desired user profile. Different settings can be stored in a user profile. This enables the optimum adaptation of the balance to the user or a particular weighing task.

#### 4 Status bar

When the left or right SmartSens is assigned a key function, the corresponding icon («≡», «→0←» or «→T←») lights up green in the left or right status bar. If the "F" icon lights up, one of the menu functions has been assigned to the corresponding SmartSens.

The yellow LED at the very bottom of the status bar lights up briefly to confirm when a key has been pressed or a menu function carried out. This visual acknowledgment is deactivated ex works.

**5 «⚙» key**

This key can be used to define the basic settings for each user profile. These settings apply to all applications used by the current user.

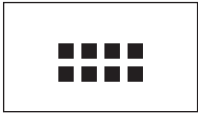
**6 «□□□□» key**

Your balance is supplied with standard applications ex works (e.g., for normal weighing, statistics, formulation, piece counting, percent weighing and density determination). This key can be used to select the application you would like to work with.

**7 «☰» key**

Each application can be ideally adapted to the current task using a number of settings. This key can be used to call up the menus for configuring the active application.

**8 «🖨» key**

Pressing this key transmits data via the interface, e.g. to a printer. However, other devices - for example, a PC - can also be connected. The data to be transmitted can be freely defined.

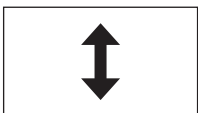
**9 «↕» key**

Use this button to open and close the doors of the glass draft shield. For ease of operation, these buttons are located on both sides of the terminal.

## 4.2 The display

Your terminal's illuminated, colorful display is a "touch screen", that is to say, a touch-sensitive screen. Not only can you read data, but you can also make settings and execute functions by touching the surface of the screen.

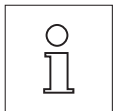

**Note:** Depending on country-specific rules, on certified versions of balances the uncertified decimal places are displayed dimmed.

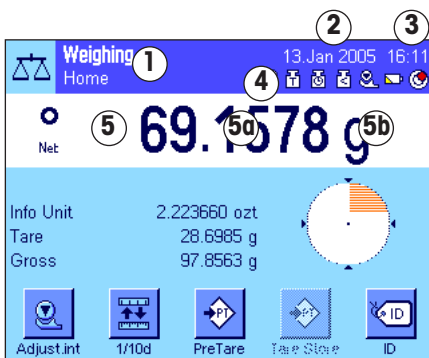

The display is divided into different zones (the figure shows the display with information fields and "SmartTrac"):

- 1 The current **active application** is indicated in the top left of the display. By touching this zone you can call up the menu in which you can select the desired application (this menu can also be accessed using the «□□□□» key).
- 2 Display of the current **date**. The date can be changed by touching this zone.
- 3 Display of the current **time**. The time can be changed by touching this zone.
- 4 **Status icons:** These symbols appear as needed and indicate any special needs of the balance (e.g., needs servicing, needs adjustment, change batteries, etc.). A list of all status icons can be found in Section 16.3.
- 5 The current **weighing result** appears in this zone. If the weighing unit is touched (**5b**), a window appears, in which the desired weighing unit can be selected.

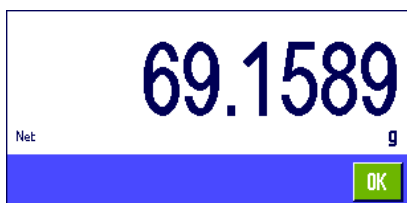

If the weighing result (**5a**) is touched, then a new screen will appear displaying the result in a larger format. This can be useful if the weighing result has to be read from a distance. This window can be closed again by pressing the "OK" button.



- 6 Additional information (**information fields**) for the active application, which makes your work easier, are displayed in this area. By touching this zone, you can indicate which information fields (and function keys, see below) should be displayed without having to go through the menu, and you can also start the Leveling Assistant (see Section 3.2).
- 7 The **“SmartTrac,”** a graphic weighing-in aid, which shows the used and remaining available weighing capacity at a glance, is displayed in this zone. Different display types for the **“SmartTrac”** can be selected or switched off completely by touching this area.
- 8 This area is reserved for the **function keys**, which provide direct access to the most frequently required functions and settings for the active application. If more than 5 function keys are activated, you can switch between them using the arrow keys (not shown in the figure).

### Screen saver

If the balance is not used for 15 minutes, the backlighting of the display is automatically switched off and the pixels are inverted at intervals of approximately 15 seconds. As soon as you start to work with the balance again (load a weight, press a key, etc.), the display returns to its normal state.

## 4.3 The software for your balance

The software controls all functions of your balance. In addition, it enables the balance to be adapted to your specific working environment. Please note the following explanations. They provide the basis for operating your balance.

The software consists of the following components:

- User profiles
- User-specific settings
- Applications
- Application-specific settings
- System settings

### User profiles

User profiles can be used to adapt the balance and its applications to personal work techniques or to particular weighing tasks. A user profile is a collection of settings, which you can define yourself and which are available at the touch of a button. When the balance is switched on, the last active user profile is loaded automatically.



The **“home”** profile is a starting point, to which you can return at any time by pressing the **«⏠»** key. It contains factory-set standard settings, with which every user can work. These presettings can of course be changed. However, we recommend that you do not change the default settings of the **“home”** profile, but rather make modifications to the 7 other user profiles.



In addition to the **“home”** profile, a total of 7 other user profiles are available, whose settings can be changed to suit your requirements. The **«☰»** key can be used to call up the desired user profile. All settings that are made while a particular user profile is active are stored under this profile. These include application-specific settings and user-specific settings but not system settings (see below).

Access authorizations for the user profiles can be defined using the security system of your balance (see Section 4.5) to protect them against unauthorized changes.

### User-specific settings

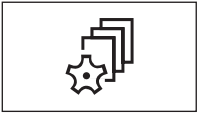

These settings, which are available under the «» key, can be used to adapt the balance to the tasks and work techniques of the current user. The settings can be defined separately for each of the 7 user profiles and "home" profile. When a user profile is called up, the relevant user-specific settings are loaded automatically.

### Applications



Applications are software modules for carrying out specific weighing tasks. The balance is supplied with different applications ex works (e.g. for normal weighing, statistics, formulation, piece counting, percent weighing and density determination). After it has been switched on, the balance loads the last active user profile and the application with which the user has last worked. The applications are available under the «» key. Notes on working with standard applications can be found in Section 7ff.

### Application-specific settings





These settings can be used to adapt applications to the requirements of the current user. The available setting options vary depending on the application selected. Pressing the «» key opens the multi-page menu, which has the settings for the currently active application. Information on the individual setting options can be found in the Section on the relevant application. The settings can be defined separately for each of the 7 user profiles and the "home" profile. When a user profile is called up, the relevant application-specific settings are loaded automatically.

### System settings



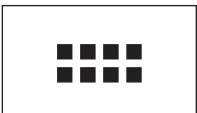



or



The system settings (e.g. settings for peripheral devices) are independent of the user profiles and applications and apply to the entire weighing system. To call up the system settings, press the «» or «» key and then the "System" button. Notes on the individual setting options can be found in Section 5.

The figure on the following page clearly illustrates the connections between the individual software components and gives an initial overview of the typical operating sequence.

**Note:** You can exit a menu at any time by once again pressing the button («», «», «» or «»), that you used to call up that menu



**Operating step**

**1. Select user profile**

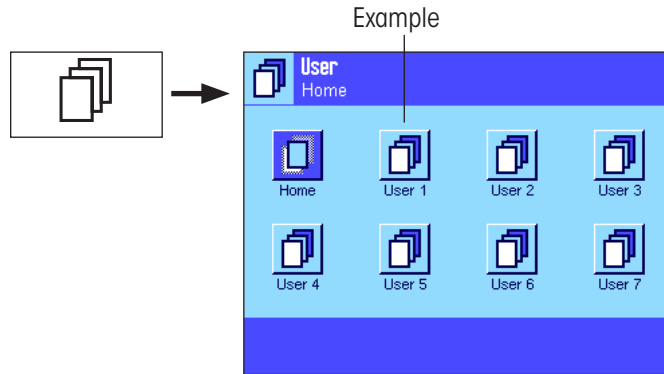

**2. Select application**

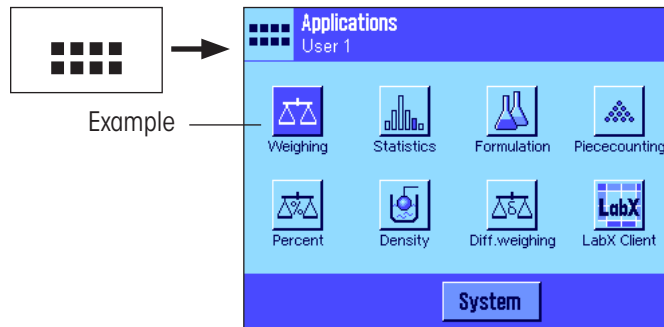

**3. Work**

**4. If necessary:**

Change settings for the selected application (**application-specific settings**)

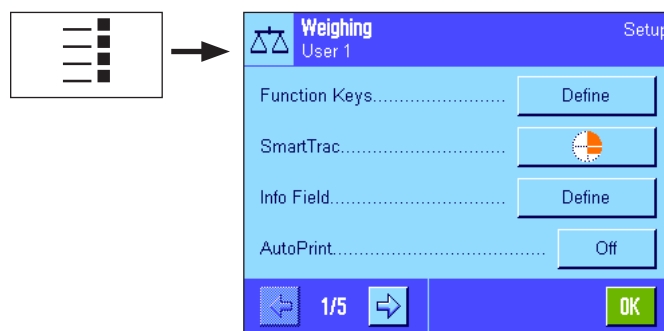

Confirm settings using "OK." The settings are stored under the **active-user profile** and the balance returns to the application.

**5. If necessary:**

Adapt the balance to the specific task and the user's work technique (**user-specific settings**)

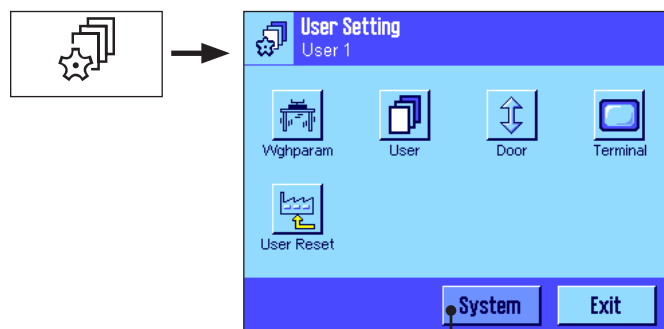

Confirm settings using "OK." The settings are stored under the **active-user profile**. Press "Exit" in the main menu to return to the active application.

**6. If necessary:**

Change global balance settings (**system settings**)

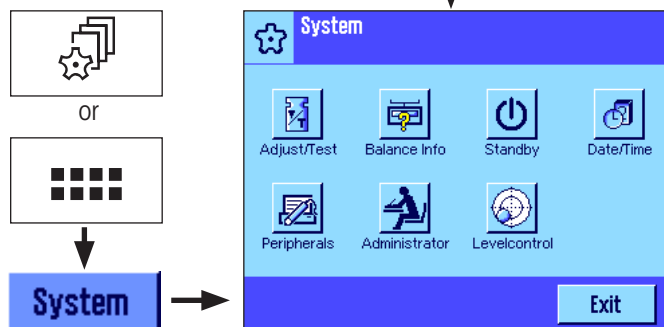

Confirm settings using "OK." The settings are stored. Press "Exit" in the main menu to return to the active application.

## 4.4 Typical operating sequence

The typical operating sequence is briefly described below, without going into detail on application-specific features.

**Note:** User profiles and settings can be protected against unauthorized access by the security system of the balance (see Section 4.5) so that they can only be accessed with a password. The following description assumes that password protection has not been defined for any area of the menu system and that all settings are freely accessible.

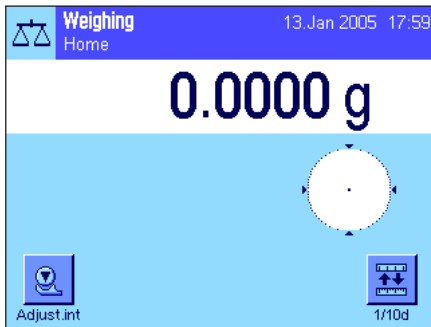
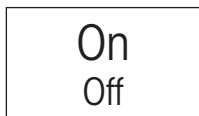

**Switching on the balance:** Switch on the balance by pressing the "On/Off" key briefly. When switched on, the balance loads the user profile that was last used and the application that was active when the balance was switched off. The application and the user profile are indicated in the upper lefthand corner of the display.

**Note:** Depending on the user profile last used and the selected settings, the display of your balance may differ from the example shown.

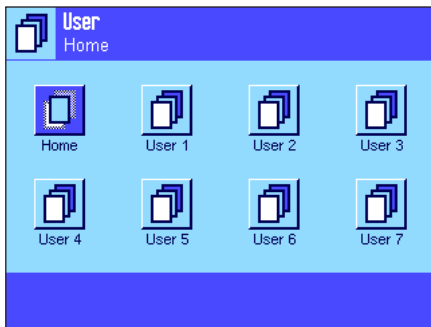

**Selecting the user profile:** If you do not wish to work with the current profile, call up the profile menu using the «☰» key and select the desired user profile by touching the relevant icon (e.g. "User 4"). This activates the user and application-specific settings that are stored under the selected profile.

**Note:** In the illustration opposite, the user profiles still have the names that were preprogrammed in the factory but these can be changed (Section 6.4).

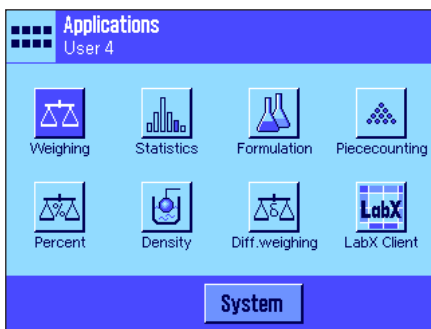
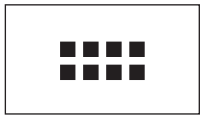

**Selecting the application:** If you do not wish to work with the current application, select the application menu using the «☰» key (alternatively you can touch the relevant zone in the top left of the display). Touch the icon for the desired application and the software loads the selected application.

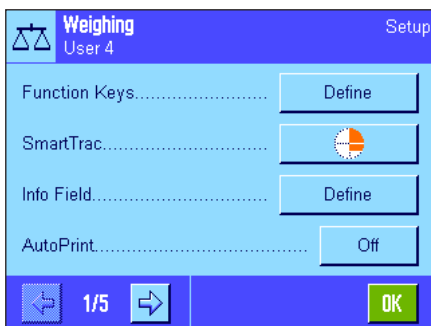

**Changing application-specific settings:** To change the settings for the active application, press the «☰» key. The settings that you define here will be stored under the active user profile, so please ensure that the desired user profile is active before you define the settings. Information on application-specific settings can be found in the description of the relevant application (Section 7ff).

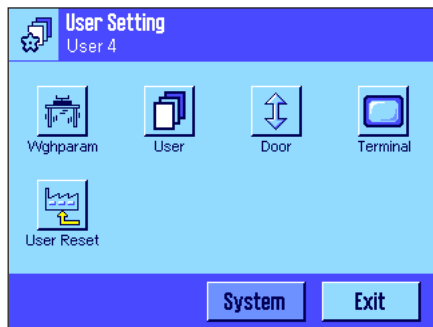



**Changing user-specific settings:** In this menu, which can be called up using the «» key, the balance can be adapted to your work technique and to specific tasks (Section 6). The settings that you define here will be stored under the active user profile and apply when working with all applications within this profile. Please ensure that the desired user profile is active before you define the settings.

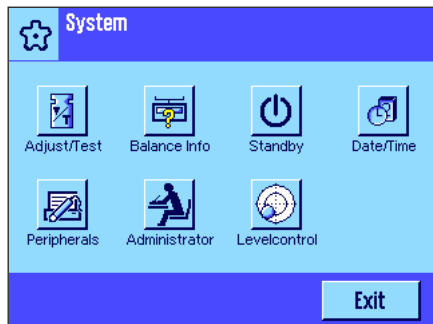
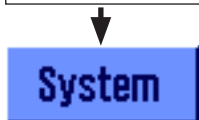
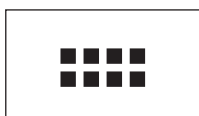

or



**Changing system settings:** To change the system settings, which apply to the entire weighing system i.e. for all user profiles and applications, press the «» or «» key and then the "System" button. The system settings are described in detail in Section 5.

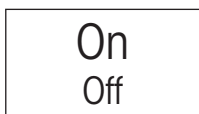

**Working:** Carry out the desired operations. Information on working with the individual applications can be found in Section 7 onwards.

**Switching off the balance:** On completion of the work, switch off the balance by pressing and holding the "On/Off" key.

## 4.5 The security system of your balance

Your balance has a comprehensive security system, which can be used to define individual access rights at administrator and user level. It is possible to define which settings can be changed for each individual user profile. Access to protected menu areas requires the entry of an identification (ID) and a password. When the balance is delivered ex works, only the "Administrator" settings (in the system settings) are protected. Additional information on setting up the security system can be found in Sections 5.8 and 6.4.



If you try to call up a menu area that is protected with an ID and password, an alphanumeric keyboard first appears in the display for entering the ID. Type in your ID (to switch between lowercase and uppercase letters, use the "a...z" and "A...Z" buttons; to enter numbers, press the "0...9" button). Incorrect entries can be deleted character by character using the backspace key.

**Note:** The dialog box can be closed at any time by pressing "C".

As soon as the ID has been entered fully, press "OK". A second dialog box appears for entering the password. Type in your password (for security reasons this is displayed using asterisks rather than in plain text) and confirm with "OK". If the ID and the password are correct, the selected menu area will be called up or the desired action will be executed. If not, an error message will appear, along with instructions to reenter your ID and password.

**CAUTION:** Note your IDs and passwords carefully. If you forget an ID or a password, it is not possible to regain access to a protected menu area. We recommend that you note down your IDs and passwords and keep them in a safe place.



## 5 System settings

This Section describes how the weighing system can be adapted to your requirements. The **system settings** apply to the entire weighing system and therefore to all user profiles and applications. **Note:** User-specific settings are described in Section 6. Application-specific settings are explained in the description of the relevant application (Section 7 onwards).

### 5.1 Calling up the system settings

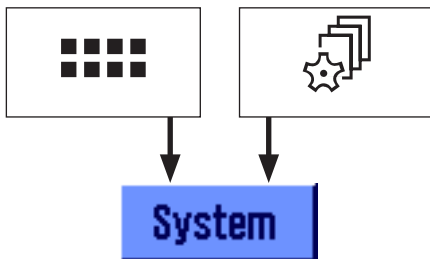

Select the application menu using the «::::» key or the menu for the user settings using the «☰» key, and then press the “**System**” button.

### 5.2 Overview of the system settings

The system settings are represented by icons. The individual settings can be called up and changed by touching the icons. Detailed notes on the setting options can be found in later Sections.

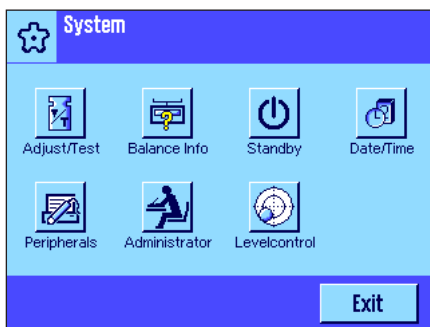

The following system settings are available:

- “**Adjust/Test**”: Settings for adjustment and test functions for testing the adjustment (Section 5.3).
- “**Balance Info**”: Display/printout of balance information (Section 5.4).
- “**Standby**”: Settings for the “Standby” mode (Section 5.5).
- “**Date/Time**”: Entry of date and time and selection of display format (Section 5.6).
- “**Peripherals**”: Configuring the interface for various peripheral devices (Section 5.7).
- “**Administrator**”: Configuring the security system of the balance, including allocating access rights and passwords for balance functions and menus (Section 5.8).  
**Note:** Access to the “Administrator” settings is protected ex works with an ID and a password.
- “**Levelcontrol**”: Settings for the integrated level sensor (Section 5.9).

Once you have defined all the settings required, press the “**Exit**” button to return to the active application. Later Sections introduce the different system settings in detail.



**Note:** If special interface options (e.g. Ethernet) have been installed, the systems settings menu additionally displays the symbol shown at left with global settings for these interfaces. These settings are described in the instructions that were supplied with the optional interface.

## 5.3 Settings for adjustment and tests

These menus can be used to define all settings relating to the adjustment of your balance. Information on all setting options for adjustment and test operations and for recording these operations can be found in the following subsections. Notes on making adjustments and tests can be found in Section 7.4.

**Note:** Depending on country-specific rules, on **certified versions of balances** certain settings may not be available.

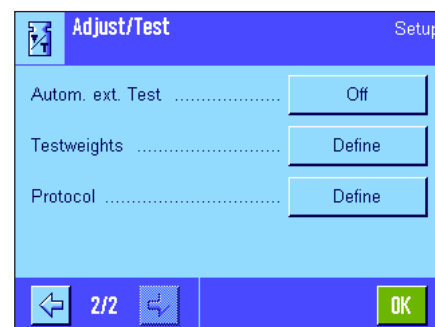
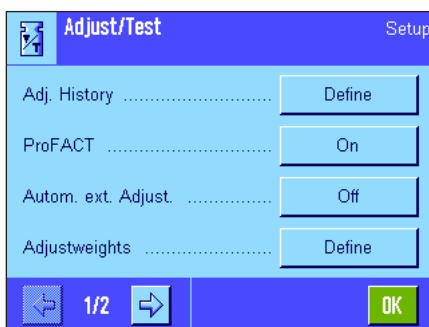

### 5.3.1 Specifications for displaying recorded adjustment operations (adjustment history)



The balance always records all adjustment operations that have been made and saves them in a memory protected against power failure. In this menu you can view a list of these operations, and define which type of adjustment operations the list should contain and how comprehensive it should be.

**Note:** If the memory is full (after 50 adjustment operations), the oldest operation will be deleted automatically. Therefore, you should print out and archive the list from time to time if your laboratory standards require full traceability of all adjustments made.

The following options are available:

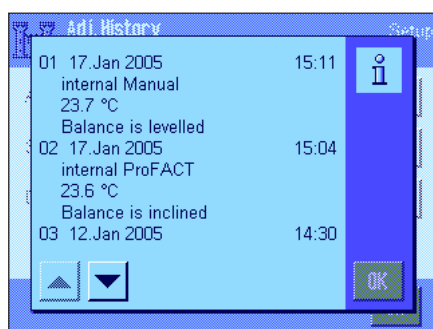

#### “Adj. History”

When the “Show” button is pressed, a window appears with a list of the adjustments made. Although the balance permanently records all adjustments made, the list only displays the operations that were selected for display (in the “Selection” menu, see below). Specific data is displayed for every adjustment operation (date and time, type of adjustment, temperature, leveling). The list can be printed out by pressing the «» key (provided that a printer is connected and activated as the output device in the peripheral settings).



#### “Selection”

This menu can be used to define which types of adjustment operations should be displayed in the list. This means you can selectively shorten the list (and hence any printout) and therefore arrange it more clearly. Manual adjustment operations as well as time and temperature-controlled adjustments can be selected (see also Section 5.3.2). Please note that the balance records all adjustment operations. It simply uses the settings in this menu to determine the display of the list contents.

**Factory setting:** “Manual adjust.”, “Temperature” and “Time Adjust” activated.

#### “Display Records”



In this menu you can specify how many of the most recently performed adjustment operations should be displayed in the list (max. 50). The list, and hence any printout, can be selectively shortened using this setting.

**Factory setting:** "Last 50"

### 5.3.2 "ProFACT" fully automatic adjustment function

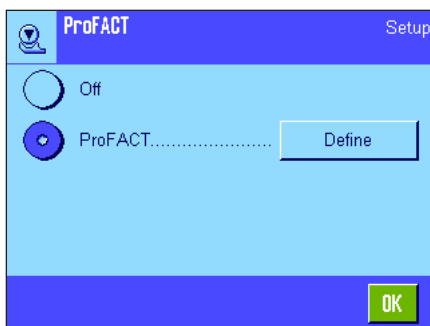

The settings for fully automatic adjustment are defined in this menu using the **internal** adjustment weight (ProFACT). ProFACT (**P**rofessional **F**ully **A**utomatic **C**alibration **T**echnology) provides fully automatic balance adjustment based on preselected time and/or temperature criteria.

The following settings are available:

**"Off":** ProFACT fully automatic adjustment is **switched off**.

**"ProFACT":** ProFACT fully automatic adjustment is **switched on** (factory default setting)

The behavior of the ProFACT adjustment function can be defined using the **"Define"** button:

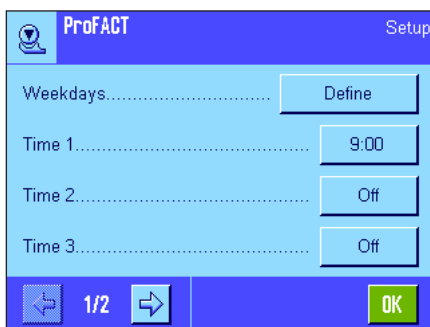

#### "Days"

This menu can be used to define the days on which a fully automatic adjustment should be carried out. If you do not wish to have time-controlled adjustment, deactivate all days.

**Factory setting:** All days activated.

#### "Time 1" ... "Time 3" ...

For the preselected days you can specify up to 3 times for a fully automatic adjustment to take place.

**Factory setting:** "Time 1" = 9:00, "Time 2" and "Time 3" = "Off".

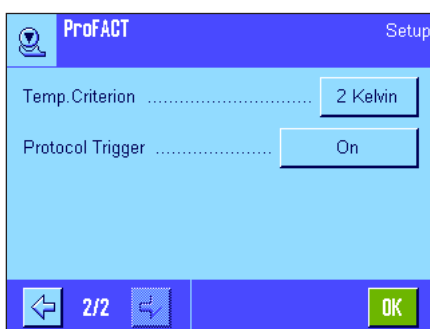

#### "Temp. Criterion"

The "Temp. Criterion" option defines which change in ambient temperature should trigger an automatic adjustment. If "Off" is selected, automatic adjustment based on a temperature criterion will not take place.

**Factory setting:** "2 Kelvin".

#### "Protocol Trigger"

This setting specifies whether an adjustment report should be printed automatically. If you select "Off", automatic printouts will not be made. If "On" is selected, a record will automatically be printed out whenever the balance undergoes fully automatic adjustment.

**Factory setting:** "On".

### 5.3.3 Automatic adjustment using an external adjustment weight

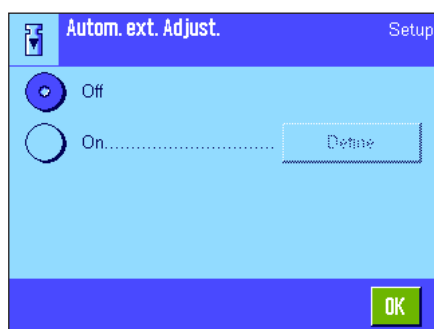

If you are working with an external adjustment weight, this setting can be used to define the days and time when the balance should provide an adjustment reminder. Information on the (automatic) adjustment process using an external adjustment weight can be found in Section 7.4.3.

The behavior of the automatic external adjustment function can be defined using the **"Define"** button. The same setting options are available as for the time criterion of the ProFACT fully automatic adjustment function (Section 5.3.1); however, only one time per day is available.

**Factory setting:** Automatic external adjustment function switched off ("Off").

### 5.3.4 Defining external adjustment weights



If you are working with external adjustment weights, this setting can be used to define their properties. Up to 5 external adjustment weights can be defined on these two menu pages. During the adjustment procedure (Section 7.4.3), you will be able to select which of the defined weights you want to use to make the adjustment.

When the "Define" button is pressed, the following settings are available for each of the 5 external adjustment weights:

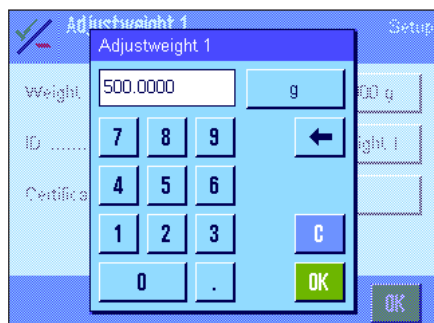

#### "Weight"

This setting can be used to define the weight of the external adjustment weight. A numeric input window appears. Enter the weight of the external adjustment weight (in grams).

**Factory setting:** Model-dependent.



#### "ID"

This setting can be used to assign a designation to each external adjustment weight (max. 20 characters). This makes it easier to identify each of the adjustment weights. The weight identification can be printed on the adjustment printouts. Alphanumeric characters can be entered in the input window.

**Factory setting:** "Adj. weight x" (x = number of the adjustment weight)

**Note:** You can select the desired adjustment weight from a list that will appear during the adjustment procedure (Section 7.4.3). We recommend you to use an "ID" which is short enough (max. 15 characters) to be completely displayed in the list.



### “Certificate No.”

In most cases, adjustment weights are supplied with a certificate. This setting can be used to enter the designation or the number of the certificate that is supplied with each adjustment weight (max. 20 characters). This enables each external adjustment weight to be clearly assigned a specific certificate. The certificate designation can be printed on the adjustment printouts. The same alphanumeric input window appears as for the ID.

**Factory setting:** No entry specified

## 5.3.5 Automatic adjustment testing using an external test weight

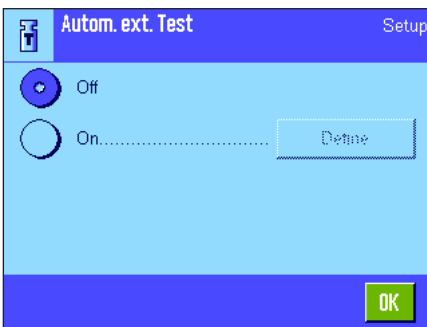

If you want to test the adjustments using an external test weight, this setting can be used to define the days and time when the balance should provide a test reminder. Information on the (automatic) testing of the adjustment process using an external test weight can be found in Section 7.4.5.

The behavior of the automatic external test function can be defined using the **“Define”** button. The same setting options are available as for defining automatic adjustment using an external adjustment weight (Section 5.3.3).

**Factory setting:** Automatic external adjustment function switched off (“Off”).

## 5.3.6 Defining external test weights

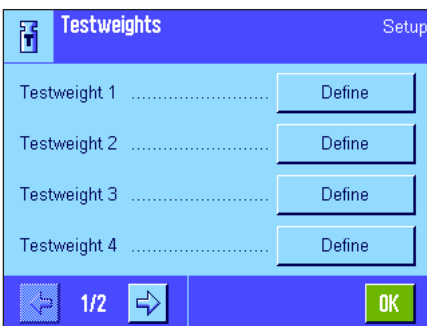

If you are working with external weights for testing the adjustment, you can define their properties here (weight, ID and certificate number).

The same input windows and settings are available as for defining the external adjustment weights (Section 5.3.4).

**Factory setting:** Weight: model-dependent  
ID: “Testweight x” (x = number of test weight)  
Certificate number: no entry

**Note:** You can select the desired test weight for checking the adjustment from a list that will appear during the testing procedure (Section 7.4.5). We recommend you to use “IDs” which are short enough (max. 15 characters) to be completely displayed in the list.



### 5.3.7 Defining adjustment and test reports

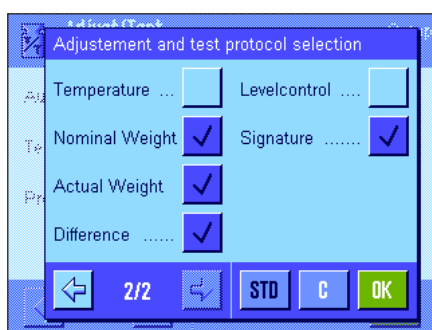
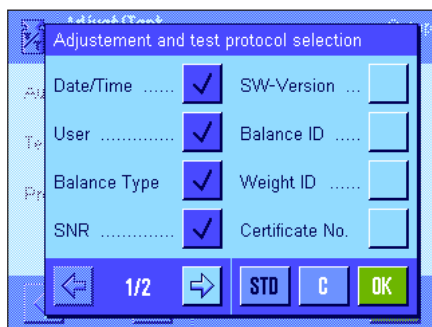

Sample printout of a test using an external test weight (all printout options activa-

```

---- External test ----
18.Jan 2005      14:10

METTLER TOLEDO
User Name      Home

Balance Type   XP504
WeighBridge SNR:
                1234567890
Terminal SNR: 1234567890
SW WeighBridge 1.90a
SW Terminal    2.90x
Balance ID     LAB-1/4
Weight ID      ETW-500/1
Certificate No. MT-223/3

Temperature    23.0 °C
Nominal        500.0000 g
Actual         500.0005 g
Diff.          0.0005 g

Balance is levelled

Test done

Signature

```

This two-page menu can be used to define the information to be printed on the adjustment and test printouts. Touch the relevant boxes to activate the desired information. If a box is checked, the relevant information will be printed. Press "STD" to return to the factory default setting. Press "OK" to save the modifications (press "C" to exit the input window without saving). The following record information is available:

#### "Date/Time"

The date and time of the adjustment are printed in the defined date and time format (Section 5.6).

#### "User"

The name of the user (designation of the user profile) who has made the adjustment is printed (not for automatic ProFACT adjustment).

#### "Balance Type"

This information is stored in the weighing platform and the terminal and cannot be changed by the user.

#### "SNR"

The serial numbers of the terminal and the weighing platform are printed. They are stored in the weighing platform and the terminal and cannot be changed by the user.

#### "SW-Version"

The version numbers of the balance software are printed (one number for the terminal and one for the weighing platform).

#### "Balance ID"

The defined identification of the balance is printed (Section 5.4).

#### "Weight ID"

The defined identification of the external adjustment weight used is printed (Section 5.3.6).

#### "Certificate No."

The defined designation for the certificate of the external adjustment weight used is printed (Section 5.3.6).

#### "Temperature"

The temperature at the time of the adjustment is printed.

#### "Nominal Weight"

The nominal weight for adjustment/testing is printed (only when adjusting/testing using an external weight, Section 5.3.5).

#### "Actual Weight"

The result of the test (actual weight) is printed (only when testing using an external weight, Section 5.3.5).

#### "Difference"

The difference between the nominal weight and the actual weight is printed (only when testing using an external weight).

#### "Levelcontrol"

Documents whether or not the balance is leveled correctly.

#### "Signature"

An additional line is printed for signing the record.

#### Factory setting:

"Date/Time", "User", "Balance Type", "SNR" (serial number), "Nominal Weight", "Actual Weight", "Difference" and "Signature".

## 5.4 Balance Information

This menu can be used to define an identification for your balance and to call up balance information.

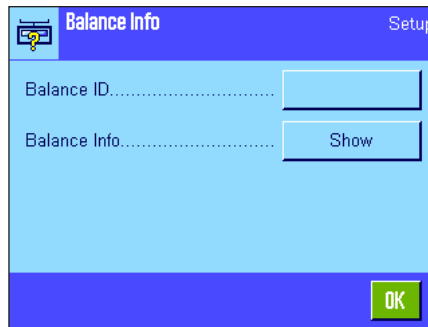

The following options are available:



### “Balance ID”

This setting can be used to assign a designation to your balance (max. 20 characters). This makes it easier to identify individual balances in operations that use several balances. This designation is also printed in the records. Alphanumeric characters can be entered in the input window.

**Factory setting:** No entry specified

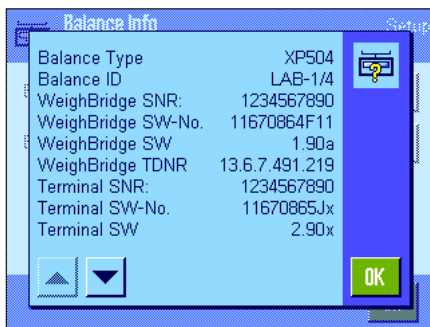

### “Balance Info”

When the “Show” button is pressed, a window appears with information on the balance and the built-in options. This information is of particular importance for the service technician. If you call the METTLER TOLEDO customer service department, you should have this information at hand.

Balance information can be printed by pressing the «» key (provided that a printer is connected and activated as the output device in the peripheral settings).

## 5.5 Standby (energy-saving function)

This menu can be used to define the length of time that the balance must be inactive before it automatically enters “standby” mode.

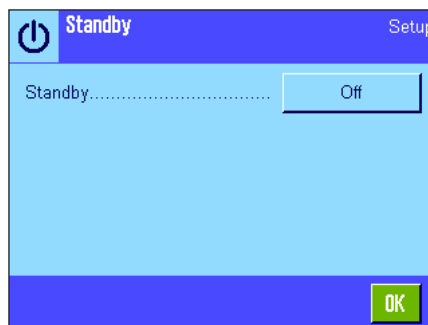

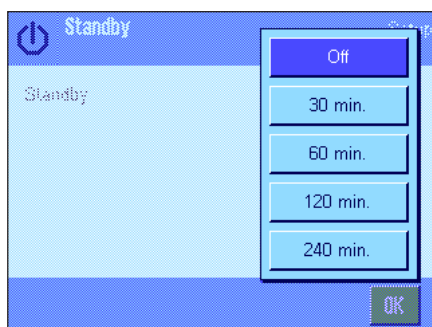

You can switch off standby mode ("Off") or define a time of 30, 60, 120 or 240 minutes, after which the balance should enter "Standby" mode. "Standby" mode is the same state that the balance enters if it is switched off using the «On/Off» key. Press the «On/Off» key to switch the balance on again.

**Factory setting:** "Off" ("Standby" mode deactivated)

**Note:** Regardless of the "standby" mode setting, the brightness of the display is automatically reduced if the balance has not been used for 15 minutes.

## 5.6 Date and time

This menu can be used to enter the date and time and select their display formats.

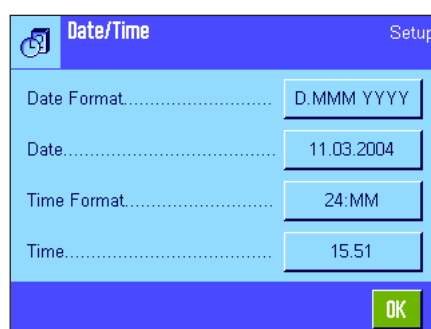

The following setting options are available:

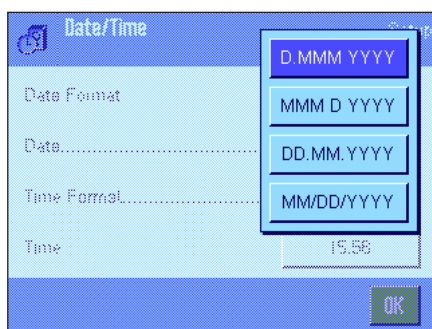

### "Date Format"

The following date formats are available:

"D.MMM.YYYY" Display example: 29. May 2003

"MMM.D.YYYY" Display example: May 29 2003

"DD.MM.YYYY" Display example: 29.05.2003

"MM/DD/YYYY" Display example: 05/29/2003

**Factory setting:** "D.MMM.YYYY"

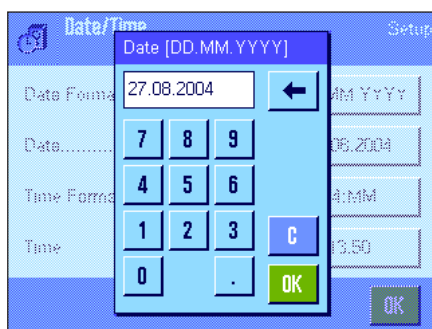

### "Date"

For setting the current date. A numeric input window appears. Enter the current date in the **format day - month - year (DD.MM.YYYY)**, regardless of which date format you have chosen for the display.

**Note:** This setting can also be made directly by touching the date in weighing mode. A window appears in which you can directly enter the date.

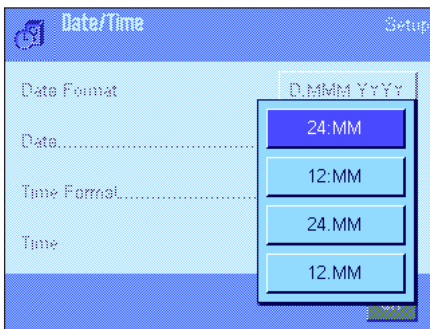

### “Time Format”

This setting can be used to define the format in which the time should be displayed. The following time formats are available:

“24:MM”	Display example:	15:04
“12:MM”	Display example:	3:04 PM
“24.MM”	Display example:	15.04
“12.MM”	Display example:	3.04 PM

**Factory setting:** “24:MM”

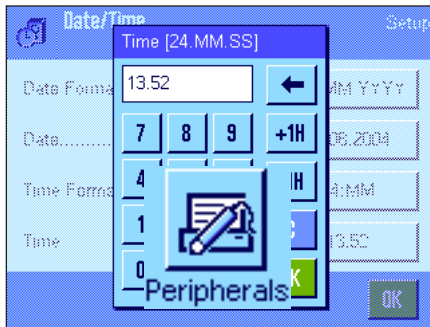

### “Time”

For setting the current time. Enter the current time in the **24-hour format (24.MM.SS)**, the entry of seconds is optional, regardless of which time format you have chosen for the display. The input window is the same as for the date. In addition, the “+1H” and “-1H” keys are available for setting the current time forward or backward by one hour. This enables you to quickly switch between summer and winter time. **Note:** The time can also be set directly by touching the time display in weighing mode.

## 5.7 Selecting peripheral devices

Various peripheral devices can be connected to the interface(s) of your balance. This menu can be used to define which devices should be connected and which parameters the interface should work with.

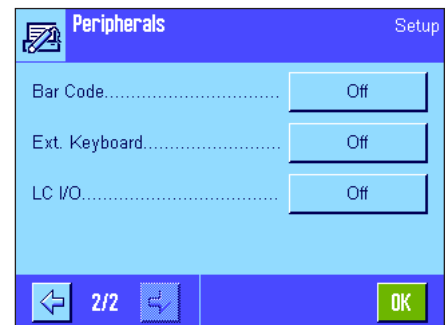
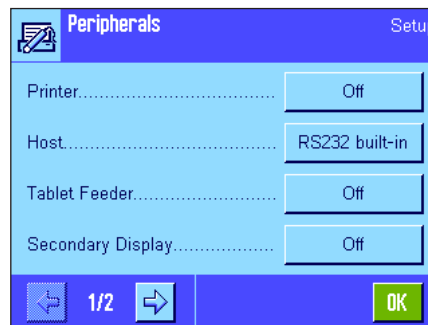

The following settings are available:

- “Printer”: Printer
- “Host”: External computer (bidirectional communication; the balance can send data to the PC and receive commands or data from the PC)
- “Tablet Feeder”: LV11 automatic feeder from METTLER TOLEDO
- “Secondary Display”: Secondary display
- “Bar Code”: Bar code reader
- “Ext. Keyboard”: PC keyboard
- “LC I/O”: Programmable relay interface from METTLER TOLEDO

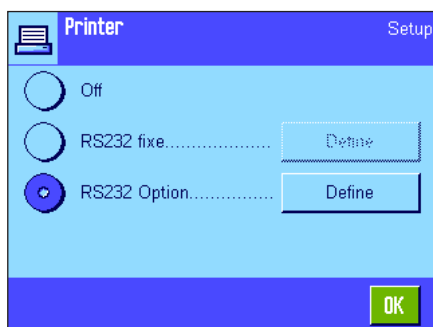

Specific setting options are available for the interfaces of each of these devices: "Off" means that no device of this type should be connected. "RS232 fix" indicates the RS232C interface, which is built in ex works. If other optional interfaces are present, they are displayed (such as the second serial interface "RS232 Option" in the example opposite). At this point, however, only the parameters of the RS232C interface, which is built in ex works, are explained. **Important:** Only one device can be activated for each available interface. All other devices must be deactivated ("Off"). If you activate a new device, the previously selected device is automatically deactivated.

**Note:** Detailed information on optional interfaces and various peripheral devices can be found in the documentation supplied with these products.



If you have activated a device, you can use the "Define" button to set the interface parameters for communication with this device, i.e. baud rate, data format, stop bits, handshake, end of line character, character set and "Continuous mode" (only for the "Host" peripheral device).

**Factory setting:**

"Host"  
(9600 baud, 8 data bits/no parity, 1 stop bit, Xon/Xoff record, end of line character <CR><LF>, ANSI/Windows character set, "Continuous mode" = off).

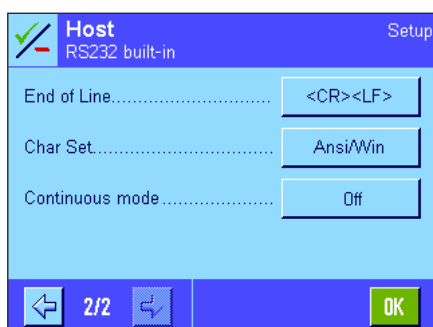

**Important:** To ensure that special characters (e.g. "°C") are printed out correctly on METTLER TOLEDO printers, the **balance and printer** must be set to **8 data bits**.



**Note:** For operation with a printer, the **IBM/DOS** setting must be selected under "Char set".

**Notes on "Continuous mode"**

In "Continuous mode", the weighing data is continuously transmitted via the interface. "Continuous mode" is available only for the "Host" peripheral device and the RS232C interface ("RS232 fix"), which is built in ex works. If "Continuous mode" is activated, additional setting options are available:

**"Output format"**

- With the "MT-SICS" setting (factory setting), the data is transmitted in MT-SICS format (**M**ettler **T**oledo **S**tandard **I**nterface **C**ommand **S**et). MT-SICS works bidirectionally, i.e. the balance can also receive acknowledgments or commands from the host. A separate handbook for MT-SICS is available at "www.mt.com/xp-analytical".
- The "PM" setting emulates the data format of PM balances (unidirectional).
- With the "AT/MT" setting, the data is transmitted in the format used by METTLER TOLEDO AT and MT balances (unidirectional).

**"Updates/sec."**

This setting determines how many data records are transmitted via the interface per second (2, 5, 6 or 10, factory setting: 5).

### Notes on the interaction between individual peripheral devices and different applications:

Each balance application supports particular peripheral devices. The control of peripheral devices can vary from application to application.

**Example:** The programmable LC-I/O relay interface from METTLER TOLEDO is supported by both the "Statistics" application and the "Piececounting" application but is controlled differently by each application. Detailed information on the interaction between balance applications and different external devices can be found in the "**Solution Guide**", which is available on the Internet ([www.mt.com/xp-analytical](http://www.mt.com/xp-analytical)).

## 5.8 Configuring the security system

This menu can be used to change the administrator ID and password, reset all balance settings, allocate access rights for individual users and define specifications for recording security-related operations.

**Important:** This menu is protected ex works with an ID and a password. When the menu is called up, the following two dialog boxes appear for entering the administrator ID and administrator password:



The character "Z" is set for the administrator ID and administrator password ex works. Type this character in each of the dialog boxes and confirm using "OK". If the ID and/or password are incorrect, you will be asked to enter them again. If the entries are correct, the following menu appears:

Detailed information on the options available for the security system of your balance can be found in later Sections.

### Warning!

- The ID and password must always be entered in the same language in which they were defined. If you change the dialog language (Section 6.4), you may no longer be able to enter the access codes.
- If the balance is controlled by the commands of an external host, the password protection will not function.

### 5.8.1 Changing the administrator ID and password

The "Administrator ID" and "Administrator Password" menus can be used to change the factory-set access codes ("Z" for ID and password). **Note:** Both an ID and a password must be defined (max. 20 characters). If you delete the existing entry and do not enter a new one, an error message appears.

**CAUTION: Note the administrator ID and password carefully. If you forget one of the codes, it is not possible to regain access to the menu areas that are protected with these access codes. We recommend that you note down your ID and password and keep them in a safe place.**

### 5.8.2 Performing a global balance reset

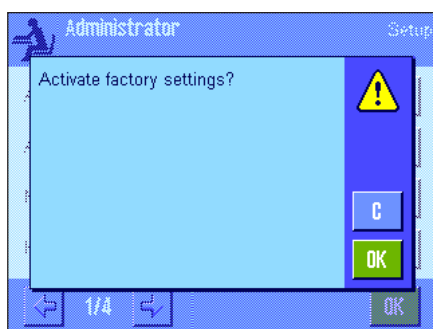

In the "Master Reset" menu all the balance settings can be reset to the factory default settings. When the "Execute" button is pressed, the prompt opposite appears. If you do not want to reset, press "C".



**WARNING: If you confirm the reset using "OK", the balance restarts and all user and application-specific settings are reset to the factory default settings. As a result, all individual settings are lost. With the exception of the recorded adjustment operations (Section 5.3.1) and the date and time, all system settings are also reset, including the administrator ID and administrator password.**

### 5.8.3 Defining user access rights



Access rights for all 8 user profiles can be defined in the "Rights Home" and "Rights User 1" ... "Rights User 7" menus. You can also specify the selection of applications for each user profile. **Note:** The designations in the user profile ("User 1", etc.) are set at the factory. You can change the designations in the user-specific settings (Section 6.4).

When the "Define" button is pressed, you can define whether the selected user profile should be protected with ID and password and which menu areas, if any, should be protected:

- "Appl. Setup": All application-specific settings («≡» key), (Section 7ff).
- "Wghparam": All weighing parameters, which are available in the user-specific settings («⚖» key) (Section 6.3).
- "Adjustweight": Definition of the external adjustment weights in the system settings "Adjust/Test" menu (Section 5.3.6).
- "User": User profile selection («☰» key), (Section 4.3).
- "User ID/Password": Definition of the ID and password in the user-specific settings "User" menu (Section 6.4).
- "System": All system settings (Section 5).
- "User Settings": All user-specific settings («⚖» key), (Section 6).
- "Application": Application selection using the «⋮» key (Section 4).

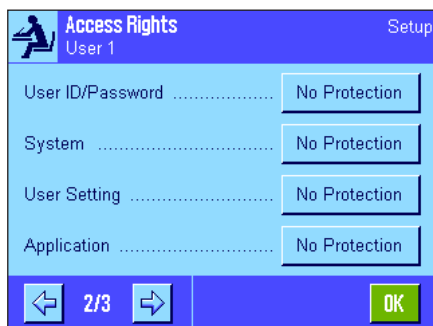

Each of the menu areas listed above can be protected individually:

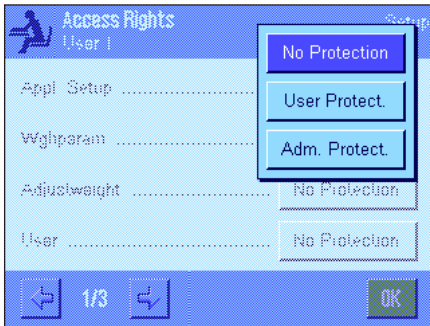

**“No Protection”:**

The menu area is freely accessible.

**“User Protect.”:**

A user ID and a user password must be entered to call up the relevant menu area. Information on user access codes can be found in Section 6.4. **Note:** All menu areas that are protected with a user ID and password can be opened using the administrator access codes.

**“Adm Protect”:**

An administrator ID and an administrator password must be entered to call up the relevant menu area. Information on administrator access codes can be found in Section 5.8.1.

**Factory setting:**

“No Protection” for all menu areas



**“Application Selection”**

On the third page of the access rights menu you can specify which applications should be available for the selected user profile.

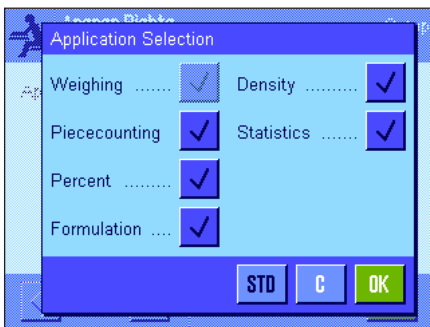

Only activated applications are displayed and can be selected in the application selection menu («:::» key).

**Note:**The application that is currently active for the selected user profile will appear light-colored in the display. This application cannot be deactivated.

**Factory setting:**

All applications are activated.

**5.8.4 Recording security-related operations**



The balance can document modifications to protected settings. A list of these operations can be viewed in the “Record” menu and recording can be switched on or off.

**Note:** If the memory is full (after approximately 50 recorded modifications), the oldest operation will be deleted automatically. Therefore, you should print out and archive the list from time to time if your laboratory standards or your QA system require full traceability of all modifications made.



The following options are available:

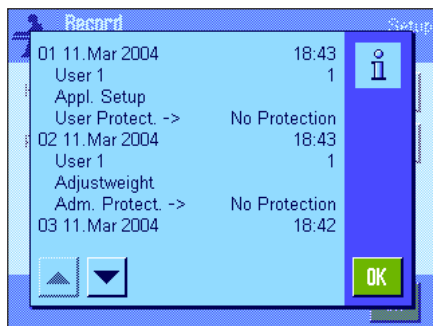

### “Recording”

When the “Show” button is pressed, a window appears with a list of the adjustments made to protected settings. Specific data is displayed for each modification (date and time, user, modification made). The list can be printed out by pressing the «» key provided that a printer is connected and activated as the output device in the peripheral settings. Alternatively, you can read out the list with an MT-SICS interface command.

### “Recording Mode”

This menu can be used to switch recording on or off.

**Factory setting:** Recording deactivated (“Off”).

## 5.8.5 Reminder function for changing the password

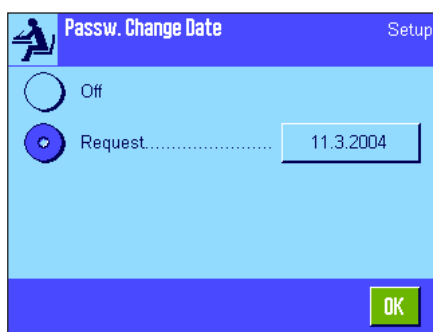

For security reasons, passwords should be changed regularly. In the “Passw. Change Date” menu you can define whether and when you want the balance to remind you to change passwords.

To activate the reminder function, select “Request” and then press the relevant button. A numeric input window appears. Enter the date (in the format DD.MM.YYYY) on which the balance should remind you to change your password.

**Factory setting:** Reminder function deactivated (“Off”)

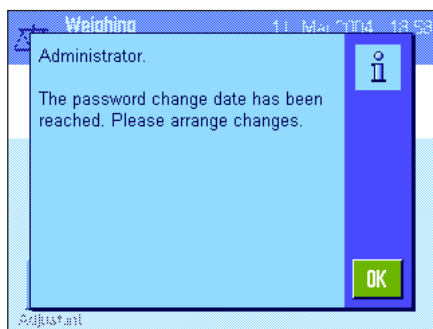

When the selected date is reached, the message opposite appears. It is then the responsibility of the administrator to ensure that all passwords are changed. The balance does not check that they have been changed. If you delete the message using “OK”, it reappears every 3 hours until you set a new date or switch off the reminder function.

## 5.8.6 Specifying the number of users

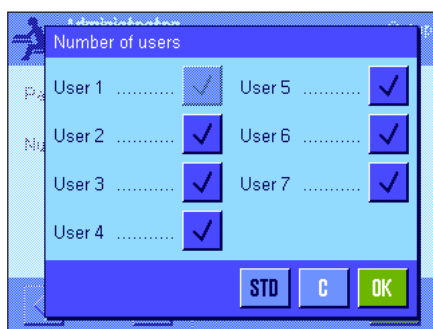

In the “Number of users” menu you can specify which user profiles should be available by pressing the «» key.

**Note:** The user profile currently loaded (“User 1” in this example) appears light-colored and cannot be deactivated. The user profile “Home” does not appear in this selection, since this profile cannot be deactivated.

**Factory setting:** All user profiles activated.

## 5.9 Settings for the level sensor

The built-in level sensor constantly monitors the correct horizontal alignment of your balance. In this menu you can activate or deactivate the level sensor, and define settings for the output of warnings when incorrect leveling has been detected. You can find information on the leveling procedure in Section 3. **Note:** On some models, the level sensor **cannot** be switched off.

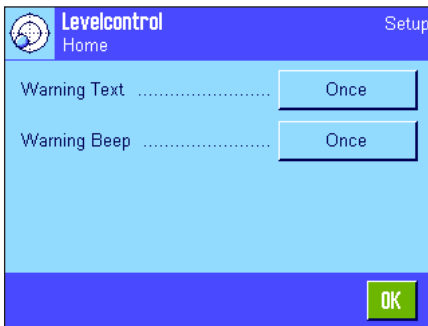

If the level sensor is activated, you can specify whether and how often a warning text and/or warning beep should occur when the balance is not precisely level by pressing the **Define** button.



The following settings are available for the "Warning Text" and "Warning Beep":

- "Off":** When the level is incorrect, only the status icon appears in the upper right-hand corner of the display. There is no warning text or beep.
- "Once":** After the level sensor detects that the level is incorrect, the warning text and warning beep occur only one time.
- "Repeat":** As long as the balance remains incorrectly leveled, the warning text and warning beep are repeated every 15 minutes.

**Factory setting:** Level sensor on/off: model-dependent  
 "Warning Text": "Once"  
 "Warning Beep": "Once"

**Note:**

- The Leveling Assistant (see Section 3) makes it easier for you to level the balance. You can call up the Assistant directly from the "Warning Text" window, which is displayed when the leveling is incorrect. If you deactivate the "Warning text" you have to start the Leveling Assistant by touching the information field zone in the display (see section 4.2).
- The level sensor is connected to the backlighting of the level indicator. When the level sensor is switched on, the level indicator is lit up. When the sensor is deactivated, the illumination of the level indicator is also switched off.

## 5.10 Printing the system settings

```

System
Adjust/Test
Adj. History
Selection
Manual adjust.          x
Temperature             x
Time Adjust.           x
Display Datasets Last 50
ProFACT                On
ProFACT
ProFACT
Weekdays
Monday                 x
Tuesday                x
Wednesday              x
Thursday               x
Friday                 x
Saturday               x
Sunday                 x
Time 1                  9:00
ProFACT
Time
Time 2                  Off
ProFACT
Time
Time 3                  Off
ProFACT
Time
Temp.Criterion 2 Kelvin
Protocol Trigger       On
Autom. ext. Adjust.   Off
Autom. ext. Adjust.
Autom. ext. Adjust.
Weekdays
Monday                 x
Tuesday                -
Wednesday              -
Thursday               -
Friday                 -
Saturday               -
Sunday                 -
Time                    17:03
Time
Adjustweights          Off
                       ECW-500/1
Weight                 500.0000 g
ID                     ECW-500/1
Certificate No.       MT-604/6

```

When you are in the menu for the system settings, you can print them at any time by pressing the «» key (provided that a printer is connected and activated as the output device in the peripheral settings).

The illustration opposite shows an excerpt from a printout of the system settings.

**Note:** The scope of the printout depends on where in the system settings you initiated the printout. If the «» key is pressed at the highest level of the system settings, all system settings will be printed. If, for example, printing is started in the "Peripherals" menu, only the settings for the peripheral devices will be printed.

## 6 User settings

This Section describes how to set basic settings for each user. This enables the balance to be adapted to the user's work technique and to specific tasks. The settings are stored under the active user profile and apply when working with all applications within this profile. When a user profile is called up, the relevant settings are loaded automatically.

### 6.1 Calling up user-specific settings



First, ensure that the correct user profile is active, i.e. the one whose basic settings you would like to modify. The 8 user profiles are available under the «» key.

Use the «» key to select the menu for the user-specific settings. **Note:** If access to the menu has been protected by the administrator, you must enter the appropriate ID and password.

### 6.2 Overview of the user-specific settings

The user-specific settings are represented by icons. The individual settings can be called up and changed by touching the icons. Detailed notes on the setting options can be found in later Sections.

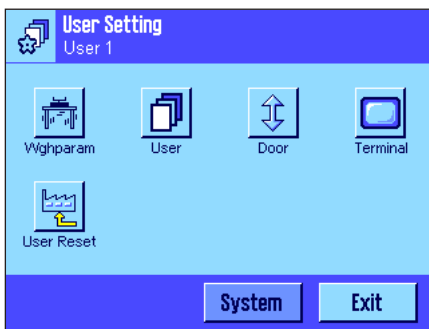

The following user-specific settings are available:

- “**Wghparam**”: Settings for adapting the balance to specific weighing tasks (Section 6.3).
- “**User**”: User information (name, password, etc.), (Section 6.4).
- “**Door**”: Settings for the doors of the glass draft shield (Section 6.5).
- “**Terminal**”: Settings for the display (brightness, etc.) and the behavior of the terminal (Section 6.6).
- “**User Reset**”: Resets the user-specific settings to the factory default settings (Section 6.7).

Once you have defined all the settings required, press the “**Exit**” button to return to the active application. The next sections introduce the user-specific settings in detail.

### 6.3 Defining weighing parameters

This menu can be used to adapt the balance to your specific requirements. **Note:** If access to this menu has been protected by the administrator, you must enter the appropriate ID and password.

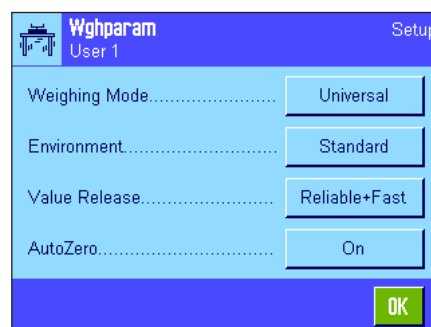

The following options are available:

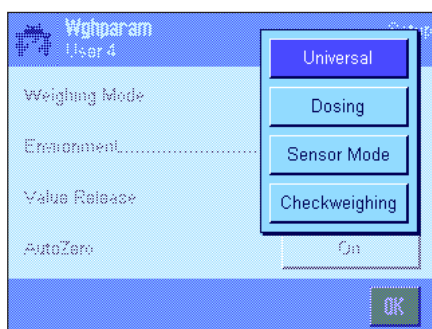

### "Weighing Mode"

The weighing mode setting is used to adapt the balance to the weighing mode. Select the "Universal" mode for all normal weighing operations or "Dosing" for dosing liquid or powdery weighing samples. With this setting, the balance reacts very quickly to the smallest changes in weight. The "Sensor Mode" setting supplies a weighing signal which is filtered to an extent which depends on the setting for the environmental conditions. The filter behaves linearly in relation to time (not adaptively) and is suitable for the continuous processing of measurement values. Under the "Checkweighing" setting the balance only responds to large changes in weight, and the measurement is therefore very stable. **Note:** The number of available settings depends on the model.

**Factory setting:** "Universal"

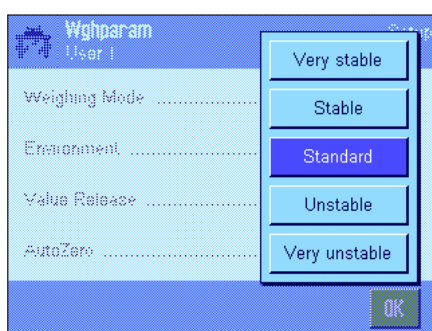

### "Environment"

This setting is used to ideally adapt the balance to the ambient conditions at the location. If you are working in an environment which is practically free from drafts and vibrations, choose the "Very stable" or "Stable" setting. If, on the other hand, you work in an environment where the conditions are continuously changing, select "Unstable" or "Very unstable". The "Standard" setting corresponds to an average working environment subject to moderate variations in the ambient conditions. **Note:** The number of available settings depends on the model.

**Factory setting:** "Standard"

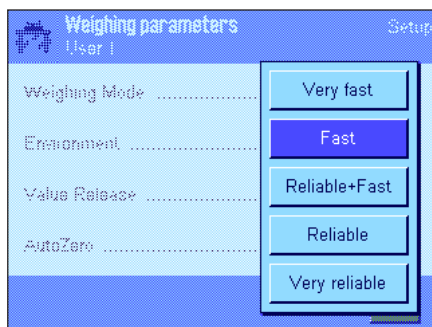

### "Measured Value Release"

This setting can be used to define the speed at which the balance regards the measured value as stable and releases it. The "Very fast" setting is recommended if you require fast results and repeatability is not very important. The "Very reliable" setting provides very good repeatability of the measured results but prolongs the settling time. In between, there are 3 other measured value release settings to choose from.

**Factory setting:** "Fast"

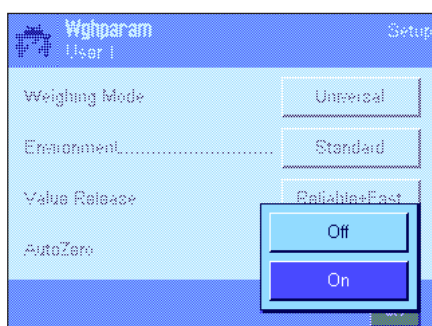

### "AutoZero"

**Note:** This menu point is not available on certified balances.

The automatic zero point correction function ("AutoZero") continuously corrects any deviations from the zero point, which can be caused by slight contamination on the weighing pan, for example.

This menu can be used to switch the automatic zero point correction function on or off.

**Factory setting:** "On" (switched on)

## 6.4 Entering user data

This menu can be used to define user names, select the dialog language and define user access codes.

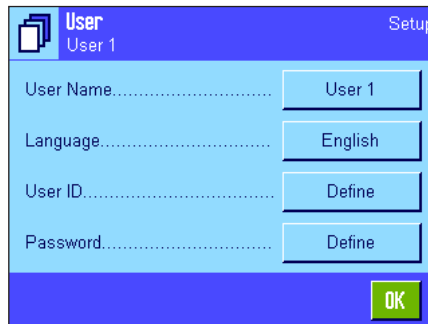

The following options are available:



### “User Name”

The name of the current user profile can be changed here (max. 20 characters). Alpha-numeric characters can be entered in the input window. **Note:** If the name you enter is already being used, an error message appears.

After modification, the user profile appears under the new name in the top left of the display and in the profile menu (◀ key). The user name is also printed in the records.

**Factory setting:** “User x” (x = 1 .. 7) and “Home”



### “Language”

This menu can be used to select the dialog language, in which you want to communicate with the balance. The language is switched immediately. All menus and messages appear in the selected language, with the exception of the interface parameters in the system settings (these are always in English).

**Warning!** If the dialog language is changed, you may no longer be able to enter the access codes for the administrator and user (password and ID). This is why the ID and password must always be entered in the same language in which they were defined.

**Factory setting:** Depends on the language package installed. Generally, the language of the destination country is preset.



### “User ID” and “Password”

The current user access codes (ID and password, max. 20 characters each) can be changed in these two menus, which have identical dialog boxes. These codes are required for accessing menu areas that have been protected at user level by the administrator (Section 5.8.3). If you delete the existing ID or password and do not enter a new code, an error message appears. **Note:** If access to both of these menus has been protected by the administrator, you must enter the current ID and password before you can change the codes.

**Factory setting:** For ID and password:

“0” (Null) for the “Home” profile

“1” for the “User 1” profile ... “7” for the “User 7” profile

## 6.5 Settings for the doors of the glass draft shield

In this menu you can adjust the function of the doors of the glass draft shield to your requirements

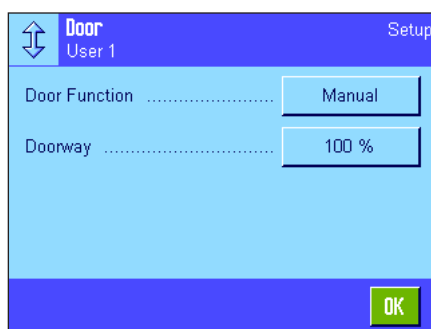

The following options are available:

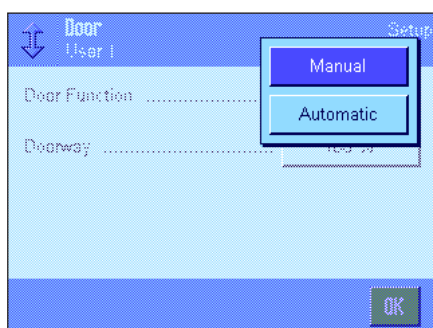

### “Door Function”

The **automatic door function** automatically opens and closes the doors of the glass draft shield as soon as this is necessary.

Examples:

- When you press the «→T←» key, the doors open automatically to allow you to place the tare weight on the pan.
- When you are prompted to place the adjustment weight on the pan while you are adjusting the balance, the doors automatically open. As soon as you have placed the weight on the pan, the doors automatically close again.
- The doors of the glass draft shield will close automatically whenever this is required to reach a stable weight value.
- The doors open and close automatically during many work processes (e.g. piece counting), depending on the current requirements of the application.

**Manual door function:** You will have to open and close the doors yourself (using the «↕», key, via SmartSens (Section 7) or by hand).

**Factory setting:** “Manual”

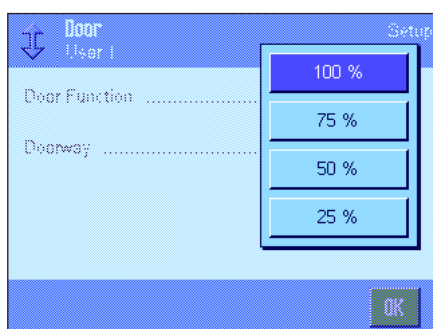

### “Doorway”

This setting allows you to define how wide the doors of the glass draft shield open (automatically or manually). If you select the 100% setting, the doors will open all the way. If you select “25%”, however, the doors will open only a quarter of the way. Two other intermediate settings can be selected.

If your application allows it, you can reduce the opening of the doors. This shortens the opening and closing times, making environmental influences (drafts) less bothersome.

**Factory setting:** “100%”

## 6.6 Terminal settings

This menu can be used to adapt the terminal to your requirements and adjust the display.

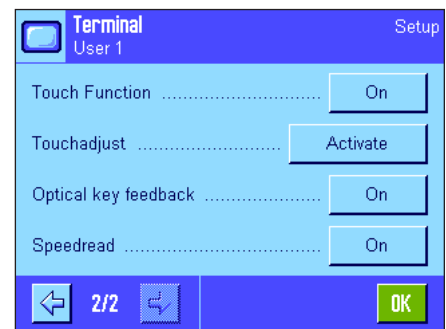

The following parameters are available:



### “Brightness”

This menu can be used to set the brightness of the display. If necessary, alter the brightness between 20% and 100% (in steps of 20%) using the arrow keys. Each time one of the two arrow keys is pressed, the brightness is altered immediately so that you can see the change right away.

**Factory setting:** 80%

**Note:** If the balance has not been used for 15 minutes, the brightness of the display is reduced automatically. This prolongs the service life of the backlighting. As soon as a key is pressed or the weight changes, the brightness is reset to the value selected here.

### “Contrast”

Setting for the display contrast (range from 0% - 100% contrast). Set in the same way as the brightness but in 2% steps.

**Factory setting:** 50%

### “Color Selection”

This menu can be used to adapt the color of the display to your personal taste. However, colors can also be used as a guide: if you use different colors for different user profiles, you can see at a glance which profile is currently active. In total, there are 8 color palettes to choose from.

**Factory setting:** Color palette 1 (blue with soft contrast)

**Note:** The color palettes in the left column offer a visually attractive appearance with soft contrast, while the palettes in the right column offer a more contrasty display for better readability under poor light conditions.

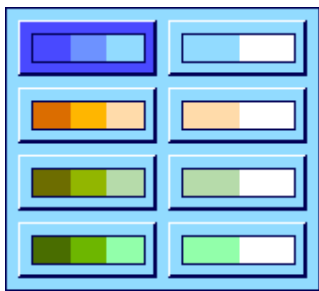

### “Sound”

Setting for the volume of the beep (range 0% - 100% in steps of 10%). Setting at 0% switches the sound off. A slider is available for setting the sound, as for setting the brightness and contrast.

**Factory setting:** 70%





### "Touch Function"

If you switch off the touch function for the "Touch Screen", the display no longer responds to touch in weighing mode and you can therefore no longer make settings by simply touching the display (except for function keys). **Important:** The touch function is always active in setting mode, as otherwise you would not be able to make settings.

**Factory setting:** "On"

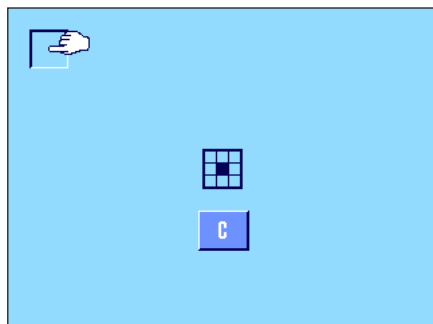

### "Touch Adjustment"

If you feel that the balance is no longer reacting correctly when you touch a specific part of the display, you can adjust the "Touch Screen". When the "Activate" key is pressed, a window appears and you are asked to touch the flashing area. This operation is repeated several times (it can be aborted at any time using the "C" key).



### "Optical key feedback"

A short beep sounds to confirm each time a key is pressed or a menu function is carried out. If you would like an additional optical confirmation, you can switch on the "Optical key feedback" function. In addition to the beep, the yellow LEDs at the bottom left and right of the status bar on the terminal light up briefly.

**Factory setting:** "On"

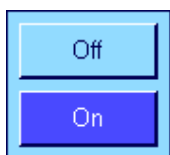

### "Speedread"

When this function is activated, the weighing result is displayed in a lighter color while it is unstable. When the result becomes stable, it is displayed in a darker color. If the "Speedread" function is deactivated, the weighing result is always displayed in the same color irrespective of whether or not it is stable.

**Factory setting:** "On"

## 6.7 Resetting user profile settings

This menu can be used to reset all settings for the active user profile to the factory default settings.

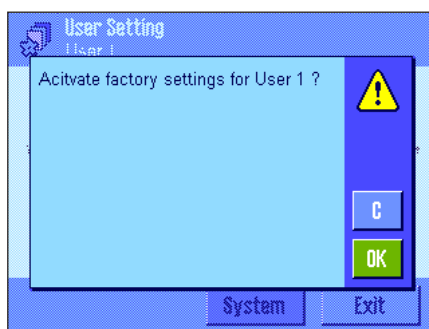

For security reasons, the above prompt appears. If you do not want to reset, press "C".

**WARNING: If you confirm the reset using "OK", the balance restarts and all user and application-specific settings for the active user profile are reset to the factory default settings. Consequently, all individual settings, including user ID and user password, are lost.**

## 6.8 Printing user-specific settings

```

User Setting
Wghparam
Weighing Mode  Universal
Environment    Standard
Value Release
                Reliable+Fast
AutoZero      On
User
User Name     User 1
Language      English
User ID       1
Door          Automatic
Door
Door Function Automatic
Doorway       100 %
Terminal
Brightness    80
Contrast      50
Colour selection
                PaletteBlueCold
Sound         70
Touch Function On
Optical key feedback On
Speedread     On
  
```

When you are in the menu for the user-specific settings, you can print them at any time by pressing the «» key (provided that a printer is connected and activated as the output device in the peripheral settings). The settings for the active user profile are printed.

The illustration opposite shows a sample printout with specific settings for the user profile "User 1".

**Note:** The scope of the printout depends on where in the user-specific settings you initiated the printout. If the «» key is pressed at the highest level of the user-specific settings, all settings will be printed. If, for example, printing is started in the "Terminal" menu, only the settings for the terminal will be printed.

## 7 The "Weighing" application

This Section describes the "Weighing" application. Here you will find information on how to work with this application and on the relevant setting options. **Please note that all settings for the "Weighing" application are stored under the active user profile. User-specific settings can thus be entered for this application. Therefore make sure that you have selected the desired user profile first.**

### 7.1 Selecting the application

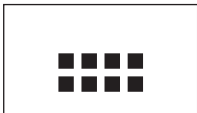

If the "Weighing" application is not already active, press the «::::» key. Touch the "Weighing" icon in the selection window. The balance is now ready for weighing.

### 7.2 Settings for the "Weighing" application

Simple weighing has already been described in Section 3. In addition to the operations described in Section 3 (zeroing, taring and performing a simple weighing), your balance offers numerous options for adapting the "Weighing" application to your specific requirements.

#### 7.2.1 Overview



The application-specific settings can be accessed via the «☰» key. When this key is pressed, the first of 5 menu pages is displayed.

The following settings are available for the "Weighing" application:



**"Function Keys":** Here you can specify which function keys are to appear at the bottom of the display. These keys enable direct access to specific functions (Section 7.2.2).

**"SmartTrac":** For specifying the visual appearance of the graphic weighing-in aid (Section 7.2.3).

**"Info Field":** Here you can specify which information fields are to be displayed (Section 7.2.4).

**"AutoPrint":** Here you can select whether the weighing result is to be printed automatically (Section 7.2.5).

Press the arrow button to access the next menu page.

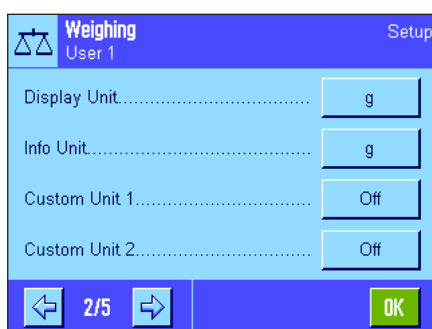

**"Display Unit":** For specifying the unit for the result display (Section 7.2.6).

**"Info Unit":** For specifying an additional weighing unit, which will appear in the appropriate information field of the display (Section 7.2.6).

**"Custom Unit 1":** For defining a custom weighing unit (Section 7.2.7).

**"Custom Unit 2":** For defining a second custom weighing unit (Section 7.2.7).

Press the arrow buttons to go back to the previous menu page or to access the next menu page.



The following settings are available on the third menu page:

- "Protocol"**: For selecting the information that is to be included in the weighing printouts (Section 7.2.8).
- "Print Key"**: For specifying the behavior of the «» key for manually printing weighing results (Section 7.2.9).
- "Transfer Key"**: For formatting the data output with the "Transfer" function key (Section 7.2.10).
- "Identification"**: For defining IDs (Section 7.2.11).

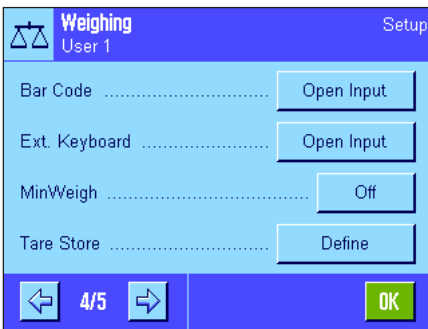

The following settings are available on the fourth menu page:

- "Bar Code"**: These settings are only relevant if a bar code reader is connected. Allows you to specify how bar code data is to be processed (Section 7.2.12).
- "Ext. Keyboard"**: These settings are only relevant if an external keyboard is connected. Allows you to specify how keyboard inputs are to be processed (Section 7.2.13).
- "MinWeigh"**: The "MinWeigh" function ensures that the weighing results are within a specified tolerance range, in accordance with the requirements of your quality assurance system. Here you can define the specifications for this function (Section 7.2.14).
- "Tare Store"**: Up to 10 tare weights can be predefined here, which can be called up during the weighing operation (Section 7.2.15).

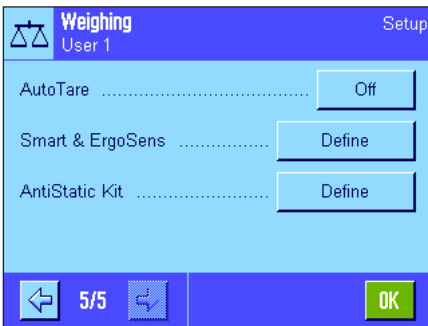

The following settings are available on the fifth menu page:

- "AutoTare"**: The automatic tare function automatically stores the first stable weight as the tare value. Here you can define the specifications for this function (Section 7.2.16).
- "Smart & ErgoSens"**: For programming the two "SmartSens" sensors on the terminal. In addition, up to two external "ErgoSens" sensors (optional) can be allocated a function in this menu (Section 7.2.17).
- "AntiStatic Kit"**: Settings for the optional antistatic kit (ionizer), which allows you to eliminate the static charge from weighing material (Section 7.2.18).

Once you have defined all the required settings, press the **"OK"** button to return to the active application.

The various settings for the "Weighing" application are described in detail in the following sections.

**Printing the application-specific settings:**

When you are in the menus for the application-specific settings, you can print the settings at any time by pressing the «» key (provided that a printer is connected and activated as the output device in the system settings).

The illustration opposite shows an excerpt from a printout of the application-specific settings.

Weighing	
Function Keys	
ID	-
Nominal	-
+Tol	-
-Tol	-
Lotcounter	-
Adjust.int	1
Adjust.ext	-
Test int	-
Test ext	-
PreTare	-

## 7.2.2 Selecting function keys

Function keys enable direct access to specific functions and settings in the application. The function keys are displayed in the application at the bottom of the display (see Section 4.2). Touching a key triggers the corresponding function. This menu can be used to specify which function keys are to be available in the application.

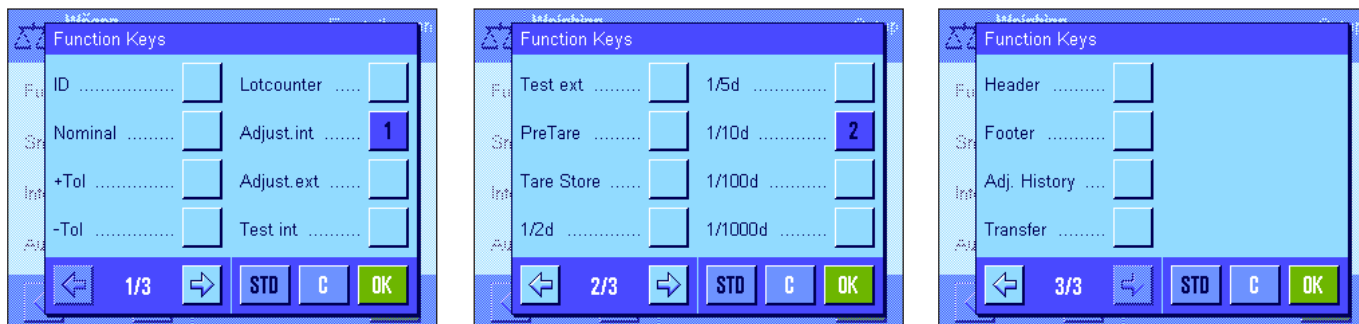

The function keys assigned a number are displayed in the application. The numbers determine the order of the function keys in the display. When a function key is activated or deactivated by being touched, the order of the keys is updated automatically. To completely redefine the order of the keys, first deactivate all the function keys and then activate them in the desired order. Press **"STD"** to return to the factory default setting. Press **"OK"** to save the modifications (press **"C"** to exit the input window without saving).

The following function keys are available.

### "ID":

This function key can be used to allocate IDs (descriptive text), which are also included in the records, to individual weighing processes. When the function key is pressed, a window appears, in which the ID can be selected and the desired text can then be entered. Information on defining IDs can be found in Section 7.2.11. Notes on working with IDs can be found in Section 7.3.4.

### "Nominal":

Specify the desired target weight (Section 7.3.5). The target weight is also used as a reference for the tolerances (described below).

### " +Tol" and "-Tol":

Specify the accuracy (tolerances) for the weighing to a target weight (Section 7.3.5).

### "Lotcounter":

This function key can be used to activate the item counter and to specify a start value (Section 7.3.3).

### "Adjust. int." and "Adjust. ext.":

For adjusting the balance using an internal or external adjustment weight. Notes on adjustment and printing adjustments can be found in Sections 7.4.2 and 7.4.3. **Note:** External adjustment is not available for certain certifiable balances.

### "Test int." and "Test ext.":

For checking the balance adjustment using an internal or external test weight. Notes on checking adjustments can be found in Sections 7.4.4 and 7.4.5.

### "PreTare":

Numeric entry of a fixed tare value (tare preset). Notes on entering tare values can be found in Section 7.3.2.

### "Tare Store":

For calling up a predefined tare value. Notes on specifying predefined tare values can be found in Section 7.2.15. Information on working with the tare memory can be found in Section 7.3.2.

### "1/2d" ... "1/1000d":

These function keys can be used to modify the resolution of the weighing result (Section 7.3.1). **Note:** For metrological reasons, the option for changing the resolution is not available on some certifiable balances.

### "Header" and "Footer":

These function keys are used to print the record header and footer (Section 7.2.8).

**"Adj. History":**

This function key can be used to display a list of adjustment operations that have been carried out (the operations that were selected in the system settings are displayed, see Section 5.3.1).

**"Transfer":**

This function key allows the current weight value to be sent directly to the connected host computer, without additional data (additional information). If desired, the output data can be formatted.

**Factory setting:**

"Adjust. int." and "1/10d" activated.

### 7.2.3 Selecting "SmartTrac"

"SmartTrac" is a graphic weighing-in aid, which can be used to display the used and available weighing range at any time (in some applications, SmartTrac even simplifies weighing in to a specific nominal value). In the application, "SmartTrac" appears below the weighing result on the right-hand side of the display (Section 4.2).

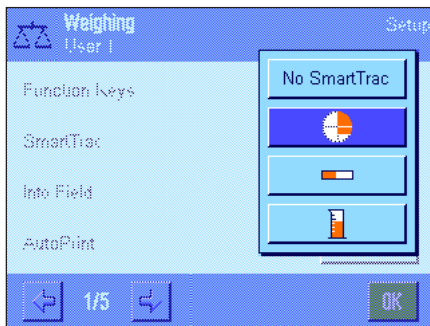

This menu can be used to select the "SmartTrac" display type or disable the function.

**Note:** This menu can also be called up directly from the application by touching "SmartTrac".

**Factory setting:** Round "SmartTrac" enabled.

### 7.2.4 Selecting information fields

The information fields continuously provide information on the set values, the recorded results, etc. In the application, the information fields appear on the left-hand side of the display, below the weighing result.

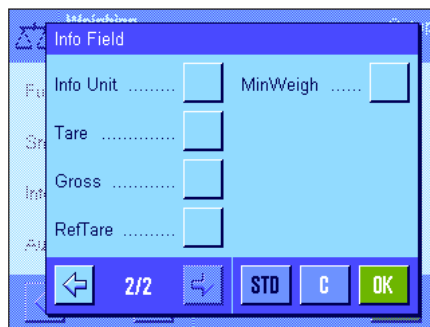
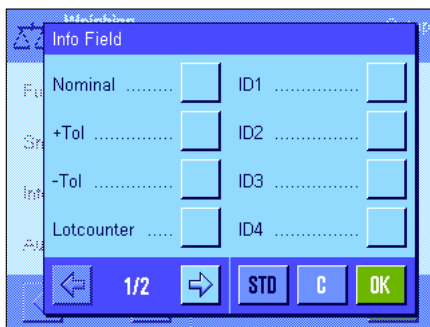

This menu can be used to specify which information fields are to be displayed. The fields assigned a number will be displayed in the application. The numbers determine the order of the information fields in the display. **Important:** For reasons of space, a maximum of 4 information fields can be activated. When an information field is activated or deactivated by touching it, the order of the fields is updated automatically.

To completely redefine the order of the fields, first deactivate all the information fields and then activate them in the desired order. Press "STD" to return to the factory default setting; press "C" to exit the input window without saving. To save the modifications, press "OK".

The following information fields are available:

**"Nominal":**

This information field shows the target weight that was entered through the function key with the same name.

**" +Tol" and "-Tol":**

This information field shows the tolerances for weighing to a target weight, which were entered through the function key with the same name.

**"Lotcounter":**

This information field displays the status of the item counter.

<b>"ID1", "ID2", "ID3" and "ID4":</b>	These information fields show the IDs entered via the "ID" function keys. <b>Note:</b> The defined names are displayed instead of "ID1", "ID2", "ID3" and "ID4" (Section 7.2.11).
<b>"Info Unit":</b>	This information field displays the weighing result in the second selected weighing unit (Section 7.2.6)."
<b>Tare":</b>	This information field shows the current tare value (in the same weight unit as the weighing result in the main display)."
<b>Gross":</b>	This information field shows the current gross weight value (in the same weight unit as the weighing result in the main display).
<b>"Ref. Tare":</b>	If the "MinWeigh" function is activated (Section 7.2.14), this information field displays the upper limit of the reference tare.
<b>"MinWeigh":</b>	If the "MinWeigh" function is activated (Section 7.2.14), this information field displays the required minimum initial weight value based on the reference tare.
<b>Factory setting:</b>	No information fields activated.

## 7.2.5 Specifications for automatic record printing

This menu option can be used to specify whether and under which conditions the balance is to print the weighing result automatically. The information defined for printing single values is printed (Section 7.2.8).

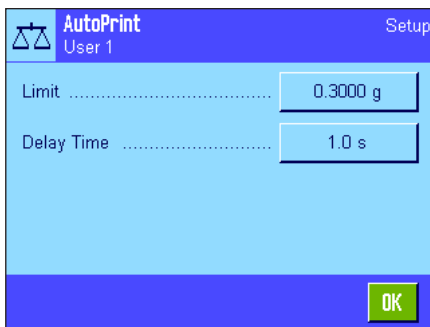

When you activate the "AutoPrint" function ("On"), press "Define" to define the criteria for automatic record printing:

<b>"Limit":</b>	For automatic record printing to occur, the weight value must fall short of and then exceed the specified limit.
<b>"Delay Time":</b>	As soon as the limit is exceeded, the "Delay Time" starts. Once this time has elapsed, the weight value is recorded and printed. This setting allows the weighing result to be printed with a defined delay, if necessary.

**Factory setting:** "Off" (automatic record printing is deactivated).

## 7.2.6 Selecting weighing units

The "Display Unit" and "Info Unit" menus can be used to specify the weighing units you wish to use. By selecting different units, the weighing result can be displayed in two different weighing units simultaneously.

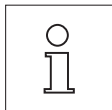

**Note:** Depending on country-specific rules, on certified versions of balances some weighing units may not be available.

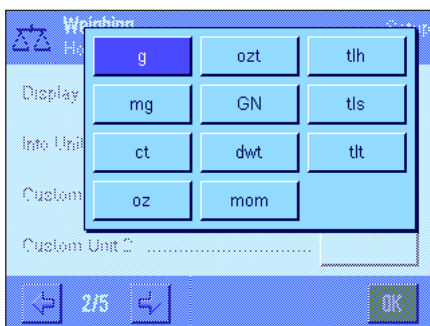

The same units are available for both the "Display Unit" and the "Info Unit" (see also conversion table in Section 19.1). The number of available weighing units depends on the model. **Note:** In the example shown at left, all available units are visible at a glance. With a larger selection, the units are displayed in the form of a rolling list.

When the "Display Unit" is modified, the current weighing result and the values in the "Tare" and "Gross" information fields (Section 7.2.4) are displayed in the new weighing unit. The "Info Unit" is used for the information field of the same name (Section 7.2.4).

**Factory setting:** Depends on the model (for both units).

## 7.2.7 Defining custom weighing units

A custom weighing unit can be defined in both the "Custom Unit 1" and the "Custom Unit 2" menus. Calculations can thus be carried out immediately once the weighing result is recorded (e.g. for surfaces or volumes). Custom weighing units are available in all menus and input fields where weighing units can be selected (but not when tare values are entered manually).

When you activate one of the custom units ("On"), press "Define" to select the following fields for defining the unit:

"Formula":

This option can be used to specify how the value specified below for "Factor" is to be calculated. There are 2 formulae to choose from: "F" stands for the factor and "Net" for the weight value. The first formula multiplies the net weight by the factor, whereas the second formula divides the factor by the net weight. The formula can be used, for example, to take into account a known error factor when recording the weight.

"Factor (F)":

This option can be used to specify the factor ( $-10^7$  ...  $10^7$ ) for calculating the effective weighing result (net weight), using the previously selected formula.

"Name":

Enter a name for your custom weighing unit (maximum of 4 characters). **Note:** Weight units ("g", "kg", etc.) must not be entered. This is prevented with an error message.

"Result Output Format":

This option can be used to specify the format for the weighing result. **Example:** A setting of "0.05" defines rounding to 2 decimal places with a multiple of significance of 5 (a recorded result of 123.4777 is therefore displayed as 123.50). **Note:** This function can only be used to **reduce** the resolution of the weighing result; i.e. do not enter a value that exceeds the maximum resolution of your balance.

Factory setting:

No custom unit defined ("Off").

## 7.2.8 Defining the record

This menu can be used to specify what information is to appear in the weighing records.

This menu is divided into 3 submenus for greater clarity. The options for record headers, printing single values and for record footers can be defined in these submenus.

**Note:** Sample printouts can be found at the end of this section.



## Options for record headers

This submenu can be used to define the information to be printed at the top of the weighing record (before the results). The header is printed automatically if it has been defined as part of the weighing record (see "Options for printing single values" on the next page). It can also be printed separately by pressing the "Header" function key.

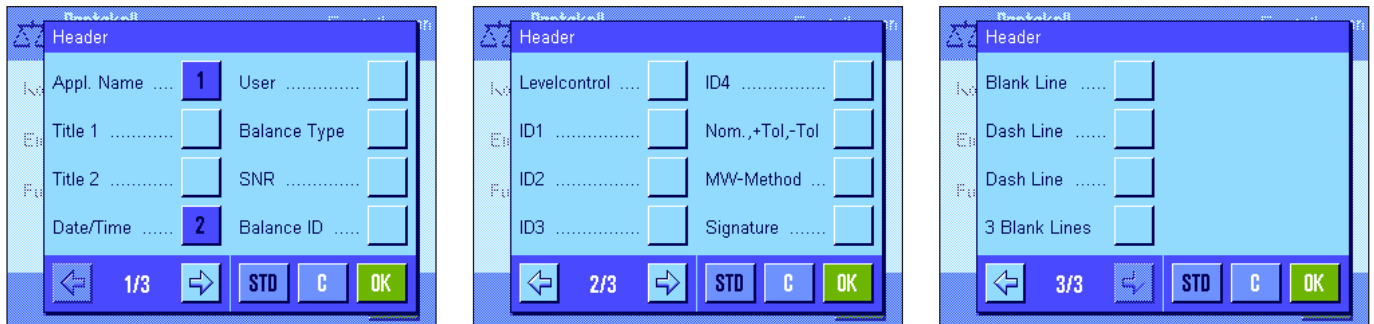

Touch the relevant boxes to activate the desired information. If a box is checked, the relevant information will be printed. Press "STD" to return to the factory default setting; press "C" to exit the input window without saving. To save the modifications, press "OK".

The following header options are available:

"Appl. Name":	The application name is printed ("Weighing").
"Title 1" and "Title 2":	The defined record title is printed (Section 7.2.11).
"Date/Time":	The current date and time are printed.
"User":	The name of the current user is printed.
"Balance Type":	The balance model is read from the balance electronics and cannot be changed by the user.
"SNR":	The serial numbers for the terminal and weighing platform are read from the balance electronics and cannot be changed.
"Balance ID":	The balance ID defined in the system settings is printed.
"Levelcontrol":	A printout is made, indicating whether the balance is correctly leveled or not.
"ID1", "ID2", "ID3" and "ID4":	The IDs defined via the "ID" function key are printed (Section 7.3.4).
"Nom., +Tol, -Tol":	Prints the specified target weight and the selected tolerances.
"MW Method":	The selected MinWeigh method is printed (Section 7.2.14).
"Signature":	Inserts a line for signing the printout.
"Blank Line":	A blank line is printed.
"Dash Line":	Inserts a dashed line (this option is available twice).
"3 Blank Lines":	Prints 3 blank lines at the end of the printout (paper advance).
<b>Factory setting:</b>	"Appl. Name" and "Date/Time" activated (in this order).

**Options for printing single values**

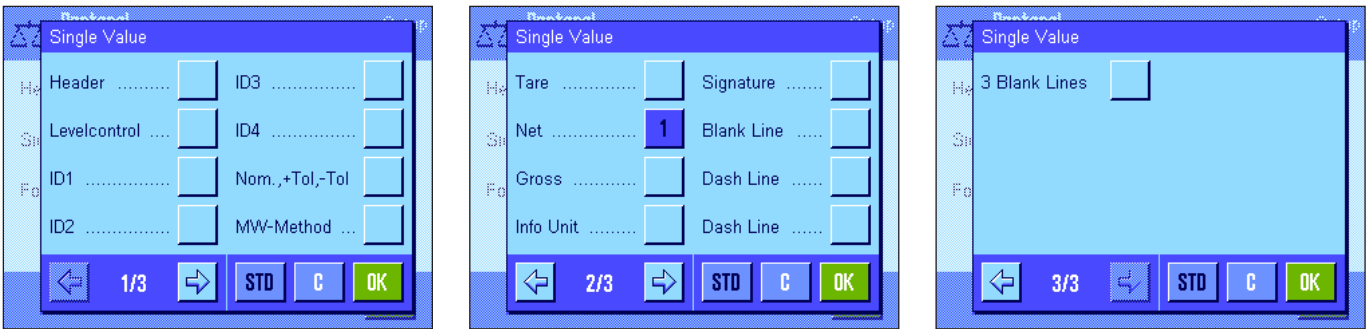

In this submenu you can specify which information should be printed for each individual weighing result. Printing is initiated by pressing the button «⏏» or automatically (if the automatic printing function is activated, see Section 7.2.5).

The following information is available for printing weighing results:

- "Header":** The information defined for the header is printed (see above).
  - "Levelcontrol":** A printout is made, indicating whether the balance is correctly leveled or not.
  - "ID1", "ID2", "ID3" and "ID4":** The IDs defined via the "ID" function key are printed (Section 7.3.4).
  - "Nom., +Tol, -Tol":** Prints the specified target weight and the selected tolerances.
  - "MW Method":** The selected MinWeigh method is printed (Section 7.2.14).
  - "Tare":** The tare value for the current weighing operation is printed.
  - "Net":** The net weight value for the current weighing operation is printed.
  - "Gross":** The gross weight value for the current weighing operation is printed.
  - "Info Unit":** The weighing result (net value) is also printed in the selected info unit (Section 7.2.6).
  - "Signature":** Inserts a line for signing the printout.
  - "Blank Line":** A blank line is printed.
  - "Dash Line":** Inserts a dashed line (this option is available twice).
  - "3 Blank Lines":** Prints 3 blank lines at the end of the printout (paper advance).
- Factory setting:** "Net" is activated.

**Options for record footers**

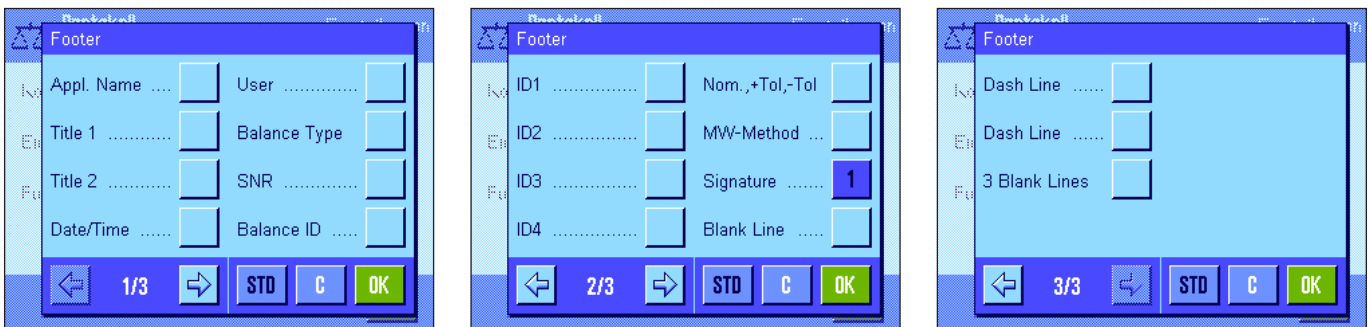

This submenu can be used to define the information to be printed at the bottom of the weighing record after the results (single values). The footer is printed when the "Footer" function key is pressed. The footer options are the same as those for the header, only the "Levelcontrol" option is unavailable.

- Factory setting:** "Signature" is activated.

**Sample printouts**

"Header" / "Footer"

```

----- Weighing -----
20.Jan 2005          19:08
T1
T2
User Name           User 1
Balance Type        XP504
Balance ID          LAB-1/4
ID1
Balance is levelled
Nominal             0.00 g
+Tol                2.50 %
-Tol                2.50 %
MW-Method           Off
Min.Weight by Tare
-----
Signature
.....

```

"Single Values"

```

----- Weighing -----
20.Jan 2005          19:18
      N      255.5051 g
      T      17.7372 g
      G      273.2423 g
-----

```

**Note regarding printed reports:** Depending on country-specific rules, on certified versions of balances the uncertified decimal places are displayed in brackets.

**7.2.9 Specifications for manual record printing**

The settings in the "Print Key" menu can be used to specify the behavior of the «» key (record printing).

**"Stable":**

When the «» key is pressed, the record is not printed until the weighing result is stable.

**"Dynamic":**

When the «» key is pressed, the record is printed immediately, regardless of whether the weighing result is stable or not.

**"Off":**

When the «» key is pressed, no record is printed as the key is inactive.

**Factory setting:**

"Stable".

### 7.2.10 Formatting the output data

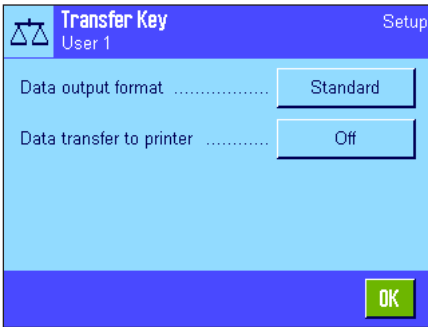

You can use the "Transfer" function key to transmit the stable weight value across the interface to a host computer (Section 7.2.2). In this menu you can specify how you want the output values to be formatted. You may need to do this if you use your balance together with other instruments, programs, or peripheral devices that require a particular data format. You can also use this menu to specify whether the data should only be output to the host or also to the printer.

At the factory, the data output is set to a **standard format** that is essentially the same as the weight value displayed on the terminal but followed by end-of-line characters that are defined for the host (Section 5.7). Negative weight values have a minus sign placed before the value. The output weight value is left-justified.

Example (-12.8934 g):

1	2	3	4	5	6	7	8	9	10	11	12
-	1	2	.	8	9	3	4		g	C <sub>R</sub>	L <sub>F</sub>

**Note:** If you reduce the resolution of the displayed value, the weight value is also transmitted to the host with reduced resolution.

If, at the time when the data are transmitted, the balance is displaying an underload or overload, "UNDERLOAD" or "OVERLOAD" is transmitted instead of the weight value.

If you want to change the output format, touch the button next to "Data output format".

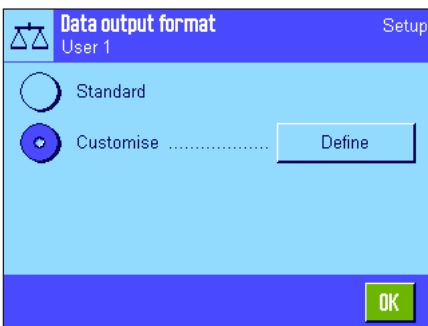

Activate "Customise" and then touch the "Define" button.

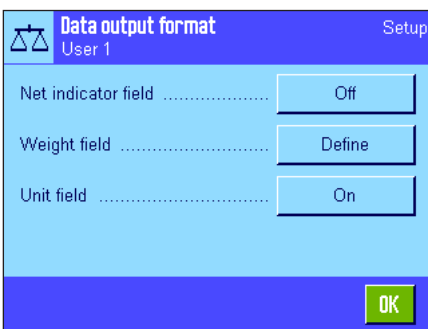

This menu contains settings for the following data fields:

- Net weight symbol
- Weight value
- Weight unit

In the output data, these fields are separated by a space character. The complete data record is terminated with the end-of-line characters that were defined for the host (Section 6.7).

The settings for the individual data fields are explained below.

### Net weight symbol

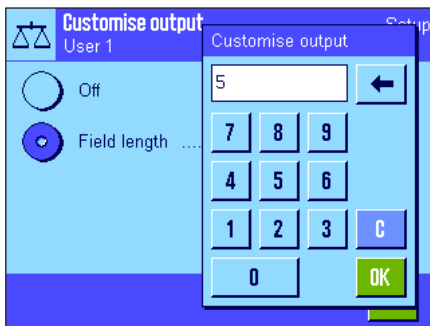

In the standard output format, net weights are not specially identified. If you want the net weights to be preceded by an "N", you must activate this function and also specify the field length (1 – 10 characters). The net symbol is left-justified in the field. **Note:** If the balance has not been tared, the net symbol is not transmitted. Instead, space characters corresponding to the selected field length are transmitted.

**Factory setting:** Net weight symbol deactivated.  
Field length 5 characters.

### Format of the weight value

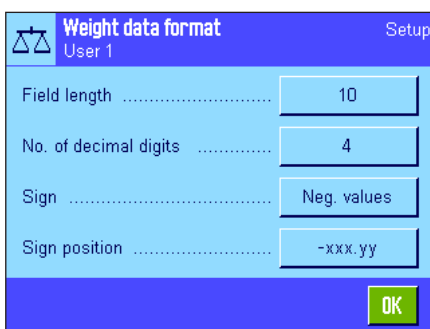

To format the weight value, the following options are available:

**"Field length":** Total length of the data field for the weight value including sign, decimal point, and decimal places (1 – 20 characters). **Note:** Depending on your setting, enough decimal places will be output for the weight value shown on the terminal to be completely transmitted. The weight value is output right-justified. **Factory setting:** 10.

**"No. of dec. digits":** Number of decimal places (0 – 6 digits). If the set number is less than the number of decimal places displayed on the terminal, the value will be rounded to the selected number of decimal places before it is transmitted. **Factory setting:** Max. number of decimal places of the balance.

**"Sign":** When set to "Always", the weight value is always preceded by a plus or minus sign. If you select "Neg. values", negative values will be preceded by a minus sign, but positive values will be transmitted without a sign. **Factory setting:** "Neg. values".

**"Sign position":** You can use this setting to specify whether the sign should be immediately in front of the weight value (right justified) or with a gap in between (left justified). **Factory setting:** Right justified (immediately in front of the weight value).

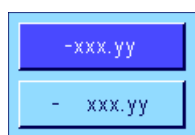

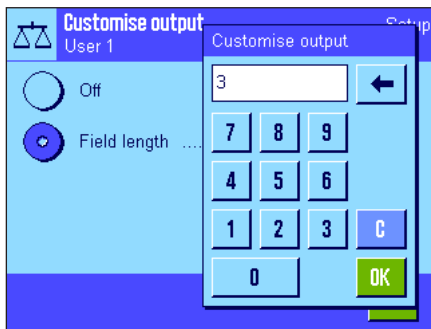

**Field for the weight unit**

In the standard output format, each weight value is output with the respective weight unit (corresponding to the current display unit). You can use this menu to specify whether weight values should be transmitted with or without the unit, and if with, also the length of the weight unit field (1 – 5 characters). Irrespective of the field length you set for the weight unit, enough characters will always be output for the weight unit displayed on the terminal to be completely transmitted. The weight unit is output left justified (separated from the weight value by a gap).

**Factory setting:** Weight unit output is activated.  
Field length 3 characters.



**Data output on the printer**

When you press the "Transfer" function key, the data are normally only transmitted to the host. If you also want to send the data to the printer, activate the setting "Data transfer to printer". **Note:** The previously described settings for formatting the data do not affect how the data is output to the printer. This is entirely controlled by the protocol settings (Section 7.2.8).

**Factory setting:** Data output to the printer is deactivated ("Off").

**7.2.11 Defining IDs and record titles**

This menu can be used to activate and rename the 4 IDs, which are available under the "ID" function key (Section 7.2.2). In addition, you can define two titles for the weighing records.

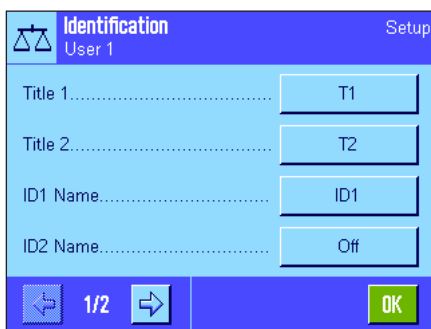

**Record Title ("Title 1" and "Title 2"):**

The names entered (e.g., the company name) can be printed in the weighing records. The maximum permissible length of the record title is 20 characters.

**IDs ("ID 1 Name" ... "ID 4 Name"):**

Select the ID that you wish to activate/deactivate or rename. **Note:** Deactivated IDs ("Off") can no longer be selected under the "ID" function key.

A window appears, in which you can activate the ID and rename it.



The factory-set ID names are "ID1", "ID2", "ID3" and "ID4". They can be replaced by custom names, e.g. "Client" for "ID1", "Order" for "ID2", "Lot" for "ID3" and "Sample" for "ID 4".

To change the current ID name, press the corresponding button. An alphanumeric input field appears, in which the new name can be entered (maximum of 20 characters). The ID is now available with the new name under the "ID" function key.

The entered names also appear as the names of the relevant information fields (Section 7.2.4) and can be printed on the weighing records (Section 7.2.8).

Notes on working with IDs can be found in Section 7.3.4.

**Factory setting:** "T1" and "T2" as the record titles  
 "ID1" activated (Name = "ID1")

## 7.2.12 Specifications for processing bar code data

If a bar code reader is connected to your balance, this menu can be used to specify how the bar code data is to be processed. The following settings are available:

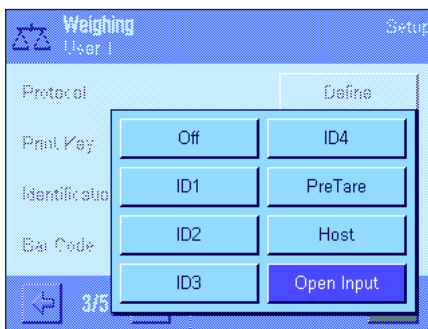

**"Off":** No bar code data is processed. This setting should be used if no bar code reader is connected.

**"ID1"..."ID4":** The received bar code data is treated like identification text and assigned to the relevant ID (Section 7.3.4). **Note:** If you have defined ID names (Section 7.2.11), they are used instead of "ID1"..."ID4".

**"PreTare":** The bar code data is interpreted as the value for the tare preset (Section 7.3.2).

**"Host":** The bar code data is not processed in the balance, but is transmitted directly to a connected PC. If no PC is connected or the PC cannot receive the data, the data is ignored.

**"Open Input":** The bar code data is written to the input window (e.g., item counter, ID or manual tare) that is currently open in the application and the input window is then closed automatically. If no input window is open, the data is ignored.

**Factory setting:** "Open Input".

**Note:** If you connect a bar code reader to your balance, configure the interface in the system settings accordingly (Section 5.7).

### 7.2.13 Specifications for processing keyboard entries

If an **external keyboard** is connected to your balance, this menu can be used to specify how the data is to be processed. The following settings are available:

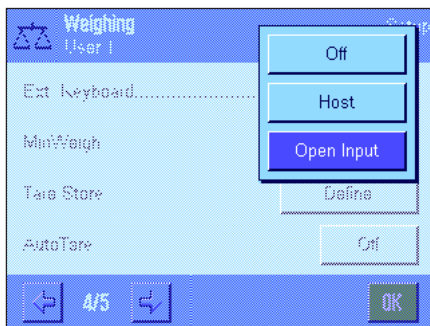

**"Off":** No keyboard entries are processed. This setting should be used if no keyboard is connected.

**"Host":** The keyboard entries are not processed in the balance, but are transmitted directly to the connected PC. If no PC is connected or the PC cannot receive the data, the data is ignored.

**"Open Input":** The keyboard entries are written to the input window (e.g., item counter, ID or manual tare) that is currently open in the application and the window is then closed automatically. If no input window is open, the data is ignored.

**Factory setting:** "Open Input".

**Note:** If you connect an external keyboard to your balance, configure the interface in the system settings accordingly (Section 5.7).

### 7.2.14 Settings for the "MinWeigh" function

**The menu containing the settings for the "MinWeigh" function is deactivated ex works and cannot be accessed. The "MinWeigh" function must be enabled and programmed by a service technician. If you need to use this function, but cannot access it in the menu, please contact your METTLER TOLEDO dealer.**

The "MinWeigh" function ensures that the weighing results are within a specified tolerance range in accordance with the requirements of your quality assurance system.

The service technician will use weights on site to determine the required minimum initial weight values according to your QA specifications and will then load these values onto the balance. Up to 3 tare values can be defined with the corresponding minimum initial weight values. In addition, the service technician will set the **weighing parameters** (Section 6.3) to values that ensure the required tolerance range is observed. **These settings cannot be modified by the user while the "MinWeigh" function is active.**

Once the balance programming is complete, the service technician creates a **certificate** that documents the measurements, tolerances and corresponding tare and minimum weight values for the initial weighing. Using the "MinWeigh" function ensures that the weighing results meet the specifications of the certificate and thus comply with your QA guidelines. Information on working with the "MinWeigh" function can be found in Section 7.3.6.

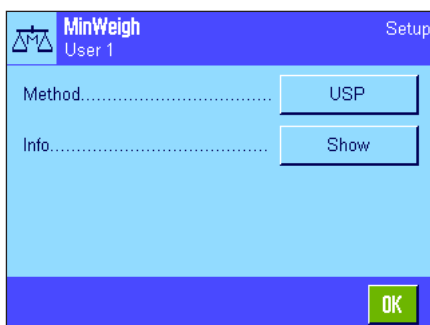

If the "MinWeigh" function has been enabled, it can be activated or deactivated in the menu. When the function is activated, press "Define". The following options are available:

**"Method":** This is the name of the QA standard that you are using. Up to 3 methods are available, e.g. "USP", "SOP" and "GLP". **Note:** The method names are predefined. The service technician can adapt the names according to your requirements, e.g. if you are using internal company QA methods.

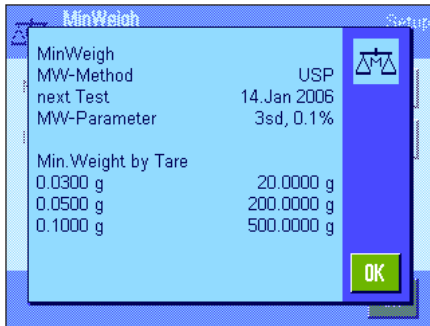

**"Info":**

When "Show" is pressed, a window opens containing information about the "MinWeigh" function (method, date of the next test by the service technician and the minimum required weight values defined by the service technician in relation to reference tare values). Press the «☰» key to print the information.

**Factory setting:**

"MinWeigh" function deactivated ("Off").

## 7.2.15 Defining and activating the tare memory

This menu can be used to define and rename up to 10 tare values, which are available under the "Tare Store" function key (Section 7.2.2).



Select the tare memory that you wish to activate/deactivate, rename or modify the weight value for. **Note:** Deactivated IDs ("Off") can no longer be selected under the "Tare Store" function key.

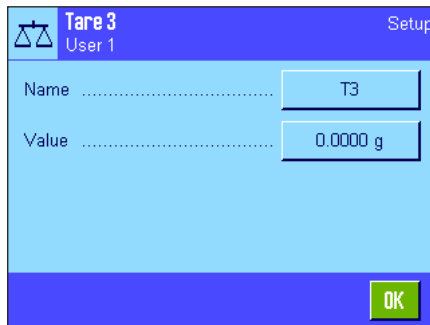

A window appears, in which you can activate and rename the desired tare memory as well as modify its weight value.

The designations of the tare memory examples are "T1" ... "T10". The names can be customized, e.g. the name of a tare container can be used.

To change the current tare memory name, press the corresponding button. An alphanumeric input field appears, in which the new name can be entered (maximum of 20 characters). The tare memory is now available with the new name under the "Tare Store" function key. **Note:** Even though the maximum permissible length of the name is 20 characters, we recommend that you use short names, as a maximum of only 10 characters can be displayed under the "Tare Store" function key.

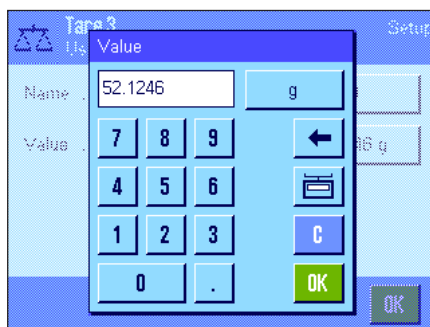

To enter the weight value, press the corresponding button. A numeric input field appears, in which the tare value can be entered. **Note:** Instead of typing in the value, you can place the relevant tare container on the weighing pan and then press the button with the balance icon. The measured weight value is thus transferred directly.

Notes on working with the tare memories can be found in Section 7.3.2.

**Factory setting:**

All tare memories are deactivated ("Off")

### 7.2.16 Settings for the automatic tare function

This menu option can be used to specify whether and under which conditions the balance is to automatically interpret the first weight following a zero setting as the tare. Notes on working with the automatic tare function can be found in Section 7.3.2.



When you activate the "AutoTare" function ("On"), press the button to define the weight criterion for the automatic tare function:

**"Limit":** This value specifies the minimum weight that must be placed on the weighing pan for it to be automatically saved as the tare. If the weight is below the limit, the value is not automatically transferred to the tare memory.  
**Note:** Instead of typing in the value, you can place your lightest tare container on the weighing pan and then press the button with the balance icon. The measured weight value is thus transferred directly as the limit.

**Factory setting:** "Off" (automatic tare function is deactivated).

### 7.2.17 Settings for SmartSens and ErgoSens

This menu option can be used to activate/deactivate each of the two contact-free sensors (SmartSens) in the top left and right corners of the terminal and to assign each sensor a function. The same settings are available for a maximum of two external ErgoSens sensors. The ErgoSens sensor is an optional external sensor with the same functions as the built-in SmartSens sensor. A maximum of 2 external ErgoSens sensors can be connected to the balance.

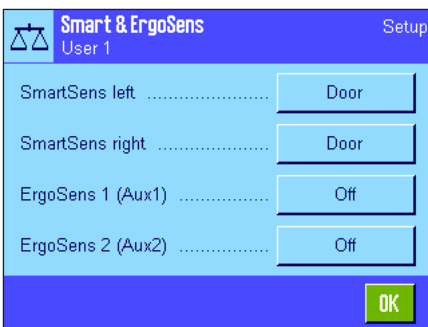

Each of the 4 sensors can be assigned one of the following functions by touching the relevant button:

- "Off":** The sensor is inactive.
- "Door":** Opening and closing the doors of the glass draft shield.
- "→0←":** Zero the balance.
- "→T←":** Tare the balance.
- "Print":** Start the print process.
- "ID1"..."ID4":** Open the input window for the relevant ID.
- "Header":** Print the header.
- "Footer":** Print the footer.
- "Pre Tare":** Open the input window to enter a fixed numeric tare value (tare preset).
- "1/2d" - "1/1000d":** Change the resolution of the weighing result.
- "AntiStatic Kit":** **This setting is only available for "ErgoSens 1" and "ErgoSens 2".** The optional antistatic kit is connected to one of the two ErgoSens connections ("Aux 1"/"Aux 2"). For the antistatic kit to function, it must be selected under "ErgoSens 1" or "ErgoSens 2" depending on the connection used. You can find additional information on the antistatic kit in Section 7.2.18.
- "Transfer":** Transmits the stable formatted weight value across the interface.

**Note:** If a function is activated, which emulates a key on the terminal, the relevant icon lights up below the corresponding sensor in the status bar ("↑", "→0←", "→T←" or "☰"). For all other settings (that emulate function keys of the same name), the green "F" (function) icon lights up. No icon lights up when the sensor is deactivated.

**Factory setting:** SmartSens left and right configured for door operation.  
 "Off" for both ErgoSens.

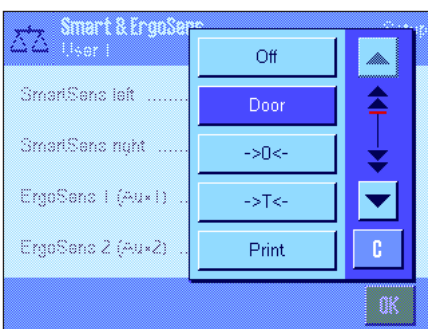

## 7.2.18 Settings for the optional antistatic kit

Settings for the optional antistatic kit eliminates the static charge of weighing material. The antistatic kit is connected to one of the two "Aux 1" or "Aux 2" connections at the rear of the balance (both of these connections are also used for the optional ErgoSens). **The antistatic kit must be selected in the ErgoSens settings for the balance to recognize it** (see Section 7.2.17; also see the instructions supplied with the antistatic kit).

In this menu option you can make settings for the operating principle of the antistatic kit.

The following settings are available:



### "After door opened":

Here you can define whether ionization will occur when the glass draft shield is opened ("Active") or whether no ionization will occur ("Inactive"). With the "Active" setting, ionization will occur continuously until the doors are closed again (a maximum of 10 minutes).



### "After door closed":

This setting defines the number of seconds ionization should occur after the doors close (adjustment range 0 ... 1000 seconds). **Note:** If you set it for "0" seconds, there will be no ionization after the doors close.

### Factory setting:

Ionization occurs when the draft shield is open ("Active"). Ionization occurs for 5 seconds after the doors close.

## 7.3 Working with the "Weighing" application

Simple weighing has already been described in Section 3. This section describes how the various functions in the "Weighing" application are used in practice.

### 7.3.1 Changing the resolution of the weighing result

The balance is set ex works so that the weighing result is displayed at the maximum resolution for the balance model (corresponds to 1d). While you are working, you can change the resolution of the weighing result at any time.



To change the resolution of the weighing result, the relevant function keys must be activated (Section 7.2.2). The following function keys can be used to display the weighing result at a lower resolution:

"1/2d": Displays the last decimal place in increments of 2

"1/5d": Displays the last decimal place in increments of 5

"1/10d": 10x lower resolution

"1/100d": 100x lower resolution

"1/1000d": 1000x lower resolution.

Press the relevant function key again to show the weighing result at the normal resolution.

**Note:** These function keys are inactive when the "MinWeigh" function is on (Section 7.2.14) or when a custom weighing unit is used (Section 7.2.7).

### 7.3.2 Tare options

The tare is usually determined by placing the weighing container on the pan and pressing the «→T←» key. The balance offers other tare options, however, which will make your day-to-day work easier.

#### Manual entry of the tare value (tare preset and manual tare)

If you are working with the same weighing container over an extended period of time, you can enter its weight manually. This eliminates the need for taring when the weighing container is placed on the pan. When the weighing container is lifted off the pan, the tare weight is displayed as a negative value. When the container is placed on the pan again, the display is set to zero and the balance is ready for weighing.



To enter a tare preset, the relevant function key must be activated (Section 7.2.2). When the function key is pressed, the window for entering the tare value appears.

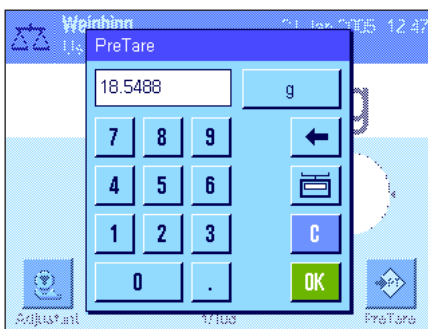

Type in the desired tare value. Check the weighing unit, which is shown to the right of the tare value (custom weighing units are not available when the tare value is entered manually).

**Note:** Instead of typing in the value, you can place the relevant tare container on the weighing pan and then press the button with the balance icon. Wait until the value displayed is stable before you accept it with "OK"!

Once you have entered the value, press "OK" to activate the tare preset.

The tare preset value is stored until a new value is entered, the «→0←» or «→T←» key is pressed, or the balance is switched off.

#### Using the automatic tare function

The balance can be configured so that the first weight placed on the pan is always automatically interpreted as the tare. The "AutoTare" function must be activated in the menu in order to use this function (Section 7.2.16).

To start automatic taring, press the «→0←» button (otherwise the tare weight will not be used automatically), then place the empty container on the weighing pan. As soon as the weight value becomes stable, this is used as the tare value. The weight display is set to zero and the "Net" icon appears. You can now begin weighing. After the full container is removed, the "Net" icon disappears and the stored tare value is deleted.

#### Working with tare memories

If you are working with different tare containers, you can store their weights and call them up at any time during the weighing operation at the touch of a button. Up to 10 tare memories can be defined.



In order to use the tare memory, the "Tare Store" function key must be activated (Section 7.2.2) and the desired tare memory must be defined and activated (Section 7.2.15).

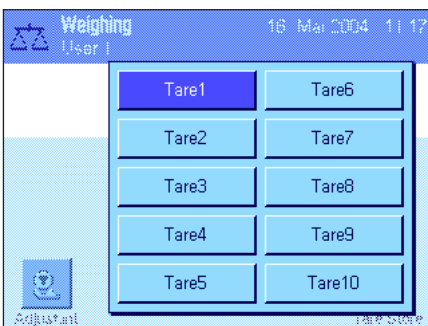

When the "Tare Store" function key is pressed, a window appears in which you can select the desired tare memory. The memory names correspond to those that were defined in the menu ("Tare 1" ... "Tare 10" are only example names).

Select the desired memory and the corresponding tare value is loaded immediately. The tare value remains active until a new tare memory is selected, the «→0←» or «→T←» key is pressed, the application is changed, another user profile is selected, or the balance is switched off.

### 7.3.3 Working with the item counter

The item counter numbers each weight value in the report printout, whereby the number automatically increases by 1 for each new item.



To use the item counter, the relevant function key must be activated (Section 7.2.2).

**Note:** When working with the item counter, we recommend that you also activate the corresponding information field (section 7.2.4). You can then view the current status of the item counter at any time.

When the function key is pressed a numeric input field appears, in which the start value for the item counter can be specified. The value is preset to 0 ex works, i.e. the item counter is switched off. To activate the item counter, enter a start value between 1 and 999.

Each time a weighing record is printed using the «» key, the weight value is preceded by a number, which increases by 1 for each new item. When the counter reaches the maximum value of 999, the numbering restarts from 1.

**Note:** The item counter can also be used with automatic record printing (Section 7.2.5).

1	N	235.8771	g
2	N	604.2467	g
3	N	817.9642	g

### 7.3.4 Working with IDs

IDs contain descriptive text for individual weighing processes, which enables weighing samples to be easily allocated to specific tasks or customers. The IDs are included on printouts (or can be transmitted to a connected PC).



To use the IDs, the "ID" function key must be activated (Section 7.2.2). This function key can be used to call up a maximum of 4 available IDs. **Note:** If the IDs are deactivated, the function key is grayed out and cannot be pressed. If this is the case, the IDs must be activated first before they can be used (Section 7.2.11).

The four factory-set ID names are "ID1", "ID2", "ID3" and "ID4". These names can be replaced by more appropriate titles for your application (Section 7.2.11). The selected names (e.g. "Client" for ID1, "Order" for ID2, "Lot" for ID3 and "Sample" for ID4) are available under the "ID" function key.

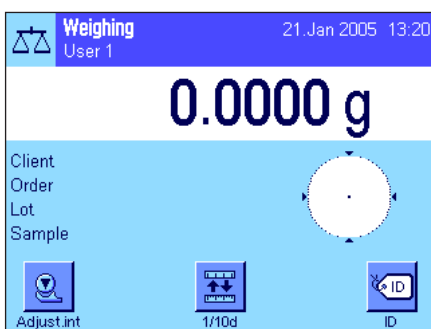

When working with the IDs, we recommend that you also activate the relevant information fields (Section 7.2.4). The information fields contain the names that were selected for the 4 IDs.

The example opposite shows the display on the balance following activation of the ID function key and the ID information fields.

The following example operation is based on the ID names that were defined in the example above.

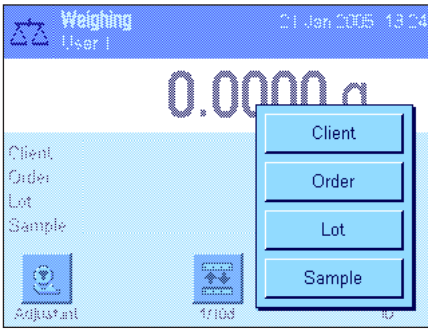

If you want to carry out an order for a customer in the application, press the "ID" function key. You can then select the ID for which you wish to enter text (e.g. "Client").



A field appears for you to enter the customer name (see illustration opposite). Enter the name and confirm your entry with "OK".

When you press the "ID" function key and select the "Order" ID, a similar field appears for you to enter the order name. The text for the "Lot" and "Sample" IDs can then be entered in the same way. The maximum permissible ID length is 24 characters.

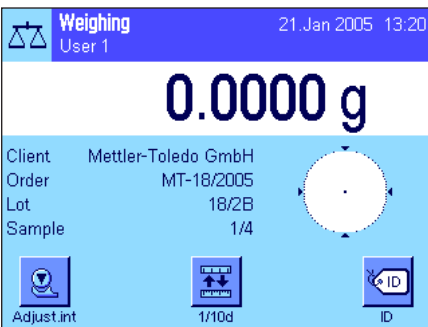

Once you have completed all the entries, you can check the selected IDs again using the information fields in the display.

All ID text is stored until it is replaced by new text.

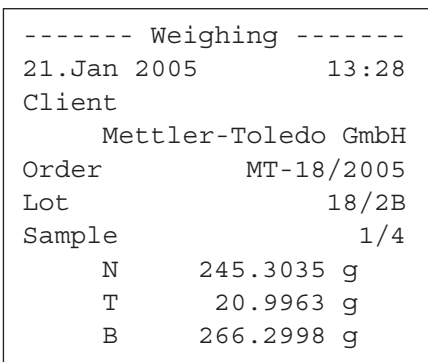

If the weighing record has been defined so that the IDs are also printed (Section 7.2.8), both the defined ID names (e.g. "Client") and the text entered (e.g., "Mettler-Toledo GmbH") will be printed. The illustration opposite shows a printout with the IDs from the example above.

### 7.3.5 Weighing to a nominal value

The "Weighing" application offers you additional functions that simplify weighing to a defined target weight.

#### Presettings



The function keys shown at left must be activated so that a nominal weight and the corresponding tolerances can be entered (Section 7.2.2). To view the defined values in the display, the information fields of the same name can also be activated, if necessary (Section 7.2.4).

#### Operating sequence

Press the "Nominal" function key. Type in the desired value. Check the weighing unit, which is shown to the right of the nominal value. When the weighing unit is touched a selection box containing the available units appears. **Note:** The units are not converted automatically; i.e., if a value is entered in one unit, this value remains the same even if the weighing unit is changed.

Once the value is entered, press "OK" to activate the nominal value.

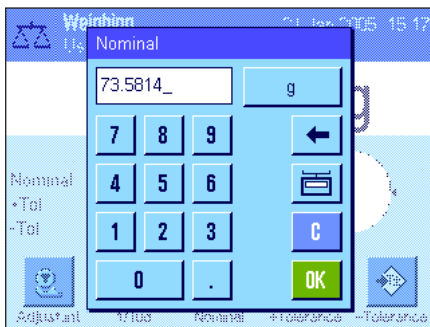

The "+Tol" and "-Tol" function keys can be used to specify the accuracy with which you wish to weigh. The input window is the same as for the nominal value. The input window is the same as for the nominal value. Both tolerance values are set to 2.5% ex works. Instead of a percentage value, you can also enter an absolute tolerance in any weighing unit (e.g., "g"). Once the relevant value is entered, press "OK" to activate the tolerance.

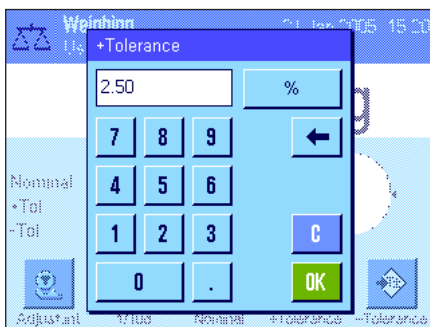

As soon as the nominal value and tolerances have been entered, a graphic weighing-in aid ("SmartTrac") appears in the display with tolerance markers that simplify weighing in to the nominal value: You can roughly weigh in your samples until the lower tolerance value is reached and then accurately dose, if necessary, up to the nominal value.

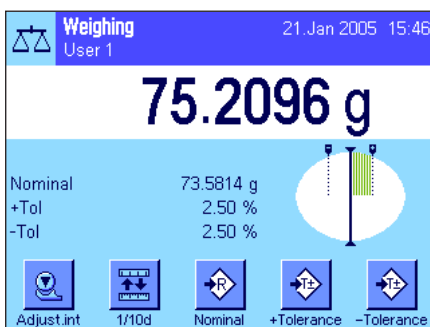

### 7.3.6 Working with the "MinWeigh" function

The "MinWeigh" function ensures that the weighing results are within a specified tolerance range in accordance with the requirements of your quality assurance system. This function must be enabled and programmed by a service technician. The "MinWeigh" function must be activated in this menu in order to use the function (Section 7.2.14). As soon as this function is activated, a small weight icon containing a "<" appears above the weighing result in the display. We recommend that you also activate the "MinWeigh", "Ref.Tare" and "Tare" information fields (Section 7.2.4).

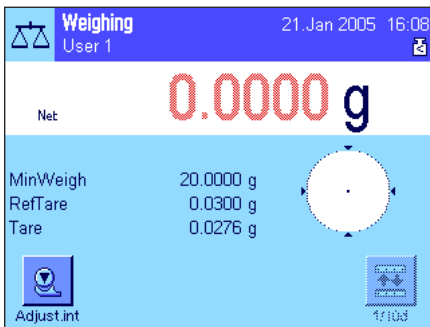

Press the «→0←» key to set the display to zero. Place the tare (weighing container) on the weighing pan and press the «→T←» key to tare the balance. The balance determines the tare value and displays it in the "Tare" information field. The "Net" icon (net weight) appears next to the weight display.

The "MinWeigh" information field displays the minimum initial weight, which is required for the current tare (20.0000 g in the example opposite). In addition, the tare reference value (which determines the minimum initial weight value) is displayed in the "Ref.Tare" information field. **Note:** If several reference tare values (and their corresponding minimum initial weight values) have been programmed by the service technician, the displayed value automatically changes to the range for the current tare weight. The required minimum initial weight value also changes simultaneously.



In the illustration opposite, the small **weight icon** above the weighing result (status icon) and the **gray** color of the weight value indicate that the minimum initial weight value has not yet been reached and that the current weight value may be outside the tolerance range specified in the QA system.

Place the weighing sample on the pan. As soon as the required minimum initial weight value is reached, the weighing result is displayed in **dark, easy-to-read** figures and the small weight icon above the weighing result disappears.

MW-Method		USP
RefTare	0.0300 g	
MinWeigh	20.0000 g	
*N	18.3386 g	
T	0.0276 g	
G	18.3662 g	

The weighing result can be printed using the «Print» key. The illustration opposite shows an excerpt from a sample printout, which lists the specifications for the "MinWeigh" function (method, reference tare and required minimum initial weight value) as well as the current weight values. The asterisk to the left of the net weight indicates that, according to the example above, the minimum initial weight value was not reached and that the value may not meet the QA specifications.



#### Note

If the status icon opposite (small weight symbol with clock) appears in the upper right of the display (below the date and time), it's time to test the "MinWeigh" function again. Contact the customer service department of your sales outlet to have a service technician run the test as soon as possible.



## 7.4 Adjusting the balance and testing adjustments

Your balance is set to ProFACT fully automatic adjustment ex works. ProFACT automatically adjusts and linearizes the balance according to preselected criteria. However, the balance can be adjusted manually and/or tested using the internal weight or an external weight at any time.

In the following descriptions, it is assumed that the relevant function keys for adjustment and tests (Section 7.2.2) are active.

### 7.4.1 ProFACT fully automatic adjustment

ProFACT automatically adjusts and linearizes your balance according to a preselected temperature criterion (Section 5.3.2).



As soon as the preselected time and/or temperature criterion is met (Section 5.3.2), the small ProFACT icon appears in the top right corner of the display, below the time. The balance uses this to indicate that it wishes to carry out a ProFACT adjustment.

**Note:** In the first 24 hours following connection to the power supply, ProFACT is carried out several times regardless of the selected criteria.

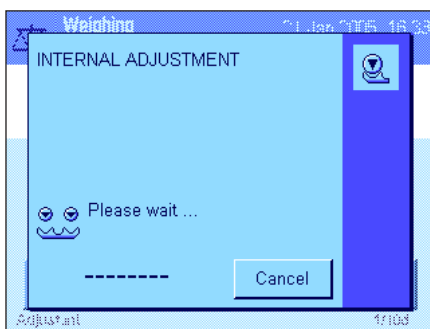

As soon as the balance is unloaded and no key has been pressed for 2 minutes, adjustment starts automatically. During adjustment a window is displayed, which provides information about the current adjustment operation. The icons are animated so that you can visually follow the progress of the adjustment operation. If you are working with the balance when adjustment starts, you can exit ProFACT via "**Cancel**". The balance will start adjustment at the next available opportunity.

Following successful adjustment, the balance automatically returns to the application. Each ProFACT adjustment is printed automatically according to your settings (Section 5.3.2). The information that is printed in addition to the adjustment data depends on your settings for the adjustment and test records (Section 5.3.7). A sample printout can be found in Section 7.4.6.

### 7.4.2 Adjustment using the internal weight



Pressing this function key triggers a balance adjustment using the built-in calibration weight. This can be implemented at any time.

You can hear how the internal weight is placed on the pan and then lifted off again in a motorized process. During adjustment the same window is displayed as for ProFACT adjustment (see above).

Following the adjustment operation, one of the following messages is displayed:

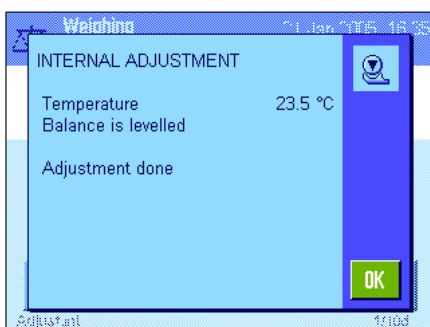

**Adjustment done.** Press "**OK**" to return to the application.

If a printer is connected to the balance, the adjustment is printed automatically according to the specifications selected in the system settings for printing adjustments (Section 5.3.7). A sample printout can be found in Section 7.4.6.

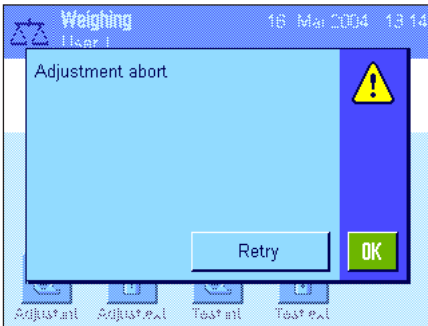

**Adjustment abort.** This message also appears when you cancel adjustment. You can repeat the adjustment operation or press "OK" to return to the application.

### 7.4.3 Adjustment using an external weight



Pressing this function key triggers a balance adjustment using an external calibration weight. This can be implemented at any time, but you can also specify in the system settings that the balance issues a calibration reminder on specific days of the week and at a specific time (Section 5.3.3). **Note:** Depending on country-specific regulations, adjustment using an external weight may not be available on certified balances.

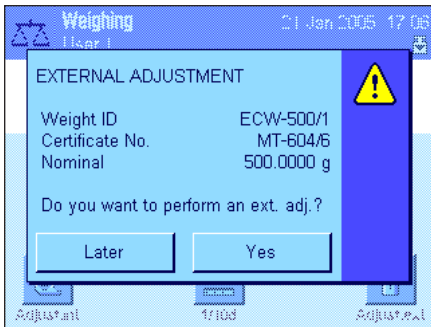

**For automatic external adjustment only:** If you specify in the system settings that the balance should automatically request adjustment (Section 5.3.3), the window opposite will appear at the selected time. If you want to carry out the adjustment, press "Yes" to start the adjustment process described below. If, on the other hand, you press "Later", you will be prompted to carry out the adjustment again after 15 minutes. The adjustment weight selected last is always used for automatic external adjustment. **Note:** The small weight icon for automatic external adjustment in the upper right of the display is deleted after adjustment is successfully completed or if, at the time of the second request, you indicate your decision not to carry out the adjustment ("No").

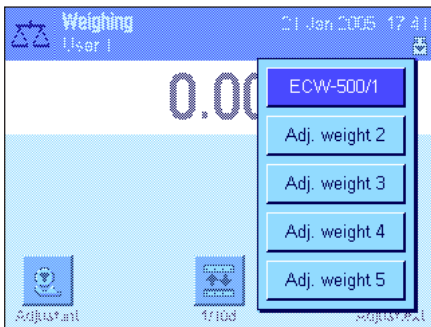

A list for selecting the adjustment weight will appear when you press the function key "Adjust. ext.". **Note:** All adjustment weights in the figure shown here still have the names they were given at the factory, with the exception of the first weight, which was assigned a unique name (Section 5.3.4). The adjustment starts immediately after the weight is selected

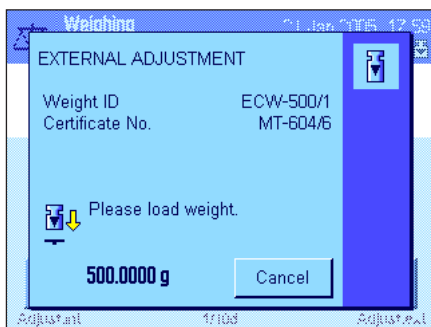

After the adjustment process starts, you will be prompted to place the adjustment weight. If available, the ID and the certificate number of the corresponding weight are displayed. The required weight value flashes at the bottom of the window.

**Important:** Make sure you place the correct weight on the pan, otherwise the adjustment operation will be stopped and aborted with an error message after a specific period of time has elapsed.

**Note:** Press "Cancel" to exit the current adjustment operation at any time.

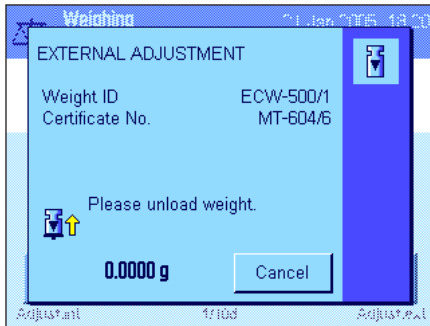

Once the requested weight is placed on the pan, the adjustment operation is carried out automatically. At the end of the adjustment operation you are prompted to lift off the weight. Remove the adjustment weight from the weighing pan.

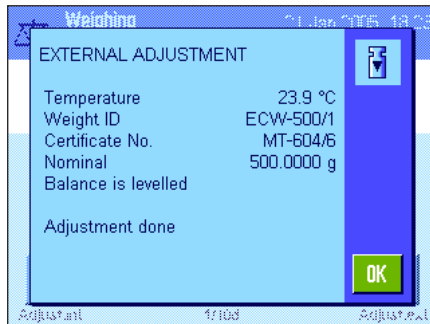

The balance confirms that adjustment was carried out successfully. Press "OK" to return to the application.

If a printer is connected to the balance, the adjustment is printed automatically according to the specifications selected in the system settings for printing adjustments (Section 5.3.7). A sample printout can be found in Section 7.4.6.

In the event of an error during adjustment, an error message is displayed, which is the same as the message for adjustment using the internal weight (see previous Section).

#### 7.4.4 Testing adjustments using an internal weight



Pressing this function key checks that your balance was adjusted correctly using the internal weight.

The test procedure is the same as that for adjustment using the internal weight (Section 7.4.2).

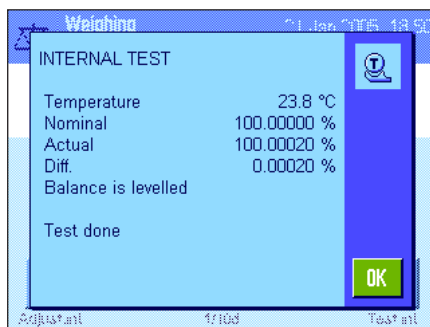

Following successful completion of the test, the window opposite is displayed as confirmation. If a printer is connected to the balance, the test is printed automatically according to the specifications selected in the system settings for printing (Section 5.3.7). A sample printout can be found in Section 7.4.6.

If the test was aborted due to an error, an error message is displayed.

### 7.4.5 Testing adjustments using an external weight

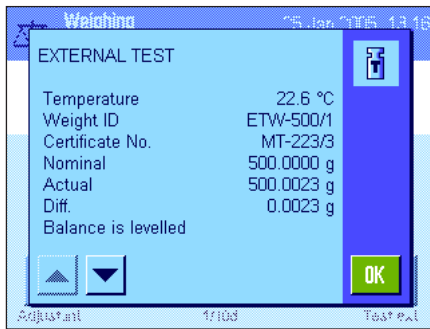

Pressing this function key checks that your balance was adjusted correctly using an external weight. This can be implemented at any time.

You can also specify in the system settings that the balance prompt for an adjustment test using an external weight on certain days and at a particular time (Section 5.3.5). In this case, the small weight icon for automatic adjustment testing is displayed until the test is successfully completed or until you indicate at the time of the second request that you have decided not to carry out the test.

The test procedure is the same as that for adjustment using an external weight (Section 7.4.3).

Following successful completion of the test, the window opposite is displayed. If a printer is connected to the balance, the test is printed automatically according to the specifications selected in the system settings for printing (Section 5.3.7). A sample printout can be found in Section 7.4.6.

### 7.4.6 Adjustment and test printouts (sample printouts)

#### Printout of an internal or ProFACT adjustment

```

- Internal adjustment --
21.Jan 2005          16:34

METTLER TOLEDO
User Name           User 1

Balance Type        XP504
WeighBridge SNR:
                    1234567890
Terminal SNR: 1234567890
Balance ID          LAB-1/4

Temperature         23.5 °C

Balance is levelled

Adjustment done

Signature
.....
-----
    
```

Note: No signature line is printed for ProFACT adjustments.

#### Printout of an external adjustment

```

- External adjustment --
21.Jan 2005          18:21

METTLER TOLEDO
User Name           User 1

Balance Type        XP504
WeighBridge SNR:
                    1234567890
Terminal SNR: 1234567890
Balance ID          LAB-1/4
Weight ID           ECW-500/1
Certificate No. MT-604/6

Temperature         23.9 °C
Nominal             500.0000 g

Balance is levelled

Adjustment done

Signature
.....
-----
    
```

**Printout of an internal test**

```
----- Internal test -----
21.Jan 2005          18:50

METTLER TOLEDO
User Name           User 1

Balance Type        XP504
WeighBridge SNR:
                    1234567890
Terminal SNR: 1234567890
Balance ID          LAB-1/4

Temperature         23.8 °C
Nominal             100.00000 %
Actual              100.00020 %
Diff.                0.00020 %

Balance is levelled

Test done

Signature
.....
-----
```

**Printout of an external test**

```
---- External test ----
25.Jan 2005          13:16

METTLER TOLEDO
User Name           User 1

Balance Type        XP504
WeighBridge SNR:
                    1234567890
Terminal SNR: 1234567890
Balance ID          LAB-1/4
Weight ID           ETW-500/1
Certificate No. MT-223/3

Temperature         22.6 °C
Nominal             500.0000 g
Actual              500.0023 g
Diff.                0.0023 g

Balance is levelled

Test done

Signature
.....
-----
```

## 8 The "Statistics" application

This Section describes the "Statistics" application. Here you will find information on how to work with this application and on the relevant setting options. **Please note that all settings for the "Statistics" application are stored under the active user profile. User-specific settings can thus be entered for this application. Therefore, make sure that you have selected the desired user profile first.**

### 8.1 Introduction to the "Statistics" application

The "Statistics" application offers the same basic options as the "Weighing" application, but also contains additional settings and functions for the statistical acquisition and evaluation of series weighing values. This Section only describes in detail the settings and functions that differ from the "Weighing" application.

**Note:** If you use Statistics in conjunction with the LC-I/O relay interface or the LV11 automatic feeder, please note the information provided in the "Solution Guide", which is available on the Internet ([www.mt.com/xp-analytical](http://www.mt.com/xp-analytical)).

### 8.2 Selecting the application

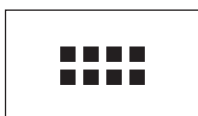

If the "Statistics" application is not already active, press the «» key. Touch the application icon in the selection window.

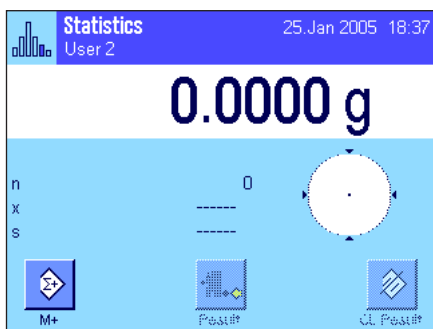

The display opposite appears when the application is selected. Some of the special function keys and information fields for statistics are activated ex works. These and other settings can be adapted to your requirements, according to the descriptions in the following Sections.

**Note:** The "Result" and "CL Result" function keys are inactive, and therefore displayed in gray, as the statistics do not yet contain any values.

### 8.3 Settings for the "Statistics" application

Various specific settings for Statistics, which can be used to adapt the application to your requirements, can be found under the «» key.

#### 8.3.1 Overview

The setting options for the "Statistics" application are virtually identical to those for the "Weighing" application (Section 7.2). Only the settings that differ are described below. They apply to the following menu pages:

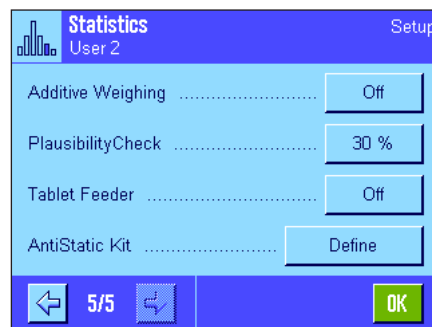
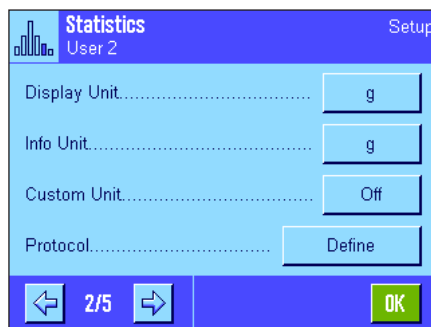
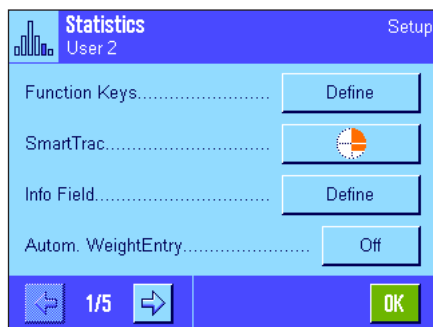

"Function Keys":	Additional function keys are available for Statistics.
"Info Field":	Additional information fields are available for Statistics.
"Autom. WeightEntry":	This setting can be used to automatically enter weight values into the statistics.
"Protocol":	Additional record information is available for Statistics.
"Additive Weighing":	Additive mode (series weighing with automatic taring) can be activated in this menu, which is only available in the "Statistics" application.
"PlausibilityCheck":	This setting prevents incorrect values from being transferred to the statistics.
"Tablet Feeder":	This menu can be used to specify the interaction between the statistics function and the LV11 automatic feeder from METTLER TOLEDO.

The specific settings for the "Statistics" application are described in detail in the following Sections.

### 8.3.2 Special function keys for use with the statistics

The following special function keys can be activated in the function key menu for use with the statistics:

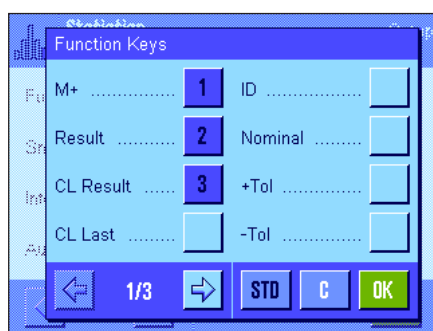

"M+": This function key transfers the current stable weight to the statistics (Section 8.4.1).

"Result": This function key opens the results window (Section 8.4.1).

"CL Result": This function key deletes the statistics for a weighing series (Section 8.4.1).

"CL Last": This function key deletes the last stored measured value (Section 8.4.1).

"Nominal": This function key can be used to define the desired nominal weight (Section 8.4.2). The nominal weight is also used as the reference for the tolerances (described below).

"+Tol" and "- Tol": These function keys can be used to define the accuracy (tolerances) with which you wish to weigh in (Section 8.4.2).

"Max n": This function key can be used to define the maximum number of samples in a series (Section 8.4.1). All other function keys are identical to those for the "Weighing" application (Section 7.2.2).

**Factory setting:** "M+", "Result" and "CL Result" are activated (in this order).



### 8.3.3 Special information fields for the statistics

The following settings for **displaying statistical values** are available in the menu for the information fields:

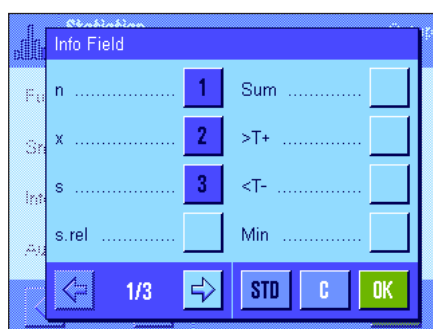

"n": Number of samples weighed in.

"x": Mean weight of all samples.

"s" and "s.rel": Standard deviation as an absolute and percentage value.

"Sum": Total weight of all individual weighings.

">T+" and "<T-": Number of samples outside the upper and lower tolerance range.

"Min" and "Max": Smallest and largest recorded weight value in the current measurement series.

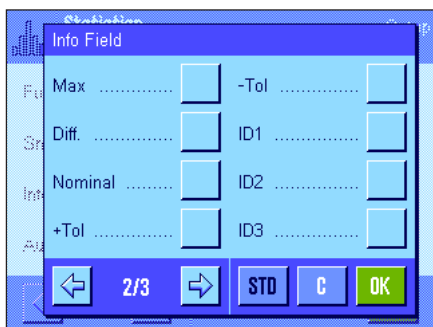

- "Diff":** Difference between the smallest and largest weight value.
- "Nominal":** Shows the nominal weight entered via the function key of the same name.
- " +Tol" and "- Tol":** These information fields show the tolerances entered via the function keys of the same name.

All other information fields are identical to those for the "Weighing" application (Section 7.2.4).

**Factory setting:** "n", "x" and "s" are activated (in this order).

### 8.3.4 Specifications for automatic weight transfer

This menu option can be used to specify whether and under which conditions the balance is to automatically transfer a stable weight value to the statistics (this means you do not have to press the "M+" function key). In addition, the weight value is printed automatically.

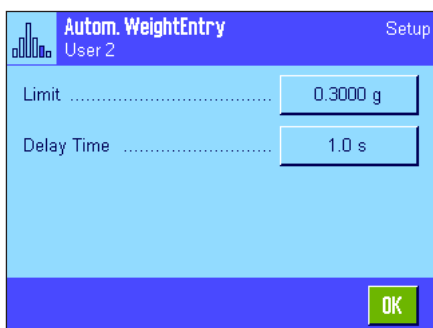

When you activate this function ("On"), press "Define" to define the criteria for automatic weight transfer:

- "Limit":** This value specifies the weight limit that must be exceeded to trigger automatic weight transfer.
- "Delay Time":** As soon as the weight limit is exceeded, the "Delay Time" starts. Once this time has elapsed, the weight value is recorded and transferred to the statistics or transmitted via the interface.

**Factory setting:** "Off" (automatic weight transfer is deactivated).

### 8.3.5 Special record information for the statistics

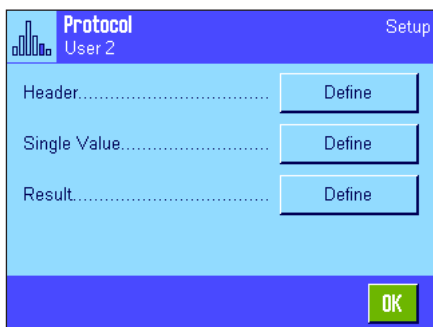

The three submenus for defining the record header, printing single values and for the result contain additional settings for the statistics, which are described below.

**Note:** The other available record information is the same as for the "Weighing" application (Section 7.2.8) and is not described here.

#### Record header

Additional settings for the statistics are available on the second page of this submenu:

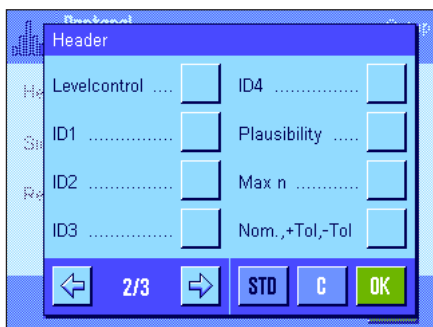

- "Plausibility":** The defined limit for plausible measured values is printed (Section 8.3.7).
- "Max n":** The defined maximum number of samples in the series is printed.
- "Nom, +/-Tol":** Prints the defined nominal weight and the defined tolerances.

**Factory setting:** "Appl.Name" ("Statistics" is printed) and "Date/Time" (in this order); no specific information is activated for the statistics.



The header is automatically printed when the "M+" key is pressed during a series of weighings in order to transfer the first measured weight to the statistical system. The header can also be printed separately by pressing the "Header" function key.

### Printing single values

The same additional settings for the statistics are available in this submenu as for the header ("Plausibility", "Max n", "Nom.,+Tol,-Tol").

**Factory setting:** "Net" (net weight value for the current weighing operation), i.e. no specific information is activated for the statistics.

A single value is printed automatically when the "M+" function key is pressed during series weighing. A single value can also be printed separately by pressing the «» key.

### Printing the result

The second and third page of this submenu can be used to define which additional statistical information is to be included in the printed results record:

**"Max n":** Defined maximum number of samples in the series.

**"Nominal, +/-Tol":** Defined nominal weight and tolerances.

**">Tol+, <Tol-":** Number of samples outside the upper and lower tolerance range.

**"n":** Number of samples weighed in.

**"x":** Mean weight of all samples.

**"s" and "s.rel":** Standard deviation as an absolute and percentage value.

**Note:** These two values are only printed if the statistics contain at least 3 values, otherwise horizontal dashes appear in place of the values.

**"Min, Max, Diff.":** The smallest and largest recorded weight value in the current measurement series and the difference between the smallest and largest weight value.

**"Sum":** Total weight of all saved individual weighings.

**Factory setting:** "n", "x", "s" and "s.rel" are activated (in this order).

The printed results record is printed by pressing the «» key when the result window is open. If a specific number of samples is defined for a series weighing ("Max n"), the printed results record is printed automatically as soon as the weight value of the last sample has been transferred to the statistics.

A **sample printout with statistical values** can be found in Section 8.4.3.

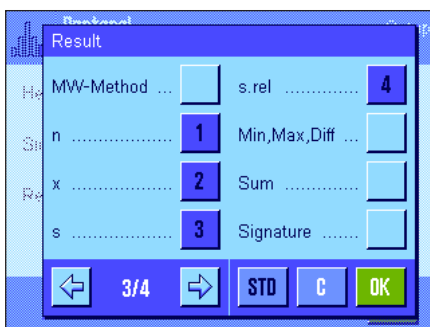
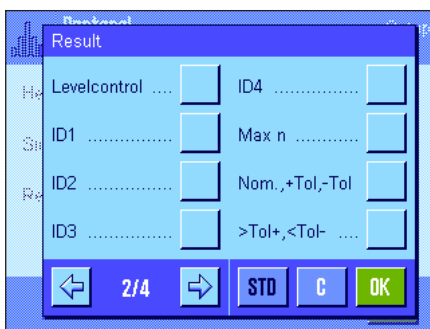

### 8.3.6 Activating additive mode

Additive mode can be switched on or off in this menu, which is only available in the "Statistics" application. During series weighing in additive mode, the samples do not have to be removed from the weighing pan.



**"On":** Additive mode is switched on. Following manual or automatic transfer of a weighing result to the statistics, the balance is **automatically tared**. The next sample can be weighed in without removing the previous sample from the weighing pan.

**"Off":** Additive mode is switched off.

**Factory setting:** "Off".

### 8.3.7 Defining plausibility limits

The plausibility check is a safeguard to prevent incorrect values being transferred to the statistics. The percentage limit for plausible weighing results can be defined in this menu.

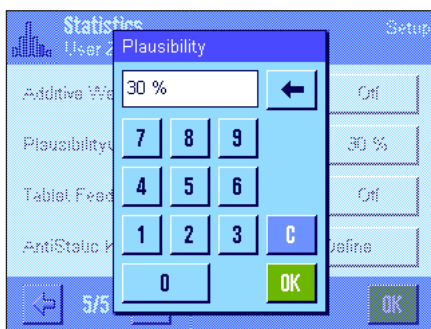

Enter the limit for plausible values. The percentage entry is based on the defined nominal value. If no nominal value is defined, the limit is based on the mean value of the previously weighed in samples in a weighing series. Example: For a plausibility limit of 30%, all weight values that deviate from the nominal or mean value by a maximum of  $\pm 30\%$  are considered plausible and are transferred to the statistics. All other weight values are ignored and are not transferred to the statistics. **Note:** If you wish to weigh in to a nominal value and define tolerances (Section 8.4.2), make sure that the limit for plausible weight values is greater than the selected tolerances, otherwise values could be omitted from the statistics even though they are within the tolerance range.

**Factory setting:** "30%".

### 8.3.8 Settings for the LV11 automatic feeder

If you are working with the LV11 automatic feeder from METTLER TOLEDO, you can define some settings for this peripheral device in this menu. **Note:** If you connect an LV11 to your balance, configure the interface in the system settings accordingly (Section 5.7).

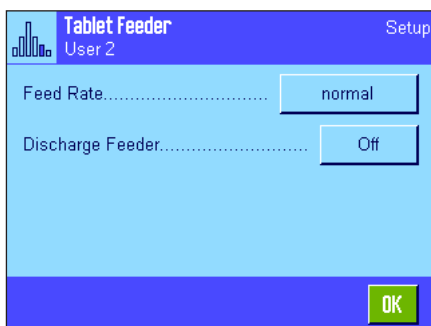

**"Feed Rate":** Select the desired feed rate: "slow", "normal", "fast" or "very fast".

**"Discharge Feeder":** When the discharge function is activated ("On") the feeder pot of the LV11 is automatically emptied once the last sample in a weighing series has been weighed in. Automatic discharge is disabled when the setting is set to "Off".

**Factory setting:** "Off" (settings for the automatic feeder are inactive).

## 8.4 Working with the "Statistics" application

This Section describes how to work with the "Statistics" application. You can of course determine a tare, change the resolution of the weighing result, work with IDs, etc.

These options were already described in the "Weighing" application (Section 7.3) and are therefore not repeated here.

### 8.4.1 Statistical acquisition of series weighing values



#### Presettings

The minimum requirement for using the statistics (Section 8.3.2) is that the 3 function keys opposite must be activated.

In addition, we recommend that you activate both of the function keys opposite. They are used to delete incorrect values ("CL Last") and to define the number of samples to be included in a weighing series ("Max n").

A printer should be connected to your balance for optimum use of the statistical functions. If no printer is connected, we recommend that you activate the four main information fields for the statistics for your application (e.g. "n", "x", "s" and "Sum", see Section 8.3.3).

**Note:** If at the start of a series weighing you use a "free weighing unit" (Chapter 7.2.7), the weight unit can only be changed back again after the measurement series has been completed.

#### Operating sequence



If the number of samples to be weighed in for a series is specified in advance, you can press the "Max n" function key and enter the number of samples (1 ... 999). After the last sample is weighed in, the series is automatically closed, the statistics window is opened and the printed results record is printed. **Note:** This function key is only active when the statistics do not yet contain any measured values. Enter the value 0 (zero) for "Max n" to set an unlimited series where you can weigh in up to 999 samples.

If you are working with a weighing container, place it on the pan and press the «→T←» key to tare the balance (alternatively you can also work with the tare memories or use the automatic tare function; these functions are described for the "Weighing" application in Section 7).



Place the first sample on the pan and press the "M+" function key to transfer the weight to the statistics. As soon as the weight value becomes stable (horizontal dashes disappear), the value is transferred to the statistics. The report header is printed out together with the result (single value) of the current weighing operation (Section 8.3.5).

Lift off the first sample. **Note:** If Additive Weighing has been activated (Section 8.3.6), you can leave the sample on the weighing pan, as the balance is tared automatically every time a weight value is transferred to the statistics.

Place the other samples on the pan one after the other. Confirm each weighing with the "M+" function key (not necessary when weight transfer is activated, see Section 8.3.4). Lift the sample off and tare the balance (not necessary when additive mode is activated, see Section 8.3.6). Each time a value is transferred to the statistics, it is printed automatically.

**Note**

- If you press the "M+" function key when a weight change has not occurred, an error message appears. This prevents the same sample from being measured twice.
- If a weight value is outside the plausibility limit (Section 8.3.7), a corresponding error message appears after the "M+" key is pressed, and the value cannot be transferred to the statistics. If the automatic weight transfer is activated (Section 8.3.4), no error message appears, the value is not transferred to the statistics and will also not appear in the statistics printout.
- If a weight is accidentally placed on the pan and the weighing result has been saved, the last value can be deleted using the "CL Last" function key (only available if values are already present in the memory, otherwise the key is grayed out and cannot be pressed). The key is deactivated after a value is deleted and can only be used again once the next value has been transferred to the statistics.



Once all the samples have been weighed in, press the "Result" function key (only available if values are present in the memory; otherwise the key is grayed out and cannot be pressed). This pauses the measurement process and opens the results window (the series can still be continued at any time). **Note:** If you specified the number of samples in the series using the "Max n" function key before starting the weighing process, the results window opens automatically after the last sample is weighed in and indicates that the maximum number of samples has been reached.

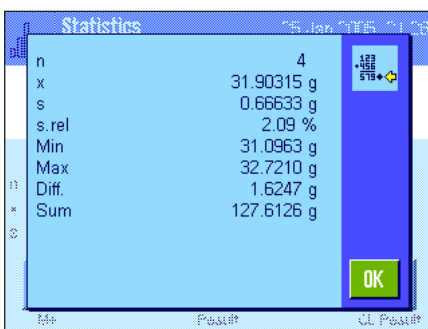

The results window contains the results of the weighing series (the information selected for printing the result is displayed, see Section 8.3.5). Please refer to the notes in Section 8.4.3 regarding the units, resolution and accuracy of displayed values.

If the results window contains several screen pages, two arrow keys appear at the bottom of the screen, which can be used to access the individual pages. Press the «» key to print the printed results record.

A complete sample printout with all the statistical values can be found in Section 8.4.3.



If you have definitely completed the measurement process and wish to clear the memory in preparation for the next series, press the "CL Result" function key (a safety prompt is displayed, which must be confirmed before the statistics are actually deleted). **Note:** If the statistics contain no values, the key is inactive and will appear grayed out.

## 8.4.2 Weighing to a nominal value

The "Statistics" application offers additional functions, which simplify weighing in to a defined Nominal value. These functions can be used for both individual weighing and series weighing when using the statistics.

### Presettings



The function keys opposite must be activated so that a nominal weight and the corresponding tolerances can be entered (Section 8.3.2). To view the defined values in the display, the information fields of the same name can also be activated, if necessary (Section 8.3.3).

### Operating sequence

**Note:** If values are already present in the statistics, the function keys for entering the nominal weight and tolerances are inactive. If this is the case, the statistics must be deleted using the "CL Result" function key, before the nominal weight and the tolerances can be defined.

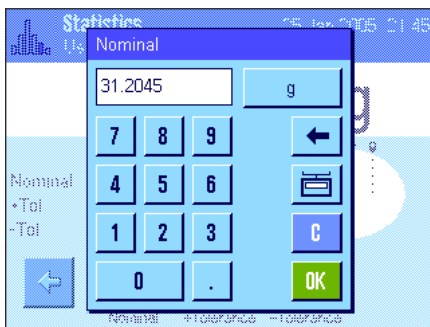

Press the "Nominal" function key to enter the desired nominal weight. Type in the desired nominal weight (if a weight that is already on the balance corresponds to the nominal weight, this can be transferred directly by pressing the button with the balance icon). Check the weighing unit, which is displayed to the right of the nominal value. When the weighing unit is touched a selection box appears, which contains the available units. **Note:** The units are not converted automatically, i.e. if you have entered a value in one unit, this value remains the same even if the weighing unit is changed. Once you have entered the value, press "OK" to activate the nominal weight.

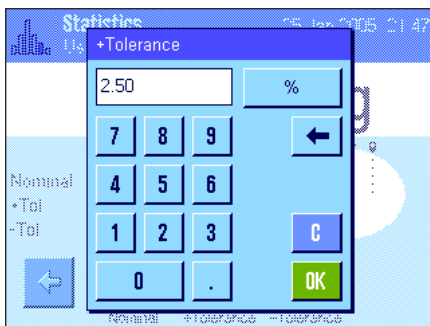

The "+Tolerance" and "-Tolerance" function keys can be used to specify the precision to be used for the weighing. The input window is the same as for the nominal value. Both tolerance values are set to 2.5% ex works. Instead of a percentage value, you can also enter an absolute tolerance in any weighing unit. Once you have entered the relevant value, press "OK" to activate the tolerance. Samples outside the tolerance range are specifically marked (">T" and "<T") when the single values are printed.

**Important:** Make sure that the plausibility limit is greater than the defined tolerances: Weight values that are within the tolerance range but exceed the plausibility limit cannot be transferred to the statistics. If necessary, change the limit value for plausible weight values (Section 8.3.7).

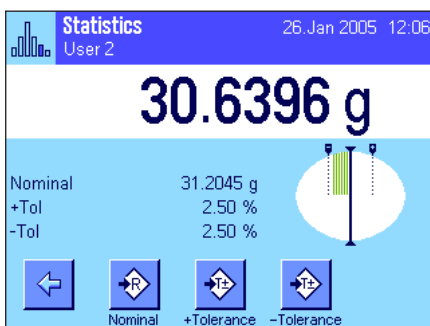

As soon as the nominal value and tolerances have been entered, a graphic weighing-in aid ("SmartTrac") appears in the display with tolerance markers, which simplify weighing in to the nominal value. You can roughly weigh in your samples until the lower tolerance value is reached and then accurately dose, if necessary, up to the nominal value.

### 8.4.3 Sample printout with statistical values

```

----- Statistics -----
26.Jan 2005          12:23
User Name           User 2
Balance Type        XP504
WeighBridge SNR:
                    1234567890
Terminal SNR: 1234567890
Balance ID          LAB-1/4
Balance is levelled
Plausibility        30 %
Nominal             31.2045 g
+Tol                2.50 %
-Tol                2.50 %
 1                  31.5178 g
 2                  30.6386 g
 3>T                32.0964 g
 4                  31.3839 g
n                   4
x                   31.40918 g
s                   0.59958 g
s.rel               1.91 %
Min                 30.6386 g
Max                 32.0964 g
Diff.               1.4578 g
Sum                 125.6367 g

Signature
.....

```

The illustration opposite shows a sample printout with statistical values. The values printed in the header, as single values and as the result, depend on your individual record settings (Section 8.3.5).

Only the **statistical information** included in the sample printout opposite is described below. Notes on additional record information can be found in Section 7.2.8:

- "**Plausibility**": Defined limit value for the plausibility of weight values.
- "**Nominal**": Defined nominal weight.
- "**+Tol**": Defined plus tolerance.
- "**-Tol**": Defined minus tolerance.
- "**1**" ... "**4**": Individual weight values in the weighing series. In this example, the third sample is outside the upper weight tolerance (>T).
- "**n**": Number of samples weighed in.
- "**x**": Mean weight of all samples. The value is printed in the current display unit. The resolution of the printed value is 10 times higher than that of the measured value with the highest resolution in the measurement series.
- "**s**": Standard deviation within the series. The value is printed in the current display unit. The resolution of the printed value is 10 times higher than that of the measured value with the highest resolution in the measurement series.
- "**s.rel**": Relative standard deviation within the series (as a percentage). The value is always printed to 2 decimal places.
- "**Min**": Smallest recorded weight value in the current measurement series. The number of decimal places and the unit correspond to those that were visible when the measured value was transferred to the result display.
- "**Max**": Largest recorded weight value in the current measurement series. The number of decimal places and the unit correspond to those that were visible when the measured value was transferred to the result display.
- "**Diff**": Difference between the smallest and largest weight value in the current measurement series. The value is printed in the current display unit. The number of decimal places for the printed value corresponds to that of the smallest or largest weight value with the highest resolution.
- "**Sum**": Total weight of all saved individual weighings. The value is printed in the current display unit. The number of decimal places corresponds to that of the measured value with the highest resolution in the measurement series.

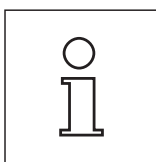

#### Important information for interpreting printed results

The values "**x**" and "**s**" are calculated results, which are displayed at a higher resolution than the single measured values. For smaller measurement series (fewer than approx. 10 measured values) and measurement series with small deviations, the significance of the last decimal place cannot be guaranteed.

## 8.4.4 Formulas used for calculating statistical values

### Calculating the mean value and standard deviation

#### Terminology

$x_i$  := Individual measurement values of a measurement series of  $n$  measurement values  $i = 1..n$

$\bar{x}$  := Mean value and  $s$  standard deviation of these measurement values

The formula for calculating the mean value is:

$$\bar{x} = \frac{1}{n} \sum_{i=1}^n x_i \quad (1)$$

The usual formula for calculating standard deviation, as seen in the literature  $s$

$$s = \sqrt{\frac{1}{n-1} \sum (x_i - \bar{x})^2} \quad (2)$$

is not suitable for numerical calculation, since the variance (individual value-mean value) can result in deletion in measurement series that have very small deviations. Moreover, when this formula is used, each individual measurement value must be stored before the standard deviation can be determined at the end.

The following formula is mathematically equivalent but significantly more stable numerically. It can be derived from (1) and (2) through appropriate recasting.

$$s = \sqrt{\frac{1}{n-1} \left\{ \sum_{i=1}^n x_i^2 - \frac{1}{n} \left( \sum_{i=1}^n x_i \right)^2 \right\}}$$

To use this formula for calculating the mean value and the standard deviation, you just need to store  $n$ ,  $\sum x_i$  and  $\sum x_i^2$ .

#### Standard deviation

Numerical stability can be improved even more by scaling the measurement value:

With  $\Delta x_i := x_i - X_0$ , where  $X_0$  (depending on the application) is either the first measurement value of a measurement series or the nominal value of a measurement series, the result is:

$$s = \sqrt{\frac{1}{n-1} \left\{ \sum_{i=1}^n (\Delta x_i)^2 - \frac{1}{n} \left( \sum_{i=1}^n \Delta x_i \right)^2 \right\}}$$

#### Mean value

The mean value is then calculated as follows:

$$\bar{x} = X_0 + \frac{1}{n} \sum_{i=1}^n \Delta x_i$$

#### Relative standard deviation

The relative standard deviation is calculated by means of the following formula:

$$s_{rel} = \frac{s}{\bar{x}} 100 \quad \text{percent}$$

#### Number of digits in the results

Mean value and standard deviation are always expressed and displayed to one more decimal place than the corresponding individual measurement values. When interpreting the results, keep in mind that the additional decimal place is not meaningful when it comes to small measurement series (less than approx. 10 measurement values).

The same is also true of percentages (such as those used in expressing relative standard deviations), which are always shown to two decimal places (for example, 13.45 percent). Here, too, the significance of the decimal places depends on the size of the background data.

## 9 The "Formulation" application

This Section describes the "Formulation" application. You will find information here about the practical aspects of working with this application and about its specific settings. **Please note that all settings for the "Formulation" application are stored under the active user profile. User-specific settings can thus be entered for this application. Therefore, make sure that you have selected the desired user profile first.**

### 9.1 Introduction to the "Formulation" application

The "Formulation" application can be used for weighing in components that are to be combined in a specific ratio. Databases are available for permanently storing all relevant parameters for formulae and components. The selected formula is processed automatically in the formulation operation and the balance weighs in all components step by step. Naturally, it is also possible to "free formulate" without using formulae from the database. The result can be printed in detail at the end of a formulation.

Many of the application-specific settings are identical to those of the "Weighing" application. However, additional settings and functions are available for Formulation. This section describes in detail only the settings and functions that differ from the "Weighing" application.

### 9.2 Selecting the application

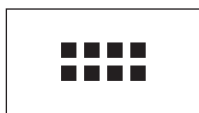

If the "Formulation" application is not already active, press the «⋮» key. Touch the application icon in the selection window.

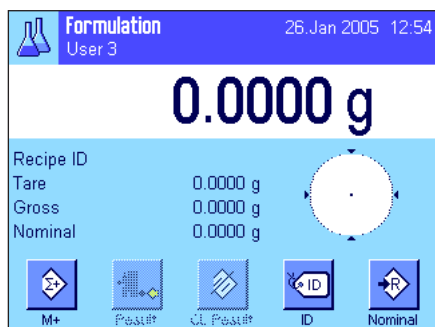

The display opposite appears when the application is selected. The special function keys and information fields for formulation are activated ex works. These and other settings can be adapted to your requirements, according to the descriptions in the following Sections.

**Note:** The two function keys for "Result" and "CL Result" are displayed in gray, since no formulation has been carried out yet.

### 9.3 Settings for the "Formulation" application

A number of different specific settings are available for Formulation, and these can be used to adapt the application to your requirements.

#### 9.3.1 Overview



The application-specific settings can be accessed via the «☰» key. When this key is pressed, the first of 4 menu pages is displayed.



The setting options for the "Formulation" application are virtually identical to those for the "Weighing" application (Section 7.2). Only the settings that differ are described below. They apply to the following menus:

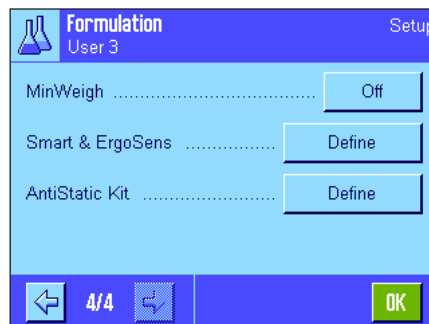
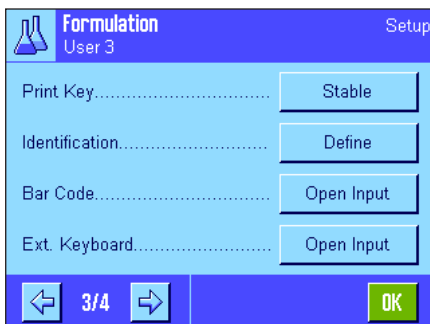
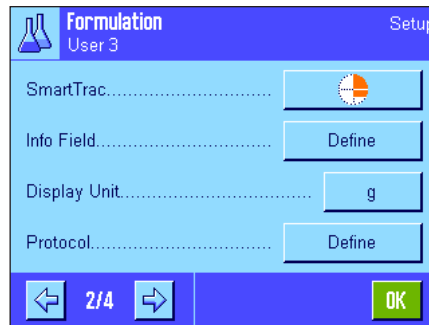
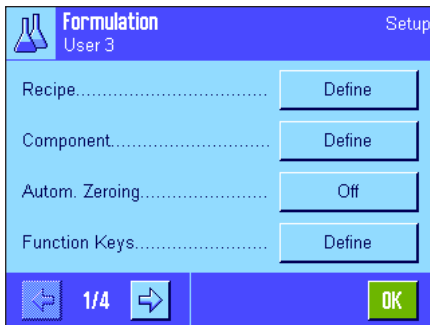

**"Recipe":**

For defining recipes.

**"Component":**

For defining components.

**"Autom. Zeroing":**

Automatically zeroes when the tare container is removed.

**"Function Keys":**

Additional function keys are available for Formulation.

**"Info Field":**

Additional information fields are available for Formulation.

**"Protocol":**

Additional record information is available for Formulation.

**"Identification":**

Special ID names are defined ex works for Formulation.

**"Smart & ErgoSens":**

Special functions can be assigned to the sensors for Formulation.

Please remember that, unlike the "Weighing" application, no "Info Unit" is available. The specific settings for the "Formulation" application are described in detail in the following Sections. **Note:** The menus for defining components and formulae are quite extensive and are therefore described separately (Sections 9.4 and 9.5).

### 9.3.2 Activating/deactivating automatic zeroing

In the "Autom. Zeroing" menu you can specify whether the display should automatically reset to zero when the tare container is removed.



**"On":**

Automatic zeroing is activated. When the tare container is removed, the display is automatically reset to zero if taring has taken place and at least one component has been weighed.

**"Off":**

Automatic zeroing deactivated.

**Factory setting:**

"Off" (automatic zeroing deactivated)

### 9.3.3 Special function keys for Formulation

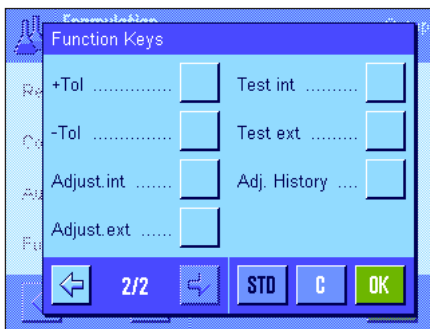
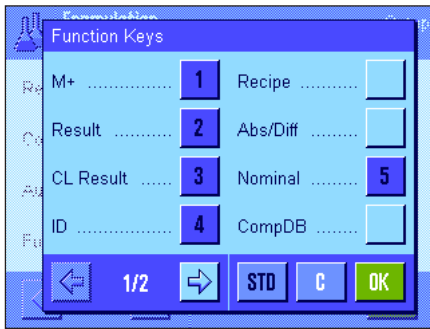

The following settings are available for Formulation in the function key menu:

- "M+":** Stores the net weight of the weighed in components and resets the weight display to zero.
- "Result":** Opens the window with the results of the formulation.
- "CL Result":** Deletes the stored values of a formulation.
- "Recipe":** Opens the formula database to enable selection of a recipe.
- "Abs/Diff":** Switches the weight display between the quantity of a component weighed in ("Abs" = Absolute) and the remaining quantity to be weighed in until the nominal weight is reached ("Diff" = Difference).
- "Nominal":** For specifying the nominal weight for the current component.
- "CompDB":** Opens the components database to enable selection of components.
- "+Tol" and "-Tol":** Defines the accuracy with which a component is to be weighed in.

All function keys not listed are identical to those for the "Weighing" application (Section 7.2.2).

**Factory setting:** "M+", "Result", "CL Result", "ID" and "Nominal" are activated (in this order).

### 9.3.4 Special information fields for Formulation

The following settings for formulation are available on the first two pages of the menu for information fields:

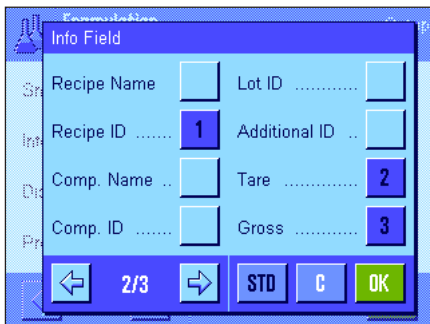
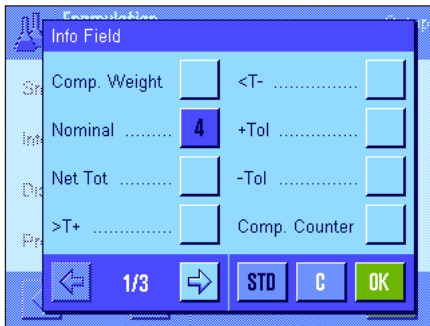

- "Comp. Weight":** Current weight of a component.
- "Nominal":** Shows the nominal weight of the current component entered via the function key of the same name.
- "Net Tot.":** Total net weight of all components that have been weighed in.
- ">T+" and "<T-":** Number of components outside the upper/lower tolerance range.
- "+Tol" and "-Tol":** These information fields show the tolerances entered via the function keys of the same name.
- "Comp. Counter":** Displays the current state of the component counter (number of the current component).
- "Recipe Name":** Name of the current recipe.
- "Recipe ID":** Identification (ID1) of the current recipe.
- "Comp. Name":** Name of the current component.
- "Comp. ID":** Identification (ID2) of the current component.
- "Lot ID":** Lot ID (ID3) entered via the "ID" function key.
- "Additional ID":** Additional ID (ID4) entered via the "ID" function key.

**Note:** The names of the four IDs are specified ex works but can be changed (Section 9.3.6).

All other information fields are identical to those of the "Weighing" application (Section 7.2.4).

**Factory setting:** "Recipe ID", "Tare", "Gross" and "Nominal" are activated (in this order).

### 9.3.5 Special record information for Formulation

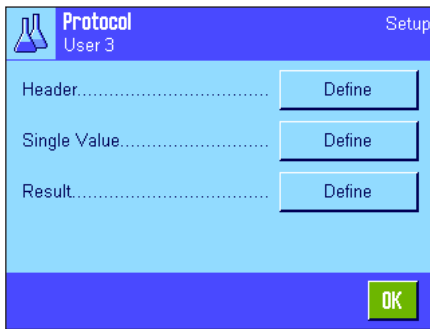

The three submenus for defining the record header, printing single values and for the result contain additional settings for the Formulation, which are described below.

**Note:** All other information fields are identical to those of the "Weighing" application (Section 7.2.8).

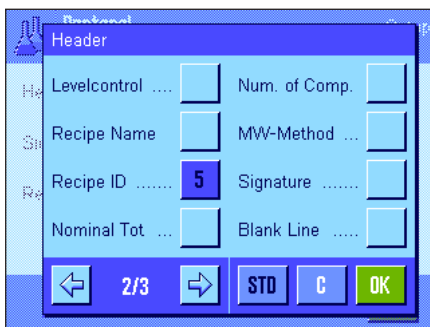

#### Record header

Additional settings for Formulation are available on the second page of this submenu:

- "Recipe Name":** Prints the name of the current formula.
- "Recipe ID":** Prints the identification (ID1) of the current formula.
- "Nominal Tot.":** Prints the sum of the nominal weight values of all components of the current formula.
- "Num. of Comp.":** Prints the number of components of the current formula.

**Factory setting:** "Appl. Name" ("Formulation" is printed), "Date/Time", "Balance Type", "Serial Numbers" and "Recipe ID (in this order).

The header is printed automatically when the "M+" function key is pressed during formulation to save the weight of the first component.

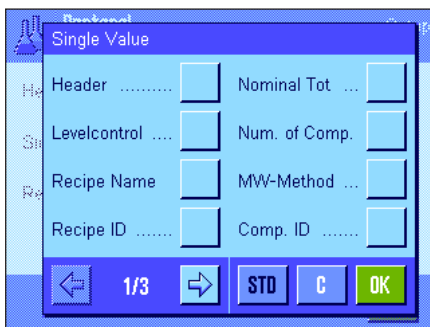

#### Printing single values

The following special settings are available in this submenu for the formulation:

- "Recipe Name":** Prints the name of the current formula.
- "Recipe ID":** Prints the identification (ID1) of the current formula.
- "Nominal Tot.":** Prints the sum of the nominal weight values of all components of the current formula.
- "Num. of Comp.":** Prints the number of components of the current formula.
- "Comp. ID":** Prints the ID of the current component (ID2).
- "Lot ID":** Prints the lot ID (ID3) defined via the "ID" function key.
- "Additional ID":** Prints the additional ID (ID4) defined via the "ID" function key.
- "Comp. Name":** Prints the name of the current component.
- "Comp. Counter":** Prints the current state of the component counter (number of the current component).
- "Nom.,+Tol,-Tol":** Prints the defined nominal weight of the current component and the defined tolerances.

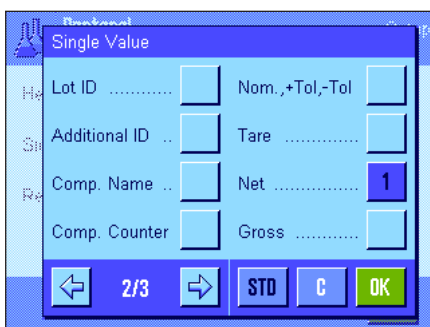

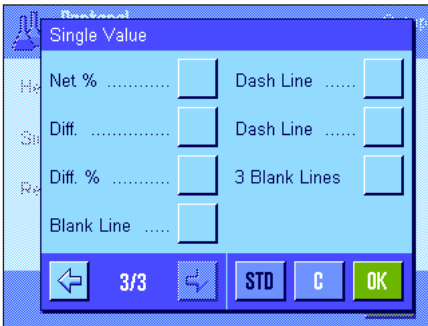

- "Net %": Prints the weight of the current component as a % of the nominal weight.
- "Diff.": Prints the difference between the actual and nominal weight of the current component.
- "Diff. %": Prints the percentage deviation of the current component between its actual weight and nominal weight.

**Factory setting:** "Net"; no specific information is activated for the Formulation.

**Note:** The names of the four IDs are specified ex works but can be changed (Section 9.3.6).

A single value is printed automatically when the "M+" function key is pressed during formulation. A single value can also be printed separately by pressing the «» key.

**Printing the result**

The second and third page of this submenu can be used to define which additional formulation information is to be included in the printed results record:

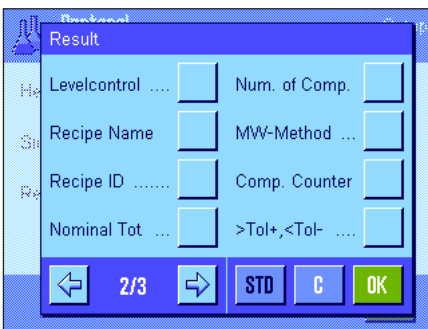

- "Recipe Name": Prints the name of the current formula.
- "Recipe ID": Prints the identification (ID1) of the current formula.
- "Nominal Tot.": Prints the sum of the nominal weight values of all components of the current formula.

"Num. of Comp.": Prints the number of components of the current formula.

"Comp. Counter": Prints the current state of the component counter (number of the current component).

">Tol+, <Tol-": Prints the number of components that are outside the upper or lower weight tolerance.

"Net Tot.": Prints the net total weight of all components weighed in.

**Factory setting:** "Tare", "Net Tot.", "Gross", "Signature", "Dash Line" and "3 Blank Lines" (in this order).

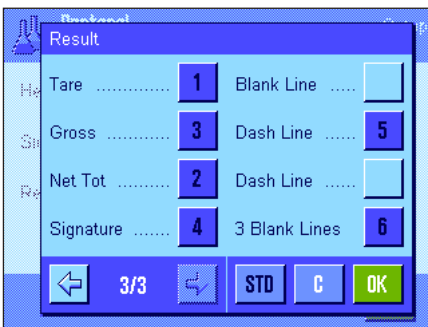

The results record is printed by pressing the «» key when the results window is open, or printed automatically once the last component of a formula has been transferred.

A **sample printout for formulation** can be found in Section 9.6.5.

### 9.3.6 Special identifications for Formulation

A maximum of 4 identifications, which should be available during formulation under the "ID" function key, can be activated and renamed in this menu. In addition, two titles for the weighing records can be defined and printed in the weighing records.

The screenshot shows the 'Identification' setup screen for 'User 3'. It has a blue header with a flask icon and 'Setup' text. Below the header are four rows of controls: 'Title 1' with a text box containing 'T1', 'Title 2' with a text box containing 'T2', 'ID1 Name' with a text box containing 'Recipe ID', and 'ID2 Name' with a text box containing 'Off'. At the bottom, there are navigation arrows, a '1/2' indicator, and an 'OK' button.

The following names for the 4 identifications are defined ex works:

"ID1" "Recipe ID"  
 "ID2" "Comp. ID"  
 "ID3" "Lot ID"  
 "ID4" "Additional ID"

Individual identifications can be deactivated or their names can be customized (maximum of 20 characters). The entered names also appear as the names of the relevant information fields (Section 9.3.4) and are included on the weighing printouts (Section 9.3.5).

**Factory setting:** "T1" and "T2" as the record titles  
 "ID1" activated, see above for name.

The screenshot shows the second page of the 'Identification' setup screen. It has a blue header with a flask icon and 'Setup' text. Below the header are two rows of controls: 'ID3 Name' with a text box containing 'Off', and 'ID4 Name' with a text box containing 'Off'. At the bottom, there are navigation arrows, a '2/2' indicator, and an 'OK' button.

**Note:** The "Recipe ID" and "Comp.ID" are not required to **automatically process predefined formulae** because they are transferred automatically from the formula or component database. The other IDs can be activated should you want to enter additional IDs during formulation. However, for **free formulation** (without using the database) the "Recipe ID" and "Comp. ID" should be activated so that your formulae and components can be assigned a name.

### 9.3.7 Special SmartSens and ErgoSens settings for Formulation

Additional settings for formulation are available for SmartSens and ErgoSens sensors.

The screenshot shows the 'Smart & ErgoSens' setup screen for 'User 3'. It has a blue header with a flask icon and 'Setup' text. Below the header are four rows of controls: 'SmartSens left' with a button labeled 'Result', 'SmartSens right' with a button labeled 'M+', 'ErgoSens 1 (Au\*1)' with a button labeled 'Recipe ID', and 'ErgoSens 2 (Au\*2)' with a button labeled 'Comp. ID'. To the right of these buttons is a vertical column of navigation arrows and a 'C' button. At the bottom, there is an 'OK' button.

"Result" and "M+" emulate the function keys of the same name. "OK" emulates pressing the button of the same name in the formulation dialog boxes (but not in the menus) to confirm entries and actions.

**Note:** The settings "Recipe ID", "Comp. ID", "Lot ID" and "Additional ID" correspond to the identifications ID1 ... ID4, which are also available in the "Weighing" application (Section 7.2.17).

If one of the above settings is activated, the green "F" (Function) icon lights up below the corresponding sensor in the status bar.

**Factory setting:** SmartSens left and right configured for door operation.  
 "Off" for both ErgoSens.

## 9.4 Defining components

Each formula consists of one or more components, which must be defined before the formulation. Your balance contains a component database, in which up to 100 components can be stored. This Section describes how to define components. **Note:** The component database is independent of the user profile. There is only **one** component database available for all users.

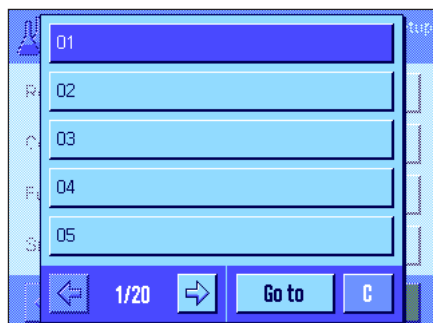

Press the «☰» key and select the menu for defining components (on the first menu page). The first page of the component database appears. The database comprises a total of 20 pages with 5 components on each. The arrow keys can be used to switch between the individual pages. Each of the 100 components can be selected directly by pressing the "Go to" button and entering the component number. In the illustration opposite, the database does not yet contain any entries.

Touch the component that you would like to define.



Each component consists of a **name** and an **identification (ID)**. When the corresponding button is touched, an alphanumeric input field opens in which the name and identification can be defined (maximum of 20 characters each). The software checks the plausibility of the entries: an error message appears if you try to enter a name or an ID that is already being used by another component. **Note:** In practice, the ID is often entered using a bar code reader. This ensures that the component has a unique reference to the relevant product. The common name of the relevant product can be used as the name. In the example opposite, a name and an ID have already been defined for component no. 1.

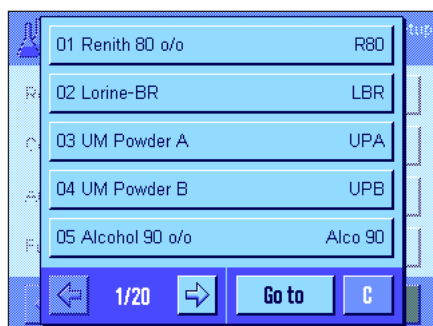

The example opposite shows the first page of the component database with the first five components.

**Note:** The contents of the component database can be printed at any time by pressing the «☰» key (the numbers of the components and their names are printed).

**Note:** To later change a component that has already been defined, please refer to the information in Section 9.7.

## 9.5 Defining and activating formulae

Your balance contains a formula database in which a maximum of 8 formulae can be stored, with up to 12 components for each formula. To define formulae completely, the corresponding components must be available in the component database (Section 9.4). This Section describes how to define formulae (to later change a formula that has already been defined, please refer to the information in Section 9.7). **Note:** The formula database is independent of the user profile. There is only **one** formula database available for all users.

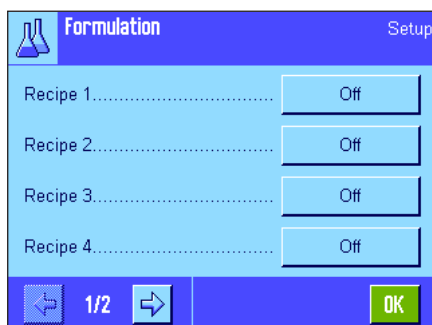

Press the «≡» key and select the menu for defining formulae (on the first menu page). The first page of the formula menu appears. The balance contains no formula data ex works; therefore, all formulae are deactivated ("Off").

Touch the button for the formula that you would like to define (e.g., Formula No. 2).



First, you must define which type of formula you would like to create:

**"Fix Component":** **Absolute** nominal weights are defined for the individual components.

**"% Component":** **Relative** (percentage) nominal values are defined for the individual components, either in relation to the final weight or the first component.

Activate the desired type of formula and then press the corresponding "Define" button. The procedure for defining a formula varies, depending on the type of formula. This procedure is therefore explained below in two separate Sections.

### 9.5.1 Formulae with "Fixed Components" (absolute nominal weights)

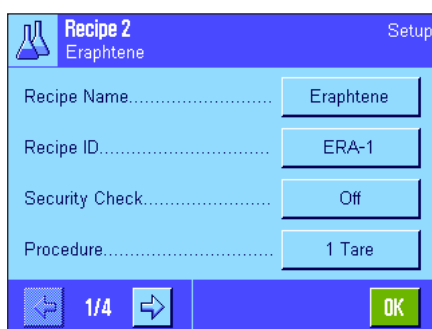

Each formula is stored under a **name**. It is therefore essential to enter a name. The definition of an **identification (ID)** is only required if the "security check" is used (see below) or if the ID is to be listed on the weighing records. When the corresponding button is touched, an alphanumeric input field opens, in which the name and identification can be defined (maximum of 20 characters each). In the example opposite, a name and an ID have already been defined for Formula No. 2. **Note:** The software checks the plausibility of the entries: An error message appears if you try to enter a name or an ID that is already being used by another formula.

The **"Security Check"** is switched off ex works. If the **"Security Check"** is switched on, the formula ID (and the component IDs) must be entered for each formulation and the formulation operation is only carried out if the IDs correspond to the formula specifications. This ensures that the user is working with the correct formula and the correct components are weighed in.

The **procedure for formulation** can be defined in the **"Procedure"** menu:

**"1 Tare":** All components are weighed in in 1 container. Taring is only required at the beginning of the formulation (factory setting).

**"n Tare":** Each component is weighed in in its own container. Taring is carried out before each initial weighing.

Recipe 2  
Eraphtene

Component 1 ..... Off

Component 2 ..... Off

Component 3 ..... Off

Component 4 ..... Off

2/4 OK

Menu pages 2 to 4 can be used to select components, which are to be part of the current formula and to define specifications for their processing. All components are deactivated ex works ("Off").

Touch the button for the component that you would like to include in the formula. A window appears in which the component can be activated. Press the "Define" button to define the specifications for processing the component.

Recipe 2  
Eraphtene, Component 1

Component Name ..... Renith 80 o/o

Comp. ID ..... R80

Component Weight ..... 24.1637 g

+Tolerance ..... 2.50 %

1/2 OK

In this menu window, first select the desired component from the component database and then define its nominal weight and the permissible tolerances.

To **select the component**, press the button next to the component name or component ID. In both cases, the component database opens and the desired component can be selected by touching it. In the example opposite, a component has already been selected.

Then define the "**Component Weight**" (nominal weight) and the permissible **tolerances** for the component (in % or in a weight unit).

Select other components for the current formula and define the specifications for their processing. The balance is now ready to process the formula.

## 9.5.2 Formulae with "% components" (relative nominal value)

The definition of formulae with components with relative nominal values differs only slightly from the definition of formulae with "absolute components".

Recipe 3  
Iorex-MP

Recipe Name ..... Iorex-MP

Recipe ID ..... IORX

Security Check ..... Off

Basis ..... Total weight

1/4 OK

The entry of the formula name and ID and the setting for the "Security Check" are identical (Section 9.5.1).

In addition, the "**Basis**" for weighing in components must be defined:

### "Total Weight":

The percentage nominal value of each component refers to the total weight (final weight) of the formula. The desired final weight must first be entered during the formulation and then the nominal weights of the individual components are calculated automatically as a percentage of this weight. This is the factory setting.

### "Comp. 1 Weight":

The nominal weight of the first component must be entered during formulation. This weight corresponds to the percentage value that is specified in the formula definition. The nominal weights of the other components are then calculated automatically in relation to the first component. **Example of a formula with 2 components:** Define a percentage of 75% for the first component and a percentage of 40% for the second component. Enter a nominal weight of 100g for the first component during formulation. The balance calculates a nominal weight of 53.33g ( $100 \text{ g} / 75\% \cdot 40\% = 53.33\text{g}$ ) for the second component.

**Note:** No formulation procedure can be selected for formulae with relative component nominal values because all components must always be weighed in in 1 container.



Recipe 3		Setup
Iorex-MP, Component 1		
Component Name.....	UM Powder A	
Comp. ID.....	UPA	
Component %.....	22.6 %	
+Tolerance.....	2.50 %	
1/2		OK

When defining specifications for the individual components, a **percentage nominal value** must be entered instead of an absolute nominal weight (depending on the selected "**Basis**", this refers to either the total weight of the formula or the first component).

The remaining settings and specifications for the components are identical to those for formulae with "absolute components".

**Important note** for formulae with percentage nominal values, which refer to the **total weight**: The balance does not check whether the sum of all component percentages is 100%. If this sum is above or below 100%, the defined percentages and the nominal weights to be weighed in are adapted automatically during the formulation operation, as shown in the **example** below:

**Specifications:**

Nominal value Component 1: **80%**, nominal value Component 2: **40%**, final weight: **100g**

**Automatic calculation of the nominal weights to be weighed in:**

Component 1:  $80\% / 120\% \cdot 100\text{g} = \mathbf{66.67\text{g}}$

Component 2:  $40\% / 120\% \cdot 100\text{g} = \mathbf{33.33\text{g}}$

### 9.5.3 Printing the formula definitions

When you are in the menu for defining a specific formula, you can print the settings and specifications for the current formula at any time by pressing the «» key.

The following examples show (from left to right) one sample printout for a formula with absolute nominal weights, one with relative nominal values in relation to the total weight and one with relative nominal values in relation to the first component.

Recipe 2	Fix Component
Name	Eraphtene
ID	ERA-1
Security Check	Off
Procedure	1 Tare
Component 1	
Name	Renith 80 o/o
ID	R80
Component Weight	
	24.1637 g
+Tolerance	2.50 %
-Tolerance	2.50 %
Component 2	
Name	Lorine-BR
ID	LBR
Component Weight	
	16.4592 g
+Tolerance	2.50 %
-Tolerance	2.50 %
Component 3	
Name	Alcohol 90 o/o
ID	Alco 90
Component Weight	
	77.0088 g
+Tolerance	2.50 %
-Tolerance	2.50 %

Recipe 3	% Component
Name	Iorex-MP
ID	IORX
Security Check	Off
<b>Basis</b>	<b>Total weight</b>
Component 1	
Name	UM Powder A
ID	UPA
Component %	22.6 %
+Tolerance	2.00 %
-Tolerance	2.00 %
Component 2	
Name	UM Powder B
ID	UPB
Component %	77.4 %
+Tolerance	3.00 %
-Tolerance	3.00 %

Recipe 4	% Component
Name	Meranit-411
ID	ME-411
Security Check	Off
<b>Basis</b>	<b>1. Comp. Weight</b>
Component 1	
Name	RF Subst. A
ID	RF-A
Component %	75.0 %
+Tolerance	2.50 %
-Tolerance	2.50 %
Component 2	
Name	Sirine Liq. 16
ID	SI-LIQ
Component %	40.0 %
+Tolerance	1.50 %
-Tolerance	1.00 %

## 9.6 Working with the "Formulation" application

This Section describes how to work with the "Formulation" application and print the results.

### 9.6.1 Presettings



The minimum requirement for each formulation is that the 3 function keys "M+", "Result" and "CL Result" must be activated (Section 9.3.3).

Other function keys must be activated depending on the type of formulation:



For **free formulation** without using formulae from the database, the "Nominal", "+Tolerance" and "-Tolerance" function keys must also be activated. The corresponding values can be entered using these keys.



For **free formulation**, the "ID" function key should be activated so that your formulae and components can be assigned the desired names. It can also be useful to activate this function key for **automatic formula processing** if you want to assign another one or two custom IDs to your components in addition to the preset IDs (e.g., a lot ID).



If you want to work with components from the component database during **free formulation**, the "CompDB" function key, which is used to call components from the database, must also be activated.



To **automatically process formulae** from the database, the "Recipe" function key, which is used to call up formulae, must be activated.



**Regardless of the type of formulation**, we recommend that the "Abs/Diff" function key is activated. This key can be used at any time to switch the weight display between the quantity of a component already weighed in and the remaining quantity to be weighed in.

The most important **information fields** for your application should also be activated (e.g., "Recipe Name", "Comp. Name", "Nominal" and "Comp. ID" for automatic formula processing, see Section 9.3.4).

A printer should be connected to your balance for printing formulations.

## 9.6.2 Free formulation (formulation without using the formula database)

It is assumed that the required function keys and information fields are activated (Section 9.6.1).

If you are working with a weighing container, place it on the balance and press the «→T←» key to tare the balance.

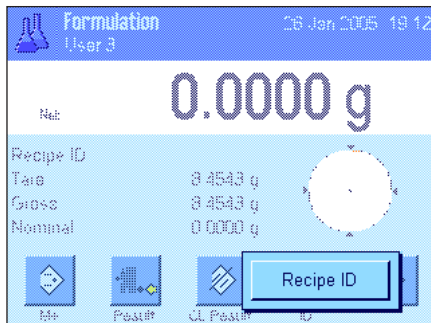

Press the "ID" function key and enter the desired name for the formula (if ID2, ID3 and ID4 are also activated, additional names can be entered, e.g. for the first component, etc.).

**Note:** If you would like to use one or more components from the component database for free formulation, the "CompDB" function key must be activated. This function key can be used to directly access the component database and select the desired component. In this case, there is no need to enter a component ID, as it will be transferred directly from the database.



If you wish to weigh in to a nominal value, press the "Nominal" function key and specify the nominal weight of the **first component**.

**Note:** If you have switched to the display of the remaining quantity (difference) using the "Abs/Diff" function key before entering the nominal weight, this weight appears as a negative value in the display (weighing in towards zero).

If you are working with tolerances, enter the corresponding values via the "+Tolerance" and "-Tolerance" function keys (samples outside the tolerance range are marked with ">T" and "<T" when the single values are printed).

As soon as the nominal weight and tolerances of the first component have been entered, a graphic weighing-in aid ("SmartTrac") appears with tolerance markers, which simplify weighing in to the nominal value.

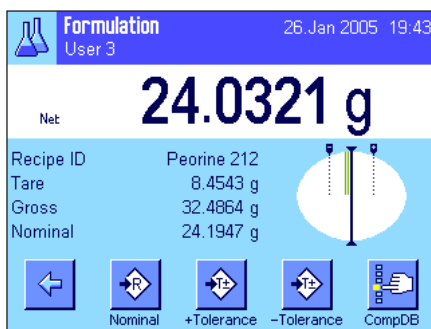

Weigh in the first component.

**Note:** The "Abs/Diff" function key can be used at any time to switch the weight display between the quantity of a component already weighed in and the remaining quantity to be weighed in.



When the nominal weight is reached or the weight is within the tolerances, press the "M+" function key to save the value (**first check the weight value again, as the balance does not check whether the weighed-in weight agrees with the nominal weight**). The report header is printed out together with the result (single value) of the current component.

The balance is now ready for weighing in the **second component**. If you want to weigh in the second component in a new weighing container, place the container on the balance and tare the balance. If you want to weigh in the second component in the same container, taring is not required.

Enter the nominal weight and the tolerances. Weigh in the components and save the result using the "M+" function key.

Weigh in the other components as described above. Each time "M+" is pressed, the recorded single value is printed automatically according to your specifications (Section 9.3.5).

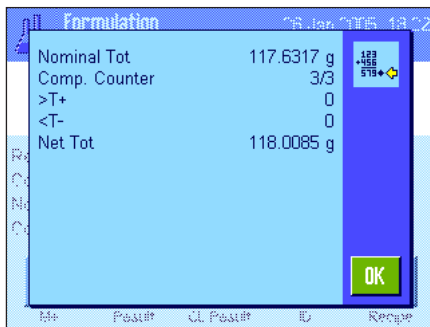

Once all the components of the formula have been weighed in, press the "Result" function key. (This is only available if values are present in the memory. Otherwise, the key is grayed out and cannot be pressed.) After the "Result" function key has been pressed, the results of the formulation appear in the display (the information selected for printing the result is displayed, see Section 9.3.4).

The result of the formulation can be printed and the formula record closed by pressing the «Print» key. A complete sample printout can be found in Section 9.6.5.



If you have completed the formulation and wish to clear the memory in preparation for the next formulation, press the "CL Result" function key (a safety prompt is displayed, which must be confirmed before the data is actually deleted).

### 9.6.3 Automatic formula processing with "Fix Components" (absolute nominal weights)

It is assumed that the relevant formula has already been defined (Section 9.5.1) and the required function keys and information fields are activated.



Press the "Recipe" function key and select the desired formula from the formula database. Formula processing starts as soon as the formula is called up. **Note:** If the "Recipe" function key is displayed in gray, a new formula cannot be selected, as another formulation is being processed. If this is the case, press the "CL Result" function key to end the current formulation.

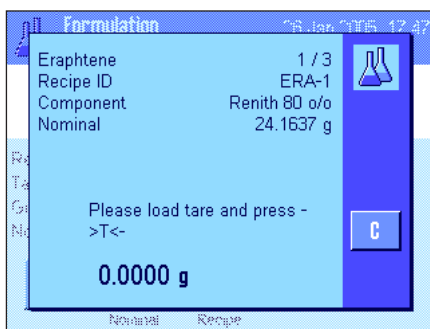

You will be prompted to tare the balance. Place the weighing container on the balance and press the «→T←» key.

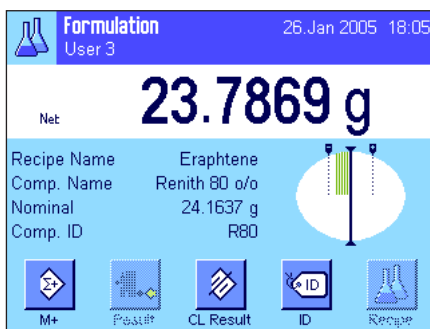

The balance is now ready for weighing in the first component, whose name, nominal value and ID are displayed in the corresponding information fields. Weigh in the first component. Note the graphic weighing-in aid ("SmartTrac") with tolerance markers, which simplify weighing in to the nominal value. **Observe this display carefully because the balance does not check whether the weighed-in weight agrees with the nominal weight.** In the example opposite, the component has not yet fully reached the nominal weight but is already within the tolerances.

**Note:** The "Abs/Diff" function key can be used at any time to switch the weight display between the quantity of a component already weighed in and the remaining quantity to be weighed in.



When the nominal weight is reached or the weight is within the tolerances, press the "M+" function key to save the value. The report header is printed out together with the single value of the current component (Section 9.3.5). **Note:** After the first component has been weighed in, the "Result" function key can also be selected and used at any time to open the results window and to access information on the current state of formulation.

The balance is now ready for weighing in the **second component**.

**Note:** If the formula definition specifies that each component should be weighed in in its own container, (Section 9.5.1), you will be prompted to place the new weighing container on the balance and press the «→T←» key before weighing in the second component. If, according to the formula definition, all components should be weighed in in the same container, this taring is not required. If **automatic zeroing** has been activated (Section 9.3.2), when the tare container is removed the display is automatically reset to zero.

Weigh in the other components as described above. Each time "M+" is pressed, the recorded single value is saved and printed automatically, according to your specifications.

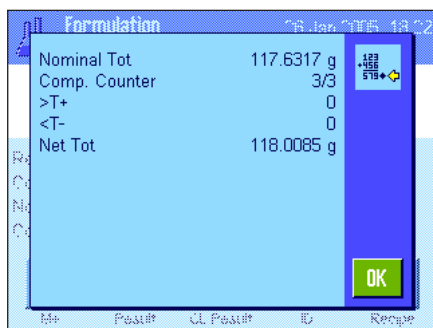

Once all the components of the formula have been weighed in, the window with the results of the formulation appears automatically (the information selected for printing the result is displayed, see Section 9.3.5). The formula record is closed simultaneously (a complete sample printout can be found in Section 9.6.5).



If you have completed the formulation (or cancelled it before completion) and wish to clear the memory in preparation for the next formulation, press the "CL Result" function key (a safety prompt is displayed, which must be confirmed before the data is actually deleted). **Note:** A new formulation cannot be processed until the "CL Result" function key has been pressed.

#### Important note

- It is the responsibility of the user to ensure that the weighed-in weights are within the defined tolerances. The balance does not check this. If an incorrect weight value is transferred via the "M+" function key, the result of the formulation will also be incorrect.
- As soon as a formula has been called up, neither the identification of the formula ("Recipe ID") nor the identification of the components ("Comp. ID") can be changed, as they are part of the relevant formula or component definition in the databases.

### 9.6.4 Automatic formula processing with "% Components" (relative nominal values)

Automatic formula processing with "% Components" is basically identical to formula processing with "Fix Components". Therefore, the procedure is only described in brief below.

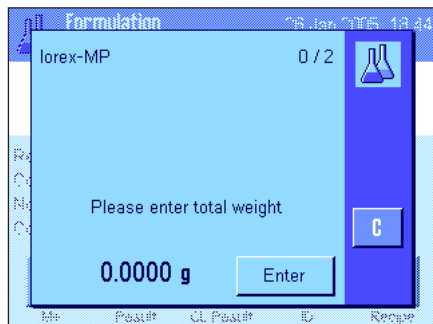

Depending on the basis for weighing in components, which is specified in the formula definition (Section 9.5.2), when the formula is called up you will first be prompted to enter the desired **final weight of the formula** or the **nominal weight of the first component**. Enter the required value.

The example opposite shows the prompt for entering the final weight.

Once the final weight (or the nominal weight of the first component) has been entered, you are prompted to tare the balance. Place the weighing container on the balance, press the «→T←» key and the balance is then ready for weighing in the first component. The nominal weight is displayed in the "Nominal" information field and the SmartTrac supports you when weighing in the nominal weight.

Weigh in the first component. The "Abs/Diff" function key can also be used to switch the weight display between the quantity of a component already weighed in and the remaining quantity to be weighed in. When the nominal weight is reached or the weight is within the tolerances, press the "M+" function key to save the value.

Weigh in the other components. Once the last component has been weighed in, the results window appears automatically and the formula record is closed.

### 9.6.5 Sample printout of a formulation

```

----- Formulation -----
26.Jan 2005          20:10
User Name           User 3
Recipe              Iorex-MP
Recipe ID           IORX
Num. of Comp.       2
Nominal Tot 84.3000 g
Comp. ID            UPA
Comp.               1/2
Nominal            19.2204 g
+Tol               0.3844 g
-Tol               0.3844 g
 1      N          19.2689 g
 1      N           100.3 %
1Diff.            0.0485 g
1Diff.             0.3 %
Comp. ID            UPB
Comp.               2/2
Nominal            65.0796 g
+Tol               1.9524 g
-Tol               1.9524 g
 2      N          65.7750 g
 2      N           101.1 %
2Diff.            0.6954 g
2Diff.             1.1 %
Net Tot            85.0439 g

Signature
.....

```

The figure opposite shows the sample printout of a formulation (the corresponding formula definition can be found in Section 9.5.3, "Formula 3").

The values printed in the header, as single values and as the result depend on your individual record settings (Section 9.3.5).

Only specific information for the formulation is explained below. Notes on additional record information can be found in Section 7.2.8:

<b>"Recipe":</b>	Name of the formula.
<b>"Recipe ID":</b>	Identification of the formula ("ID1").
<b>"Num. of Comp.":</b>	Prints the number of components of the current formula.
<b>"Nominal Tot.":</b>	Sum of the nominal weight values of all components.
<b>"Comp. ID":</b>	Defined name of the component ("ID2").
<b>"Comp.":</b>	Status of the component counter (current comp./number of comp.).
<b>"Nominal":</b>	Nominal weight of the component.
<b>" +Tol" and "- Tol":</b>	Defined tolerances for a component.
<b>"N" [g]:</b>	Weight of the relevant component.
<b>"N" [%]:</b>	Weight of the relevant component as a % of the nominal weight.
<b>"Diff." [g]:</b>	Difference between the actual and nominal weight of the relevant component.
<b>"Diff." [%]:</b>	Percentage deviation of the actual weight of the relevant component from its nominal weight.
<b>"Net Tot":</b>	Net total weight of all components.

## 9.7 Notes on changing existing components and formulae

It is possible to change the definition of stored formulae and components. The following rules apply for this:



- When a formula is being processed, neither stored formulae nor components can be changed.
- If you want to change a component that is part of a formula, the error message opposite appears. Should you still wish to change the component, it must first be deactivated in all corresponding formulae. If you would like to include the component in the corresponding formulae again after modification, it must be explicitly selected from the component database, activated in the formula, and the nominal value and tolerances must be re-entered. We recommend that formula names and IDs are changed in all cases. This avoids confusion with earlier formulations, which have been carried out using the old definition of the corresponding formula.
- To remove a component from the database, simply delete its name or ID. However, this is only possible if the component is not part of a formula (see above).
- Formulae cannot be deleted from the database. If a formula is no longer required, deactivate it. The only way to permanently remove a formula from the database if it is no longer required is to overwrite it with a new one.



## 10 The "Piece Counting" application

This Section describes the "Piece Counting" application. You will find here information on how to work with this application and on the relevant setting options. **Please note that all settings for the "Piece Counting" application are stored under the active user profile. User-specific settings can thus be entered for this application. Therefore, make sure that you have selected the desired user profile first.**

### 10.1 Introduction to the "Piece Counting" application

The "Piece Counting" application allows you to count pieces. The application provides several different methods for determining the reference piece weight.

Many of the application-specific settings are identical to those of the "Weighing" application. However, additional application-specific function settings are available for Piece Counting. In the following description, only those settings are described in detail which differ from the "Weighing" application.

**Note:** If you use the "Piece Counting" function in conjunction with the METTLER TOLEDO LC-I/O relay interface, please note the information provided in the "**Solution Guide**", which is available on the Internet ([www.mt.com/xp-analytical](http://www.mt.com/xp-analytical)).

### 10.2 Selecting the application

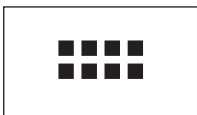

If the "Piece Counting" application is not already active, press the «...» key. Touch the application icon in the selection window.

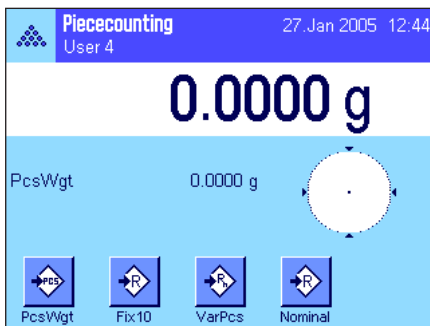

The display opposite appears when the application is selected. Some of the special function keys, as well as a special information field for piece counting, are activated ex works. The function keys and other settings can be adapted to your requirements, according to the descriptions in the following Sections.

### 10.3 Settings for the "Piece Counting" application

A number of different specific settings are available for piece counting, and these can be used to adapt the application to your requirements.

#### 10.3.1 Overview



The application-specific settings can be accessed via the «≡» key. When this key is pressed, the first of 5 menu pages is displayed.

The setting options for the "Piece Counting" application are virtually identical to those for the "Weighing" application (Section 7.2). Only the settings that differ are described below. They apply to the following menus:

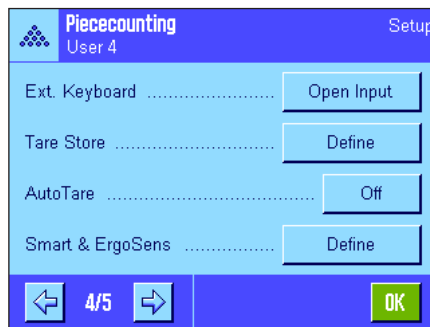
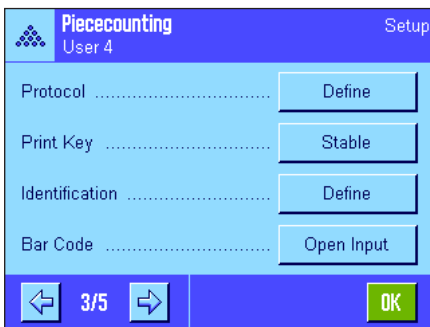
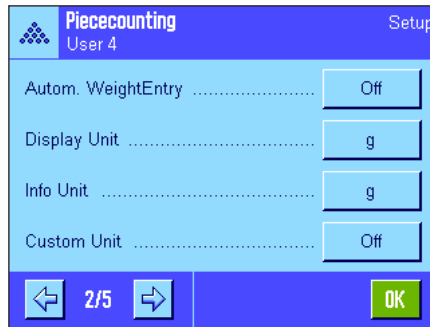
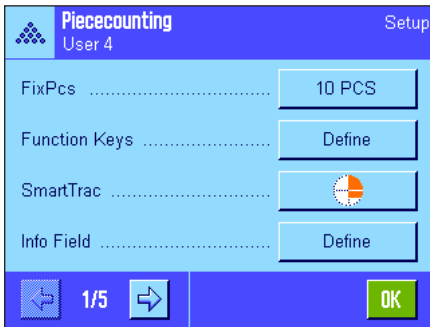

**"FixPcs":**

Allows you to specify a fixed reference piece number.

**"Function Keys":**

Additional function keys are available for piece counting.

**"Info Field":**

Additional information fields are available for piece counting.

**"Autom. Weight Transfer":**

This setting can be used to automatically calculate total piece counts.

**"Display Unit" and "Info Unit":**

The "PCS" unit is also available for piece counting.

**"Protocol":**

Additional record information is available for piece counting.

**"Smart & ErgoSens":**

Special functions can be assigned to the sensors for piece counting.

Keep in mind that, unlike the "Weighing" application, you can specify only **one** free unit. The "MinWeigh" function is also not available. The specific settings for the "Piece Counting" application are described in detail in the following Sections.

**10.3.2 Specifying the fixed reference piece number**

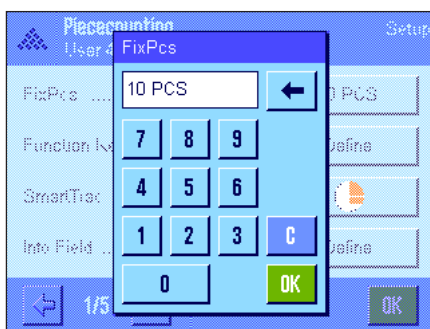

This menu can be used to assign a fixed reference piece number to the "FixPcs" function key (Section 10.3.3). After pressing the corresponding button, an input window appears in which you can define the desired reference piece number.

Each time the "FixPcs" function key is pressed during a piece count, the weight in the weighing pan is divided by the specified fixed reference piece number. This determines the reference piece weight, which serves as the basis for the piece counting.

**Note:** The "FixPcs" function key is marked "Fix n" where "n" is the reference piece count selected here. Example: "Fix 10".

**Factory setting:** 10 PCS.

### 10.3.3 Special Function Keys for piece counting

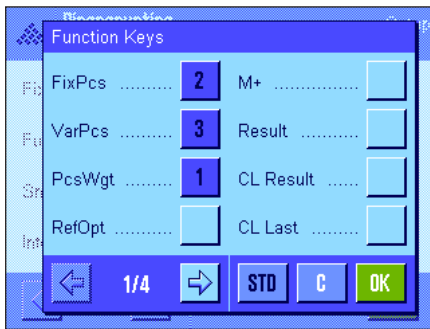

The following settings are available for piece counting on the first two pages of the function key menu:

- "**FixPcs**": Determines the Reference piece weight using a specified number of fixed pieces (Section 10.4.1).
- "**VarPcs**": Allows free selection of the Reference piece count (Section 10.4.1).
- "**PcsWgt**": Allows input of the known weight of a reference piece.
- "**RefOpt**": Carries out a reference optimization (Section 10.4.4).
- "**M+**": Transfers the current piece count to the memory (Section 10.4.2).
- "**Result**": Opens the results window (Section 10.4.2).
- "**CL Result**": Deletes the stored values of a series of piece counts (Section 10.4.2).
- "**CL Last**": Deletes the most recently saved piece count (Section 10.4.2).
- "**Nominal**": Specifies the desired nominal piece count (Section 10.4.3). The nominal piece count is also used as the reference for the tolerances (described below).
- "**Abs/Diff**": Switches the weight display between the piece count that has already been weighed in and the number of pieces to be weighed in before the nominal piece count is reached (Section 10.4.2).
- "**+Tol**" and "**- Tol**": Defines the precision (tolerances) for piece counting (Section 10.4.3).
- "**Max n**": Specifies the maximum number of piece counts in a series (Section 10.4.2).

All other function keys are identical to those for the "Weighing" application (Section 7.2.2).

**Factory setting:** "PcsWgt", "FixPcs", "VarPcs" and "Nominal" are activated (in this order).

### 10.3.4 Special information fields for piece counting

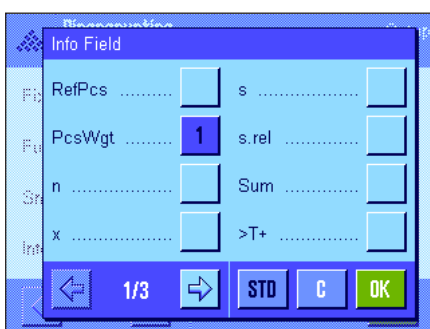

The following settings for piece counting are available on the first two pages of the menu for information fields:

- "**RefPcs**": Selected reference piece number.
- "**PcsWgt**": Reference piece weight.
- "**n**": Number of implemented and stored piece counting processes in a series.
- "**x**": Average piece of all counting process in a series.
- "**s**" and "**s.rel**": Standard deviation in a series of piece counts as an absolute or percentual value.
- "**Sum**": Total piece count of all counting processes in a series.
- "**>T+**" and "**<T-**": Number of implemented counting processes outside the upper or lower tolerances.

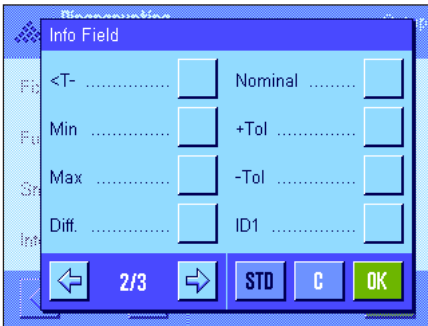

- "Min" and "Max":** Smallest and largest recorded piece counts in a series of piece counts.
- "Diff":** Difference between the largest and smallest piece counts in a series of piece counts.
- "Nominal":** Shows the nominal piece count entered via the function key of the same name.
- " +Tol" and "- Tol":** These information fields show the tolerances entered via the function keys of the same name.

All other information fields are identical to those for the "Weighing" application (Section 7.2.4).

**Factory setting:** "PcsWgt" is activated.

### 10.3.5 Specifications for automatic weight transfer

This menu option can be used to specify whether and under which conditions the balance is to automatically transfer a stable weight value to the statistics (this prevents you from having to press the "M+" function key during series counting). Also, the piece count is not automatically printed.

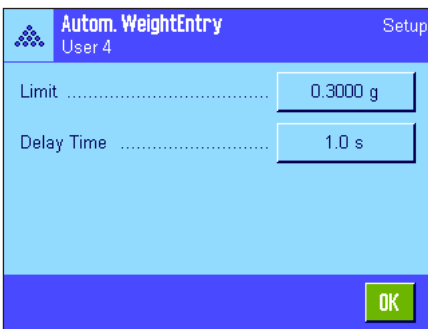

When you activate this function ("On"), press "Define" to define the criteria for automatic weight transfer:

- "Limit":** This value defines the smallest modification (piece count or weight, depending on the unit selected) required to trigger an automatic transfer of the measurement value to the memory.
- "Delay Time":** As soon as the minimum weight change is reached, the "DelayTime" starts. Once this time has elapsed, the weight value is recorded and transferred to the statistics or transmitted via the interface.

**Factory setting:** "Off" (automatic transfer is deactivated).

### 10.3.6 Additional unit for piece counting

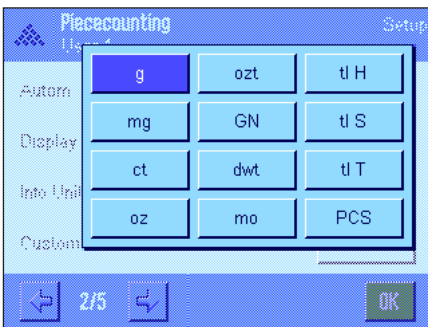

In addition to the common weighing units, the menus for the "Display Unit" and the "Info Unit" also contain the "PCS" unit (provided that a reference piece weight was already determined).

**Note:** The "PCS" unit does not have to be explicitly selected for piece counting, since the display unit always switches to "PCS" automatically when the reference piece weight is being determined. The desired unit can be selected at any time after the reference piece weight is determined (unless a value has already been transferred to the memory during a series of piece counts; in this case, switching between "PCS" and the other weighing units is not possible until the results have been cleared).

**Factory setting:** "g" (gram) for "Display Unit" and "Info Unit".

### 10.3.7 Special printout information for piece counting

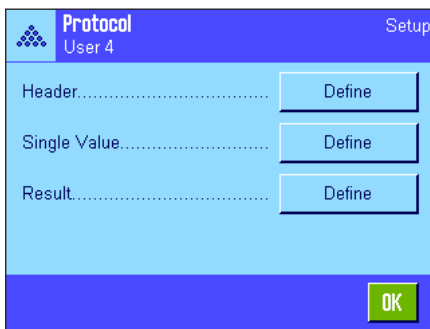

The three submenus for defining the record header, printing individual values and for the result contain additional settings for piece counting, which are described below.

**Note:** The other available record information is the same as for the "Weighing" application (Section 7.2.8) and is not described here.

#### Record header

Additional settings for piece counting are available on the second page of this submenu:

**"Max n":** The defined maximum number of piece counts in a series is printed.

**"Nom.,+Tol,-Tol":** The defined nominal piece number and the selected tolerances are printed.

**Factory setting:** "Appl. Name" ("Piece Counting" is printed), "Date/Time", "Balance Type" and "Serial Numbers" (in this order); no specific information is activated for piece counting.

The header is printed automatically when the "M+" key is pressed during a series of piece counts to store the first count value. The header can also be printed separately by pressing the "Header" function key.

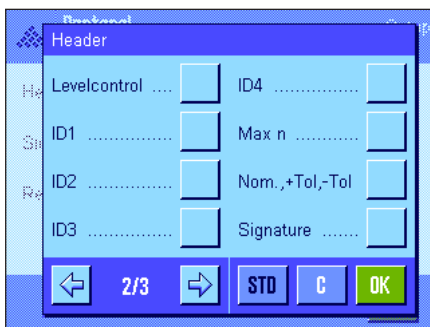

#### Printing single values

The following special settings are available for piece counting on the first and second pages of this submenu:

**"Nom.,+Tol,-Tol":** The defined nominal piece number and the selected tolerances are printed.

**"RefPcs":** The selected reference piece number is printed.

**"PcsWgt":** The recorded reference piece weight is printed.

**"NetPcs":** The recorded net piece number is printed.

**Factory setting:** "ID1", "Nom.,+Tol,-Tol", "Net" and "NetPcs" (in this order). A single value is printed automatically when the "M+" function key is pressed during series counts. A single value can also be printed separately by pressing the «» button (in which case no item counter is placed in front of the net value).

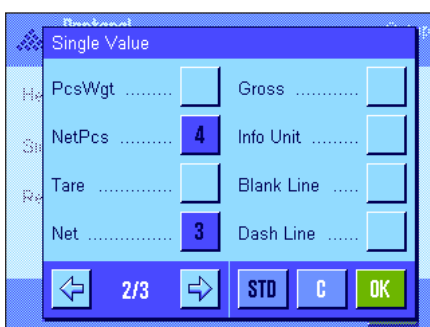
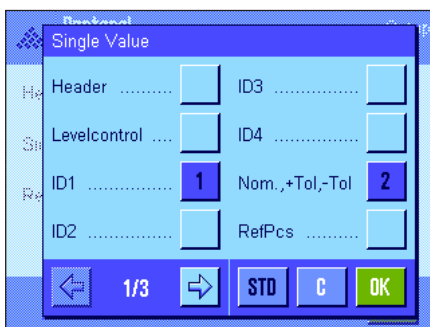

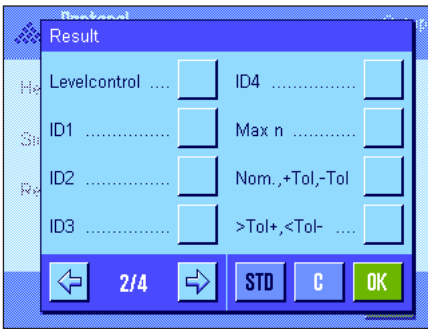

**Printing the result**

The second and third page of this submenu can be used to define which additional information for piece counting is to be included in the printed results record:

- "Max n": Defined maximum number of piece counts in the series.
- "Nom., +Tol, -Tol": Defined nominal piece count and selected tolerances.
- ">Tol+, <Tol-": Number of piece counts outside the upper and lower tolerance range.
- "n": Number of completed piece counts in a series.
- "x": Average piece count of all counts in a series.
- "s" and "s.rel": Standard deviation as an absolute and percentual value.  
**Note:** These two values are printed only if the memory contains at least 3 values. Otherwise, horizontal dashes appear in place of the values.
- "Min, Max, Diff.": Smallest and largest recorded piece count within the current series of measurements, and the difference between the largest and smallest piece count.
- "Sum": Total of the values of all saved single measurements in the current display unit.
- "SumPcs": Total piece count of all saved single counts.

**Factory setting:** "n", "x", "s", "s.rel", "Min, Max, Diff.", "Sum" and "SumPcs", as well as "Signature" and "3 Blank Lines" are activated (in this order).

The results record is printed by pressing the «» key when the results window is open. If a specific number of single counts is defined for a series of piece counts ("Max n"), the results record is printed automatically as soon as the result of the last count has been transferred to the statistics.

A **sample printout for a piece count** can be found in Section 10.4.5.

**10.3.8 Special SmartSens and ErgoSens settings for piece counting**

Additional settings for piece counting are available for the SmartSens and ErgoSens sensors.

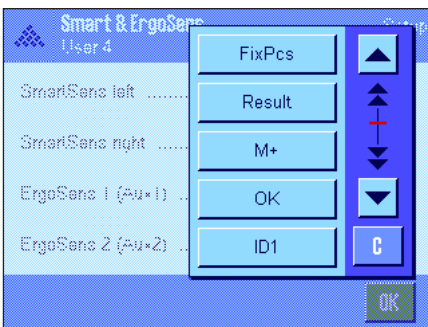

"FixPcs", "Result" and "M+" emulate the function keys of the same name. "OK" emulates pressing the button of the same name in the piece counting dialog boxes (but not in the menus) to confirm entries and actions.

If one of the above settings is activated, the green "F" (Function) icon lights up below the corresponding sensor in the status bar.

**Factory setting:** SmartSens left and right configured for door operation. "Off" for both ErgoSens.

## 10.4 Working with the "Piece Counting" application

This Section describes how to work with the "Piece Counting" application. You can of course determine a tare, change the resolution of the weighing result, work with IDs, etc.

Since these possibilities are discussed in the Section on the "Weighing" application (Section 7.3), they will not be repeated here.

### 10.4.1 Simple piece counting

#### Presettings



To carry out a simple piece count, at least one of the 3 function keys shown opposite must be activated (Section 10.3.3) so that the reference can be determined.

We also recommend that the information fields "PcsWgt" (reference piece weight) and "RefPcs" (reference piece number) be activated (Section 10.3.4).

#### Determining the reference

Place the desired number of reference pieces on the weighing pan. The balance uses these reference pieces to determine the average piece weight, which serves as the basis for piece counting.

When you have placed exactly the same number of pieces on the weighing pan as the number specified for the "FixPcs" function key (Section 10.3.2), press this function key. As soon as the weighing result is stable, the calculated average piece weight is accepted as the reference. The information fields display the average piece weight (the number of decimal places depends on the model) and the reference piece number.

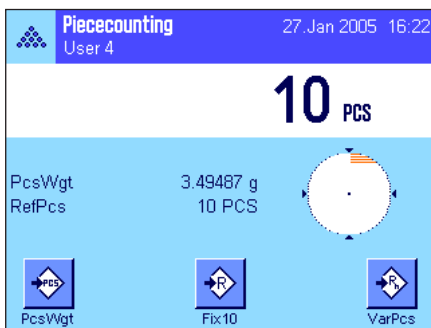

If you have placed a **different number of reference pieces** on the weighing pan than the number corresponding to the "FixPcs" key (e.g., 32 pieces), press the "VarPcs" (variable piece number) function key. An input field appears, in which you can enter the number of pieces.

After you confirm the number of pieces, the balance determines the reference. The information fields then display the reference piece number and the average piece weight.



**If the piece weight is known**, it can be entered directly. To do this, press the "PcsWgt" function key. An input field appears, in which the piece weight can be entered in the desired unit.

Since the balance does not have to determine a reference if this method is used, the result of the piece counting (the number of pieces currently on the weighing pan) is displayed right after the piece weight has been confirmed.

The information fields then display the reference piece weight that has been entered and the reference piece number "1" (because the weight of one single piece has been entered).



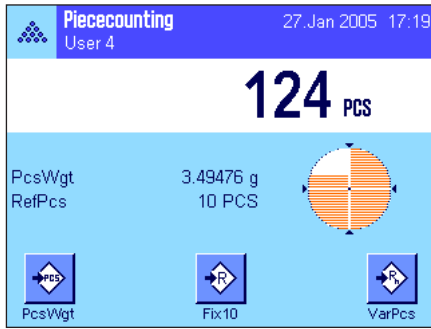

### Implementing the piece count

After the reference has been determined, place the pieces you wish to count on the weighing pan. The number of pieces determined appears in the results display.

**Note:** If you want to know the weight of the pieces in the weighing pan instead of the number, touch the "PCS" unit and select the desired weighing unit.

The recorded single value can be printed using the «» key. A sample printout can be found in Section 10.4.5.

## 10.4.2 Totaling piece counts and recording them statistically

### Presettings

The minimum requirement for totaling and recording piece counts is that the 3 function keys shown opposite be activated (Section 10.3.3), as well as at least one of the function keys for determining the reference (Section 10.4.1).

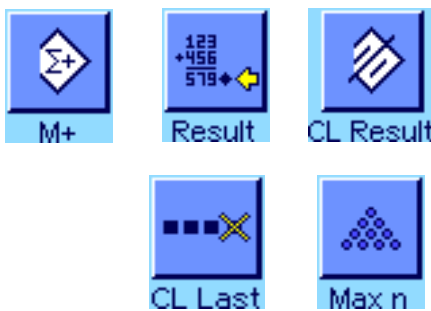

In addition, we recommend that you activate both of the function keys opposite. They are used to delete incorrect values ("CL Last") and to define the number of piece counts to be included in a series ("Max n").

A printer should be connected to your balance for optimum use of the statistical functions. If no printer is connected, we recommend that you activate the four main information fields for the statistics for your application (e.g., "n", "x", "Min" and "Max", see Section 10.3.4).

### Operating sequence



If the number of piece counts for a series is specified in advance, you can press the "Max n" function key and enter the number (1 ... 999). Upon completion of the final piece count, the series is automatically closed, the results window is opened and the results record is printed. **Note:** This function key is active only when the statistics do not yet contain any measured values. Enter the value 0 (zero) for "Max n" to set an unlimited series where you can record up to 999 piece counts.

If you are working with a weighing container, place it on the pan and press the «» key to tare the balance (alternatively you can also work with the tare memories or use the automatic tare function; these functions are described for the "Weighing" application in Section 7).

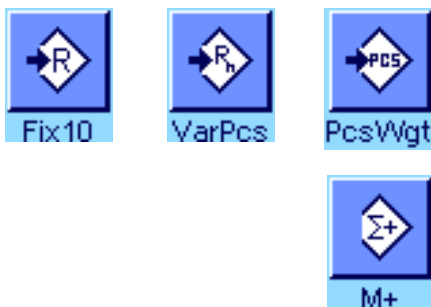

Determine the reference using the desired method (fixed reference piece number, variable reference piece number or enter the known piece weight, see Section 10.4.1).

Carry out the first piece count and press the "M+" function key to transfer the weight to the statistics. As soon as the result becomes stable (horizontal dashes disappear), the value is transferred to the statistics. The report header is printed out together with the result (single value) of the current piece count (Section 10.3.7).



Take the pieces from the first count out of the weighing pan. Carry out the series of piece counts in sequence. Confirm each result using the "M+" function key, then lift off the pieces. Each time a result is transferred to the statistics, it is printed automatically.

#### Note

- If you press the "M+" function key when a weight change has not occurred, an error message appears. This prevents you from accidentally recording the same result twice.
- If the function for automatic weight transfer is active (Section 10.3.5), there is no need to press the "M+" key for recording a result, as the value is transferred to the statistics automatically.
- If an incorrect piece count is saved by mistake, it can be removed from the statistics by using the "CL Last" function key. But you can do this only for the most recently recorded result. The "CL Last" function key is active only if there are values present in the memory. Otherwise, the key is grayed out and cannot be pressed. The key is deactivated after a result is deleted and can only be used again once the next result has been transferred to the statistics.



Once all the piece counts of the series have been carried out, press the "Result" function key. (This is only available if values are present in the memory. Otherwise, the key is grayed out and cannot be pressed.) This pauses the piece count series and opens the results window (the series can be continued at any time). **Note:** If you specified the number of piece counts in the series using the "Max n" function key, the results window opens automatically after the last piece count is recorded and indicates that the maximum number of piece counts has been reached.

Piezecounting		12 Jan 2015 12:58
Max. number of samples reached.		123 +456 578
n	3	
x	15.0000 PCS	
s	1.0000 PCS	
s.rel	6.67 %	
Min	14 PCS	
Max	16 PCS	
Diff.	2 PCS	
Sum	45.0000 PCS	
		OK

The results window contains the results of the counting series (the information selected for printing the result is displayed, see Section 10.3.7). Please refer to the notes in Section 10.4.5 regarding the units, resolution and accuracy of displayed values.

If the results window takes up several display pages, you can use the arrow keys to switch back and forth between the pages. Press the «» key to print the results record.

A complete sample printout with all the statistical values can be found in Section 10.4.5.



If you have definitely completed the current piece count series and wish to clear the memory in preparation for the next series, press the "CL Result" function key (a safety prompt is displayed, which must be confirmed before the statistics are actually deleted). **Note:** If the key is grayed out, the statistics do not contain any values.

### 10.4.3 Counting to a nominal value

The "Piece Counting" application offers additional functions that simplify counting to a defined Nominal value. These functions can be used for both single piece counts and series counts when using the statistics. The following description assumes that the reference for the piece count has been determined already.

#### Presettings



The function keys shown at left must be activated so that a nominal weight and the corresponding tolerances can be entered (Section 10.3.3). To view the defined values in the display, the information fields of the same name can also be activated, if necessary (Section 10.3.4).



We also recommend activating the "Abs/Diff" function key, so that you can switch between the quantity already weighed in and the quantity that remains to be weighed until the nominal value is reached.

#### Operating sequence

**Note:** If values are already present in the statistics, the function keys for entering the nominal weight and tolerances are inactive. In this case the statistics must be deleted using the "CL Result" function key before the nominal weight and the tolerances can be defined.

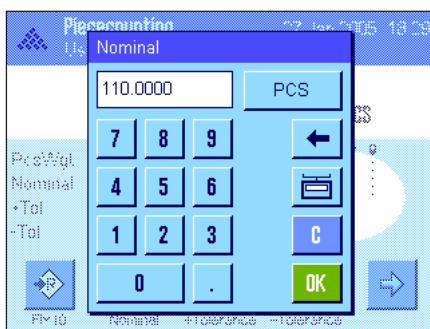

Press the "Nominal" function key. Type in the desired value. Check the weighing unit, which is shown to the right of the nominal value. When the weighing unit is touched a selection box containing the available units, including "PCS" (Pieces), appears. **Note:** The "PCS" unit is available only if a reference piece weight has been determined. The units are not converted automatically; i.e., if a value is entered in one unit, this value remains the same even if the weighing unit is changed. Once the value is entered, press "OK" to activate the nominal value.

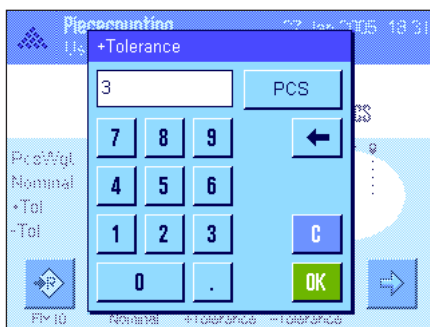

The "+Tolerance" and "-Tolerance" function keys can be used to specify the accuracy with which you wish to count. The input window is the same as for the nominal value. Both tolerance values are set to 2.5% ex works. Instead of a percentage value, you can also enter an absolute tolerance in any weighing unit (e.g., "PCS"). Once the relevant value is entered, press "OK" to activate the tolerance. Piece counts that are outside the tolerance range are specifically marked (">T" and "<T") when the single values are printed.

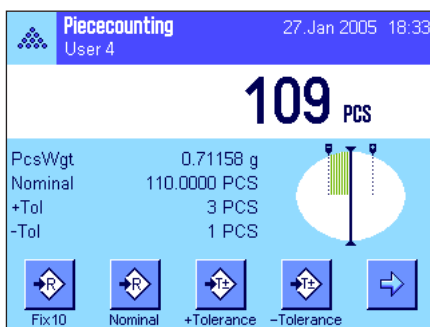

As soon as the nominal value and tolerances have been entered, a graphic weighing-in aid ("SmartTrac") appears in the display with tolerance markers that simplify weighing in to the nominal value: You can roughly weigh in your samples until the lower tolerance value is reached and then accurately dose, if necessary, up to the nominal value.

### 10.4.4 Reference optimizing

Reference optimizing improves the precision of piece counting results. The average piece weight (reference) is recalculated with each reference optimization. Because the new pieces that have been placed in the weighing pan increase the basis for the calculation, the reference, and therefore the result of the piece count, are more exact.



The "Ref.Opt" function key must be activated in order to use reference optimization (Section 10.3.3).



Determine the reference using the desired method (fixed or variable reference piece number, see Section 10.4.1). A reference piece number of 10 is used in the example opposite.

**Note:** In this figure, the "Ref.Opt" function key is inactive and cannot be pressed, because no more pieces were added after the reference was determined.



Proceed with the piece count, and place additional pieces on the weighing pan. To optimize the reference, press the "Ref.Opt" function key. The number of pieces in the pan is now used as the new reference piece number and the reference piece weight is recalculated on this basis.

After reference optimization, the "Ref.Opt" key becomes inactive again until you add more pieces to the pan. Reference optimization can be carried out any number of times, and will only improve the precision of the reference and, therefore, the counting result.

#### Note

- Reference optimization is possible only if:
  - the number of pieces placed in the weighing pan is **larger than the reference piece number**.
  - the number of pieces placed in the weighing pan (19 in this example) is **not greater than twice** the most recently saved reference piece number (10 in this example).
  - either the "fixed reference piece number" or "variable reference piece number" is used as the method of determining the reference. Reference optimization is not possible when a known reference piece weight ("PcsWgt" function key) is entered.
- Reference optimization is possible with a **piece counting series** only before the result of the first count is saved using the "M+" function key. The "Ref.Opt" key is then grayed out and cannot be pressed, since the change in the basis of calculation (reference piece weight) is not reliable in the middle of a running series.

### 10.4.5 Sample printout of a piece count with statistical values

```

---- Piececounting ----
27.Jan 2005      19:47
User Name      User 4
Balance Type   XP504
WeighBridge SNR:
                1234567890
Terminal SNR: 1234567890
Nominal      110.0000 PCS
+Tol         3 PCS
-Tol         1 PCS
Max n        3
  1          110 PCS
NetPcs       110 PCS
RefPcs       10 PCS
PcsWgt       2.31406 g
  2          109 PCS
NetPcs       109 PCS
RefPcs       10 PCS
PcsWgt       2.31406 g
  3>T        114 PCS
NetPcs       114 PCS
RefPcs       10 PCS
PcsWgt       2.31406 g
n            3
x            111.00000 PCS
s            2.60000 PCS
s.rel        2.34 %
Min          109 PCS
Max          114 PCS
Diff         5 PCS
Sum          333.0000 PCS
SumPcs       333 PCS
>T+         1
<T-         0

Signature
.....

```

The figure opposite shows the sample printout of a piece count with statistical values. The values printed in the header, as single values and as the result depend on your individual print settings (Section 10.3.7).

Only specific **information for the piece count** and the related statistical values are explained in the sample printout opposite. Notes on additional printout information can be found in Section 7.2.8.

"Nominal":	Defined nominal value (in this example, as a piece count).
" +Tol":	Defined plus tolerance (in this example, as a piece count).
" -Tol":	Defined minus tolerance (in this example, as a piece count).
"Max n":	Defined number of piece counts in the series.
"1" ... "3":	Consecutive numbers and net values of the individual piece counts in the series. Note: The results are displayed in the current display unit, which does not necessarily have to be "PCS".
"NetPcs":	Recorded net piece count for the relevant piece count.
"RefPcs":	Number of reference pieces for the relevant piece count.
"PcsWgt":	Reference piece weight for the relevant piece count.
"n":	Number of recorded piece counts.
"x":	Average piece count of all recorded counts.
"s":	Standard deviation within the series.
"s.rel":	Relative standard deviation within the series (as a percentage). The value is always printed to 2 decimal places.
"Min":	Smallest recorded value in the current measurement series.
"Max":	Largest recorded value in the current measurement series.
"Diff":	Difference between the largest and smallest weight value in the current measurement series.
"Sum":	Total result of all saved single measurements.
"SumPcs":	Total piece count (total result of all saved single counts in a series).
">T+", "<T-":	Number of piece counts in the series that are outside the relevant tolerance limits (in this example, the result of the third piece count exceeded the upper tolerance limit).

**Note:** The values for "x", "s", "Min", "Max", "Diff" and "Sum" are shown in the current display area. It does not have to be strictly "PCS" (pieces).

#### Important information for interpreting printed results

The values "x" and "s" are calculated results, which are displayed at a higher resolution than the single measured values. For smaller measurement series (< approx. 10 measured values) and measurement series with small deviations, the significance of the last decimal place cannot be guaranteed. Notes on the formulae used for calculating these values can be found in Section 8.4.4.

## 11 The "Percent Weighing" application

In this Section you will be introduced to the "Percent Weighing" application. You will find practical information about working with this application and about the different settings. **Please note that all settings for the "Percent Weighing" application are saved under the active user profile, so each user can make their own settings for this application. Because of this, first make sure that you have selected the desired user profile.**

### 11.1 Introduction to the "Percent Weighing" application

The "Percent Weighing" application enables you to weigh to a specified value (100%) and detect deviations from this target value. Many of the application-dependent settings are identical to those of the "Weighing" application. However, additional settings are available to you for percent weighing. In the description that follows, only those settings are explained in detail which are different from the "Weighing" application.

**Note:** If you use the "Percent Weighing" application in conjunction with the LC-I/O relay interface, please note the information provided in the "Solution Guide", which is available on the Internet ([www.mt.com/xp-analytical](http://www.mt.com/xp-analytical)).

### 11.2 Selecting the Application

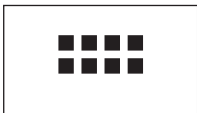

If "Percent Weighing" is not already active, first press the  key. In the selection window, touch the symbol for the application.

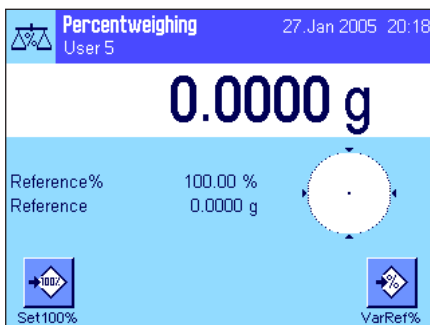

After you have selected the application, the display shown at left appears. Some of the special function keys and the special information fields for percent weighing are activated at the factory. How you can adapt these and other settings to your needs is described in the Sections that follow.

### 11.3 Settings for the "Percent Weighing" application

For percent weighing you have various specific settings available which you can use to adapt the application to your needs.

#### 11.3.1 Overview



The application-dependent settings can be accessed with the  key. When this key is pressed, the first of 4 menu pages appears.

With only a few exceptions, the settings available in the "Percent Weighing" application are identical to those of the "Weighing" application (Section 7.2). Only the settings that are different are described below. These settings are contained in the following menus:

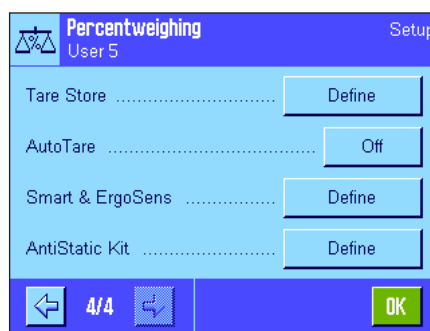
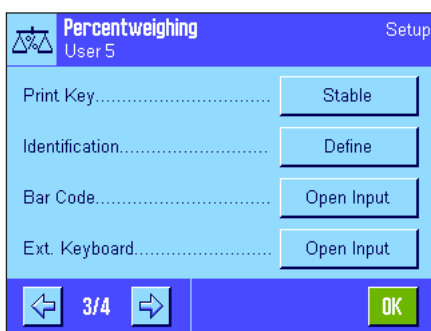
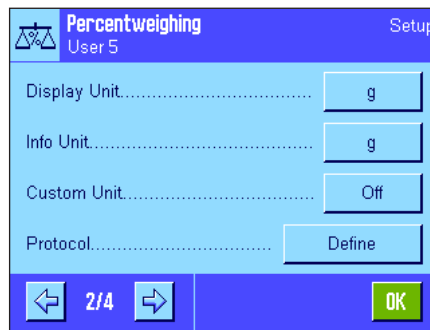
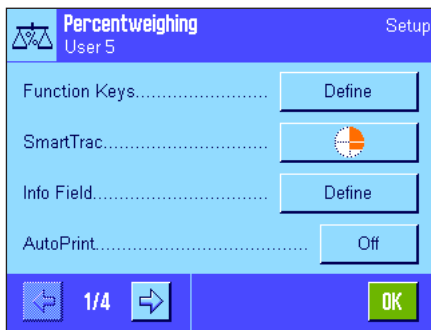

**"Function Keys":**

Additional function keys are available for percent weighing.

**"Info Fields":**

Additional information fields are available for percent weighing.

**"Display Unit" and "Info Unit":**

An additional unit "%" (percent) is available for percent weighing.

**"Reports":**

Additional information is available for percent weighing reports.

**"Smart & ErgoSens":**

Special percent weighing functions can be assigned to the sensors.

Please note that in contrast to the "Weighing" application, only **one** free unit can be defined. Also, the "Minimum Weight" function is not available.

In the following Sections you will be given a detailed introduction to the specific settings for the "Percent Weighing" application.

**11.3.2 Special Function Keys for Percent Weighing**

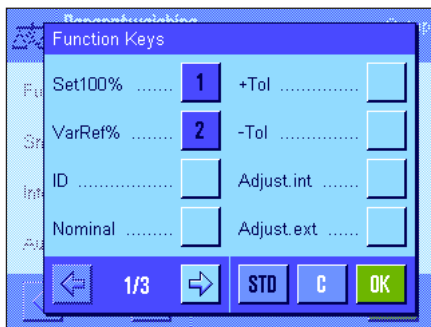

The first page of the function key menu presents you with the following options for percent weighing:

**"Set100%":** You can use this function key to define the current weight value as the reference (100%) (Section 11.4.1).

**"VarRef%":** You can use this function key to assign the weight value to a variable reference (Section 11.4.1).

**"Nominal":** Specifies the desired target weight (Section 11.4.2). This is also used as reference for the tolerances (described below).

**"+Tol" and "-Tol":** Specifies the accuracy (tolerances) for the percent weighing (Section 11.4.2).

All other function keys are the same as for the "Weighing" application (Section 7.2.2).

**Factory setting:** "Set100%" and "VarRef%" are activated (in this order).

### 11.3.3 Special Information Fields for Percent Weighing

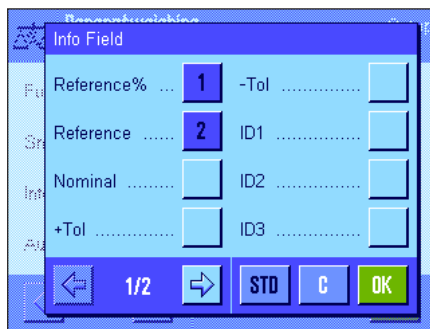

On the first page of the menu for info fields the following settings for percent weighing are available:

**"Reference%":** Reference value percent.

**"Reference":** Absolute weight value of the reference.

**"Nominal":** Displays the target value which was input with the respective function key.

**" +Tol" and "-Tol":** These information fields display the tolerances which were input with the respective function keys.

All other information fields are the same as for the "Weighing" application (Section 7.2.4).

**Factory setting:** "Reference%" and "Reference" activated (in this order).

### 11.3.4 Additional Unit for Percent Weighing

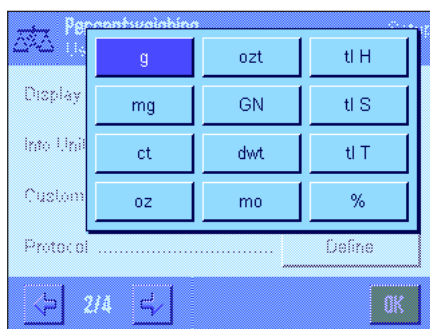

In the menu for the "Display Unit" and the "Info Unit", in addition to the known weighing units the unit "%" (percent) is available (provided that a reference has already been determined).

**Note:** For percent weighing you do not need to explicitly select the "%" unit, since the display unit is always switched over to "%" automatically when the reference is determined. Afterwards, you can select the desired unit again whenever you want to.

**Factory setting:** "g" (gram) for "display unit" and for "info unit".

### 11.3.5 Special Information for Percent Weighing

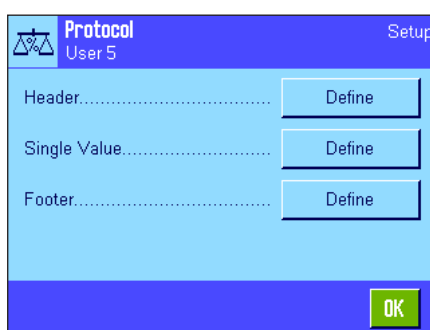

In the three submenus where you can specify the options for the header line of the report, for reporting the individual values, and for the footer line, you also have additional settings available for percent weighing which are described below.

**Note:** All other information items in the report are the same as in the "Weighing" application (Section 7.2.8) and are not described here.



**Report Header Line**

On the second page of this submenu there are additional settings for percent weighing:

- "Ref%, Ref.": Reports the reference in percent and as a weight value.
- "Nom., +Tol, -Tol": Reports the specified target value and the selected tolerances.

**Factory setting:** "Appl. Name" ("Percent Weighing" is printed out) and "Date/Time" (in this order); no specific information items for percent weighing are activated.

The header line is printed automatically if it is defined to be part of the weighing report (see "Reporting Individual Values" on the next page). However, the header can also be printed out separately by pressing the "Header line" function key.

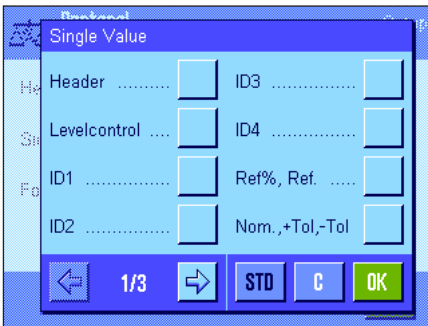

**Reporting Individual Values**

On the first and second pages of this submenu, the following special settings for percent weighing are available:

- "Ref%, Ref.": Reports the reference in percent and as a weight value.
- "Nom., +Tol, -Tol": Reports the specified target value and selected tolerances.
- "Diff. ": Reports the deviation from the target value as a weight value.
- "Diff. %": Reports the deviation from the target value in percent.

**Factory setting:** "Net"; no specific information items for percent weighing are activated.

The individual values are printed out by pressing the  $\leftarrow$  key or, if the automatic print function is activated, automatically (see Section 7.2.5).

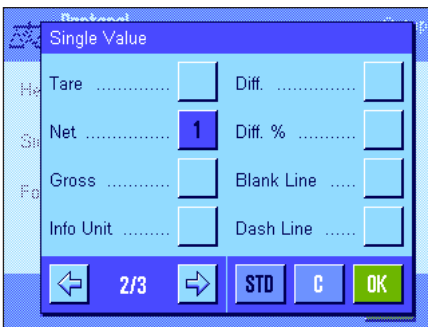

**Report Footer Line**

On the second page of this submenu you can specify which additional items of information for percent weighing should be printed out in the footer line of the weighing report after the results (individual values):

- "Ref%, Ref.": Reports the reference in percent and as a weight value.
- "Nom., +Tol, -Tol": Reports the specified target value and selected tolerances.

**Factory setting:** "Signature" and "3 Blank Lines" (in this order); no specific information items for percent weighing are activated.

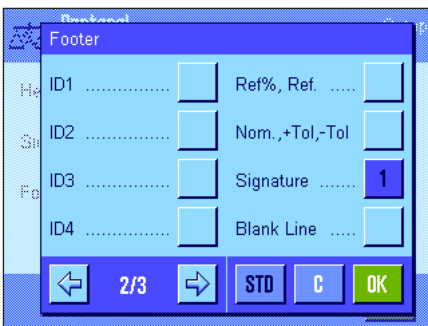

To print the footer line, press the "Footer Line" function key.

You will find **an example of a percent weighing** in Section 11.4.3.



### 11.3.6 Special Settings of SmartSens and ErgoSens for Percent Weighing

The SmartSens and ErgoSens sensors have special settings for percent weighing.

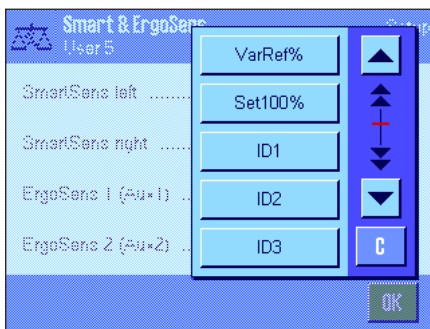

"VarRef%" and "Set100%" emulate the function keys with the same names.

If one of these settings is activated, the "F" (function) symbol lights up green in the status line under the respective sensor.

**Factory setting:** SmartSens left and right configured for door operation.  
"Off" for both ErgoSens.

## 11.4 Working with the "Percent Weighing" Application

In this Section you will learn how to work with the "Percent Weighing" application. This application also allows you to determine a tare, change the resolution of the weighing result, work with identifications, etc. Since you have already learnt how to do these in the "Weighing" application (Section 7.3) they are not explained again here.

### 11.4.1 Simple Percent Weighing



#### Preliminary Settings

Before you can perform a percent weighing, you must first activate at least one of the two function keys shown at left (Section 11.3.2) so that you can determine the reference. The information fields "Reference%" (reference value in percent) and "Reference" (absolute weight value of the reference) are both activated at the factory (Section 11.3.3).

#### Determining the Reference

Place the reference weight on the weighing pan.

**If the reference weight placed on the pan should equal 100%**, press the function key for "Set100%".

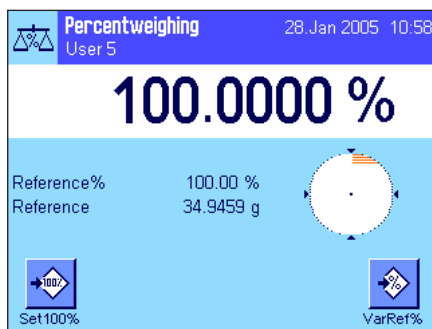

As soon as the weighing result is stable, the weight which is determined is saved as the reference weight.

The results display and the "Reference%" information field display the reference value (100%), while the "Reference" information field displays the absolute weight of the reference.



If, instead, you want to make the weight on the pan a **variable reference**, press the function key for "VarRef%". An input field appears in which you can specify the percentage value (e.g. 60%) which the weight on the pan should represent.

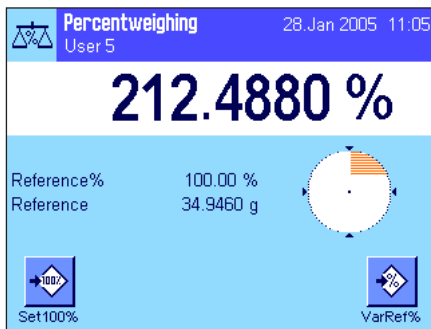

### Performing the Percent Weighing

After you have determined the reference, place the weighing sample on the pan. The weight of the weighing sample as a percentage of the reference weight appears in the results display.

**Note:** If instead of the percentage weight you want to know the absolute weight of the weighing sample, touch the "%" unit and select the desired weighing unit.

You can print out the result of the percent weighing with the «» key. You will find an example of a report in Section 11.4.3.

### 11.4.2 Percent Weighing to a Target Value

The "Percent Weighing" application provides you with additional functions to make weighing to a specified target value easier. In the description which follows, it is assumed that the reference for the percent weighing has already been determined.



#### Requirements

Before you can input a target value and the associated tolerances, the function keys shown at left must be activated (Section 11.3.2). If you want the specified values to be shown in the display, you can also activate the information fields with the same name (Section 11.3.3).

#### Performing a Percent Weighing to a Target Value



Press the function key "Nominal". Type in the desired target value (e.g. 167%). Check the weighing unit which is displayed to the right of the target value. Touching the weighing unit displays the available units, which include "%" (the "Percent" unit only becomes available after the reference has been determined).

**Note:** The units are not converted automatically, so once you have input a value in a particular unit, the value does not change even if you change the unit. When you have input the value, press "OK" to activate the target value.



You can use the two function keys "+Tol" and "-Tol" to specify the accuracy with which you want to weigh. The input window is similar to the one for the target value. Both tolerance values are set to 2.5% at the factory. Instead of a percentage value, you can also enter a unit of your choice (e.g. "g"). When you have entered the respective value, press "OK" to activate the tolerance. Percentage weighings which lie outside the tolerances are specially marked in the report of individual values with ">T" or "<T".

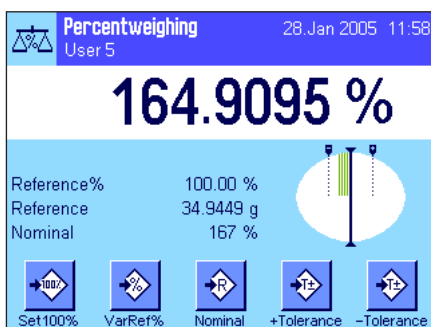

When you have input the target value and the tolerances, tolerance marks for the graphical weighing aid ("SmartTrac") appear in the display. The tolerance marks make weighing to the target value easier for you. You can weigh your weighing sample roughly until the lower tolerance value is reached, and then if necessary dispense finely until the target value is reached.

### 11.4.3 Example of a percent weighing report

```

---- Percentweighing ---
28.Jan 2005          12:16
User Name           User 5
Reference%          100.00 %
Reference           34.9449 g
Nominal             167 %
+Tol                2.50 %
-Tol                2.50 %
                   166.8665 %
Diff. %             -0.08 %

Signature

.....

```

Shown at left is an example of a report for a percent weighing with target value and tolerances. The values which are reported in the header line, as individual values, and in the footer line depend on your individual report settings (Section 11.3.5).

Only those **information items shown in the report which specifically relate to percent weighing** are explained below. You will find explanations of the other items in Section 7.2.8).

<b>"Reference%":</b>	Reference value in percent.
<b>"Reference":</b>	Absolute weight value of the reference.
<b>"Nominal":</b>	Specified target value (in this example, in the unit '%').
<b>" +Tol":</b>	Specified plus tolerance (in this example, in the unit '%').
<b>" -Tol":</b>	Specified minus tolerance (in this example, in the unit '%').
<b>"166.8665":</b>	Result of the weighing as % of the reference.
<b>"Diff.%":</b>	Percentage deviation of the result from the target value.

## 12 The "Density" application

In this Section you will be introduced to the "Density" application. You will find practical information about working with this application and about the different settings. **Please note that all settings for the "Density" application are saved under the active user profile, so each user can make their own settings for this application. Because of this, first make sure that you have selected the desired user profile.**

### 12.1 Introduction to the "Density" application

The "Density" application enables you to determine the density of solid bodies, liquids, and pasty substances. Every sample can be given an identification, and the built-in statistics functions allow statistical evaluation of measurement series. Determination of the density uses **Archimedes' principle** according to which a body immersed in a fluid undergoes an apparent loss in weight which is equal to the weight of the fluid it displaces.

To perform density determinations you can use the hanger for weighing below the balance which belongs to your balance (Section 2.8). However, to determine the density of solid bodies, we recommend you to work with the optional density kit which contains all the attachments and aids needed for convenient and precise density determination. The density kit is supplied with separate instructions which explain how to install and use it.

To determine the density of liquids, you additionally need a **sinker** which you can also obtain from your METTLER TOLEDO dealer. Alternatively, the "Density" application also supports the use of a **pycnometer** for determining the density of liquids. Pycnometers can be obtained from companies specializing in laboratory equipment. To determine the density of pasty substances a **gamma sphere** is required; your dealer will be pleased to tell you where this can be obtained.

Please take note of the instructions which are supplied with these accessories; they contain useful information about working with the aids as well as for their handling and care.

### 12.2 Selecting the Application

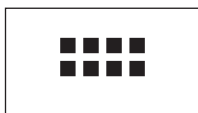

If the "Density" application is not already active, press the «» key. In the selection window, touch the symbol of the application.

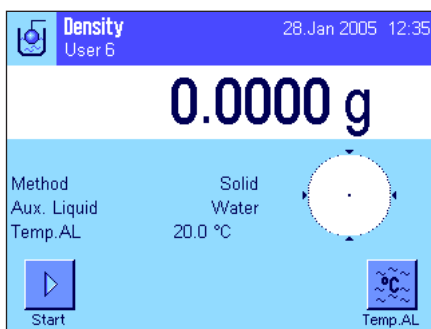

When you have selected the application, the display shown at left appears. Special function keys and information fields for density determination are activated at the factory. The balance is preset to use water as the auxiliary liquid for density determination. However, you can change these settings according to your needs as described in the Sections that now follow.

## 12.3 Settings for the "Density" application

For the determination of density, various specific settings are available which you can use to adapt the application to your requirements.

### 12.3.1 Overview



The application-dependent settings can be accessed with the «» key.

Some of the settings for the "Density" application are identical to those for the "Weighing" application (Section 7.2). Only the settings which are different are described below. These settings are contained in the following menus:

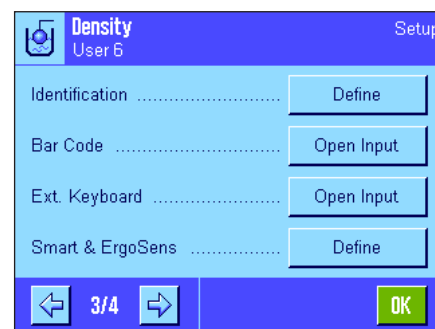
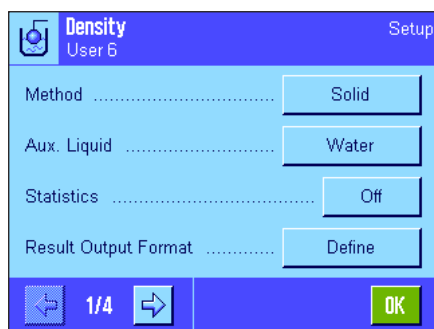

**"Method":**

In this menu you can select the type of density determination.

**"Aux. Liquid":**

In this menu you can specify the auxiliary liquid you want to use.

**"Statistics":**

In this menu you can activate or deactivate the statistics for the selected method.

**"Results Output Format":**

In this menu you can specify how the result of the density determination should be calculated and displayed.

**"Function Keys":**

Several special function keys for density determination are available.

**"Info Field":**

Additional information fields for density determination are available.

**"Protocol":**

Additional information about density determination is available for reports.

**"Smart & ErgoSens":**

The sensors can be given special functions for density determination.

In the following Sections you will be given a detailed introduction to the specific settings for the "Density" application.

### 12.3.2 Selecting the method for density determination

In this menu you can specify the type of density determination you want to perform:

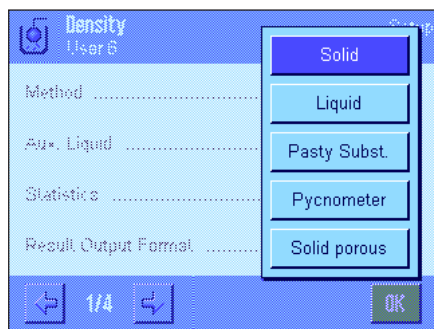

**"Solid":**

Density determination of non-porous solid bodies using an auxiliary liquid.

**"Liquid":**

Density determination of liquids using a sinker.

**"Pasty Subst.":**

Density determination of pasty substances using a gamma sphere.

**"Pycnometer":**

For determining the density of liquids using a pycnometer.

**"Solid porous":**

For determining the density of porous solid bodies by using a supplementary oil bath.

**Factory setting:**

The "Solid" method is activated.

### 12.3.3 Selecting the auxiliary liquid

In this menu you can specify the auxiliary liquid you want to work with. **This setting only applies to the density determination of solid bodies!** The following auxiliary liquids are available:

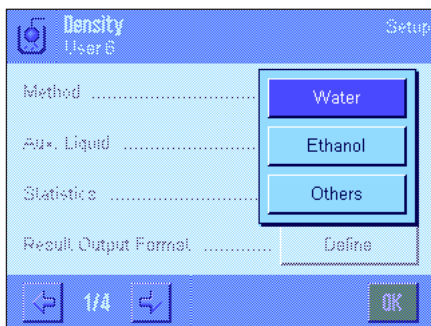

**"Water":** The density of distilled water at temperatures from 10.0°C to 30.0°C is stored in the balance.

**"Ethanol":** The density of ethanol at temperatures from 10.0°C to 30.0°C is also stored in the balance.

**"Others":** Any other auxiliary liquid whose density at the current temperature must be known.

**Factory setting:** "Water" as auxiliary liquid is activated.

### 12.3.4 Activating and deactivating statistics

The balance can keep its own statistics for each method of density determination. With statistics activated, you are asked at the end of each density determination whether you want to include the result in the statistics. You can activate or deactivate the statistics function in this menu:

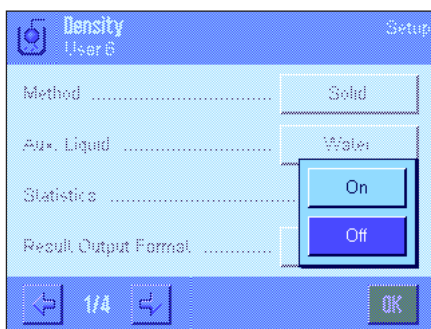

**"On":** Statistics function activated.

**"Off":** Statistics function deactivated.

**Factory setting:** Statistics function deactivated ("Off").

**Note:** To use the statistics function you must also activate the two associated function keys (Section 12.3.6). You will find information about working with the statistics in Section 12.5.

### 12.3.5 Settings for calculating and displaying the result

In this menu you can specify the number of decimal places and the unit with which the result of the density determination should be calculated, as well as whether the air buoyancy should be included in the calculation.

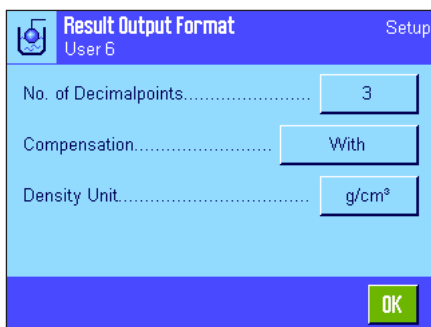

**"No. of Dec. Points":** The result of the density determination can be displayed and reported with from 1 to 5 decimal places.

**"Compensation":** The result of the density determination can be corrected by the correction factor for the force calibration and by the mean density of air (setting "With"). If set to "Without", no correction is made. With the setting "With/Without" both the corrected and the uncorrected result are displayed and reported.

**"Density Unit":** Here you can define the unit which should be used for the density determination: "g/cm<sup>3</sup>", "kg/m<sup>3</sup>", or "g/l" (grams per liter).

**Factory setting:**

Number of decimal places:	"3"
Compensation:	"With" (correction)
Unit of density:	"g/cm <sup>3</sup> "

### 12.3.6 Special function keys for density determination

In the menu for function keys you can activate the following special function keys for density determination:

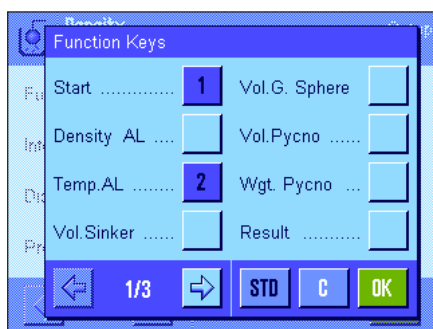

"**Start**":

This is the **function key** you use to start the density determination, so it **must always be activated!**

"**Density AL**":

Specifies the **density of the auxiliary liquid**. Only required for density determination of solid bodies and when an auxiliary liquid other than water or ethanol is used.

"**Temp.AL**":

Used to enter the **temperature of the auxiliary liquid**. Only required if distilled water or ethanol is used, since for other liquids the density at the current temperature must always be entered. For methods which do not use an auxiliary liquid, the key can be used to enter the current ambient temperature so that this temperature is printed on the reports.

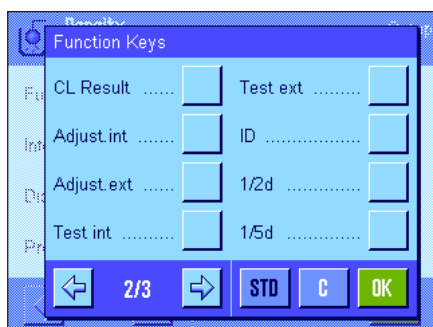

"**Vol. Sinker**":

Used to enter the **volume of the sinker** (in  $\text{cm}^3$ , max. 5 decimal places). Only required for the density determination of liquids with the aid of a sinker.

"**Vol. G. Sphere**":

Used to enter the **volume of the gamma sphere** (in  $\text{cm}^3$ , max. 5 decimal places). Only required for the density determination of pasty substances with the aid of a gamma sphere.

"**Vol. Pycno**":

For entering the **volume of the pycnometer** (in  $\text{cm}^3$ , max. 5 decimal places). Only necessary for determining the density of liquids using a pycnometer.

"**Wgt. Pycno**":

For entering the **weight of the pycnometer**. Only necessary for determining the density of liquids using a pycnometer.

"**Result**":

Displays the statistics for the current method of density determination. **Note:** You only need to activate this function key if you have also activated the statistics function (Section 12.3.4). If there are no results in the statistics, the key cannot be operated.

"**CL Result**":

Clears (deletes) the statistical data for the current density determination to start a new measurement series.

**Factory setting:**

"Start" and "Temp.AL" activated (in this order).

### 12.3.7 Special information fields for density determination

On the first page of the menu of info fields there are additional settings for density determination:

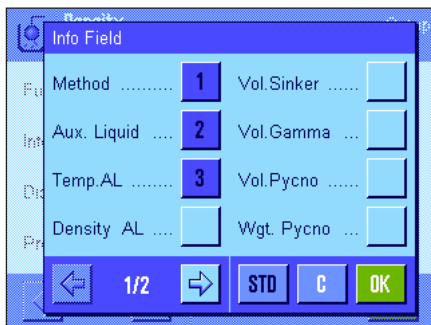

- "Method":** Selected type of density determination.
- "Aux. Liquid":** Selected auxiliary liquid (density determination of solid bodies).
- "Temp. AL":** Shows the temperature of the auxiliary liquid (distilled water, ethanol) which was input using the function key with the same name.
- "Density AL":** Density of the auxiliary liquid. For water and ethanol, the density which is automatically read from the built-in density table is displayed; for other auxiliary liquids the density value which was input using the function key with the same name is displayed.
- "Vol. Sinker":** Volume of the sinker (for density determination of liquids using a sinker).
- "Vol. Gamma":** Volume of the gamma sphere (for density determination of pasty substances with the aid of a gamma sphere).
- "Vol. Pycno":** Volume of the pycnometer (determining the density of liquids using a pycnometer).
- "Wgt. Pycno":** Weight of the pycnometer (determining the density of liquids using a pycnometer).
- Factory setting:** "Method", "Aux. Liquid", and "Temp. AL" activated (in this order).

### 12.3.8 Special report information for density determination

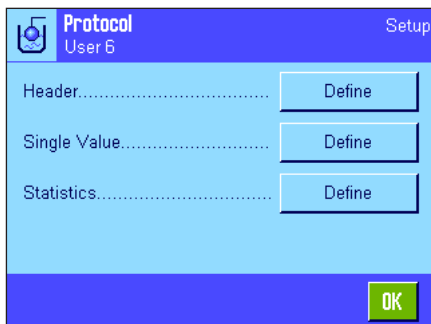

In the three submenus where you can specify the options for the header line of reports, the options for reports of individual values, and the options for statistical reports, there are additional settings available which are described below.

**Note:** All other items of information on the reports are the same as for the "Weighing" application (Section 7.2.8) and are not listed here.

#### Report header line

On the second and third pages of this submenu there are further settings for density determination:

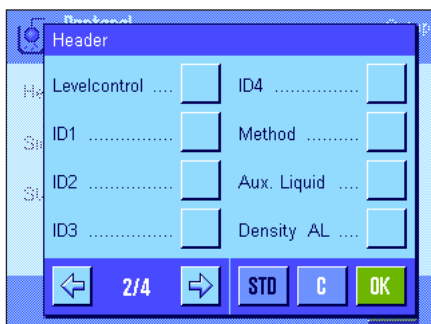

- "Method":** Reports the selected density determination method.
- "Aux. Liquid":** Reports the selected auxiliary liquid (for density determination of solid bodies).
- "Density AL":** Reports the density of the auxiliary liquid which was input using the function key with the same name. If water or ethanol is being used, the value taken from the built-in table is reported.
- "Temp. AL":** Reports the temperature of the auxiliary liquid which was input using the function key with the same name (for water and ethanol).



**"Vol. Sinker":**

Reports the volume of the sinker which was input using the function key with the same name (for density determination of liquids with the aid of a sinker).

**"Vol. Gamma":**

Reports the volume of the gamma sphere which was input using the function key with the same name (for density determination of pasty substances with the aid of a gamma sphere).

**"Vol. Pycno":**

Prints the pycnometer volume that was entered via the function key of the same name (determining the density of liquids using a pycnometer).

**"Wgt. Pycno":**

Prints the pycnometer weight that was entered via the function key of the same name (determining the density of liquids using a pycnometer).

**Factory setting:**

"Appl. Name"; no specific information items for density determination are activated.

If a report for an individual value is printed, the header line is automatically printed out with it (as described below).

### Reporting individual values

This submenu contains additional settings for density determination.

**"Method":**

Reports the selected density determination method.

**"Aux. Liquid":**

Reports the selected auxiliary liquid (density determination of solid bodies).

**"Density AL":**

Reports the density of the auxiliary liquid which was input using the function key with the same name. If water or ethanol is being used, the value taken from the built-in table is reported.

**"Temp. AL":**

Reports the temperature of the auxiliary liquid which was input using the function key with the same name (for water and ethanol).

**"Vol. Sinker":**

Reports the volume of the sinker which was input using the function key with the same name (for density determination of liquids with the aid of a sinker).

**"Vol. Gamma":**

Reports the volume of the gamma sphere which was input using the function key with the same name (for density determination of pasty substances with the aid of a gamma sphere).

**"Vol. Pycno":**

Prints the pycnometer volume that was entered via the function key of the same name (determining the density of liquids using a pycnometer).

**"Wgt. Pycno":**

Prints the pycnometer net weight that was entered via the function key of the same name (determining the density of liquids using a pycnometer).

**"Wgt. in Air:**

Reports the weight of the sample in air (density of solid bodies).

**"Wgt. in Liquid":**

Reports the weight of the sample in the auxiliary liquid (for density determination of solid bodies) or the weight of the sample substance displaced by the sinker or gamma sphere.

**"Wgt. of content":**

Prints the weight of the sample in the pycnometer (determining the density of liquids using a pycnometer).

- "Vol. Probe":** Reports the volume of the sample (which is calculated by the software).
- "Density":** Reports the result of the current density determination.
- Factory setting:** "Density" and "3 Blank Lines".

The report of individual values (report of an individual density determination) can be printed out with the «» key. You will find an example of a report in Section 12.4.4.

**Reporting statistical data**

On the second and third pages of this submenu you can specify the statistical information of density determinations that you want to be reported. These settings are only relevant if you have activated the statistics function (Section 12.3.4).

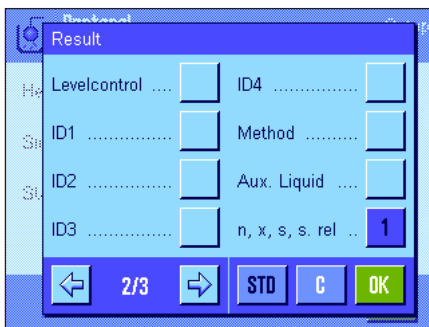

- "Method":** Selected density determination method.
- "Aux. Liquid":** Selected auxiliary liquid (for density determination of solid bodies).
- "n, x, s, s. rel.":** Number of samples in the current measurement series ("n"), average (mean) density value of all samples ("x"), and absolute/relative standard deviation of the current measurement series ("s"/"s. rel").

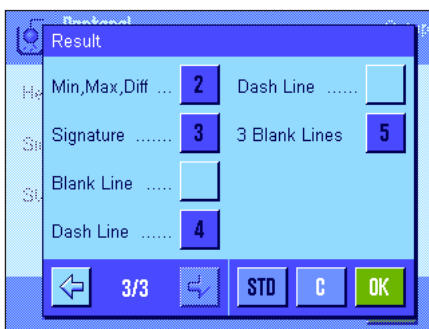

- "Min, Max, Diff":** Lowest and highest density values determined in the current measurement series and the difference between these two values.
- Factory setting:** "n, x, s, s. rel" and "Min, Max, Diff". The settings "Signature", "Dash Line" and "3 Blank Lines" are also activated.

The statistics report can be printed out by opening the statistics window and then pressing the «» key. You will find an example of a report and an explanation of the statistics in Section 12.5.

**12.3.9 Special SmartSens and ErgoSens settings for density determination**

There are additional settings for the SmartSens and ErgoSens sensors for density determination.

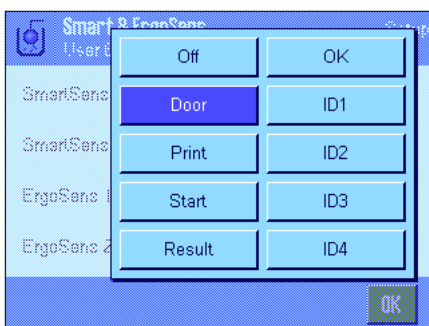

- "Start" and "Result"** emulate the function keys with the same names. **"OK"** emulates pressing the key with the same name in the density determination dialogs (but not in the menus) to confirm inputs and actions.
- If one of these settings is activated, the green **"F"** (function) symbol under the respective sensor in the status bar lights up.

- Factory setting:** SmartSens left and right configured for door operation. "Off" for both ErgoSens.

## 12.4 Working with the "Density" application

In this Section you will learn more about how to work with the "Density" application and the various methods of density determination. It is assumed that the "Density" application has already been selected. The following explanations assume that the statistics function has been de-activated. (You will find instructions how to use the statistics in Section 12.5).

### 12.4.1 Density determination of non-porous solid bodies

For the density determination of non-porous solid bodies, the solid body is first weighed in air and then in the auxiliary liquid. The difference in weight gives the buoyancy from which the software calculates the density.

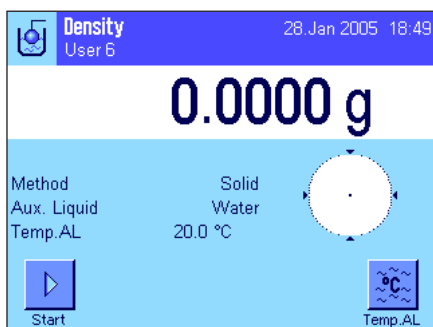

In the application-specific settings, select the method for "Solid" (Section 12.3.2) and specify the desired auxiliary liquid (Section 12.3.3).

**Activate the appropriate function keys and information fields** (Sections 12.3.6 and 12.3.7).

**Note:** The example at left shows settings for the density determination of solid bodies when using distilled water as the auxiliary liquid. If you use a different liquid than water or ethanol, instead of the "Temp. AL" function key you must activate the "Density AL" key and the information field with the same name.



If you use **water or ethanol as the auxiliary liquid**, enter its **temperature** with the "Temp. AL" function key. (Density tables for these two liquids in the temperature range 10 °C to 30 °C are stored in the balance, see also Sections 12.7 and 12.8). The screenshot at left shows the corresponding input field (input in °C with one decimal place).

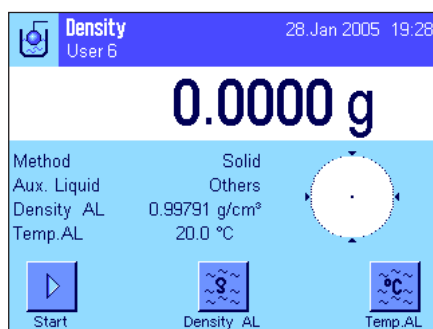

If you use **a different auxiliary liquid** than water or ethanol, activate the "Density AL" function key and use this key to enter the **density of the auxiliary liquid you are using at the current temperature** (in g/cm<sup>3</sup>, max. 5 decimal places). You have to do this because the balance only stores density tables for water and ethanol. The value you enter appears in the information field with the same name, which you must also activate. **Note:** If you are using a different auxiliary liquid than water or ethanol, the "Temp. AL" function key which is shown activated in the example at left, as well as the information field with the same name, is not required. If you wish, however, you can use this function key to enter the current ambient temperature so it is printed on the report as a record of the temperature at which the density was determined.

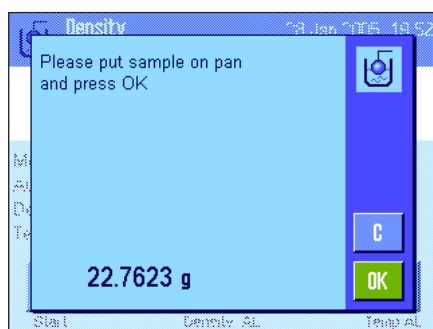

Press the "Start" function key to start the density determination. The balance executes an automatic tare and you will then be prompted to place the solid body on the balance to weigh it in air.

If you are working with the optional density kit, follow the instructions supplied with the kit. If you are working with the below-the-balance hanger, hang the solid body on the hanger. The weight of the solid body on the balance is displayed in the bottom left corner of the window.

Press "OK" to accept the weight value.

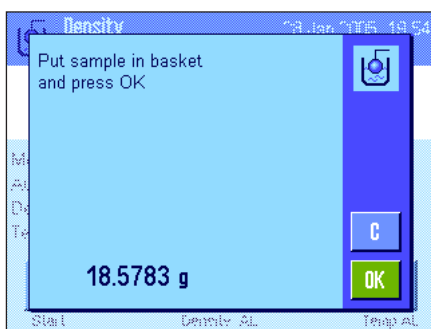

The weighing result is saved and you are then prompted to immerse the solid body in the auxiliary liquid.

If you are working with the optional density kit, follow the instructions supplied with the kit. If you are working with the below-the-balance hanger, place the container with the auxiliary liquid under the hanger. In either case, make sure that the solid body is immersed by at least 1 cm in the liquid and that there are no air bubbles in the container.

The weight of the solid body in the liquid is displayed in the bottom left corner of the window.

Press "**OK**" to accept the weight value.

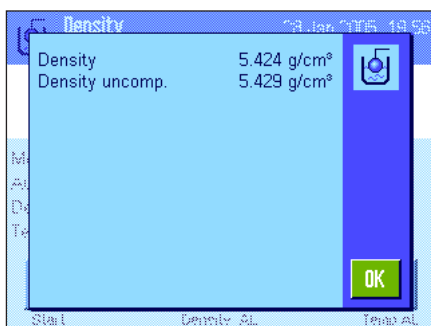

The balance now determines the density of the solid body and displays the result. Either the compensated result, the uncompensated result, or both is/are displayed depending on the settings you made for the result display (see Section 12.3.5).

If a printer is connected, you can press the «» key to print out a report of the density determination result according to your specifications (Section 12.3.8). The result is saved until the next density determination using the same method has been completed, so it can be printed out again if required. You will find an example of a report along with corresponding explanations in Section 12.4.6.

## 12.4.2 Density determination of liquids using a sinker

To determine the density of liquids, use is often made of a sinker whose volume is known. The sinker is first tared in air and then weighed in the liquid whose density must be determined. The difference between these weight values gives the buoyancy, which is used by the software to calculate the density.

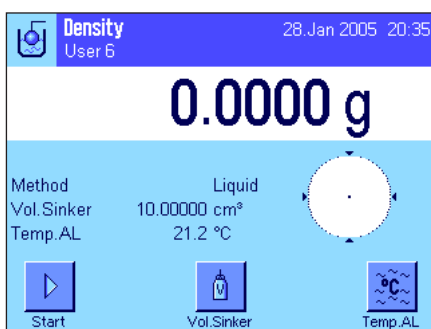

In the application-specific settings for the method, select "**Liquid**" (Section 12.3.2).

Activate the appropriate **function keys and information fields** (Sections 12.3.6 and 12.3.7). The example at left shows settings for the density determination of liquids using a sinker. **Note:** The "**Temp.AL**" function key which is shown activated in the example at left, as well as the information field with the same name, is not required for this method of density determination. If you wish, however, you can use this function key to enter the current ambient temperature so it is printed on the report as a record of the temperature at which the density was determined.

Press the "**Vol. Sinker**" function key and enter the volume of the sinker (in this example 10.00000 cm<sup>3</sup>).

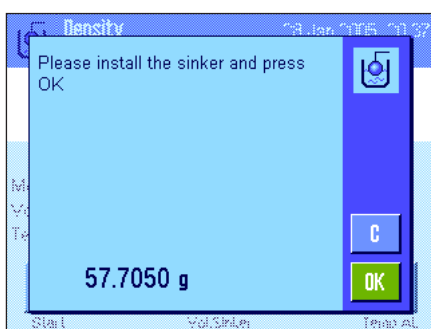

Press the "**Start**" function key to start the density determination. You are then prompted to install the sinker (weighing in air for taring).

If you are working with the optional density kit, follow the instructions supplied with the kit. If you are working with the below-the-balance hanger, hang the sinker on the hanger.

Press "**OK**" to tare the sinker.

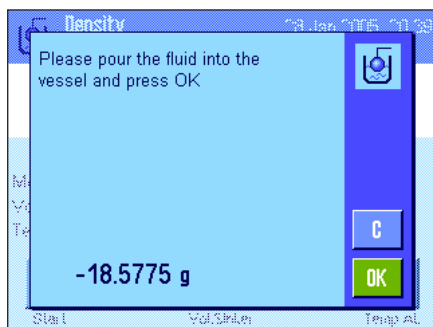

After you have tared the sinker you are prompted to pour the liquid whose density you want to determine into a container. If you are working with the optional density kit, follow the instructions supplied with the kit. If you are working with the below-the-balance hanger, place the container with the liquid under the hanger.

In either case, make sure that the sinker is immersed by at least 1 cm in the liquid, and that there are no air bubbles in the container.

The buoyancy which the sinker experiences is displayed with a minus sign in the bottom left corner of the window.

Press "**OK**" to accept the weight value.

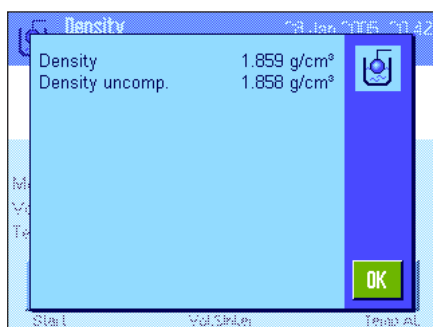

The balance now determines the density of the liquid and displays the result. Either the compensated result, the uncompensated result, or both is/are displayed depending on the settings you made for the result display (see Section 12.3.5).

If a printer is connected, you can press the  key to print out a report of the density determination result according to your specifications (Section 12.3.8). The result is saved until the next density determination using the same method has been completed, so it can be printed out again if required.

### 12.4.3 Density determination of pasty substances using a gamma sphere

To determine the density of pasty substances, use is often made of a gamma sphere whose volume is known. The pasty substance is first tared without the gamma sphere and then with it.

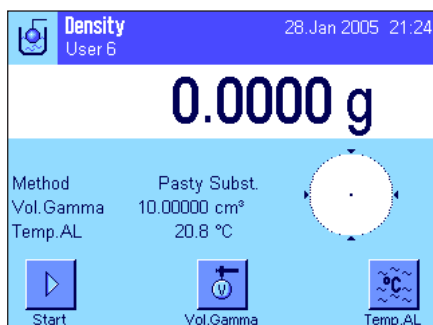

In the application-specific settings for the method, select "**Pasty Subst.**" (Section 12.3.2).

Activate the appropriate **function keys and information fields** (Sections 12.3.6 and 12.3.7). The example at left shows settings for the density determination of pasty substances using a gamma sphere. **Note:** The "**Temp. AL**" function key which is shown activated in the example at left, as well as the information field with the same name, is not required for this method of density determination. If you wish, however, you can use this function key to enter the current ambient temperature so it is printed on the report as a record of the temperature at which the density was determined.

Press the "**Vol. Gamma**" function key and enter the volume of the gamma sphere (in this example 10.00000 cm<sup>3</sup>).

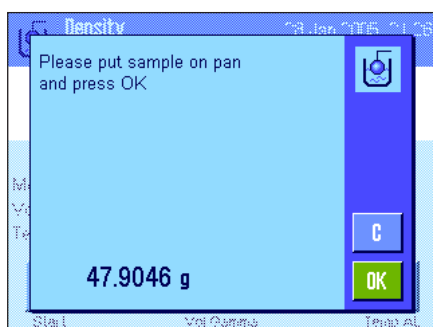

Press the "**Start**" function key to start the density determination. You are then prompted to place the sample on the balance (without the gamma sphere).

The weight of the sample is displayed in the bottom left corner of the window.

Press "**OK**" to tare the sample.

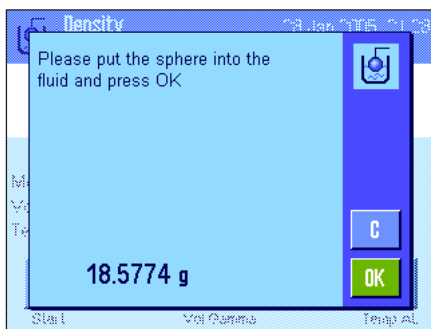

After you have tared the sample you are prompted to immerse the gamma sphere in the sample substance.

The weight of the substance which is displaced by the gamma sphere is displayed in the bottom left corner of the window.

Press **"OK"** to accept the weight value.

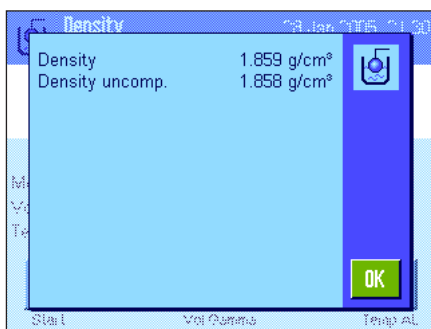

The balance now determines the density of the pasty substance and displays the result. Either the compensated result, the uncompensated result, or both is/are displayed depending on the settings you made for the result display (see Section 12.3.5).

If a printer is connected, you can press the «» key to print out a report of the density determination result according to your specifications (Section 12.3.8). The result is saved until the next density determination using the same method has been completed, so it can be printed out again if required.

#### 12.4.4 Determining the density of liquids using a pycnometer

A pycnometer — a glass container with a known capacity and net weight—is often used for determining the density of liquids. The liquid is poured into the pycnometer and weighed.

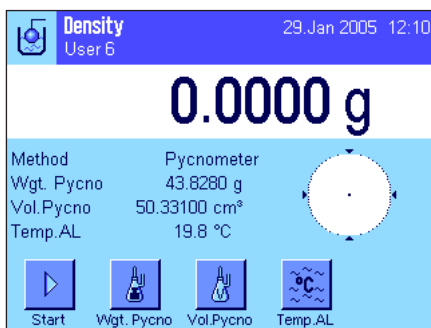

In the application-specific settings, select **"Pycnometer"** as your method (Section 12.3.2).

Activate the appropriate **function keys and information fields** (Sections 12.3.6 and 12.3.7). The example shown here illustrates practical settings for determining the density of liquids using a pycnometer. **Note:** The **"Temp. AL"** function key in the example shown here, and the information field with the same name are not required for this method of density determination. You can, nevertheless, use these function keys to enter the current ambient temperature. This will in turn also be included on the printouts, and indicates the temperature at which the density was determined.

Press the **"Wgt. Pycno"** function key and enter the weight of the pycnometer (in this example, 43.828g).

Press the **"Vol. Pycno"** function key and enter the volume of the pycnometer (in this example, 50.331 cm<sup>3</sup>).

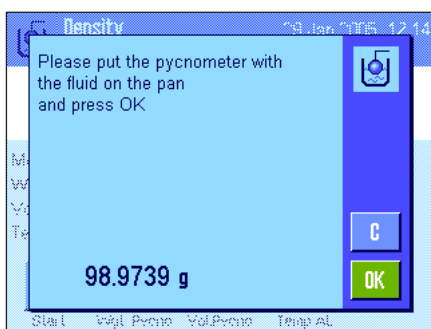

Press the **"Start"**, function key to start the density determination. You will then be prompted to place the filled pycnometer (the selected weight of the pycnometer appears in the lower left-hand corner of the window with a minus sign).

Place the filled pycnometer on the pan. The net weight of the sample appears in the lower left-hand corner of the window. Press **"OK"** to accept the weight value.

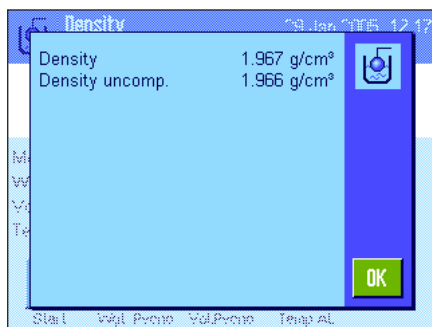

The balance now determines the density of the liquid and displays the result. Either the compensated result, the uncompensated result, or both is/are displayed depending on the settings you made for the result display (see Section 12.3.5).

If a printer is connected, you can press the «» key to print out a report of the density determination result according to your specifications (Section 12.3.8). The result is saved until the next density determination using the same method has been completed, so it can be printed out again if required.

### 12.4.5 Determining the density of porous solid bodies

To determine the density of porous solid bodies, the solid is first weighed in air. In contrast to non-porous solids, a supplementary oil bath is required for closing the pores of the solid before it is weighed in the auxiliary liquid.

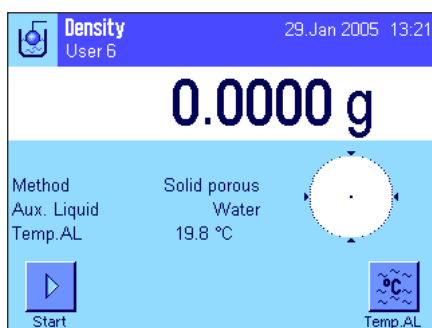

In the application-specific settings, select "**Solid porous**" as your method (Section 12.3.2), and specify the desired auxiliary liquid (Section 12.3.3).

Activate the appropriate **function keys and information** fields (Sections 12.3.6 and 12.3.7).

**Note:** the example shown here illustrates settings for determining the density of solid bodies using distilled water as the auxiliary liquid. If you use an auxiliary liquid other than water or ethanol, then instead of the "**Temp. AL**" function key you should activate the "**Density AL**" function key you should activate the.



If you are using **water or ethanol as the auxiliary liquid**, enter its **temperature** using the "**Temp. AL**" function key. Density tables for these two substances covering the temperature range from 10 °C to 30 °C are stored in the balance; see also Sections 12.7 and 12.8). The illustration here shows the corresponding input field (input in °C with 1 decimal figure).

If you use an **auxiliary liquid other than water or ethanol**, activate the "**Density AL**" function key, and use it to enter **the density of the auxiliary liquid being used at the current temperature** (in g/cm<sup>3</sup>, max. 5 decimal places). This is necessary because density tables are only saved for water and ethanol. The value you have entered appears in the information field with the same name, which you should also activate. **Note:** The "**Temp. AL**" function key, activated in the example shown here, and the information field with the same name are not necessary for determining density when using an auxiliary liquid other than water or ethanol. You can, nevertheless, use these function keys to enter the current ambient temperature. This will in turn also be included on the printouts, and indicates the temperature at which the density was determined.

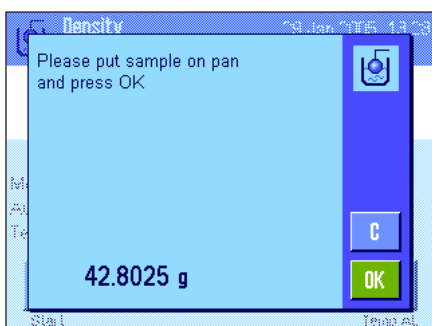

Press the "**Start**" function key to start the density determination. The balance will automatically carry out a taring, after which you will be prompted to put the solid in place (first weighing in air).

If you are working with the optional density kit, follow the instructions that are included with it. If you are using the hanger (for weighing underneath the balance), hang the solid body from the suspension equipment.

The weight of the solid body appears in the lower left-hand corner of the window. Press "**OK**", to accept the weight value.

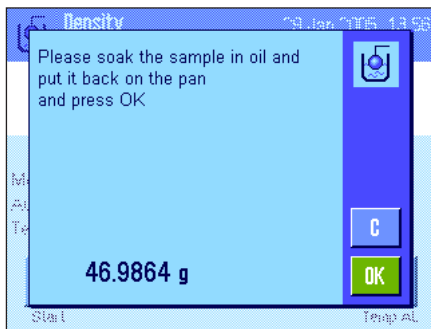

You will now be prompted to briefly immerse the solid body in the oil bath, and then put it back into place (second weighing in air)

Put the oil-coated solid body back into the same position as in the first weighing in air.

The weight of the solid body is displayed in the lower left-hand corner of the window

Press "OK", to accept the weight value.



The balance will now prompt you to immerse the oil-coated solid body in the auxiliary liquid.

If you are working with the optional density kit, follow the instructions that are included with it. If you are working with the hanger, place the container with the auxiliary liquid underneath the suspension equipment. In either case, ensure that the solid body is submerged at least 1 cm under the surface of the liquid, and that there are no air bubbles in the container.

The weight of the solid body submerged in the liquid is displayed in the lower left-hand corner of the window.

Press "OK", to accept the weight value.

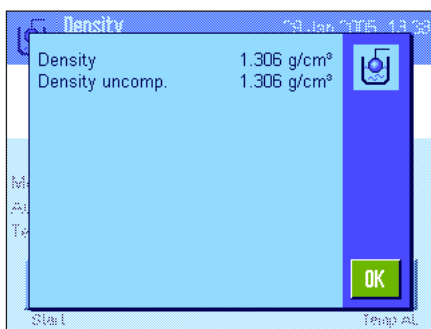

The balance now determines the density of the solid body and displays the result. Either the compensated result, the uncompensated result, or both is/are displayed depending on the settings you made for the result display (see Section 12.3.5).

If a printer is connected, you can press the «Print» key to print out a report of the density determination result according to your specifications (Section 12.3.8). The result is saved until the next density determination using the same method has been completed, so it can be printed out again if required.

### 12.4.6 Example of a density determination report

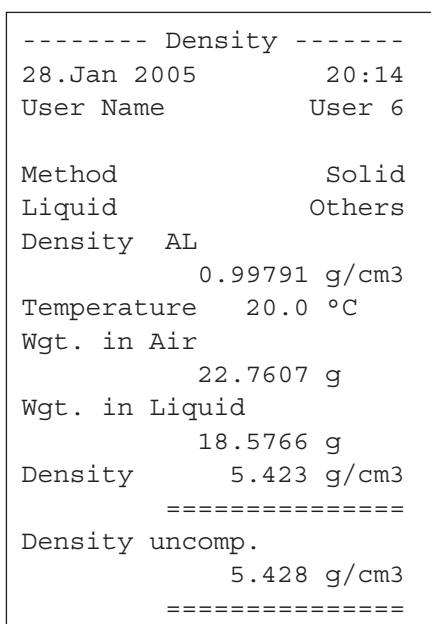

As soon as the result window of a density determination is displayed, you can print out the associated report by pressing the «Print» key.

**Note:** The result is saved until the next density determination has been completed and can be printed out again by pressing the «Print» key. This may be necessary, for example, if you need a second copy of the report, or if the printer cannot print the report because it has run out of paper.

Shown at left is an example of a report for a **density determination of a solid body**. The information which is printed on the report is determined by the settings you made in the "Protocol" (Report) menu (Section 12.3.8).



## 12.5 Using the density statistics

Separate statistics can be maintained for each method of density determination. All results (max. 651500) are saved which you accept into the statistics when you perform density determinations.

### Settings

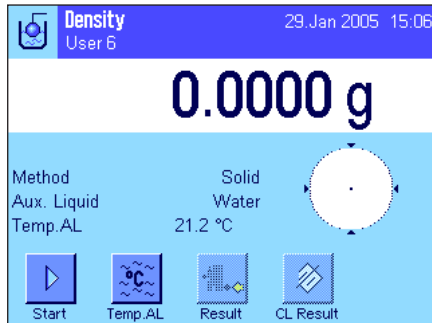

For use of the statistics to be possible, the **statistics function** (Section 12.3.4) and the two function keys "**Result**" and "**CL Result**" must be activated (Section 12.3.6).

**Note:** In the example at left, no values have been accepted into the statistics yet. Because of this, the two function keys "**Result**" and "**CL Result**" are inactive and cannot be used.

### Recording values for the statistics

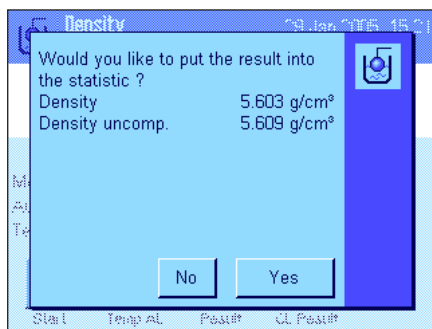

If the statistics function is activated, at the end of each density determination you are asked whether you want to include the result in the statistics.

If you want to include the current measuring result in the statistics, press the "**YES**" key. The result is then included in the **statistics for the current method**.

Inclusion of the result is confirmed in the display.

If you do not want to include the result in the statistics, press "**No**". The result then stays saved until the next measurement, but is not included in the statistics.

### Displaying and printing statistics

Make sure you have selected the density determination method for which you want to display or print statistics (Section 12.3.2).



Press the "**Result**" function key to call up the statistics. **Note:** If there are no values in the statistics, the key is shown gray and cannot be used.

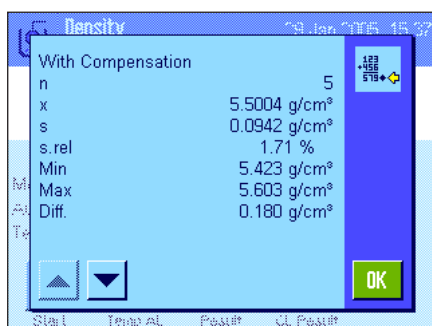

The statistics window displays those values which you selected to be included in reports of statistical data (Section 12.3.8). The following values are selected at the factory:

- "n": Number of samples recorded in the current measurement series
- "x": Average (mean) density of all recorded samples
- "s": Absolute standard deviation of the measurement series
- "s. rel": Relative standard deviation within the measurement series
- "Min": Lowest density value determined in the measurement series
- "Max": Highest density value determined in the measurement series
- "Diff": Difference between the largest and smallest density value within the measurement series

```

----- Density -----
29.Jan 2005      15:55
Method          Solid
Liquid          Water
With Compensation
n               5
x              5.5004 g/cm3
s              0.0942 g/cm3
s.rel          1.71 %
Without Compensation
n               5
x              5.5062 g/cm3
s              0.0944 g/cm3
s.rel          1.72 %
With Compensation
Min            5.423 g/cm3
Max            5.603 g/cm3
Diff.         0.180 g/cm3
Without Compensation
Min            5.429 g/cm3
Max            5.609 g/cm3
Diff.         0.180 g/cm3

Signature
.....
-----
    
```

To print the statistics, with the statistics window open press the «» key. The printout will contain those values which you activated in the "Statistics" submenu of the report settings (Section 12.3.8). An example of a report is shown at left.



**Clear statistics**

If you want to terminate a measurement series, press the "CL Result" key to clear the associated statistics.

**Note:** The "CL Result" function key deletes the statistics for the currently selected method of density determination. The statistics for other methods remain saved. **Before you clear any statistics, you must therefore make sure that you have selected the density determination method whose statistics you want to clear (Section 12.3.2)!**

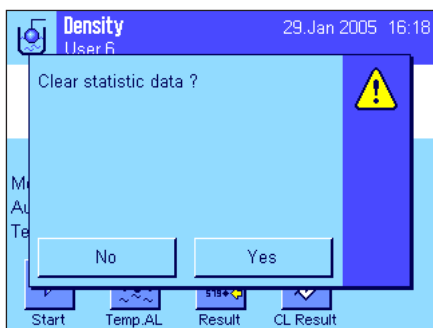

For safety, you are asked for confirmation before the statistics are finally deleted.

## 12.6 Formulae used to calculate density

The "Density" application is based on the formulae listed below.

### 12.6.1 Formulae for determining the density of solid bodies

#### With compensation for air density

$$\rho = \frac{A}{A - B} (\rho_0 - \rho_L) + \rho_L$$

$$V = \alpha \frac{A - B}{\rho_0 - \rho_L}$$

#### Without compensation for air density

$$\rho = \frac{A \cdot \rho_0}{A - B}$$

$$V = \frac{A - B}{\rho_0}$$

- $\rho$  = Density of the sample
- $A$  = Weight of the sample in air
- $B$  = Weight of the sample in the auxiliary liquid
- $V$  = Volume of the sample
- $\rho_0$  = Density of the auxiliary liquid
- $\rho_L$  = Density of air (0.0012 g/cm<sup>3</sup>)
- $\alpha$  = Weight correction factor (0.99985) to take the atmospheric buoyancy of the adjustment weight into account

### 12.6.2 Formulae for determining the density of liquids and pastes

#### With compensation for air density

$$\rho = \frac{\alpha \cdot P}{V_0} + \rho_L$$

#### Without compensation for air density

$$\rho = \frac{P}{V_0}$$

- $\rho$  = Density of the liquid or paste
- $P$  = Weight of the displaced liquid or paste
- $V_0$  = Volume of the sinker or gamma sphere
- $\rho_L$  = Density of air (0.0012 g/cm<sup>3</sup>)
- $\alpha$  = Weight correction factor (0.99985) to take the atmospheric buoyancy of the adjustment weight into account

## 12.7 Density table for distilled water

T/°C	0.0	0.1	0.2	0.3	0.4	0.5	0.6	0.7	0.8	0.9
10.	0.99973	0.99972	0.99971	0.99970	0.99969	0.99968	0.99967	0.99966	0.99965	0.99964
11.	0.99963	0.99962	0.99961	0.99960	0.99959	0.99958	0.99957	0.99956	0.99955	0.99954
12.	0.99953	0.99951	0.99950	0.99949	0.99948	0.99947	0.99946	0.99944	0.99943	0.99942
13.	0.99941	0.99939	0.99938	0.99937	0.99935	0.99934	0.99933	0.99931	0.99930	0.99929
14.	0.99927	0.99926	0.99924	0.99923	0.99922	0.99920	0.99919	0.99917	0.99916	0.99914
15.	0.99913	0.99911	0.99910	0.99908	0.99907	0.99905	0.99904	0.99902	0.99900	0.99899
16.	0.99897	0.99896	0.99894	0.99892	0.99891	0.99889	0.99887	0.99885	0.99884	0.99882
17.	0.99880	0.99879	0.99877	0.99875	0.99873	0.99871	0.99870	0.99868	0.99866	0.99864
18.	0.99862	0.99860	0.99859	0.99857	0.99855	0.99853	0.99851	0.99849	0.99847	0.99845
19.	0.99843	0.99841	0.99839	0.99837	0.99835	0.99833	0.99831	0.99829	0.99827	0.99825
20.	0.99823	0.99821	0.99819	0.99817	0.99815	0.99813	0.99811	0.99808	0.99806	0.99804
21.	0.99802	0.99800	0.99798	0.99795	0.99793	0.99791	0.99789	0.99786	0.99784	0.99782
22.	0.99780	0.99777	0.99775	0.99773	0.99771	0.99768	0.99766	0.99764	0.99761	0.99759
23.	0.99756	0.99754	0.99752	0.99749	0.99747	0.99744	0.99742	0.99740	0.99737	0.99735
24.	0.99732	0.99730	0.99727	0.99725	0.99722	0.99720	0.99717	0.99715	0.99712	0.99710
25.	0.99707	0.99704	0.99702	0.99699	0.99697	0.99694	0.99691	0.99689	0.99686	0.99684
26.	0.99681	0.99678	0.99676	0.99673	0.99670	0.99668	0.99665	0.99662	0.99659	0.99657
27.	0.99654	0.99651	0.99648	0.99646	0.99643	0.99640	0.99637	0.99634	0.99632	0.99629
28.	0.99626	0.99623	0.99620	0.99617	0.99614	0.99612	0.99609	0.99606	0.99603	0.99600
29.	0.99597	0.99594	0.99591	0.99588	0.99585	0.99582	0.99579	0.99576	0.99573	0.99570
30.	0.99567	0.99564	0.99561	0.99558	0.99555	0.99552	0.99549	0.99546	0.99543	0.99540

## 12.8 Density table for ethanol

T/°C	0.0	0.1	0.2	0.3	0.4	0.5	0.6	0.7	0.8	0.9
10.	0.79784	0.79775	0.79767	0.79758	0.79750	0.79741	0.79733	0.79725	0.79716	0.79708
11.	0.79699	0.79691	0.79682	0.79674	0.79665	0.79657	0.79648	0.79640	0.79631	0.79623
12.	0.79614	0.79606	0.79598	0.79589	0.79581	0.79572	0.79564	0.79555	0.79547	0.79538
13.	0.79530	0.79521	0.79513	0.79504	0.79496	0.79487	0.79479	0.79470	0.79462	0.79453
14.	0.79445	0.79436	0.79428	0.79419	0.79411	0.79402	0.79394	0.79385	0.79377	0.79368
15.	0.79360	0.79352	0.79343	0.79335	0.79326	0.79318	0.79309	0.79301	0.79292	0.79284
16.	0.79275	0.79267	0.79258	0.79250	0.79241	0.79232	0.79224	0.79215	0.79207	0.79198
17.	0.79190	0.79181	0.79173	0.79164	0.79156	0.79147	0.79139	0.79130	0.79122	0.79113
18.	0.79105	0.79096	0.79088	0.79079	0.79071	0.79062	0.79054	0.79045	0.79037	0.79028
19.	0.79020	0.79011	0.79002	0.78994	0.78985	0.78977	0.78968	0.78960	0.78951	0.78943
20.	0.78934	0.78926	0.78917	0.78909	0.78900	0.78892	0.78883	0.78874	0.78866	0.78857
21.	0.78849	0.78840	0.78832	0.78823	0.78815	0.78806	0.78797	0.78789	0.78780	0.78772
22.	0.78763	0.78755	0.78746	0.78738	0.78729	0.78720	0.78712	0.78703	0.78695	0.78686
23.	0.78678	0.78669	0.78660	0.78652	0.78643	0.78635	0.78626	0.78618	0.78609	0.78600
24.	0.78592	0.78583	0.78575	0.78566	0.78558	0.78549	0.78540	0.78532	0.78523	0.78515
25.	0.78506	0.78497	0.78489	0.78480	0.78472	0.78463	0.78454	0.78446	0.78437	0.78429
26.	0.78420	0.78411	0.78403	0.78394	0.78386	0.78377	0.78368	0.78360	0.78351	0.78343
27.	0.78334	0.78325	0.78317	0.78308	0.78299	0.78291	0.78282	0.78274	0.78265	0.78256
28.	0.78248	0.78239	0.78230	0.78222	0.78213	0.78205	0.78196	0.78187	0.78179	0.78170
29.	0.78161	0.78153	0.78144	0.78136	0.78127	0.78118	0.78110	0.78101	0.78092	0.78084
30.	0.78075	0.78066	0.78058	0.78049	0.78040	0.78032	0.78023	0.78014	0.78006	0.77997

Density of C<sub>2</sub>H<sub>5</sub>OH according to the "American Institute of Physics Handbook".

## 13 The "Differential Weighing" Application

This section describes the "Differential Weighing" application. Here you will find information on how to work with this application and on the relevant setting options.

Please note that all settings for the "Differential Weighing" application are stored under the active user profile. This means that you can enter user-specific settings for this application. You must therefore ensure that you have first selected the desired user profile.

**Important:** Specific data related to differential weighing (definitions and names of series and samples, etc.) and weighing results are stored in a database. The database is independent of the user profile. There is only **one** database available for all users.

### 13.1 Introduction to the "Differential Weighing" Application

The Differential Weighing application is used to analyze changes in the weight of one or more samples. The first step is to determine the initial weight of the sample (weighing in). Selected components are then separated from or added to the sample. This includes procedures such as drying, centrifugation, filtering, incineration, vaporization, coating, etc. After the sample has been processed, it is re-weighed (residual weight). The balance then determines the difference between the two weighed values.

You can define up to 99 series, each of which can contain multiple samples (the balance can manage a maximum total of 500 samples). Each sample can be tared, weighed in, and re-weighed up to 3 times.

For each series, you can also define whether the operating sequence is performed automatically or manually. In automatic processing, the balance guides you through each step of differential weighing for every sample (taring, weighing in, residual weighing). In manual processing, you can specify the order in which you want to process the samples. In both types of processing, the balance stores the current status of each sample in consecutive order, and thus prevents the accidental duplication of operating steps (for example, it is not possible to weigh the same sample twice).

Many of the application-specific settings are identical to those of the "Weighing" application. However, there are some additional application-specific settings for Differential Weighing. In the following description, only settings that differ from the "Weighing" application are described in detail.

### 13.2 Selecting the Application

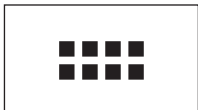

If the "Differential Weighing" application is not already active, press the «:» key. Choose the icon for the application in the selection window.

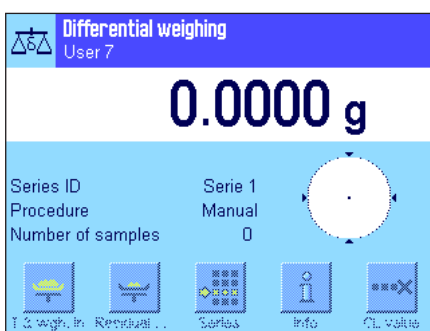

When the application has been selected, the display opposite appears. Some of the specific function keys, as well as specific information fields for differential weighing, are activated ex works. You can adapt these and other settings to your own requirements, as described in the following sections.

**Note:** The figure opposite shows the application after the initial start. All function keys are inactive, as no settings for series and samples have yet been made. Only one series is pre-defined ex works. This series does not contain any samples ("Series 1" with 0 samples).

## 13.3 Settings for the "Differential Weighing" Application

A number of specific settings are available for differential weighing, which can be used to adapt the application to suit your needs.

### 13.3.1 Overview

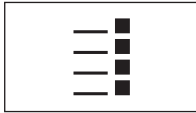

The application-specific settings can be accessed via the «» key. The first of a total of three menu pages appears after pressing this key.

The setting options for the "Differential Weighing" application are virtually identical to those for "Weighing" (section 7.2). Only the settings that differ from the Weighing application are described below. These concern the following menus:

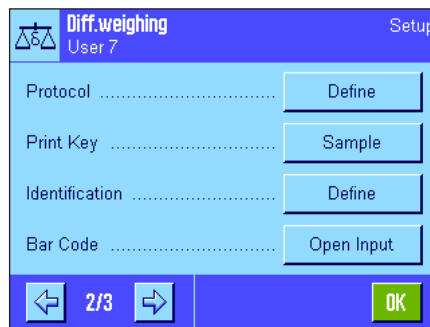
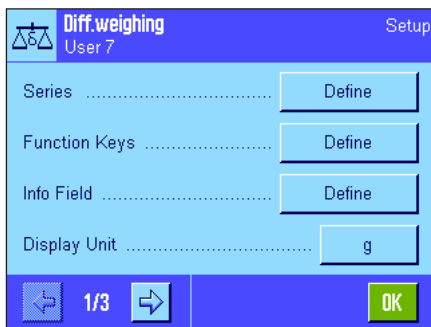

#### "Series":

In this menu, you can define a new series, edit and delete existing series, and select a series for performing differential weighing.

#### "Function Keys":

Additional function keys are available for differential weighing.

#### "Info Field":

Additional information fields are available for differential weighing.

#### "Protocol":

Additional protocol information can be defined for differential weighing.

#### "Print Key":

In this menu, you specify whether values for the selected sample or for the whole series are printed when the «» key is pressed.

#### "Bar Code":

In this menu there is an additional setting for differential weighing.

**Note:** The unit of measure selected in the "Display Unit" menu is used for display and in the printed protocol. However, the application always records and stores data internally using the unit "g" (grams).

The specific settings for the "Differential Weighing" application are described in detail in the following sections. **Note:** The menu for defining and editing a series is very extensive, and is therefore described separately (see section 13.4).

### 13.3.2 Specific Function Keys for Differential Weighing

The first two pages of the function key menu offer the following settings for differential weighing:

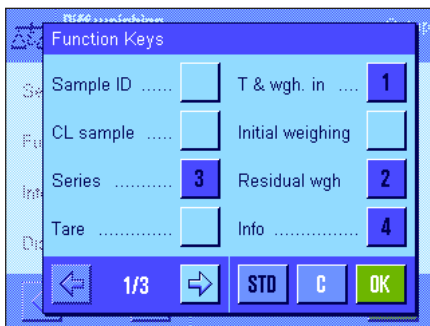

**"Sample ID":**

Use this function key to assign a name to each sample in the current series.

**"CL Sample":**

Deletes all measured values for a sample and resets the sample ID to the default text (see section 13.5.6). The sample itself remains in the series.

**"Series":**

Use this function key to select the series with which you want to work.

**"Tare":**

Tares a sample vessel in a separate operation.

**"T & wgh. in":**

Activates taring of the sample vessel with subsequent weighing in of the sample.

**"Initial weighing":**

Initial weighing of the sample is performed in a separate operation.

**"Residual wgh":**

Starts the residual weighing of a sample.

**"Info":**

Displays information on the current series (sample IDs, measured values, results).

**"No tare":**

Enables differential weighing without tare. Only activate this key if you want to measure a whole series without taring (see section 13.5.6).

**"Copy tare":**

Copies the tare value of the first sample for all further samples in the current series for which the tare value has not yet been recorded (see section 13.5.6).

**"CL value":**

Deletes the weight value that was just recorded (tare, weigh-in or re-weigh weight) (section 13.5.6).

All other function keys are identical to those for the "Weighing" application.

**Factory default setting:** "T & wgh. in", "Residual wgh", "Series", "Info" and "CL value" activated (in this order).

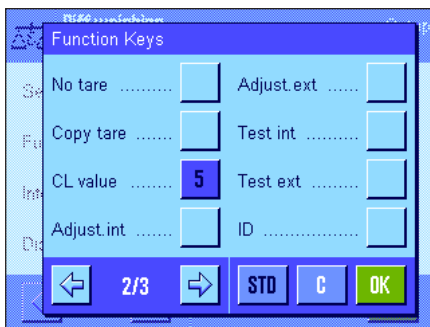

### 13.3.3 Specific Information Fields for Differential Weighing

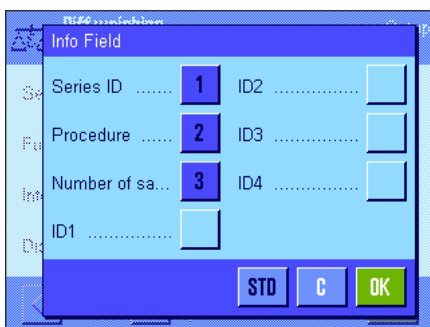

The following settings for differential weighing are available in the menu for the information fields:

**"Series ID":**

Displays the name of the selected series.

**"Procedure":**

Displays the procedure for the selected series (automatic or manual).

**"Number of sa...":**

Displays the number of samples in the selected series.

All other information fields are identical to those for the "Weighing" application.

**Factory default setting:** "Series ID", "Procedure" and "Number of sa..." activated (in this order).

### 13.3.4 Specific Protocol Information for Differential Weighing

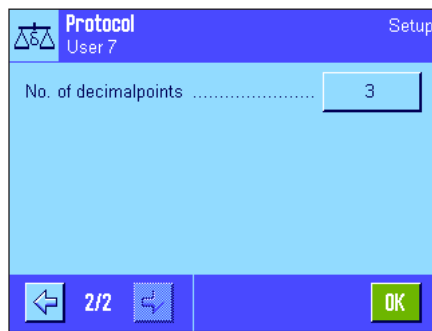
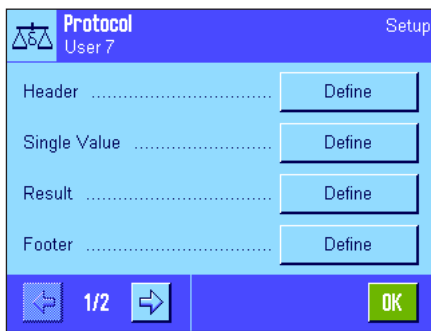

The five submenus in which you can select options for records contain additional settings for differential weighing. These are described below. For further information on protocol settings, please also refer to the settings in the "Print Key" menu (section 13.3.5).

**Note:** The other available protocol information is the same as for the "Weighing" application and is not described here.

#### The printout header

An additional setting for differential weighing is available on the second page of this submenu:

**"Series ID":** Prints the ID of the selected series.

**Factory default setting:** "Appl. Name" ("Differential Weighing" is printed) and "Date/Time" (in this order); no specific information is activated for differential weighing.

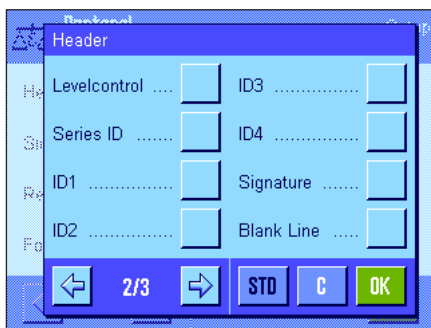

#### Printing protocols for single values

The following specific settings are available for differential weighing on the first and second pages of this submenu: These settings define which additional information is printed for each sample:

**"Series ID":** Prints the series ID.

**"Sample ID":** Prints the sample ID.

**"Tare time":** Prints the date and time at which the tare value was recorded.

**"Tare":** Prints the tare weight value.

**"Weighing in ti...":** Prints the date and time of weigh-in.

**"Weighing in":** Prints the initial weight value.

**"Time 1 res.wgh":** Prints the date and time of the first residual weight.

**"1. Residual wgh":** Prints the weight value of the first residual weight.

**"Time 2 res.wgh":** Prints the date and time of the second residual weight.

**"2. Residual wgh":** Prints the weight value of the second residual weight.

**"Time 3 res.wgh":** Prints the date and time of the third residual weight.

**"3. Residual wgh":** Prints the weight value of the third residual weight.

**Factory default settings:** "Sample ID", "Tare", "Weighing in" and "1. Residual wgh" (in this order).

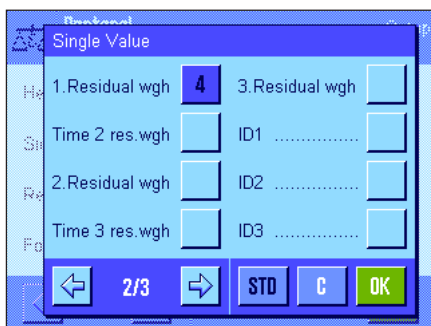
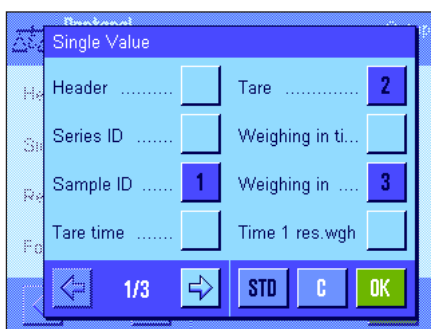



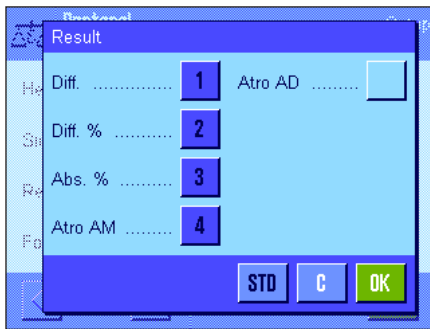

### Defining the results protocol

In this submenu, you define the format in which the results of differential weighing are printed. The following settings are available:

- "**Diff.**": Absolute weight difference between initial weight and residual weight.
- "**Diff. %**": Difference between initial weight and residual weight as a percentage of the initial weight value.
- "**Abs. %**": Residual weight as a percentage of the initial weight (weigh-in value).
- "**Atro AM**": Moisture content of the sample as a percentage of the dry weight ("ATRO Moisture Content").
- "**Atro AD**": Wet weight of the sample as a percentage of the dry weight ("ATRO Dry Content").

**Factory default setting:** "Diff.", "Diff. %", "Abs. %" and "Atro AM" (in this order).

To print the results protocol, press the «» key (prerequisite: the Print key has been configured for printing series data, see section 13.3.5). Results are printed in the display unit selected.

The formulae used to calculate the above settings are provided in section 13.6.

### Printout footer

On the second page of this submenu, you define which additional information for differential weighing is printed in the footer of the printout after the results:

"**Series ID**": Prints the series ID.

**Factory default setting:** "Signature" and "3 Blank Lines" (in this order); no specific information is activated for differential weighing.

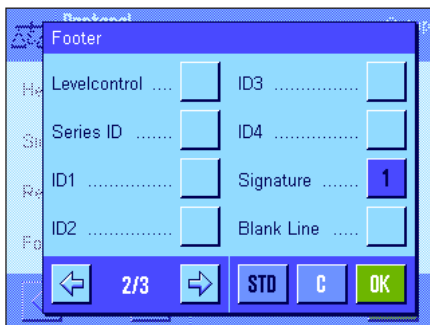

### No. of decimal places

In this submenu, you define the number of decimal places to be included in the results.

"**1**" – "**5**": The results are displayed in the printout with the defined number of decimal places.

**Factory setting:** "3"

**Note:** This setting refers only to the results of differential weighing calculated by the application. Weight values (tare, weigh-in, residual weight) are always recorded in the maximum resolution of the balance used.



For a **sample printout of differential weighing**, see section 13.5.5.

### 13.3.5 Print Key Behavior

In the "Print Key" menu, you can define which data is printed when the «» key is pressed.

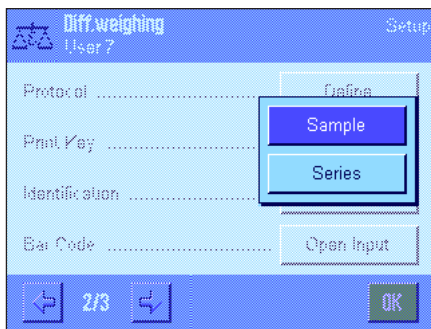

**"Sample":**

Pressing the «» key displays a selection window that lists all the samples in the current series. Here you can select the sample for which you want to print the data.

**"Series":**

When you press the «» key, the data for all samples in the current series is printed out.

**Factory setting:**

"Sample"

### 13.3.6 Special setting for processing barcode data

The "Bar Code" menu contains an additional setting for differential weighing.

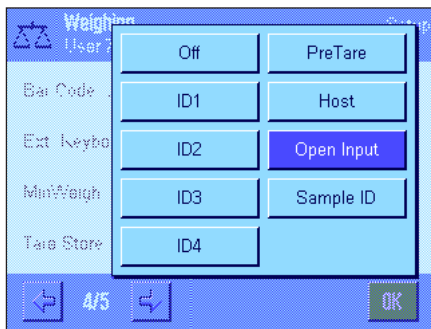

**"Sample ID":**

The barcode that has been scanned in is interpreted as the sample identification. If there is a sample with this ID in the current series, the respective sample is called up and is immediately available for execution of the next work step. If the current series does not contain a sample with this ID, a corresponding message appears.

**Note:** If a series contains several samples with the same ID, the first sample whose ID matches the barcode that has been read in is selected.

**Factory setting:**

"Open Input".

## 13.4 Defining, Editing, Deleting, and Selecting a Series

Before you can perform differential weighing, you must define at least one series with at least one sample.

**Note:** When the application is started, the balance checks that at least 1 series exists. If no series is defined, the application automatically generates series 1.

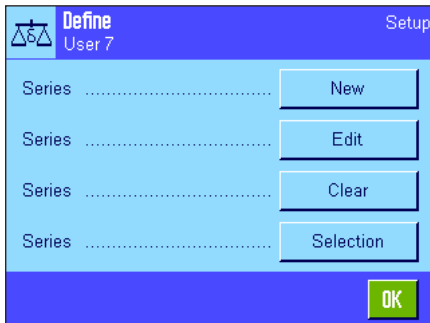

Press the  $\leftarrow$  key and select the menu for defining a series (on the first menu page). This menu contains options for creating a new series, and for editing or deleting an existing series. In the final menu option, you can select the series with which you want to work. These options are explained in more detail in the following sections.

### 13.4.1 Defining a New Series

Choose "Series....New". In this submenu, you can define a new series. The following options are available:

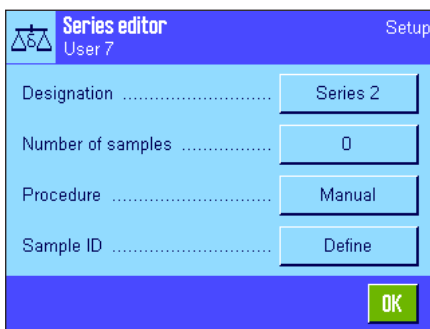

**"Designation":**

Opens an alphanumeric input field in which you can enter a name for the series (max. 20 characters). The series are numbered consecutively as a factory default setting ("series x"). You can change the default text to a name of your choice.

**"No. of samples":**

Opens a numeric input field in which you can define the number of samples in the series.

**Note:** The balance can manage a maximum of 500 samples. For one series, a maximum of 500 samples minus the number of samples already used is therefore available. If you enter a value that exceeds the number of available samples, a corresponding error message is displayed (this may take some time).

**"Procedure":**

You can choose between an automatic or manual procedure for differential weighing. In automatic processing, the balance guides you through each step of differential weighing for every sample (taring, weighing in, re-weighing). For more information, see section 13.5.3. In manual processing, you can specify the order in which you want to process the samples (see section 13.5.4).

**"Sample ID":**

Each new sample is automatically assigned a standard name and a consecutive number ("Sample x"). You can use the alphanumeric input field to change this to a name of your choice (max. 20 characters).

**Note:** If you have activated the function key with the same name, you can also change the sample names directly without having to use the menu.

### 13.4.2 Editing an Existing Series

Choose "Series...Edit". A selection field is displayed in which you can select the series that you want to edit. For editing, the same options are available as for defining a new series (see the previous section).

**Note:** It is only possible to reduce the number of samples in the series if you do not delete samples for which measured values already exist. Example: If you reduce the number of samples for a series from 20 to 10, and measured values already exist for sample 15, the number of samples can only be reduced to 15. You can only continue to reduce the series by deleting the measured values for the affected samples (in this case the measured values for samples 11 – 15).



**Caution:** All series are stored in a single database that is available to all users. You can therefore also edit series created by other users. For this reason, you should proceed with caution when editing a series and consult other users if necessary.

### 13.4.3 Deleting a Series

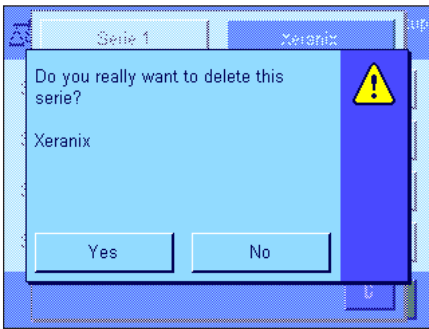

Choose "Series...Clear". A selection field is displayed in which you can select the series that you want to delete. Before the series is deleted, the prompt displayed opposite appears. If you respond with yes, the series is deleted together with all measured values and calculated results.



**Caution:** All series are stored in a single database that is available to all users. You can therefore also delete series created by other users. For this reason, you should proceed with caution when deleting a series, and consult other users if necessary.

### 13.4.4 Selecting a Series for Differential Weighing

Choose "Series...Selection". A selection field is displayed in which you can select the series with which you want to work.

**Note:** Instead of selecting the series via the menu, we recommend that you activate the "**Series**" function key, which enables you to select a series directly without having to use the menu (see section 13.3.2).

### 13.5 Using the "Differential Weighing" Application

This section describes how to work with the "Differential Weighing" application and print the results.

#### 13.5.1 The Different Methods of Differential Weighing

The "Differential Weighing" application supports three possible methods for performing differential weighing. These three methods are described in the following.

##### Method 1 (with taring and weighing in in a single cycle)

This is the simplest method, as the tared weight of the sample vessel and the initial weight (net weight) of the sample are determined in a single procedure:

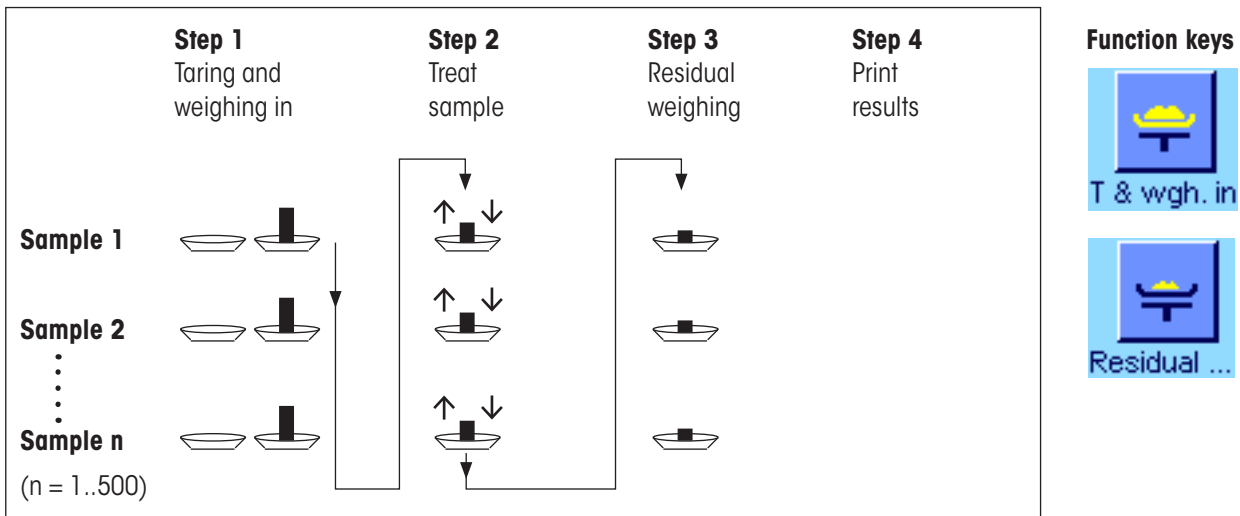

##### Method 2 (with separate taring and weighing in)

In this method, the weight of the sample vessel (tared weight) and the initial weight (net weight) of the sample are determined in separate procedures. With this method, all weighing vessels are tared first, and then all samples are weighed in a second procedure:

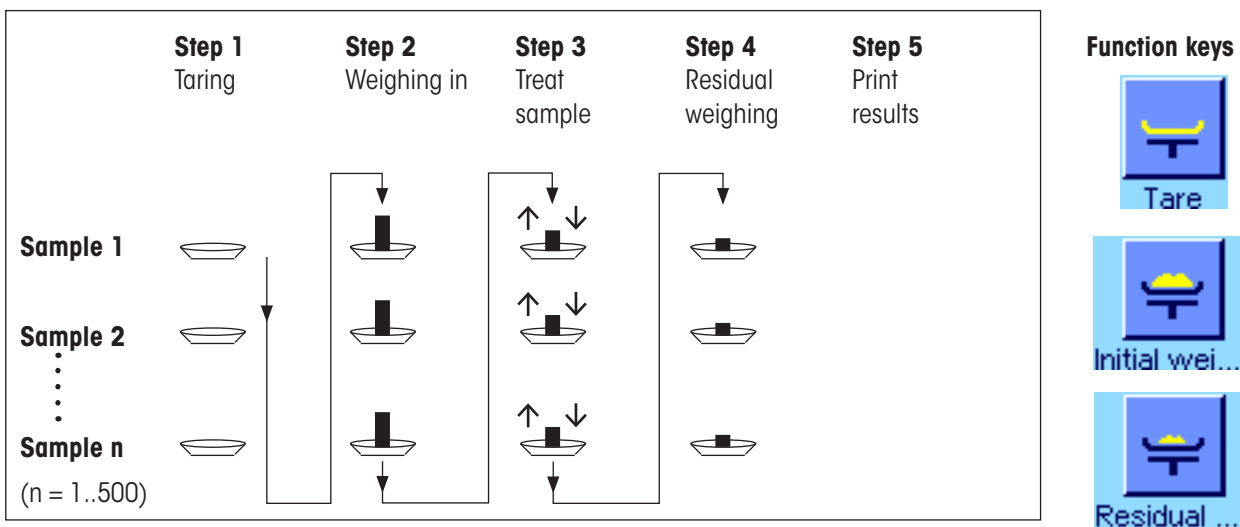

**Method 3** (user-defined)

While methods 1 and 2 automatically follow on from one sample to the next, method 3 permits the user to define the operating sequence, i.e. the taring, weighing in, and residual weighing can be performed as individual steps for each sample. It is therefore not obligatory to carry out all 3 steps for a particular sample before moving on to the next. The following is **an example of user-defined** operation:

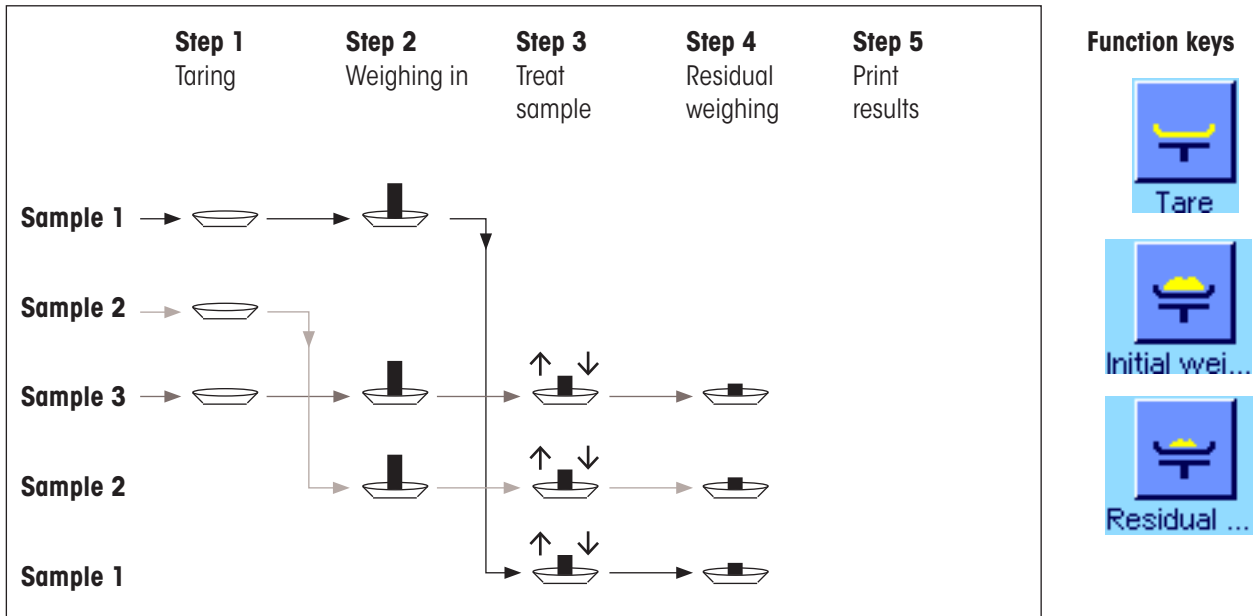

You need to make the appropriate default settings for each working method as described in the following section.

**13.5.2 Default Settings**

This section provides information on the recommended default settings for differential weighing.



Regardless of the method used, the function keys opposite should be activated for every differential weighing procedure so that you can select the series and perform differential weighing (you can also select the series via the menu).



You can also activate these three function keys. These enable you to change the name of a sample at any time (also possible via the menu), call the existing measured values for the current series, and delete the last entered value.



If you are working with **method 1** (taring and weighing-in in a single cycle), the function key opposite should be activated.



Activate this function key if you are using **method 2** (taring and weighing-in in separate steps) or **method 3** (user-defined procedure).



Copy tare



No tare

For specific cases, you can also activate these three function keys. These enable you to transfer the first tare value to all further samples, and allow differential weighing for a series without taring (section 13.5.6).

### 13.5.3 Differential Weighing: Automatic Procedure

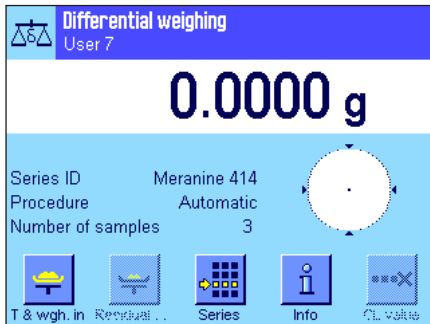

This description only applies if you have selected the automatic procedure for the series.

**Note:** The automatic procedure guides you through method 1 or 2. You can exit automatic processing and switch to manual processing at any time. Conversely, you can also switch from manual to automatic processing at any time.

#### Preparatory steps

The series that is currently active is displayed in the "Series ID" information field. If you want to process a different series, press the "Series" function key and select the required series.

**Note:** To prevent incorrect operation, only the function keys available for the next operating step are active (all other keys are displayed in gray and cannot be selected).

If you want to change the default sample ID and have not already done so when defining the series (section 13.4.1), press the "Sample ID" function key and enter the required name for each sample. The selected names are also displayed on the protocols.

#### Taring and weighing in samples

Press the "T & wgh. in" function key to start differential weighing.

**Note:** In this function, taring and weighing in are performed in a single procedure. If you want to separate the two procedures, you can define separate function keys for taring and for weighing in (section 13.3.2).

The balance displays the first sample in the series for which no tare and weight values are available. If you want to tare and weigh in a different sample, press the arrow key at the bottom of the window. In this example, however, we presume that you want to start with the first sample. Confirm this by pressing "OK".

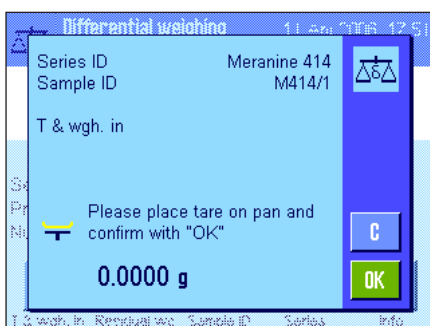
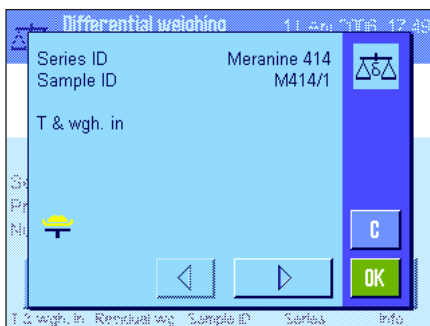

Wait until the balance prompts you to load the weighing vessel (tare) for the first sample. When you have done this, press "OK". While the balance is determining the tare weight, a corresponding message is displayed.

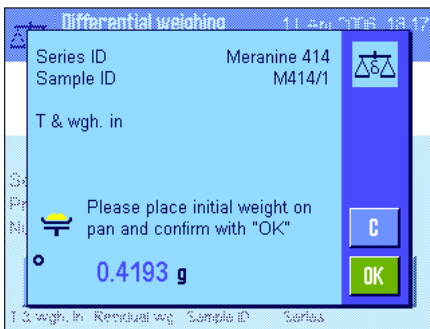

When the balance has determined the tare weight, you are prompted to begin weighing. To perform weighing in, add the weighing sample to the container and then press "OK". While the balance is determining the weight, a corresponding message is displayed.

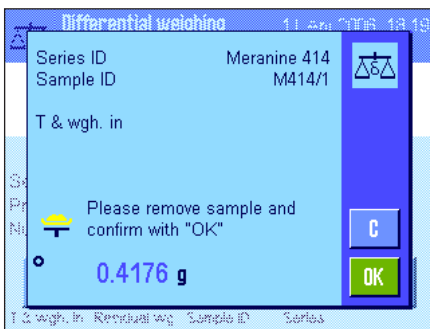

Once weighing in is complete, you are prompted to remove the sample. Remove the sample vessel containing the sample and confirm with "OK".

Taring and weighing in of the first sample in the series is now complete. The balance then automatically starts the above procedure for taring and weighing in all further samples in the series.

**Note:** You can terminate all tare and weighing in procedures at any time. All values recorded up to this point will be saved. If you then press the "T & wgh. in" function key again, the balance automatically calls the first sample for which there is no tare or weigh-in value.

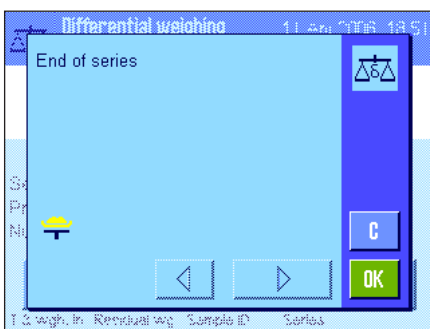

After the last sample, a message is displayed confirming that taring and weighing is complete for all samples in the series.

Confirm the message with "OK". The balance is then ready to perform residual weighing.

Before residual weighing, you separate components from, or add new components to the samples. This includes procedures such as drying, centrifugation, filtering, incineration, vaporization, coating, etc..

### Residual weighing of samples

Press the "Residual wgh." function key.

Since you can re-weigh every sample up to 3 times (e.g. for samples in which components are added or separated in several steps), a window is displayed in which you which residual weighing procedure is being performed. In this example, no residual weighing has yet been performed. Only the first residual weighing is therefore offered for selection.

To start residual weighing, press the button for the required residual weighing procedure.

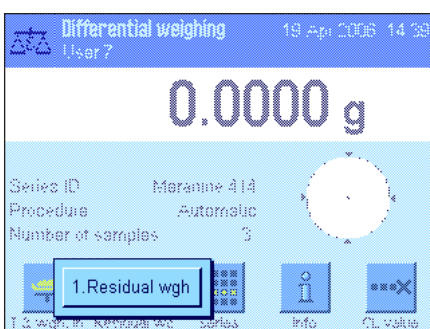





The balance displays the first sample in the series for which no corresponding residual weight values are available. If you want to perform residual weighing for a different sample, press the arrow key at the bottom of the window. In this example, however, we presume that you want to start with the first sample. Confirm this by pressing "OK".

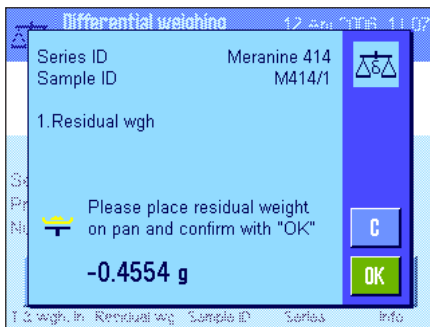

Wait until the balance prompts you to load the selected sample for residual weighing. Load the weighing vessel (tare) with the first sample and then press "OK".

While the balance is determining the weight, a corresponding message is displayed.

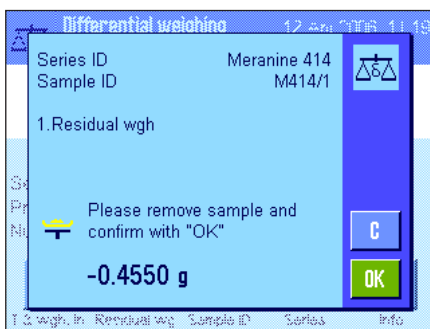

When residual weighing is complete, you are prompted to remove the sample. Remove the sample vessel containing the sample and confirm with "OK".

This completes residual weighing for the first sample. The balance then automatically starts the above procedure for residual weighing of all further samples in the series.

**Note:** You can terminate any residual weighing procedure at any time. All values recorded up to this point will be saved. If you then press the "Residual wgh." function key again, the balance automatically calls the first sample for which there is no residual weight value.

**If you want to perform further residual weighing, press the "Residual wgh." function key and select the required residual weighing procedure from the list (a maximum of 3 residual weights per sample is allowed).**

### Displaying the results of differential weighing

You can use the "Info" function key at any time to display the results of differential weighing. In the example opposite, the results for the first sample are displayed (press the arrow key at the bottom right of the screen to display the results of further samples). The values have the following meaning:

"Series ID": Name of the series

"Sample ID": ID of the sample

"T": Tare value of the sample

"NE": Net weigh-in value

"NR 1": Net value of 1st residual weight **Note:** If multiple residual weights have been performed, these are listed as "NR 2" and "NR 3", and the corresponding results are also labeled with the relevant numbers (e.g. "Diff. 2")

"Diff. 1": Absolute difference between initial weigh-in and 1st residual weight of the sample

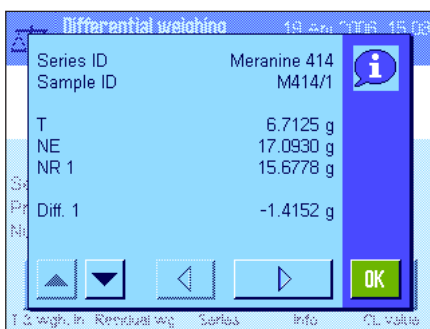

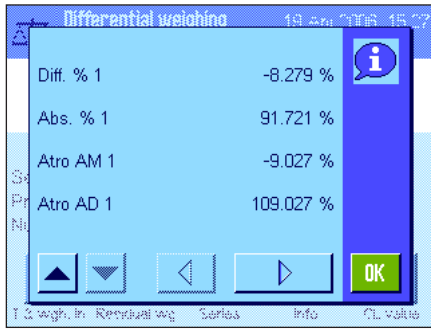

If the results for one sample take up several windows, you can use the scroll buttons at the bottom left of the screen to switch between the individual results windows.

**"Diff.% 1"**: Difference between initial weigh-in and 1st residual weight of the sample as a percentage of the initial weight (weigh-in value)

**"Abs.% 1"**: Residual weight value as a percentage of the weigh-in value

**"Atro AM 1"**: Moisture content of the sample as a percentage of the dry weight

**"Atro AD 1"**: Wet weight of the sample as a percentage of the dry weight.

**Note:** The formulae used to calculate the above results are provided in section 13.6.

### 13.5.4 Differential Weighing: Manual Procedure

The manual procedure is essentially the same as the automatic procedure for differential weighing, except that you determine the sequence in which you want to process the samples. The preparatory steps are the same for both methods.

When you start differential weighing with the **"T & wgh. in"** function key (tare and weigh in), a selection window is displayed. Here you can select the sample for which you want to perform taring and weighing in.

In contrast to the automatic procedure, when an operating step is called, the application does not automatically display the first sample for which no value is yet available. Instead, you must select the sample that you want to process.

Unlike the automatic procedure, the balance provides no further guidance through the process after taring and weighing in the first sample, and the process is not automatically restarted. You can then either tare and weigh in additional samples, or perform residual weighing for the first sample immediately (function key **"Residual wgh."**). The selection window for samples is also displayed in residual weighing.

**Note:** In the sample selection window, only those samples for which the current procedure has not already been performed are displayed.

### 13.5.5 Printing the Results of Differential Weighing

The result of the current differential weighing can be printed using the **«Print»** key. Depending on your settings, either the selected sample or the whole series is printed. The following is an example printout with some explanations.

```

- Differential weighing-
19.Apr 2006           16:59
Sample ID           M414/1
T                   6.7125 g
NE                  17.0930 g
NR 1                15.6778 g
Diff. 1             -1.4152 g
Diff. % 1           -8.279 %
Abs. % 1            91.721 %
Atro AM 1           -9.027 %

Signature
.....
    
```

If you selected the **"Sample"** setting in the **"Print Key"** menu, (section 13.3.5), pressing the **«Print»** key prints the result of differential weighing for a single sample.

Before printing, a selection window is displayed. Here you can select the sample whose values you want to print. A sample printout is illustrated here.

The settings you make in the **"Protocol"** menu control which information is printed (section 13.3.4). The protocol opposite is based on the factory default settings.

If you selected the **"Series"** option in the **"Print Key"** menu (section 13.3.5), the values for all samples in the current series are printed.

### 13.5.6 Additional Options

This section describes some further functions of the "Differential Weighing" application.

#### Deleting a single value



If you realize immediately after entering a value (tare, weigh in, residual weighing) that you have made a error, you can delete the **last entered value** using the "**CL value**" function key. However, this is only possible if no menu has been called, and if you do not exit the application in the meantime. The last value that was recorded can also not be deleted after you change the sample or the series.

#### Deleting all values for a sample

If you have made an error in differential weighing, you can delete all measured values for a single sample.



Before you can delete the values for a sample, the "**CL Sample**" function key must be activated (section 13.3.2).

After pressing the "**CL Sample**" function key, a selection window is displayed. Here you can choose which sample you want to delete.

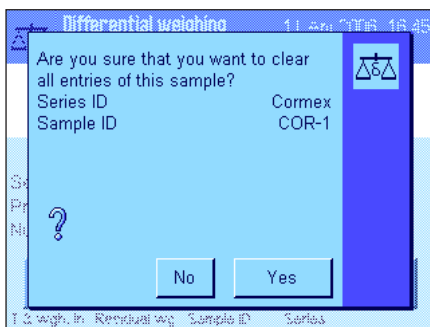

Before deletion, the balance requires you to confirm that you actually want to delete all values for the selected sample. When you confirm the prompt, all available values for tare, weighing in and residual weighing are deleted, and the sample ID is reset to the factory default setting. Check the ID before continuing to work with this sample.

**Note:** The menu for the application-specific settings, includes a function for deleting a whole series (section 13.4.3).



**Note:** All series and sample are stored in a single database that is available to all users. You can therefore also delete series and samples defined by other users. For this reason, you should proceed with caution when deleting a series or sample, and consult other users if necessary.

#### Copying the tare value



The "**Copy tare**" function key enables you to use the tare weight of the first sample for all other samples in the series that do not yet have a defined tare value (existing tare values are retained!). This can save a considerable amount of time if you use the same tare vessel for all samples.

**Note:** The function key is inactive if no tare weight has been entered for the first sample, or if all samples in the series already have a defined tare weight.

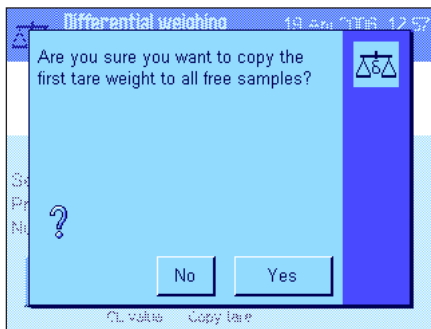

When the function key is pressed, the prompt opposite appears. When you respond with yes, the tare weight of the first sample is copied for all further samples in the current series (as long as no tare weight has already been defined for these samples).

**Differential weighing without tare**

For certain applications in which no tare vessels are used (e.g. filter weighing), you can suppress tare determination for the whole series. This saves an operating step.



Before you can process a series with no tare value, the "No tare" function key must be activated (section 13.3.2).

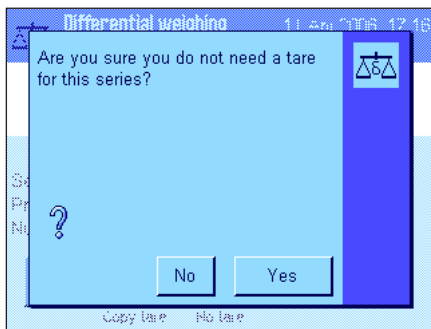

After pressing the "No tare" function key, the balance displays a prompt. Before you confirm this, please consider the following:

If you suppress the tare process, this applies for **all samples in the series** for which no tare value yet exists (existing tare values are retained, all tare values that have not yet been defined are set to zero). If you nonetheless want to enter a tare value for a particular sample in this series, you first need to delete all the measured values for that sample.

**13.6 Formulae Used for Calculating the Results of Differential Weighing**

"Diff.": Residual weight – initial weight

"Diff. %": 
$$\frac{(\text{Residual weight} - \text{initial weight}) \cdot 100\%}{\text{Initial weight}}$$

"Abs. %": 
$$\frac{\text{Residual weight} \cdot 100\%}{\text{Initial weight}}$$

"Atro AM" [0 ... -1000%]: 
$$\frac{- [\text{Initial weight (wet weight)} - \text{residual weight (dry weight)}] \cdot 100\%}{\text{Residual weight (dry weight)}}$$

"Atro AD" [100 ... 1000%]: 
$$\frac{\text{Initial weight (wet weight)} \cdot 100\%}{\text{Residual weight (dry weight)}}$$

## 14 The "LabX Client" application

This section provides an introduction to the "LabX Client" application. It provides information on starting the application and the setting options. **Please note that all settings for the "LabX Client" application are saved under the active user profile, so each user can make their own settings for this application. Because of this, first make sure that you have selected the desired user profile.**

### 14.1 Introduction to the "LabX Client" application

The "LabX Client" application registers your balance as a client in the "**LabX balance**" PC application ("**LabX light balance**" or "**LabX pro balance**"). "LabX balance" enables the definition of complete dialog-controlled work processes for the balance, and can be used to store and manage measured values and additional data in a database on the PC.

As soon as you have started the application, the balance establishes contact with "LabX balance" and following successful logon, the PC application assumes control of the balance. The balance screen then displays the user navigation for "LabX balance".

**The "LabX balance" PC software is not covered in these instructions. For more information on working with this software, see the separate operating instructions for "LabX balance".**

Since your balance is controlled as a "LabX Client" by the PC software, "LabX Client" only has a few application-specific settings.

### 14.2 Selecting the application

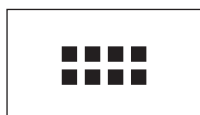

If the "LabX Client" application is not already active, press the «::::» key. Choose the icon for the application in the selection window.

Once the application has been selected, the balance tries to establish contact with the "LabX balance" software on the PC. If logon is successful, the user navigation for "LabX balance" is displayed. **For all further instructions, refer to the operating instructions for "LabX balance".**

## 15 Software updates

METTLER TOLEDO is continuously improving its balance software for the benefit of customers. So that you, the customer, can benefit quickly and easily from further developments, METTLER TOLEDO makes the latest software versions available on the Internet. The Software made available on the Internet has been developed and tested by Mettler-Toledo GmbH using processes that meet the guidelines of ISO 9001. Mettler-Toledo GmbH does not, however, accept liability for consequences that might arise from using the software.

### 15.1 Operating principle

You will find all the relevant information and updates for your balance on the METTLER TOLEDO Web site at the following address:

**[www.mt.com/balance-support](http://www.mt.com/balance-support)**

We recommend that you create a bookmark for this address in your Web browser, so that you can access the site directly in the future.

A program known as the "e-Loader II" is loaded onto your computer together with the software update. You can use this program to download the software to the balance. The "e Loader II" can also save the settings in your balance before the new software is downloaded to it. You can reload the saved settings into the balance after the software is downloaded.

If the selected update includes an application that is not described in these instructions (or that has been updated in the meantime) you can download the corresponding instructions in Adobe Acrobat® PDF format. You will need Adobe Acrobat Reader® to open PDF documents ([www.adobe.com](http://www.adobe.com)).

The following Sections offer detailed information on obtaining software updates from the Internet and downloading software into the balance.

### 15.2 Requirements

The minimum requirements for obtaining applications from the Internet and downloading them into your balance are as follows:

- PC with Microsoft Windows® operating system (Version 98, 98SE, ME, NT 4.0, 2000 or XP)
- Internet connection and Web browser
- PC-balance connection cable (RS232 cable, 9-pin sub-D plug m/f, order number 11101051)

### 15.3 Loading software updates from the Internet

The first step is to download the software from the Internet onto your computer:

Connect to the Internet.

In your browser, select "**[www.mt.com/balance support](http://www.mt.com/balance-support)**" as the Internet address, and then click the "Software" link.

Click on the appropriate update package for your balance.

Enter the information required for registration.

Load the software package onto your computer.

Before you install the "e-Loader II" software program, please read Section 15.4.

## 15.4 Loading the new software into the balance

Before you can load the software obtained from the Internet into the balance, you must connect the balance through the RS232 cable to the serial interface of your computer. **Note:** The cable must always be connected to the **RS232C interface that is permanently fitted at the factory!**

Set the interface on the balance to the following values (detailed information on these system settings can be found in Section 5.6): Select "Host" as the peripheral device, and then set the following communication parameters: **Baud rate: 9600, parity: 8 bits/none, handshake: none, end of line: <CR><LF>, character set: ANSI/WIN.**

Make sure that the corresponding communication parameters on your computer are set to the same values.

Start the "e-Loader II VXXX" information program that you obtained from the Internet ("XXX" is a place holder for the version number). This program installs the e-Loader on your computer.

Follow the instructions, which will take you step-by-step through the installation.



The e-Loader II will start automatically after installation. This diagram illustrates the starting screen for the e-Loader II.

You are asked to select the **interface on the computer** to which the balance is connected (if necessary, this setting can be changed at any later time in the "Options" -> "COM Port" menu).

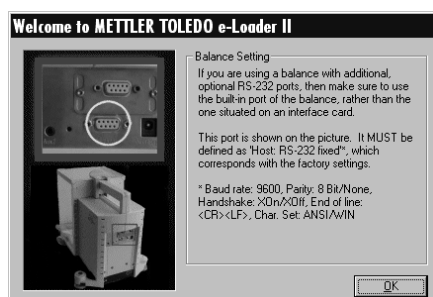

Having selected the interface, click "Proceed".

A message window appears, reminding you that the standard RS232C interface on the balance is to be used. The interface settings are also listed once again (see above). Close the window by clicking on "OK".



Under the factory settings, the e-Loader II guides you through the updating process using English as the **language**. If you wish, you can enter the "Options" -> "Language" menu to select one of the other available languages. The e-Loader II will then display all the instructions and notes in the language that you have chosen. **The following diagrams and information are based on the English version.**

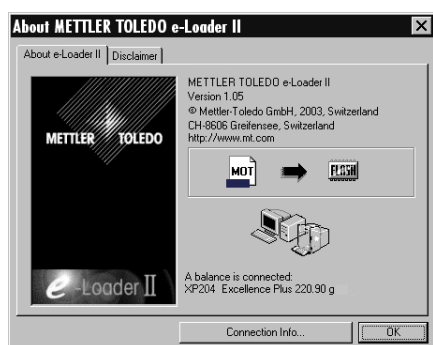

Before you update the software of your balance, please check in the "Help" menu that the communication with the balance is functioning. (In the example shown here, the e-Loader II is confirming that a balance is connected.)

If the e-Loader II reports that a balance is not connected, first check whether the correct interface, with the right setting, has been selected, and then, if necessary, check that the communication settings of the computer and the balance correspond.



You can begin the updating process once you have made the necessary settings and checked that the connection is operating. Click on "Start Software Update Procedure" to do this. Follow the instructions provided by e-Loader II; these will guide you step-by-step through the updating process. e-Loader II will ask you if you want to save the current balance settings on your computer. We recommend that you carry out this data backup. This will save you from having to enter all the settings again, since they will all be returned to the factory settings in the course of the update. At the end of the updating procedure, e-Loader II will ask whether the saved data should be reloaded back into the balance.



Before you start the actual updating operation, you have the possibility to define a **Secure ID** to protect the balance against unauthorized software updating operations. To do this, click on the "Create Secure-ID" button. If you do not wish to use this function, click on "Continue".

The Secure ID is balance-specific and saved in the balance. Please make a note of the Secure ID and keep it in a safe place. If you forget the Secure ID, no further updates can be made to the balance.



Define the "Secure ID" and confirm it by entering it again in the field provided. Then click on "Continue".

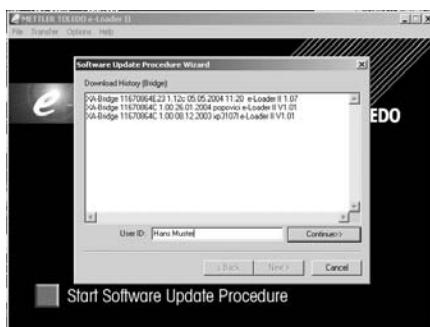

The e-Loader II now displays a list of the updates which have been performed. In this window you can enter a user identification "**User ID**" so that it is subsequently possible to trace who performed the software updating operation.

Click on "Continue" to start the updating operation.

The balance software consists of a terminal software and a weighing-platform software. After the terminal software has been loaded, updating of the weighing-platform software begins. Here, too, you can define a Secure ID and enter a User ID.

**Changing the Secure ID:** The Secure ID can be changed when a new software updating operation is started. To do so, click on the "Change Secure ID" field. You can now enter a new Secure ID. If you leave the field empty, the Secure ID is deleted and no longer active.

When the updating process has been completed you can close e-Loader II. Your balance will now operate with the newly loaded software.





## 15.5 Saving and reloading balance settings

In addition to balance software updates, e-Loader II also offers a function whereby the current balance settings can be copied to a PC. This allows you to have a backup copy of your settings available at all times. This function can also be used to copy the settings from one balance to another.

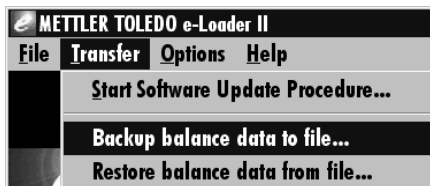

In order to save the current balance settings on a PC, start e-Loader II and call up the data backup function, as shown in the diagram here.

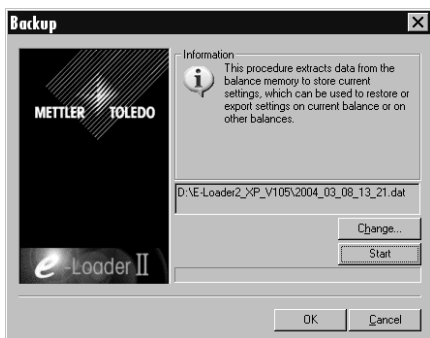

e-Loader II suggests a path and a name for the backup file. You can change these designations via the "Change" key.

Note: e-Loader suggests a combination of the current date and the current time as a name for the backup file, and the file extension ".dat". (For example: "2004\_03\_08\_13\_21.dat" for a backup file that was created on March 8, 2004 at 13.21 hours.) You are free to alter the file name, if you wish, but not the ".dat" extension.

Click on "Start" to begin the data backup. Successful completion of the backup is confirmed on the display.



To copy the balance settings from the PC back into the balance, call the reload function, as illustrated here.

Having started the reload function you can select, via the "Browse" button, the settings file to be loaded back into the balance, after which you can begin the transfer process with "Start". **Keep in mind that this will cause all the settings saved in the balance to be overwritten!**

## 16 Error and status messages

### 16.1 Error messages occurring during normal operation

Most error messages appear in plain text directly in the respective application, and usually accompanied by a text describing how to correct the error. Error messages of this type are self-explanatory and therefore not mentioned below.

The following error messages can appear instead of the weighing result:



#### Overload

The weight on the pan exceeds the weighing capacity of the balance. Reduce the weight on the weighing pan.



#### Underload

Ensure that the weighing pan is correctly in place, can move freely, and does not catch on the draft cover.

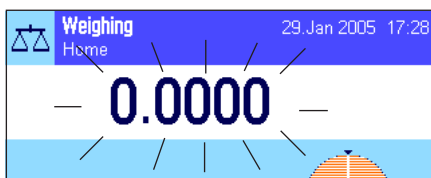

#### Error when switching on or zeroing →0← (weight display flashes)

When the balance was switched on (i.e. when it was connected to the power supply or switched on from standby mode) or upon zeroing, one or more limits were exceeded. The usual reason for this message to appear is when there is a weight on the weighing pan when the balance is switched on. Remove the weight.



#### Taring or zeroing was interrupted

A taring or zeroing operation was aborted because a stable result was not obtained during the settling time ("Timeout"). Close the doors of the draft shield (if your balance is equipped with a draft shield) and check the working location (vibrations, drafts). Press "OK" and repeat the taring («→T←») or zeroing («→0←»).

### 16.2 Further error messages

If any error messages appear ("Error x") other than those described above, please contact your METTLER TOLEDO dealer.

## 16.3 Status messages

Status messages are displayed by means of small icons (symbols) in the top right of the display (under the date and time) (Section 4.2). The status icons indicate the following:



The balance would like to carry out a fully automatic **ProFACT adjustment** but is unable because another operating sequence is running. The adjustment is carried out as soon as the balance is unloaded, the display becomes stable and no key has been pressed for 2 minutes (Section 7.4.1). The status icon disappears after the adjustment is successfully completed.



You have specified in the system settings that the balance should automatically **request an adjustment using an external weight** (Section 5.3.3). The balance uses this status icon and a corresponding message to prompt you to carry out the adjustment. The status icon fades after the adjustment is successfully concluded or if you indicate your decision not to carry out the adjustment (Section 7.4.3).



You have specified in the system settings that the balance should automatically request **adjustment testing using an external weight** (Section 5.3.5). The balance uses this status icon and a corresponding message to prompt you to carry out the test. The status icon fades after the adjustment is successfully concluded or if you indicate your decision not to carry out the adjustment (Section 7.4.5).



The **MinWeigh** is active (Section 7.2.14). This status icon informs you that the minimum weigh-in value for the current tare has not been reached yet and that the current weight value is outside the tolerance range specified by your quality assurance system. The status icon fades as soon as the minimum weigh-in value has been reached (Section 7.3.6).



It is time for the next scheduled test of the **MinWeigh** function (Section 7.3.6). Contact your dealer's customer service department as soon as possible to have a service technician run the test.



The **battery** in your balance must be replaced. This battery ensures that the date and time are not lost when the balance is disconnected from the network. Contact your dealer's service department as soon as possible to have a service technician change the battery.



Your balance is due for **servicing**. Contact your dealer's customer service department as soon as possible to have a technician service your balance.



The built-in level sensor has determined that the balance is not correctly leveled. This status icon normally appears together with a warning text. Level the balance immediately (Section 3.2). The status icon will disappear as soon as the balance is leveled correctly.

## 17 Cleaning and service

Periodically clean the weighing pan, the drip tray, the housing, and the terminal of your balance using the brush supplied with it.

To clean the weighing chamber thoroughly, swivel the glasses of the draft shield (including the intermediate shelf) away from the balance and pull them out of their fastenings. Carefully raise the front of the weighing pan and lift it out of the guide. Pull the drip tray away from the balance.

When you replace these parts, make sure they are in the correct position (see Section 2.2).

Your balance is made from high quality, resistant materials and can therefore be cleaned with a commercially available, mild cleaning agent.



### **Please observe the following notes**

- On no account use cleaning agents, which contain solvents or abrasive ingredients, as this can result in damage to the terminal overlay.
- Ensure that no liquid comes into contact with the balance, the terminal or the AC adapter.
- Never open the balance, terminal or AC adapter - they contain no components, which can be cleaned, repaired or replaced by the user.

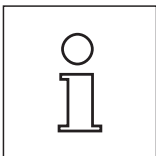

Please contact your METTLER TOLEDO dealer for details of the available service options. Regular servicing by an authorized service engineer ensures constant accuracy for years to come and prolongs the service life of your balance.

## 18 Technical data and accessories

In this Section you will find the most important technical data for your balance. Accessories from the METTLER TOLEDO range increase the functionality of your balance and open up additional areas of application. In this chapter you will find a list of the options currently available.

### 18.1 General data

#### Power supply

- Power supply connector with AC/DC adapter: 11132070, PSU30A-3  
Primary: 100-240V, -15%/+10%, 50/60Hz, 0.8A  
Secondary: 12VDC +/-5%, 2.25A (with electronic overload protection)
- Cable to AC adapter: 3-core, with country-specific plug
- Power supply to the balance: 12VDC +/-5%, 2.25A, maximum ripple: 80mVpp



Use only with a tested AC adapter with SELV output current.

Ensure correct polarity 

#### Protection and standards

- Overvoltage category: Class II
- Degree of pollution: 2
- Protection: Protected against dust and water
- Standards for safety and EMC: See Declaration of Conformity (separate brochure 11780294)
- Range of application: For use only in closed interior rooms

#### Environmental conditions

- Height above mean sea level: Up to 4000 m
- Ambient temperature: 5-40 °C
- Relative air humidity: Max. 80% at 31°C, linearly decreasing to 50% at 40 °C, noncondensing
- Warm-up time: At least **120** minutes after connecting the balance to the power supply; when switched on from standby-mode, the balance is ready for operation immediately.

#### Materials

- Housing: Die-cast aluminum, plastic, chrome steel and glass
- Terminal: Die-cast zinc, chromed and plastics
- Grid weighing pan: Chrome-nickel steel X5CrNi18-10

#### Standard equipment

- Delivered with balance: AC adapter with country-specific power cable  
RS232C interface  
Protective cover for the terminal  
Feedthroughs for below-the-balance weighing and for antitheft device  
ErgoClip "Basket" small  
Cleaning brush
- Documentation: Operating instructions and production certificate
- Dimensions and weight: Balance (W x D x H) [mm] 263 x 487 x 322, Weighing pan (W x D) [mm] 78 x 73, Usable height of draft shield 235 mm, Weight: 10 kg

### 18.1.1 Explanatory notes for the METTLER TOLEDO AC adapter

METTLER TOLEDO balances are operated with a certified external power supply which conforms to the requirements for Class II double insulated equipment and it is not provided with a protective earth connection but with a functional earth connection for EMC purposes. Information about conformance of our products can be found in the brochure "Declaration of Conformity" which is coming with each product or can be downloaded from [www.mt.com](http://www.mt.com)

Consequently an earth bonding test is not required. Similarly it is not necessary to carry out an earth bonding test between the supply earth conductor and any exposed metalwork on the balance.

In case of testing with regard to the directive 2001/95/EC the power supply and the balance has to be handled as Class II double insulated equipment.

Because analytical balances can be sensitive to static charges a leakage resistor, typically  $10\text{k}\Omega$ , is connected between the earth connector and the power supply output terminals. The arrangement is shown in Fig.1. This resistor is not part of the electrical safety arrangement and does not require testing at regular intervals.

#### Equivalent circuit diagram:

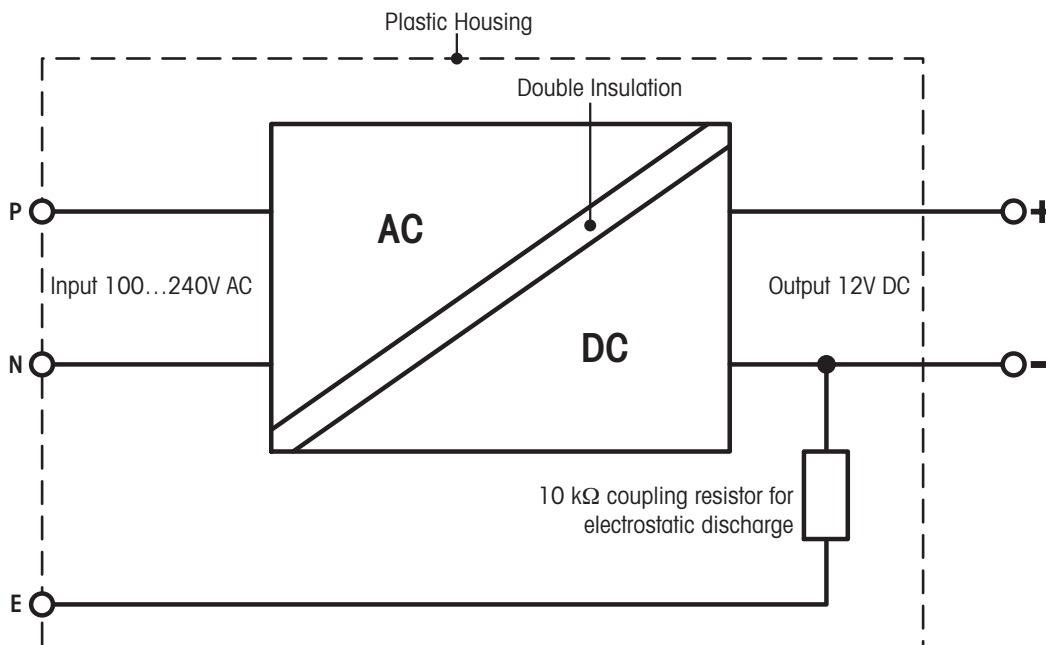

## 18.2 Model-specific data

### Technical data (limit values)

Model	XP105DR	XP205	XP205DR
Maximum load	120 g	220 g	220 g
Maximum load, fine range	31 g	—	81 g
Readability	0.1 mg	0.01 mg	0.1 mg
Readability, fine range	0.01 mg	—	0.01 mg
Repeatability (measured at)	0.06 mg (100 g)	0.03 mg (200 g)	0.06 mg (200 g)
Repeatability at low load (measured at)	0.05 mg (10 g)	0.015 mg (10 g)	0.05 mg (10 g)
Repeatability, fine range (measured at)	0.04 mg (100 g)	—	0.04 mg (200 g)
Repeatability at low load, fine range (measured at)	0.015 mg (10 g)	—	0.015 mg (10 g)
Linearity	0.15 mg	0.1 mg	0.15 mg
Eccentric load deviation (measured at)	0.2 mg (50 g)	0.2 mg (100 g)	0.25 mg (100 g)
Sensitivity offset <sup>2)</sup>	$4 \times 10^{-6} \cdot R_{nt}$	$2 \times 10^{-6} \cdot R_{nt}$	$2.5 \times 10^{-6} \cdot R_{nt}$
Sensitivity temperature drift	$1 \times 10^{-6}/^{\circ}\text{C} \cdot R_{nt}$	$1 \times 10^{-6}/^{\circ}\text{C} \cdot R_{nt}$	$1 \times 10^{-6}/^{\circ}\text{C} \cdot R_{nt}$
Sensitivity stability	$1 \times 10^{-6}/\text{a} \cdot R_{nt}$	$1 \times 10^{-6}/\text{a} \cdot R_{nt}$	$1 \times 10^{-6}/\text{a} \cdot R_{nt}$
Interface update rate	23 /s	23 /s	23 /s
Balance dimensions (W x D x H) [mm]	263 x 487 x 322	263 x 487 x 322	263 x 487 x 322
Usable height of draft shield	235 mm	235 mm	235 mm
Weighing pan dimensions (W x D) [mm]	78 x 73	78 x 73	78 x 73
Weight	10 kg	10 kg	10 kg

### Typical data for determination of the measurement uncertainty

Model	XP105DR	XP205	XP205DR
Settling time	1.5 s	2.5 s	1.5 s
Repeatability (sd) <sup>1)</sup>	$0.04 \text{ mg} + 1 \times 10^{-7} \cdot R_{gr}$	$0.008 \text{ mg} + 6 \times 10^{-8} \cdot R_{gr}$	$0.04 \text{ mg} + 5 \times 10^{-8} \cdot R_{gr}$
Repeatability (sd) fine range <sup>1) 3)</sup>	$0.008 \text{ mg} + 1.5 \times 10^{-7} \cdot R_{gr}$	—	$0.008 \text{ mg} + 1.2 \times 10^{-7} \cdot R_{gr}$
Differential nonlinearity (sd)	$\sqrt{2.5 \times 10^{-11} \text{ g} \cdot R_{nt}}$	$\sqrt{5 \times 10^{-12} \text{ g} \cdot R_{nt}}$	$\sqrt{1.2 \times 10^{-11} \text{ g} \cdot R_{nt}}$
Differential eccentric load offset (sd)	$1 \times 10^{-6} \cdot R_{nt}$	$5 \times 10^{-7} \cdot R_{nt}$	$5 \times 10^{-7} \cdot R_{nt}$
Sensitivity offset (sd) <sup>2)</sup>	$1 \times 10^{-6} \cdot R_{nt}$	$5 \times 10^{-7} \cdot R_{nt}$	$8 \times 10^{-7} \cdot R_{nt}$
Minimum weight (according to USP) <sup>1) 4)</sup>	$120 \text{ mg} + 3 \times 10^{-4} \cdot R_{gr}$	$24 \text{ mg} + 1.8 \times 10^{-4} \cdot R_{gr}$	$120 \text{ mg} + 1.5 \times 10^{-4} \cdot R_{gr}$
Minimum weight (according to USP), fine range <sup>1) 3) 4)</sup>	$24 \text{ mg} + 4.5 \times 10^{-4} \cdot R_{gr}$	—	$24 \text{ mg} + 3.6 \times 10^{-4} \cdot R_{gr}$
Minimum weight (U=1%, 2 sd) <sup>1) 4)</sup>	$8 \text{ mg} + 2 \times 10^{-5} \cdot R_{gr}$	$1.6 \text{ mg} + 1.2 \times 10^{-5} \cdot R_{gr}$	$8 \text{ mg} + 1 \times 10^{-5} \cdot R_{gr}$
Minimum weight (U=1%, 2 sd) fine range <sup>1) 3) 4)</sup>	$1.6 \text{ mg} + 3 \times 10^{-5} \cdot R_{gr}$	—	$1.6 \text{ mg} + 2.4 \times 10^{-5} \cdot R_{gr}$

<sup>1)</sup> Valid for compact objects

<sup>2)</sup> After adjustment with built-in reference weight

<sup>3)</sup> On DeltaRange models: fine range starts at zero gross load

<sup>4)</sup> The minimum weight can be improved by the following measures:

- Selecting suitable weighing parameters
- Choosing a better location
- Using smaller taring containers

sd = Standard deviation

R<sub>gr</sub> = Gross weight

R<sub>nt</sub> = Net weight (sample weight)

a = Year (annum)

Data shown as typical are reference values for calculation of the expected measurement uncertainty. The actual measurement performance may be affected negatively or positively by the place of use and/or the settings.

**Technical data (limit values)**

Model	XP204	XP504	XP504DR
Maximum load	220 g	520 g	520 g
Maximum load, fine range	---	---	101 g
Readability	0.1 mg	0.1 mg	1 mg
Readability, fine range	---	---	0.1 mg
Repeatability (measured at)	0.07 mg (200 g)	0.12 mg (500 g)	0.6 mg (500 g)
Repeatability at low load (measured at)	0.05 mg (10 g)	0.1 mg (10 g)	0.5 mg (10 g)
Repeatability, fine range (measured at)	---	---	0.25 mg (500 g)
Repeatability at low load, fine range (measured at)	---	---	0.1 mg (10 g)
Linearity	0.2 mg	0.4 mg	0.5 mg
Eccentric load deviation (measured at)	0.25 mg (100 g)	0.4 mg (200 g)	0.5 mg (200 g)
Sensitivity offset <sup>2)</sup>	$3 \times 10^{-6} \cdot R_{nt}$	$3 \times 10^{-6} \cdot R_{nt}$	$4 \times 10^{-6} \cdot R_{nt}$
Sensitivity temperature drift	$1 \times 10^{-6} / ^\circ\text{C} \cdot R_{nt}$	$1 \times 10^{-6} / ^\circ\text{C} \cdot R_{nt}$	$1 \times 10^{-6} / ^\circ\text{C} \cdot R_{nt}$
Sensitivity stability	$1 \times 10^{-6} / \alpha \cdot R_{nt}$	$1 \times 10^{-6} / \alpha \cdot R_{nt}$	$1 \times 10^{-6} / \alpha \cdot R_{nt}$
Interface update rate	23 /s	23 /s	23 /s
Balance dimensions (W x D x H) [mm]	263 x 487 x 322	263 x 487 x 322	263 x 487 x 322
Usable height of draft shield	235 mm	235 mm	235 mm
Weighing pan dimensions (W x D) [mm]	78 x 73	78 x 73	78 x 73
Weight	10 kg	10 kg	10 kg

**Typical data for determination of the measurement uncertainty**

Model	XP204	XP504	XP504DR
Settling time	1.5 s	1.5 s	1.5 s
Repeatability (sd) <sup>1)</sup>	$0.04 \text{ mg} + 5 \times 10^{-8} \cdot R_{gr}$	$0.04 \text{ mg} + 6 \times 10^{-8} \cdot R_{gr}$	$0.4 \text{ mg} + 2 \times 10^{-7} \cdot R_{gr}$
Repeatability (sd) fine range <sup>1)3)</sup>	---	---	$0.04 \text{ mg} + 2 \times 10^{-7} \cdot R_{gr}$
Differential nonlinearity (sd)	$\sqrt{2 \times 10^{-11} \text{ g} \cdot R_{nt}}$	$\sqrt{5 \times 10^{-11} \text{ g} \cdot R_{nt}}$	$\sqrt{8 \times 10^{-11} \text{ g} \cdot R_{nt}}$
Differential eccentric load offset (sd)	$6 \times 10^{-7} \cdot R_{nt}$	$5 \times 10^{-7} \cdot R_{nt}$	$5 \times 10^{-7} \cdot R_{nt}$
Sensitivity offset (sd) <sup>2)</sup>	$1 \times 10^{-6} \cdot R_{nt}$	$6 \times 10^{-7} \cdot R_{nt}$	$8 \times 10^{-7} \cdot R_{nt}$
Minimum weight (according to USP) <sup>1)4)</sup>	$120 \text{ mg} + 1.5 \times 10^{-4} \cdot R_{gr}$	$120 \text{ mg} + 1.8 \times 10^{-4} \cdot R_{gr}$	$1200 \text{ mg} + 6 \times 10^{-4} \cdot R_{gr}$
Minimum weight (according to USP), fine range <sup>1)3)4)</sup>	---	---	$120 \text{ mg} + 6 \times 10^{-4} \cdot R_{gr}$
Minimum weight (U=1%, 2 sd) <sup>1)4)</sup>	$8 \text{ mg} + 1 \times 10^{-5} \cdot R_{gr}$	$8 \text{ mg} + 1.2 \times 10^{-5} \cdot R_{gr}$	$80 \text{ mg} + 4 \times 10^{-5} \cdot R_{gr}$
Minimum weight (U=1%, 2 sd) fine range <sup>1)3)4)</sup>	---	---	$8 \text{ mg} + 4 \times 10^{-5} \cdot R_{gr}$

<sup>1)</sup> Valid for compact objects

<sup>2)</sup> After adjustment with built-in reference weight

<sup>3)</sup> On DeltaRange models: fine range starts at zero gross load

<sup>4)</sup> The minimum weight can be improved by the following measures:

- Selecting suitable weighing parameters
- Choosing a better location
- Using smaller taring containers

sd = Standard deviation

Rgr = Gross weight

Rnt = Net weight (sample weight)

$\alpha$  = Year (annum)

Data shown as typical are reference values for calculation of the expected measurement uncertainty. The actual measurement performance may be affected negatively or positively by the place of use and/or the settings.



### **18.2.1 Zero-setting range and switch-on zero range for certified balances**

#### **Zero-setting range**

Certified balances can only be set to zero within  $\pm 2\%$  of the maximum capacity. Outside this range, the balance must be tared.

#### **Switch-on zero range**

Certified balances can only be started up when the load is within the range  $-5 \text{ g} \dots +28 \text{ g}$  relative to the switch-on zero value (balance with empty weighing pan).

### 18.3 Dimensions of the XP analytical balances

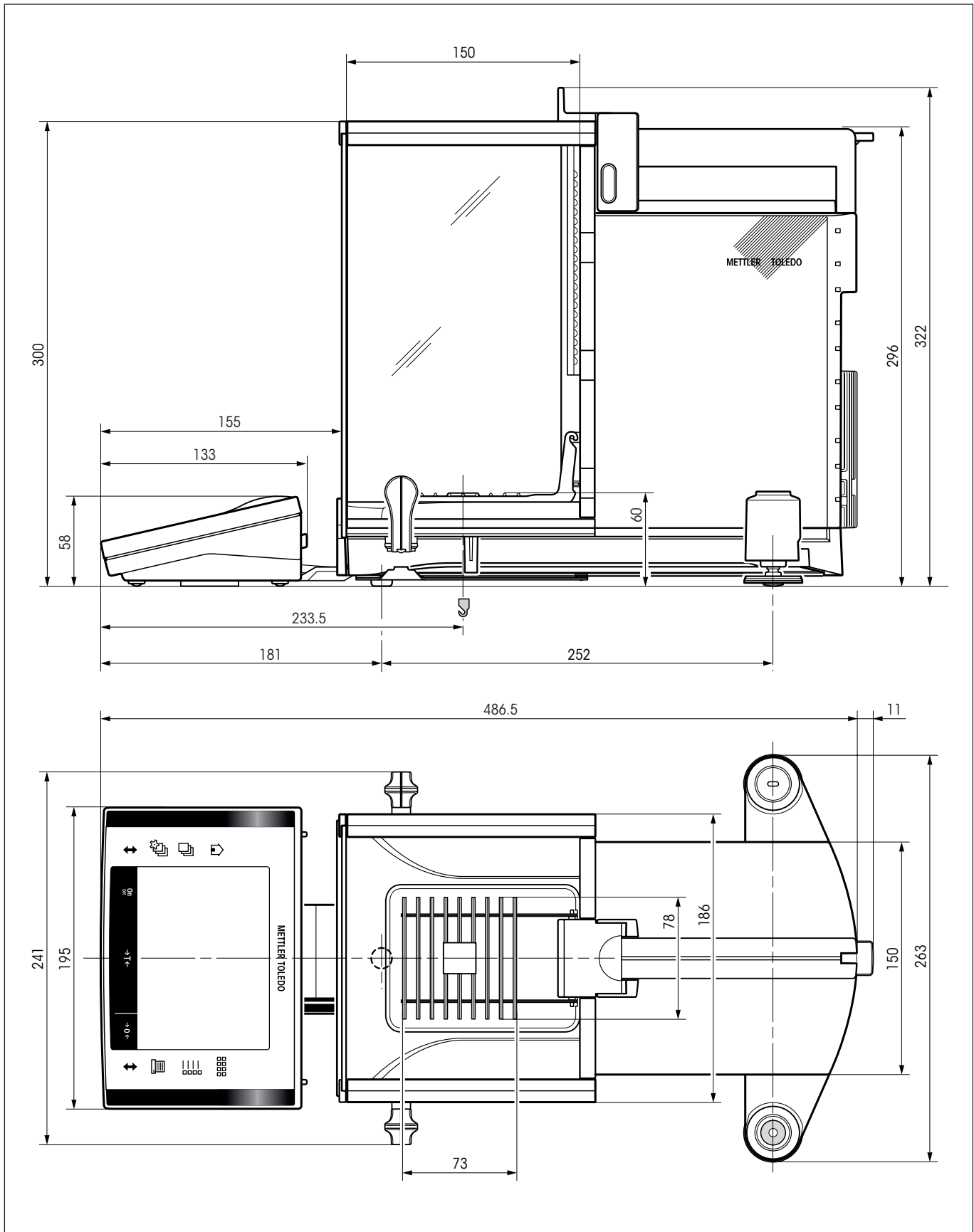

## 18.4 Specifications of the RS232C interface

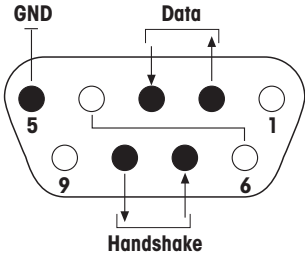
Interface type:	Voltage interface according to EIA RS-232C/DIN 66020 (CCITT V24/V.28)	
Max. cable length:	15m	
Signal level:	Outputs: +5V ... +15V (RL = 3 – 7kΩ) –5V ... –15V (RL = 3 – 7kΩ)	Inputs: +3V ... 25V –3V ... 25V
Connector:	Sub-D, 9-pole, female	
Operating mode:	Full duplex	
Transmission mode:	Bit-serial, asynchronous	
Transmission code:	ASCII	
Baud rates:	600, 1200, 2400, 4800, 9600, 19200, 38400 <sup>1)</sup> (software selectable)	
Bits/parity:	7-bit/even, 7-bit/odd, 7-bit/none, 8-bit/none (software selectable)	
Stop bits:	1 stop bit	
Handshake:	None, XON/XOFF, RTS/CTS (über Software wählbar)	
End-of-line:	<CR><LF>, <CR>, <LF> software selectable)	
 <p>Pin 2: Balance transmit line (TxD)  Pin 3: Balance receive line (RxD))  Pin 5: Ground signal (GND)  Pin 7: Clear to send (hardware handshake) (CTS)  Pin 8: Request to send (hardware handshake) (RTS)</p>		

1) 38400 baud is only possible in special cases, such as:

- Weighing platform without terminal, or
- Weighing platform with terminal, only via the optional RS232C interface.

## 18.5 Specification of the "Aux" connections

You can connect the METTLER TOLEDO "ErgoSens" or an external switch to sockets Aux 1 and Aux 2. This allows you to start functions such as taring, zeroing, printing and others.

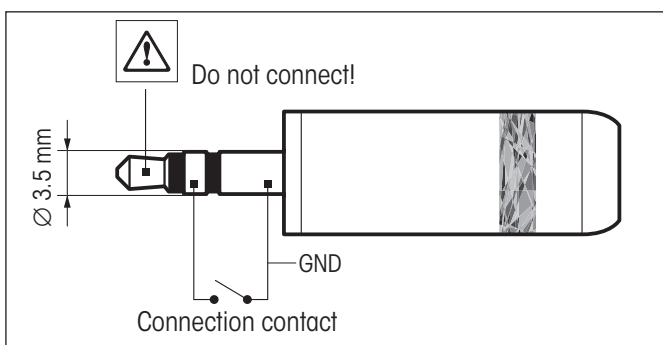

### External connection:

Connector: 3.5 mm stereo jack connector  
Electrical data: Max. voltage 12 V  
Max. current 150 mA

## 18.6 MT-SICS Interface commands and functions

Many of the balances and scales used have to be capable of integration in a complex computer or data acquisition system.

To enable you to integrate balances in your system in a simple manner and utilize their capabilities to the full, most balance functions are also available as appropriate commands via the data interface.

All new METTLER TOLEDO balances launched on the market support the standardized command set "METTLER TOLEDO Standard Interface Command Set" (MT-SICS). The commands available depend on the functionality of the balance.

### Basic information on data interchange with the balance

The balance receives commands from the system and acknowledges the command with an appropriate response.

### Command formats

Commands sent to the balance comprise one or more characters of the ASCII character set. Here, the following must be noted:

- Enter commands only in uppercase.
- The possible parameters of the command must be separated from one another and from the command name by a space (ASCII 32 dec., in this description represented as `␣`).
- The possible input for "text" is a sequence of characters of the 8-bit ASCII character set from 32 dec to 255 dec.
- Each command must be closed by CRLF (ASCII 13 dec., 10 dec.).

The characters `CRLF`, which can be inputted using the Enter or Return key of most entry keypads, are not listed in this description, but it is essential they be included for communication with the balance.

### Example

#### S – Send stable weight value

Command	<code>S</code>	Send the current stable net weight value.
Response	<code>S␣S␣WeightValue␣Unit</code>	Current stable weight value in unit actually set under unit 1.
	<code>S␣I</code>	Command not executable (balance is currently executing another command, e.g. taring, or timeout as stability was not reached).
	<code>S␣+</code>	Balance in overload range.
	<code>S␣-</code>	Balance in underload range.

### Example

Command	<code>S</code>	Send a stable weight value.
Response	<code>S␣S␣␣␣␣␣␣␣␣100.00␣g</code>	The current, stable weight value is 100.00 g.



## 18.7 Accessories

You can increase the functionality of your balance with accessories from the METTLER TOLEDO range. The following options are available:

<b>Printer</b> RS-P42: Printer with connection cable RS232, for recording results BT-P42: Bluetooth printer with wireless connection to the balance	00229265 11132540
<b>Optional interfaces</b> RS232C (second RS232C interface) LocalCAN: Connection for max. 5 devices with LocalCAN connection MiniMettler (downward compatibility to older devices from METTLER TOLEDO) PS/2: For connection of commercially available keyboards and barcode readers BTS (Bluetooth): For wireless connection to a BT-P42 printer, BT-BLD auxiliary display or to a PC BT option: For wireless connection for max. 6 different devices Ethernet: For connection to an Ethernet network e-Link IP65 EB01: Ethernet connection to the e-Link network with IP65 protection	11132500 11132505 11132510 11132520 11132535 11132530 11132515 11120003
<b>Cable for RS232C interface</b> (for standard interface or option 11132500) RS9 – RS9 (m/f), connection cable for computer or RS-P42 printer, length = 1 m RS9 – RS25 (m/f), connection cable for computer (IBM XT or compatible), length = 2 m RS9 – RS9 (m/m), connection cable for devices with DB9 socket (f), length = 1 m	11101051 11101052 21250066
<b>Cable for LocalCAN interface</b> (option 11132505) LC-RS9: Cable for connecting a PC with RS-232C, 9-pin, length = 2 m LC-RS25: Cable for connecting a printer or PC with RS-232C, 25-pin (m/f), length = 2 m LC-RS open: Cable for connecting the MT ComBus system, length = 4 m LC-CL: Cable for connecting a device with METTLER TOLEDO CL interface (5-pin), length = 2 m LC-LC03: Extension cable for LocalCAN, length = 0.3 m LC-LC2: Extension cable for LocalCAN, length = 2 m LC-LC5: Extension cable for LocalCAN, length = 5 m LC-LCT: Cable branch (T-connector) for LocalCAN	00229065 00229050 21900640 00229130 00239270 00229115 00229116 00229118
<b>Cable for MiniMettler interface</b> (option 11132510) MM – RS9f: RS232C connection cable for MiniMettler Interface, length = 1.5 m	00210493
<b>Auxiliary display</b> (displays only the weight value and unit, if defined) RS/LC-BLD: Auxiliary display with RS232 & LC connection and external power supply, with table stand RS/LC-BLDS: Auxiliary display with RS232 & LC connection for table stand or balance stand BT-BLD bluetooth auxiliary display for wireless connection to balance with BTS interface, with table stand LC-AD: Auxiliary display, active, with table stand LC-ADS: Auxiliary display, active, with table stand	00224200 11132630 11132555 00229140 00229150

<p><b>Input/output devices</b></p> <p>ErgoSens: programmable sensor for hands-off operation, cable length = 0.6 m</p> <p>Foot switch: Programmable key with cable, length 2 m</p> <p>LC-FS: Foot switch with adjustable function for balances with LocalCAN interface</p> <p>LC-IO: Relay interface with digital inputs and outputs, switch eight different devices on and off</p> <p>LC switchbox; connect up to three balances with LocalCAN interface to a printer</p> <p>Barcode reader RS232</p> <ul style="list-style-type: none"> <li>• AC adapter 230V EUR</li> <li>• AC adapter 115V USA</li> </ul> <p>LV11 automatic feeder for small items</p>	<p>11132601</p> <p>11106741</p> <p>00229060</p> <p>21202217</p> <p>00229220</p> <p>21900879</p> <p>21900882</p> <p>21900883</p> <p>21900608</p>
<p><b>Density determination kit</b></p> <p>Kit for density determination of solids and liquids</p> <p>Sinker 10 ml</p> <p>Sinker 10 ml, certified model</p> <p>Precision thermometer, certified model</p>	<p>11106706</p> <p>00210260</p> <p>00210672</p> <p>11132685</p>
<p><b>Antistatic kit</b></p> <p>For discharging electrostatically charged weighing containers and weighing objects (single point ionizer).</p> <p>Optional second single point ionizer</p> <p>Universal antistatic kit, complete (U ionizer)</p> <p>Optional U ionizer for universal antistatic kit</p>	<p>11107761</p> <p>11107762</p> <p>11107767</p> <p>11107764</p>
<p><b>SE kit</b></p> <p>XP-SE kit: Separate evaluation electronics for weighing in contaminated environments</p> <p>Extension cable between cell and evaluation electronics, length 0.6 m</p> <p>Extension cable between cell and evaluation electronics, length 5 m</p>	<p>11106743</p> <p>00211535</p> <p>00210688</p>
<p><b>ErgoClips</b></p> <p>ErgoClip:           Basket Small</p> <p>                          Titration Basket</p> <p>                          Weighing Boat</p> <p>                          Round Bottom Flask</p> <p>                          Flask</p> <p>                          MinWeighDoor (ideal for use with ErgoClip "Flask")</p> <p>                          Tube</p> <p>                          Single-use aluminum weighing pan (10 units)</p>	<p>11106747</p> <p>11106883</p> <p>11106748</p> <p>11106746</p> <p>11106764</p> <p>11106749</p> <p>11106784</p> <p>11106711</p>
<p><b>Weighing Kit - Set of ErgoClips</b></p> <p>Included ErgoClips: Test Tube</p> <p>                          Weighing Boat</p> <p>                          Round Bottom Flask</p> <p>                          Weighing boat (20 units)</p> <p>                          Single-use aluminum pans (10 units)</p>	<p>11106707</p>

<b>Software</b>	
LabX pro balance (network capable solution for management of weighing data)	11120301
LabX light balance (management of weighing data made easy)	11120317
LabX direct balance (simple data transfer)	11120340
Freeweigh. Net	21900895
<b>Moisture trap</b>	
PC-Volume without software, Option 2	21901263
PC-Volume with software, Option 3	21901264
<b>Various</b>	
IP54 Protective housing for AC adapter	11132550
Metal door with cutout for use on XP balance when operating with a LV11 automatic feeder	11106715
Single-use aluminum weighing pan (10 units)	11106711
Wall fixture for terminal	11132665
Fixture for terminal or printer, mounting on balance	11106730
Terminal extension cable, length = 4.5 m	11600517
Protective cover for terminal	11132570
Transport case	11106869
Anti-theft device (steel cable)	11600361



## 19 Appendix

### 19.1 Conversion table for weight units

Kilogram	1 kg = 1000.0	g	1 g = 0.001	kg
Milligram	1 mg = 0.001	g	1 g = 1000.0	mg
Microgram	1 µg = 0.000001	g	1 g = 1000000.0	µg
Carat	1 ct = 0.2	g	1 g = 5.0	ct
Pound	1 lb = 453.59237	g	1 g ≈ 0.00220462262184878	lb
Ounce (avdp)	1 oz = 28.349523125	g	1 g ≈ 0.0352739619495804	oz
Ounce (troy)	1 ozt = 31.1034768	g	1 g ≈ 0.0321507465686280	ozt
Grain	1 GN = 0.06479891	g	1 g ≈ 15.4323583529414	GN
Pennyweight	1 dwt = 1.55517384	g	1 g ≈ 0.643014931372560	dwt
Momme	1 mom = 3.75	g	1 g ≈ 0.266666666666667	mom
Mesghal	1 msg ≈ 4.6083	g	1 g ≈ 0.217	msg
Tael Hong Kong	1 tlh = 37.429	g	1 g ≈ 0.0267172513291833	tlh
Tael Singapore (Malaysia)	1 tls ≈ 37.7993641666667	g	1 g ≈ 0.0264554714621853	tls
Tael Taiwan	1 tlt = 37.5	g	1 g ≈ 0.0266666666666667	tlt
Tola	1 tola = 11.6638038	g	1 g ≈ 0.0857353241830079	tola
Baht	1 baht = 15.16	g	1 g ≈ 0.0659630606860158	baht

## 19.2 SOPs - standard operating procedures

In the documentation of a GLP test, the SOPs are a small, but very important part.

Practical experience confirms that SOPs written in-house are followed much better than SOPs written by an external, anonymous source.

You will find below a brief overview of the responsibilities in relation to SOPs, as well as a checklist for creating an SOP.

### Responsibilities in relation to SOPs

Head of testing laboratory	Instructs SOPs to be created Approves SOPs with date and signature
Testing supervisor	Ensures that SOPs are available Approves SOPs as deputy to laboratory head
Employees	Follow the SOPs and other guidelines
GLP quality assurance	Checks whether valid SOPs are available Checks whether the SOPs are followed Checks how and when changes are documente

### Checklist for creating SOPs

Administrative matters	YES	NO
1. Use of SOP forms		
2. Name of testing laboratory		
3. Date of creation of SOP		
4. Archive reference for SOPs		
5. Page number (1 of n)		
6. Title		
7. Date of release		
8. Modification number		
9. Designation of departments/offices responsible for implementation		
10. Date and signaturesn: a) Author b) Person checking c) Person authorized to approve		
11. Distribution list		

---

<b>Contents of the SOP</b>	<b>YES</b>	<b>NO</b>
1. Introduction and objective		
2. Material required		
3. Description of work steps		
4. Description of documentation		
5. Data processing and evaluation		
6. Documents, samples, etc., to be preserved		
7. Archiving information		

## 20 Index

### A

AC adapter 11, 18, 173, 174  
Accessories 11, 182  
Access rights 47  
Additive mode 90  
Adjusted 81  
Adjustment 37, 171  
Adjustment and test reports 41  
Adjustment testing 171  
Administrator 47  
Ambient conditions 53  
Antistatic kit 75  
Application-specific settings 32  
Applications 32  
Assembling the balance 14  
Automatic door function 55  
Automatic feeder 44, 90  
Automatic tare function 74  
Automatic weight transfer 116  
Automatic zeroing 97  
Automatic zero point correction 53  
AutoPrint 63  
AutoTare 74, 76  
AutoZero 53  
Auxiliary liquid 134, 139, 143

### B

Backup copy 169  
Balance information 42  
Bar code data 71  
Battery 171  
Below-the-balance weighing 24  
Brightness of the display 56

### C

Certificate 40, 72  
Certified balances 177  
Cleaning 172  
Color palette 56  
Component database 102, 107  
Components 102, 112  
Confirmation 57  
Contrast 56  
Conventions 10  
Copying the tare value 163  
Custom unit 64

### D

"Density" application 132  
"Differential Weighing" application 149  
Data backup 168  
Date 30, 43  
Density 132  
Density determination kit 183  
Density statistics 145  
Density table 148  
Dialog language 54  
Differential Weighing 149  
Dimensions of the XP analytical balances 178  
Display 30  
Display field remains dark 18  
Disposal 11  
Doors 55

### E

e-Loader II 166  
ErgoSens 74, 101, 118, 129, 138, 179  
Error messages 170  
External adjustment weights 39  
External keyboard 72  
External test weights 40

### F

"Formulation" application 96  
Features 10  
Fixed reference piece number 114  
Footers 66  
Formula 103, 112  
Formula database 103  
Formulae 147  
Formulas 95  
Formulation 96  
Fully automatic adjustment (calibration) 81  
Function Keys 115, 126, 151  
Function keys 31, 61, 87, 98, 135

### G

Gamma sphere 132, 141  
Glass draft shield 19, 55  
GLP 10, 186  
Good Laboratory Practice 10  
Grid weighing pan cover 25

**H**

"Home" profile 31  
Hanger for weighing below the balance 132  
Header 65

**I**

ID 35, 46, 47  
IDs 70, 77  
Info fields 127, 136  
Information fields 31, 62, 87, 98, 115, 151  
Installing the ErgoClip 25  
Installing the grid weighing pan cover 25  
Installing the single-use aluminum weighing pan 24  
Interface 44  
Interfaces 182  
Intermediate shelf 17  
Intermediate shelf draft shield 17  
ISO 9001 10  
Item counter 77

**K**

Keyboard 72  
Keys 28, 29

**L**

"LabX Client" application 165  
LabX balance 165  
LabX Client 165  
Language 54  
LC-I/O 86, 125  
LC I/O 44  
Level 171  
Leveling Assistant 26  
Leveling the balance 26  
Level sensor 26, 50, 171  
Liquid 140  
Location of the terminal 20  
LV11 44, 86

**M**

Manual tare 76  
Materialien 173  
Mean value 95  
Mean weight 94  
Measured value release 53  
Method 157  
MinWeigh 72, 80, 171  
Model-specific data 175  
MT-SICS 45, 180

**N**

Nominal value 93, 107, 122  
Nominal weight 93, 94

**O**

Operating elements 29  
Operating of the glass draft shield 19  
Operating sequence 34  
Optional density kit 132  
Overload 170  
Overview of your balance 3

**P**

"Percent Weighing" application 125  
"Piece Counting" application 113  
Pack 21  
Password 35, 46, 47  
Pasty substance 141  
Percent weighing 125  
Peripheral devices 11, 44  
Piece Counting 113  
Plausibility check 90  
Plausibility limit 90  
Power supply 18, 173  
Power supply voltage 11  
Power supply voltages 18  
Printout 94  
ProFACT 38, 81, 171  
Protection and standards 173  
Protection of the instrument 11  
Pycnometer 132, 142

**Q**

Quality assurance system 60, 72, 80

**R**

Record 70  
Recording 48  
Record printing 67  
Record title 65  
Reference 126  
Reference optimization 115  
Reference optimizing 123  
Reference piece count 115  
Reference piece number 119  
Reference piece weight 114, 115, 119  
Reference tare 73, 80  
Reference weight 129  
Relative standard deviation 95  
Reload function 169

Reminder function 49  
Remove terminal 20  
Repeatability 53  
Reset 47, 58  
Residual weighing 160  
Resolution 75  
RS232C interface 45, 179

**S**

“Statistics” application 86  
Safety 11  
Schutz und Normen 173  
Secure ID 168  
Security Check 103  
Security system 35, 46  
Selecting a location 18  
Self test 18  
Series 155  
Series weighing 91  
Service 172  
Servicing 171  
Setting the reading angle 20  
Setting up 12  
Simple weighing 28  
Single values 66  
Sinker 132, 140  
SmartSens 29, 74, 101, 118, 129, 138  
SmartTrac 31, 62  
Software 29, 31, 166  
Software updates 166  
Solid 143  
Solid body 139  
SOP 10, 186  
Stability detector 28  
Standard deviation 95  
Standard Operating Procedure 10  
Standard operating procedures 186  
Standard scope of delivery 14  
Standby 42, 43  
Statistics 86, 91, 125, 134  
Status icons 30, 171  
Status messages 171  
Stromversorgung 173  
Summer time 44  
Switching off the balance 26  
Switching on the balance 26  
Symbols 10  
System settings 32, 36

**T**

Tablet Feeder 44  
Tare memory 73  
Tare preset 61, 74, 76  
Taring 28  
Technical data 173  
Temperature Criterion 38  
Temperature criterion 81  
Terminal 20, 29  
Testing adjustments 83  
Test weight 40  
Time 30, 43  
Time-controlled adjustment 38  
Timeout 170  
Tolerances 104, 107  
Touch screen 30  
Transporting over long distances 21  
Transporting over short distances 21  
Transporting the balance 21

**U**

Umgebungsbedingungen 173  
Underload 170  
Unpacking the balance 12  
User-specific settings 32  
User ID 168  
User profile 29, 31

**V**

Variable reference 129  
Volume 56

**W**

“Weighing” application 59  
Weighing in 159  
Weighing mode 53  
Weighing result 30  
Weighing unit 30, 63  
Weight display flashes 170  
Weight units 185  
Winter time 44

**Z**

Zeroing 28  
Zero point correction 53



**To protect your METTLER TOLEDO product's future:  
METTLER TOLEDO Service assures the quality, measuring accuracy  
and preservation of value of all METTLER TOLEDO products for years  
to come.**

**Please send for full details about our attractive terms of service.  
Thank you.**



Subject to technical changes and to changes in  
the accessories supplied with the instruments.

© Mettler-Toledo AG 2006 11780747C Printed in Switzerland 0612/2.12

**Mettler-Toledo AG, Laboratory & Weighing Technologies**, CH-8606 Greifensee, Switzerland  
Phone +41-44-944 22 11, Fax +41-44-944 30 60, Internet: <http://www.mt.com>