

METTLER TOLEDO

Table of Contents

1	Introduction	7
2	Safety Measures	8
	2.1	Definition of signal warnings and symbols 8
	2.2	Product specific safety notes 8
3	Design and Function	11
	3.1	Overview 11
	3.2	Sensor connection 11
	3.3	T-Pad and hard keys 11
	3.4	Interface connection 13
	3.5	Display icons 13
	3.6	LED 15
	3.7	Acoustic signal 15
4	Putting into Operation	16
	4.1	Scope of Delivery 16
	4.2	Installing the batteries 17
	4.3	Installing power supply 18
	4.4	Connecting sensors 19
	4.5	Installing optional equipment 20
	4.5.1	Electrode holder 20
	4.5.2	Meter base stabilizing unit 20
	4.5.3	Wrist strap 21
	4.6	Switching the instrument on and off 22
	4.7	Instrument Setup 22
	4.7.1	Data storage 23
	4.7.1.1	Storage mode 23
	4.7.1.2	Storage destination 23
	4.7.2	System settings 24
	4.7.2.1	Language 24
	4.7.2.2	Time and date 24
	4.7.2.3	Access control 24
	4.7.2.4	Sounds and visuals 25
	4.7.2.5	User modes 25
	4.7.2.6	Power management 26
	4.7.3	Factory reset 26
	4.7.4	Instrument self-test 26
5	Instrument Setup	27
	5.1	Data storage 27
	5.1.1	Storage mode 27
	5.1.2	Storage destination 27
	5.2	System settings 28
	5.2.1	Language 28
	5.2.2	Time and date 28
	5.2.3	Access control 28
	5.2.4	Sounds and visuals 29
	5.2.5	User modes 29
	5.2.6	Power management 30
	5.3	Factory reset 30
	5.4	Instrument self-test 30

6	Conductivity Settings		31
	6.1	Calibration settings	32
	6.1.1	Select a pre-defined conductivity standard	32
	6.1.2	Enter a customized conductivity standard	33
	6.1.3	Enter a cell constant	33
	6.1.4	Calibration reminder	33
	6.2	Measurement settings	35
	6.2.1	Reference Temperature	35
	6.2.2	Temperature Correction	35
	6.2.3	TDS factor	36
	6.2.4	Conductivity unit	36
	6.2.5	Conductivity Ash	37
	6.3	Endpoint type	38
	6.4	Interval readings	38
	6.5	Temperature settings	39
	6.6	Measurement limits	39
7	IDs		40
	7.1	Sample ID	40
	7.2	User ID	40
	7.3	Sensor ID	41
8	Sensor Calibration		42
9	Sample Measurement		43
	9.1	Selecting a measurement unit	43
	9.2	Performing a conductivity measurement	43
	9.3	Performing a TDS measurement	44
	9.4	Performing a salinity measurement	45
	9.5	Performing a resistivity measurement	46
	9.6	Performing a conductivity ash measurement	47
	9.7	Performing a measurement with interval reading	48
10	Data Management		49
	10.1	Data menu structure	49
	10.2	Measurement data	49
	10.3	Calibration data	50
	10.4	ISM data	50
	10.5	Data export to PC	51
11	Maintenance		52
	11.1	Software update	52
	11.2	Repair of the instrument	52
	11.3	Disposal	52
12	Product Portfolio		53
	12.1	Meter and kit versions	53
	12.2	Accessories	54
13	Technical Data		55

14	Appendix		57
14.1	Conductivity standards		57
14.2	Temperature correction factors		58
14.3	Temperature coefficients (alpha-values)		59
14.4	Practical salinity scale (UNESCO 1978)		59
14.5	Conductivity to TDS conversion factors		59
14.6	USP/EP tables		60
14.7	Conductivity ash methods		60
14.7.1	Refined sugar (28 g/100 g solution) ICUMSA GS2/3-17		60
14.7.2	Raw sugar or molasses (5 g / 100 mL solution) ICUMSA GS 1/3/4/7/8-13		60

1 Introduction

Thank you for purchasing this high quality METTLER TOLEDO portable meter. Everywhere you measure pH, conductivity or dissolved oxygen - the Seven2Go™ portables are designed to offer you fast quality data, one-handed operation and an investment that lasts. Whether you work in the laboratory, at-line or outdoors, the Seven2Go™ meters will provide you with high quality measurement everywhere you go. The Seven2Go™ offers many exciting features, including:

- Simple and intuitive menus that shorten steps needed for setting up measurements and calibration
- T-pad hard keys for comfortable and fast navigation
- Rubber side-guards for comfortable, one-handed operation
- IP67 rating for the entire measurement system, including meter, sensor and the connection cables
- Useful accessories such as the electrode clip, the meter base stabilizing unit, the wrist strap and the uGo™ carrying case with hermetically sealed interior for easy cleaning

2 Safety Measures

2.1 Definition of signal warnings and symbols

Safety notes are marked with signal words and warning symbols. These show safety issues and warnings. Ignoring the safety notes may lead to personal injury, damage to the instrument, malfunctions and false results.

Signal words

WARNING	for a hazardous situation with medium risk, possibly resulting in severe injuries or death if not avoided.
CAUTION	for a hazardous situation with low risk, resulting in damage to the device or the property or in loss of data, or minor or medium injuries if not avoided.
Attention	(no symbol) for important information about the product.
Note	(no symbol) for useful information about the product.

Warning symbols



General hazard



Toxic substance



Inflammable or explosive substance

2.2 Product specific safety notes

Your instrument represents state-of-the-art technology and complies with all recognized safety rules, however, certain hazards may arise in extraneous circumstances. Do not open the housing of the instrument; it does not contain any parts that can be maintained, repaired or replaced by the user. If you ever have problems with your instrument, contact your authorized METTLER TOLEDO dealer or service representative.

Intended use



This instrument is designed for a wide range of applications in various areas and is suitable for measuring pH (S2, S8), conductivity (S3, S7) or dissolved oxygen (S4, S9).

The use therefore requires knowledge and experience in working with toxic and caustic substances as well as knowledge and experience working with application-specific reagents, which may be toxic or hazardous.

The manufacturer shall not be held liable for any damage resulting from incorrect usage divergent to the operating instructions. Furthermore, the manufacturer's technical specifications and limits must be adhered to at all times and in no way exceeded.

Location



The instrument has been developed for indoor and outdoor operation and may not be used in explosive environments.

Use the instrument in a location which is suitable for the operation, protected from direct sunlight and corrosive gases. Avoid powerful vibrations, excessive temperature fluctuations and temperatures below 0 °C and above 40 °C.

Protective Clothing

It is advisable to wear protective clothing in the laboratory when working with hazardous or toxic substances.



A lab coat should be worn.



Suitable eye protection such as goggles should be worn.



Use appropriate gloves when handling chemicals or hazardous substances, checking their integrity before use.

Safety notes



WARNING

Chemicals

All relevant safety measures are to be observed when working with chemicals.

- a) Set up the instrument in a well-ventilated location.
 - b) Any spills should be wiped off immediately.
 - c) When using chemicals and solvents, comply with the instructions of the producer and the general lab safety rules.
-



WARNING

Flammable solvents

All relevant safety measures must be observed when working with flammable solvents and chemicals.

- a) Keep all sources of flame away from the workplace.
 - b) When using chemicals and solvents, comply with the instructions of the producer and the general lab safety rules.
-

FCC Rules

This device complies with Part 15 of the FCC Rules and Radio Interference Requirements of the Canadian Department of Communications. Operation is subject to the following conditions: (1) this device may not cause harmful interference, and (2) this device must accept any interference received, including interference that may cause undesired operation.

This equipment has been tested and found to comply with the limits for a Class A digital device, pursuant to Part 15 of the FCC rules. These limits are designed to provide reasonable protection against harmful interference when the equipment is operated in a commercial environment. This equipment generates, uses, and can radiate radio frequency energy and, if not installed and used in accordance with the instruction manual, may cause harmful interference to radio communications. Operation of this equipment in a residential area is likely to cause harmful interference in which case the user will be required to correct the interference at his own expense.

3 Design and Function

3.1 Overview

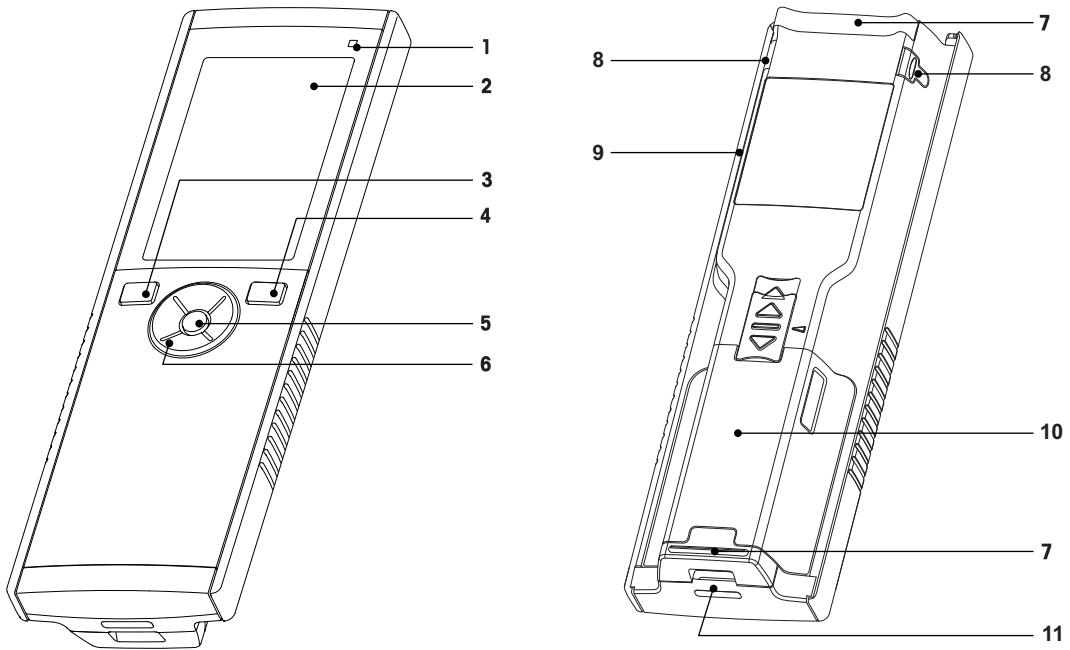

- | | |
|---|---|
| <ul style="list-style-type: none"> 1 Status LED (only Pro-series) 2 Display 3 Calibration key 4 On/Off key 5 Read key 6 T-Pad | <ul style="list-style-type: none"> 7 Rubber feet 8 Fixing points for electrode holder 9 Micro-USB port (only Pro-series) 10 Battery compartment 11 Slot for wrist strap |
|---|---|

3.2 Sensor connection

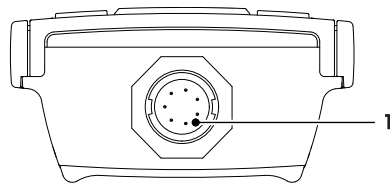



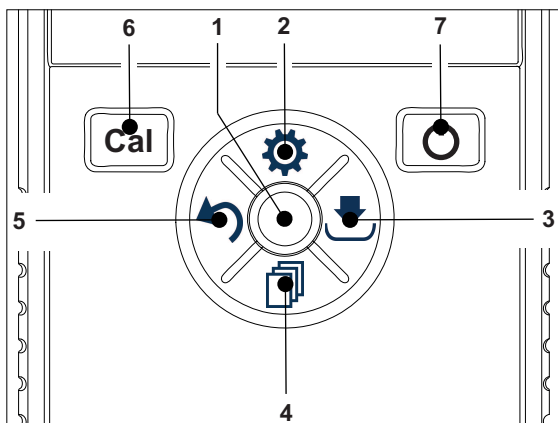

- 1** LTW socket for conductivity and temperature signal input





3.3 T-Pad and hard keys







In standard screen

	Key	Press and release	Press and hold
1	Read	Start and manually stop a measurement	Activate/Deactivate uFocus™
2	Settings / Up 	Open setup menu	---
3	Store / Right 	Save last measurement data	---
4	Mode / Down 	Switch measurement mode	---
5	Recall / Left 	Recall measurement data	---
6	Cal	Enter calibration mode	Recall last calibration result
7	On / Off 	---	Switch instrument on (hold for 1 second) or off (hold for 3 seconds)

In calibration mode (indicated by)

	Key	Press and release	Press and hold
1	Read	Start and manually stop calibration Save calibration result	---
2	Settings / Up 	---	---
3	Store / Right 	---	---
4	Mode / Down 	---	---
5	Recall / Left 	Discard calibration result	Exit calibration mode
6	Cal	---	---
7	On / Off 	---	---

Settings and data menu

	Key	Press and release	Press and hold
1	Read	Select submenu Confirm setting	Exit menu
2	Settings / Up 	Edit value (increase) Navigate between menu points	Fast value increase
3	Store / Right 	Navigate between menu tabs (only in top level per tab)	---
4	Mode / Down 	Edit value (decrease) Navigate between menu points	Fast value decrease
5	Recall / Left 	Navigate between menu tabs (only in top level per tab) One level up (if not in top level) Move left (in input fields)	One level up (if entering value into input field)
6	Cal	---	---
7	On / Off 	---	---

3.4 Interface connection

The Micro-USB interface can be used for data transfer to a connected PC (LabX direct software) and for external power supply. It is not possible to charge the batteries.

- 1 Micro-USB port

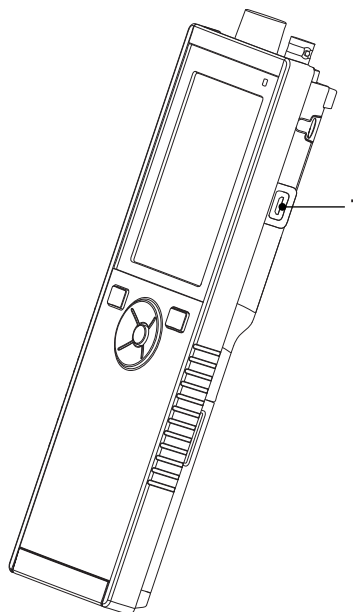







See also

- Installing power supply (page 18)

3.5 Display icons

Icon	Description
	Power status ■ 100% (fully charged) ■ 75% ■ 50% ■ 25% ■ 0% (fully discharged) ⚡ External power supply connected (USB)
	USB-PC connection
	User mode R Routine E Expert O Outdoor
	Storage mode A Automatic M Manual
	Interval Reading is on
	GLP format is used
	ISM sensor has been detected and is properly connected
	Warning / Error occurred

Icon	Description
	Sample ID
	Calibration standard
	User ID
	Sensor ID
	Endpoint type \overline{A} Automatic $\overline{A}T$ Timed $\overline{A}M$ Manual
	Wait icon

3.6 LED

To use the LED, it has to be enabled in the instrument setup, see section Sounds and visuals (page 25). The LED indicates different information of the device:

- Alarm Messages
- Measurement endpoint
- System Info

Instrument State	LED green	LED red	LED orange	Meaning
Instrument turn ON	On for 5 s			<ul style="list-style-type: none"> • Instrument boot up
		Blinking		<ul style="list-style-type: none"> • Instrument has failed to boot correctly or failure after booting • Error message appears
Instrument running without calibration or measurement in progress		Blinking		<ul style="list-style-type: none"> • Calibration has expired and user has defined instrument to be blocked if sensor expires - error message displayed • Any other error occurred and is displayed
Measurement Mode	Pulsing			<ul style="list-style-type: none"> • Measurement in progress
	Solid			<ul style="list-style-type: none"> • Measurement complete
		Blinking		<ul style="list-style-type: none"> • Measurement outside limits • Error occurred
Calibration Mode	Pulsing			<ul style="list-style-type: none"> • Calibration in progress
	Solid			<ul style="list-style-type: none"> • Calibration complete
		Blinking		<ul style="list-style-type: none"> • Calibration not successful • Error occurred
Data Transfer	Pulsing			<ul style="list-style-type: none"> • Data transfer in progress
	Solid			<ul style="list-style-type: none"> • Data transfer complete
		Blinking		<ul style="list-style-type: none"> • Data transfer not successful • Error occurred
Sleep Mode			Solid	<ul style="list-style-type: none"> • Meter in Sleep Mode • Press On/Off to re-activate meter

3.7 Acoustic signal

To use the acoustic signals, they have to be enabled in the instrument setup (see section Sounds and visuals (page 25)). You can enable or disable the acoustic signal for the following features:

- Keypress
- Alarm Messages
- Measurement endpoint

4 Putting into Operation

4.1 Scope of Delivery

Check the completeness of the delivery. The following parts belong to the standard equipment of your new instrument. Further parts may be included depending on the ordered kit versions.

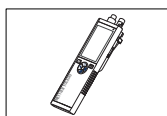

S7 instrument
for conductivity measurement

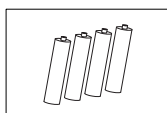

Battery LR3/AA 1.5V
4 pcs.

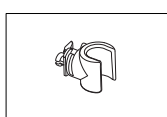

Electrode holder

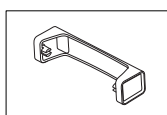

Meter base unit

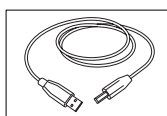

USB-A to micro-USB cable for connection to PC,
length = 1 m

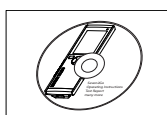

CD-ROM including operating instructions

4.2 Installing the batteries

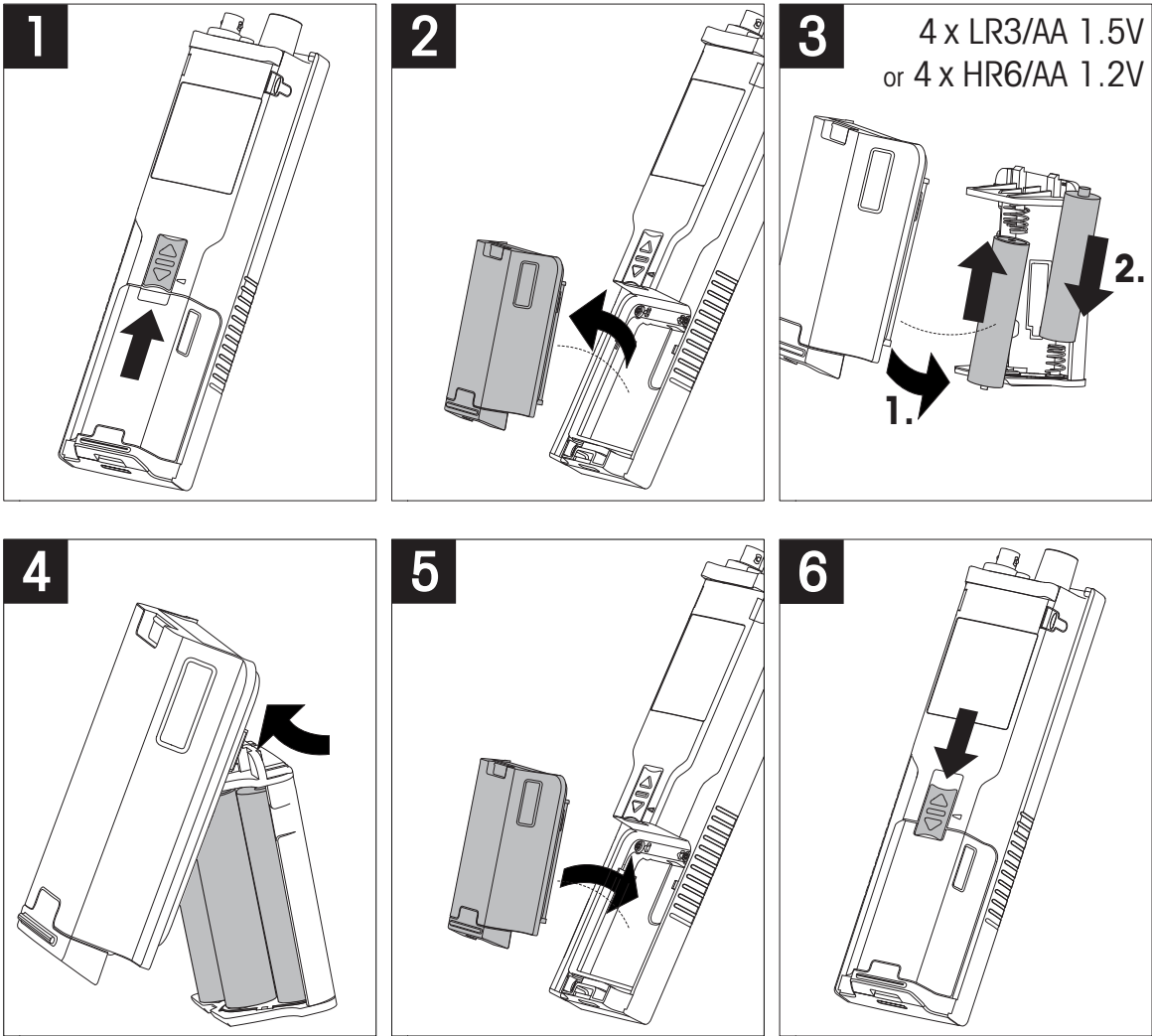

4.3 Installing power supply

The instrument is not supplied with an AC adapter.

Alternatively, the instrument can be supplied by an external power supply unit (not included in the scope of delivery) via the Micro-USB socket. Use an AC adapter that is suitable for all line voltages in the range of 100 to 240 V, 50/60 Hz and incorporates a USB socket. For connection, a suitable USB cable with an Micro-USB plug is required.

While the instrument is powered by the external power supply, the batteries are not being used. The icon  is shown on the screen.

Attention

- Take care that the AC adapter does not come into contact with liquids!
- The power plug must be accessible at all times!

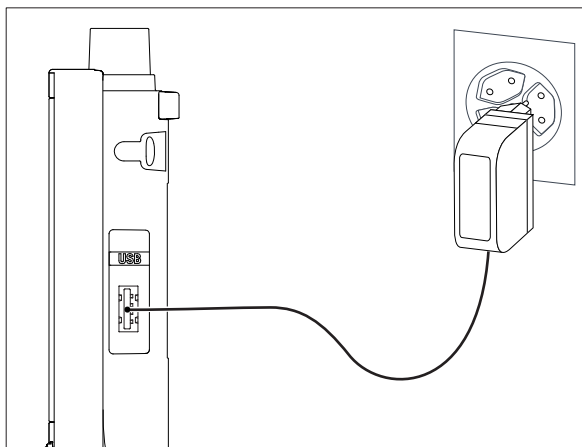

- 1 Connect the cable of the AC adapter with the Micro-USB socket of the instrument.
- 2 Plug the AC adapter into the wall socket.

4.4 Connecting sensors

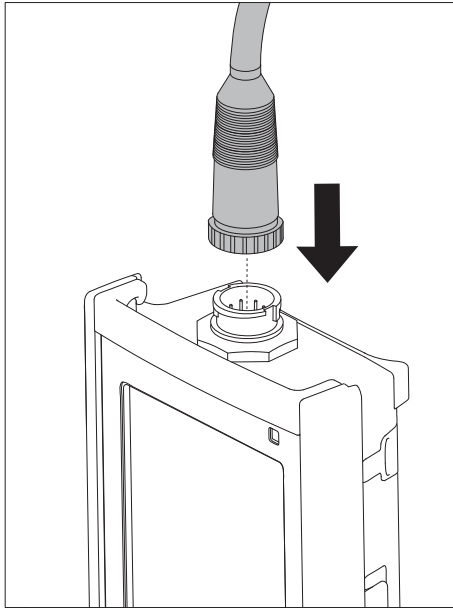

ISM® sensor

When connecting an ISM® sensor to the meter, one of the following conditions have to be met for the calibration data to be transferred automatically from the chip of the sensor into the meter and is used for further measurements. After attaching the ISM® sensor ...

- The meter must be switched on.
- (If the meter is already switched on) the **READ** key is pressed.
- (If the meter is already switched on) the **CAL** key is pressed.

We strongly recommend you to switch off the meter when disconnecting an ISM sensor. In doing so, you make sure that the sensor is not removed while the instrument is reading data from or writing data to the ISM-chip of the sensor.

The **ISM** icon  appears on the display and the sensor ID of the sensor chip is registered and appears on the display.

The calibration history, the initial certificate and the maximum temperature can be reviewed and printed in the data memory.

4.5 Installing optional equipment

4.5.1 Electrode holder

For a safe placing of the electrode you can mount an electrode holder on the side of the instrument. The electrode holder is part of delivery. You can mount it on either sides of the instrument for your personal handling.

- 1 Remove the protective clips (1).

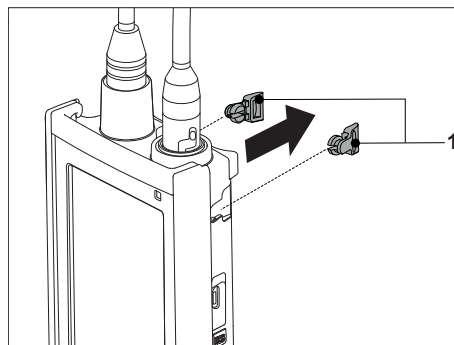

- 2 Push the electrode holder (1) into the recess (2) of the instrument.

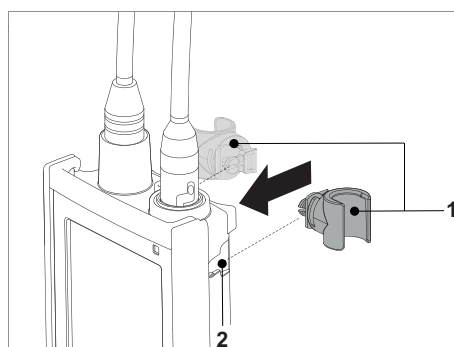

4.5.2 Meter base stabilizing unit

The meter base stabilizing unit should be mounted when using the instrument on a desk. It ensures a more firm and secure stand when pressing the keys.

- 1 Remove the protective clips (1).

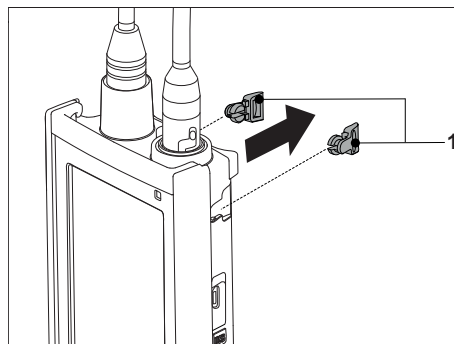

- 2 Push the meter base stabilizing unit (1) into the recesses (2) of the instrument.

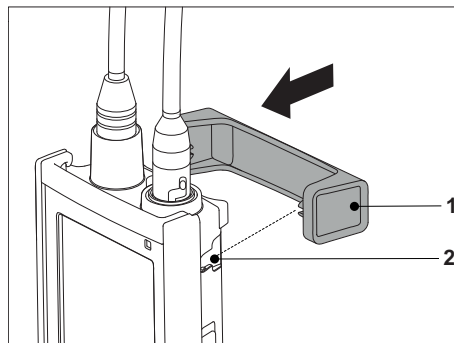

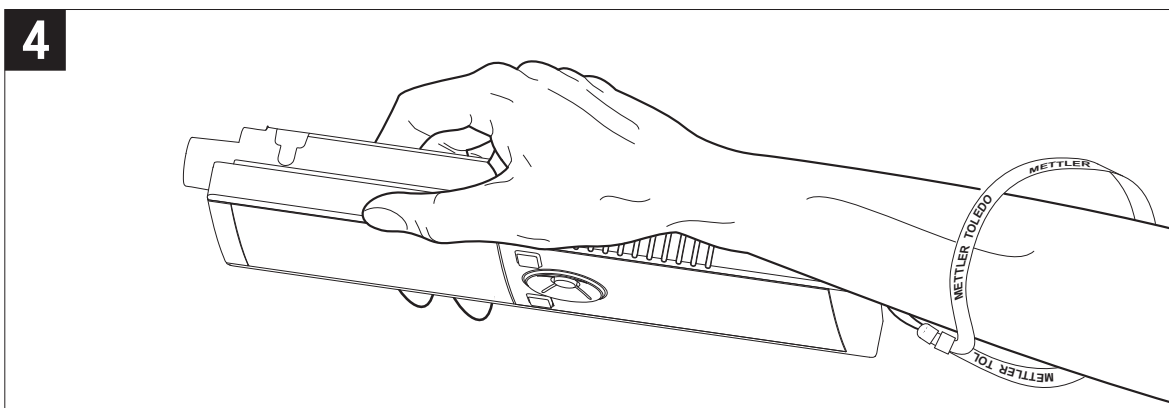
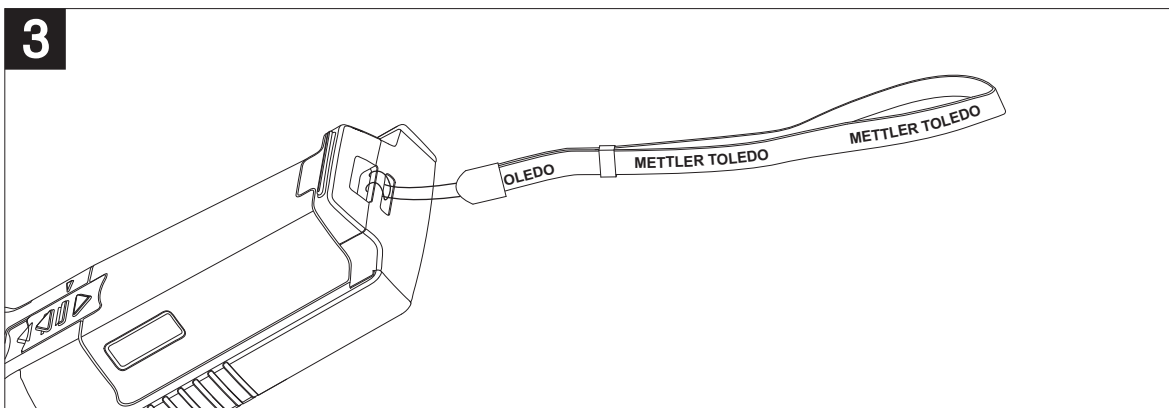
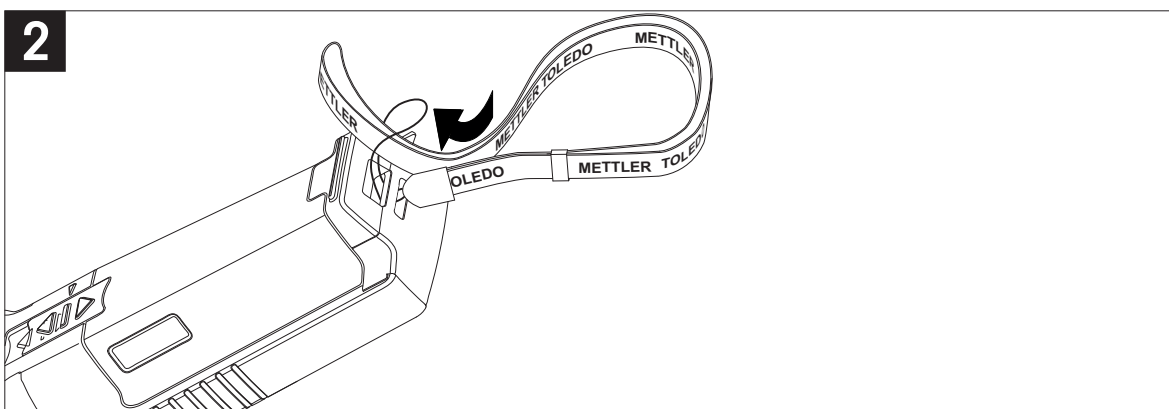
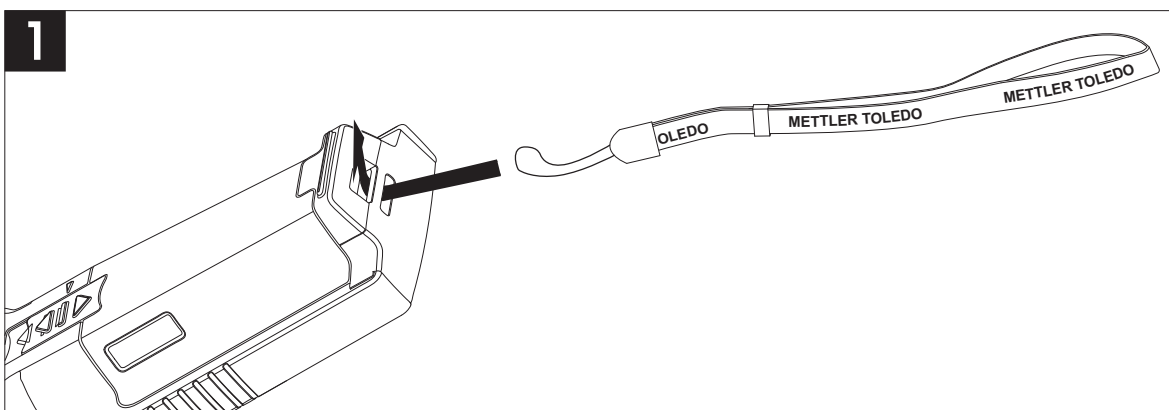

4.5.3 Wrist strap

For better protection against damage caused by dropping, you can mount the wrist strap as shown in the following diagrams.



4.6 Switching the instrument on and off

- 1 Press  to switch on the instrument.
 - ⇒ The firmware version, the serial number and the current date are displayed for about 5 seconds. After that the instrument is ready for use.
- 2 Press  for 3 seconds and release to switch off the instrument.

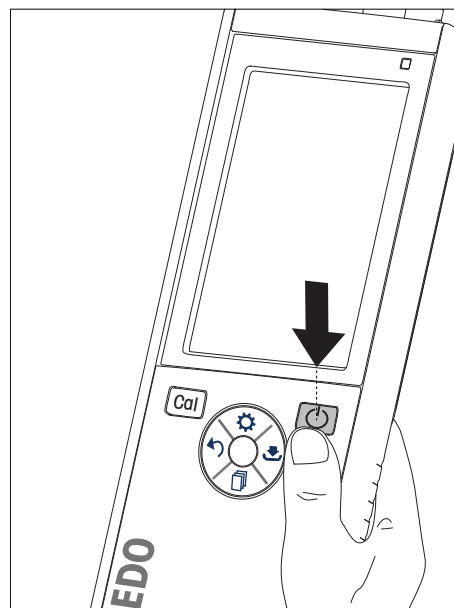



Note

- By default after 10 minutes not in use, the instrument changes to sleep mode. This can be changed in the setup.
- When starting the meter for the first time, the display for entering time and date appears automatically. These settings can be changed later again.

See also

- Power management (page 26)
- Time and date (page 24)

4.7 Instrument Setup

- 1 Press  to enter the menu.
- 2 Go to .

Menu structure

1.	Data Storage
1.1	Storage Mode
1.1.1	Automatic Storage
1.1.2	Manual Storage
1.2	Storage Destination
1.2.1	Memory
1.2.2	LabX Direct
1.2.3	Memory + LabX Direct
2.	System Settings
2.1	Language
2.2	Time and Date
2.3	Access Control
2.4	Sounds & Visuals
2.5	User Mode
2.6	Power Management
3.	Factory Reset
4.	Instrument Self-test

4.7.1 Data storage

4.7.1.1 Storage mode

- **Automatic storage:**
In this storage mode, all measurement results are getting saved automatically to the selected storage destination.
- **Manual storage:**
In this mode, the user has to save a measurement result manually by pressing . For this, the user gets a message on the display after every measurement.

4.7.1.2 Storage destination

There are different possibilities to store the measurement results. The Seven2Go pro meter provides 2000 internal memory locations (**M0001 - M2000**).

- **Memory:**
The measurement results are saved in the internal memory.
- **LabX Direct:**
The measurement results are transferred only to LabX Direct. For this a PC connection via USB is required. The PC software LabX®direct must be setup accordingly.
- **Memory + LabX Direct:**
The measurement results are saved in the internal memory and transferred to LabX®Direct. For this a PC connection via USB is required. The PC software LabX®direct must be setup accordingly.

4.7.2 System settings

4.7.2.1 Language

The following languages are available for the system:

- English
- German
- French
- Spanish
- Italian
- Portuguese
- Polish
- Russian
- Chinese
- Japanese
- Korean
- Thai

4.7.2.2 Time and date

When starting the meter for the first time, the display for entering time and date appears automatically. In the system settings, two time and four date display formats are available:

- **Time**
 - 24-hour format (for example, 06:56 and 18:56)
 - 12-hour format (for example, 06:56 AM and 06:56 PM)
- **Date**
 - 28-11-2013 (day-month-year)
 - 11-28-2013 (month-day-year)
 - 28-Nov-2013 (day-month-year)
 - 28/11/2013 (day-month-year)

4.7.2.3 Access control

PIN settings are available for:

- **System Settings**
- **Deletion of Data**
- **Instrument Login**

A maximum of 6 characters can be entered as PIN. When enabling an access control, the PIN must be defined and re-entered for verification.

Note

- Access control for system settings cannot be disabled as long as the instrument is operated in routine mode!

See also

- User modes (page 25,29)

4.7.2.4 Sounds and visuals

An acoustic signal can be switched on or off for the following three cases:

- Key is pressed
- Alarm/warning message appears
- Measurement is stable and has endpointed (stability signal appears)

The LED can be switched on or off for the following three cases:

- Alarm message
- Measurement endpoint
- System info

4.7.2.5 User modes

The meter has three user modes:

Routine Mode:

Limited access rights. The user can only perform measurements, calibrations, review results and change basic settings. The concept of the routine mode is a GLP feature which ensures that important settings and stored data cannot be deleted or unintentionally changed. The following operations are blocked in routine mode:

- Deletion of data
- Measurement and Calibration settings (except choosing reference temperature)
- Create sensor ID
- Factory reset
- Instrument self-test
- System settings can be accessed by entering PIN code (by default 000000)

Expert Mode:

The factory default setting enables all functions of the meter.

Outdoor Mode:

The user has full access rights (like in expert mode). The screen is always in uFocus view and the following parameters are set to specific values to reduce battery consumption:

- Auto dimming after 20 s
- Auto shutdown after 10 min
- All LED signals off

4.7.2.6 Power management

Screen Brightness:

The screen brightness can be set from levels 1 to 16.

Auto Dimming:

You can activate the auto dimming function for power saving. For this you can define a time period from 5 - 300 s. This is the time when the period backlight is switched off after the instrument is not in use.

Energy Saving:

You can activate either auto sleep or auto shutdown for saving energy.

Auto Sleep

The instrument changes into the sleep modus (standby) after a defined time of not in use. The instrument does not shut down automatically. You can define a time period between 5 - 99 minutes. The orange LED light indicates that the instrument currently is in sleep mode. Press  to activate the meter.

Auto Shutdown

The instrument shuts down automatically after a defined time of not in use. You can define a time period between 5 - 99 minutes.





4.7.3 Factory reset



Note



Loss of data!

With a factory reset all settings will be set to default values and all data memories will be deleted.



- 1 Press  to enter the setup menu.
- 2 Go to  > **Factory Reset**.
- 3 Press **Read** to confirm the factory reset or press  to cancel.
 - ⇒ When confirmed, all settings have default values and the memory is fully cleared.
- 4 Press and hold  to exit the setup menu.

4.7.4 Instrument self-test

The instrument self-test allows to check if display, LED, beep and keys are working correctly.

- 1 Press  to enter the setup menu.
- 2 Go to  > **Instrument Self-test**.
- 3 Press **Read** to start the self-test.
 - ⇒ **Display:** All pixels of the display are shown black for 2 seconds, then white for 2 seconds.
 - ⇒ **LED:** The LED changes color to green, orange and flashing red.
 - ⇒ **Beep and keys:** The icons for the seven keys are shown on the screen, each keypress lets its icon disappear while a beep sounds. The keys must be pressed within 20 seconds.
- ⇒ If the self-test is successful, **OK** appears on the screen and the LED is green for 2 seconds. Otherwise **Self-test failure** appears and the LED flashes red. In both cases the instrument then goes back to normal mode.

5 Instrument Setup

- 1 Press  to enter the menu.
- 2 Go to .

Menu structure

1.	Data Storage
1.1	Storage Mode
1.1.1	Automatic Storage
1.1.2	Manual Storage
1.2	Storage Destination
1.2.1	Memory
1.2.2	LabX Direct
1.2.3	Memory + LabX Direct
2.	System Settings
2.1	Language
2.2	Time and Date
2.3	Access Control
2.4	Sounds & Visuals
2.5	User Mode
2.6	Power Management
3.	Factory Reset
4.	Instrument Self-test

5.1 Data storage

5.1.1 Storage mode

- **Automatic storage:**
In this storage mode, all measurement results are getting saved automatically to the selected storage destination.
- **Manual storage:**
In this mode, the user has to save a measurement result manually by pressing . For this, the user gets a message on the display after every measurement.

5.1.2 Storage destination

There are different possibilities to store the measurement results. The Seven2Go pro meter provides 2000 internal memory locations (**M0001 - M2000**).

- **Memory:**
The measurement results are saved in the internal memory.
- **LabX Direct:**
The measurement results are transferred only to LabX Direct. For this a PC connection via USB is required. The PC software LabX®direct must be setup accordingly.
- **Memory + LabX Direct:**
The measurement results are saved in the internal memory and transferred to LabX®Direct. For this a PC connection via USB is required. The PC software LabX®direct must be setup accordingly.

5.2 System settings

5.2.1 Language

The following languages are available for the system:

- English
- German
- French
- Spanish
- Italian
- Portuguese
- Polish
- Russian
- Chinese
- Japanese
- Korean
- Thai

5.2.2 Time and date

When starting the meter for the first time, the display for entering time and date appears automatically. In the system settings, two time and four date display formats are available:

- **Time**
 - 24-hour format (for example, 06:56 and 18:56)
 - 12-hour format (for example, 06:56 AM and 06:56 PM)
- **Date**
 - 28-11-2013 (day-month-year)
 - 11-28-2013 (month-day-year)
 - 28-Nov-2013 (day-month-year)
 - 28/11/2013 (day-month-year)

5.2.3 Access control

PIN settings are available for:

- **System Settings**
- **Deletion of Data**
- **Instrument Login**

A maximum of 6 characters can be entered as PIN. When enabling an access control, the PIN must be defined and re-entered for verification.

Note

- Access control for system settings cannot be disabled as long as the instrument is operated in routine mode!

See also

- User modes (page 25)

5.2.4 Sounds and visuals

An acoustic signal can be switched on or off for the following three cases:

- Key is pressed
- Alarm/warning message appears
- Measurement is stable and has endpointed (stability signal appears)

The LED can be switched on or off for the following three cases:

- Alarm message
- Measurement endpoint
- System info

5.2.5 User modes

The meter has three user modes:

Routine Mode:

Limited access rights. The user can only perform measurements, calibrations, review results and change basic settings. The concept of the routine mode is a GLP feature which ensures that important settings and stored data cannot be deleted or unintentionally changed. The following operations are blocked in routine mode:

- Deletion of data
- Measurement and Calibration settings (except choosing reference temperature)
- Create sensor ID
- Factory reset
- Instrument self-test
- System settings can be accessed by entering PIN code (by default 000000)

Expert Mode:

The factory default setting enables all functions of the meter.

Outdoor Mode:

The user has full access rights (like in expert mode). The screen is always in uFocus view and the following parameters are set to specific values to reduce battery consumption:

- Auto dimming after 20 s
- Auto shutdown after 10 min
- All LED signals off

5.2.6 Power management

Screen Brightness:

The screen brightness can be set from levels 1 to 16.

Auto Dimming:

You can activate the auto dimming function for power saving. For this you can define a time period from 5 - 300 s. This is the time when the period backlight is switched off after the instrument is not in use.

Energy Saving:

You can activate either auto sleep or auto shutdown for saving energy.

Auto Sleep

The instrument changes into the sleep modus (standby) after a defined time of not in use. The instrument does not shut down automatically. You can define a time period between 5 - 99 minutes. The orange LED light indicates that the instrument currently is in sleep mode. Press  to activate the meter.

Auto Shutdown

The instrument shuts down automatically after a defined time of not in use. You can define a time period between 5 - 99 minutes.





5.3 Factory reset



Note



Loss of data!

With a factory reset all settings will be set to default values and all data memories will be deleted.

- 1 Press  to enter the setup menu.
- 2 Go to  > **Factory Reset**.
- 3 Press **Read** to confirm the factory reset or press  to cancel.
 - ⇒ When confirmed, all settings have default values and the memory is fully cleared.
- 4 Press and hold  to exit the setup menu.

5.4 Instrument self-test

The instrument self-test allows to check if display, LED, beep and keys are working correctly.

- 1 Press  to enter the setup menu.
 - 2 Go to  > **Instrument Self-test**.
 - 3 Press **Read** to start the self-test.
 - ⇒ **Display:** All pixels of the display are shown black for 2 seconds, then white for 2 seconds.
 - ⇒ **LED:** The LED changes color to green, orange and flashing red.
 - ⇒ **Beep and keys:** The icons for the seven keys are shown on the screen, each keypress lets its icon disappear while a beep sounds. The keys must be pressed within 20 seconds.
- ⇒ If the self-test is successful, **OK** appears on the screen and the LED is green for 2 seconds. Otherwise **Self-test failure** appears and the LED flashes red. In both cases the instrument then goes back to normal mode.

6 Conductivity Settings

- 1 Press  to enter the menu.
- 2 Go to **Conductivity**.

Menu structure

1.	Calibration Settings
1.1	Calibration Standard
1.1.1	Predefined Standard
1.1.2	Customized Standard
1.1.3	Enter Cell Constant
1.2	Calibration Reminder
2.	Measurement Settings
2.1	Reference Temperature
2.2	Temperature Correction
2.3	TDS Factor
2.4	Conductivity Unit
2.5	Conductivity Ash
2.5.1	ICUMSA Method
2.5.2	Conductivity of Used Water
3.	Endpoint Type
4.	Interval Readings
5.	Temperature Settings
5.1	Set MTC Temperature
5.2	Temperature Unit
6.	Measurement Limits
6.1	Conductivity Limit
6.2	TDS Limit
6.3	Salinity Limit
6.4	Resistivity Limit
6.5	Conductivity Ash Limit
6.6	Temperature Limit

6.1 Calibration settings

6.1.1 Select a pre-defined conductivity standard

The following pre-defined international conductivity standards are available:

- 10 $\mu\text{S}/\text{cm}$
- 84 $\mu\text{S}/\text{cm}$
- 500 $\mu\text{S}/\text{cm}$
- 1413 $\mu\text{S}/\text{cm}$
- 12.88 mS/cm
- Saturated NaCl





The following pre-defined chinese conductivity standards are available:

- 146.5 $\mu\text{S}/\text{cm}$
- 1408 $\mu\text{S}/\text{cm}$
- 12.85 mS/cm
- 111.35 mS/cm

The following pre-defined japanese conductivity standards are available:

- 1330.00 $\mu\text{S}/\text{cm}$
- 133.00 $\mu\text{S}/\text{cm}$
- 26.6 $\mu\text{S}/\text{cm}$







Select a pre-defined standard:

- 1 Press  to enter the setup menu.
- 2 Go to **Conductivity > Calibration Settings > Calibration Standard > Predefined Standard**.
- 3 Select a standard using  and .
- 4 Press **Read** to confirm.
- 5 Press  to exit the calibration menu.
- 6 Press and hold  to exit the setup menu.

6.1.2 Enter a customized conductivity standard



This option is for users who would like to use their own conductivity standard for calibration of the conductivity sensor. Up to 5 temperature-dependent values (in mS/cm only) can be entered in the table. The lowest possible conductivity value is 0.00005 mS/cm (0.05 μ S/cm). This value corresponds to the conductivity of pure water at 25 °C, exclusively caused by the autoprotolysis of water. The highest value that can be entered is 200 mS/cm.

When switching from a predefined standard to customized standard, you should always save the table even if no values have changed.

- 1 Press  to enter the setup menu.
- 2 Go to **Conductivity > Calibration Settings > Calibration Standard > Customized Standard**.
 - ⇒ There are pre-defined values of a standard in the table which are all changeable.
- 3 Select a temperature value by using  and  and press **Read** to edit it.
- 4 Change the selected temperature digit by digit using the TPad keys and press **Read** to confirm.
- 5 Press  to navigate to the related calibration standard value and press **Read** to edit it.
- 6 Change the value digit by digit using the TPad keys and press **Read** to confirm.
- 7 Repeat steps 3 to 6 for all pairs of temperature and conductivity value.
 - To delete any value, press and hold **Read** in that field of the table.
 - Please note that the table must not have empty lines in-between but only at the end.
- 8 Go to **Save** and press **Read** to save your changes.
- 9 Press  to exit the calibration menu.
- 10 Press and hold  to exit the setup menu.



6.1.3 Enter a cell constant

If the cell constant of the conductivity cell being used is accurately known, it can be entered directly in the meter. A cell constant between 1.00000e-6 cm⁻¹ and 2.00000e+2 cm⁻¹ (corresponds to 0.000001 cm⁻¹ and 200 cm⁻¹). can be entered. In the calibration settings you only set the calibration option to entering the cell constant manually. The cell constant itself is entered during the normal calibration process instead of measuring in a calibration standard and it is saved per sensor ID.

- 1 Press  to enter the setup menu.
- 2 Go to **Conductivity > Calibration Settings > Calibration Standard > Enter Cell Constant** and press **Read**.
- 3 Press  to exit the calibration menu.
- 4 Press and hold  to exit the setup menu.
- 5 Press **Cal**.
- 6 Enter the cell constant digit by digit. Increase or decrease each value by using the TPad keys and press **Read** to confirm.
 - ⇒ The entered cell constant is displayed on the screen.

6.1.4 Calibration reminder

When the calibration reminder is activated, the user is reminded to perform a new calibration after a certain user-defined interval (maximum 9999 h) has elapsed.

- 1 Press  to enter the setup menu.
- 2 Go to **DO > Calibration Settings > Calibration Standard > Calibration Reminder**.
- 3 Choose **On** or **Off** by using  and .
- 4 Press **Read** to confirm.
 - ⇒ Another screen appears to enter the interval time.
- 5 Enter the interval time by using the TPad keys and press **Read** to save.
 - ⇒ Another screen appears to select calibration expiration date. Select as of when the sensor should be blocked for further measurements as soon as the entered interval has elapsed.





- ⇒ **Immediately:**
The meter is immediately blocked for measurement when the predefined interval has elapsed.
 - ⇒ **Exp: Reminder + 1 h:**
The meter is blocked for measurement 1 hour after the predefined interval has elapsed.
 - ⇒ **Exp: Reminder + 2 h:**
The meter is blocked for measurement 2 hours after the predefined interval has elapsed.
 - ⇒ **Continue Reading:**
The user can continue measuring when the predefined interval has elapsed.
- 6 Press **Read** to confirm.
 - 7 Press ↵.
 - 8 Press and hold ↵ to exit the setup menu.

6.2 Measurement settings

6.2.1 Reference Temperature

The following reference temperatures are available:

- 20 °C (68 °F)
- 25 °C (77 °F)

- 1 Press  to enter the setup menu.
- 2 Go to **Cond. > Measurement Settings > Reference Temperature**.
- 3 Choose the reference temperature by using  and  and press **Read**.
- 4 Press  to exit the measurement menu.
- 5 Press and hold  to exit the setup menu.

6.2.2 Temperature Correction

There are four options for temperature correction available:

- linear
- non-linear
- pure water
- off

With most solutions, a linear interrelationship between conductivity and temperature is given. In such cases, select the **linear correction** method. The conductivity of natural water shows strong non-linear temperature behavior. For this reason, use the **non-linear correction** for natural water. The option **pure water** should only be used for cases in which ultra-pure or pure water is measured.

In some cases, for example, when measuring according to USP/EP (United States/European Pharmacopoeia) you need to switch **off** the temperature correction.

Linear

When selecting linear correction, the input field for the temperature correction coefficient - also called alpha coefficient - appears. Values from 0.000 to 10.000 %/°C can be entered. The measured conductivity is corrected and displayed using the following formula:

$$GT_{\text{Ref}} = GT / (1 + (\alpha(T - T_{\text{Ref}})) / 100 \%)$$





- GT: conductivity measured at temperature T (mS/cm)
- GT_{Ref} : conductivity (mS/cm) displayed by the instrument, calculated back to the reference temperature T_{Ref}
- α : linear temperature correction coefficient (%/°C); $\alpha = 0$: no temperature correction
- T: measured temperature (°C)
- T_{Ref} : Reference temperature (20 °C or 25 °C)

Each sample has different temperature behavior. For pure salt solutions the correct coefficient can be found in literature, otherwise you need to determine the α -coefficient by measuring the conductivity of the sample at two temperatures and calculate the coefficient by using the following formula:

$$\alpha = (GT1 - GT2) * 100\% / (T1 - T2) / GT2$$

- T1: Typical sample temperature
- T2: Reference temperature
- GT1: Measured conductivity at typical sample temperature
- GT2: Measured conductivity at reference temperature

To enter the linear temperature correction follow these steps:

- 1 Press  to enter the setup menu.
- 2 Go to **Measurement Settings > Temperature Correction > Linear** and press **Read** to confirm.
- 3 Enter the α -coefficient (0.000 - 10.000) by using  and  and press **Read**.
- 4 Press  to exit the measurement menu.

5 Press and hold  to exit the setup menu.

Non-linear

The conductivity of natural water shows strong non-linear temperature behavior. For this reason, use the non-linear correction for natural water. The measured conductivity is multiplied by the factor f_{25} for the measured temperature (see appendix) and thus corrected to the reference temperature of 25 °C:

$$G_{T25} = GT \cdot f_{25}$$

If 20 °C is used as reference temperature, the conductivity corrected to 25 °C is divided by 1.116 (see f_{25} for 20.0 °C):

$$GT_{20} = (GT \cdot f_{25}) / 1.116$$

Note

- Conductivity measurements of natural water can only be performed at temperatures ranging from 0 °C to 36 °C. Otherwise, the warning message **Temp. out of conductivity ash correction range** appears.

Pure water





Similar to non-linear correction for natural water a different type of non-linear correction is used for ultra-pure and pure water. The values are compensated in the range from 0.005 to 5.00 µS/cm at temperatures (0-50 °C) that differ from the reference temperature (25 °C). This could for example be when checking the pure or ultra-pure water production equipment, or when checking if the cleaning-in-progress procedure for which ultra-pure water has been used had led to the removal of all soluble substances. Due to the high influence of CO₂ from the air, we strongly recommend to use a flow-through-cell for this type of measurements.

Note

- Conductivity measurements using the pure water compensation mode can only be performed at temperatures ranging from 0 °C to 50 °C. Otherwise, the warning message "Temp. out of pure water range" appears.
- In case the conductivity reading exceeds the upper limit of 5.00 µS/cm in the mode pure water, the compensation will resemble a linear compensation mode with $\alpha = 2.00 \text{ \%}/\text{°C}$.





6.2.3 TDS factor

TDS (Total dissolved solids) is calculated by multiplying the conductivity value in µS/cm with the TDS factor to get the concentration in mg/L or ppm. A factor between 0.40 and 1.00 can be entered. Please see appendix for some typical values for the TDS factor.

- 1 Press  to enter the setup menu.
- 2 Go to **Measurement Settings > TDS Factor**.
- 3 Enter the TDS factor (0.40 - 1.00) digit by digit using  and  and press **Read**.
- 4 Press  to exit the measurement menu.
- 5 Press and hold  to exit the setup menu.

6.2.4 Conductivity unit

Depending on your requirements to express the readings per centimeter or per meter, you can change the conductivity unit as follows:





- µS/cm and mS/cm
 - µS/m and mS/m
- 1 Press  to enter the setup menu.
 - 2 Go to **Cond. > Measurement Settings > Conductivity Unit**.
 - 3 Choose the unit by using  and  and press **Read**.
 - 4 Press  to exit the measurement menu.
 - 5 Press and hold  to exit the setup menu.

6.2.5 Conductivity Ash

Conductivity Ash (%) is an important parameter that reflects the content of soluble inorganic salts in refined sugar or raw sugar/melasses. These soluble inorganic impurities directly affect the purity of the sugar. This meter can measure conductivity ash according to the following two ICUMSA methods.

- 28 g/100 g solution (refined sugar - ICUMSA GS2/3-17)
- 5 g/100 mL solution (raw sugar – ICUMSA GS1/3/4/7/8-13)

The instrument will directly convert the measured conductivity to conductivity ash % according to the selected method. The user has the possibility to enter the conductivity of the used water for preparing the sugar solutions in $\mu\text{S}/\text{cm}$ (0.0 to 100.0 $\mu\text{S}/\text{cm}$). This value is then used for correcting the measured conductivity ash values according to the formulae given in the appendix.

- 1 Press  to enter the setup menu.
- 2 Go to **Measurement Settings > Conductivity Ash > ICUMSA Method**.
- 3 Use  and  to select the right method and confirm with Read.
- 4 Go to **Cond. of Used Water** Water.
- 5 Enter the conductivity of used water digit by digit using the TPad and press **Read** to save.
- 6 Press  to exit the measurement menu.
- 7 Press and hold  to exit the setup menu.



Note

- Conductivity ash measurements are only possible in the temperature range from 15 °C to 25 °C. Otherwise, the warning message ... appears.

6.3 Endpoint type



Auto Endpoint

With the automatic endpoint the meter defines the end of an individual reading depending on programmed stability criterion for the signal. This ensures an easy, quick and precise measurement.

- 1 Press  to enter the setup menu.
- 2 Go to **DO > Endpoint Type**.
- 3 Select **Auto EP** and press **Read** to confirm.
- 4 Press and hold  to exit the setup menu.



Manual Endpoint

In this mode, the user is required to stop the measurement reading manually.

- 1 Press  to enter the setup menu.
- 2 Go to **DO > Endpoint Type**.
- 3 Select **Manual EP** and press **Read** to confirm.
- 4 Press and hold  to exit the setup menu.

Timed Endpoint

The measurement stops after the defined time, which can be set between 5 s and 3600 s.



- 1 Press  to enter the setup menu.
- 2 Go to **DO > Endpoint Type**.
- 3 Select **Timed EP** and press **Read** to confirm.
- 4 Enter the measurement time digit by digit using the TPad keys and press **Read** to save.
- 5 Press and hold  to exit the setup menu.

6.4 Interval readings

A reading is taken every time after a certain interval (1 – 2400 s) defined in the menu has elapsed. The measurement series stops according to the selected endpoint format or manually by pressing **Read**. When timed-interval reading is **On**, ^{Int.} appears on the screen.

Example:



To measure the conductivity every 30 s during 5 min, set the interval time to 30 s and the endpoint type to timed with a measurement time of 5 min.

- 1 Press  to enter the setup menu.
- 2 Go to **DO > Interval Readings**.
- 3 Select **On** and press **Read** to confirm.
- 4 If interval readings has been enabled, enter the interval time digit by digit using the TPad keys.
- 5 Press **Read** save.
- 6 Press and hold  to exit the setup menu.

6.5 Temperature settings

Setting the temperature unit:

You can set the temperature unit to °C or °F.













- 1 Press  to enter the setup menu.
- 2 Go to **DO > Temperature Settings > Temperature Unit**.
- 3 Select the temperature unit and press **Read** to save.
- 4 Press .
- 5 Press and hold  to exit the setup menu.

6.6 Measurement limits

You can define limits (max. and min.) for every kind of measurement:

- **DO Limit**
- **Temperature Limit**

To set a measurement limit follow these steps:

- 1 Press  to enter the setup menu.
- 2 Go to **DO > Measurement Limits**.
- 3 Choose the desired measurement type by using  and  and press **Read** to confirm.
- 4 Select **Yes** to activate the limit and press **Read** to confirm.
- 5 Press **Read** to activate or deactivate the max. Limit.
- 6 Press  and then press **Read** to edit the max. limit value.
- 7 Change the max. limit value digit by digit using  and  and press **Read** to save.
- 8 Press  to switch to the min. limit.
- 9 Press **Read** to activate or deactivate the min. Limit.
- 10 Press  and then press **Read** to edit the min. limit value.
- 11 Change the min. limit value digit by digit using  and  and press **Read** to save.
- 12 Go to **Save** and press **Read** to save your settings.
- 13 Press .
- 14 Press and hold  to exit the setup menu.

7 IDs

- 1 Press  to enter the menu.
- 2 Go to **ID**.

Menu structure

1.	Sample ID
1.1	Enter Sample ID
1.2	Auto Sequential
1.3	Select Sample ID
1.4	Delete Sample ID
2.	User ID
2.1	Enter User ID
2.2	Select User ID
2.3	Delete User ID
3.	Sensor ID / SN
3.1	Enter Sensor ID / SN
3.2	Select Sensor ID

7.1 Sample ID

- 1 Press  to enter the setup menu.
- 2 Go to **ID Settings > Sample ID**.

Go to **Enter Sample ID** to enter a new sample ID. An alphanumeric sample ID with up to 12 characters can be entered.

Auto sequential:

1. **Auto Sequential = On**
Using this setting will automatically increment the sample ID by 1 for each reading. If the last character of the sample ID is not a number, then the number 1 will be added to the sample ID with the second sample. This requires the sample ID to have less than 12 characters.
2. **Auto Sequential = Off**
The sample ID is not incremented automatically.

To select a sample ID out of a list of already entered sample IDs, go to **Select Sample ID**. A maximum of 10 sample IDs are stored in memory and listed for selection. If the maximum of 10 has already been entered, either any sample ID is deleted manually or the oldest ID will automatically be overwritten by the new ID.

To delete an existing sample ID out of the list, go to **Delete Sample ID**. Choose the sample ID you want to delete and press **Read**.

7.2 User ID

- 1 Press  to enter the setup menu.
- 2 Go to **ID Settings > User ID**.

Select **Enter User ID** to enter a new user ID. An alphanumeric user ID with up to 12 characters can be entered.

To select a user ID out of the list, go to **Select User ID**. A maximum of 10 user IDs are stored in memory and listed for selection. If the maximum of 10 has already been entered, either a user ID is deleted manually or the oldest ID will automatically be overwritten by the new ID.

To delete an existing user ID out of the list, go to **Delete User ID**. Choose the user ID you want to delete and press **Read**.

7.3 Sensor ID

- 1 Press  to enter the setup menu.
- 2 Go to **ID Settings** > **Sensor ID / SN**.

Select **Enter Sensor ID / SN** to enter a new sensor ID and serial number (SN). An alphanumeric sensor ID and SN with up to 12 characters can be entered.

To select a sensor ID out of the list, go to **Select Sensor ID**. A maximum of 10 sensor IDs are stored in the memory and listed for selection. If the maximum of 10 has already been entered, the oldest ID will automatically be overwritten by the new ID.

Note

- To delete a sensor from the list, delete its calibration data, see section Calibration data (page 50).

8 Sensor Calibration

The following procedure only applies if a pre-defined or user-defined calibration standard is set. In case the cell constant has to be entered manually, a separate section is required:

- 1 Press **Cal**.
 - ⇒ An input field appears to enter the cell constant.
- 2 Increase or decrease the cell constant value digit by digit using the TPad keys and press **Read** to confirm.

Perform a sensor calibration:

- ▶ A sensor is connected to the instrument.
 - ▶ The correct calibration standard is defined in the settings (see section Calibration settings (page 32)).
- 1 Place the electrode in a calibration standard and press **Cal** to enter the calibration mode.
 - ⇒ μ appears on the display.
 - 2 Press **Read** to start the calibration.
 - ⇒ Depending on the set endpoint format, the letter **A** (auto), **T** (timed) or **M** (manual) is blinking during the calibration.
 - ⇒ When the endpoint is reached, the display freezes automatically. Independent on the set endpoint format, **Read** can be pressed to endpoint the calibration manually.
 - ⇒ The calibration result is displayed.
 - 3 Press **Read** to save the calibration data or press \leftarrow to cancel.

Note

- The second point required for the conductivity calibration curve is permanently programmed in the meter and is 0 S/m for a specific resistivity moving toward infinity. To ensure the most accurate conductivity readings, verify the cell constant with a standard solution regularly and recalibrate if necessary.

9 Sample Measurement



9.1 Selecting a measurement unit

With the S7 conductivity meter it is possible to measure the following parameters of a sample:

- Conductivity ($\mu\text{S}/\text{cm}$ and mS/cm)
The instrument will switch automatically to $\mu\text{S}/\text{m}$ and mS/m depending on the measurement value (e.g. conductivity of ethanol according to the ABNT/ABR 10547 method).
- TDS (mg/L)
- Salinity (psu)
- Resistivity ($\text{Ohm}\cdot\text{cm}$)
- Conductivity ash (%)

To change the measurement mode, press  as often as the desired appears.

9.2 Performing a conductivity measurement

- ▶ An sensor is connected to the instrument.
 - ▶ The sensor is calibrated.
 - ▶ The following measurement settings are done:
 - Reference temperature
 - Temperature correction method
 - Conductivity unit
 - Endpoint type
 - Data storage mode and location
- 1 Press  once or several times to switch between the measurement modes until a conductivity unit ($\mu\text{S}/\text{cm}$, mS/cm , $\mu\text{S}/\text{m}$, mS/m) is displayed.
 - 2 Place the sensor into the sample and press **Read** to start the measurement.
 - ⇒ The decimal point and - depending on the endpoint format setting - **A** (automatic), **T** (timed) or **M** (manual) are blinking during the measurement.
 - 3 When the measurement has endpointed, the display freezes. Independent on the set endpoint format, **Read** can be pressed to endpoint the measurement manually.
 - ⇒ The measurement result is displayed.
 - ⇒ If Data Storage Mode is set to **Automatic Storage**, the complete measurement data is automatically transferred to the set storage destination.
 - 4 If Data Storage Mode is set to **Manual Storage**, press  to transfer the data to the set storage location.

Information on the display:

The following symbols appear on the display, depending on the endpoint setting.

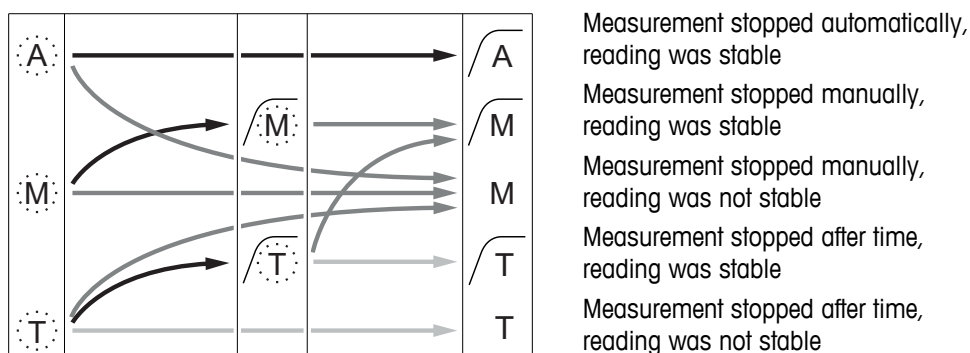

 Defined measurement time elapsed



 User presses **Read**

 Signal becomes stable

See also

- Measurement settings (page 35)

9.3 Performing a TDS measurement

- ▶ A sensor is connected to the instrument.
 - ▶ The sensor is calibrated.
 - ▶ The following measurement settings are done:
 - Reference temperature
 - Temperature correction method
 - TDS factor
 - Endpoint type
 - Data storage mode and location
- 1 Press  once or several times to switch between the measurement modes until the unit mg/L or g/L is displayed.
 - 2 Place the sensor into the sample and press **Read** to start the measurement.
 - ⇒ The decimal point and - depending on the endpoint format setting - **A** (automatic), **T** (timed) or **M** (manual) are blinking during the measurement.
 - 3 When the measurement has endpointed, the display freezes. Independent on the set endpoint format, **Read** can be pressed to endpoint the measurement manually.
 - ⇒ The measurement result is displayed.
 - ⇒ If Data Storage Mode is set to **Automatic Storage**, the complete measurement data is automatically transferred to the set storage destination.
 - 4 If Data Storage Mode is set to **Manual Storage**, press  to transfer the data to the set storage location.

Information on the display:

The following symbols appear on the display, depending on the endpoint setting.

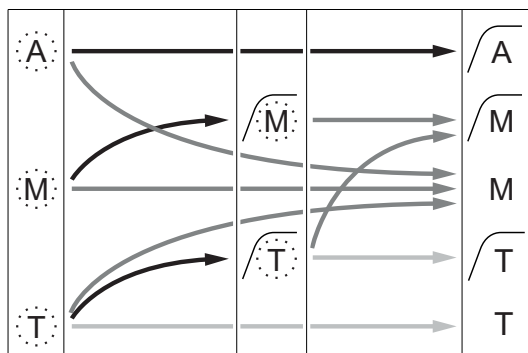



- Measurement stopped automatically, reading was stable
- Measurement stopped manually, reading was stable
- Measurement stopped manually, reading was not stable
- Measurement stopped after time, reading was stable
- Measurement stopped after time, reading was not stable

- Defined measurement time elapsed
- User presses **Read**
- Signal becomes stable

See also

- Measurement settings (page 35)

9.4 Performing a salinity measurement

- ▶ A sensor is connected to the instrument.
 - ▶ The sensor is calibrated.
 - ▶ The following measurement settings are done:
 - Endpoint type
 - Data storage mode and location
- 1 Press once or several times  to switch between the measurement modes the unit psu is displayed.
 - 2 Place the sensor into the sample and press **Read** to start the measurement.
 - ⇒ The decimal point and - depending on the endpoint format setting - **A** (automatic), **T** (timed) or **M** (manual) are blinking during the measurement.
 - 3 When the measurement has endpointed, the display freezes. Independent on the set endpoint format, **Read** can be pressed to endpoint the measurement manually.
 - ⇒ The measurement result is displayed.
 - ⇒ If Data Storage Mode is set to **Automatic Storage**, the complete measurement data is automatically transferred to the set storage destination.
 - 4 If Data Storage Mode is set to **Manual Storage**, press  to transfer the data to the set storage location.

Information on the display:

The following symbols appear on the display, depending on the endpoint setting.

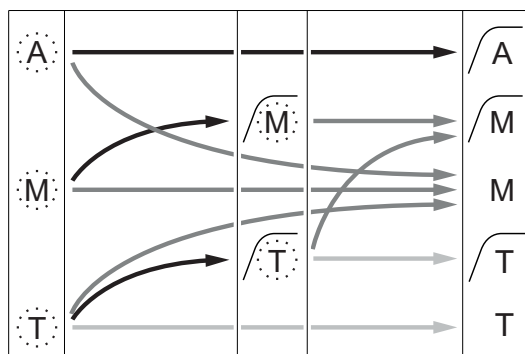



Measurement stopped automatically, reading was stable

Measurement stopped manually, reading was stable



Measurement stopped manually, reading was not stable

Measurement stopped after time, reading was stable

Measurement stopped after time, reading was not stable

-  Defined measurement time elapsed
-  User presses **Read**
-  Signal becomes stable

9.5 Performing a resistivity measurement

- ▶ A sensor is connected to the instrument.
 - ▶ The sensor is calibrated.
 - ▶ The following measurement settings are done:
 - Reference temperature
 - Temperature correction method
 - Endpoint type
 - Data storage mode and location
- 1 Press  once or several times to switch between the measurement modes until a resistivity unit (Ω cm, $k\Omega$ cm, $M\Omega$ cm) is displayed.
 - 2 Place the sensor into the sample and press **Read** to start the measurement.
 - ⇒ The decimal point and - depending on the endpoint format setting - **A** (automatic), **T** (timed) or **M** (manual) are blinking during the measurement.
 - 3 When the measurement has endpointed, the display freezes. Independent on the set endpoint format, **Read** can be pressed to endpoint the measurement manually.
 - ⇒ The measurement result is displayed.
 - ⇒ If Data Storage Mode is set to **Automatic Storage**, the complete measurement data is automatically transferred to the set storage destination.
 - 4 If Data Storage Mode is set to **Manual Storage**, press  to transfer the data to the set storage location.

Information on the display:

The following symbols appear on the display, depending on the endpoint setting.

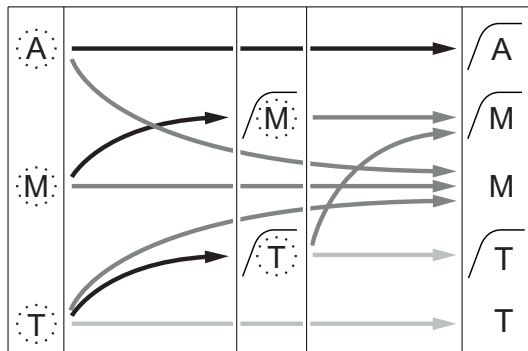

Measurement stopped automatically, reading was stable

Measurement stopped manually, reading was stable



Measurement stopped manually, reading was not stable

Measurement stopped after time, reading was stable

Measurement stopped after time, reading was not stable

- Defined measurement time elapsed
- User presses **Read**
- Signal becomes stable

9.6 Performing a conductivity ash measurement

- ▶ A sensor is connected to the instrument.
 - ▶ The sensor is calibrated.
 - ▶ The following measurement settings are done:
 - ICUMSA method
 - Conductivity of used water
 - Endpoint type
 - Data storage mode and location
- 1 Prepare the sugar sample according to the selected ICUMSA method (see appendix).
 - 2 Press  once or several times to switch between the measurement modes until the unit % is displayed.
 - 3 Place the sensor into the sample and press **Read** to start the measurement.
 - ⇒ The decimal point and - depending on the endpoint format setting - **A** (automatic), **T** (timed) or **M** (manual) are blinking during the measurement.
 - 4 When the measurement has endpointed, the display freezes. Independent on the set endpoint format, **Read** can be pressed to endpoint the measurement manually.
 - ⇒ The measurement result is displayed.
 - ⇒ If Data Storage Mode is set to **Automatic Storage**, the complete measurement data is automatically transferred to the set storage destination.
 - 5 If Data Storage Mode is set to **Manual Storage**, press  to transfer the data to the set storage location.

Note



- According to ICUMSA conductivity ash measurements must be performed in a temperature range of 15 to 25 °C. If this requirement is not met, an error message is displayed.

Information on the display:

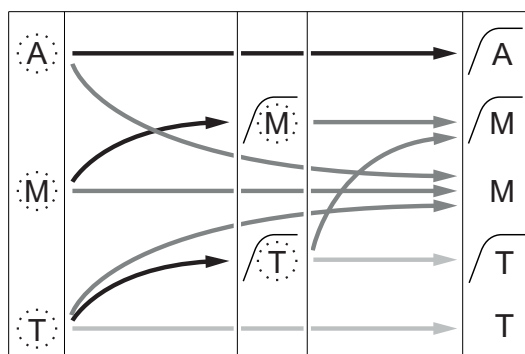

The following symbols appear on the display, depending on the endpoint setting.



- Measurement stopped automatically, reading was stable
- Measurement stopped manually, reading was stable
- Measurement stopped manually, reading was not stable
- Measurement stopped after time, reading was stable
- Measurement stopped after time, reading was not stable

-  Defined measurement time elapsed
-  User presses **Read**
-  Signal becomes stable

9.7 Performing a measurement with interval reading

- ▶ A sensor is connected to the instrument.
 - ▶ The sensor is calibrated.
 - ▶ Measurement settings were done (see previous chapters).
 - ▶ Timed interval reading is enabled (see chapter Interval readings (page 38)).
- 1 Press  once or several times to switch between the measurement modes until the desired unit is displayed.
 - 2 Place the sensor into the sample and press **Read** to start the measurement.
 - 3 Press  once or several times to switch between the measurement modes until the unit mg/L or g/L is displayed.
 - 4 Place the sensor into the sample and press **Read** to start the measurement.
 - ⇒ The decimal point and - depending on the endpoint format setting - **A** (automatic), **T** (timed) or **M** (manual) are blinking during the measurement.
 - ⇒ After every defined time interval the result is automatically sent to the set data storage destination. This happens even if Data Storage Mode is set to Manual.
 - 5 When the measurement has endpointed, the display freezes. The last measurement result is displayed.

10 Data Management

10.1 Data menu structure

Press **↵** to enter and also to exit the setup menu.

1.	Measurement Data
1.1	Review
1.2	Transfer
1.3	Delete
2.	Calibration Data
2.1	Review
2.2	Transfer
2.3	Delete
3.	ISM Data
3.1	Initial Calibration Data
3.2	Calibration History
3.3	Electrode Records
3.4	Reset ISM

10.2 Measurement data

Review > All

Transfer > All

Delete > All:

All stored measurement data can be reviewed, transferred or deleted. The most recent data saved appears on the display.

Review > Partial

Transfer > Partial

Delete > Partial:

Partially selected measurement data can be reviewed, transferred or deleted. The measurement data can be filtered according to 4 criteria.

- Date/Time
- Sample ID
- Measurement mode
- Memory number

Note

- When filtering by date/time, the date must always be entered. If the time 00:00 is used, all results from the whole day are showed/transferred/deleted. Otherwise only the results exactly at the given date and time are affected.

Delete > All After Transfer:

All stored measurement data can be transferred to a PC with software LabX@direct. The measurement data will be deleted automatically after transfer.

10.3 Calibration data

Review:

The stored calibration data of the selected sensor can be reviewed.

Transfer:

All stored calibration data of the selected sensor can be transferred to a PC with software LabX@direct.

Delete:

The calibration data of the selected sensor is deleted. As the same time the sensor ID is deleted from the sensor ID list.

Note

- It is not possible to delete the active sensor. Choose a different one from the sensor ID list first.

10.4 ISM data

Seven2Go meters incorporate Intelligent Sensor Management (ISM[®]) technology. This ingenious functionality provides extra security, safety and eliminates mistakes. The most important features are:

Extra security!

- After connecting the ISM[®] sensor, the sensor is automatically recognized and the sensor ID and serial number are transferred from the sensor chip to the meter. The data is also printed on the GLP printout.
- After calibration of the ISM[®] sensor, the calibration data is automatically stored from the meter to the sensor chip. The most recent data is always stored where it should be – on the sensor chip!

Extra safety!

After connecting the ISM[®] sensor, the five most recent calibrations are transferred to the meter. These can be reviewed to see the development of the sensor over time. This information provides an indication if the sensor should be cleaned or renewed.

Eliminate mistakes!

After connecting an ISM[®] sensor, the last set of calibration data is automatically used for measurements.

Additional features are described below.

In the ISM data menu you have the following submenus:

Initial calibration data

When an ISM[®] sensor is connected, the initial calibration data in the sensor can be reviewed or transferred. The following data is included:

- Response time
- Temperature tolerance
- Cell constant
- Cell constant tolerance
- Type (and name) of electrode (for example, InLab Expert Pro ISM)
- Serial number (SN) and ordering (ME) number
- Production date

Calibration history

The last 5 calibrations data stored in ISM[®] sensor including current calibration can be reviewed or transferred.

Electrode Records

Beside the initial electrode name and serial number, the maximum temperature the sensor measured and the date when this happened can be reviewed.

Reset ISM[®]





The calibration history in this menu can be deleted. This menu is protected by a deletion PIN. Upon delivery, the PIN for deletion is set to 000000. Change the PIN to prevent unauthorized access.

10.5 Data export to PC

It is possible to transfer either all data or a user-defined set of data from the memory to a PC by using LabX@direct. The settings between the instrument and PC are adjusted automatically because USB connection is plug-and-play.

The following section describes how to proceed with the different configurations.

Data transfer from the meter to LabX@direct

- 1 Connect the instrument via USB-B to the PC.
⇒  appears on the display.
- 2 Press  to enter the setup menu.
- 3 Go to  > **Data Storage** > **Storage Destination** and select **LabX Direct**.
- 4 Press  for 3 s to leave the setup menu.
- 5 Open the software **LabX@direct pH** and select the correct instrument.
- 6 Press  to enter the data menu.
- 7 Go to **Measurement Data** > **Transfer** and select the data you want to transfer.
⇒ The transfer starts automatically after the data content is selected.

11 Maintenance

11.1 Software update

A software update can only be done by an authorized METTLER TOLEDO Service agent!

11.2 Repair of the instrument

Seven2Go meters can be repaired. Please ask the METTLER TOLEDO Service department for more information.

11.3 Disposal

In conformance with the European Directive 2002/96/EC on Waste Electrical and Electronic Equipment (WEEE) this device may not be disposed of in domestic waste. This also applies to countries outside the EU, per their specific requirements.

Please dispose of this product in accordance with local regulations at the collecting point specified for electrical and electronic equipment. If you have any questions, please contact the responsible authority or the distributor from which you purchased this device. Should this device be passed on to other parties (for private or professional use), the content of this regulation must also be related.

Thank you for your contribution to environmental protection.



12 Product Portfolio

12.1 Meter and kit versions

Parts	Order No.
Seven2Go Conductivity meter S7 ONLY ¹⁾	30207961
S7-Standard Kit with InLab 738-ISM	30207962
S7-Field Kit with InLab 738-ISM and uGo carrying case	30207963
S7-USP/EP Kit with InLab 742-ISM and uGo carrying case	30207873

¹⁾ **Including:**

- 1 x CD with operating instructions
- 1 x QuickGuide
- 1 x Declaration of conformity
- 1 x Test certificate
- 1 x Wrist strap
- 1 x Electrode assembly
- 1 x Micro-USB to USB-A cable
- 1 x Meter base
- 1 x LabX direct CD
- 1 x Set of conductivity standards

12.2 Accessories

Parts	Order No.
uGo™ carrying case	30122300
Seven2Go meter benchtop stabilizing base	30122303
Seven2Go electrode clip and electrode clip covers (4 pcs.)	30137805
Seven2Go wrist strap	30122304
Electrode arm uPlace™ (complete)	30019823
Power adapter for USB cable (to operate instrument without batteries)	30207980
InLab 738-ISM-IP67, 4 graphite poles, epoxy shaft, ATC, cell constant: 0.57cm ⁻¹	51344110
InLab 742-ISM-IP67, 2 steel poles, steel V4A shaft, ATC, cell constant: 0.105 cm ⁻¹	51344116
InLab® 725, 2 platinum poles, glass shaft, ATC, cell constant: 0.1 cm ⁻¹ Adapter for connection with the instrument required	30014160
Mini-DIN to LTW adapter to connect benchtop conductivity sensors (e.g. InLab 725) to Seven2Go Conductivity meters	51302329
Solutions	Order No.
1.3 µS/cm conductivity check solution, 250 mL	30090847
5 µS/cm conductivity calibration standard solution, 250 mL	30094617
10 µS/cm conductivity calibration standard solution, 10 x 20 mL	30111141
10 µS/cm conductivity standard solution, 250 mL	51300169
84 µS/cm conductivity calibration standard solution, 10 x 20 mL	30111140
84 µS/cm conductivity standard solution, 250 mL	51302153
500 µS/cm conductivity standard solution, 250 mL	51300170
1413 µS/cm conductivity standard solution, 30 x 20 mL	51302049
1413 µS/cm conductivity calibration standard solution, 250 mL	51350092
1413 µS/cm conductivity standard solution, 6 x 250 mL	51350096
12.88 mS/cm conductivity standard solution, 30 x 20 mL	51302050
12.88 mS/cm conductivity calibration standard solution. 250 mL	5350094
12.88 mS/cm conductivity standard solution, 6 x 250 mL	51350098
Documents	Order No.
A Guide to Conductivity Measurement	3009912
Software	Order No.
LabX®direct pH PC software	51302876

13 Technical Data

General

Power rating (batteries)	Batteries	4 x LR6/AA 1.5 V Alkaline - or - 4 x HR6/AA 1.3 V NiMH rechargeable
	Battery life (Standby)	200... 250 hrs
Power rating (USB powered)	Connection	Micro-USB
	Rating	5 V $\overline{\text{DC}}$, 200 mA
Dimensions	Height	222 mm
	Width	70 mm
	Depth	35 mm
	Weight	290 g
Display	LCD	Graphic LCD display
Interfaces	PC connection	Micro-USB
Ambient conditions	Ambient temperature	0...40 °C
	Relative humidity	5%...85% (non-condensing) at 31 °C, linearly descending to 50% at 40 °C
	Overvoltage category	Class II
	Pollution degree	2
	Maximum operating altitude	Up to 2000 m
	Range of application	For indoor and outdoor use
Materials	Housing	ABS/PC reinforced
	Window	Polymethyl methacrylate (PMMA)
Data security / storage	ISM®	Yes
	Memory size	2000 (GLP conform)

Measurement

Parameters	Conductivity, TDS, salinity, specific resistance, conductivity ash	
Sensor input	Conductivity	LTW (IP67)
Conductivity	Measuring range	0.01 $\mu\text{S}/\text{cm}$... 1000 mS/cm
	Resolution	0.01...1 (out range)
	Accuracy (sensor input)	$\pm 0.5\%$
TDS	Measuring range	0.01 mg/L...600 g/L
	Resolution	0.01...1 (out range)
	Accuracy (sensor input)	$\pm 0.5\%$
Specific Resistance	Measuring range	0.01...100.0 M Ωcm
	Resolution	0.01...0.1 (out range)
	Accuracy (sensor input)	$\pm 0.5\%$
Salinity	Measuring range	0.00...42 psu
	Resolution	0.01...0.1 (out range)
	Accuracy (sensor input)	$\pm 0.5\%$
Conductivity Ash	Measuring range	0.00...2022%
	Resolution	0.01...1 (out range)
	Accuracy (sensor input)	0.5%

Temperature	Measuring range	-5...105 °C
	Resolution	0.1 °C
	Accuracy (sensor input)	± 0.1
	ATC/MTC	Yes
	Reference temperature	20 °C/25 °C
Calibration	Calibration points	1
	Predefined conductivity standards	13
	User-defined conductivity standards	Yes
	Manual cell constant entry	Yes

14 Appendix

14.1 Conductivity standards

International (Ref. 25°C)

T [°C]	10 µS/cm	84 µS/cm	500 µS/cm	1413 µS/cm	12.88 mS/cm
5	6.13	53.02	315.3	896	8.22
10	7.10	60.34	359.6	1020	9.33
15	7.95	67.61	402.9	1147	10.48
20	8.97	75.80	451.5	1278	11.67
25	10.00	84.00	500.0	1413	12.88
30	11.03	92.19	548.5	1552	14.12
35	12.14	100.92	602.5	1667	15.39

Chinese Standards (Ref. 25°C)

T [°C]	146.5 µS/cm	1408 µS/cm	12.85 mS/cm	111.3 mS/cm
15	118.5	1141.4	10.455	92.12
18	126.7	1220	11.163	97.8
20	132.2	1273.7	11.644	101.7
25	146.5	1408.3	12.852	111.31
35	176.5	1687.6	15.353	131.1

Japanese Standards (Ref. 20°C)

T [°C]	1330.00 µS/cm	133.00 µS/cm	26.6 µS/cm
0	771.40	77.14	15.428
5	911.05	91.11	18.221
10	1050.70	105.07	21.014
15	1190.35	119.04	23.807
20	1330.00	133.00	26.6
25	1469.65	146.97	29.393
30	1609.30	160.93	32.186
35	1748.95	174.90	34.979

Saturated NaCl (Ref. 25°C)

T [°C]	251.3 mS/cm
5	155.5
10	177.9
15	201.5
20	226.0
25	251.3
30	277.4
35	304.1

14.2 Temperature correction factors

Temperature correction factors f_{25} for non-linear conductivity correction

°C	.0	.1	.2	.3	.4	.5	.6	.7	.8	.9
0	1.918	1.912	1.906	1.899	1.893	1.887	1.881	1.875	1.869	1.863
1	1.857	1.851	1.845	1.840	1.834	1.829	1.822	1.817	1.811	1.805
2	1.800	1.794	1.788	1.783	1.777	1.772	1.766	1.761	1.756	1.750
3	1.745	1.740	1.734	1.729	1.724	1.719	1.713	1.708	1.703	1.698
4	1.693	1.688	1.683	1.678	1.673	1.668	1.663	1.658	1.653	1.648
5	1.643	1.638	1.634	1.629	1.624	1.619	1.615	1.610	1.605	1.601
6	1.596	1.591	1.587	1.582	1.578	1.573	1.569	1.564	1.560	1.555
7	1.551	1.547	1.542	1.538	1.534	1.529	1.525	1.521	1.516	1.512
8	1.508	1.504	1.500	1.496	1.491	1.487	1.483	1.479	1.475	1.471
9	1.467	1.463	1.459	1.455	1.451	1.447	1.443	1.439	1.436	1.432
10	1.428	1.424	1.420	1.416	1.413	1.409	1.405	1.401	1.398	1.384
11	1.390	1.387	1.383	1.379	1.376	1.372	1.369	1.365	1.362	1.358
12	1.354	1.351	1.347	1.344	1.341	1.337	1.334	1.330	1.327	1.323
13	1.320	1.317	1.313	1.310	1.307	1.303	1.300	1.297	1.294	1.290
14	1.287	1.284	1.281	1.278	1.274	1.271	1.268	1.265	1.262	1.259
15	1.256	1.253	1.249	1.246	1.243	1.240	1.237	1.234	1.231	1.228
16	1.225	1.222	1.219	1.216	1.214	1.211	1.208	1.205	1.202	1.199
17	1.196	1.193	1.191	1.188	1.185	1.182	1.179	1.177	1.174	1.171
18	1.168	1.166	1.163	1.160	1.157	1.155	1.152	1.149	1.147	1.144
19	1.141	1.139	1.136	1.134	1.131	1.128	1.126	1.123	1.121	1.118
20	1.116	1.113	1.111	1.108	1.105	1.103	1.101	1.098	1.096	1.093
21	1.091	1.088	1.086	1.083	1.081	1.079	1.076	1.074	1.071	1.069
22	1.067	1.064	1.062	1.060	1.057	1.055	1.053	1.051	1.048	1.046
23	1.044	1.041	1.039	1.037	1.035	1.032	1.030	1.028	1.026	1.024
24	1.021	1.019	1.017	1.015	1.013	1.011	1.008	1.006	1.004	1.002
25	1.000	0.998	0.996	0.994	0.992	0.990	0.987	0.985	0.983	0.981
26	0.979	0.977	0.975	0.973	0.971	0.969	0.967	0.965	0.963	0.961
27	0.959	0.957	0.955	0.953	0.952	0.950	0.948	0.946	0.944	0.942
28	0.940	0.938	0.936	0.934	0.933	0.931	0.929	0.927	0.925	0.923
29	0.921	0.920	0.918	0.916	0.914	0.912	0.911	0.909	0.907	0.905
30	0.903	0.902	0.900	0.898	0.896	0.895	0.893	0.891	0.889	0.888
31	0.886	0.884	0.883	0.881	0.879	0.877	0.876	0.874	0.872	0.871
32	0.869	0.867	0.866	0.864	0.863	0.861	0.859	0.858	0.856	0.854
33	0.853	0.851	0.850	0.848	0.846	0.845	0.843	0.842	0.840	0.839
34	0.837	0.835	0.834	0.832	0.831	0.829	0.828	0.826	0.825	0.823
35	0.822	0.820	0.819	0.817	0.816	0.814	0.813	0.811	0.810	0.808

14.3 Temperature coefficients (alpha-values)

Substance at 25 °C	Concentration [%]	Temperature coefficient alpha [%/°C]
HCl	10	1.56
KCl	10	1.88
CH ₃ COOH	10	1.69
NaCl	10	2.14
H ₂ SO ₄	10	1.28
HF	1.5	7.20

α-coefficients of conductivity standards for a calculation to reference temperature 25 °C

Standard	Measurement temp.: 15 °C	Measurement temp.: 20 °C	Measurement temp.: 30 °C	Measurement temp.: 35 °C
84 μS/cm	1.95	1.95	1.95	2.01
1413 μS/cm	1.94	1.94	1.94	1.99
12.88 mS/cm	1.90	1.89	1.91	1.95

14.4 Practical salinity scale (UNESCO 1978)

The salinity is calculated according to the official definition of UNESCO 1978. Therefore the salinity Spsu of a sample in psu (practical salinity unit) at standard atmospheric pressure is calculated as follows:

$$S = \sum_{j=0}^5 a_j R_T^{j/2} - \frac{(T-15)}{1+k(T-15)} \sum_{j=0}^5 b_j R_T^{j/2}$$

a ₀ = 0.0080	b ₀ = 0.0005	k = 0.00162
a ₁ = -0.1692	b ₁ = -0.0056	
a ₂ = 25.3851	b ₂ = -0.0066	
a ₃ = 14.0941	b ₃ = -0.0375	
a ₄ = -7.0261	b ₄ = 0.0636	
a ₅ = 2.7081	b ₅ = -0.0144	

$$R_T = \frac{R_{\text{sample}}(T)}{R_{\text{KCl}}(T)}$$

(32.4356 g KCl per 1000 g of solution)

14.5 Conductivity to TDS conversion factors

Conductivity at 25 °C	TDS KCl		TDS NaCl	
	ppm value	factor	ppm value	factor
84 μS/cm	40.38	0.5048	38.04	0.4755
447 μS/cm	225.6	0.5047	215.5	0.4822
1413 μS/cm	744.7	0.527	702.1	0.4969
1500 μS/cm	757.1	0.5047	737.1	0.4914
8974 μS/cm	5101	0.5685	4487	0.5000
12.880 μS/cm	7447	0.5782	7230	0.5613
15.000 μS/cm	8759	0.5839	8532	0.5688
80 mS/cm	52.168	0.6521	48.384	0.6048

14.6 USP/EP tables

Conductivity requirements ($\mu\text{S/cm}$) for USP / EP (highly purified water) / EP (purified water)

Temperature [°C]	USP [$\mu\text{S/cm}$]	EP (highly purified water) [$\mu\text{S/cm}$]	EP (purified water) [$\mu\text{S/cm}$]
0	0.6	0.6	2.4
5	0.8	0.8	-
10	0.9	0.9	3.6
15	1.0	1.0	-
20	1.1	1.1	4.3
25	1.3	1.3	5.1
30	1.4	1.4	5.4
35	1.5	1.5	-
40	1.7	1.7	6.5
45	1.8	1.8	-
50	1.9	1.9	7.1
55	2.1	2.1	-
60	2.2	2.2	8.1
65	2.42	2.42	-
70	2.5	2.5	9.1
75	2.7	2.7	9.7
80	2.7	2.7	9.7
85	2.7	2.7	-
90	2.7	2.7	9.7
95	2.9	2.9	-
100	3.1	3.1	10.2

14.7 Conductivity ash methods

The meter can measure the conductivity ash (%) according to the two ICUMSA methods:

14.7.1 Refined sugar (28 g/100 g solution) ICUMSA GS2/3-17

The formula that the instrument uses is:

$$\% \text{ (m/m)} = 0,0006 \times ((C1 / (1 + 0,026 \times (T - 20))) - 0,35 \times (C2 / (1 + 0,026 \times (T - 20)))) \times K$$

C1 = conductivity of the sugar solution in $\mu\text{S/cm}$ with cell constant = 1 cm^{-1}

C2 = conductivity of the water used in $\mu\text{S/cm}$ to prepare the sugar solution with cell constant = 1 cm^{-1}

T = temperature in °C between 15°C and 25°C

K = cell constant

14.7.2 Raw sugar or molasses (5 g / 100 mL solution) ICUMSA GS 1/3/4/7/8-13

The formula that the instrument uses is:

$$\% \text{ (m/V)} = 0,0018 \times ((C1 / (1 + 0,023 \times (T - 20))) - C2 / (1 + 0,023 \times (T - 20))) \times K$$

C1 = conductivity of the sugar solution in $\mu\text{S/cm}$ with cell constant = 1 cm^{-1}

C2 = conductivity of the water used to prepare the sugar solution in $\mu\text{S/cm}$ with cell constant = 1 cm^{-1}

T = temperature in °C between 15°C and 25°C

K = cell constant of the used sensor

To protect your product's future:

METTLER TOLEDO Service assures the quality, measuring accuracy and preservation of value of this product for years to come.

Please request full details about our attractive terms of service.

www.mt.com/ph

For more information

Mettler-Toledo AG, Analytical

CH-8603 Schwerzenbach, Switzerland

Tel. +41 (0)44 806 77 11

Fax +41 (0)44 806 73 50

www.mt.com

Subject to technical changes.

© Mettler-Toledo AG 08/2014

30219677A

