

Operating instructions

*METTLER TOLEDO MultiRange
IND226x weighing terminal*

METTLER TOLEDO

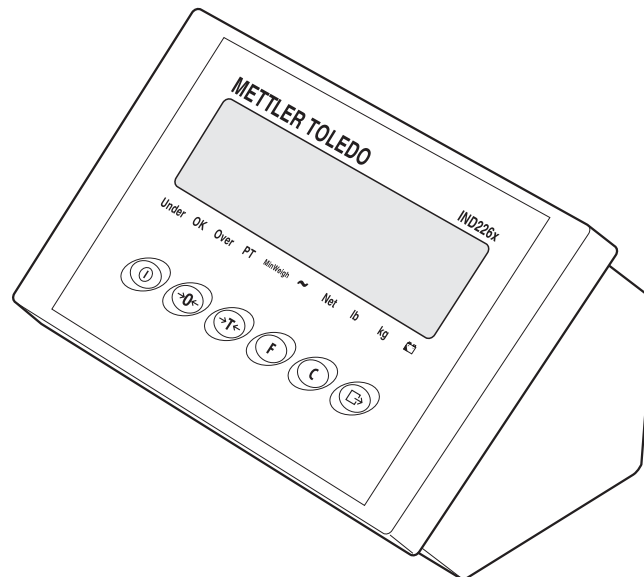

www.mt.com/support

Dependable Performance of Your IND226x Scale Terminal

1

Register your new terminal:

We invite you to register your new scale equipment at www.mt.com/productregistration to allow us to contact you about enhancements, updates and important notifications concerning your product.

2

Get to know your weighing equipment:

Production engineers, maintenance personnel and operators should familiarize themselves with the user and technical documentation shipped with your new terminal. If you cannot locate this information, please contact your local authorized service provider to request a copy.

3

Contact METTLER TOLEDO for service:

The value of a measurement is proportional to its accuracy – an out of specification scale can diminish quality, reduce profits and increase liability. Timely service from METTLER TOLEDO will ensure accuracy and optimize uptime and equipment life.



Installation, Configuration, Integration and Training

Our service representatives are factory-trained, weighing equipment experts. We make certain that your weighing equipment is ready for production in a cost effective and timely fashion and that personnel are trained for success.



Initial Calibration Documentation

The installation environment and application requirements are unique for every industrial scale so performance must be tested and certified. Our calibration services and certificates document accuracy to ensure production quality and provide a quality system record of performance.



Periodic Calibration Maintenance

A Calibration Service Agreement provides on-going confidence in your weighing process and documentation of compliance with requirements. We offer a variety of service plans that are scheduled to meet your needs and designed to fit your budget.

Whenever you call us, our service representatives will be there at the right time, with the right parts, the right tools and the right skills to meet your needs.

METTLER TOLEDO



Product Model Number¹: _____

Product Serial Number: _____

Authorized Service Provider²: _____

Service Telephone Number: _____

- 1) Product model and serial number can be obtained from product data plate
- 2) Visit www.mt.com/contact to find the name and number of an authorized service provider

Extending the Capability of Your IND226x

The IND226x is a weighing terminal for the use in hazardous areas. There are a variety of peripherals that can be added to the terminal to enhance your process. METTLER TOLEDO authorized sales and service representatives will assist you in selecting, installing, configuring, connecting and maintaining your IND226x with the following hardware and software solutions:

Configurable Weighing Functions:

- Over/Under mode (checking or classifying)
- CalFREE calibration without test weights
- Configurable Sleep / Standby mode
- Remote display function

Communications:

- Interface IND: serial data interface for communicating with PC systems or peripheral devices in the non-hazardous zone via the interface converter ACM200
- Interface Remote: serial data interface for operating the IND226x as a secondary display

Discrete I/O:

- One active input for clear, tare, zero or print function

Parts and Accessories:

- Floor stand
- Pillar support
- Wall bracket

Additional Services to Ensure Compliance, Equipment Life and Uptime

METTLER TOLEDO can deliver services that help to ensure your compliance with regulatory and quality requirements and to maximize equipment life and uptime. These services include:

Regulatory Compliance Services:

- Equipment Qualification (IQ, OQ, PQ)
- Recommendations and help with SOPs
- Periodic test procedures and reference weights

Calibration and Certification Services:

- ISO9001 and ISO17025 compliant certification
- Measurement uncertainty and minimum weight determination

Maintenance and Repair:

- Comprehensive service agreements
- On-site maintenance and repair



Contents

	Page
<i>1</i>	<i>Safety instructions</i> 5
<i>2</i>	<i>Introduction</i> 6
2.1	System overview..... 6
2.2	Commissioning..... 8
2.3	Description..... 9
<i>3</i>	<i>Basic functions</i> 11
3.1	Switching on and off..... 11
3.2	Zeroing..... 11
3.3	Simple weighing..... 11
3.4	Weighing with tare..... 12
3.5	Printing/transferring data..... 12
3.6	Information on storage battery operation..... 13
3.7	Cleaning..... 13
<i>4</i>	<i>Applications</i> 14
4.1	Displaying weight values with a higher resolution (x10)..... 14
4.2	Switching weight unit..... 14
4.3	Checkweighing..... 15
4.4	Classifying..... 16
<i>5</i>	<i>Operator menu</i> 18
5.1	Entering the operator menu..... 18
5.2	Operating the menu..... 18
5.3	F2 – F key menu..... 19
5.4	F3 – terminal menu..... 22
5.5	F4 – communication menu..... 22
5.6	F6 – ending menu..... 24
<i>6</i>	<i>Supervisor menu</i> 25
6.1	Entering Supervisor menu..... 25
6.2	Operating the Supervisor menu..... 25
6.3	Block F1 – Scale..... 26
6.4	Block F5 – Maintenance..... 31
<i>7</i>	<i>Interface commands</i> 33
7.1	SICS interface commands..... 33
7.2	Toledo Continuous Mode..... 34
<i>8</i>	<i>Error messages</i> 36

9	<i>Technical data and accessories</i>	37
9.1	Technical data	37
9.2	Technical data for ACM200	39
9.3	Accessories	40
10	<i>Appendix</i>	41
10.1	Disposal.....	41
10.2	Declarations of conformity	42

1 Safety instructions



The IND226x weighing terminal is approved for operation in Zone 1 and 21 hazardous areas. The interface converter ACM200 may only be installed and operated in the safe area.

If the IND226x weighing terminal is used in hazardous areas, special care must be taken. The code of practice is oriented to the "Safe Distribution" concept drawn up by METTLER TOLEDO.

- Competence* ▲ The weighing system may only be installed, maintained and repaired by authorised METTLER TOLEDO service personnel.
- Ex approval* ▲ No modifications may be made to the terminal and no repair work may be performed on the modules. Any weighing platform or system modules that are used must comply with the specifications contained in the installation instructions. Non-compliant equipment jeopardises the intrinsic safety of the system, cancels the "Ex" approval and renders any warranty or product liability claims null and void.
- ▲ The safety of the weighing system is only guaranteed when the weighing system is operated, installed and maintained in accordance with the respective instructions.
- ▲ Also comply with the following:
- the instructions for the system modules,
 - the regulations and standards in the respective country,
 - the statutory requirement for electrical equipment installed in hazardous areas in the respective country,
 - all instructions related to safety issued by the owner.
- ▲ The explosion-protected weighing system must be checked to ensure compliance with the requirements for safety before being put into service for the first time, following any service work and every 3 years, at least.
- Operation* ▲ Prevent the build-up of static electricity. Always wear suitable working clothes when operating or performing service work in a hazardous area.
- ▲ Do not use protective coverings for the devices.
- ▲ Protect the keyboard membrane against ultraviolet radiation.
- ▲ Avoid damage to the system components.

2 Introduction

2.1 System overview

A weighing system with the IND226x weighing terminal can be operated either with one of the following power supply units or an external storage battery:

<i>APS500</i>	Power supply unit in a hazardous area, US version, 120 VAC, 50/60 Hz
<i>APS501</i>	Power supply unit in a hazardous area, EU version, 240 VAC, 50/60 Hz
<i>PSUx/120 V</i>	Power supply unit in a hazardous area, US version, 120 VAC, 50/60 Hz
<i>PSUx/230 V</i>	Power supply unit in a hazardous area, EU version, 230 VAC, 50 Hz
<i>External Battery Pack</i>	External storage battery for a hazardous area, charging only in a safe area and using a charger specified and approved by METTLER TOLEDO

Either an analog weighing platform or the system solution Analog Ex1 can be connected to the weighing IND226x terminal.

The following components are necessary for connection of peripheral devices:

<i>Interface IND</i>	Active intrinsically safe data interface, installed in IND226x (Master)
<i>Interface Remote</i>	Passive intrinsically safe data interface, for remote control of an IND226x (IND226x as a second display), installed in IND226x (second display)
<i>ACM200</i>	Interface converter for the safe area, for example, for connection of a PC in the safe area Wide range power supply unit 100 – 240 V AC, 50/60 Hz

2.1.1 Configuration with interface converter ACM200 in the safe area

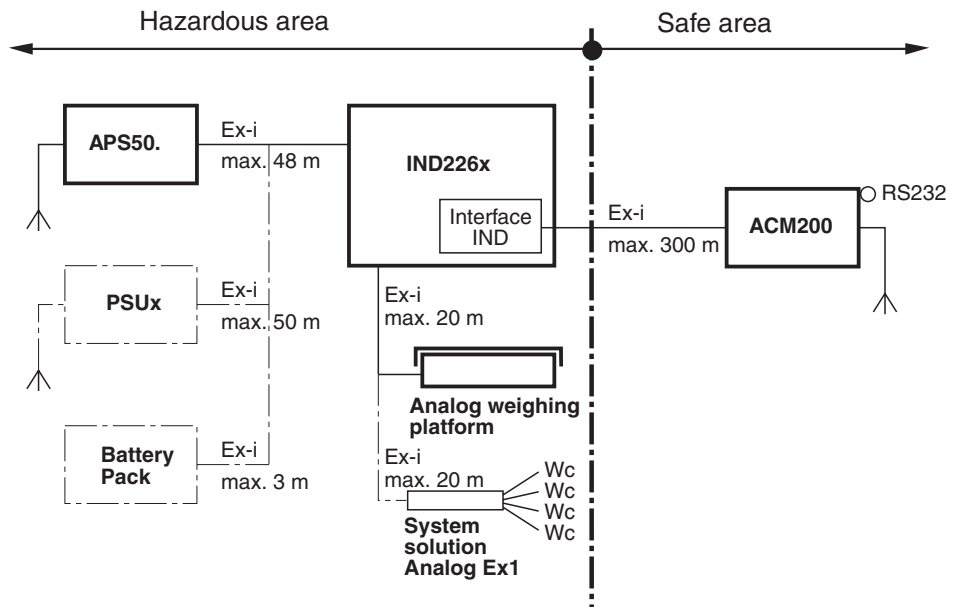

Dashed-line components are alternatives.

2.1.2 Configuration with remote controlled IND226x (second display)

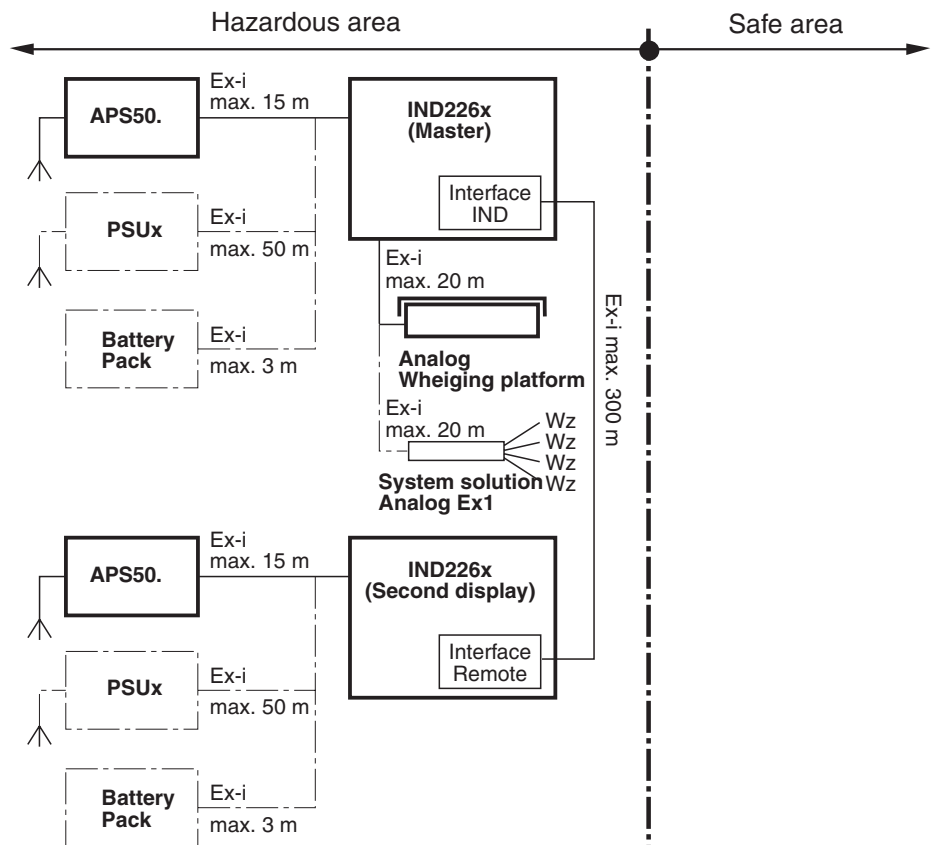

Dashed-line components are alternatives.

2.2 Commissioning

2.2.1 Guide for installers and terminal diagram

The installation of an explosion-protected weighing system with the IND226x weighing terminal may only be carried out in accordance with the guide for installers ME-72203958 and control drawing ME-72203677.

2.2.2 Information on certified weighing systems

In the case of certified weighing systems, the weighing platform connection at the weighing terminal must be sealed with a wire seal or a verification mark. In addition, a label with the information on "Max", "Min" and "e" has to be placed within the range of vision of the weight display.

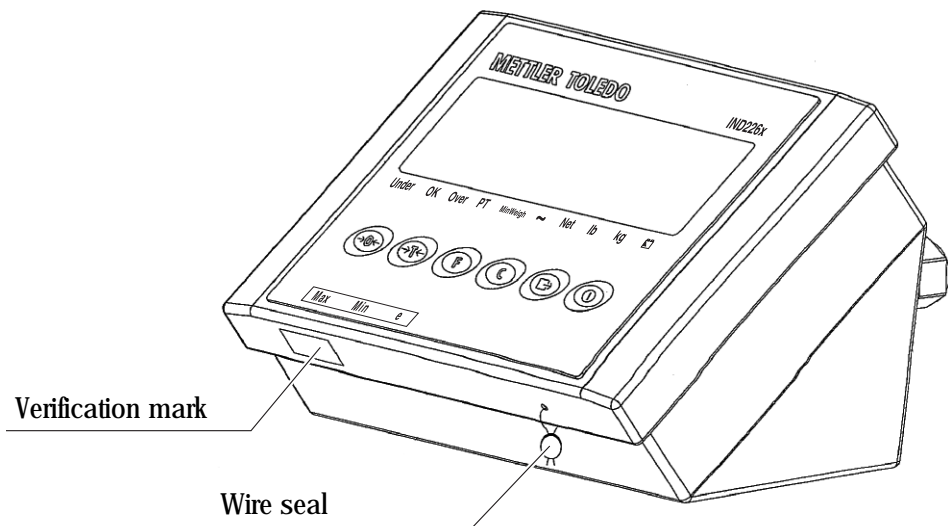

2.3 Description

2.3.1 Overview

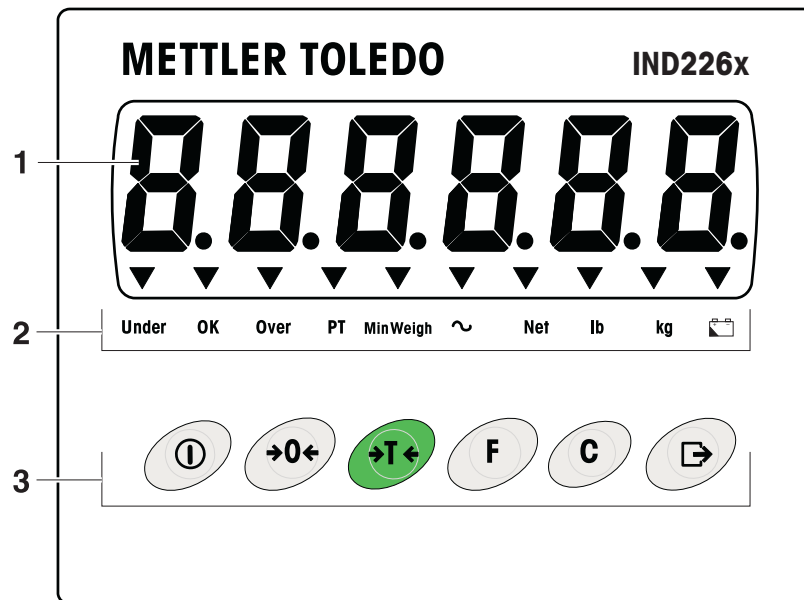

1 6-digit weight display







2 Status indicators

3 Keypad

2.3.2 Status indicators

<i>LED</i>	<i>Meaning</i>
<i>Under / OK / Over</i>	Indicators for check weighing
<i>PT</i>	Indicator for tare specification
<i>MinWeigh</i>	Indicator for MinWeigh function
<i>~</i>	Movement indicator
<i>Net</i>	The displayed weight value is a net weight value
<i>lb / kg</i>	Weight unit currently selected
	Storage battery state

2.3.3 Keys

<i>Key</i>	<i>Operating mode</i>	<i>Menu</i>	<i>Key</i>	<i>Operating mode</i>	<i>Menu</i>
	Switching power on/off; abort	–		Function key	Back to the next higher menu item
	Zeroing	Scrolling back		Clear key	Back to the previous menu item
	Tare	Scrolling forward		Transfer key Long key-press: Calling up menu	Activating menu item; accepting selected setting

3 Basic functions

3.1 Switching on and off

Switching on

→ Press .

The display lights up and then shows the software number.

When the weight display appears, the weighing terminal is ready for operation.

Switching off

→ Press and hold  until **-OFF-** is displayed.

3.2 Zeroing

Zeroing corrects the influence of slight soiling on the load plate.

Setting to zero manually

1. Unload weighing platform.

2. Press .

The zero display appears.

Automatic zeroing

In case of non-certified weighing platforms, the automatic zero point correction can be deactivated in the supervisor menu (F1.4.1).

In standard operation, the zero point of the weighing platform is automatically corrected when the weighing platform is unloaded.

3.3 Simple weighing

1. Place weighing sample on the weighing platform.

2. Wait until the motion indicator goes out.

3. Read weighing result.

3.4 Weighing with tare

Taring

Place the empty container on the weighing platform and press . The zero display and the *Net* indicator appear.

Clearing the tare

Press .

The *Net* indicator goes out, the gross weight appears in the display.

- If automatic clearing of the tare weight is set in the supervisor menu (F1 . 5 . 2=On), the tare weight is cleared automatically as soon as the weighing platform is unloaded to zero.
- If tare interlock is set in the supervisor menu (F1 . 5 . 3=On), the tare weight can only be cleared when the weighing platform is unloaded to zero.

Automatic taring

This function must be activated in the supervisor menu (F1 . 5 . 1=On).

Place the empty container on the weighing platform.

The weight applied on the weighing platform is automatically saved as the tare weight.

The zero display and the *Net* indicator appear.

3.5 Printing/transferring data

Condition

The weighing terminal is connected via the optional Interface IND to the interface converter ACM200 in the safe area.

Press .

The display contents are printed out or transferred to a computer.

Note

The display contents will not be printed or transferred if the scale is in motion.

3.6 Information on storage battery operation





EXPLOSION HAZARD!

Always charge the Battery Pack in a safe area!

Only use chargers approved by METTLER TOLEDO!

The indicator  indicates the storage battery state.

▼ above  continuous red	Storage battery charged approx. 10% Residual operating life approx. 3–5 h
▼ above  slow flashing, red	Storage battery charged approx. 5% Residual operating life approx. 1 h
▼ above  rapid flashing, red	Storage battery charged less than 5% Storage battery must be charged immediately

The (residual) operating life during storage battery operation depends on the operating mode.

The following operating life applies for a fully charged new storage battery:

Sleep mode	min. 70 h
Normal weight display	min. 60 h
Normal weight display and interface operation	min. 50 h

Note

Depending on the age and the charging state of the storage battery, the operating life may vary downwards.

3.7 Cleaning



EXPLOSION HAZARD!

→ Before cleaning ensure that the weighing terminal is closed properly. The four clip fasteners at the corners must have engaged fully.

Further notes on cleaning

- Use a damp cloth.
- Do not use any acids, alkalis or strong solvents.
- Do not clean the weighing terminal using high-pressure or high-temperature water.
- Follow all the relevant instructions regarding cleaning intervals and permissible cleaning agents.

4 Applications

Depending on the setting of F2.1 parameter in the operator menu, different applications can be activated using the **F** key.

4.1 Displaying weight values with a higher resolution (x10)

For this purpose F2.1=MULT must be set in the operator menu (factory setting).



Press **F**.

The weight value is displayed with a higher resolution (x10) for about 10 seconds.

Note

The weight value in higher resolution (x10) cannot be printed.

4.2 Switching weight unit

For this purpose, F2.1=Unit must be set in the operator menu.



Press **F**.

The weight value is displayed in the second weight unit.

Note

The displayed weight unit remains until it is switched again.

4.3 Checkweighing

For this purpose, F2.1=OVER and F2.2.1=CHECK (factory setting) must be set in the operator menu. In the factory setting, the check weighing function is working with upper and lower tolerances of 10 d. With parameters F2.2.3 and F2.2.4, these tolerances can be customized.

Setting target weight

1. Press **F** to activate the check weighing function.
2. Press and hold **F** until **tARGET** and the 3 indicators *Under*, *OK* and *Over* appear.
If **F2.2.2=WEIGHT** (factory setting) is set in the operator menu, the weight display appears.
3. Put the target weight on the weighing platform and save with **F**.
The *OK* indicator lights.
If **F2.2.2=MANUAL** is set in the operator menu, the weight display with blinking last digit appears.
4. Enter target weight using the **→T←**, **→0←** and **F** keys and confirm with **↵** (see page 18).
5. Save entered weight value as target weight using the **F** key.

Check weighing

Example: Target weight = 1.000 kg

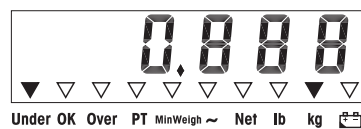

- Weight is less than the target weight and below the lower tolerance value.
The *Under* indicator lights.

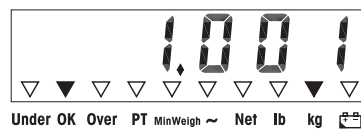

- Weight is within the tolerance values.
The *OK* indicator lights.

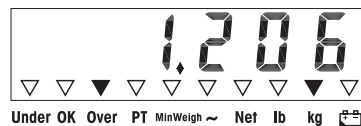

- Weight is more than the target weight and above the upper tolerance value.
The *Over* indicator lights.

Switching between checkweighing and normal weighing

Press **F** to switch between checkweighing and normal weighing.

4.4 Classifying

For this purpose, and F2.2.1=CLASS must be set in the operator menu.

In the factory setting, the classifying function is working with upper and lower tolerances of 10 d, 20 d, 30 d. With parameters F2.2.3 and F2.2.4, these tolerances can be customized.

Setting target weight

1. Press **F** to activate the classifying function.
2. Press and hold **F** until and the 3 indicators *Under*, *OK* and *Over* appear.
If (factory setting) is set in the operator menu, the weight display appears.
3. Put the target weight on the weighing platform and save with **F**.
The *OK* indicator lights.
If is set in the operator menu, the weight display with blinking last digit appears.
4. Enter target weight using the **→T←**, **→0←** and **F** keys and confirm with **↵** (see page 18).
5. Save entered weight value as target weight using the **F** key.

Classifying

Example:

Target weight = 1,000 kg, tol. 1 = 100 kg, tol. 2 = 200 kg, tol. 3 = 300 kg

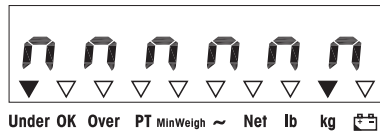

- Weight is less than the target weight and below tolerance 3, e.g. below 700 kg. The *Under* indicator lights.

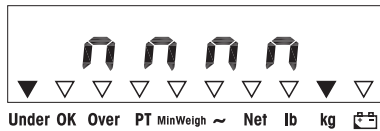

- Weight is less than the target weight and below tolerance 2, e.g. between 700 kg and 800 kg. The *Under* indicator lights.

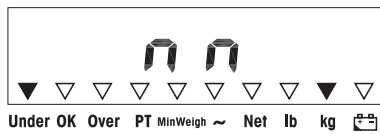

- Weight is less than the target weight and below tolerance 1, e.g. between 800 kg and 900 kg. The *Under* indicator lights.

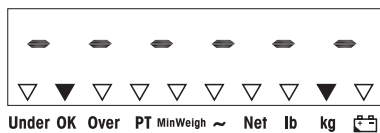

- Weight is within tolerance 1, e.g. between 900 kg and 1,100 kg. The *OK* indicator lights.

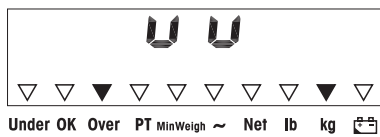

- Weight is more than the target weight and above upper tolerance 1, e.g. between 1,100 kg and 1,200 kg. The *Over* indicator lights.

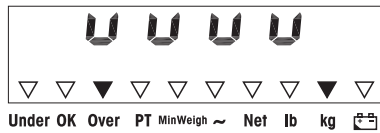

- Weight is more than the target weight and above upper tolerance 2, e.g. between 1,200 kg and 1,300 kg. The *Over* indicator lights.

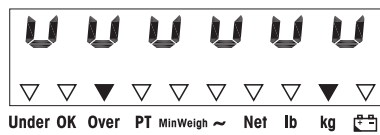

- Weight is more than the target weight and above upper tolerance 3, e.g. above 1,300 kg. The *Over* indicator lights.

Switching between classifying and normal weighing

Press **F** to switch between classifying and normal weighing.





5 Operator menu

The operator menu consists of the following blocks:

- F2 – F key menu settings
- F3 – Terminal menu settings
- F4 – Communication menu settings
- F6 – Exit menu

5.1 Entering the operator menu

In gross mode, press and hold  until **MAStEr** appears.

Enter pass word    and confirm with .





SEtUP appears.

Press .





F2 appears.

5.2 Operating the menu

Keys and their function in the menu

-  Selecting next parameter.
-  Back to the previous parameter.
-  Confirming selection.
-  Back to the previous menu item.
-  Back to the next higher menu item.

Numeric entry

1. Press  for editing the displayed value.
The (last) digit will blink.
2. Increase the displayed digit using the  key.
– or –
Decrease the displayed digit using the  key.
3. When entering multi-digit numbers, use the  key to move the cursor one place to the left.
4. Change the digit as described in step 2.
5. Repeat steps 3 and 4 if necessary.
6. When all digits are entered, use the  key to confirm the entry.

Note

With **C**, you can clear the entry.

5.3 F2 – F key menu

Factory settings are printed with *bold* characters.

F2.1 – Function of the F key

3 different functions can be assigned to the F key:

MUL10 When pressing the F key, the weight value is displayed in *10 times higher resolution*
 When pressing the F key, the weight unit switches between kg and lb
 Note: lb is not possible in compulsory-certification mode.
 Plus/Minus weighing
 Additional settings, see F2.2

F2.2 – Plus/Minus weighing

These parameters only appear if **is set.**

F2.2.1 – Operating mode

CHECh *Check weighing*
 Classifying

F2.2.2 – Setting the target weight

WEIGHT *By weighing in* an actual sample weight
MAAnUAL *By numeric entry*

F2.2.3 – Upper tolerances

After selecting the parameter, the currently set tolerance value is displayed.

If **F2.2.1 = Chech** is set:

Upper tolerance = target value + displayed tolerance value

If **F2.2.1 = CLASS** is set:

Internally the terminal calculates 3 tolerances.

Upper tolerance 1 = target value + displayed tolerance value

Upper tolerance 2 = target value + 2 x displayed tolerance value

Upper tolerance 3 = target value + 3 x displayed tolerance value

1. If necessary, use the **F** key to activate editing.
2. Change tolerance value using the **→0←**, **→T←** and **F** keys.

Factory setting upper tolerance value = *10 d*

Possible settings 0 ... full load

F2.2.4 – Lower tolerances

After selecting the parameter, the currently set tolerance value is displayed.

If **F2.2.1 = Chech** is set:

Lower tolerance = target value – displayed tolerance value

If **F2.2.1 = CLASS** is set:

Internally the terminal calculates 3 tolerances.

Lower tolerance 1 = target value – displayed tolerance value

Lower tolerance 2 = target value – 2 x displayed tolerance value

Lower tolerance 3 = target value – 3 x displayed tolerance value

1. Use the **F** key to activate editing if necessary.
2. Change tolerance using the **→0←**, **→T←** and **F** keys.

Factory setting lower tolerance value = 10 d

Possible settings 0 ... full load

F2.4 – Remote Display (IND226x as secondary display)

The Interface Remote has to be installed in the secondary display in order to use this function.

The following commands can be carried out optionally by the master or the secondary display: Set to Zero, Tare, and Delete.

The cabling of the system components is described in the terminal diagram ME-72203677 of the IND226x installation instructions.

OFF *Remote function of the secondary display de-activated*

ON Remote function activated. The secondary display displays the weight value of the master terminal.

F2.5 – Active input

Please refer to the IND226x guide for installers and the terminal diagram ME-72203677 for information on selecting and connecting external switches or pushbuttons to the active input.

The active input can have one of the following functions assigned to it:

None *Active input de-activated*

Clear Delete key

Print Transfer key

Tare Tare key

Zero Zero-adjustment key

F2.6 – MinWeigh

When the MinWeigh function is activated, the MinWeigh indicator lights up when the weight lies below the minimum weighing-in quantity.

F2.6.1 – Activation of the MinWeigh function

MinWeigh function *de-activated*

ON MinWeigh function activated

F2.6.2 – Input mode

The minimum weighing-in quantity can be entered directly or be calculated directly by the terminal from the following variables:

U_0 Measurement uncertainty when the load approaches 0
 T Required tolerance as a %
 F Safety factor

dirEct Enter minimum weighing-in quantity via keyboard
 The minimum weighing-in quantity is calculated by the terminal

F2.6.3 – Direct entry of the minimum weighing-in quantity

This parameter is only displayed if $F2.6.2 = \text{dirEct}$ has been selected.

Enter the minimum weighing-in quantity by using the keys $\rightarrow 0 \leftarrow$, $\rightarrow T \leftarrow$ and F .

F2.6.4 – Entry of the measurement uncertainty U_0

This parameter is only displayed if $F2.6.2 = \text{CoMPon}$ has been selected.

Enter the measurement uncertainty by using the keys $\rightarrow 0 \leftarrow$, $\rightarrow T \leftarrow$ and F .

F2.6.5 – Entry of the tolerance T

This parameter is only displayed if $F2.6.2 = \text{CoMPon}$ has been selected.

Enter the tolerance as a % by using the keys $\rightarrow 0 \leftarrow$, $\rightarrow T \leftarrow$ and F .

Factory setting 0.1%
 Possible values 0.1 ... 99.9%

F2.6.6 – Entry of the safety factor F

This parameter is only displayed if $F2.6.2 = \text{CoMPon}$ has been selected.

Enter the safety factor by using the keys $\rightarrow 0 \leftarrow$, $\rightarrow T \leftarrow$ and F .

Factory setting 1
 Possible values 1 ... 10

F2.10 – Reset F key settings

Reset all parameters $F2.x(.x)$ to factory setting.

5.4 F3 – terminal menu

Factory settings are printed with *bold* characters.

F3.1 – Display settings

F3.1.1 – Sleep mode

The weighing terminal switches to sleep mode when during the set time no action on the weighing terminal or no change in weight occurred.

Factory setting **60 (seconds)**

Function disabled 0

Possible settings 10 ... 999 (seconds)

F3.2 – Auto power off

The weighing terminal is switched off if during the set time no action was on the weighing terminal or on the weighing platform.

Factory setting **5 (minutes)**

Function disabled 0

Possible settings 0.5 ... 60 (minutes)

F3.10 – Reset terminal settings

Reset all parameters F3.x(.x) to factory setting.

5.5 F4 – communication menu

The Interface IND data interface has to be installed in the IND226x in order to use this function. In addition an interface converter ACM200 is required for communication with PCs or printers in the safe area.

Factory settings are printed in *bold* characters.

F4.1 – Connections

	When pressing  , the current display is printed.
APrint	Stable weight values are printed automatically Additional settings: F4.2.5 and F4.2.6
SICS	Communication via the METTLER TOLEDO <i>Standard Interface Command Set</i> (MT-SICS)
Contin	Toledo Continuous Mode – for continuous transfer of weight data and status information, for example to a PC or a secondary display.

F4.2 – Format

F4.2.1 – Line format

	<i>Multi line</i>
Single	Single line

F4.2.2 – Print format

Standard (current display)
 OVer over / good / under
 Count Piece number

F4.2.3 – Print language

English
 CHn Chinese

F4.2.4 – Add line feed

Factory setting 3 (lines)
 Possible settings 0 ... 9 (lines)

F4.2.5 – Auto print threshold

This menu item is only available if F4.1=APrint is set.
 A stable weight value which is higher than the set value is printed automatically.
 Factory setting 10 (d)
 Possible settings 0 ... max. load

F4.2.6 – Auto print reset threshold

This menu item is only available if F4.1=APrint is set.
 The scale must be unloaded below the set value before a new weight value can be printed automatically.
 Factory setting 10 (d)
 Possible settings 0 ... max. load

F4.3 – Parameters**F4.3.1 – Baudrate**

1200
 2400
 4800
9600
 19200

F4.3.2 – Data bits / parity

7-odd 7 bits, parity odd
 7-even 7 bits, parity even
8-nonE 8 bits, no parity
 8 bits, parity odd
 8 Bits, parity even

F4.3.3 – Xon/Xoff

Xon/Xoff enabled
OFF Xon/Xoff disabled

F4.3.4 – Checksum

Checksum enabled
OFF Checksum *disabled*

F4.10 – Reset communication settings

Reset all parameters F4.x(.x) to factory setting.

5.6 *F6 – ending menu*







1. Press **C**.
F6 appears.
2. To save changes: Press **↵**.
SAVE appears.
Then press **↵** again.
– or –
To reject changes: Press **↵T↵**.
AbOrt appears.
Press **↵**.

6 Supervisor menu

In addition to the blocks of the user menu, the following blocks can be accessed in the Technician menu:

- F1 – Scale settings
- F5 – Terminal settings
- F6 – Exit menu

6.1 Entering Supervisor menu

1. In gross mode, press and hold  until **MAStEr** appears in the display.
1. Enter password     and confirm with . **SEtUP** appears in the display.
1. Press . **F1** appears in the display. All parameters can be modified.

Information for certified weighing systems (OIML or NTEP)

The parameters F1, F5.1 und F5.4 are disabled at certified weighing systems. Proceed as follows in order to change these parameters:

1. Switch off weighing terminal and open.
2. Use a jumper to close the W&M solder bridge on the mainboard.
3. Close the cover and switch on the weighing terminal. **SEtUP** is displayed. All the parameters can be modified.
4. Save the modified configuration (F6).
appears in the display.
5. Switch off weighing terminal and open.
6. Open the W&M solder bridge by removing the jumper.
7. Close the cover and seal the weighing terminal.

6.2 Operating the Supervisor menu

Operating the Supervisor menu is the same as in the Operator menu, see page 18.

6.3 Block F1 – Scale

Factory settings are printed in *bold* letters.

F1.1 – Approval

no *no approval*
 approval according to OIML
 approval according to NTEP
 for other approvals

F1.2.1 – Weight units

1 weight unit: *kg*
 weight unit: lb 1 lb \approx 0.454 kg

F1.2.3 – Capacity

Possible capacities and the factory settings depend on the weighing platform connected.

If necessary, modify the displayed value.

Factory setting **3 kg**

F1.2.4 – Resolution

Possible resolutions and the factory settings depend on the weighing platform connected.

1. If necessary, modify the displayed value.

Factory setting **0.001 kg**

F1.3.1 – Geo value

Adaptation of the weighing platform to the geographical location, see table in the annex.

Possible settings 0 ... 31

Factory setting **16**











F1.3.2 – Linearization during adjustment

LinOFF Linearization *disabled*

LinOn Linearization enabled (3 point linearization)

F1.3.3 – Adjustment

The steps with grey background only appear if parameter is set.

<i>Display</i>	<i>Key</i>	<i>Description</i>
E SCL		Unload weighing platform
		Confirm empty weighing platform
10 CAL ... 0 CAL		The weighing terminal counts down from 10 to 0. The zero point is determined
Add Ld		Load half of the maximum load
		Confirm half load
000000		Enter weight value for half maximum load
	  	Enter weight value
003000		Weight value for half of the maximum load entered
		Confirm weight value
10 CAL ... 0 CAL		The weighing terminal counts down from 10 to 0. Half maximum load is adjusted
FULL Ld		Load maximum load
		Confirm maximum load
000000		Enter weight value of maximum load
	  	Enter weight value
006000		Weight value for maximum load entered
		Confirm weight value
10 CAL ... 0 CAL		The weighing terminal counts down from 10 to 0. Maximum load is adjusted
done		Adjustment finished. This message is displayed for about 2 seconds
F1.4		Next block in the supervisor menu

F1.3.4 – CalFREE

The CalFREE procedure can be used at tank and silo scales. It is used to precalibrate the weighing system without calibration weights.

CalFREE offers simple and rapid calibration when the use of calibration weights is not possible or when the readability > 0.2% of the weighing capacity. The CalFREE procedure calibrates only the internal A/D converter of the IND226x. Mechanical influences and vibrations are *not* compensated.

In order to achieve the best results we recommend interconnecting the individual weighing cells via a junction PCB without rotary potentiometers.

F1.3.4.1 – Entering the total weighing cell capacity

The total weighing cell capacity E_{\max} is the total of the individual capacities.

Determine the total weighing cell capacity E_{\max} and use the $\rightarrow 0 \leftarrow$, $\rightarrow T \leftarrow$ and F keys to enter it.

Example 4 weighing modules with 500 kg each result in a total weighing cell capacity $E_{\max} = 2000$ kg.

F1.3.4.2 – Selecting the weight unit of the weighing cell capacity

1 kg
 lb

F1.3.4.3 – Entering the mean value of the output signals

Determine the mean value up to 3 decimal places and use the $\rightarrow 0 \leftarrow$, $\rightarrow T \leftarrow$ and F keys to enter it.

Permissible values: 0 to 3 mV/V

Example Weighing module 1 output signal S1 = 1.990 mV/V
Weighing module 2 output signal S2 = 2.002 mV/V
Weighing module 3 output signal S3 = 1.998 mV/V
Weighing module 4 output signal S4 = 1.995 mV/V

Mean value from S1 ... S4 S = 1.996 mV/V

F1.3.4.4 – Entering the preload range of the weighing system

Enter the preload range by using the keys $\rightarrow 0 \leftarrow$, $\rightarrow T \leftarrow$ and F .

F1.3.4.5 – Starting the CalFREE procedure

Display	Key	Description
E SCL		Unload weighing platform
		Confirm empty weighing platform
10 CAL ... 0 CAL		The weighing terminal counts downwards from 10 to 0 The internal A/D converter is calibrated
F1.3		CalFREE procedure terminated, return to F1.3

F1.4.1 – Automatic zero setting

- Automatic zero setting disabled
- 0.5 d** Automatic zero setting within ± 0.5 d
- Automatic zero setting within ± 1.0 d
- Automatic zero setting within ± 3 d

F1.4.2 – Power up zero

- Power up zero disabled
- Power up zero within ± 2 %
- 10** Power up zero within ± 10 %
- Power up zero within ± 20 %

F1.4.3 – Pushbutton zero

- Pushbutton zero disabled
- 2** Pushbutton zero with ± 2 % zero setting range
- Pushbutton zero with ± 10 % zero setting range
- Pushbutton zero with ± 20 % zero setting range

F1.5.1 – Automatic taring

- Automatic taring enabled
- OFF** Automatic taring *disabled*

F1.5.2 – Auto clear tare

- Clearing tare automatically enabled
- OFF** Clearing tare automatically *disabled*

F1.5.3 – Tare Interlock

- The weighing platform must be unloaded to zero before the tare weight can be cleared.
- OFF** Function *disabled*

F1.5.4 – Auto tare threshold

This menu item is only available if is set.

The weighing platform must be loaded to the set value before the weight value is automatically tared.

Factory setting 10 d

Possible settings 0 ... maximum load

F1.5.5 – Auto clear tare threshold

This menu item is only available if is set.

The weighing platform must be unloaded below the set value before a new weight value can be tared automatically.

If is set, the weighing platform must be unloaded to the set value before the tare value is cleared automatically.

Factory setting 10 d

Possible settings 0 ... maximum load

F1.5.6 – Restart

If the Restart function is activated, the last zero point and the tare value are stored. The terminal operates with the stored zero point and tare value after it has been switched off and on or after a power interruption.

OFF Restart function *de-activated*
 Restart function activated

F1.6.1 – Digital filter

The digital filter stabilizes the weight display when the load is moving or vibrating.

Low filter
MEd Medium filter
 High filter

F1.6.2 – Motion detection

0.5 d Motion detection within ± 0.5 d
 Motion detection within ± 1 d
 Motion detection within ± 3 d

F1.10 – Resetting parameters 1.x(.x) to factory setting

Only parameter settings are reset, the adjustment is saved.

6.4 Block F5 – Maintenance

Factory settings are printed in *bold* letters.

F5.1 – Display of calibration values

In this menu the following calibration values can be called up:

F5.1.1 – Show zero-counts

F5.1.2 – Show half load weight value

F5.1.3 – Show half load counts

F5.1.4 – Show full load weight value

F5.1.5 – Show full load weight counts

F5.2– Keypad test

The terminal shows **PrESS**.

Press   **F** **G** .

Press  to exit keypad test.

F5.3 – Display test

All display segments light up.

F5.4 – Internal resolution of the display

The current weight value is displayed in "RawCounts".

F5.5 – COM1 test

To this purpose the terminal has to be connected to a computer via the interface converter ACM200 In addition the Interface IND data interface has to be installed in the IND226x.

F5.6 – Testing the digital input

The digital input is tested.

F5.7 – Print setup

Output all the parameters via the data interface.

F5.8 – Entering the serial number

The 10-digit serial number of the weighing terminal has to be entered in 2 blocks in the reverse order.

1. Activate F5.8.
H – is displayed in the display.
2. Enter the first 5 digits of the serial number in the reverse order (Digit 5, ... Digit 1).
3. Press $\rightarrow T \leftarrow$.
L – is displayed in the display.
4. Enter the last 5 digits of the serial number in the reverse order (Digit 10, ... Digit 6).

F5.10 – General reset

Reset all parameters of groups F1 to F4 to factory settings.

7 Interface commands

7.1 SICS interface commands

The weighing terminal supports the MT-SICS (METTLER TOLEDO Standard Interface Command Set) command set. With SICS commands, it is possible to configure, query and operate the terminal from a PC. SICS commands are divided up into various levels.

For further information about the MT-SICS command set, see MT-SICS Manual (Order No. 00 705 184) or contact the METTLER TOLEDO Customer Service.

	<i>Command</i>	<i>Meaning</i>
LEVEL 0	@	Reset the scale
	I0	Inquiry of all available SICS commands
	I1	Inquiry of SICS level und SICS version
	I2	Inquiry of scale data
	I3	Inquiry of scale software version
	I4	Inquiry of serial number
	S	Send stable weight value
	SI	Send weight value immediately
	SIR	Send weight value immediately and repeatedly
	Z	Zero the scale
	ZI	Zero immediately
LEVEL 1	T	Tare
	TAC	Clear tare
	TI	Tare immediately

7.2 Toledo Continuous Mode

The weighing terminal supports the Toledo Continuous Mode for continuous transfer of weight data and status information, for example to a PC or a secondary display. At a baud rate of 2400 bauds and higher, a data string is transferred approximately 9 times per second. The transfer rate is slower if the baud rate is lower.

7.2.1 Toledo Continuous commands

<i>Command</i>	<i>Meaning</i>
<i>P</i>	Print out the current result
<i>T</i>	Tare the scale
<i>Z</i>	Zero the display
<i>C</i>	Clear the current value
<i>U</i>	Switching the weight unit

7.2.2 Toledo Continuous output format

Weight values are always transmitted in the following format:

STX	SB1	SB2	SB3	DF1	DF2	CR	CHK
-----	-----	-----	-----	-----	-----	----	-----

STX	ASCII characters 02 hex/2 deci, character for "start of text"
SB...	For status bytes, see below
DF1	Data field with 6 digits for the weight value (gross or net), transmitted without a decimal point and unit, leading zeroes replaced by blank spaces
DF2	Data field with 6 digits for the tare weight; transmitted without a decimal point and unit, leading zeroes replaced by blank spaces
CR	Carriage return (ASCII character 0D hex/13 deci)
CHK	Checksum (2-part complement of binary sum of 7 lower bits of all previously transmitted characters, including STX and CR), transmitted only if activated in the menu

Status byte SB1

<i>Bit 6</i>	<i>Bit 5</i>	<i>Bit 4</i>	<i>Bit 3</i>	<i>Bit 2</i>	<i>Bit 1</i>	<i>Bit 0</i>
0	1	Rounding / Increment		Decimal position		

<i>Bit 4</i>	<i>Bit 3</i>	<i>Rounding/ Increment</i>
0	1	x1
1	0	x2
1	1	x5

<i>Bit 2</i>	<i>Bit 1</i>	<i>Bit 0</i>	<i>Decimal position</i>
0	0	0	XXXX00
0	0	1	XXXXX0
0	1	0	XXXXXX
0	1	1	XXXXX.X
1	0	0	XXXX.XX
1	0	1	XXX.XXX
1	1	0	XX.XXXX
1	1	1	X.XXXXX

Status byte SB2

<i>Bit 6</i>	<i>Bit 5</i>	<i>Bit 4</i>	<i>Bit 3</i>	<i>Bit 2</i>	<i>Bit 1</i>	<i>Bit 0</i>
1	1	0 lb	0 Stabilization	0 Normal status	0 Positive sign	0 Gross value
		1 kg	1 Movement	1 Underload/ overload	1 Negative sign	1 Net value

Status byte SB3

<i>Bit 6</i>	<i>Bit 5</i>	<i>Bit 4</i>	<i>Bit 3</i>	<i>Bit 2</i>	<i>Bit 1</i>	<i>Bit 0</i>
0	1	0 Normal status	0 Normal status	Weight unit		
		1 High resolution (x 10)	1 Print request			

<i>Bit 2</i>	<i>Bit 1</i>	<i>Bit 0</i>	<i>Weight unit</i>
0	0	0	kg / lb (SB2 Bit 4)
0	0	1	g
0	1	0	t
0	1	1	oz
1	0	0	ozt
1	0	1	dwt
1	1	0	ton
1	1	1	free unit

8 Error messages

Error code	Error	Remedy
Err 3	<ul style="list-style-type: none"> EEPROM error 	Turn the weighing terminal off and on
Err 6	<ul style="list-style-type: none"> EEPROM read/write error 	Call METTLER TOLEDO Service
Err 32	<ul style="list-style-type: none"> Impermissible values entered in Block F1 	Repeat the entry with correct values If the message is displayed again, inform the METTLER TOLEDO Service
Err 35	<ul style="list-style-type: none"> Weighing platform in motion when calibrating 	Ensure that the weighing platform is stable
Err 70	<ul style="list-style-type: none"> Keypad error 	Call METTLER TOLEDO Service
EEE	<ul style="list-style-type: none"> In case of certified weighing platforms: Zero setting range exceeded during switching on 	Unload weighing platform
-EEE	<ul style="list-style-type: none"> In case of certified weighing platforms: Zero setting range below limit during switching on 	Place the load plate on (correctly)
no DTA	<ul style="list-style-type: none"> Secondary display does not receive any valid data 	Check the communication settings Check data cable connections If the message is displayed again, inform the METTLER TOLEDO Service
L _ _ _ _ J	<ul style="list-style-type: none"> Underload 	Press  If the message reappears, call METTLER TOLEDO Service
r _ _ _ _ 7	<ul style="list-style-type: none"> Overload 	Decrease load
r - n 0 - 7 L - n 0 - J	<ul style="list-style-type: none"> Zero setting outside zero setting range 	Unload weighing platform
- - n 0 - -	<ul style="list-style-type: none"> Cannot perform the key function 	Go back to gross mode
- - - - -	<ul style="list-style-type: none"> Cannot perform the key function, scale is in motion 	Ensure that the weighing platform is stable
Weighing terminal switches off automatically	<ul style="list-style-type: none"> Automatic switching-off activated Battery level too low 	Unload the weighing platform and, if appropriate, configure Display Timeout and Power Off differently Charge the Battery Pack
Weighing terminal remains dark after being switched on	<ul style="list-style-type: none"> No or incorrect voltage supply 	Check supply unit connection Call the METTLER TOLEDO Service

9 Technical data and accessories

9.1 Technical data

<i>Explosion protection IND226x, Interface IND, Interface Remote</i>	
Ignition protection type	ATEX II 2G Ex ib IIC T4 II 2D Ex tD A21 T60 °C cFMUS IS Class I, II, III, Div. 1, Group A, B, C, D, E, F, G / T4 T _a 40 °C
<i>Metrological data</i>	
Input signal range	0 to 3 mV/V
Supply voltage	5 V
Weighing platform impedance	87.5 ... 1050 Ω
Smallest perm. certif. incr.	0.80 μV/e
Fraction of the error limit (P _i)	0.5
Number of weighing cells	max. 4
Max. number of certifiable increment values	≤ 6000 e
Scale configuration	Single range (SR)
<i>Maximum cable length</i>	
Weighing platform – IND226x	max. 20 m
APS50. – IND226x	max. 15 m
PSUx – IND226x	max. 50 m
Battery Pack – IND226x	max. 3 m
ACM200 – IND226x	max. 300 m

<i>General technical data</i>	
Display	Weight value: 7-segment display, 6 digits, 30 mm high Status indication: 10 indicators
Housing	stainless steel
Protection type	IP66
Power supply	APS500/501 power supply unit alternatively via external Battery Pack or PSUx
Data interface	1 serial intrinsically safe data interface: Interface IND for communication with peripheral devices in the safe area Alternatively: Interface Remote for operating the IND226x as a secondary display
Digital inputs	1 digital input
Weight (incl. packaging)	2.5 kg
<i>Ambient conditions</i>	
Operating temperature	-10 ... +40 °C
Storage temperature	-20 ... +60 °C
Relative humidity	10 ... 85 %, non-condensing
Operating altitude	up to 2000 m above sea level, indoors

Dimensions

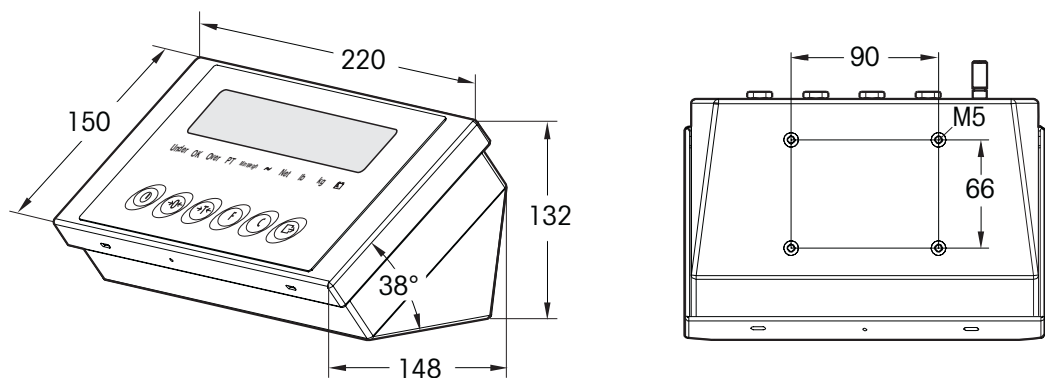

Dimensions in mm

9.2 Technical data for ACM200

<i>Explosion protection</i>	
Ignition protection type	EN II (2) GD [Ex ib] IIC cFM _{US} AIS Class I, II, III; Division 1; Group A, B, C, D, E, F, G
<i>General technical data</i>	
Housing	Stainless steel
Protection type	IP66
Power supply	Wide range power supply unit 100 ... 240 VAC 50/60 Hz
Data interface	RS232
Weight (incl. packaging)	3,4 kg
<i>Ambient conditions</i>	
Operating temperature	-10 ... +40 °C
Storage temperature	-20 ... +60 °C
Relative humidity	10 ... 85 %, non-condensing
<i>Connection cables</i>	
Cable to IND226x	10 m, premounted at the factory, intrinsically safe, with M16x1.5 screwing
Cable to peripheral devices	10 m, premounted at factory, RS232 Sub-D connector (female)
Power connection cable	2.4 m, with earthing-pin plug

Dimensions

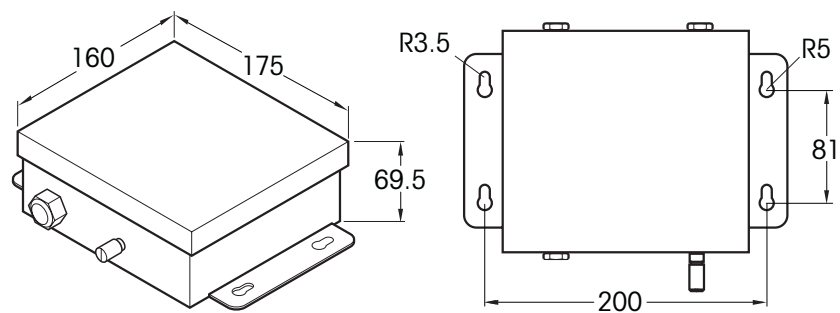

Dimensions in mm

9.3 Accessories

<i>Accessories</i>	<i>Description</i>	<i>Order number</i>
Interface IND	Serial data interface (active) for installation in the IND226x, communication with peripheral devices in the safe area	22 018 019
Interface Remote	Serial data interface (passive) for installation in the IND226x, remote function of the IND226x	22 018 020
Scale stand for PBA430x	For mounting the weighing terminal to the weighing platform, stainless Height 330 mm Height 660 mm	22 010 334 22 010 335
Floor stand	For free installation of the weighing terminal including mounting material for screwing to the floor, stainless, rustproof	00 504 132
Stand base	For movable installation of the floor stand, rustproof	00 503 701
Wall bracket	For mounting the weighing terminal to the wall, including mounting screws, rustproof	00 504 130
Bench stand S	For fastening the weighing terminal to PBA430x, 600 x 800 mm, rustproof	00 504 128
ID retainer	For mounting the weighing terminal to the shaft of the pallet scale PTA459x	22 012 196

10 Appendix

10.1 Disposal



In conformance with the European Directive 2002/96/EC on Waste Electrical and Electronic Equipment (WEEE), this device may not be disposed of in domestic waste. This also applies to countries outside the EU as per their specific regulations.

Please dispose of this product in accordance with local regulations at the collecting point specified for electrical and electronic equipment.

If you have any questions, please contact the responsible authority or the distributor from which you purchased this device.

Should this device be passed on to other parties (for private or professional use), the content of this regulation must also be related.

Thank you for your contribution to environmental protection.

10.2 Declarations of conformity

METTLER TOLEDO

Legal Metrology

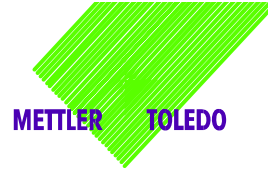

Declaration of Conformity

Konformitätserklärung
Déclaration de conformité
Declaración de Conformidad
Conformiteitsverklaring
Dichiarazione di conformità

We, Wir, Nous, Nosotros, Wij, Noi

Mettler-Toledo (ChangZhou) Measurement Technology Ltd.
111 West TaiHu Road, XinBei District, ChangZhou, JiangSu, 213125, P.R.China

Declare under our sole responsibility that the product,
erklären, in alleiniger Verantwortung, dass dieses Produkt,
déclarons sous notre seule responsabilité que le produit,
declaramos, bajo nuestra sola responsabilidad, que el producto,
verklaren onder onze verantwoordelijkheid, dat het product,
dichiariamo sotto nostra unica responsabilità, che il prodotto,

Model/Type: IND226x weighing terminal (EC test certificate: TC6862)

to which this declaration relates, is in conformity with the following standard(s) or other normative document(s).
auf das sich diese Erklärung bezieht, mit der/den folgenden Norm(en) oder Richtlinie(n) übereinstimmt.
Auquel se réfère cette déclaration est conforme à la (aux) norme(s) ou au(x) document(s) normatif(s).
Al que se refiere esta declaración es conforme a la(s) norma(s) u otro(s) documento(s) normativo(s).
Waarnaar deze verklaring verwijst, aan de volende norm(en) of richtlijn(en) beantwoordt.
A cui si riferisce questa dichiarazione è conforme alla/e sequente/i norma/e o documento/i normativo/i.

EC marking	EC Directive:	Applicable Standards.	
	2004/108/EC EMC	EN61000-6-1 EN61000-6-3 EN61000-4-3(10V/m) EN61000-4-6(10V/m)	
	94/9/EC ATEX	EN 60079-0: 2006 EN 60079-11: 2007 EN 61241-0: 2006 EN 61241-1: 2004	EXAM BBG 1) BVS 07 ATEX E015
For non-automatic weighing instrument used in an Article 1,2.(a) application ,additional metrological marking according to Annex IV of Council Directive 2009/23/EC must be attached to the instrument.			
	2009/23/EC Non-automatic weighing instruments	EN 45501:1992 /AC:1993 2)	

- 1) Certificate issued by EXAM BBG Prüf-und Zertifizier GmbH., 44809 Bochum, Germany, notified body no. 0158
- 2) Applies to certified non automatic weighing instruments only in connection with approved load cells
gilt nur für geeichte Waagen in Verbindung mit zugelassenen Wägezellen
valable uniquement pour les balances vérifiées avec des cellules de charge homologuées
sola aplicable a balanzas verificadas en combinación con células de carga aprobadas
la dichiarazione vole sola per le bilance omologate in collegamento con celle die carico approve

Issued on: 2007-12-1 Revised on: 2010-7-16
Mettler-Toledo (ChangZhou) Measurement Technology Ltd.

Zhu Dan
General Manager

Yang JiaWu
QA Manager

Mettler-Toledo (ChangZhou) Scale System Ltd.

EC-Declaration of Conformity

EC-Konformitätserklärung
 EC-Déclaration de conformité
 EC-Declaración de Conformidad
 EC-Conformiteitsverklaring
 EC-Dichiarazione di conformità

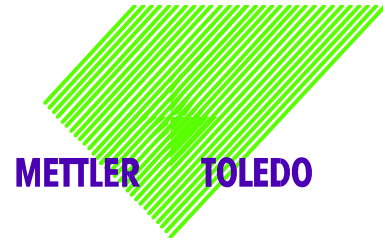

We, Wir, Nous, Nosotros, Wij, Noi

Mettler-Toledo (ChangZhou) Scale System Ltd.
 No.111, West Tai Hu Road, XinBei District, ChangZhou, JiangSu, 213125, P.R.China

declare under our sole responsibility that the product,
 erklären, in alleiniger Verantwortung, daß dieses Produkt,
 déclarons sous notre seule responsabilité que le produit,
 declaramos, bajo nuestra sola responsabilidad, que el producto,
 verklaren onder onze verantwoordelijkheid, dat het product,
 dichiariamo sotto nostra unica responsabilità, che il prodotto,

Model/Type: ACM200 Communication module

To which this declaration relates , is in conformity with the following standard(s) or other normative document(s),
 auf das sich diese Erklärung bezieht, mit/der/den folgenden Norm(en) oder Richtlinie(n) übereinstimmt.
 Auquel se réfère cette déclaration est conforme à la (aux) norme(s) ou au(x) document(s) normatif(s).
 Al que se refiere esta declaración es conforme a la(s) norma(s) u otro(s) documento(s) normativo(s).
 Waarnaar deze verklaring verwijst, aan de volende norm(en) of richtlijn(en) beantwoordt.
 A cui si riferisce questa dichiarazione è conforme alla/e sequente/i norma/e o documento/i normativo/i.

EC Directive	Applicable Standards
94/9/EC Directive	EN60079-0:2006 EN60079-11:2007 **
2006/95/EC Low Voltage Directive	EN61010-1: 2001
2004/108/EC EMC Directive	EN61000-6-1 EN61000-6-3 EN61000-4-3(10V/m) EN61000-4-6(10V/m)
2002/95/EC RoHS Directive	N/A

** ATEX certificate: BVS 07 ATEX E 149, EXAM 0158, 44809 Bochum, Germany

No.111, West TaiHu Road, XinBei District , ChangZhou, JiangSu. 213125,PRC, Nov 7, 2007,Mettler-Toledo (ChangZhou) Scale & System Ltd.

Yang JiaWu

Quality Assurance Manager

ServiceXXL
Tailored Services

Congratulations on choosing the quality and precision of METTLER TOLEDO. Proper use according to these instructions and regular calibration and maintenance by our factory-trained service team ensure dependable and accurate operation, protecting your investment. Contact us about a ServiceXXL agreement tailored to your needs and budget.

We invite you to register your product at www.mt.com/productregistration so we can contact you about enhancements, updates and important notifications concerning your product.



72203952B

Subject to technical changes © Mettler-Toledo (Changzhou) Measurement Technology Ltd. 08/10 72203952B

Mettler-Toledo (Changzhou) Measurement Technology Ltd.

10 Kunlun Road, Changzhou Xinbei District, Jiangsu Province, P.R. China 213125

Tel. 0086-519-664-2040

Fax 0086-519-664-1991

Internet <http://www.mt.com>