

Quantos Dosing System



METTLER TOLEDO

Table of Contents

1	Introduction	7
	1.1	Conventions and Symbols Used in these Operating Instructions 7
	1.2	Finding More Information 7
	1.3	Quantos Product Modules Overview 8
2	Safety Information	9
	2.1	Definition of Warnings and Symbols 9
	2.2	Product Specific Safety Notes 9
3	Design and Function	11
	3.1	Overview 11
	3.2	Terminal 12
	3.3	Display 13
4	Installation and Putting into Operation	15
	4.1	Scope of Delivery 15
	4.2	Location 16
	4.2.1	Selecting the Location 16
	4.2.2	Levelcontrol 17
	4.3	Wiring the Components 18
	4.3.1	QA Series 18
	4.3.2	QB Series 19
5	Operation	20
	5.1	First Steps 20
	5.1.1	Switching On / Off 20
	5.1.2	First Dosing 21
	5.1.2.1	Dosing Head 21
	5.1.2.2	Installing Dosing Head 21
	5.1.2.3	Dose 21
	5.2	Basic Operation 24
	5.2.1	Typical Configuration Menu Overview 24
	5.2.2	Security System 25
	5.2.3	Glass Draft Shield 25
	5.3	Dosing Heads 26
	5.3.1	General Information 26
	5.3.2	Handling of Powder Dosing Heads and Containers 27
	5.3.3	Data Stored in the Dosing Head's RFID 28
	5.3.4	Displaying Head Information 28
	5.3.5	Selecting Function Key [Set content] 28
	5.3.6	Preparing a new Head for Operation 29
	5.3.7	Copying Data from one Head to Another 31
	5.3.8	Unlocking the Head Manually 32
	5.4	Advanced Features 32
	5.4.1	Working with Sample Counter 32
	5.4.2	Changing the Resolution of Dosing Result 32
	5.4.3	Manual Dosing 32
	5.4.4	Working with the "MinWeigh" Function 33
	5.4.5	Working with "SafePos" 34

5.4.6	Best Practice of User Profiles	35
5.5	Adjusting the Instrument	36
5.5.1	ProFACT Fully Automatic Adjustment	36
5.5.2	Adjusting with Internal Weight	36
5.5.3	Adjusting with External Weight	37
5.5.4	Testing Adjustments with Internal Weight	37
5.5.5	Testing Adjustments with External Weight	37
5.6	Auto Sampler	38
5.6.1	Overview	38
5.6.2	Scope of Delivery - Auto Sampler	38
5.6.3	Operation	38
5.6.3.1	Basics of Auto Sampler	38
5.6.3.2	Working with Auto Sampler	39
5.6.3.3	Selecting the Auto Sampler	39
5.6.3.4	Notes on the "SafePos" Function	40
5.6.3.5	Loading the magazines	40
5.6.3.6	Dosing with Auto Sampler	40
5.6.3.7	Aborting a Running Dosing Cycle	41
5.6.3.8	One Single Dosing	41
5.6.3.9	Using the Weight Basket	41
5.7	Liquid Module	42
5.7.1	Overview	42
5.7.2	Function	42
5.7.3	Scope of Delivery - Liquid Module	43
5.7.4	Wiring the Components	43
5.7.5	Operation	44
5.7.5.1	First Steps	44
5.7.5.2	Special Workflows	45
5.7.5.3	Handling of Bottle	46
5.7.5.4	Basic Operation Settings	47
5.7.5.5	Activating Density	48
5.8	Upgrade Differences	48
5.8.1	Overview	48
5.8.2	Scope of Delivery - Upgrade	49
5.8.3	Wiring the Components	50
5.8.4	Operation	50
5.8.4.1	Glass Draft Shield	50
5.8.4.2	Releasing Pressure	50
6	Settings	51
6.1	User Profiles	51
6.2	Application Settings	51
6.2.1	Selecting Function Keys	53
6.2.2	Selecting Information Fields	55
6.2.3	Defining Data Output	55
6.2.3.1	Specifying the Contents of Sample Data Labels	56
6.2.3.2	Specifying the Contents of Sample Data Records	59
6.2.3.3	Defining the Target Devices for Sample Data	60
6.2.3.4	Defining the Output Mode for Sample Data	60
6.2.3.5	Defining the Output of Dosing Head Data	61

6.2.3.6	Specifying Info Head	61
6.2.4	Configuring the Dosing Steps	61
6.2.5	Selecting the Tolerance Mode	62
6.2.6	Setting up the Head Definition Data	62
6.2.7	Selecting the Dosing Algorithm	62
6.2.8	Selecting the Display Unit	62
6.2.9	Defining Titles	63
6.2.10	Specifications for External Devices	63
6.2.11	Settings for the "MinWeigh" Function	63
6.2.12	Settings for SmartSens and ErgoSens	64
6.2.13	Configuring the Side Doors	65
6.2.14	Configuring the Front Door	65
6.2.15	Configuring the Auto Sampler	65
6.2.16	Configuring the Liquid Module	66
6.2.17	Settings for the Tapper	66
6.2.18	Setting for "SafePos" Option	67
6.2.19	Settings for the Dosing Unit	67
6.2.20	Maintenance	67
6.3	User Settings	69
6.3.1	Defining Weighing Parameters	69
6.3.2	Entering User Data	70
6.3.3	Settings for the Side Doors	71
6.3.4	Terminal Settings	72
6.3.5	Resetting User Settings	73
6.4	System Settings	74
6.4.1	Settings for Adjustment and Tests	75
6.4.1.1	Displaying Recorded Adjustments	75
6.4.1.2	Fully Automatic Adjustment – ProFACT	76
6.4.1.3	Automatic Adjustment	76
6.4.1.4	Defining Adjustment Weights	77
6.4.1.5	Automatic Adjustment Testing	77
6.4.1.6	Defining Test Weights	78
6.4.1.7	Defining Adjustment and Test Reports	78
6.4.2	Instrument Information	78
6.4.3	Standby	78
6.4.4	Date and Time	79
6.4.5	Selecting Peripheral Devices	80
6.4.6	Establishing Global Settings for the Ethernet Interface	81
6.4.7	Configuring the Security System	81
6.4.8	Settings for the Level Sensor	83
7	Maintenance	85
7.1	Cleaning	85
7.2	Cleaning the Auto Sampler	86
7.2.1	Quick Cleaning Procedure	86
7.2.2	In-depth Cleaning	86
7.2.3	Check After Cleaning	87
7.3	Cleaning the Liquid Module	87
7.4	Disposal	88

8	Troubleshooting		89
	8.1	Error Messages	89
	8.2	Status Icons	93
	8.3	Fault Prevention	94
	8.3.1	Storage of Dosing Heads and Powder	94
	8.3.2	Target Quantities and Tolerances	95
	8.3.3	Preventing Electrostatic Charge	95
9	Technical Data		97
	9.1	General Data	97
	9.2	Explanatory Notes for the METTLER TOLEDO AC Adapter	98
	9.3	Model-Specific Data	99
	9.4	Dimensions	103
10	Accessories and Spare Parts		107
	10.1	Accessories	107
	10.2	Spare Parts	112
11	Appendix		114
	11.1	Overview Menu	114
12	Index		124

1 Introduction

Thank you for purchasing the Quantos dosing system.

Quantos is based on the renowned and reliable XP series balances from METTLER TOLEDO. Besides the highly accurate dosing capabilities and ease of use, the Quantos provides connectivity to a variety of peripheral devices (e.g. barcode readers, label printers), and to a host computer.

This chapter contains basic information about the Quantos. Please read this chapter carefully, even if you already have experience with dosing systems or analytical balances.

The operating instructions are based on the initially installed firmware (software) version V 3.30.

1.1 Conventions and Symbols Used in these Operating Instructions

For better readability the **Quantos Dosing System** is further referred to as **instrument**.

Key designations are indicated by a picture or text in square brackets (e.g.  or **[Printer]**).



This symbol indicates press key briefly (less than 1.5 s).



This symbol indicates press and hold key down (longer than 1.5 s).

These symbols indicate an instruction:





- ▶ prerequisites
- 1 steps
- 2 ...
- ⇒ results

1.2 Finding More Information

Internet <http://www.mt.com/quantos>

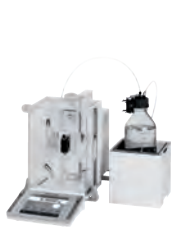
1.3 Quantos Product Modules Overview

Quantos 1-series

	QA1-L	QB1-P	QB1-PL	QB1-PS	QB1-PLS
					
Powder	-	P	P	P	P
Liquid	L	-	L	-	L
AutoSampler	-	-	-	S	S
Minimum sample weight	xx mg	xx mg	xx mg	xx mg	xx mg

Quantos 3-series

	QA3-L	QB3-P	QB3-PL	QB3-PS	QB3-PLS
Powder	-	P	P	P	P
Liquid	L	-	L	-	L
AutoSampler	-	-	-	S	S
Minimum sample weight	21 mg	15 mg	15 mg	15 mg	15 mg

Quantos 5-series

	-	QB5-P	QB5-PL	QB5-PS	QB5-PLS
Powder	-	P	P	P	P
Liquid	-	-	L	-	L
AutoSampler	-	-	-	S	S
Minimum sample weight	-	9 mg	9 mg	9 mg	9 mg

Quantos 7-series

	-	QB7-P	QB7-PL	-	-
Powder	-	P	P	-	-
Liquid	-	-	L	-	L
AutoSampler	-	-	-	-	-
Minimum sample weight	-	4 mg	4 mg	-	-

If you need to configure and control your instrument via external commands, please contact your METTLER TOLEDO dealer.

Also see

- Working with "SafePos" (page 34)
- Auto Sampler (page 38)
- Liquid Module (page 42)

2 Safety Information

2.1 Definition of Warnings and Symbols

Signal Words

WARNING	for a hazardous situation with medium risk, possibly resulting in severe injuries or death if not avoided.
CAUTION	for a hazardous situation with low risk, resulting in damage to the device or the property or in loss of data, or minor or medium injuries if not avoided.
Attention	(no symbol) for important information about the product.
Note	(no symbol) for useful information about the product.

Symbols

	General hazard		Electrical shock
	Inflammable or explosive substance		Heavy object

2.2 Product Specific Safety Notes

Always operate and use your instrument only in accordance with the instructions contained in this manual. The instructions for setting up your new instrument must be strictly observed.

If the instrument is not used according to these Operating Instructions, protection of the instrument may be impaired and METTLER TOLEDO assumes no liability.

Intended Use

Your Dosing System is used for weighing and dosing powder or liquid samples. Use the instrument exclusively for this purpose. Any other type of use and operation beyond the limits of technical specifications without written consent from Mettler-Toledo AG, is considered as not intended.



It is not permitted to use the instrument in explosive atmosphere of gases, steam, fog, dust and flammable dust (hazardous environments).

**CAUTION****Damage of device**

- For use only in dry interior rooms.
 - Do not use sharply pointed objects to operate the keyboard! Although your instrument is very ruggedly constructed, it is nevertheless a precision instrument. Treat it with corresponding care.
 - Do not open the instrument: It does not contain any parts which can be maintained, repaired, or replaced by the user. If you ever have problems with your instrument, contact your METTLER TOLEDO dealer.
 - Use only instrument accessories and peripheral devices from METTLER TOLEDO; they are optimally adapted to your instrument.
-

**CAUTION****Damage of Device**

Use only the original universal AC adapter delivered with your instrument.

**WARNING****Heavy object**

- Single person lift could cause injury.
 - Do not move or lift this equipment without assistance.
-

Certain samples require special care!

With certain types of samples, there is a possibility of danger to personnel or damage of property. Please note that the user always has the responsibility and liability for damage caused by use of any types of samples!

**CAUTION — Fire or Explosion**

- Flammable or explosive substances.
 - Substances containing solvents.
1. In cases of doubt, perform a careful risk analysis.
 2. Working temperature that is low enough to prevent the formation of flames or an explosion.
 3. Wear protective glasses.

3 Design and Function

3.1 Overview

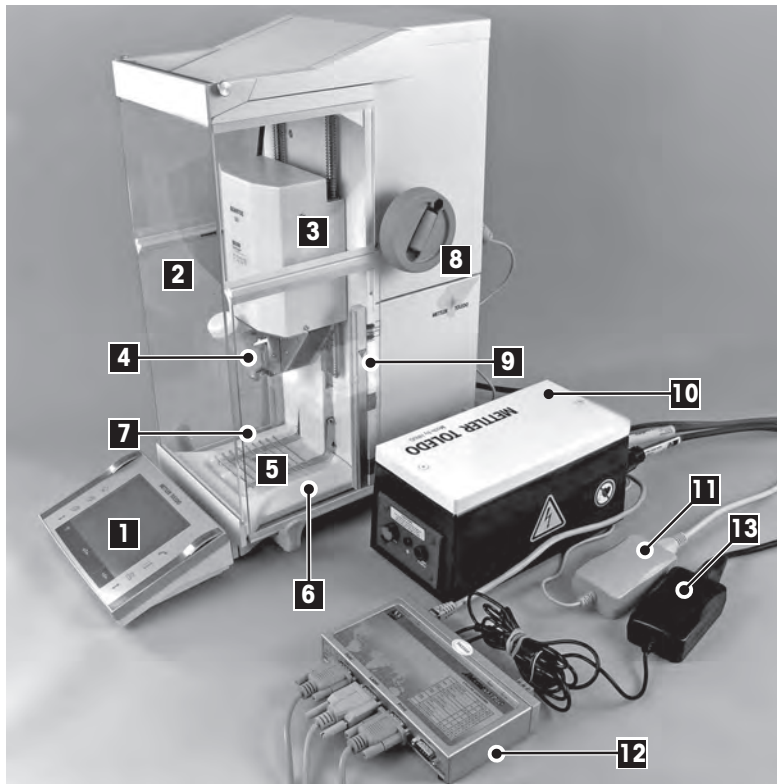

- 1 Terminal
- 2 Front door
- 3 Dosing unit
- 4 Dosing head
- 5 Weighing pan
- 6 Drip pan
- 7 Side doors
- 8 Head height adjustment handle
- 9 Electrode (AntiStatic Kit)
- 10 High-voltage power adapter (AntiStatic Kit)
- 11 AC adapter for instrument
- 12 Ethernet-to-Serial converter
- 13 AC adapter for Ethernet-to-Serial converter



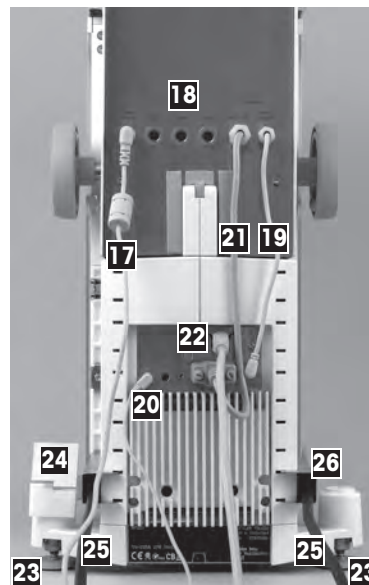
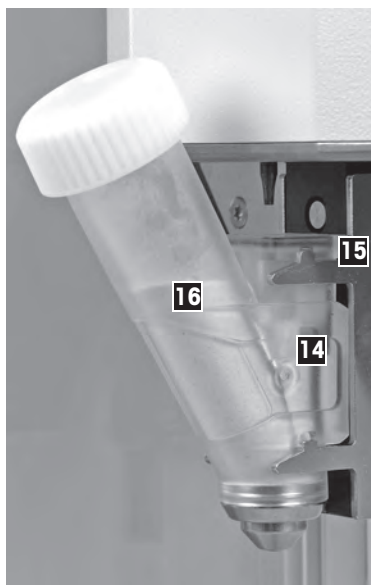

Dosing head on backside



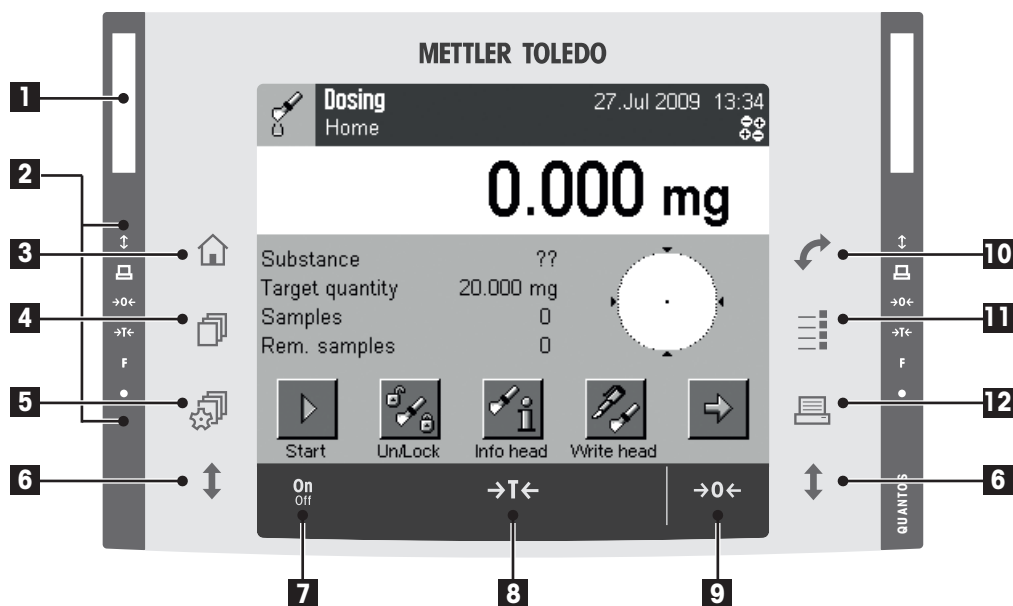



- 14 Dosing head base with RFID chip
- 15 Dosing head support
- 16 Built-in powder container
- 17 Power supply cable (from AC adapter)
- 18 Connectors for Auto Sampler and CAN devices
- 19 Power supply cable from dosing unit to balance
- 20 Aux connectors (Aux1 / Aux2) - signal cable for AntiStatic Kit
- 21 RS232C interface - cable to dosing unit
- 22 Ethernet interface
- 23 Leveling screw (footscrew)
- 24 Level indicator with mirror (option)
- 25 Electrode cable (AntiStatic Kit)
- 26 Cable duct (AntiStatic Kit)

3.2 Terminal

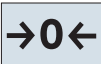

- 1 **SmartSens** Two contact-free sensors
Each of the SmartSens can be assigned a particular function. **See** Settings for SmartSens and ErgoSens (page 64)
To start the particular function, move your hand over one of SmartSens (max. distance of approximately 5 cm). The sensor beeps to confirm that it has recognized the command.
- 2 **Status bar** The green icons in the status bar indicate the functions assigned to the "**SmartSens left**" or "**SmartSens right**". The **F** represents a function key. If no green icon is visible, the SmartSens is de-selected.
The yellow LED at the bottom of the status bar confirms when a key has been pressed or a menu function carried out.
- 3  **[Home]**
To return from any menu level to the user profile "**Home**".
- 4  **User profile**
To call up the desired user profile. Different settings can be stored in a user profile. This adapts the instrument to the user or a particular dosing task. **See** Best Practice of User Profiles (page 35)
- 5  **Settings for user profile**
To define the basic settings for each user profile.
- 6  **Side doors**
To open and close the side doors of the glass draft shield. The buttons are located on both sides. **See** Glass Draft Shield (page 25)
Note
If the Auto Sampler is mounted and programmed, the keys ↑↓ do have a different function. **See** Basics of Auto Sampler (page 38)
- 7  **[On/Off]**
To switch the instrument on and off.

- 8**  **Tare**
To tare the instrument manually (required only when carrying out normal weighings with the instrument). As soon as the taring is complete, the "Net" symbol appears in the display indicating that all weight values displayed are net values.
- Note**
A negative weight value, is not permitted. An error message will appear.
To tare the instrument is not the same as to set to zero.
- 9**  **Set to zero**
To set a new zero point manually (required only when carrying out normal weighings with the instrument). After "**Zeroing**" all weight values (including the tare weight) are measured in relation to the new zero point and the following values apply: tare weight = 0, net weight (= gross weight) = 0.
- 10**  **Front door**
To open and close the front door of the glass draft shield.
- 11**  **Configuration**
To call up the menus for "**Application Setup**". The dosing application can be ideally adapted to the current task using a number of settings.
- 12**  **Print**
To print the data on a printer or to save it via the interface.

3.3 Display

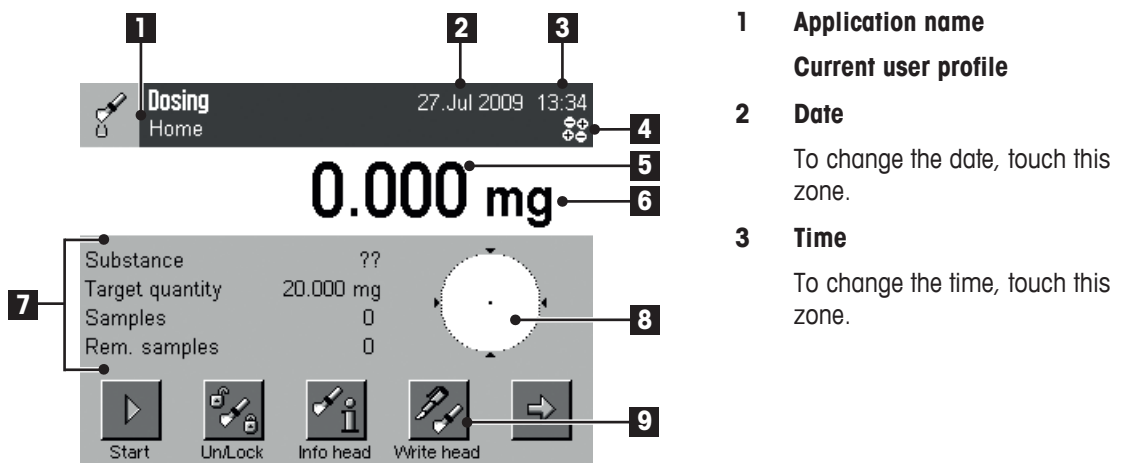

4 Status icons

These symbols indicate any special needs of the instrument (e.g. needs servicing, etc.) or show the status of particular functions (e.g. AntiStatic Kit is active) **See** Status Icons (page 93)

5 Weight value

If you touch the weight value **5**, it will be displayed in a larger format in a new window. This can be useful if the dosing result has to be read from a distance.

6 Weighing unit

If you touch the weighing unit **6**, you can change it, e.g from "**mg**" to "**g**".

1 Application name
Current user profile

2 Date
To change the date, touch this zone.

3 Time
To change the time, touch this zone.

7 Information fields

Additional information is displayed in this area. If you touch the Information fields **7**, you can select which fields and function keys should be displayed without having to go through the menu. You can also start the Leveling Assistant.

8 SmartTrac

The SmartTrac is a graphic weighing-in aid, which shows the used and remaining available weighing capacity at a glance. If you touch the SmartTrac, you can select different display types or switch them off completely.

9 Function keys

This area is reserved for the "**Function Keys**", which provide direct access to the most frequently required functions and settings. If more than 5 function keys are selected, you can switch between them using the arrow keys.

4 Installation and Putting into Operation

Installation

Note

The instrument is installed by METTLER TOLEDO service engineers. This includes the wiring as well as the configuration of the interfaces and peripherals.



CAUTION

Touching the metal pins inside the electrodes of the AntiStatic Kit may lead to a slight but perceptible electrical shock which may cause you to twitch or involuntarily pull your hand away. In this case you might damage parts of the instrument or knock over the sample containers!

Do not touch the electrodes of the AntiStatic Kit.

4.1 Scope of Delivery

QA1-L / QA3-L

- Balance and terminal
 - **QA1-L**: Balance QD204
 - **QA3-L**: Balance QD205 DR
- AC adapter with country-specific power cable
- Set of draft shield side doors, front window and terminal support
- Drip pan (below the weighing pan)
- Protective cover for terminal
- Terminal cable (long)
- Cleaning brush
- Operating Instructions (this document)
- Production certificate
- EC declaration of conformity
- QLX45 kit (see below)

QLX45 kit

- Liquid Head Support
- Cable conduct
- Cable clip (cable conduct closure)
- Power supply with country-specific power cable
- ErgoClip (tilting)
- Top glass
- MinWeigh door
- Cable RS232
- 5 Dosing heads QH000-M
- Further Liquid Module parts **see** Scope of Delivery - Liquid Module (page 43)

QB1... / QB3...

- Balance and terminal
 - **QB1...**: Balance QD204
 - **QB3...**: Balance QD205 DR
- AC adapter with country-specific power cable
- Set of draft shield side doors and terminal support
- Drip pan (below the weighing pan)
- Grid weighing pan
- Protective cover for terminal
- Terminal cable (long)
- Cleaning brush
- Operating Instructions (this document)
- Production certificate
- EC declaration of conformity
- Dosing unit (see below)

For option Liquid Module **See** Scope of Delivery - Liquid Module (page 43)

For option Auto Sampler **See** Scope of Delivery - Auto Sampler (page 38)

QB5... / QB7...

- Balance and terminal
 - **QB5...**: Balance QD206 DR
 - **QB7...**: Balance QD56
- AC adapter with country-specific power cable
- Set of draft shield side doors and terminal support
- Drip pan (below the weighing pan)
- Grid weighing pan
- Protective cover for terminal
- Terminal cable (long)
- Cleaning brush
- Operating Instructions (this document)
- Production certificate
- EC declaration of conformity
- Dosing unit (see below)

For option Liquid Module **See** Scope of Delivery - Liquid Module (page 43)

For option Auto Sampler (QB5... only) **See** Scope of Delivery - Auto Sampler (page 38)

Dosing unit

- Dosing unit
- Front door (electro conductive inside)
- Set of side windows for dosing unit
- Set of bolts for side windows
- ErgoClip weighing pan for vial adapters
- Front cover
- Type label (standard or approved balance), to be affixed to the dosing unit

Recommended Options

Ethernet

- Ethernet Option

Converter

- Ethernet-to-Serial converter
- AC adapter with country-specific power cable
- Cable adapter for power supply to converter
- Ethernet cable
- RS232 cable for host connection

AntiStatic Kit

- High-voltage power adapter with country-specific power cable
- AntiStatic Kit electrodes with cable (left and right)
- Cable duct for electrode cables (2 units)
- Control cable for high-voltage power adapter
- Clip for cable feedthrough with opening for electrode cable (4 pieces)

Various

- Cable box
- Dosing head for powder test

4.2 Location

4.2.1 Selecting the Location

Select a stable, vibration-free position that is as horizontal as possible. The surface must be able to safely carry the weight of a fully loaded instrument.

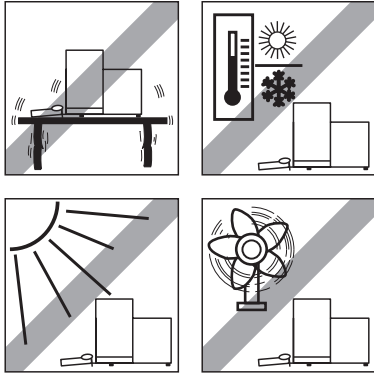

Observe ambient conditions. **See** Technical Data (page 97)

Avoid the following:

- Vibrations
- Excessive temperature fluctuations
- Direct sunlight
- Powerful drafts (e.g. from fans or air conditioners)

4.2.2 Levelcontrol

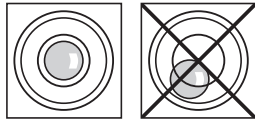

The instrument has a levelcontrol. The balance is exactly horizontal when the air bubble is in the middle of the level glass. **See** Leveling the Balance

Note: The instrument should be leveled and adjusted each time it is moved to a new location.

4.3 Wiring the Components

Attention

- Use only the 3-pin power cable with equipment grounding conductor which was supplied with your instrument.
- Only an 3-pin grounded outlet for connecting your AC adapter must be used.
- The power plug must be always accessible.
- Only extension cables which meet this relevant standards and also have an equipment grounding conductor may be used.
- Take care that AC adapter cannot come into contact with liquids.

4.3.1 QA Series

The following figure provides a basic overview of the Quantos wiring scheme.

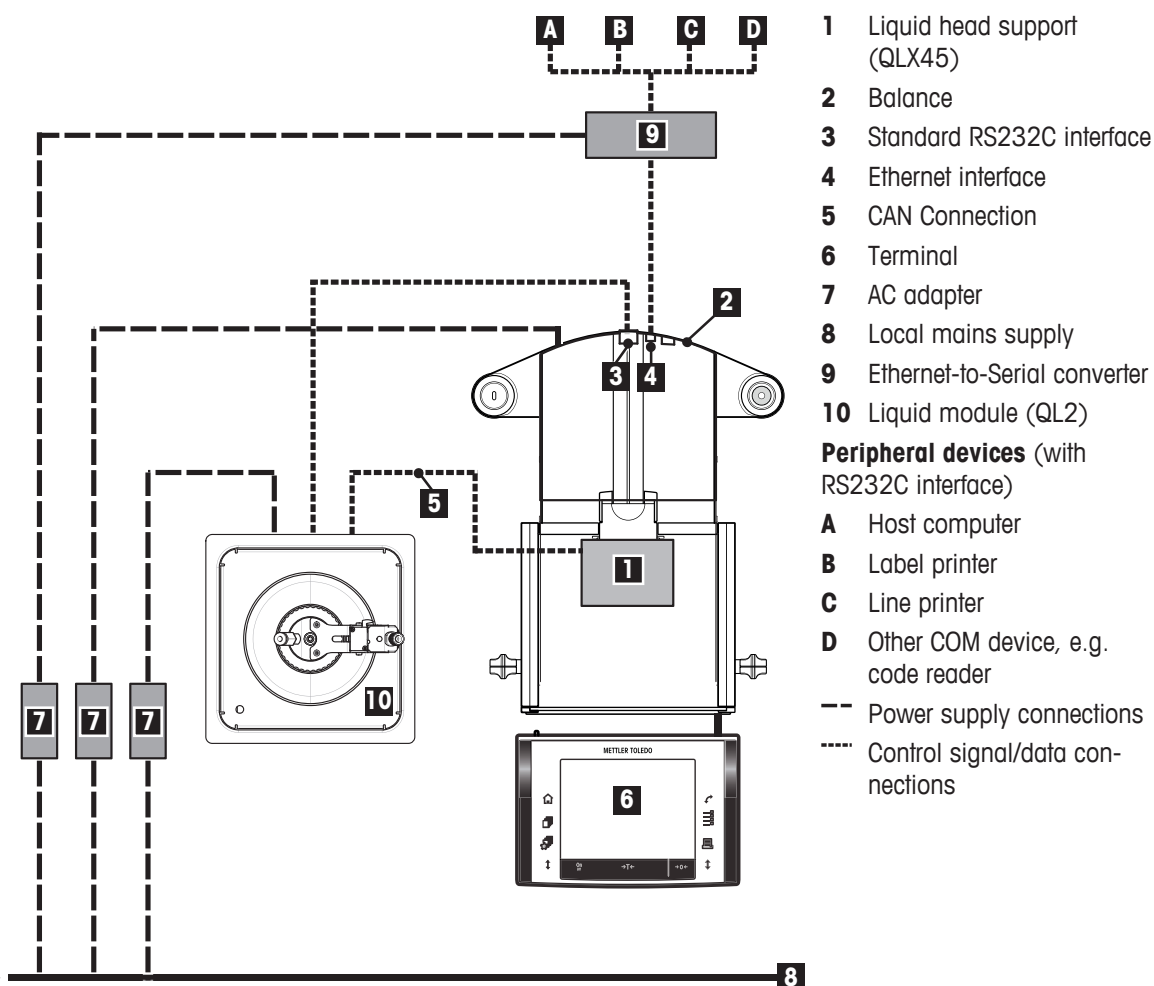

4.3.2 QB Series

The following figure provides a basic overview of the Quantos wiring scheme.

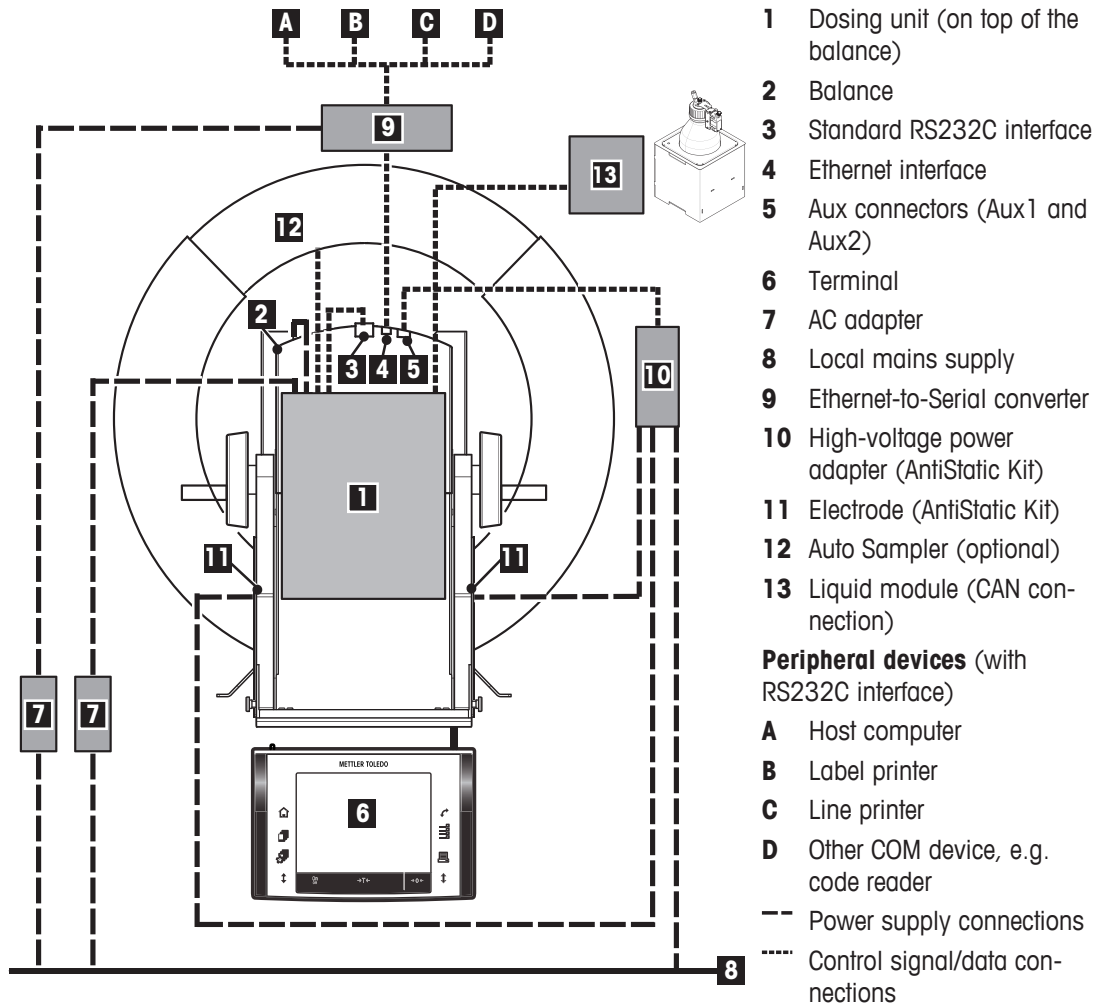

5 Operation

5.1 First Steps

5.1.1 Switching On / Off

Switching On



- Press [**On/Off**].
- ⇒ The display appears.



Switching Off



- Press [**On/Off**] until "Off" appears in the display.

Note

Do not disconnect the instrument from the power supply except if you will not be using the instrument for an extended period.

5.1.2 First Dosing

5.1.2.1 Dosing Head

A dosing head can store all relevant data about the substance (identification, weight, filling and expiry date etc.) on a chip.

5.1.2.2 Installing Dosing Head

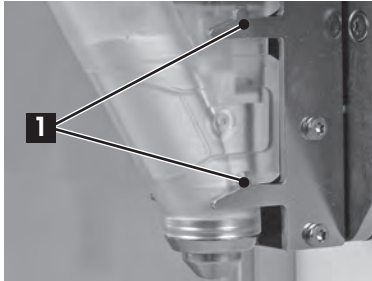

- 1 To open the front door, press ↻.
- 2 To open the side doors, press one of the ⬆️ keys for easier access.
Note
If you have the Auto Sampler these keys will have a different function. **See** Auto Sampler (page 38)
- 3 Slide the test head onto the dosing head support until it comes to a stop.
- 4 Press it slightly down until it is properly seated in the holding pins **1**.
Note
At this time the dosing head will not be locked. If you want to remove it again, it is possible.
⇒ The dosing head is ready to dose.

5.1.2.3 Dose



The instrument has a customizable "**Dosing steps**" that will lead you step-by-step through the dosing procedure. Once you are familiar with the instrument you may disable the **Dosing steps** as a whole, or just the steps that you do not need. At the factory the **Dosing steps** is set to get you started easily.

Note

The **Dosing steps** of instruments equipped with Accessories may slightly differ from the example below. **See** Auto Sampler (page 38) or Liquid Module (page 42) or Working with "SafePos" (page 34)



[Start]

Start the procedure

- Touch [Start] at the bottom of the display.
⇒ A message appears that the instrument now prepares for dosing.

Note

The dosing head will be locked.

Abort the procedure

You may abort the dosing procedure at any time by touching the cancel key [C] in any of the **Dosing steps** windows. The instrument then returns to the main window.



Locking of dosing head takes place as soon as you start dosing or write data to the head.

[Un/Lock]

- 1 Touch the **[Un/Lock]** function key at the bottom of the Display.
⇒ The head is released.
- 2 Remove the head.

"User ID"

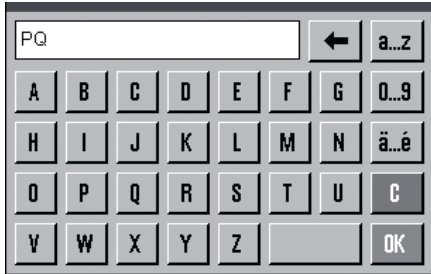

- 1 Enter your **"User ID"** e.g. your name. The instrument displays the **"User ID"** that was used with the previous dosing, if any. (max. 20 characters)
- 2 Touch **[OK]**.
⇒ The entered **"User ID"** appears in the relevant information field and can be printed on the dosing reports or labels.

"Sample ID"

- 1 Enter your **"Sample ID"** which identifies the current sample. (max. 20 characters)
- 2 Confirm with **[OK]**.
⇒ The entered **"Sample ID"** appears in the respective information field and can be printed on the dosing reports or labels.

Note

The **"Sample ID"** is not mandatory and the instrument does not check whether or not it is unique.

"Target quantity"

- 1 Enter the quantity of substance to be dosed the **"Target quantity"** in milligrams.
Example: 50 mg
- 2 Confirm with **[OK]**.
⇒ The entered **"Target quantity"** appears in the respective information field and can be printed on the dosing reports or labels.

"Tolerance"

- 1 Enter the **"Tolerance"** in percent.
Example: 1%
- 2 Touch **[OK]**.
⇒ The entered **"Tolerance"** appears in the respective information field and can be printed on the dosing reports or labels.

Note

- To find the appropriate **"Tolerance"** for your **"Target quantity"**, **see** Target Quantities and Tolerances (page 95).
- Entering 1% results in a tolerance range of +1%/–1%. For other possibilities **see** Selecting the Tolerance Mode (page 62)

"Dosage preparation"

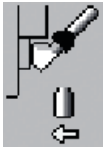

- 1 Place the sample vessel on the weighing pan.

Note

Align it properly with the dosing head.

- 2 Touch [OK].

⇒ The value at the bottom of the display shows the weight of the sample vessel.

"Dosage preparation"

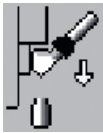

- 1 Lower the position with the head height adjustment handle.

Note

Lower until the nozzle of the dosing head is about 0.5 mm to 1 mm above the sample vessel.

- 2 Touch [OK].

⇒ A taring of the instrument is performed and dosing starts.

"Dosage in progress ..."



SmartTrac

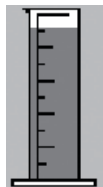

- Watch your first dosing cycle in progress.

Note

The SmartTrac shows a graphical representation of the dosing process.

Note

The instrument has a built-in learning mode. When using a new dosing head for the first time, dosing will be relatively slow as the instrument doses very carefully in the beginning, slowly approaching the target quantity. Dosing speed and accuracy will constantly improve with every subsequent dosing.

"DOSAGE RESULT"



After the instrument has finished dosing, the result is displayed. Also whether or not the result is within the tolerance you specified.

- Confirm with [OK].

The instrument is ready for the next dosing.

Congratulations, you have just successfully finished your first dosing!

Note

The instrument now writes some internal data back to the head. This updates the dosing counter and the amount of substance remaining. In addition, the instrument writes some specific dosing data that is used for the automatic learning mode.

Example: Printout

Balance ID	LAB 2A

Substance	Glucose
Sample ID	XK-414
Content in mg	19.813
Dispense date	
	05.06.2008
Exp. date	21.08.2008

User ID	TRPF

On the left is an excerpt from a printout.

Note

Each printout is rather long, as the specific settings of every single menu and submenu will be included.

More information **see** Defining the Output of Dosing Head Data (page 61) **or** Specifying the Contents of Sample Data Records (page 59)

5.2 Basic Operation

5.2.1 Typical Configuration Menu Overview

The typical configuration menus are briefly described below, without going into detail on application-specific features.

Note

User profiles and settings can be protected against unauthorized access by the security system of the instrument so that they can only be accessed with a password. The following description assumes that password protection has not been defined for any area of the menu system and that all settings are freely accessible.

Changing User Profile

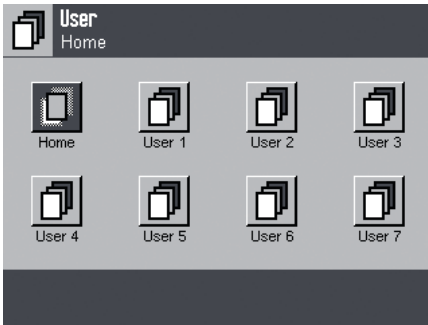

- 1 Press .
- 2 To select a user profile, touch the relevant function key, e.g. **[User 4]**.
 - ⇒ This activates the user- and application-specific settings that are stored under the selected profile.
See User Profiles (page 51)

Example

The windows in this chapter will be shown as follows:

Navigation: "Window title" > [Button]

Navigation: "User" > **[User 4]**

Changing Application Specific Settings



- Press .
- ⇒ Window "**Application Setup**" opens.
- ⇒ The settings that you define here will be stored under the active user profile here "**User 4**", so ensure that the desired user profile is active before you make your changes.
See Application Settings (page 51)

Example

The windows in this chapter will be shown as follows:

Navigation: "Window title > Function name" > [Button]

Navigation: "**Application Setup > Function Keys**" > **[Define]**

Changing User Specific Settings

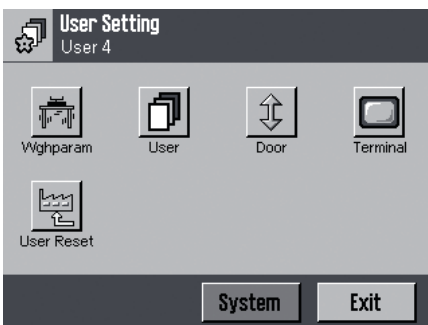

In this menu the instrument can be adapted to your work technique and to specific tasks.

- Press .
- ⇒ The settings that you define here will be stored under the active user profile e.g. "**User 4**", so ensure that the desired user profile is selected before you make your changes.

Function key **[Wghparam]** stands for Weighing Parameters.

See Entering User Data (page 70)

Changing System Settings

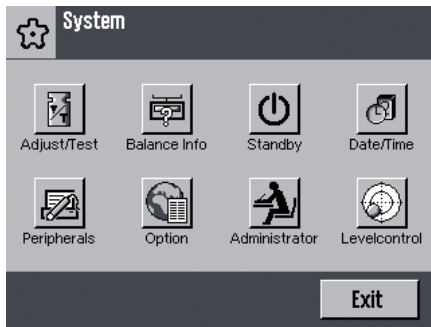

In this menu you can change the system settings, which globally apply to the instrument (i.e. for all user profiles).

- Press  and then **System**.
- See System Settings (page 74)**

5.2.2 Security System

Your instrument has a comprehensive security system, which can be used to define individual access rights at administrator and user level. It is possible to define which settings can be changed for each individual user profile. Access to protected menu areas requires the entry of an identification (ID) and a password. When the instrument is delivered ex works, only the "**Administrator**" settings in the system settings are protected.

See Configuring the Security System (page 81)

If you try to call up a menu area that is protected with an ID and password, an alphanumeric keyboard first appears in the display for entering the ID.

- 1 Type in your ID.
 - To switch between lowercase and uppercase letters, touch [**a...z**] and [**A...Z**].
 - To enter numbers, touch [**0...9**].
 - To delete incorrect entries character by character, touch backspace .

Note

The window can be closed at any time by touching [**C**].

- 2 As soon as the ID has been entered fully, touch [**OK**].
 - ⇒ A second window appears for entering the password.
- 3 Type in your password (for security reasons this is displayed using asterisks rather than in plain text) and confirm with [**OK**].
 - ⇒ If the ID and the password are correct, the selected menu area will be called up or the desired action will be executed. If not, an error message will appear, along with instructions to reenter your ID and password.

CAUTION



Don't forget your security IDs and passwords

If you forget a security ID or a password, it is not possible to regain access to a protected menu area.

- Note down your security IDs and passwords and keep them in a safe place.
-

5.2.3 Glass Draft Shield

The glass draft shield includes the left and right side door, and the large front door.

Opening the side door

- To close and open the side door, press .

Note

Instruments with the Auto Sampler have special side doors. **See** Auto Sampler (page 38)

To configure the side doors, **see** Configuring the Side Doors (page 65) or Settings for the Side Doors (page 71)



Removing the side doors

For example for cleaning purposes:

- 1 Open the front door.
- 2 Grasp the side door by its upper part, tilt it away from the instrument and carefully lift it off.



Disengaging the side doors

To use only one of the doors, you may disengage the other one from the internal motor.

- Pull the respective door handle away from the instrument.
 - ⇒ This reduces the drafts as one side of the glass draft shield always remains closed.

Removing the front door



- 1 To close and open the front door, press ↻.
- 2 If the front door is open, close it.
- 3 To remove the front door, e.g. for cleaning purposes, pull the two buttons at the top of the door away from the instrument and lift off the glass carefully.

Note

To configure the front door, **see** Configuring the Front Door (page 65)

5.3 Dosing Heads

This chapter provides some in-depth information about the dosing heads and explains how to prepare a new head for operation.

5.3.1 General Information

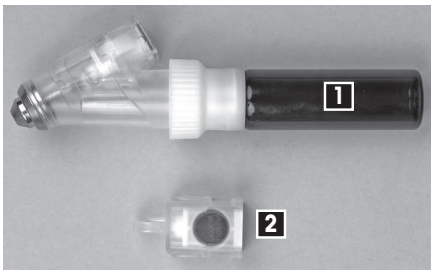

There are 3 types of dosing heads:

- 1 Automatic powder dosing:
this head is equipped with a powder storage container. This is the standard head for dosing powder.
- 2 Manual dosing:
this head has no powder container and the user has to dispense the powder manually. It is reduced to a tag equipped with a RFID chip that allows to enter substance data and to print respective data. The head has no lifetime limit because it has no dosing mechanism.



- 3** Liquid dosing:
this head is the standard for liquid dosing. **See** Liquid Module (page 42)

Special dosing heads

For powder test:

this head is equipped with a powder storage container filled with CaCO_3 and a RFID with a test function. It dispenses automatically 10 times a certain mass and reports the results. Check the results of the Typical values > **Repeatability (sd), fine range** automated operation and Dosing time, **see** Model-Specific Data

For "MinWeigh" test:

this head performs a MinWeigh test automatically by placing a test weight on given tare weights. The procedure will be repeated 10 times to define the "MinWeigh".

As soon as the head is inserted, the instrument automatically reads the data of the new head. In addition, the instrument performs some automatic adjustments concerning the **Dosing steps**, automatic door operation and other instrument settings. For example, with the manual dosing head installed, the **Dosing steps** will not prompt you to lower the dosing head because dosing is done by the user, and the doors will open when the unit is ready for dosing (in automatic dosing they will close instead). In addition, the SmartTrac will change with the dosing head installed, i.e. in automatic mode a graduated cylinder is displayed while for manual dosing the SmartTrac displays a cross-hair graph that facilitates precise dosing to the target value.

When no dosing head is installed the instrument will replace head-specific information with factory settings (watch the information fields, e.g. instead of the substance name you will encounter question marks when no head is installed).

5.3.2 Handling of Powder Dosing Heads and Containers

The dosing heads are supplied in a plastic container. We recommend using this container when shipping a dosing head. The spare cap **1** included in the delivery may be used to seal the powder container **2** if you want to store it away from the head.

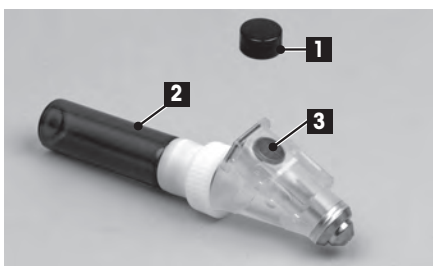

Opening

- ▶ Turn the dosing head upside down.
- 1 Unscrew the powder container **2** from the dosing head.
- 2 Fill in your powder.
- 3 To prepare the head for operation, install the dosing head in the instrument and enter the respective data. The data is stored in the RFID chip **3** of the dosing head.

If you want to print a label **2** containing the powder data stored in the dosing head, affix this label to the powder container **1**.

How to define the data for printing or labeling, **see** Defining Data Output (page 55).

Note

The section of the label holding the matrix code has no adhesive on the back. When affixing the label to a round sample container this section will remain flat for easy reading with a scanner.

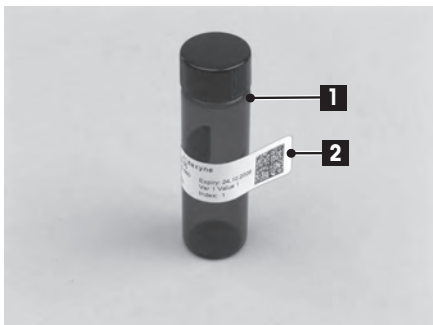

5.3.3 Data Stored in the Dosing Head's RFID

Every dosing head is equipped with a Radio Frequency Identification chip (RFID) that can store and exchange data with the instrument. The most obvious advantage of this design is the portability of data – you may remove the dosing head and install it in another Quantos unit and the relevant information goes with it and is readily available.

The following data is stored in the RFID of the head:

- **User data**

This block holds information about the substance such as the name of the substance, the filling and expiry dates, the quantity, etc. This data can be edited by the user at any time and it should be entered before using a new head for the first time to ensure proper functioning of the instrument's internal monitoring routines, and to have the data available for reports and labels.

- **Internal data**

This block holds the counters for the remaining dosing cycles and the remaining amount of substance. After every dosing, the counters are updated automatically. This block also holds the data the instrument gathers in the automatic learning mode that increases speed and accuracy of dosing over time. This block of data cannot be modified by the user.

Note for powder

The counter for the remaining powder dosing cycles is based on the lifetime limit of the dosing head. With every dosing cycle started, the counter is decreased by 1. If the counter drops to zero, the head must be replaced. If the powder container of the old head still contains a considerable amount of powder, you may remove the powder container from the old head and screw it onto the new one. Just copy the user data and the powder content value from the old head to the new one.

If the remaining quantity of powder is insufficient for the next dosing cycle, a warning message will appear. You can unscrew and refill the powder container. Don't forget to update the user data that the instrument works correctly.

5.3.4 Displaying Head Information

To view the information stored in the current dosing head at any time.



- 1 Touch [**Info head**].

⇒ The display shows the data stored in the dosing head.

Note

The amount of data displayed depends on the menu settings. Depending on these settings, the listing may be several windows long and you may use the arrow buttons at the bottom to scroll through the list.

See Defining the Output of Dosing Head Data (page 61)

- 2 To return to the main window, touch [**OK**].

5.3.5 Selecting Function Key [Set content]



[**Set content**] temporarily stores the net weight of the powder and inserts this value automatically in the head data "**Content [mg]**".

- 1 Touch "**Application Setup**" > "**Function Keys**" > [**Define**].
- 2 Navigate with the right arrow key until "**Set content**" appears and select it.
⇒ A number appears which indicates the order of the function keys displayed.
- 3 Confirm with [**OK**].
⇒ [**Set content**] is displayed in the application at the bottom of the display.

Note

Overview of all "Function Keys", see Selecting Function Keys (page 53).

5.3.6 Preparing a new Head for Operation

The amount of user data that is required for setting up a dosing head is customizable, the procedure described below reflects the maximum amount of data.

Preparing head



[Set content]



- ▶ [Set content] is selected.

- 1 Unscrew the powder container from the new head and put the container on the weighing pan.
- 2 To tare the instrument, press →T←.
- 3 Pour your powder into the powder container.
- 4 Store the net weight of the powder with [Set content] or note the value.
- 5 Screw the powder container to the dosing head again.
- 6 Insert the dosing head into the dosing unit.

Entering head data



[Write head]

- Touch [Write head].

⇒ The instrument first reads some data from the head and then opens the window for entering the user data.

"Substance"

PQ										←	a..z
A	B	C	D	E	F	G	0..9				
H	I	J	K	L	M	N	ä..é				
O	P	Q	R	S	T	U	C				
V	W	X	Y	Z					OK		

- 1 - Enter the name of the substance.
(max. of 20 characters)
- If a barcode reader is connected to your instrument and your substance provides a barcode, scan the product barcode instead of entering the name manually. The name of the substance appears in the respective information field and can be printed on the dosing reports or labels.
- 2 Confirm with [OK].

"Lot ID"

- 1 Enter the **Lot ID** of your substance.
(max. of 15 characters)
- 2 Confirm with [OK].
The **Lot ID** can be printed on the dosing reports or labels.

"Filling date"

- 1 Enter the "Filling date" of your substance.
- 2 Confirm with [OK].
The "Filling date" can be printed on the dosing reports or labels.

"Exp. date"

- 1 Enter the "Exp. date" of your substance.
- 2 Confirm with [OK].

Note

Once the "Exp. date" is reached an error message appears and you will not be able to continue dosing.

- "Content [mg]"** – If you stored the net weight of the powder with [**Set content**], confirm the value with [**OK**]. Otherwise, enter the noted value in milligrams and with [**OK**] afterwards.
- Note**
With this value the counter calculates the remaining powder.

The following two windows are for the first customizable field called "**Var1**" which may be used for entering additional data, e.g. about your substance or your company.

- "Var 1 name"**
- 1 Select "**Var 1 name**" which is the title of the first customizable field.
 - 2 Change this identification.
Factory setting: "**Var1**" (variable 1).
(max. up to 10 characters)
Example: If you want to save the storage temperature of 5 °C, enter **Storage**.
⇒ The new title will appear in the respective information field and on the labels and reports you print.
 - 3 Confirm with [**OK**].
- Note**
In the course of this manual the default title "**Var1**" will be used.

- "Var1"**
- 1 Enter the contents of the first customizable field.
Factory setting: **Value 1**
(max. 15 characters)
Example: If you want to save the storage temperature of 5 °C, enter **5oC**.
 - 2 Confirm with [**OK**].
- Note**
In the course of this manual the default contents **Value 1** will be used.

Note

The following information is not part of the default head definition sequence. If you want to use this additional customizable fields, select them. **See** Setting up the Head Definition Data (page 62)

- "Var2..."** After having defined "**Var1**" there will be another three customizable fields called "**Var2**", "**Var3**" and "**Var4**", for entering the respective title and contents.

- "Dose limit"** ► Dosing head begins with "QH..."
- 1 Enter the number of possible dosing according to the specification of your substance.
Factory setting: **250**
Example: If you have NaCl, change the limit to **100**.
 - 2 Confirm with [**OK**].
- Note**
Change just at the first time you set up a new dosing head. A change during the lifetime of a dosing head, may lead to an error that you can't use your dosing head anymore.

- "Retest date"**
- 1 Enter the **"Retest date"** of your substance. Once the retest date is reached a warning appears. You can decide to continue or to abort dosing. If you abort dosing, test your substance.
 - 2 Confirm with **[OK]**.
- "Write head"**
- The instrument writes the user data to the head and then a message of successful data transfer appears.
- 1 - If a label printer is connected and automatic printing is selected, a label will be printed. Affix it to the dosing head.
- If no automatic label printing takes place, press  while the message is displayed.
 - 2 To return to the main window, confirm with **[OK]**.
⇒ The new head is ready for dosing.

Note

The amount of user data that is required for setting up a dosing head is customizable. You can shorten the procedure. **See** Setting up the Head Definition Data (page 62)

Also see

- Setting up the Head Definition Data (page 62)
- Setting up the Head Definition Data (page 62)

5.3.7 Copying Data from one Head to Another

If the counter for the remaining dosing cycles drops to zero, an error message appears and the head must be replaced with a new one. If the powder container of the old head still contains a considerable amount of powder, remove the powder container from the old head and screw it onto the new one.

Selecting [Copy head]



Copying data from one head to another requires **[Copy head]** function key.

How to select a function key, **see** Selecting Function Key [Set content] (page 28).

Copying the Data



- 1 Touch **[Copy head]**.
⇒ Follow the instructions.



- 2 Install the source head. Make sure the previous (used) head is installed.
⇒ The data is copied from the head to the internal memory.
- 3 Install the target head. Make sure the new head is installed.
- 4 Confirm with **[OK]**.
⇒ The data is now copied from the instrument's internal memory to the new head.
- 5 To return to the main window, confirm with **[OK]**.
⇒ The new head now contains all user and internal data, i.e. head is ready for dosing.

Note

Depending on your settings, a label and/or record with the head data will be printed automatically. **See** Defining Data Output (page 55)

5.3.8 Unlocking the Head Manually

You can configure the instrument that the head is unlocked automatically after each dosing cycle, **see** Configuring the Dosing Steps (page 61). If this feature is de-selected, unlock the head manually.



- 1 Touch [**Un/Lock**].
⇒ Instrument releases the head. Remove head.
- 2 If [**Un/Lock**] is not available, re-select the function key. **See** Selecting Function Keys (page 53)

Note

After having installed the head again you do not need to lock it manually. This is done automatically as soon as you start a dosing cycle or write data to the head.

5.4 Advanced Features

5.4.1 Working with Sample Counter

The sample counter is meant to assist you when dosing a given number of samples.

- ▶ "**Application Setup > Function Keys > Samples**" is selected.
 - ▶ If you work with the sample counter, select the corresponding information fields.
- 1 Touch [**Samples**].
⇒ A numeric input field appears.
 - 2 If you enter a value between 1 and 1000, you select the sample counter.
Factory setting = "0" - sample counter is switched off.
 - 3 Dose the first sample.
⇒ After dosing is completed the counter has decreased by 1.
⇒ At the end "**Last sample reached**" appears.
 - 4 Confirm with [**OK**].
⇒ The instrument resets both values to zero.

5.4.2 Changing the Resolution of Dosing Result

The instrument is set ex works so that the dosing result is displayed at the maximum resolution (corresponds to 1d). You can change the resolution of the dosing result at any time. These function keys are greyed out when "**MinWeigh**" is on.

- ▶ Relevant function key or keys are selected and active.
- 1 Touch the relevant function key.
 - 2 To show the dosing result at the normal resolution, touch it again.



- | | |
|--------------------|------------------------|
| " 1/10d " | 10x lower resolution |
| " 1/100d " | 100x lower resolution |
| " 1/1000d " | 1000x lower resolution |

Note

With some models "**1/2d**" and "**1/5d**" function keys are also available.

- | | |
|-----------------|--|
| " 1/2d " | Displays the last decimal place in increments of 2 |
| " 1/5d " | Displays the last decimal place in increments of 5 |

5.4.3 Manual Dosing

Usually, you will work in automatic dosing mode. In some cases the dosing head may not be able to dose a particular substance properly or you want to `dose` a solid e.g. tablets or wax. In such a case you can revert to

manual dosing. The dosing procedure is almost the same as in automatic mode except that you do the dosing. For manual dosing you will still need a dosing head installed in the instrument that will provide the necessary data for printing records and labels, or for creating XML output. For this purpose, your instrument is supplied with a special dosing head.



Once the manual dosing head is installed, the instrument is prepared and automatically adapts a few procedures:

- **Dosing steps:** No lowering of the dosing head
- **Door operation:** If "**Application Setup** > **Side doors** or **Front door**" > [**Define**] > "**Dosing**" is selected, the doors will automatically open and close as needed.
- **Auto Sampler:** To prevent interference, the Auto Sampler will be moved to "**Home**" position and disabled temporarily.

- 1 Insert the manual dosing head.
- 2 Touch [**Start**] and enter all required data. **See** Preparing a new Head for Operation (page 29)
- 3 Put the sample container on the weighing pan.

Note

All of the above **Dosing steps** steps are exactly the same as with automatic dosing. Except that there is no message of lowering the dosing head because the head is not involved. You can even raise the head for easier access to the sample container.

Dosing powder

- 1 Dose the powder into the sample container manually.
 - ⇒ The SmartTrac cross-hair graph assists you. This is the coarse range indicator that helps you dosing the powder quickly until you approach the target area. As soon as the vertical bar (fine range indicator) starts moving to the right you should slow down the dosing procedure and carefully approach the target value in the middle between the two tolerance marks.



- ⇒ As soon as the quantity is within tolerance both indicator bars turn from red to green.
- 2 If you want to store the net weight of the powder, touch [**Set content**].
 - 3 If the target quantity is reached, confirm with [**OK**].
 - ⇒ The result of the manual dosing appears.
 - ⇒ The label and/or record are printed. The `Validity` item is followed by `M` stating that this was a manual dosing.

5.4.4 Working with the "MinWeigh" Function

The "**MinWeigh**" function ensures that the sample weight does not go below a certain limit (in reference to the tare weight) in order to meet the admissible tolerance for the measured values, as specified by the work standard used. The "**MinWeigh**" function must be mounted and programmed by a service engineer. After that, "**MinWeigh**" is set.



As soon as "**MinWeigh**" is set, the status icon appears in the upper right corner of the display. This icon and the light color of the weight value indicate that the minimum initial weight value has not yet been reached and that the current weight value may be outside the tolerance range specified in the quality assurance system.

Now start dosing as usually. While dosing, the weight value first appears in a light color indicating that the minimum initial weight has not yet been reached. As soon as the minimum weight is reached, the color of the weight value turns solid and the status icon disappears.

Note

If several reference tare values (and their corresponding minimum initial weight values) have been programmed by the service engineer, the required minimum initial weight value changes automatically, depending on the tare weight.

At the end of the dosing cycle the result of the "**MinWeigh**" function will be shown at the bottom of the display "**Valid**" (minimum weight reached) or "**Invalid**" (minimum weight not reached).

If you include "**MinWeigh**" in your sample labels and/or records the result will also appear in the printout.



Note

If the status icon "**MinWeigh test**" appears, contact the customer service department. A service engineer runs the "**MinWeigh**" test as soon as possible.

Example

When working according to GMP the admissible tolerance is 1%, 2s, while the more restrictive USP standard allows for 0.1%, 3s.

Also see

- Settings for the "MinWeigh" Function (page 63)

5.4.5 Working with "SafePos"

When using small sample container the dosing head needs to be lowered close to the container. In most cases the dosing head needs to be raised again after dosing to remove the sample container. The "**SafePos**" option automatically moves the dosing head to a safe distance from the sample container to prevent contact of head and container e.g. during exchange of sample container.

Mounting "SafePos"

The "**SafePos**" is mounted by a METTLER TOLEDO Service Engineer.

See Setting for "SafePos" Option (page 67)

Selecting function keys for "SafePos"

Navigation: "Application Setup > Function Keys" > [Define]



"SafePos"

To move the dosing head from the dosing position to the safe position, and vice versa. To check that the position is correct.



"Setup"

To select and adjust of the Auto Sampler directly and the "**SafePos**" option.

Selecting "SafePos"

Note

At the same time you can adjust the "**Auto sampler**" option, as required. **See** Auto Sampler (page 38)



- ▶ Function key [Setup] is selected.



- 1 Touch [Setup].
⇒ Window "**Setup**" opens.
- 2 Make sure "**SafePos**" is selected.
- 3 Touch [Start adjustments].
⇒ Window "**SafePos**" for adjustment opens.
- 4 Follow the instructions of the adjustment procedure.

A new adjustment of the dosing height is required only when switching to a different sample container.

5.4.6 Best Practice of User Profiles

All application settings are stored in the active user profile. User profiles are an extremely flexible means for adapting the instrument to your particular work environment. If your instrument is operated by personnel having different levels of experience, you want to create user profiles that match their respective tasks. For instance, you can create a profile for the operator who just does the dosing but has no rights to enter head data or change application settings.

Creating a new user profile

- 1 Press  and choose [User 1].
⇒ User profile "User 1" is active.
- 2 Press  and touch [User].
- 3 Touch "User Name" > [Define].
- 4 Enter a new name, e.g. **Dosing** and confirm with [OK].
- 5 Check in "Application Setup > Function Keys" that a minimum of them are selected: [Start], [Info head], [Un/Lock]
- 6 To see at a glance the different user profiles, change the background color in [Terminal] > "Colour selection".
- 7 To check the changes, switch back to user "Home".

Reducing rights of user dosing

- ▶ Knowledge of administrator ID and password.
- 1 Press  and choose **Dosing**.
⇒ User profile **Dosing** is active.
 - 2 Touch "**System**" > "**Administrator**" > **Rights Dosing** and give in administrator ID and password.
 - 3 Change all items in "**Access Rights**" except "**User**" of the following table to [Adm. Protect.].
⇒ Just the selected function keys and the right to change "**User**" are now available for **Dosing**.

Factory Setting

Page 1	selected	Page 2	selected
"Application Setup"	[No Protection]	"User ID/Password"	[No Protection]
"Weighing parameters"	[No Protection]	"System"	[No Protection]
"Adjustweight"	[No Protection]	"User Setting"	[No Protection]
"User"	[No Protection]		

Also see

- Application Settings (page 51)

5.5 Adjusting the Instrument

Like any precision instrument the Quantos requires to be readjusted on a regular schedule. Your instrument offers many options for adjustment as well as functions for testing the adjustment. **See** Settings for Adjustment and Tests (page 75)

Your instrument is set to **ProFACT** ex works. ProFACT automatically adjusts and linearizes the instrument according to preselected criteria. Additionally the instrument can be adjusted manually and/or tested using the internal weight or an external weight at any time.

Precondition for this chapter is that the following function keys are selected:

[**Adjust.int**], [**Adjust.ext**], [**Test int**], [**Test ext**]

- To show the adjustment changes, touch [**Adj. History**].
 - ⇒ An information window opens.
- To print any setting, press .

If a printer is connected to the instrument, the adjustment can be printed automatically according to your settings. **See** Fully Automatic Adjustment – ProFACT (page 76) The adjustment records that are printed depending on your settings. **See** Defining Adjustment and Test Reports (page 78)

5.5.1 ProFACT Fully Automatic Adjustment

ProFACT automatically adjusts and linearizes your instrument according to a preselected criterion. **See** Fully Automatic Adjustment – ProFACT (page 76)



As soon as the preselected time and/or temperature criterion is met, the status icon appears in the top right corner of the display, below the time. The instrument shows that it wants to carry out a ProFACT adjustment.

Note

In the first 24 hours connected to the power supply, ProFACT is carried out several times regardless of the selected criteria.

- 1 Unload the instrument.
- 2 Don't touch any key for 2 minutes.
 - ⇒ Adjustment starts automatically.

During adjustment a window is displayed, which provides information about the current adjustment operation. If adjustment starts, but you want to continue working, abort ProFACT with [**Cancel**]. The instrument will start adjustment at the next available opportunity.

If the adjustment is successfully completed, the status icon disappears. Each ProFACT adjustment is printed automatically according to your settings.

Also see

- Defining Adjustment and Test Reports (page 78)

5.5.2 Adjusting with Internal Weight



[**Adjust.int**] triggers an instrument adjustment using the built-in adjustment weight. This can be implemented at any time.

- 1 Touch [**Adjust.int**].
 - ⇒ Hear how the internal weight is placed on the pan and then lifted off again in a motorized process.
 - ⇒ During adjustment a same window is displayed as for "**ProFACT**".

- 2 If "**Adjustments done**" is displayed, confirm with [**OK**].
If "**Adjustment abort**" is displayed,
 - if you aborted the adjustment, confirm with [**OK**].
 - if the instrument aborted the adjustment, touch [**Retry**].

5.5.3 Adjusting with External Weight



[**Adjust.ext**] triggers an instrument adjustment using an external adjustment weight. This can be implemented at any time.



Additionally you can specify an adjustment reminder on specific days of the week and at a specific time and the status icon will occur. **See** Automatic Adjustment (page 76) and Defining Adjustment Weights (page 77)

Note

Depending on country-specific regulations, adjustment using an external weight is not available on certified instruments.

► **See** Using the Weight Basket (page 41)

- 1 Touch [**Adjust.ext**].
 - ⇒ A list for selecting the adjustment weight appears.
- 2 Select a weight. Factory setting [**Adj. weight 1**] ... [**Adj. weight 5**].
 - ⇒ The adjustment starts. You can abort the current adjustment operation at any time by touching [**Cancel**].
- 3 Place the appropriate adjustment weight. If available, the ID and the certificate number of the corresponding weight are displayed.

Note

Check that the correct weight is on the pan, otherwise the adjustment operation will be aborted.

⇒ The required weight value flashes and the adjustment operation is carried out automatically.

- 4 At the end of the adjustment operation lift off the weight.
 - ⇒ A window opens.
- 5 Confirm with [**OK**].
 - ⇒ The status icon has disappeared.

Note

If you have specified in the system settings an adjustment reminder and if you want to adjust, touch [**Yes**]. If you touch [**Later**], adjustment reminder will appear again after 15 minutes. The adjustment weight selected last is always used for automatic external adjustment.

5.5.4 Testing Adjustments with Internal Weight



[**Test int**] checks that your instrument was adjusted correctly using the internal weight. The test procedure is the same as that for adjustment using the internal weight.

– Touch [**Test int**].

If the test was aborted due to an error, an error message is displayed.

5.5.5 Testing Adjustments with External Weight



[**Test ext**] checks that your instrument was adjusted correctly using an external weight. This can be implemented at any time.



Additionally you can specify a test reminder on specific days of the week and at a specific time and the status icon will occur. **See** Automatic Adjustment (page 76) and Defining Adjustment Weights (page 77)

The status icon is displayed until the test is successfully completed or until you indicate at the time of the second request that you have decided not to test.

- Touch [Test ext].

The test procedure is the same as that for adjustment using an external weight.

5.6 Auto Sampler

The Auto Sampler automatically transports up to 30 sample containers, allowing unattended dosing of up to 30 samples. In this chapter you will find information on how to configure the unit and you will learn how to use the Auto Sampler.

Note

- The Auto Sampler can be used for liquid or solid dosing.
- Solution dosings are not possible unattended, because you have to change dosing heads. **See** Liquid Module (page 42)
- The Auto Sampler is not compatible with the QB7, and therefore no unattended dosing is possible for the QB7.

5.6.1 Overview

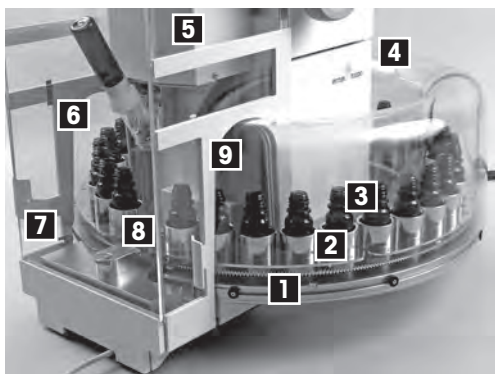

- 1 Revolving drive ring
- 2 Magazine for 5 sample containers (6 numbered magazines for 5 containers)
- 3 Sample container (e.g. powder)
- 4 Tunnel rear
- 5 Side windows
- 6 Side door left with tunnel
- 7 Door handle
- 8 Cover "Home" position
- 9 Side door right with tunnel

5.6.2 Scope of Delivery - Auto Sampler

- Base ring with motor
- 2 screws M4x16
- Bottom cover
- Revolving drive ring
- Weighing pan standard
- Cover of weighing pan
- Cover "Home" position
- Weighing pan large
- Weight basket
- Hook for cleaning
- 2 cover clip (sheet steel)
- 6 magazines
- Side windows (left, right)
- 3 tunnels (left, right, rear)

5.6.3 Operation

5.6.3.1 Basics of Auto Sampler

Door operation

- - To operate the front door, press ↻.
- - To open or close the side doors grasp the left or right side door handle and turn the door to the stop.

Note

The keys ↑ ↓ do have a different function: they turn the Auto Sampler clockwise or anti-clockwise by 1 magazine = 5 positions.

Sample container

- **Do not** install a sample container in the "**Home**" position as this can lead to taring errors and cause the container to get jammed when the drive ring turns. **Exception see** One Single Dosing (page 41)
- The instrument stores and evaluates the position numbers of the sample containers. Therefore make sure to install the magazines in the correct order (position "1" is to the left of the dosing head).
- Make sure to install all sample containers required for a particular dosing series. If a sample position is empty then the dosing sequence will skip to the next sample container available.

5.6.3.2 Working with Auto Sampler

Please proceed as follows before using the Auto Sample for the first time.

Mounting the Auto Sampler

The Auto Sampler is mounted by a METTLER TOLEDO Service Engineer.

Configuring the Auto Sampler

Navigation: "Application Setup > Auto sampler" > [Define]

Configure your settings in this menu. More details **see** Configuring the Auto Sampler (page 65)

Selecting function keys for the Auto Sampler

Navigation: "Application Setup > Function Keys" > [Define]



"Right"

To turn the Auto Sampler anti-clockwise.



"Left"

To turn the Auto Sampler clockwise.



"Home"

To move the Auto Sampler to the "**Home**" position, i.e. to the initial position where no sample container is located on the weighing pan.



"Setup"

To select and adjust the Auto Sampler directly and the "**SafePos**" option.
See Advanced Features (page 32)

5.6.3.3 Selecting the Auto Sampler

The Auto Sampler must be mounted and programmed by a service engineer. Afterwards you should adjust the Auto Sampler.

Note

At the same time you can adjust the "**SafePos**" option, as required. **See** Notes on the "SafePos" Function (page 40).



► Function key [**Setup**] is selected.

- 1 Touch [**Setup**].
- 2 Make sure the Auto Sampler is selected.
- 3 Touch [**Start adjustments**] to open the Auto Sampler adjustment window.
⇒ Window "**Auto sampler**" for adjustment opens.
- 4 Follow the instructions of the adjustment procedure.

Note

Dosing head and the sample container will now have an offset.

- 5 To align them, touch the right arrow key  to move the Auto Sampler stepwise until the opening of the sample container is located exactly in the center below the dosing head.
- 6 Confirm with [**OK**].
⇒ The Auto Sampler is now adjusted and automatically moves to the "**Home**" position

Note

If you move the Auto Sampler too far, you can move it back by the appropriate number of steps using the left arrow key. However, be aware that the sample container does not move back thus making correct positioning difficult. In this case, use [**Test**] to verify the positioning of the sample container and re-adjust the device if required.

If you use new sample containers with a different opening or the current containers are no longer exactly centered, re-adjust the Auto Sampler.

5.6.3.4 Notes on the "SafePos" Function

When using **sample containers with small openings** the dosing head needs to be lowered close to the container to prevent spilling. In this case we strongly recommend to select "**SafePos**", see Working with "SafePos" (page 34). Before every movement of the Auto Sampler, "**SafePos**" automatically raises the dosing head to a safe position thus preventing it from touching the sample. Upon the subsequent dosing cycle the dosing head is lowered automatically to the dosing position again.

5.6.3.5 Loading the magazines

- Left side door is open.
- 1 Remove a magazine and load it with your sample containers.
 - 2 Re-install the magazine according to their numbering (position "1" is to the left of the dosing head).
 - 3 Check that the magazine is even.
 - 4 Press .
 - ⇒ Auto Sampler moves forward to next magazine.
 - 5 Repeat the loading procedure for up to 5 times.

5.6.3.6 Dosing with Auto Sampler

- 1 Touch [**Start**] to start the dosing.
⇒ The **Dosing steps** leads you through the various stages of the dosing cycle. The workflow is almost the same as for dosings without the Auto Sampler.
- 2 At the beginning of the dosing, enter the **number of samples to be dosed** (1 – 1000).
⇒ The Auto Sampler moves to the "**Home**" position
- 3 Enter all subsequent data (user ID, sample ID, target quantity and tolerance). These entries apply to all samples to be dosed.
⇒ Once the data has been entered, the instrument automatically locates the sample container no. 1 and starts dosing.

⇒ Upon completion of the dosing cycle the Auto Sampler is reset and moves back to the initial position. The instrument is now ready for the next dosing.

Notes

- If the number of samples to be dosed is greater than 30, the instrument will temporarily suspend the dosing after sample #30 has been dispensed. You can then install new sample containers (this break will not reset the sample counter). Touch [**Start**] again, then select the option to resume the current dosing.
- The "**Sample ID**" applies to all samples of a dosing series. For proper identification of single samples the "**Sample ID**" is followed by a consecutive number that appears on printed labels and records as well as in XML data records (e.g. AB-1, AB-2, ...).
- There is no individual cutting of sample labels but the labels are cut all together at the end of the dosing cycle, resulting in a tab holding the labels of all samples of the recent dosing series.
- When working with the Auto Sampler all of the settings described in the previous chapters (steps of the **Dosing steps**, door behavior, ...) apply correspondingly.

5.6.3.7 Aborting a Running Dosing Cycle

- 1 To abort a running dosing cycle, touch [**C**].
⇒ The window "**Dosage stopped by user**" appears.
- 2 Restart the dosing and select one of the following options:
 - "**Continue actual series**": To resume the current series starting with the next sample. The previous aborted sample will **not** be dosed again.
 - "**New series**": To define a new series.
 - "**Cancel**": To close the window. It will reappear when starting the next dosing).

Note

Before resuming an interrupted dosing cycle replace all full sample containers with empty ones.

5.6.3.8 One Single Dosing

If you want a single dosing **without** using the Auto Sampler, e.g. dosing into a larger sample container.



- ▶ Auto Sampler is in the "**Home**" position.
 - ▶ Weighing pan is empty.
 - ▶ Function key [**Setup**] is selected.
- 1 Touch [**Setup**].
 - 2 Make sure the Auto Sampler is **de-selected** and confirm with [**OK**].
 - 3 Remove both magazines to the left and right of the weighing pan.
 - 4 Remove the cover of "**Home**" position to get access to the weighing pan.
 - 5 Install the large weighing pan **1**.
 - 6 Start dosing.

If you want to resume working with the Auto Sampler, remove the large weighing pan, install both magazines, and finally re-select the Auto Sampler.

5.6.3.9 Using the Weight Basket

The weight basket is used when adjusting the instrument with an external weight (or testing the adjustment). The weight basket holds the external weight.



- 1 Remove the cover of the "Home" position.
 - 2 Put the weight basket **1** onto the weighing pan.
 - 3 Make sure the weight basket is properly fitted to the weighing pan (watch recess on bottom side of weight basket).
- ⇒ The instrument is ready for adjustment with an external weight. **See** Adjusting the Instrument (page 36)

5.7 Liquid Module

5.7.1 Overview

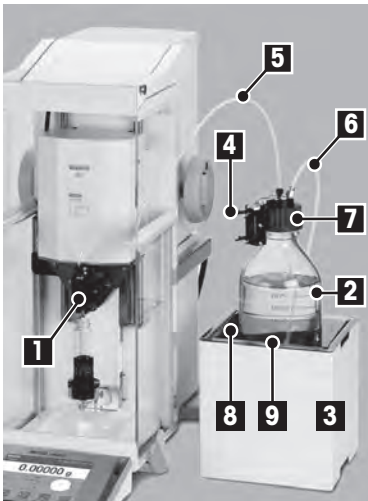

Liquid Module

- 1 Liquid dosing head
- 2 Liquid bottle
- 3 Pump module
- 4 Liquid dosing head support
- 5 Liquid tube
- 6 Air tube
- 7 Liquid bottle cap
- 8 Bottle holder
- 9 Drip pan

Bottle

- 10 Tube fitting
- 11 Suction filter¹⁾

¹⁾ appearance may vary according to filter type



CAUTION

Damage of Bottle

The bottle has to be pressure tested up to 1.5 bar (21 psi).

5.7.2 Function

The principle function of the liquid module is:

- Pump module **3** pumps air in the bottle **2**.
- Pressure builds up through air tube **6**.
- Pressure reaches min. 0.3 to max. 0.5 bar (4.4 to 7.2 psi).
- Micro dispensing valve in the dosing head **1** opens.
- Liquid ascends the liquid tube **5**.
- Instrument doses liquid into sample vessel on basis of weight.

5.7.3 Scope of Delivery - Liquid Module

- Pump module
- Drip pan
- Bottle holder
- Bottle
- Bottle cap with support liquid dosing head
- Liquid dosing head
- Air tube
- Liquid tube include fitting
- Cable CAN
- Inline frit filter (two pieces)
- Cleaning tool for micro dispensing valve

5.7.4 Wiring the Components

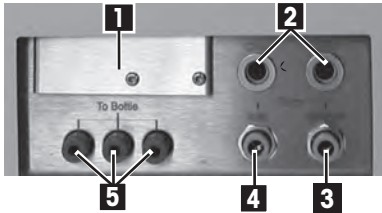

- 1 Faceplate
- 2 CAN connector
- 3 Exhaust air outlet
- 4 Air inlet
- 5 Air outlet to bottle

Wiring

- 1 Connect Quantos with the liquid module via CAN cable.

Note

There are two CAN connectors. There is no preference which one to take.

- 2 Connect air tube of the bottle to air outlet.

Note

A tube in the air outlet to bottle opens the valve of the air outlet. Never leave a tube without connecting a bottle to this air outlet, because pressure cannot be built up.

- 3 If you have a sound absorber, connect it to air inlet.

⇒ Liquid module is connected.

For further tube sizes or materials of wetted parts **see** Model-Specific Data

Exhaust air outlet

Outlet to feed via a tube the exhaust air or gas to a specific destination.

Outer tube diameter: 6 mm



CAUTION

Dangerous liquids

If you use toxic, explosive or flammable liquids, the exhaust air will be contaminated.

- Use a tube for the exhaust air outlet.

Air inlet

Inlet to feed the pump with protective gas, e.g. nitrogen.

Outer tube diameter: 6 mm

Max. pressure range: 0.3 ... 0.5 bar (4.4 ... 7.2 psi)

Faceplate

Do not remove the faceplate.

5.7.5 Operation

5.7.5.1 First Steps

5.7.5.1.1 Working with Liquid Module

Note

The liquid module is mounted by a METTLER TOLEDO Service Engineer.

After a master reset, check following setting: "**Application Setup > Liquid module**" > [Mounted]

Configure your settings in this menu. More details, **see** Configuring the Liquid Module (page 66)

Navigation: "**Application Setup > Liquid module**" > [Define]



- "Liquid module"
- "Open air bleed valve"
- "Max. solvent mass"

5.7.5.1.2 Installing Liquid Dosing Head

- 1 Touch the catch at the dosing head connector and place the liquid dosing head in the instrument.
- 2 Thread the tube through the guide notch **1**.
- 3 Slide the liquid dosing head onto the dosing head support until it comes to a stop.
- 4 Press it down slightly until it is properly seated in the holding pins.

Note

Check that dosing head is inserted correctly.

If there is just a small gap between dosing head and its support, press it down again.

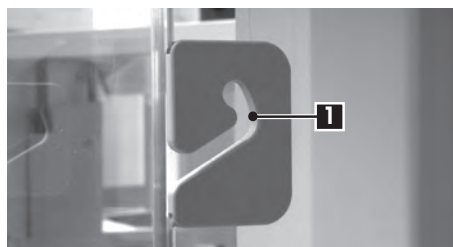
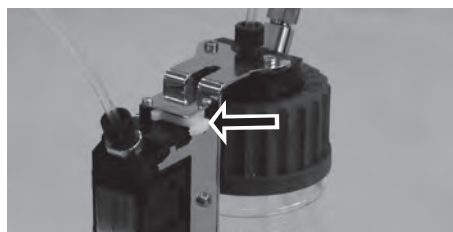

5.7.5.1.3 Dosing Liquid

- ▶ Liquid dosing head is installed.
- ▶ The weighing pan is empty.
- ▶ Take the standard factory setting for "**Dosing steps (liquid)**".

- 1 Touch [Start] > [Liquid dosing].
- 2 Enter the amount "**Target liquid [g]**" required.
- 3 Confirm with [OK].
- 4 Place sample vessel on weighing pan.
- 5 Confirm with [OK].
 - ⇒ Pressure builds up.
 - ⇒ Instrument doses liquid.

Note

- Bubbles in the tube do not impair the result, because the target result is weighed.
- If you dose liquids that might crystallize, clean the dosing head from time to time. **See** Cleaning the Liquid Module (page 87)

5.7.5.1.4 Dosing Solution

Dosing a solution

If you want to dose a solution there are different menu behaviours according to use cases. In this chapter is how the standard way works, how you dose a powder and a liquid with the instrument.

For other use cases, **see** Special Workflows (page 45).

Note

Solution dosings are not possible with the Auto Sampler. You can't work unattended, because you have to change dosing heads.

Solution dosings work with a concentration **not** measured by volume [ml], but by weight [mg].

Concentration To calculate the concentration (C):

$$C = \text{mass of solid} / (\text{mass of solid} + \text{mass of liquid})$$

Powder and liquid

- ▶ Powder or manual dosing head is inserted.
 - ▶ Weighing pan is empty.
 - ▶ Take the standard factory setting for "**Dosing steps (solution)**".
 - ▶ Check following setting: "**Application Setup > Liquid module**" > [Mounted]
- 1 Touch [Start] > [Solution].
 - 2 Enter each information of "**Dosing steps (solution)**" required.
 - 3 Enter the "**Concentration [mg/g]**" required.
 - 4 Enter the "**Target solution [g]**" required. (max. 100.0 g)
 - 5 Place sample vessel on weighing pan.
 - ⇒ Instrument doses powder.
 - 6 Install liquid dosing head.
 - ⇒ Instrument doses liquid.

5.7.5.1.5 Releasing Pressure

If you need to release the pressure in e.g. the bottle, switch off the instrument.

Switching Off



- Press [On/Off] until "Off" appears in the display.

Note

Do not disconnect the instrument from the power supply except if you will not be using the instrument for an extended period.

5.7.5.2 Special Workflows

5.7.5.2.1 Starting with Liquid Dosing Head

Dosing solution with pre-prepared solid

If you have sample vessels with already prepared solid e.g. a tablet you can leave the liquid dosing head installed.

- ▶ Liquid dosing head is installed.
- ▶ Mass of solid is known.
- ▶ Weighing pan is empty.

- ▶ Take the standard factory setting for "**Dosing steps (solution)**".
 - ▶ Check following setting: "**Application Setup > Liquid module**" > [Mounted]
- 1 Touch [Start] > [Solution] > "**Enter predosed quantity**".
 - 2 Enter the weight of the pre-dosed solid in "**Pre-dosed Quantity [mg]**".
 - 3 Enter each information of "**Dosing steps (solution)**" required.
 - 4 Place liquid sample vessel on weighing pan.
 - ⇒ Instrument doses liquid.

Dosing solution – powder manually

If you have just very few solid samples you can leave the liquid dosing head installed.

- ▶ Liquid dosing head is installed.
 - ▶ Weighing pan is empty.
 - ▶ Take the standard factory setting for "**Dosing steps (solution)**".
 - ▶ Check following setting: "**Application Setup > Liquid module**" > [Mounted]
- 1 Touch [Start] > [Solution] > "**Start manual dosing**".
 - 2 Enter each information of "**Dosing steps (solution)**" required.
 - 3 Place liquid sample vessel on weighing pan.
 - 4 Dose manually the needed powder and confirm with [OK].
 - ⇒ Instrument doses liquid.

5.7.5.2.2 Starting with Manual Dosing Head

Dosing solution with often used powders

If you often need the same solid the manual head helps you to save information and you have to write less in the "**Dosing steps (solution)**".

- ▶ Manual dosing head is written and installed.
 - ▶ Weighing pan is empty.
 - ▶ Take the standard factory setting for "**Dosing steps (solution)**".
 - ▶ Check following setting: "**Application Setup > Liquid module**" > [Mounted]
- 1 Touch [Start] > [Solution].
 - 2 Enter each information of "**Dosing steps (solution)**" required.
 - 3 Enter the "**Concentration [mg/g]**" required.
 - 4 Enter the "**Target solution [g]**" required. (max. 100.0 g)
 - 5 Place sample vessel on weighing pan.
 - 6 Dose manually the needed powder and confirm with [OK].
 - 7 Install liquid dosing head.
 - ⇒ Instrument doses liquid.

5.7.5.3 Handling of Bottle

Changing a bottle

If you have more than one bottle equipped with cap and dosing head:

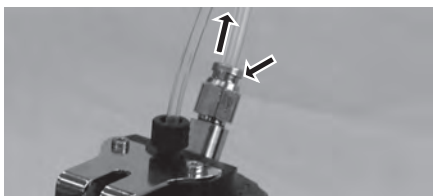

- ▶ Pressure is released.
- 1 Install dosing head on the support at the bottle.
- 2 Unplug air tube.
- 3 To seal the bottle, insert pin into air tube fitting.
- 4 Take the new bottle.
- 5 Connect air tube to new bottle.
- 6 To continue dosing with the new bottle, install head on support of the instrument.

Filling of bottle

The Inline Frit Filter has to be covered with liquid at all times. Before the Inline Frit Filter gets dry, refill the bottle.

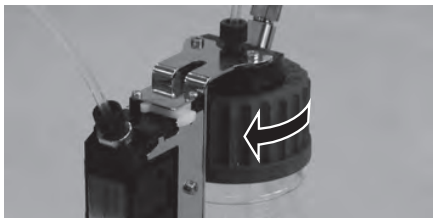

- ▶ Pressure is released.
 - 1 Unscrew regular cap (GL45).
 - 2 Fill in the liquid. (max. is shown on bottle e.g. 1000 ml)
- Note**
Do not exceed the maximum. The air above the liquid is necessary for dosing.
- 3 Screw the cap.
 - 4 Check that the cap is tight.

Installing new PEEK nut

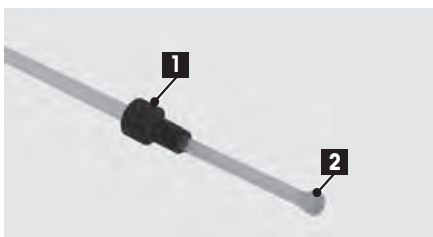

- 1 Remove PEEK nut **1**.
- 2 Cut off ferrule **2**. Check that the end of the tube is straight.
- 3 Thread the PEEK nut.
- 4 Thread ferrule. Check that the face of the ferrule is aligned to the face of the tube.
- 5 Screw the PEEK nut tight.
- 6 Screw a quarter turn more.

Changing the liquid of bottle

You have just one cap with dosing head and want to change the liquid:

- ▶ Pressure is released.
- 1 Unplug air tube.
- 2 Unscrew regular cap (GL45).
- 3 Unscrew inner PEEK nut.
- 4 Change the inner tube and the Inline Frit Filter.
- 5 Screw the regular cap on new bottle.
- 6 Check that the cap is tight.
- 7 Connect air tube to new bottle.
- 8 To purge the contaminated external tube, touch **[Start]** > **[Liquid dosing]**.

5.7.5.4 Basic Operation Settings

This chapter describes functions that differ from the standard Quantos instrument.

If you touch **[Start]** with the liquid module, you get these options:



[Solution]	To prepare a solution with defined concentration solid/liquid in mg/g .
[Solid dosing]	To dose a powder.
[Liquid dosing]	To dose a liquid.
[Cancel]	To return.

See Configuring the Liquid Module (page 66)

5.7.5.5 Activating Density

Basically Quantos works gravimetric. But users who work with liquids normally think volumetric and need the parameter of density.

Navigation: Application Setup

Activating and printing density for solutions

Formula: Concentration volumetric [mg/ml] = Concentration gravimetric [mg/g] x Density [g/ml]

- 1 Activate **Dosing steps (solution) > Density param..**
- 2 Activate **Data output > Sample label > Text (solution) > Density param..**
- 3 To print the volume, activate **Data output > Sample label > Text (solution) > Vol. conc..**

Note

Other output formats in **Data output**:

- **Sample label > Matrix code (solution)**
- **Sample protocol > Single value (solution)**
- **Sample data output > Host (XML)**

Activating and printing density for liquids

Formula: Volume [ml] = Mass [g] / Density [g/ml]

- 1 Activate **Dosing steps (liquid) > Density param..**
- 2 Activate **Data output > Sample label > Text (liquid dosing) > Density param..**
- 3 To print the volume, activate **Data output > Sample label > Text (solution) > Liquid vol..**

Note

Other output formats in **Data output**:

- **Sample label > Matrix code (liquid dosing)**
- **Sample protocol > Single value (liquid dosing)**
- **Sample data output > Host (XML)**

5.8 Upgrade Differences

Also see

- Glass Draft Shield (page 25)
- Basics of Auto Sampler (page 38)

5.8.1 Overview









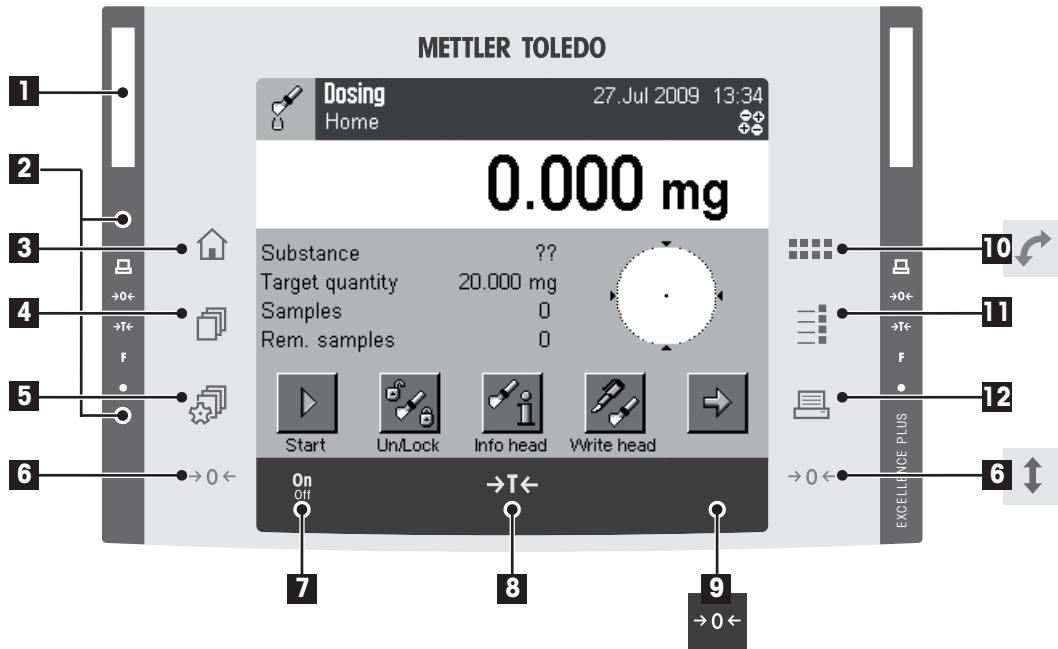

Upgrade means that you have chosen to upgrade your balance for the application of powder, liquid or powder and liquid dosing. This means that your balance has changed to a dosing unit with the software update and the standard balance applications are not longer available.

Terminal

Most buttons between Quantos and the upgraded Balance are the same, but some have changed. Here you find the mapping between Quantos and your balance terminal. Quantos information, **see** Terminal (page 12).

See Spare Parts (page 112)



- | | | | | |
|---|---|---|----|--|
| 1 | SmartSens | See Settings for SmartSens and ErgoSens (page 64) | | |
| 2 | Status bar | See Terminal (page 12) | 8 |  Tare |
| 3 |  | [Home] | 9 |  Set to zero |
| 4 |  | User profile | 10 |  Front door for powder dosing only |
| 5 |  | Settings for user profile | 11 |  Configuration |
| 6 |  | Side doors
The buttons are located on both sides. See Glass Draft Shield (page 50) | | |
| 7 |  | [On/Off] | 12 |  Print |

5.8.2 Scope of Delivery - Upgrade

Powder and Liquid Dosing Upgrade

- Option Powder Dosing See Scope of Delivery (page 15) > Dosing Unit
- Option Liquid Module See Scope of Delivery (page 43)

Powder Dosing Upgrade

- Option Powder Dosing See Scope of Delivery (page 15) > Dosing Unit

Liquid Dosing Upgrade

- Liquid Dosing Unit QLX45
- Option Liquid Module See Scope of Delivery (page 43)

Also see

- Scope of Delivery - Liquid Module (page 43)

5.8.3 Wiring the Components

Powder Dosing Upgrade

See Wiring the Components (page 18)

Liquid Dosing Upgrade

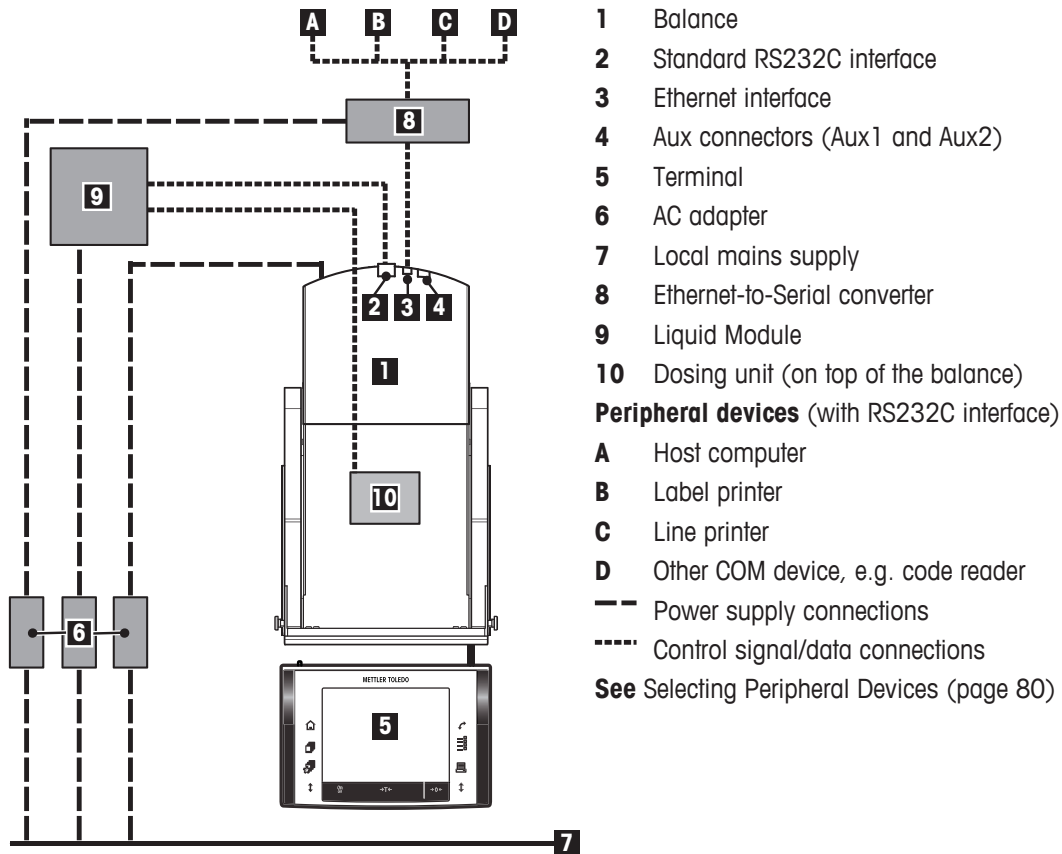

5.8.4 Operation

5.8.4.1 Glass Draft Shield

Powder Dosing Upgrade

General information for the side doors and front door, **see** Glass Draft Shield (page 25).

Liquid Dosing Upgrade

With the liquid dosing upgrade you got a new top glass and a new side door.

General information for the side doors, **see** Glass Draft Shield (page 25). The front glass will not change to a door with this upgrade.

Removing the side doors, **see** the balance-specific Operating Instructions Part 1 <http://www.mt.com/excellence>.

5.8.4.2 Releasing Pressure

If you need to release the pressure in e.g. the bottle, unplug the CAN plug.

6 Settings

6.1 User Profiles

This menu is to choose the user profile.

- To check or change the user profile, press .
- ⇒ Window "**User**" opens.

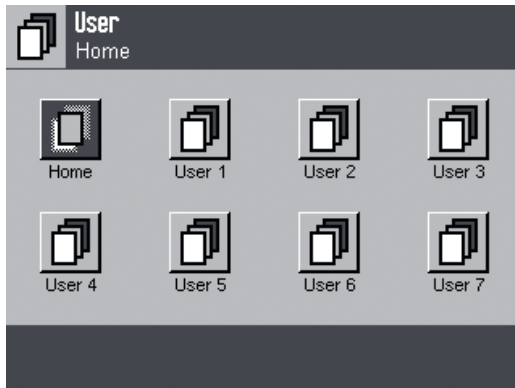

There are 8 user profiles.

In this menu you just choose the user profile. The user profile settings you define in the application and user settings.

Note

You can use the user profiles for different typical users as well as for special usecases. The user profiles have default names. Change the name of the function key to an appropriate name of yours.

See Entering User Data (page 70) and Best Practice of User Profiles (page 35)



Also see

- User Settings (page 69)

6.2 Application Settings

This chapter describes how to customize the dosing application for your particular requirements.

Please note that all settings are stored under the active user profile and apply when working within this profile. Therefore make sure that you have selected the desired user profile first.

- To check the user profile, press .
- To print any setting, press .

Overview

- To access the application settings, touch .
- ⇒ Window "**Application Setup**" opens.



Navigation: "Application Setup"

- "**Function Keys**" To specify which function keys are to appear at the bottom of the display. These keys enable direct access to specific functions. **See** Selecting Function Keys (page 53)
- "**Info Field**" To specify which information fields are to be displayed. **See** Selecting Information Fields (page 55)
- "**Data output**" To specify the type of data output (record, label, etc.) and define the information to be included. **See** Defining Data Output (page 55)
- "**Dosing steps (solid)**" To configure the "**Dosing steps**" that leads you step-by-step through the dosing procedure. **See** Configuring the Dosing Steps (page 61)
- "**Dosing steps (solution)**"
- "**Dosing steps (liquid)**"
- "**Tolerance Mode**" To select whether the tolerance value designates a "**+/- Tolerance**" or a "**0/+Tolerance**". **See** Selecting the Tolerance Mode (page 62)
- "**Head def. data**" To select the amount of data that is required when setting up a head with the function key [**Write head**]. **See** Setting up the Head Definition Data (page 62)
- "**Algo**" Algorithm used for dosing unit control. **See** Selecting the Dosing Algorithm (page 62)
- "**Display Unit**" To specify the display unit. **See** Selecting the Display Unit (page 62)
- "**Titles**" To define titles that can be included in the data output (labels, records, etc.). **See** Defining Titles (page 63)
- "**Barcode**" These settings are only relevant if a barcode reader is connected. To specify how barcode data is to be processed. **See** Specifications for External Devices (page 63)
- "**Ext. Keyboard**" These settings are only relevant if an external keyboard is connected. To specify how keyboard inputs are to be processed. **See** Specifications for External Devices (page 63)
- "**MinWeigh**" The function "**MinWeigh**" ensures that the dosing results are within a specified tolerance range, in accordance with the requirements of your quality assurance system. **See** Settings for the "MinWeigh" Function (page 63)
- "**Smart & ErgoSens**" To program the two "SmartSens" sensors on the terminal. The "ErgoSens" setting is used to configure the "Aux" connectors of the instrument for the AntiStatic Kit. **See** Settings for SmartSens and ErgoSens (page 64)
- "**Side doors**" Settings for the lateral doors of the draft shield. **See** Configuring the Side Doors (page 65)

"Front door"	Settings for the front door of the draft shield. See Configuring the Front Door (page 65)
"Liquid module"	Settings for the optional liquid module. See Configuring the Liquid Module (page 66)
"Auto sampler"	Settings for the optional Auto Sampler. See Configuring the Auto Sampler (page 65)
"Tapper"	Settings for the built-in "Tapper". See Settings for the Tapper (page 66)
"SafePos"	Installation of the option "SafePos". See Setting for "SafePos" Option (page 67)
"Dosing unit"	Settings for the dosing unit. See Settings for the Dosing Unit (page 67)
"Maintenance"	Adjustment of the front door. See Maintenance (page 67)

– If you have defined all the required settings, press [OK] to return to the application.

The various settings are described in detail in the following chapters.

Printing the "Application Setup"

Application Setup	
Function Keys	
Start	1
Quantity	5
Tolerance	6
User ID	-
Sample ID	-
Unlock	2
Copy head	-
Info head	3
Write head	4
Samples	7

► Navigation "Application Setup"

– To print the settings at any time, press .

(provided that a printer is connected and selected as the output device in the system settings) **See** Selecting Peripheral Devices (page 80)

On the left is an excerpt from a printout of the application settings.

Note

The printout is rather long as the settings of every single menu and submenu will be included.

6.2.1 Selecting Function Keys

Function keys enable direct access to specific functions and settings in the application. They are displayed in the application at the bottom of the display. Touching a key triggers the corresponding function.



selected



de-selected

Function Keys assigned a number are displayed in the application. The numbers determine the order of the function keys in the display.

- 1 To select or de-select a function key, touch it. The order of the keys is updated automatically.
- 2 To completely redefine the order of the keys, first de-select all the function keys and then select them in the desired order.
- 3 To return to the factory setting, touch [STD].
- 4 - To save the modifications, touch [OK].
- To exit the input window without saving, touch [C].

Navigation: "Application Setup > Function Keys" > [Define]

"Function Keys"



"Start"



















To start a dosing cycle.



"Quantity"

To access quickly the target quantity of the dosing steps.

See Configuring the Dosing Steps (page 61)

	"Tolerance"	To access quickly the accuracy of the dosing steps.
	"User ID"	To access quickly the user ID of the dosing steps.
	"Sample ID"	To access quickly the sample ID of the dosing steps.
Note		
If the Dosing steps is selected you may de-select the related functions keys to have more space for others.		
	"Un/Lock"	To unlock the dosing head so that it can be removed. See Unlocking the Head Manually (page 32)
	"Copy head"	To copy data from one head to another. See Copying Data from one Head to Another (page 31)
	"Info head"	To view the data stored in the current head. See Displaying Head Information (page 28)
	"Write head"	To enter the data of a new head or edit data of a used head. See Preparing a new Head for Operation (page 29)
	"Samples"	To define the number of samples to be dosed. If you have selected the appropriate information field the number of remaining samples will be shown there.
	"Set content"	When filling up the powder container of a dosing head this function key stores the net weight of the powder thus facilitating the setup of the head. See Preparing a new Head for Operation (page 29)
	"Right", "Left", "Home"	For Auto Sampler only: To move the Auto Sampler. See Auto Sampler (page 38)
	"Tapper"	To actuate the built-in tapper manually. How to configure the Tapper : See Settings for the Tapper (page 66)
	"Setup"	For Auto Sampler and SafePos only: To select and adjust of the Auto Sampler directly and the "SafePos" option. See Advanced Features (page 32) or Auto Sampler (page 38)
	"SafePos"	For SafePos only: To move the dosing head from the dosing position to the safe position, and vice versa. To check that the position is correct. See Advanced Features (page 32)
	"Adjust.int", "Adjust.ext"	To adjust the instrument using the internal or an external adjustment weight. See Adjusting the Instrument (page 36)
	"Test int", "Test ext"	To check the instrument adjustment using the internal or an external test weight.
	"1/10d", "1/100d", "1/1000d"	To modify the resolution of the result. See Changing the Resolution of Dosing Result (page 32)
Note		
With some models "1/2d" and "1/5d" function keys are also available.		
	"Adj. History"	To display a list of adjustment operations that have been carried out. The operations that were selected in the system settings are displayed. See Settings for Adjustment and Tests (page 75)
	"Purge"	For Liquid Module only: To purge the liquid dosing head for a defined time. See Cleaning the Liquid Module (page 87)

6.2.2 Selecting Information Fields

The information fields of the display continuously provide information on the sample, the target quantity, etc.

The information fields assigned a number are displayed in the application. The numbers determine the order of the information fields in the display.

(max. 4 information fields)

- 1 To select or de-select an information field, touch it. The order of the fields is updated automatically.
- 2 To completely redefine the order of the fields, first de-select all the information fields and then select them in the desired order.
- 3 To return to the factory setting, touch **[STD]**.
- 4 - To save the modifications, touch **[OK]**.
- To exit without saving, touch **[C]**.

Navigation: "Application Setup > Info Field" > [Define]

"Var1"..."Var4"	To show the contents of the four customizable fields defined when setting up a dosing head.
Note "Var1" to "Var4" are just the default placeholders, they will be replaced with the titles you defined when setting up the head.	
"Target quantity"	To show the target quantity that was entered, either in the "Dosing steps" or through the function key [Quantity] .
"Tolerance"	To show the tolerance for dosing, either entered in the "Dosing steps" or via the function key [Tolerance] .
"User ID"	To display the user ID entered, either in the "Dosing steps" or through the function key [User ID] .
"Sample ID"	To display the sample ID entered, either in the "Dosing steps" or through the function key [Sample ID] .
"Substance"	To display the identification of the substance (retrieved from the dosing head).
"Samples"	To display the total number of samples to be dosed as entered via the function key [Samples] .
"Rem. samples"	To count and display the number of samples remaining to be dosed assuming the total number of samples has been entered via the function key [Samples] .
"Rem. dosages"	To display the number of dosing cycles left before the dosing head needs to be replaced.



6.2.3 Defining Data Output

The instrument can output data to a variety of peripherals. In this menu you define the form of the output (printed label, printed record, XML data or display) and you want to set up the amount of data sent to the respective output device. However, you cannot reduce the amount of data sent in XML format to the host computer. You can output the data of a sample and/or the data stored in the dosing head.

This menu contains a total of 9 submenus, 4 of which are used to define the output of sample data ("Sample ..."). The other 5 submenus are used to define the output of head data ("Head ..."). The sample labels are usually affixed to the sample container while the head labels can be affixed to the dosing head.

Navigation: "Application Setup > Data output" > [Define]

"Sample label"	To specify the sample data to be printed on the labels. The sample labels are usually affixed to the sample container. See Specifying the Contents of Sample Data Labels (page 56)
"Sample protocol"	To specify the sample data sent to a line printer. See Specifying the Contents of Sample Data Records (page 59)

"Sample data output"	To select or de-select the output of sample data to a particular device, e.g. you can decide whether or not you want to print a label. See Defining the Target Devices for Sample Data (page 60)
"Sample data output mode"	To specify whether data is sent automatically after dosing is complete or manually by pressing  . See Defining the Output Mode for Sample Data (page 60)
"Head label"	To specify the contents of the label printed on the label printer. The head label can be affixed to the dosing head. Similar to Specifying the Contents of Sample Data Labels (page 56)
"Head protocol"	To specify the head data sent to a line printer. See Specifying the Contents of Sample Data Records (page 59)
"Head data output"	To select or de-select the output of head data to a particular device, e.g. you can decide whether or not you want to print a label. See Defining the Target Devices for Sample Data (page 60)
"Head data output mode"	To specify whether head data is sent automatically or manually by pressing  . See Defining the Output of Dosing Head Data (page 61)
"Info head"	To specify the data displayed by touching [Info head]. See Specifying Info Head (page 61)

6.2.3.1 Specifying the Contents of Sample Data Labels

If you have a label printer connected to your instrument you may record the dosing results and other related information on labels. The labels include a plain text section and a code section that may hold a matrix code or a barcode. The content of these sections is defined by the user.

Navigation: "Data output > Sample label" > [Define]

"Text (solid dosing)"	To specify the information you want to include in the text section of the label. With matrix code or barcode (max. of 5 label text items)
"Text (liquid dosing)"	Without a code (max. of 8 label text items)
"Text (solution)"	
"Matrix code (solid dosing)"	If you include a standard matrix code, to define the matrix code. Note
"Matrix code (liquid dosing)"	If no item is selected, the code will not print.
"Matrix code (solution)"	
"Label layout"	To select one of the preset layout schemes for your label.
"Label quantity"	To specify the amount of labels you want to print per sample.
"Label barcode"	If you include a standard "Code 128" barcode with your label, to define the contents of the barcode.
"Cutter man. series"	To specify whether the labels of a dosing series will be cut after each individual dosing or at the end of the sequence.

These options are explained in the following sections.

You are already familiar with most of the items you can select here. They include data entered before starting a dosing cycle (e.g. the sample ID) and the user data entered when setting up a new dosing head.

Navigation: "Sample label > Text (solid dosing)" > [Define]

"Substance"	Prints the identification of the substance (retrieved from the dosing head).
-------------	--

" Sample ID "	Prints the " Sample ID " entered (either in the Dosing steps or through the function key [Sample ID]).
" Lot ID "	Prints the " Lot ID " read from the current dosing head.
" Content [mg] "	Initial weight of the powder in the current dosing head.
" Tolerance "	Specifies the accuracy you specified for the current dosing.
" User ID "	Prints the " User ID " entered (either in the Dosing steps or through the function key [User ID]).
" Dispense date "	Date of the current dosing.
" Exp. date "	Expiry date of the substance in the current dosing head.
" Retest date "	Retest date defined in the settings of the dosing head.
" Balance ID "	Identification of the instrument defined in the " System > Balance Info ".
" Var1 " ... " Var4 "	Prints the title and contents of the four customizable fields defined in the settings of the dosing head.
	Note " Var1 " ... " Var4 " are just the default placeholders, they will be replaced with the field titles defined in the settings of the dosing head.
" Title 1 ", " Title 2 "	Prints the titles defined in the menu.
" Validity "	Indicates whether the dosing result is " Valid " (within the tolerance) or " Invalid " (out of tolerance).
" MinWeigh "	Indicates whether the " MinWeigh " criteria have been met (" Valid " or " Invalid "). If the " MinWeigh " function is de-select " Off " will be printed instead.
" Dose duration "	Prints the duration of the dosing cycle in seconds.
" Target quantity "	Prints the target quantity of the dosing.
" Label index "	This is a counter for the number of labels printed for a particular sample. This information may be of interest for quality assurance and traceability.
" Sample position "	For Auto Sampler only: Prints the location of the sample in the Auto Sampler (1 – 30).
" Head type "	Type of dosing head used for the current dosing.
" Head ID "	Serial number of the dosing head used for the current dosing.

Note

"**Text (liquid dosing)**" and "**Text (solution)**" have similar submenus.

Navigation: "**Sample label > Matrix code (solid dosing)**" > [**Define**]

"**Matrix code (solid dosing)**" The items available for the matrix code of the sample label are the same as the ones for the label text.

- Define your choice to be included in the matrix code. (max. 8 items)

Note

The size of the code will grow with every item added (thus leaving less space for the label text items).

Note









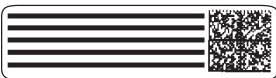

"**Matrix code (liquid dosing)**" and "**Matrix code (solution)**" have the same submenus. **See** Overview Menu (page 114)

Navigation: Sample label > Label layout

You can choose from 10 preset layout schemes for your sample labels. The table below show a sample label each for all 10 layout schemes.

Note

The layout schemes differ in type of font and font size used, and some include a matrix code or a barcode while others are plain text labels. The layout schemes respect the label text items you have selected and their printing order. However, if you have selected too many text items, the label may run out of space (especially if the layout includes a matrix code or barcode). In this case the label will just contain the text items that fit into the available space. You may now rearrange the printing order of the text items in a way that the most important items are printed first (printing always starts with item 1). As an alternative, you may select another layout scheme that accommodates more text items, i.e. one with a smaller font size or one without a code. The above restrictions apply to text items only, the codes (matrix code or barcode) will always be complete, i.e. they hold all the information you selected for code printing.

No.	Specimen	Number of text rows	Font size	No.	Specimen	Number of text rows	Font size
1		5	large	6		5	small
2		5	small	7		8	large and small
3		5	large	8		3	small
4		8	small	9		3	large
5		10	small	10		6	small

See Handling of Powder Dosing Heads and Containers (page 27)

Navigation: "Sample label > Label quantity"

"**Label quantity**" – Define the quantity of printed labels per sample. (max. 5 labels)

Navigation: "Sample label > Label barcode"

"**Label barcode**" The standard "Code 128" barcode that can be printed on the labels allows for just one item to be selected.
([Substance], [Sample ID], [Lot ID], [Dos. value])

Navigation: "Sample label > Cutter man. series"

- "Cutter man. series"** Label cutting for serial dosing
- ▶ manual series only, i.e. when working with the sample counter. **See** Working with Sample Counter (page 32)
 - Define whether all labels are cut individually after each dosing [**Samples**] or at the end of the dosing sequence [**Series**].
- Note**
When dosing series with the Auto Sampler the all labels will be cut at the end of the dosing sequence.

6.2.3.2 Specifying the Contents of Sample Data Records

If you have a line printer connected to your instrument you may record the dosing results and other related information on paper.

Options for record headers

Here you can specify the information you need in the header section at the top of every record. In general, header data contains information about the instrument. The header is printed automatically if it has been defined as part of the record. You are already familiar with most of the items you can select for the record header, they are very similar to the ones for label printing.

Navigation: "Data output > Sample protocol" > [Define]

- "Header"
- "Single value (solid dosing)"
- "Single value (liquid dosing)"
- "Single value (solution)"
- "Footer"

Navigation: "Sample protocol > Header" > [Define]

"Appl. Name"	To print the application name, e.g. "Dosing".
"Title 1", "Title 2"	Prints the titles defined in the menu.
"Date/Time"	Prints time and date.
"User ID"	Prints the "User ID" entered (either in the Dosing steps or through the function key [User ID]).
"Balance Type"	To read the instrument's type identification from the electronics.
"SNR:"	To read the serial numbers of the terminal and the dosing unit from the electronics.
"Balance ID"	Identification of the instrument defined in the " System > Balance Info ".
"Levelcontrol"	To indicate whether or not the instrument is correctly leveled.
"Last cal."	To print the date when the instrument was last adjusted.
"Signature"	To print a line for signing the printout.
"Blank Line"	To print a blank line.
"Dash Line"	To print a dashed line. This Option is available twice.
"3 Blank Lines"	To print 3 blank lines. Usually at the end of the printout for the paper advance.

Navigation: "Sample protocol > Single value (solid dosing)" > [Define]

In this submenu you can specify which information should be printed for each individual dosing.

Page 1		Page 2	
"Header"	"Var4"	"Lot ID"	"User ID"
"Var1"	"Title 1"	"Sample ID"	"Dispense date"
"Var2"	"Title 2"	"Content [mg]"	"Exp. date"
"Var3"	"Substance"	"Tolerance"	"Retest date"
Page 3		Page 4	
"Validity"	"Signature"	"Dash Line"	
"MinWeigh"	"Head type"	"3 Blank Lines"	
"Dose duration"	"Blank Line"		
"Target quantity"	"Dash Line"		

Note

"Single value (liquid dosing)" and "Single value (solution)" have very similar submenus.

Navigation: "Sample protocol > Footer" > [Define]

This submenu can be used to define the information to be printed at the bottom of the dosing record. The selection is very similar to "Header".

Example

Balance ID	LAB 2A

Substance	Glucose
Sample ID	XK-414
Content in mg	19.813
Dispense date	
	05.06.2008
Exp. date	21.08.2008

User ID	TRPF

This is an english sample data record output by the line printer, the items printed reflect the factory settings. In this case the Balance ID and the following dashed line form the "Header", while the User ID together with the preceding dashed line are the "Footer" and everything in-between is data from "Single value (solid dosing)".

6.2.3.3 Defining the Target Devices for Sample Data

In the "Sample data output" section you can select or de-select the output of sample data to a particular device.

Navigation: "Data output > Sample data output" > [Define]

- "Protocol" To send sample data to the line printer.
- "Label" To send sample data to the label printer.
- "Host (XML)" To sample data to a remote host computer.

Note

The instrument always transmits the full XML data set to the host computer. You cannot define the amount of data sent in XML format.

6.2.3.4 Defining the Output Mode for Sample Data

Navigation: "Data output > Sample data output mode" > [Define]

- "Manual" No automatic transfer of data. To transfer the dosing result to the selected devices, press  while it is displayed.

Note

This option is not possible if the Auto Sampler is mounted and programmed.

"Automatic" To transfer the dosing result to the selected devices automatically after a dosing cycle has been completed. - (Factory setting)

6.2.3.5 Defining the Output of Dosing Head Data

In the submenus **"Head label"**, **"Head protocol"**, **"Head data output"** and **"Head data output mode"** you will find items that are similar to the previous ones available for sample data.

This chapter describes functions that differ from the previous.

Navigation: **"Data output > Head data output mode"** > [Define]

"Manual" No automatic transfer of data. To transfer the data to the dosing head, press  while it is displayed.

"Automatic" To transfer the data to the dosing head automatically when you touch [Write head].

6.2.3.6 Specifying Info Head

In the submenu **"Info head"** specify the amount of head data displayed when touching the function key [Info head].

Navigation: **"Data output > Info head"** > [Define]

Choose one or more possibilities:

Page 1		Page 2	
"Substance"	"Retest date reached"	"Rem. quantity"	"Var1"
"Lot ID"	"Head type"	"Rem. dosages"	"Var2"
"Filling date"	"Head prod. date"	"Accuracy"	"Var3"
"Exp. date"	"Content [mg,g]"	"Dose limit"	"Var4"
Page 3			
"Type data version"			
"Head ID"			

6.2.4 Configuring the Dosing Steps

At your first dosing you clicked step by step through the user guide called **"Dosing steps"**. In the **"Dosing steps"** menu you can specify these **"Dosing steps"**. Here you select or de-select the different steps which prompt you to enter data by each dosing cycle.

All these steps are also available via the function keys with the same names.

Navigation: **Application Setup > Dosing steps (solid)** > [Define]

Choose one or more possibilities:

"User ID"	"Place container"
"Sample ID"	"Lowering head"
"Target quantity" ¹⁾	"Unlock head"
"Tolerance"	

¹⁾(min. 0.1 mg)

Navigation: **Application Setup > Dosing steps (solution)** > [Define]

Choose one or more possibilities:

User ID	Density param.
Sample ID	Place container
Concentration	Lowering head
Target solution	Unlock head

Navigation: Application Setup > Dosing steps (liquid) > [Define]

Choose one or more possibilities:

User ID	Place container
Sample ID	Lowering head
Target liquid	Unlock head
Density param.	

6.2.5 Selecting the Tolerance Mode

In the menu "**Tolerance Mode**" you select the mode you want to work with.

Navigation: "Application Setup > Tolerance Mode"

[**+/- Tolerance**] Usually, the tolerance value reflects a "**+/- Tolerance**", i.e. entering a value of 2 results in a tolerance range from -2% to + 2%.

Factory setting

[**0/+Tolerance**] In production environments under-filling a "**+/- Tolerance**" may not be allowed. In this case you may enable "**0/+Tolerance**", i.e. entering a value of 2 results in a tolerance range from 0% to +2%.

6.2.6 Setting up the Head Definition Data

In the submenu "**Head def. data**" specify the amount of head data displayed when touching the function key [**Write head**].

Navigation: "Application Setup > Head def. data" > [Define]

Choose one or more possibilities:

Page 1		Page 2	
"Substance"	"Retest date reached"	"Var3"	
"Lot ID"	"Content [mg,g]"	"Var4"	
"Filling date"	"Var1"	"Dose limit" ¹⁾²⁾	
"Exp. date"	"Var2"		

¹⁾ Range: 1 ... 999

²⁾ Change during first definition. Do not change after dosing head is used.

6.2.7 Selecting the Dosing Algorithm

In this menu you define the algorithm that controls the powder dosing unit. Liquid dosing uses an independent algorithm.

Navigation: "Application Setup > Algo"

[**Algo M**] The proactive algorithm works for most powders with good accuracy and speed. - (Factory setting)

[**Algo P**] The reactive algorithm can be used with difficult do dose powders such as compacting or inhomogeneous powders. It improves performance at small targets.

Note

Algo H (reactive) is only available in terminal software prior to V 3.30.

6.2.8 Selecting the Display Unit

In this menu you define the weighing unit you want to use.

Note

This setting changes the weight display only, while the target quantity is always entered and displayed in "mg".

Navigation: "Application Setup > Display Unit"

- [g]
- [mg] - (Factory setting)

6.2.9 Defining Titles

In this menu you can define two titles that can be included in the data output. These two titles are stored in the instrument, i.e. they are independent from the dosing head currently installed.

Navigation: "Application Setup > Titles" > [Define]

- "Title 1" > [T1]
- "Title 2" > [T2]

"T1" and "T2" are factory settings.

- Replace the default title text
e.g. general identifications such as the company or department name
(max. 20 characters)

6.2.10 Specifications for External Devices

If an external device barcode reader or a keyboard is connected to the instrument, this menu you specify how the data is handled.

Navigation: "Application Setup > Barcode"

or

Navigation: "Application Setup > Ext. Keyboard"

- | | |
|--------------|---|
| [Off] | No data is processed. This setting should be used if no external device is connected. |
| [Host] | The data is transmitted directly to a connected PC.
If no PC is connected or the PC cannot receive the data, the data is ignored. |
| [Open Input] | The data is written to the input window on the terminal that is currently open (e.g., name of the substance or lot ID). The window is closed automatically after the data is processed. If no input window is open, the data is ignored.

Factory setting |

6.2.11 Settings for the "MinWeigh" Function

Attention

The menu containing the settings for the "MinWeigh" function is disabled ex works and cannot be accessed. "MinWeigh" must be programmed by a service engineer. If you need to use this function, but cannot access it in the menu, please contact your METTLER TOLEDO dealer.

"MinWeigh"

"MinWeigh" ensures that the dosing results are within a specified tolerance range in accordance with the requirements of your quality assurance system.

Up to 3 tare values can be defined with the corresponding minimum initial weight values. In addition, the service engineer will set the weighing parameters in the user settings to ensure the required tolerance range is observed. **See** User Settings (page 69)

Note

The service engineer gives to you a certificate with the measurements, tolerances, corresponding tare weight

and minimum weight values for the initial weighing. These settings cannot be modified by the user while "MinWeigh" is selected.

In this menu you select or de-select "MinWeigh".

Navigation: "Application Setup > MinWeigh"



- [On]
- [Off]

Navigation: "MinWeigh > On" > [Define]

- "Method"** Method or methods which are set up by the service engineer according to your regulations. Up to 3 methods can be defined. e.g. [USP]
- "Info" > [Show]** To show a window containing information about "MinWeigh"-**"Method"** selected like:
- method name
 - date of the next test by the service engineer
 - minimum weight values defined by the service engineer in relation to reference tare values
- To print the information, press

6.2.12 Settings for SmartSens and ErgoSens

In this submenu you select or de-select each of the sensors. The two contact-free sensors (SmartSens) are in the top left and right corners of the terminal. The ErgoSens settings allow to configure external sensors connected to the "Aux 1" and "Aux 2" connectors located on the back panel of the instrument. Each of the two SmartSens and ErgoSens can be assigned one of the following functions by touching the relevant button.

Navigation: "Application Setup > Smart & ErgoSens" > [Define]

- "SmartSens left"
- "SmartSens right"
- "ErgoSens 1 (Aux1)"
- "ErgoSens 2 (Aux2)"

[Off] To de-select the sensor. - (Factory setting for both SmartSens)

Assign one of these functions, if you need the functionality without touching the terminal.

[Door] To open or close the side doors via sensor.

[Start] To start a dosing cycle.

[1/10d] to [1/1000d] To modify the resolution of the result.

Note

With some models [1/2d] and [1/5d] are also available.

Navigation: "Smart & ErgoSens > ErgoSens 1 (Aux1) or ErgoSens 2 (Aux2)" > [Define]

[AntiStatic Kit] "AntiStatic Kit" selected - (Factory setting)

▶ **AntiStatic Kit** is powered up.

– Connect the "AntiStatic Kit" to one of "Aux 1" or "Aux 2" connections. One or both are possible.

To make the AntiStatic Kit work, select under "**ErgoSens 1 (Aux1)**" or "**ErgoSens 2 (Aux2)**" depending on the connection used.

6.2.13 Configuring the Side Doors

In this submenu you configure the behavior of the side doors. You may link the door movement to a particular procedure or action and the doors open and close automatically as required.

Note

If the Auto Sampler is mounted and programmed, these settings do not have any effect. Also the keys **↑** do have a different function. **See** Basics of Auto Sampler (page 38)

Navigation: "Application Setup > Side doors" > [Define]

- "Dosing" Door movement is linked to the dosing procedure. - (Factory setting)
- "Un/Lock" Door movement is linked to the function key [Un/Lock].
- "Int. Adj, int. Tst" Door movement is linked to any internal adjustment or test.

6.2.14 Configuring the Front Door

In this submenu you configure the behavior of the front door. You may link the door movement to a particular procedure or action and the door opens and closes automatically as required.

Navigation: "Application Setup > Front door" > [Define]

- [Mounted] To define that the front door moves. - (Factory setting)
- [Unmounted] To define that the front door doesn't move.

Navigation: "Front door > Linked with ..." > [Define]

Choose one or more possibilities:

- "Dosing" Door movement is linked to the dosing procedure. - (Factory setting)
- "Un/Lock" Door movement is linked to the function key [Un/Lock].
- "MinWeigh test" Door movement is linked to the function "MinWeigh test".
- "Int. Adj, int. Tst" Door movement is linked to any internal adjustment or test.

6.2.15 Configuring the Auto Sampler

Note

Do not select one of these functions unless a METTLER TOLEDO Service Engineer has mounted the hardware. Otherwise the system will suffer from malfunction.

Navigation: "Application Setup > Auto sampler" > [Define]



- "Auto sampler" To select or de-select the Auto Sampler. This setting tells the instrument whether or not the Auto Sampler hardware is available and connected.

Note

If you de-select the Auto Sampler although the device hardware is available you may no longer use this device. However, the [Start] function key still starts a dosing cycle which will take place at the current position. In this case make sure there is a sample container installed, otherwise the instrument may get soiled.

- "FK "Right" (samples)" To define by how many positions the Auto Sampler turns anti-clockwise by touching [Right].
- "FK "Left" (samples)" To define by how many positions the Auto Sampler turns clockwise by touching [Left].

"Sample release (steps)" To define the number of steps the Auto Sampler moves back after every rotation to ensure the sample container in the dosing position is standing freely on the weighing pan. The factory setting matches the optional Vial adapter and ensures that the sample containers are located exactly in the center of the weighing pan if this adapter is used. You may need to change this setting if you are using new sample containers of a different diameter.

Factory setting: 8 steps
 Setting range: 1 ... 50 steps

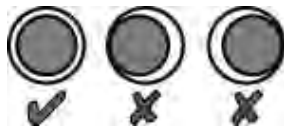

Left: Correct positioning where the sample container does not touch the magazine. Middle and right: Incorrect positioning with the sample container touching the magazine.

See Auto Sampler (page 38)

6.2.16 Configuring the Liquid Module

Note

Do not select one of these functions unless a METTLER TOLEDO Service Engineer has mounted the hardware. Otherwise the system will suffer from malfunction.

Navigation: "Application Setup > Liquid module" > [Define]



- "Liquid module"
- "Open air bleed valve"
- "Max. solvent mass"

Navigation: "Liquid module > Liquid module"

- [Mounted] To define that the liquid module is connected.
 [Unmounted] To define that the liquid module is disconnected.

Navigation: "Liquid module > Open air bleed valve"

- [Standby] To keep pressure as long as the terminal displays. (min. 10 min)
 [After dosing] To release pressure after each dosing.

Navigation: "Liquid module > Max. solvent mass"

- "Max. solvent mass [g]" To define the size of your sample container by a value. (max. 110 ml)
 This value is the basis to calculate that the solution concentration is possible and will not flood the sample container.

See Liquid Module (page 42)

6.2.17 Settings for the Tapper

The tapper improves the powder flow if it seems to be low, bridging or ratholding occurs with the powder. In this submenu you configure the tapper.

Navigation: "Application Setup > Tapper" > [Define]

- "Intensity" To determine the intensity of "Tapping before dosing".
 (Range of 10 to max. 100) - (Factory setting = 50)
- "Duration [s]" To determine the duration of "Tapping before dosing".
 (Range of 1 to 10 seconds) - (Factory setting = 1)

- "Tapping before dosing"** To select the automatic start of tapper before every dosing. This prevents large quantities of powder from dropping suddenly to the dosing mechanism during a dosing cycle which could possibly lead to overdosing.
Factory setting: [**Off**]
- "Tapping while dosing"** To select the automatic start of tapper when required during the dosing. Intensity and duration of tapping cycle will be automatic.
Factory setting [**On**]

Use cases

If tapping interferes with your workflow or your compacting powder must not be shaken, select [**Off**]. In this case we propose to select the function key [**Tapper**] to start a tapping cycle manually (using the settings for intensity and duration).

If tapping worked with your powder but does not improve the powder flow, increase the "**Intensity**" or "**Duration [s]**".

6.2.18 Setting for "SafePos" Option

After every dosing, the option "**SafePos**" moves the dosing head to a safe position to prevent touching the sample container. **See** Working with "SafePos" (page 34)

Note

Do not select one of these functions unless a METTLER TOLEDO Service Engineer has mounted the hardware. Otherwise the system will suffer from malfunction.

Navigation: "Application Setup > SafePos" > [**Define**]

[**Unmounted**] To define that no hardware is there.

[**Mounted**] To define that the hardware for "**SafePos**" is available.

To reduce electrostatic influence, **see** Preventing Electrostatic Charge (page 95)

6.2.19 Settings for the Dosing Unit

Note

Do not select one of these functions unless a METTLER TOLEDO Service Engineer has mounted the hardware. Otherwise the system will suffer from malfunction.

Navigation: "Application Setup > Dosing unit"

[**Unmounted**] To define that no hardware is there.

[**Mounted**] To define that the hardware for "**Dosing unit**" Q2 is available.

6.2.20 Maintenance

This submenu holds maintenance procedures for the front door, a fine-tuning adjustment.

Navigation: "Application Setup > Maintenance" > [**Define**]

Navigation: "Maintenance > Front door"

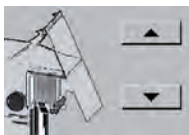

[**Execute**] To adjust the front door.

Adjusting the front door

The adjustment of the front door may be required if the door does not close completely or if there is a sound when the door hits the lower stop.



- 1 Select this function and touch [**Execute**].
 - ⇒ The front door slightly opens.
- 2 To close the front door step by step until the glass enters the lower guide rail, touch the lower arrow key.
- 3 Confirm with [**OK**].
 - ⇒ The door opens slightly and then closes again.

If you hear a hard sound when the door hits the stop, repeat the adjustment procedure and take care not to move the door too far down.

6.3 User Settings

This chapter describes how to customize the basic settings for each user. This adapts the instrument to the user's work technique and to specific tasks.





Please note that all settings are stored under the active user profile and apply when working within this profile. Therefore make sure that you have selected the desired user profile first.

- To check the user profile, press .
- To print any setting, press .

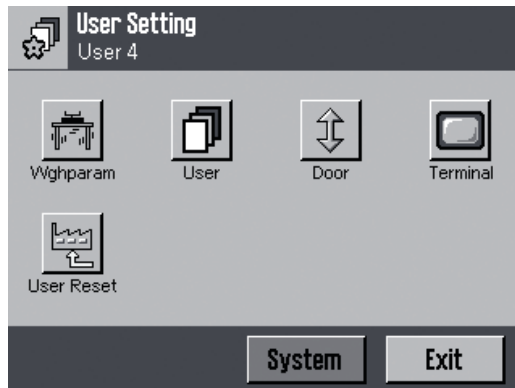
Overview

- To access the user settings, press .
- ⇒ Window "User Setting" opens.



	"Wghparam"	To specify settings for adapting the instrument to specific weighing tasks. See Defining Weighing Parameters (page 69)
	"User"	To define different user profiles with different information (name, password, menu language, etc.). See Entering User Data (page 70)
	"Door"	To specify settings for the side doors of the glass draft shield. See Settings for the Side Doors (page 71)
	"Terminal"	To specify settings for the display (brightness, etc.) and the behavior of the terminal. See Terminal Settings (page 72)
	"User Reset"	To reset the user settings to the factory settings. See Resetting User Settings (page 73)

- If you have defined all the required settings, touch [**Exit**] to return to the application. The various settings are described in detail in the following chapters.

6.3.1 Defining Weighing Parameters

In this menu you can set the weighing mode, ambient conditions and the measured value.

Note

- If this menu has been protected by the administrator, you must enter the appropriate ID and password.
- If "**Application Setup** > **MinWeigh**" is active, the weighing parameters cannot be changed.
- We recommend to leave the weighing parameters at their factory settings, because they are optimally suited for proper functioning of the instrument.



- Touch "**User Setting**" > [**Wghparam**].
⇒ "**Weighing parameters**" opens.

Navigation: "**Weighing parameters** > **Weighing Mode**"

- [**Universal**] For all normal weighing operations. - (Factory setting)
- [**Dosing**] For dosing liquid or powdery weighing samples. The instrument reacts very quickly to the smallest changes in weight.
- [**Sensor Mode**] For supplying a weighing signal which is filtered to an extent which depends on the setting for the environmental conditions. The filter behaves linearly in relation to time (not adaptively) and is suitable for the continuous processing of measurement values.
- [**Checkweighing**] For large changes in weight, and the measurement is therefore very stable.

Navigation: "**Weighing parameters** > **Environment**"

To define the ambient conditions at the location.

- [**Very stable**] For an environment which is practically free from drafts and vibrations.
- [**Stable**]
- [**Standard**] For an average working environment subject to moderate variations in the ambient conditions. - (Factory setting)
- [**Unstable**]
- [**Very unstable**] For an environment where the conditions are continuously changing.

Navigation: "**Weighing parameters** > **Value Release**"

To define the speed at which the instrument regards the measured value as stable and releases it.

- [**Very fast**] For fast results and repeatability is not very important.
- [**Fast**]
- [**Reliable+Fast**] (Factory setting)
- [**Reliable**]
- [**Very reliable**] For very good repeatability of the measured results but prolongs the settling time.

Navigation: "**Weighing parameters** > **AutoZero**"

Factory setting: [**On**] **Note** This menu item is not available on certified instruments.

To select or de-select "**AutoZero**". The automatic zero point correction "**AutoZero**" continuously corrects any deviations from the zero point, which can be caused by slight contamination on the weighing pan.

6.3.2 Entering User Data

This menu can be used to define user names, select the display language and define user access codes.



- Touch "**User Setting**" > [**User**].
⇒ Window "**User**" opens.

Navigation: "**User** > **User Name**" > [**Define**]

Factory setting: "**User 1**" .. "**User 7**" and "**Home**"

The name of the current user profile can be changed here. Alphanumeric characters can be entered in the input window.
(max. 20 characters)

Note

If the user name you enter is already being used, an error message appears. After modification, the user profile appears under the new name in the top left of the display and in the profile menu. The user name is also printed in the records.

Note

For a intuitive differentiation of user profiles change for each User the backgroundcolor. **See** Terminal Settings (page 72)

Navigation: "User > Language" > [Define]

Factory setting: Generally, the language of the destination country is preset.

This menu is to select the display language. The language is switched immediately. All windows and messages appear in the selected language.

Exception: interface parameters in the system settings are always in English.

Attention

If the display language is changed, you may no longer be able to enter the access codes for the administrator and user (password and ID). This is why the ID and password must always be entered in the same language in which they were defined!

Navigation: "User > User ID or Password" > [Define]

Factory setting: For **User ID** and **Password** the same:

"Home" is "0"

"User 1" is "1"

"User 7" is "7"

The current user access codes can be changed in these two menus. These codes are required for accessing menu areas that have been protected at user level by the administrator (max. 20 characters each)

If you delete the existing ID or password and do not enter a new code, an error message appears.

Note

If access to both of these menus has been protected by the administrator, you must enter the current ID and password before you can change the codes.

6.3.3 Settings for the Side Doors



– Touch "**User Setting**" > [**Door**].

⇒ Window "**Door**" opens.

Navigation: "Door > Doorway"

For defining how wide the side doors will open. This shortens the opening and closing times, reducing environmental influences (e.g. drafts). This function will have no effect on the front door.

[100%] Side doors will open all the way. - (Factory setting)

[75%]

[50%]

[25%] Side doors will open only a quarter of the way.

Note

If the Auto Sampler is mounted and programmed, these settings do not have any effect. Also the keys **↑** do have a different function. **See** Basics of Auto Sampler (page 38)

6.3.4 Terminal Settings



- Touch "**User Setting**" > [**Terminal**].
⇒ Window "**Terminal**" opens.

Navigation: "**Terminal** > **Brightness**"

Factory setting: 80 %

To define the brightness of the display, alter the brightness between 20 % and 100 % (in steps of 20 %) using the arrow keys. The brightness is altered immediately.

Note

If the instrument has not been used for 15 minutes, the brightness of the display is reduced automatically. As soon as a key is pressed or the weight changes, the brightness is reset to the value selected.

Navigation: "**Terminal** > **Colour selection**"

Factory setting: Color palette 1 (blue with strong contrast).



strong

If you use different colors for different user profiles, you can see at a glance which profile is currently active.



soft

There are 8 color palettes. 4 different colors each with strong (left) or soft (right) contrast.

Note

The color palettes with strong contrast are better under poor light conditions.

Navigation: "**Terminal** > **Sound**" >

Factory setting: 70 %

Setting for the volume of the beep. Setting at 0 % switches the sound off. (range 0 % - 100 % in steps of 10 %).

Navigation: "**Terminal** > **Touch Function**"

Factory setting: "**On**"

To select or de-select "**Touch Function**".

Note

If you switch off, the display no longer responds to touch in dosing mode and you can therefore no longer make settings by the display (except for function keys). In the setting mode "**Touch Function**" is always selected, otherwise you would not be able to make settings.

Navigation: "**Terminal** > **Touchadjust**" > [**Activate**]

If you feel that the instrument is no longer reacting correctly when you touch a specific part of the display, use the "**Touchadjust**".

A window appears in which you touch the flashing area. This operation is repeated several times.

To abort the procedure at any time, touch [**C**].

Navigation: "**Terminal** > **Optical key feedback**"

Factory setting: "**On**"

To select or de-select "**Optical key feedback**".

Note

A short beep sounds to confirm each time a key is pressed or a menu function is carried out. To get an additional optical confirmation, you can select "**Optical key feedback**". If the function is selected the yellow LEDs at the bottom left and right of the status bar on the terminal light up briefly.

Navigation: "Terminal > Speedread"

Factory setting: "On"

To select or de-select "**Speedread**".

Note

When this function is selected, the current weight value is displayed in a lighter color while it is unstable. When the value becomes stable, it is displayed in a darker color. If the "**Speedread**" function is de-selected, the weight value is always displayed in the same color.

6.3.5 Resetting User Settings

To reset the settings of the active user profile back to factory settings.



- 1 Touch "**User Setting**" > [**User Reset**].
⇒ Window "**Activate factory settings?**" opens.
- 2 - To abort, touch [**C**].
- To reset the current settings, confirm with [**OK**].
⇒ The instrument restarts with the factory settings.

Attention

Consequently, all individual settings, including **User ID** and **Password**, has to be set anew.

6.4 System Settings







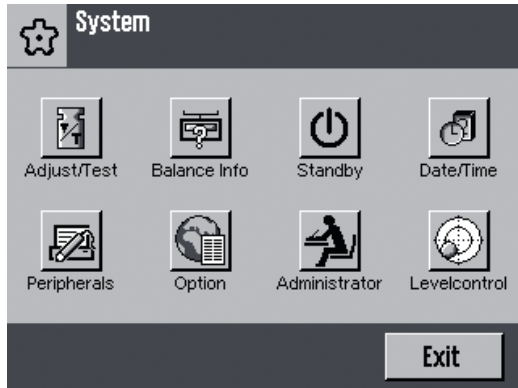

This chapter describes how to adapt the instrument to your requirements. The system settings apply to the entire dosing system while the application settings and the user settings allow the instrument and the dosing application to be adapted to the user's work technique and to specific tasks.

- To print any setting, press .

Overview

- To access the system settings, press  and then [**System**].
 - ⇒ Window "**System**" opens.



-  "**Adjust/Test**" To specify the settings for adjustment and test functions for verifying the adjustment. **See** Settings for Adjustment and Tests (page 75)
-  "**Balance Info**" To display the instrument information. **See** Instrument Information (page 78)
-  "**Standby**" To specify the settings for the "Standby" mode. **See** Standby (page 78)
-  "**Date/Time**" To entry date and time and select of display format. **See** Date and Time (page 79)
-  "**Peripherals**" To specify the interfaces for various peripheral devices. **See** Selecting Peripheral Devices (page 80)
-  "**Option**" This button appears only if special interface options (e.g. Ethernet) have been installed. To specify the global settings for these interfaces. **See** Establishing Global Settings for the Ethernet Interface (page 81)
-  "**Administrator**" To specify the security system of the instrument, including allocating access rights and passwords. Additionally this menu item allows you to reset the instrument to the factory settings. **See** Configuring the Security System (page 81)
Note: Access is protected ex works with an ID and a password.
-  "**Levelcontrol**" To specify the settings for the integrated level sensor. **See** Settings for the Level Sensor (page 83)

Note

Configuration work in the menus "**Peripherals**" and "**Option**" of the system settings requires some patience. Reason: for each setting the unit needs to access the respective interface which takes some time.

6.4.1 Settings for Adjustment and Tests

These menus can be used to define all settings related to the adjustment of your instrument. Information on all setting options for adjustment and test operations and for recording these operations can be found in the following chapters. **See** Adjusting the Instrument (page 36)



- Touch "**User Setting**" > "**System**" > [**Adjust/Test**].
⇒ Window "**Adjust/Test**" opens.

Navigation: "Adjust/Test"

"Adj. History"	see Displaying Recorded Adjustments (page 75)
"ProFACT"	see Fully Automatic Adjustment – ProFACT (page 76)
"Autom. ext. Adjust."	see Automatic Adjustment (page 76)
"Adjustweights"	see Defining Adjustment Weights (page 77)
"Autom. ext. Test"	see Automatic Adjustment Testing (page 77)
"Testweights"	see Defining Test Weights (page 78)
"Protocol"	see Defining Adjustment and Test Reports (page 78)

6.4.1.1 Displaying Recorded Adjustments

The instrument always records all adjustment operations that have been made and saves them in a memory protected against power failure. In this menu you can view a list of these operations, and define which type of adjustment operations the list should contain.

Note

If the memory is full, the oldest operation will be deleted. If your laboratory standards require full traceability of all adjustments made, print out and archive the list from time to time.
Memory max. 50 operations



- Touch "**Adjust/Test** > **Adj. History**" > [**Define**].
⇒ Window "**Adj. History**" opens.

Navigation: "Adj. History > Adj. History" > [Show]

A window appears with a list of the adjustments made. Although the instrument permanently records all adjustments made, the list only displays the type of operations that were selected for display in "**Selection**". Specific data is displayed for every adjustment operation (date and time, type of adjustment, temperature, leveling).

Navigation: "Adj. History > Selection" > [Define]

- "**Manual adjust.**"
- "**Temperature**"
- "**Time Adjust.**"

Factory setting: all selected

To define which types of adjustment operations should be displayed in the list. This means you can selectively shorten the list and therefore arrange it more clearly.

Note

The instrument records all adjustment operations. It simply uses the settings in this menu to determine the contents of the list.

Navigation: "Adjust/Test > Display Datasets"

Factory setting: [**Last 50**]

To specify how many of the most recently performed adjustment operations should be displayed in the list.

(max. 50 operations)

6.4.1.2 Fully Automatic Adjustment – ProFACT



– Touch "**Adjust/Test > ProFACT**" > [**Off**].

⇒ Window "**ProFACT**" opens.

Factory setting: [**On**]

To select or de-select "**ProFACT**". "**ProFACT**" (**Professional Fully Automatic Calibration Technology**) provides fully automatic instrument adjustment based on preselected time and/or temperature criteria.

Navigation: "ProFACT > ProFACT" > [Define]

To define the settings for fully automatic adjustment using the internal adjustment weight.

Navigation: "ProFACT > Weekdays" > [Define]

Factory setting: All days are selected



To define the days on which a fully automatic adjustment should be carried out.

Navigation: "ProFACT > Time 1"

Factory setting: "**Time 1**" is "9:00", "**Time 2**" is "**Off**", "**Time 3**" is "**Off**"

For the preselected days you can specify up to 3 times.

Navigation: "ProFACT > Temp.Criterion" >

Factory setting: [**2 Kelvin**]

To define which change in ambient temperature should trigger an automatic adjustment. If you select [**Off**], automatic adjustment based on a temperature criterion will not take place.

Navigation: "ProFACT > Protocol Trigger"

Factory setting: [**On**]

This setting specifies whether an adjustment report should be printed automatically. If you select [**Off**], automatic printouts will not be made.

6.4.1.3 Automatic Adjustment

Navigation: "Adjust/Test > Autom. ext. Adjust."

Factory setting: [**Off**]



If you are working with an external adjustment weight, this setting can be used to define the days and time when the instrument should provide an adjustment reminder.

The same setting options are available as for the time criterion of "**ProFACT**".

Exception: only one time per day is available.

6.4.1.4 Defining Adjustment Weights



- Touch "**Adjust/Test > Adjustweights**" > [**Define**].
⇒ Window "**Adjustweight 1**" opens.

If you are working with external adjustment weights, use this setting to define their properties. Up to 5 external adjustment weights. During the adjustment procedure, you will be able to select which of the defined weights you want to use to make the adjustment.

Navigation: "Adjustweights > Adjustweight 1" > [Define]

In this submenu you define the properties of as an example "**Adjustweight 1**".

Navigation: "Adjustweight 1 > Weight"

Factory setting: Model-dependent

To define the weight of the external adjustment weight. A numeric input window appears. Enter the weight of the external adjustment weight [g].

Navigation: "Adjustweight 1 > ID"

Factory setting: "**Adjustweight 1**" etc.

To assign an identification name to each external adjustment weight. This makes it easier to identify each of the adjustment weights. Alphanumeric characters can be entered in the input window.

recom. 15 characters (max. 20 characters)

Note

You can select the desired adjustment weight from a list that will appear during the adjustment procedure.

Navigation: "Adjustweight 1 > Certificate No."

Factory setting: No entry specified

To enter the identification or the number of the certificate that is supplied with each adjustment weight. This number identifies each external adjustment weight.

(max. 20 characters)

6.4.1.5 Automatic Adjustment Testing

Navigation: "Adjust/Test > Autom. ext. Test"



If you want to test the adjustments using an external test weight, select or de-select "**Autom. ext. Test**".

Factory setting: [**Off**]

Navigation: "Autom. ext. Test > On" > [Define]

To define the days and time when the instrument should provide a test reminder.

The same setting options are available as for the criterion of "**Autom. ext. Adjust.**".

6.4.1.6 Defining Test Weights

Navigation: "Adjust/Test > Testweights" > [Define]

If you are working with external weights for testing the adjustment, use this setting to define their properties. The same input windows and factory settings are available as for "Adjustweights".

Note

You can select the desired test weight for checking the adjustment from a list that will appear during the manual testing procedure. We recommend you to use an ID with max. 15 characters to be completely displayed in the list.

6.4.1.7 Defining Adjustment and Test Reports

Navigation: "Adjust/Test > Protocol" > [Define]

This two-page menu can be used to define which information is printed on the adjustment and test reports.

Page 1		Page 2	
"Date/Time"	"SW-Version"	"Temperature"	"Level control off"
"User"	"Balance ID"	"Nominal Weight"	"Signature"
"Balance Type"	"Weight ID"	"Actual Weight"	
"SNR"	"Certificate No."	"Difference"	

6.4.2 Instrument Information



- Touch "User Setting" > "System" > [Balance Info].
⇒ Window "Balance Info" opens.

Navigation: "Balance Info"

This menu can be used to define an identification for your instrument and to call up instrument information.

Navigation: "Balance Info > Balance ID"

Factory setting: Serial number of the instrument

To assign an identification to your instrument. This makes it easier to identify individual instruments in operations that use several instruments. This identification is also printed in the records. Alphanumeric characters can be entered in the input window.

(max. 20 characters)

Navigation: "Balance Info > Balance Info" > [Show]

A window appears with information on the instrument and the built-in options. This information is of particular importance for the service engineer. If you call the METTLER TOLEDO customer service department, you should have printed this information.

6.4.3 Standby



- Touch "User Setting" > "System" > [Standby].
⇒ Window "Standby" opens.

Navigation: "Standby" > [Standby]

Factory setting: [Off]

To define the length of time until the instrument enters the mode "**Standby**". "**Standby**" is the same state that the instrument enters if it is switched off using [**On/Off**].

You can de-select standby mode or define a time of 30, 60, 120 or 240 minutes.

Note

Regardless of the standby mode setting, the brightness of the display is automatically reduced if the instrument has not been used for several minutes.

- To switch the instrument on again, press [**On/Off**].

6.4.4 Date and Time



- Touch "**User Setting**" > "**System**" > [**Date/Time**].
⇒ Window "**Date/Time**" opens.

Navigation: "Date/Time"

To enter the date and time and select their display formats.

Navigation: "Date/Time > Date format"

Factory setting: [**D.MMM YYYY**]

To define the format in which the date should be displayed:

Format	Display example
[D.MMM YYYY]	29. May 2008
[MMM D YYYY]	May 29 2008
[DD.MM.YYYY]	29.05.2008
[MM/DD/YYYY]	05/29/2008

Navigation: "Date/Time > Date"

To set the current date. A numeric input window appears. Enter the current date in the format day - month - year (DD.MM.YYYY), regardless of which date format you have chosen for the display.

Note

The date can be set directly by touching it on the display. A window appears in which you can directly enter the date.

Navigation: "Date/Time > Time Format"

Factory setting: [**24:MM**]

To define the format in which the time should be displayed:

Format	Display example
[24:MM]	15:04
[12:MM]	3:04 PM
[24.MM]	15.04
[12.MM]	3.04 PM

Navigation: "Date/Time > Time"

To set the current time. Enter the current time in the 24-hour format (HH.MM.SS, the entry of seconds is optional), regardless of which time format you have chosen for the display. To enter the hours quickly touch [**+1H**] or [**-1H**]. So you can quickly switch between summer time and winter time.

Note

The time can also be set directly by touching it on the display.

6.4.5 Selecting Peripheral Devices

Various peripheral devices can be connected to the interfaces of your instrument. This menu can be used to define which devices are connected with which parameters of the interface.



- Touch "**User Setting**" > "**System**" > [**Peripherals**].
⇒ Window "**Peripherals**" opens.

Navigation: "Peripherals"

"Dosing unit" This designates the terminal of the instrument that is always connected to the built-in standard RS232C interface.
Example: [**RS232 built-in**]

The interface is reserved for the terminal of the instrument. The parameters of the built-in RS232C interface must stay with the factory settings. In some special cases this configuration may get lost and you have to re-establish it.

Factory setting: **See** Troubleshooting (page 89)

Note

This submenu will always be displayed in English, regardless of the display language you selected.

"Host" External computer (bidirectional communication; the instrument can send data to a PC and receive commands or data from a PC).
Example: Host is connected to the Ethernet interface.

The instrument is supplied with an Ethernet interface that connects to an external Ethernet-to-Serial converter. All peripherals (such as printers and Host computer) are connected to this converter and controlled via the Ethernet interface.

"Printer" Line printer from METTLER TOLEDO
Example: connected via adapter to Ethernet interface

Note

Before configuring the Ethernet interface (option) for the various peripherals make sure the global settings for the Ethernet interface have been properly set up. **See** Establishing Global Settings for the Ethernet Interface (page 81)

Note

This submenu will always be displayed in English, regardless of the display language you selected.

The settings required for the various peripherals:

Setting option	Host computer COM1	Label printer COM2	Printer COM3	Other serial device COM4
Communication Mode	Client & Server			
Remote Host Address	192.168.1.102			
Remote Host Port Number	8001	8002	8003	8004
Local Server Port Number	8001	8002	8003	8004
End of Line	<CR><LF>	<CR>	<CR><LF>	<CR><LF>

"Label Printer" Label printer from METTLER TOLEDO
Example: connected to Ethernet interface

"Secondary Display" Secondary display
Example: [**Off**] not connected

"Barcode" Bar code reader
Example: [**Off**] not connected

"Ext. Keyboard" PC keyboard
Example: [Off] not connected

6.4.6 Establishing Global Settings for the Ethernet Interface



- Touch "User Setting" > "System" > [Option].
⇒ Window "Global Settings" opens.

Most ethernet interface installations are carried out by METTLER TOLEDO service engineers on site (including Ethernet configuration). The interface comes with a separate manual. So this chapter describes just some basic information to help you in case of communication problems.

Navigation: "Global Settings"



Note

This menu will always be displayed in English, regardless of the display language you selected.

After having installed the Ethernet interface (which is usually done at the factory) you will notice the presence of an additional icon in the system settings. Via "Option" you can configure the global settings for the Ethernet interface.

Example

Page 1		Page 2	
"DHCP"	Off	"Domain Name Server"	
"IP-Adress"	192.168.1.101	"Hostname"	not available
"Subnet Mask"	255.255.255.0		
"Standard Gateway"	not available		

6.4.7 Configuring the Security System

This menu can be used to change the administrator ID and password, reset all instrument settings, allocate access rights for individual users and define specifications for recording security-related operations.

Attention

This menu is protected ex works with an ID and a password.



- 1 Touch "User Setting" > "System" > [Administrator].
⇒ Window "Protected Area: Enter Administrator ID." opens.
- 2 Enter your ID. Factory setting: "Z"
⇒ Window "Protected Area: Enter Admin. Password." opens.
- 3 Enter your password. Factory setting: "Z"
⇒ Window "Administrator" opens.

Attention

The ID and password must always be entered in the same language in which they were defined.

- If you change the display language, you may no longer be able to enter the access codes.
- If the instrument is controlled by the commands of an external host, the password protection will not function.

Navigation: "Administrator > Administrator ID" > [Define]

To change the "Administrator ID" and "Administrator Password".
(max. 20 characters each)

Note

Both an ID and a password must be defined. If you delete the existing entry and do not enter a new one, an error message appears.

Attention

If you forget one of the codes, it is not possible to regain access to the menu areas that are protected with these access codes. We recommend that you note down your ID and password and keep them in a safe place.

Navigation: "Administrator > Master Reset" > [Execute]

To reset all instrument settings to the factory settings.

Note

To reset all instrument setting means that the reset includes also these settings:

- individual settings
- system setting except recorded adjustments, date and time
- peripheral and interface options

Navigation: "Administrator > Home Rights ... User 7 Rights" > [Define]

Factory Setting

Page 1	selected	Page 2	selected
"Application Setup"	[No Protection]	"User ID/Password"	[No Protection]
"Weighing parameters"	[No Protection]	"System"	[No Protection]
"Adjustweight"	[No Protection]	"User Setting"	[No Protection]
"User"	[No Protection]		

The identifications of the user profiles for example "User 1" are set at the factory. You can change the identifications in the user-specific settings.

Access rights for all 8 user profiles can be defined in the "Home Rights" and "User 1 Rights ... User 7 Rights" menus. Each identification can be protected as follows:

"No Protection" The menu area is freely accessible.

"User Protect." A user ID and a user password must be entered to call up the relevant menu area.

Note

All menu areas that are protected with a user ID and password can be opened using the administrator access codes.

"Adm. Protect." An administrator ID and an administrator password must be entered to call up the relevant menu area.

Navigation: "Administrator > History" > [Define]

The instrument can document modifications to protected settings. A list of these operations can be viewed in the "Record" menu and recording can be switched on or off.

Note

If the memory is full (after approximately 50 recorded modifications), the oldest operation will be deleted automatically. Therefore, print out and archive the list from time to time if your laboratory standards or your QA system require full traceability of all modifications made.

"History" > [Show] Displays a list of the adjustments made to protected settings. Specific data is displayed for each modification. The list can be printed.

"Record Mode" To switch recording on or off.
Factory setting: [Off]

Navigation: "Administrator > Passw. Change Date"

Factory setting: [Off]

To define whether and when you want the instrument to remind you to change passwords.

Activating the reminder function

For security reasons, passwords should be changed regularly.

- 1 Select **"Request"** and then touch the relevant button.
⇒ A numeric input window appears.
- 2 Enter the date (DD.MM.YYYY) on which the instrument should remind you to change your password.
⇒ When the selected date is reached, a message appears.

Note

The administrator has to ensure that all passwords are changed and set a new reminder. The instrument does not check that they have been changed. If you confirm with [OK], it reappears every 3 hours until you set a new date or switch off the reminder function.

Navigation: "Administrator > Number of users" > [Define]

Factory Setting

all selected			
"User 1"	✓	...	✓
...	✓	"User 7"	✓

To specify which user profiles should be available by pressing . The user profile **"Home"** does not appear in this selection, since this profile cannot be de-selected.

6.4.8 Settings for the Level Sensor

In this menu you can select or de-select the level sensor, and define settings for the warning messages when incorrect leveling has been detected.



- Touch **"User Setting" > "System" > [Levelcontrol]**.
⇒ Window **"Levelcontrol"** opens.

Navigation: "Levelcontrol"

Factory setting [Levelcontrol]

To select or de-select the level sensor.

Note

The level sensor is connected to the backlighting of the level indicator located above the right-hand footscrew. When the level sensor is selected, the level indicator is lit up.

Navigation: "Levelcontrol > Levelcontrol" > [Define]



- **"Warning Text"**
- **"Warning Beep"**

Factory setting: [Once] for both

To specify whether and how often "**Warning Text**" or "**Warning Beep**" should occur when the instrument is not precisely leveled.

The following settings are available:

[**Off**] When the level is incorrect, only the status icon appears in the upper right-hand corner of the display. There is no warning text or beep.

Note

If you de-select the "**Warning Text**" you have to start the Leveling Assistant by touching the information field zone.

[**Once**] After the level sensor detects that the level is incorrect, the warning text and warning beep occur only one time.

[**Repeat**] As long as the instrument remains incorrectly leveled, the warning text and warning beep are repeated every 15 minutes.

7 Maintenance

7.1 Cleaning

Clean your instrument, e.g. the dosing chamber (including the drip pan), the housing, and the terminal using the brush supplied with it. The maintenance interval depends on your standard operating procedure (SOP).

Please observe the following notes



WARNING

Risk of electric shock

- The instrument must be disconnected from the power supply.
- Use only the power cable from METTLER TOLEDO, if it needs replacing.
- Ensure that no liquid comes into contact with the dosing unit, the terminal or the AC adapter.
- Never open the instrument housing, terminal or AC adapter – they contain no components, which can be cleaned, repaired or replaced by the user.



CAUTION

Damage of terminal

On no account use cleaning agents which contain solvents or abrasive ingredients, as this can result in damage to the terminal overlay.

Cleaning

Your instrument is made from high quality, resistant materials and can therefore be cleaned with a commercially available, mild cleaning agent.

- 1 To clean the dosing chamber thoroughly, fully open the side doors and the front door. **See** Glass Draft Shield (page 25)
- 2 Remove the dosing head.
- 3 Carefully raise the front of the weighing pan and lift it out of the guide.
- 4 Lift the front part of the drip pan (located below the weighing pan), then pull the pan away from the instrument.
- 5 Replace these parts and make sure they are in the correct position.

Cleaning the side windows

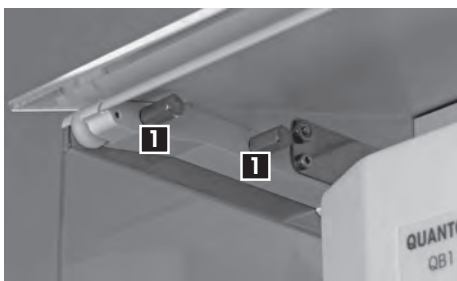

- 1 Unscrew both screws **1**. Both upper side windows are fastened with two screws that are accessible from the inside.
- 2 Remove the side window by carefully pulling it away from the instrument.
- 3 Clean the side windows.

Note

Please contact your METTLER TOLEDO dealer for details of the available service options. Regular servicing by an authorized service engineer ensures constant accuracy for years to come and prolongs the service life of your instrument.

7.2 Cleaning the Auto Sampler

Clean the Auto Sampler using the brush supplied with it. The maintenance interval depends on visible contamination or clean your instrument each time you change substances.



CAUTION

Trapping fingers

If the Auto Sampler is selected inadvertently while cleaning, your hand or fingers may get trapped between the drive ring and the gear.

- Disconnect the instrument from the power supply before carrying out any dismantling and cleaning work.

7.2.1 Quick Cleaning Procedure



▶ Auto Sampler is in "**Home**" position.

▶ Front door is open.

1 Remove the dosing head and the cover "**Home**" position.

2 Move both side doors back to the stop.

3 Unscrew the knurled screw **1** then lift and remove the cover **2**.

4 Remove the two magazines in the front.

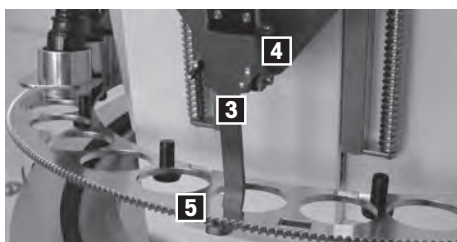

5 Attach the hook **3** to the dosing head support **4**.

6 Lift the drive ring **5** and attach it to the hook. If needed, lower the hook by turning the height adjustment handles.

7 Move the hook to the highest position by turning the height adjustment handles.

⇒ You have free access to the dosing chamber.

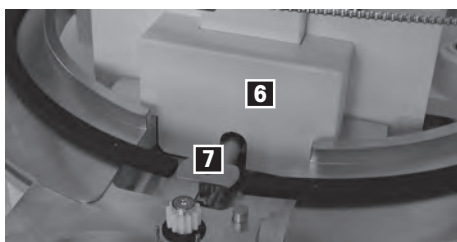

8 Remove the cover **6** and the weighing pan **7** by pulling it upwards.

9 Clean the space underneath the weighing pan.

7.2.2 In-depth Cleaning

For thorough cleaning you may remove further components of the Auto Sampler. Clean the parts with a mild household cleaning agent, as required.

Note

Do not use cleaning agents containing abrasive components.

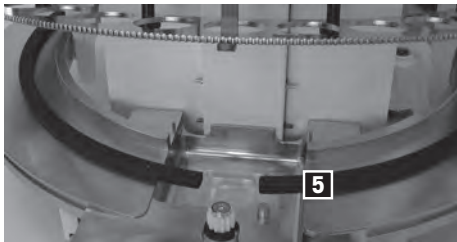
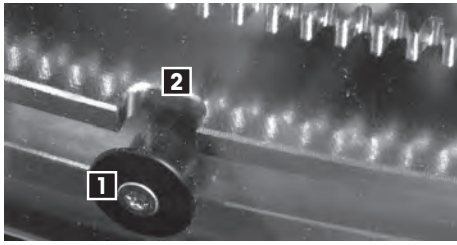

- 1 To clean the tunnels, grasp the required side door by the handle and move it back until the front and rear guide rollers of the tunnel **1** are located directly underneath the recess of the metal ring **2**.
- 2 Grasp the tunnel by the lower edge (near to the center guide roller), slightly pull the tunnel outwards and then lift it up until it comes off the guide.
- 3 Remove the other side tunnel also.
- 4 Remove the rear tunnel.
- 5 Clean the tunnels.
- 6 To clean the magazines, lift the 6 numbered magazines **3** and remove them from the drive ring **4**.
- 7 Remove the slide ring **5**.
- 8 Clean the magazines, the drive ring and the slide ring.

7.2.3 Check After Cleaning

After cleaning reinstall all items in reverse order to the dismantling procedure while observing the following:

- Make sure the **slide ring** properly fits all guiding pins and its lower side is absolutely flush with the supporting surface.
- When installing the **weighing pan** make sure it is correctly attached to the holding pins.
- When installing the **drive ring** make sure the teeth are correctly located in the gear. You may install the ring in any position as reconnecting the instrument to the power supply starts the Auto Sampler which then finds the "**Home**" position automatically.
- First start the Auto Sampler to find the "**Home**" position. Then install the **magazines** according to their numbering (position "1" is to the left of the dosing head).

7.3 Cleaning the Liquid Module

Your instrument is made from high quality, resistant materials and can therefore be cleaned with a commercially available, mild cleaning agent. If your flow rate is decreasing, clean your instrument.

- 1 Remove liquid bottle, bottle holder and drip pan.
- 2 Clean all items.
- 3 Reinstall all items.

Suction Filter

- 1 Check visually that the suction filter is clean once a week.
- 2 Change suction filter at least once a year. Maintenance interval depends on the liquid type used.

Purging the liquid dosing head



- ▶ Check that the liquid sample vessel is big enough for your "**Purge time [sec]**".
- 1 Touch [**Purge**].
- 2 Place sample vessel.
- 3 Confirm with [**OK**].
 - ⇒ "**Purge time [sec]**" opens.
- 4 Enter your time.
- 5 Confirm with [**OK**].
 - ⇒ Dosing head lowers.
 - ⇒ Pressure builds up.
 - ⇒ Instrument purges.

Cleaning the liquid dosing head

If purging is not enough, clean the liquid dosing head as follows.

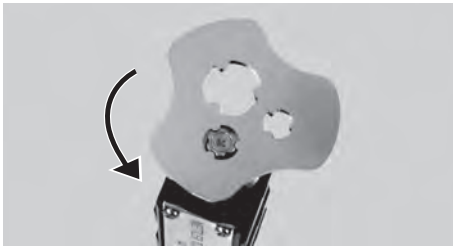

- 1 Open the head with the special bolt driver.
- 2 Take out the micro dispensing valve and clean it, e.g. in an ultrasonic bath.
- 3 After the cleaning reinstall the micro dispensing valve.

7.4 Disposal

In conformance with the European Directive 2002/96/EC on Waste Electrical and Electronic Equipment (WEEE) this device may not be disposed of in domestic waste. This also applies to countries outside the EU, per their specific requirements.

Please dispose of this product in accordance with local regulations at the collecting point specified for electrical and electronic equipment. If you have any questions, please contact the responsible authority or the distributor from which you purchased this device. Should this device be passed on to other parties (for private or professional use), the content of this regulation must also be related.

Thank you for your contribution to environmental protection.



8 Troubleshooting

8.1 Error Messages

Error messages in the display draw your attention to incorrect operation or that the balance could not execute a procedure properly. The instructions are based on the assumption that you work with a non-hazardous substance.









CAUTION — Fire or Explosion

- Flammable or explosive substances.
 - Substances containing solvents.
1. In cases of doubt, perform a careful risk analysis.
 2. Working temperature that is low enough to prevent the formation of flames or an explosion.
 3. Wear protective glasses.



Numbered

Error Message	Problem	Solution												
 "Timeout See manual (Troubleshooting) No. 0"	Communication: <ul style="list-style-type: none"> • Interfaces in general 	<ol style="list-style-type: none"> 1 Check the wiring between the balance and the dosing unit. 2 Check the wiring between the instrument and the terminal. 3 Check the wiring between the instrument and the peripheral device. 4 Check the factory setting of "System" > [Peripherals] > "Dosing unit" 												
	Factory Setting of "Dosing unit" :													
	<table border="1"> <tr> <td>"Baudrate"</td> <td>9600</td> </tr> <tr> <td>"Bit/Parity"</td> <td>8/No</td> </tr> <tr> <td>"Stop Bits"</td> <td>1 Stopbit</td> </tr> <tr> <td>"Handshake"</td> <td>Xon/Xoff</td> </tr> <tr> <td>"End of Line"</td> <td><CR><LF></td> </tr> <tr> <td>"Char.Set"</td> <td>Ansi/Win</td> </tr> </table>		"Baudrate"	9600	"Bit/Parity"	8/No	"Stop Bits"	1 Stopbit	"Handshake"	Xon/Xoff	"End of Line"	<CR><LF>	"Char.Set"	Ansi/Win
	"Baudrate"	9600												
"Bit/Parity"	8/No													
"Stop Bits"	1 Stopbit													
"Handshake"	Xon/Xoff													
"End of Line"	<CR><LF>													
"Char.Set"	Ansi/Win													
<ul style="list-style-type: none"> • Auto Sampler 	– Check the wiring between the instrument and the Auto Sampler.													
<ul style="list-style-type: none"> • Liquid module 	– Check the wiring between the instrument and the liquid module.													

Error Message	Problem	Solution
 <p>"Dosing head actuator blocked See manual (Troubleshooting) No. 2" " ... 3" " ... 4" " ... 5"</p>	<p>Dosing head has become clogged . or Blocked mechanism</p>	<ol style="list-style-type: none"> 1 Check dosing head, that screw is rotatable. 2 Remove the dosing head and tap it manually. 3 Try different settings for your powder: "Application Setup > Algo" or "Application Setup > Tapper" 4 Take new dosing head or refill container. If the error occurs with a certain powder more than 2 times, the powder might be not applicable. 5 Check the system with the dosing head for powder test. 6 Contact your local METTLER TOLEDO service engineer.
 <p>"Front door Timeout See manual (Troubleshooting) No. 7"</p>	<p>Door can't be closed.</p>	<p>– Check that no obstacle stands before the instrument.</p>
	<p>Door not correctly adjusted.</p>	<p>– Check the settings for "Application Setup > Maintenance > Front door"</p>
	<p>Connection interrupted.</p>	<p>– Contact your local METTLER TOLEDO service engineer.</p>
 <p>"Auto sampler Error See manual (Troubleshooting) No. 8"</p>	<p>Blocked Auto Sampler</p>	<ol style="list-style-type: none"> 1 Check that no obstacle is there. 2 Check weighing pan is mounted properly. 3 Check the proper fit of the magazines.
	<p>Connection interrupted.</p>	<p>– Check carefully the wiring.</p>
 <p>"Leakage in air system See manual (Troubleshooting) No. 13"</p>	<p>Building up pressure takes too long.</p>	<ol style="list-style-type: none"> 1 Check that no loose tube exists. Each tube has to be connected either to a bottle or to the instrument. 2 Check tight fit of the cap and the bottle-neck is not broken . 3 Check proper fit of air tube fitting of the bottle and of the pump. 4 Check tight fit of the micro dispensing valve.
 <p>"No pressure release See manual (Troubleshooting) No. 16"</p>	<p>Bleeding valve blocked</p>	<ol style="list-style-type: none"> 1 Release pressure. For Quantos liquid module see Releasing Pressure (page 45) For liquid module upgrade of an excellence balance see Releasing Pressure (page 50) 2 Contact your local METTLER TOLEDO service engineer.

Error Message	Problem	Solution
 <p>"SafePos Error See manual (Troubleshooting) No. 27"</p>	Dosing head is too low for higher sample vessel.	<ol style="list-style-type: none"> 1 Adjust the position with the head height adjustment handle. 2 Tap function key [Setup] > [Start adjustments]. 3 Follow the instructions.

Instrument hardware

Error Message	Problem	Solution
 <p>"Timeout Weight Unstable"</p>	Too much vibration	– Check everything that might cause this vibration, e.g. leaning on the table.
	Open Draft shield	– Close the side doors and front door.
	Removed front door	– Reinstall the front door and close it.
 <p>"Message(s) Head dosage limit reached Please press Cancel to stop"</p>	"Dose limit" reached.	<ol style="list-style-type: none"> 1 Confirm with [C]. 2 Touch [Info head]. 3 Check "Dose limit" with "Rem. dosages". 4 Check the dosing head and change dosing head if necessary.
 <p>"Wrong head type mounted!"</p>	Wrong type of dosing for the mounted head	<ol style="list-style-type: none"> 1 Check that the head is installed properly. 2 - If you mounted the liquid dosing head, choose [Start] > [Solution] or [Liquid dosing]. - If you mounted the powder dosing head, choose [Start] > [Solid dosing] or [Solution].
--no message--	If the instrument hangs on start-up or an error message appears indicating a balance type mismatch.	<ol style="list-style-type: none"> 1 Switch off the high-voltage power adapter of the AntiStatic Kit. 2 After successful startup switch the power adapter on again.





Liquid Module

Error Message	Problem	Solution
 <p>"Liquid flow too low"</p>	Not enough liquid left in the bottle.	– Refill the bottle. See Handling of Bottle (page 46)
	Not enough liquid for dosing.	<ol style="list-style-type: none"> 1 Check for leakages. 2 Check that liquid dosing head is clean. 3 Clean it for example by purging. See Cleaning the Liquid Module (page 87)
--no message--	Dripping on the lid.	– Change PEEK nut. See Basic Operation Settings (page 47)
--no message--	Dripping of the liquid dosing head.	<ol style="list-style-type: none"> 1 Check cap. 2 If there is too much air in tubing, check air connector module.



Error Message	Problem	Solution
--no message--	No dosing	<ol style="list-style-type: none"> 1 Check filter. 2 Check that dosing head is engaged. If there is just a small gap between dosing head and its support, touch it down again. 3 Check that head is installed properly.

Substance

In most cases problems related to the substance occur if a particular limit has been reached:

Error Message	Problem	Solution
 "Powder flow too low"	<p>Dosing head ran out of powder while dosing.</p> <p>Dosing head has become clogged.</p>	<ul style="list-style-type: none"> – Check the quantity of powder remaining, possibly. – Tap the container on a table.
 "Message(s) Expiry date reached Please press Cancel to stop"	<p>Substance has expired, i.e. the expiry date entered has expired.</p>	<ol style="list-style-type: none"> 1 Replace the substance. 2 To prevent contamination, install and set up a new dosing head.
 "Message(s) Remaining quantity too low Please press Continue to proceed or Cancel to stop"	<p>Quantity of powder is insufficient for the next dosing cycle.</p> <p>On the initial filling you entered the quantity. After each dosing cycle the respective quantity is subtracted from this value.</p>	<ul style="list-style-type: none"> – Abort [C] or continue [Continue] the current dosing. <p>Note If you continue dosing you should be aware that the target weight may not be reached.</p>
 "Message(s) Retest date reached Please press Continue to proceed or Cancel to stop"	<p>Substance needs to be retested, i.e. the retest date you entered has been reached.</p>	<ol style="list-style-type: none"> 1 Abort the current dosing. 2 Check the substance. 3 Enter a new retest date. <p>⇒ If you continue dosing instead, the message will re-appear upon every subsequent dosing.</p>

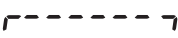
Exceeding limits

Error Message	Problem	Solution
	<p>Overload - The weight on the pan exceeds the weighing capacity.</p>	<ul style="list-style-type: none"> – Reduce the weight on the weighing pan.
	<p>Underload</p>	<ul style="list-style-type: none"> – Check that the weighing pan is positioned correctly.
	<p>Instrument is switched on or upon zeroing, one or more limits were exceeded.</p> <p>Instrument is switched on and a weight is on the weighing pan .</p>	<ul style="list-style-type: none"> – Remove the weight.

Error Message	Problem	Solution
"Timeout"	Taring or zeroing was aborted because a stable result was not received.	<ol style="list-style-type: none"> 1 Close the doors of the draft shield and check the working location (vibrations, drafts). 2 Touch [OK]. 3 Repeat your procedure.









Interfaces

Communication problems are often due to faulty wiring or erroneous interface settings. In case of problems please try the following:

Error Behavior	Problem with	Solution
<ul style="list-style-type: none"> • No display 	Power	– Check the wiring.
<ul style="list-style-type: none"> • No printing • No XML transfer 	Ethernet interface	<ol style="list-style-type: none"> 1 Shut down the instrument. 2 Disconnect the instrument and the Ethernet-to-Serial converter from their power supplies. 3 Reconnect the Ethernet-to-Serial converter to the power supply. 4 Wait about 40 seconds and reconnect the instrument to the power supply. 5 Start up the instrument. 6 Check the global Ethernet settings as well as the settings for the peripherals. See Selecting Peripheral Devices (page 80) and Establishing Global Settings for the Ethernet Interface (page 81) 7 If the problem persists, contact your local METTLER TOLEDO service engineer.

8.2 Status Icons

	Cause	Rectification
	<p>The AntiStatic Kit is active, i.e. ionizing is on.</p> <p>This just indicates that the Antistatic Kit is selected, it does not confirm that the AntiStatic Kit is powered up and fully functional.</p>	<ul style="list-style-type: none"> ▶ The transformer of the AntiStatic Kit is connected to the power supply and switched on. – Upon zeroing, taring, dosing and adjusting the instrument, ionizing is turned off and the status icon disappears as ionizing could interfere with these operations. To turn ionizing on again, install a dosing head or touch [Start]. <p>Note If the instrument is not used for 10 minutes the AntiStatic Kit will be disabled automatically. The icon disappears.</p>

- | | |
|--|---|
|  <p>Automatic "ProFACT" adjustment is not possible because another operating sequence is running.</p> | <ol style="list-style-type: none"> 1 Unload the instrument. 2 Don't touch any key for 2 minutes. The display becomes stable. <ul style="list-style-type: none"> ⇒ If the adjustment is successfully completed, the icon disappears. |
|  <p>You have specified in the system settings that the instrument should automatically request an adjustment using an external weight.</p> | <ul style="list-style-type: none"> – Start the adjustment. <ul style="list-style-type: none"> ⇒ If the adjustment is successfully completed or if you confirm not to adjust, the icon disappears. |
|  <p>You have specified in the system settings that the instrument should automatically request adjustment testing using an external weight.</p> | <ul style="list-style-type: none"> – Start the test. <ul style="list-style-type: none"> ⇒ If the test is successfully completed or if you confirm not to test, the icon disappears. |
|  <p>The function "MinWeigh" is active. This indicates that the minimum weigh-in value for the current tare has not been reached yet.</p> | <ul style="list-style-type: none"> – Reach the minimum weigh-in value. <ul style="list-style-type: none"> ⇒ The icon disappears. |
|  <p>It is time for the next scheduled test of the function "MinWeigh".</p> | <ul style="list-style-type: none"> – Contact your dealer's customer service department as soon as possible. <ul style="list-style-type: none"> ⇒ A service engineer will run the test. |
|  <p>The battery in your instrument must be replaced. This battery ensures that the date and time are not lost when the instrument is disconnected from the power supply.</p> | <ul style="list-style-type: none"> – Contact your dealer's customer service department as soon as possible. <ul style="list-style-type: none"> ⇒ A service engineer will change the battery. |
|  <p>Your instrument is due for a service.</p> | <ul style="list-style-type: none"> – Contact your dealer's customer service department as soon as possible. <ul style="list-style-type: none"> ⇒ A service engineer will service your instrument. |
|  <p>The built-in level indicator has determined that the instrument is not correctly leveled.</p> | <ul style="list-style-type: none"> – Level the instrument immediately. <ul style="list-style-type: none"> ⇒ If the instrument is leveled correctly, the icon disappears. |

8.3 Fault Prevention

The following information helps avoiding potential problems with your instrument.

8.3.1 Storage of Dosing Heads and Powder

Protect your dosing heads by storing them in the delivered plastic container. This prevents the powder from absorbing too much humidity.

In case of long-term storage:

- Check the instructions for storing a particular powder.
- Shake the dosing head so that the powder flows back to the powder container.
- Remove the powder container from the head and screw on the supplied spare cap.

8.3.2 Target Quantities and Tolerances

Input range

Target quantity (Tolerance): 0.1 mg (+/-40 %) ... 220 g (+/-0.1 %)

Example:

- Target quantity = 50 mg
- Tolerance = 1 %
- Repeatability of powder dosing¹⁾ = 0.5 mg

¹⁾ depending on powder characteristics, in this example an average limit

If you dose samples with a smaller target quantity than 50 mg, increase the tolerance to achieve valid results.

Example of calcium carbonate powder

Target quantity [mg]	Tolerance +/- [%]
50.0	1
25.0	2
10.0	5
5.0	10
2.5	20
1.0	40

8.3.3 Preventing Electrostatic Charge

When preparing sample containers electrostatic charge may build up. Electrostatic charge may make correct dosing impossible or adversely affect the dosing result.

Possibilities for electrostatic charge:

- sample container made of plastic
- wearing latex gloves

The instrument is equipped with two ionizing electrodes (AntiStatic Kit) which are activated automatically when installing a new dosing head or touching [**Start**]. The two electrodes remove most of the electrostatic charge from your sample containers.

Always make sure to install a dosing head before locating the sample container on the weighing pan. This way, ionizing is active when placing the container which constantly removes the electrostatic charge. In addition, we recommend you do not touch the upper edge of the container (close to the opening) when handling the vessel.

Checking the container of electrostatic charge

- 1 Install the dosing head.
⇒ The AntiStatic Kit is active.
- 2 Locate the sample container on the weighing pan.
- 3 Check that the distance between the dosing head and the container is at least 5 cm and the opening of the container is aligned with the dosing head exactly.
- 4 Close all doors of the draft shield.
- 5 Press →**T**← to reset the display to zero, this switches the AntiStatic Kit off.
- 6 Slowly lower the dosing head to about 3 mm above the container and simultaneously watch the weight display.
⇒ If the displayed value remains stable (almost "0"), there is no electrostatic charge on the sample container.

Discharging the container

- 1 Install a dosing head or touch [**Start**].
 - ⇒ The AntiStatic Kit is active.
- 2 Grasp the sample container by its lower part and locate its upper edge in front of one of the two electrodes at a distance of about 50 mm for approximately 20 to 40 seconds.
Repeat this procedure as needed.
- 3 Relocate the container on the weighing pan not touching its upper part.

If your powder container is made of plastic material it may be impossible to completely remove electrostatic charge and the displayed value fluctuates.

- If the opening of the sample container is large enough, increase the distance between the dosing head and the container to more than 3 mm until the weight value in the displayed value remains stable.

9 Technical Data

9.1 General Data



CAUTION

Use only with a tested AC Adapter with SELV output current.
Ensure correct polarity

Power Supply

AC/DC Adapter:	Primary: 100-240 VAC, -15%/+10%, 50/60 Hz, 0.8 A Secondary: 12 VDC \pm 5%, 2.25 A (with electronic overload protection)
Balance:	Power supply to the balance: 12 VDC, 2.25 A max. 27 W
Power cable:	Design: 3-core, with country-specific plug

Protection and Standards

• Overvoltage category:	Class II
• Degree of pollution:	2
• Degree of protection:	Protected against dust and water
• Standards for safety and EMC:	See Declaration of Conformity
• Range of application:	For use only in dry interior rooms

Environmental conditions

• Height above mean sea level:	up to 4000 m
• Ambient temperature range:	5 to 40 °C
• Relative air humidity:	max. 80 % at 31 °C, linearly decreasing to 50 % at 40 °C, noncondensing

9.2 Explanatory Notes for the METTLER TOLEDO AC Adapter

The certified external power supply which conforms to the requirements for Class II double insulated equipment is not provided with a protective earth connection but with a functional earth connection for EMC purposes. This earth connection IS NOT a safety feature. Further information about conformance of our products can be found in the brochure "Declaration of Conformity" which is coming with each product.

In case of testing with regard to the European Directive 2001/95/EC the power supply and the instrument have to be handled as Class II double insulated equipment.

Consequently an earth bonding test is not required. Similarly it is not necessary to carry out an earth bonding test between the supply earth conductor and any exposed metalwork on the instrument.

Because the instruments are sensitive to static charges a leakage resistor, typically 10 k Ω , is connected between the earth connector and the power supply output terminals. The arrangement is shown in the equivalent circuit diagram. This resistor is not part of the electrical safety arrangement and does not require testing at regular intervals.

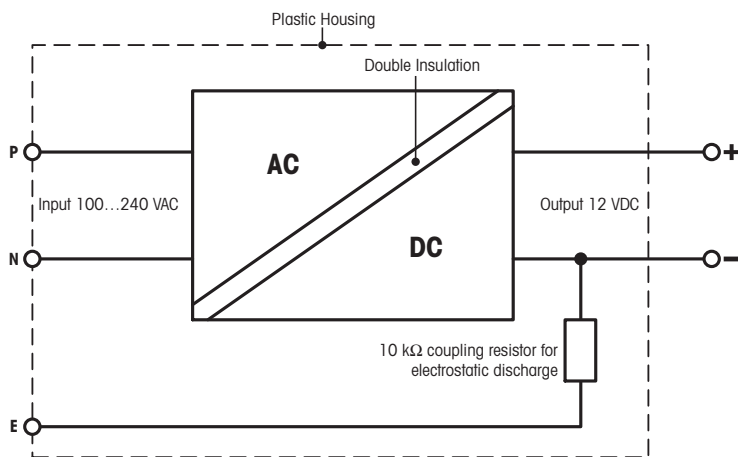

Equivalent circuit diagram

9.3 Model-Specific Data

Technical Data of Instrument

Quantos		QA1/QB1 (QD204)	QA3/QB3 (QD205 DR)
Limit values¹⁾			
Maximum capacity		220 g	220 g
Readability		0.1 mg	0.1 mg
Tare range (from ... to)		0 ... 220 g	0 ... 220 g
Maximum capacity, fine range		–	81 g
Readability, fine range		–	0.01 mg
Repeatability (at nominal load)	sd	0.07 mg (200 g)	0.06 mg (200 g)
Repeatability (at low load)	sd	0.05 mg (10 g)	0.05 mg (10 g)
Repeatability, fine range (at low load)	sd	–	0.015 mg (10 g)
Repeatability, fine range automated operation (at low load)	sd	–	0.015 mg (10 g)
Linearity deviation		0.2 mg	0.15 mg
Eccentricity deviation (test load)		0.25 mg (100 g)	0.25 mg (100 g)
Sensitivity offset (test weight) ²⁾		0.6 mg (200 g)	0.5 mg (200 g)
Sensitivity temperature drift		0.0001%/°C	0.0001%/°C
Sensitivity stability		0.0001%/a	0.0001%/a
Typical values			
Repeatability ³⁾	sd	0.04 mg	0.04 mg
Readability, fine range	sd	–	0.007 mg
Repeatability, automated operation, fine range	sd	0.04 mg	0.005 mg
Linearity deviation		0.13 mg	0.1 mg
Eccentricity deviation (test load)		0.12 mg (100 g)	0.1 mg (100 g)
Sensitivity offset (test weight) ²⁾		0.4 mg (200 g)	0.32 mg (200 g)
Minimum sample weight (acc. to USP) ³⁾		120 mg	120 mg
Minimum sample weight (acc. to USP), fine range ^{3) 4)}		–	21 mg
Minimum sample weight (acc. to USP), automated operation, fine range ^{3) 4)}		120 mg	15 mg
Minimum sample weight (U=1%, k=2) ³⁾		8 mg	8 mg
Minimum sample weight (U=1%, k=2), fine range ^{3) 4)}		–	1.4 mg
Minimum sample weight (U=1%, k=2), fine range ^{3) 4)} automated operation		8 mg	1 mg
Typical uncertainties and supplementary data			
Repeatability ³⁾	sd	0.04 mg + 0.000005%•R _{gr}	0.04 mg + 0.000005%•R _{gr}
Repeatability, fine range	sd	–	0.007 mg + 0.000012%•R _{gr}
Repeatability, automated operation, fine range	sd	0.04 mg + 0.000005%•R _{gr}	0.005 mg + 0.0000065%•R _{gr}
Differential linearity deviation	sd	$\sqrt{(20\text{pg}\cdot R_{nt})}$	$\sqrt{(12\text{pg}\cdot R_{nt})}$
Differential eccentric load deviation	sd	0.00006%•R _{nt}	0.00005%•R _{nt}
Sensitivity offset ²⁾	sd	0.0001%•R _{nt}	0.00008%•R _{nt}

Quantos	QA1/QB1 (QD204)	QA3/QB3 (QD205 DR)
Minimum sample weight (acc. to USP) ³⁾	120 mg + 0.015%•R _{gr}	120 mg + 0.015%•R _{gr}
Minimum sample weight (acc. to USP), fine range ^{3) 4)}	–	21 mg + 0.036%•R _{gr}
Minimum sample weight (acc. to USP), automated operation, fine range ^{3) 4)}	120 mg + 0.015%•R _{gr}	15 mg + 0.0195%•R _{gr}
Minimum sample weight (U=1%, k=2) ³⁾	8 mg + 0.001%•R _{gr}	8 mg + 0.001%•R _{gr}
Minimum sample weight (U=1%, k=2), fine range ^{3) 4)}	–	1.4 mg + 0.0024%•R _{gr}
Minimum sample weight (U=1%, k=2), automated operation, fine range ^{3) 4)}	8 mg + 0.001%•R _{gr}	1 mg + 0.0013%•R _{gr}
Weighing time	4 s	4 s
Weighing time, fine range	–	6 s
Interface update range	23/s	23/s
Number of built-in reference weights	2	2

¹⁾ Measured at 10...30 °C; 20...80 %rH

³⁾ Valid for compact objects

²⁾ After adjustment with built-in reference weight

⁴⁾ On DeltaRange models: Fine range starts at zero gross load

sd = Standard deviation

R_{gr} = Gross weight

a = Year (annum)

R_{nt} = Net weight (sample weight)

+

Technical Data of Instrument

Quantos	QB5... (QD206 DR)	QB7... (QD56)
Limit values¹⁾		
Maximum capacity	220 g	52 g
Readability	0.01 mg	0.001 mg
Tare range (from ... to)	0 ... 220 g	0 ... 52 g
Maximum capacity, fine range	81 g	–
Readability, fine range	0.005 mg	–
Repeatability (at nominal load)	sd 0.03 mg (200 g)	0.007 mg (50 g)
Repeatability (at low load)	sd 0.015 mg (10 g)	0.0030 mg (1 g)
Repeatability, fine range (at low load)	sd 0.015 mg (10 g)	–
Repeatability, fine range automated operation (at low load)	sd 0.005 mg (10 g)	–
Linearity deviation	0.1 mg	0.02 mg
Eccentricity deviation (test load)	0.2 mg (100 g)	0.03 mg (20 g)
Sensitivity offset (test weight) ²⁾	0.4 mg (200 g)	0.125 mg (50 g)
Sensitivity temperature drift	0.0001%/°C	0.0001%/°C
Sensitivity stability	0.0001%/a	0.0001%/a
Typical values		
Repeatability ³⁾	sd 0.007 mg	0.0026 mg
Readability, fine range	sd 0.007 mg	–
Repeatability, automated operation, fine range	sd 0.003 mg	0.0013 mg

Quantos		QB5... (QD206 DR)	QB7... (QD56)
Linearity deviation		0.065 mg	0.01 mg
Eccentricity deviation (test load)		0.1 mg (100 g)	0.012 mg (20 g)
Sensitivity offset (test weight) ²⁾		0.2 mg (200 g)	0.06 mg (50 g)
Minimum sample weight (acc. to USP) ³⁾		21 mg	8 mg
Minimum sample weight (acc. to USP), fine range ^{3) 4)}		21 mg	–
Minimum sample weight (acc. to USP), automated operation, fine range ^{3) 4)}		9 mg	4 mg
Minimum sample weight (U=1%, k=2) ³⁾		1.4 mg	0.52 mg
Minimum sample weight (U=1%, k=2), fine range ^{3) 4)}		1.4 mg	–
Minimum sample weight (U=1%, k=2), automated operation, fine range ^{3) 4)}		0.6 mg	0.27 mg
Typical uncertainties and supplementary data			
Repeatability ³⁾	sd	0.007 mg + 0.000006%•R _{gr}	0.0026 mg + 0.0000028%•R _{gr}
Repeatability, fine range	sd	0.007 mg + 0.000006%•R _{gr}	–
Repeatability, automated operation, fine range	sd	0.003 mg + 0.000006%•R _{gr}	0.0013 mg + 0.0000028%•R _{gr}
Differential linearity deviation	sd	$\sqrt{(5pg \cdot R_{nt})}$	$\sqrt{(0.5pg \cdot R_{nt})}$
Differential eccentric load deviation	sd	0.00005%•R _{nt}	0.00003%•R _{nt}
Sensitivity offset ²⁾	sd	0.00005%•R _{nt}	0.00006%•R _{nt}
Minimum sample weight (acc. to USP) ³⁾		21 mg + 0.018%•R _{gr}	8 mg + 0.0084%•R _{gr}
Minimum sample weight (acc. to USP), fine range ^{3) 4)}		21 mg + 0.018%•R _{gr}	–
Minimum sample weight (acc. to USP), automated operation, fine range ^{3) 4)}		9 mg + 0.018%•R _{gr}	4 mg + 0.018%•R _{gr}
Minimum sample weight (U=1%, k=2) ³⁾		1.4 mg + 0.0012%•R _{gr}	0.52 mg + 0.00056%•R _{gr}
Minimum sample weight (U=1%, k=2), fine range ^{3) 4)}		1.4 mg + 0.0012%•R _{gr}	–
Minimum sample weight (U=1%, k=2), automated operation, fine range ^{3) 4)}		0.6 mg + 0.0012%•R _{gr}	0.26 mg + 0.0000028%•R _{gr}
Weighing time		6 s	18 s / 10 s (automated)
Weighing time, fine range		10 s	–
Interface update range		23/s	23/s
Number of built-in reference weights		2	2

¹⁾ Measured at 10...30 °C; 20...80 %rH

²⁾ After adjustment with built-in reference weight

sd = Standard deviation

a = Year (annum)

³⁾ Valid for compact objects

⁴⁾ On DeltaRange models: Fine range starts at zero gross load

R_{gr} = Gross weight

R_{nt} = Net weight (sample weight)

Dosing Head	QH016-BNMW	QH120-LNMW	QH120-LNLW
Nominal values			
Powder container adapter	Thread DIN 18 mm	Thread DIN 27 mm	Thread DIN 27 mm
Dosing head contents	--	--	
Minimum dosing quantity	0.1 mg	0.1 mg	0.1 mg
Number of dosings (recommended)	250	250	250
Volume	16 ml	120 ml	120 ml
Target range	0.1 ...250 mg	0.1 ...250 mg	250 ... 5000 mg
Dosing properties			
Limit values			
Dosing quantity offset (powder; quantity; tolerance)	0.5 mg (CaCO ₃ ; 50 mg; 1%) ¹⁾	0.5 mg (CaCO ₃ ; 50 mg; 1%) ¹⁾	2.5 mg (CaCO ₃ ; 500 mg; 1%) ¹⁾
Dosing quantity Repeatability (sd) (powder; quantity; tolerance)	1 mg (CaCO ₃ ; 50 mg; 1%) ¹⁾	1 mg (CaCO ₃ ; 50 mg; 1%) ¹⁾	5 mg (CaCO ₃ ; 500 mg; 1%) ¹⁾
Dosing time (powder; quantity; tolerance)	90 s (CaCO ₃ ; 50 mg; 1%) ¹⁾	90 s (CaCO ₃ ; 50 mg; 1%) ¹⁾	90 s (CaCO ₃ ; 500 mg; 1%) ¹⁾
Typical values			
Dosing quantity offset (powder; quantity; tolerance)	0.2 mg (CaCO ₃ ; 50 mg; 1%) ¹⁾	0.2 mg (CaCO ₃ ; 50 mg; 1%) ¹⁾	0.5 mg (CaCO ₃ ; 500 mg; 1%) ¹⁾
Dosing quantity Repeatability (sd) (powder; quantity; tolerance)	0.2 mg (CaCO ₃ ; 50 mg; 1%) ¹⁾	0.2 mg (CaCO ₃ ; 50 mg; 1%) ¹⁾	1 mg (CaCO ₃ ; 500 mg; 1%) ¹⁾
Dosing time (powder; quantity; tolerance)	40 s (CaCO ₃ ; 50 mg; 1%) ¹⁾	40 s (CaCO ₃ ; 50 mg; 1%) ¹⁾	60 s (CaCO ₃ ; 500 mg; 1%) ¹⁾

¹⁾ Calcium carbonate: Sigma-Aldrich 21061

sd = Standard deviation

Liquid Module

Tested solvents:

1,4-dioxane, 1-butanol, acetic acid, acetone, acetonitrile, benzene, chloroform, dichloromethane, ethanol, ethyl acetate, formic acid 98 %, hexane, isopropanol, methanol, pentane, toluene, water (H₂O)

Dosing Head	QL001
Dosing properties	
Limit values	
Dosing quantity offset (liquid; quantity)	20 mg (H ₂ O; 5 g)
Dosing quantity Repeatability (sd) (liquid; quantity)	10 mg (H ₂ O; 5 g)
Dosing time (liquid; quantity)	35 s (H ₂ O; 5 g)
Typical values	
Dosing quantity offset (liquid; quantity)	1 mg (H ₂ O; 5 g)
Dosing quantity Repeatability (sd) (liquid; quantity)	1 mg (H ₂ O; 5 g)
Dosing time (liquid; quantity)	30 s (H ₂ O; 5 g)

Tubing	Outer Diameter	Inner Diameter	Length
Liquid dosing head > Cap	3.2 mm	1.6 mm	700 mm
Inside the bottle			220 mm
Pump module > Bottle	4.0 mm	2.4 mm	660 mm

Inline Frit Filter	
Tubing Outer Diameter	3.2 mm

Inline Frit Filter	
Filter pore size	10 µm

Materials: Wetted parts

	Bottle	Inline Frit Filter	Liquid bottle cap	Tubing	Body of dosing head	Micro dispensing valve	O-ring
Borosilicate glass	X						
PP		X	X				
PE			X				
FEP				X			
Stainless steel					X	X	
PEEK						X	
Sapphire						X	
Ruby						X	
FFMK (DuPont™ Kalrez®)							X

9.4 Dimensions

Quantos	QA1, QA3	QB1, QB3, QB5	QB7	QB3 / QB5 + QS30
Dimensions				
Max. height of sample container	–	178 mm	178 mm	115 mm
Min. height of sample container	–	31 mm	31 mm	10 mm
Minimum opening of sample container (diameter)	–	6 mm	6 mm	8 mm
Usable height of draft shield	–	180 mm	180 mm	180 mm
Height of instrument (*with open front door)	235 mm	675 mm*	675 mm*	675 mm*
Number of sample containers	–	1	1	30
Weight of instrument (without terminal)	10 kg	15.5 kg	15.5 kg	23.1 kg
Diameter of sample containers (up to) ¹⁾	–	100 mm	50 mm	28 mm
Weighing platform dimensions (WxD)	78 x 73 mm	78 x 73 mm	40 x 40 mm	–
Required Space				
Depth without terminal	487 mm	400 mm	400 mm	480 mm
Depth with terminal		550 mm	550 mm	630 mm
Height	322 mm	680 mm	680 mm	680 mm
Width	263 mm	330 mm	330 mm	520 mm

¹⁾ Sample containers having a diameter of 24 mm exactly match the magazine set 11141772. For sample containers with a diameter from 8 to 24 mm there are various adapters available for this magazine set.

(on request) Sample containers having a diameter of 28 mm exactly match the magazine set 11141773. For sample containers with a diameter from 24 to 28 mm there are various adapters available for this magazine set.

Terminal

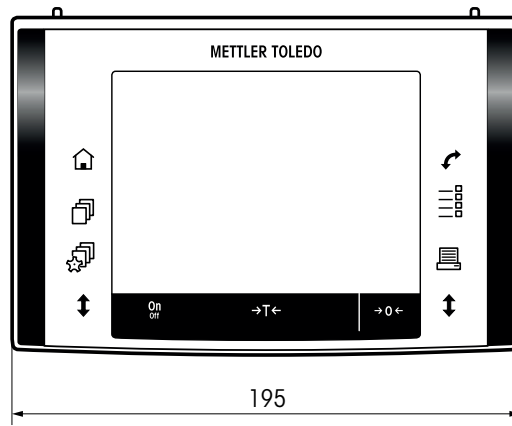
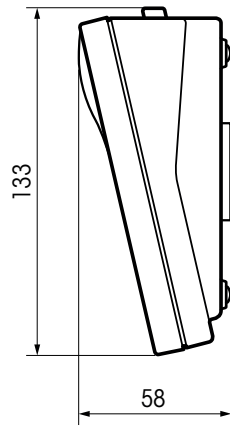

Instrument

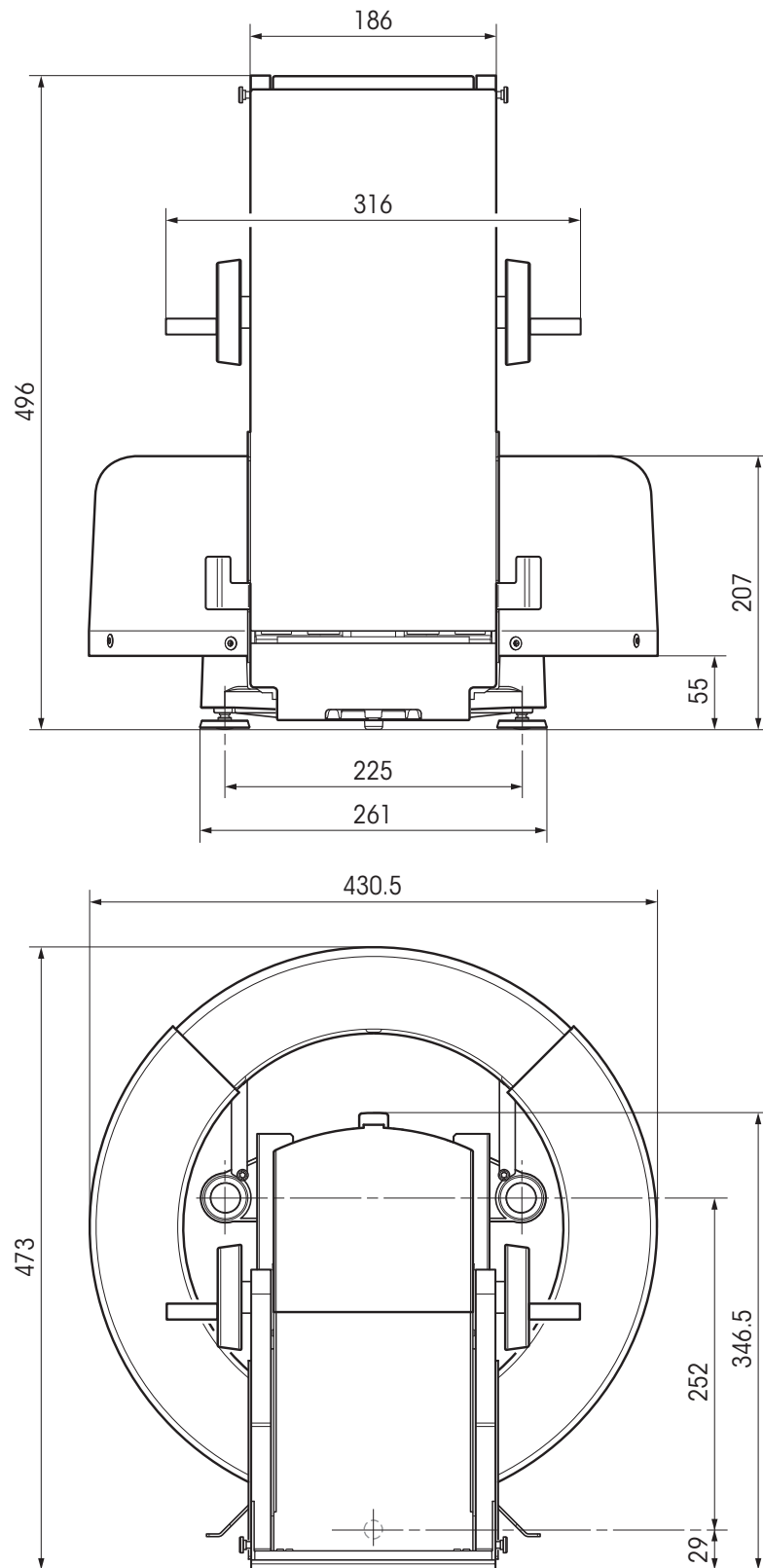

Liquid module

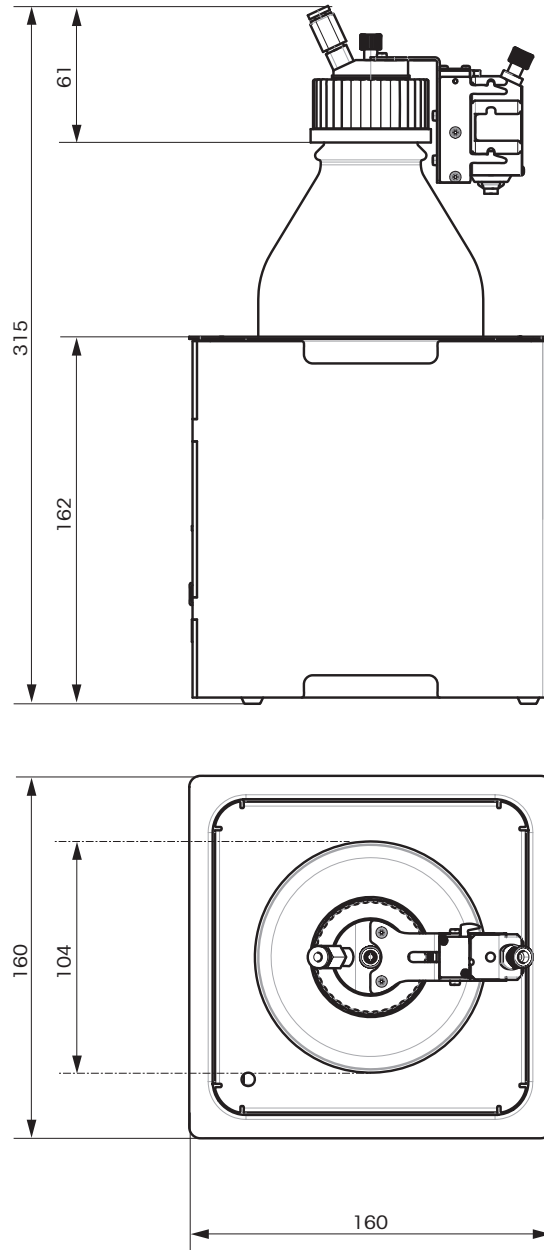

10 Accessories and Spare Parts

10.1 Accessories

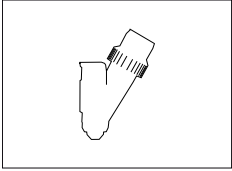
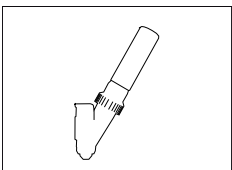
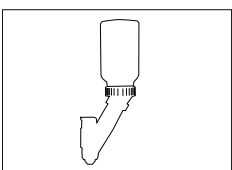
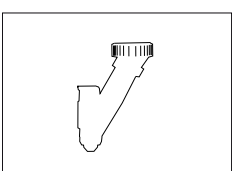
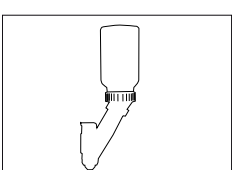
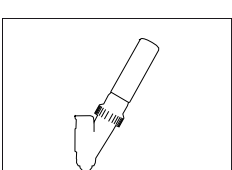
	Description	Part No.
Dosing heads		
	QH008-BNMW Dosing head for recommended 250 dosings up to 500 mg, bulk, 8 ml	11141533
	QH012-LNMW Dosing head for recommended 250 dosings up to 500 mg, bulk, 12 ml	11141532
	QH016-BNMW Dosing head for recommended 250 dosings up to 500 mg, 16 ml	11141503
	QH120-LNMW Dosing head for recommended 250 dosings up to 500 mg, 120 ml	11141502
	QH012-LNLW Dosing head for recommended 250 dosings more than 250 mg, bulk, large dosing pin, 12 ml	11150144
	QH120-LNLW Dosing head for recommended 250 dosings more than 250 mg, large dosing pin, 120 ml	11150145
	Sterile dosing head	on request

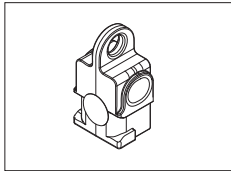

QA000-M Manual dosing head (set of 5)
transponder for the information of often used solids

11141505

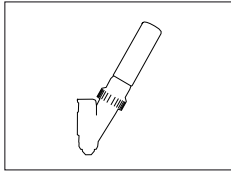

QA075-PNMW Special dosing head for powder test
filled with test powder for 75 dosings, automatic repetition of
10 dosings

11141506

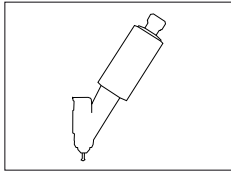

QA000-W Special dosing head for "MinWeigh" test

11141507

Printers

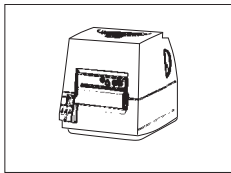

CLS-631 Label printer for Quantos (RS232C/USB-A)
Quantos label and ink ribbon kit

11141820

30004309

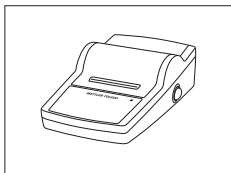

RS-P25 printer for Quantos (RS232C)
Ink ribbon (set of 2)
Standard paper (5 rolls)
Self-adhesive paper (3 rolls)

11141834

00065975

00072456

11600388

Barcode reader

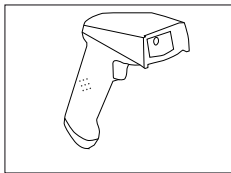

Matrix scanner (USB interface)

11600706

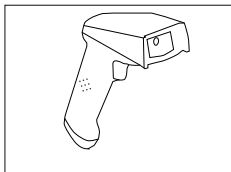

RS232C Barcode Reader

21901297

The following accessories are needed for operation (not included):

RS232 F cable 21901305

Null modem adapter 21900924

Plus one of the following:

AC adapter 5 V for EU 21901370

AC adapter 5 V for US 21901372

AC adapter 5 V for GB 21901371

AC adapter 5 V for AU 21901370

+ 71209966

Power supplies

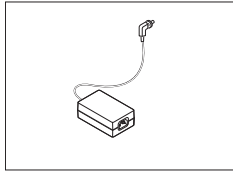

AC/DC adapter (without power cable) 100–240 VAC,
50/60 Hz, 0.3 A, 12 VDC 2.25 A

11107909

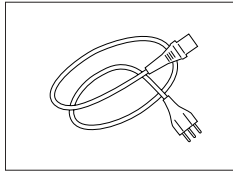

Country-specific 3-Pin power cable with grounding conductor.

Power cable AU	00088751
Power cable BR	30015268
Power cable CH	00087920
Power cable CN	30047293
Power cable DK	00087452
Power cable EU	00087925
Power cable GB	00089405
Power cable IL	00225297
Power cable IN	11600569
Power cable IT	00087457
Power cable JP	11107881
Power cable TH, PE	11107880
Power cable US	00088668
Power cable ZA	00089728

Protective covers

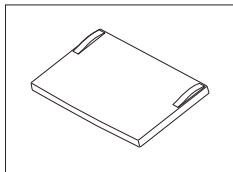

Protective cover for Terminal

11141982

Software

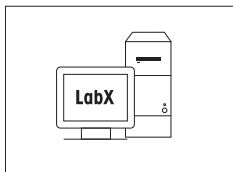

LabX direct Quantos

11141840

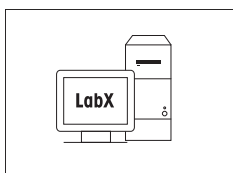

LabX direct QuantosConnect

30008323

Adjustment weights

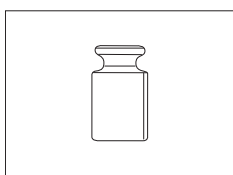

OIML / ASTM Weights (with calibration certificate) see www.mt.com/weights

Various

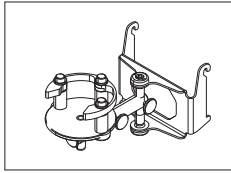

ErgoClip for Quantos

11141570

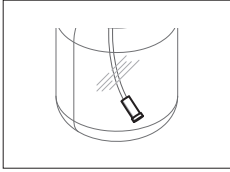

Suction filter PP for 1/8" OD

30007832

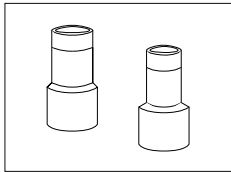

Vial adapters for magazine set 1114172

10.3 mm, capsule size 000

11141571

12 mm

11141575

15 mm, capsule size 13 and 12

11141572

16.2 mm

11141573

21 mm, capsule size 11

11141574

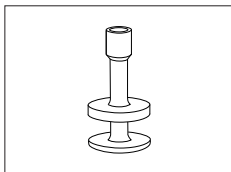

Capsule adapters for magazine set 1114172 (stainless steel)

size 000

30006416

size 00

30006417

size 0

30006418

size 1

30006419

size 2

30006430

size 3

30006431

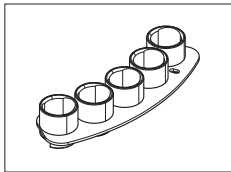

Magazine set for sample containers
(6 magazines with positions consecutively numbered from 1 to 30)

from Ø 8 mm to Ø 24 mm

11141772

from Ø 24 mm to Ø 28 mm

11141773

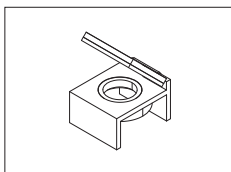

Level bubble mirror

11140150



Integrable antistatic kit incl. pair of multiple point-electrode and power supply

11141829

Special Accessories

The following Accessories must be mounted and installed by a METTLER TOLEDO service engineer.

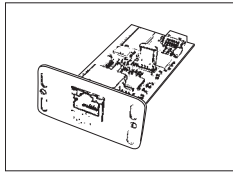

Ethernet Interface for connection to an Ethernet network

11132515

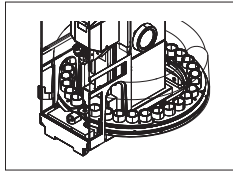

Auto Sampler QS30 complete

11141300

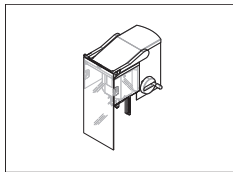

Dosing unit Q2

30005906

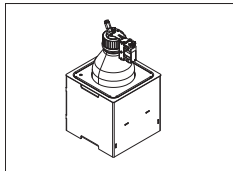

Liquid module

Pump module QL2

30008317

Liquid dosing head and bottle QLL1000

30008318

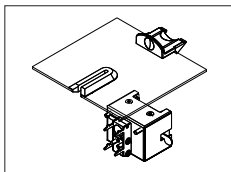

QLX45 kit

30008618

- Liquid head support
- Top glass door
- MinWeigh door
- Cable conduct
- Cable clip
- Power supply with country-specific power cable
- ErgoClip (tilting)
- Cable RS232
- 5 Dosing heads QH000-M

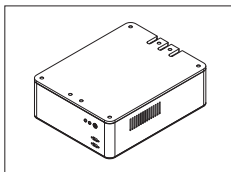

WorkFlowBox

30062623

10.2 Spare Parts

SpareParts QA1...

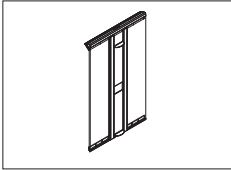
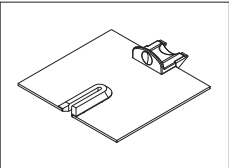
	Description	Part No.
	MinWeigh door	11106749
	Top glass door	30013594

Spare Parts QB1... / QB3... / QB5... / QB7...

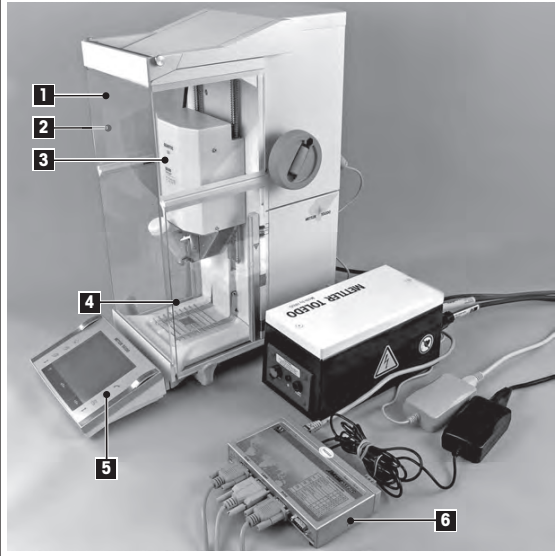
Drawing	Pos	Description	Part No.
	1	Front door QB1.../QB3.../QB5...	11141855
		Front door QB7...	30079864
	2	Side window left	11141854
	3	Side window right	11141853
	4	Side doors (conductive)	11106263
	5	Terminal DAT complete	11141003
	6	Ethernet-to-Serial converter	11141832

Spare Parts Auto Sampler

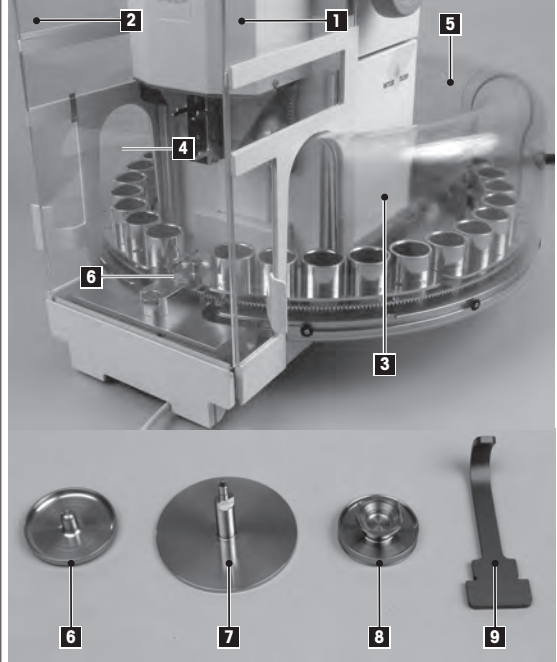
Drawing	Pos	Description	Part No.
	1	Side window right	11141790
	2	Side window left	11141791
	3	Side door right with tunnel	11141787
	4	Side door left with tunnel	11141788
	5	Tunnel rear	11141789
	6	Cover " Home " position	11141390
	7	Weighing pan large	11141337
	8	Weight basket (for external adjustment)	11141391
	9	Hook for cleaning	11141484

11 Appendix

11.1 Overview Menu

Navigation: Application Setup			
Level 1	Level 2	Level 3	Level 4
Function Keys see Selecting Function Keys (page 53)	<ul style="list-style-type: none"> • Start • Quantity • Tolerance • User ID • Sample ID • Un/Lock • Copy head • Info head • Write head • Samples • Set content • Right, Left, Home • Tapper • Setup • SafePos • Adjust.int, Adjust.ext • Test int, Test ext • 1/10d, 1/100d, 1/1000d • Adj. History • Purge 		
Info Field see Selecting Information Fields (page 55)	<ul style="list-style-type: none"> • Var1...Var4 • Target quantity • Tolerance • User ID • Sample ID • Substance • Samples • Rem. samples • Rem. dosages 		

Navigation: Application Setup			
Level 1	Level 2	Level 3	Level 4
Data output see Defining Data Output (page 55)	Sample label	Text (solid dosing)	<ul style="list-style-type: none"> • Substance • Sample ID • Lot ID • Content [mg] • Tolerance • User ID • Dispense date • Exp. date • Retest date • Balance ID • Var1 ...Var4 • Title 1 and Title 2 • Validity • MinWeigh • Dose duration • Target quantity • Label index • Sample position • Head type • Head ID
		Text (liquid dosing)	<ul style="list-style-type: none"> • Solvent name • Sample ID • Lot ID • User ID • Dispense date • Exp. date • Retest date • Balance ID • Var1 ...Var4 • Title 1 and Title 2 • MinWeigh • mSolvent Target • mSolvent meas • Density param. • Liquid vol. • Label index • Sample position • Head type • Head ID

Navigation: Application Setup			
Level 1	Level 2	Level 3	Level 4
Data output see Defining Data Output (page 55)	Sample label	Text (solution)	<ul style="list-style-type: none"> • Solvent name • Substance • Act. conc. • Act. solution • Act. substance • Act. solvent • Density param. • Vol. conc. • Conc. target • m Solution targ. • m Solid target • m Liquid target
		Matrix code (solid dosing)	see Text (solid dosing)
		Matrix code (liquid dosing)	see Text (liquid dosing)
		Matrix code (solution)	see Text (solution)
		Label layout	<ul style="list-style-type: none"> • [Layout 1] • ...[Layout 10]
		Label quantity	<ul style="list-style-type: none"> • 1 - 5
		Label barcode	<ul style="list-style-type: none"> • [Substance] • [Sample ID] • [Lot ID] • [Dos. value]
		Cutter man. series	<ul style="list-style-type: none"> • [Series] • [Samples]
	Sample protocol	Header	<ul style="list-style-type: none"> • Appl. Name • Title 1 and Title 2 • Date/Time • User ID • Balance Type • SNR: • Balance ID • Levelcontrol • Var1...Var4 • Last cal. • Signature • Blank Line • Dash Line • Dash Line • 3 Blank Lines

Navigation: Application Setup			
Level 1	Level 2	Level 3	Level 4
Data output see Defining Data Output (page 55)	Sample protocol	Single value (solid dosing)	<ul style="list-style-type: none"> • Header • Var1 ...Var4 • Title 1 and Title 2 • Substance • Lot ID • Sample ID • Content [mg] • Tolerance • User ID • Dispense date • Exp. date • Retest date • Validity • MinWeigh • Dose duration • Target quantity • Signature • Head ID • Blank Line • Dash Line • Dash Line • 3 Blank Lines
		Single value (liquid dosing)	similar to Text (liquid dosing)
		Single value (solution)	similar to Text (solution)
		Footer	see Header
	Sample data output	<ul style="list-style-type: none"> • Protocol • Label • Host (XML) 	
	Sample data output mode	<ul style="list-style-type: none"> • Manual • Automatic 	
	Head label	similar to Sample label	
	Head protocol	see Sample protocol	
	Head data output	see Sample data output	
	Head data output mode	see Sample data output mode	

Navigation: Application Setup			
Level 1	Level 2	Level 3	Level 4
Data output see Defining Data Output (page 55)	Info head	<ul style="list-style-type: none"> • Substance • Lot ID • Filling date • Exp. date • Retest date • Head type • Head prod. date • Content [mg,g] • Rem. quantity • Rem. dosages • Accuracy • Dose limit • Var1...Var4 • Type data version • Head ID 	
Dosing steps (solid) see Configuring the Dosing Steps (page 61)	<ul style="list-style-type: none"> • User ID • Sample ID • Target quantity • Tolerance • Place container • Lowering head • Unlock head 		
Dosing steps (solution)	<ul style="list-style-type: none"> • User ID • Sample ID • Concentration • Target solution • Density param. • Place container • Lowering head • Unlock head 		
Dosing steps (liquid)	<ul style="list-style-type: none"> • User ID • Sample ID • Target liquid • Density param. • Place container • Lowering head • Unlock head 		
Tolerance Mode see Selecting the Tolerance Mode (page 62)	<ul style="list-style-type: none"> • [+/- Tolerance] • [0/+Tolerance] 		

Navigation: Application Setup			
Level 1	Level 2	Level 3	Level 4
Head def. data see Setting up the Head Definition Data (page 62)	<ul style="list-style-type: none"> • Substance • Lot ID • Filling date • Exp. date • Retest date reached • Content [mg,g] • Var1...Var4 • Dose limit 		
Algo see Selecting the Dosing Algorithm (page 62)	<ul style="list-style-type: none"> • [Algo M] • [Algo P] 		
Display Unit see Selecting the Display Unit (page 62)	<ul style="list-style-type: none"> • [g] • [mg] 		
Titles see Defining Titles (page 63)	<ul style="list-style-type: none"> • Title 1 and Title 2 		
Barcode see Specifications for External Devices (page 63)	<ul style="list-style-type: none"> • [Off] • [Host] • [Open Input] 		
Ext. Keyboard	see Barcode		
MinWeigh see Settings for the "MinWeigh" Function (page 63)	Off		
	On	<ul style="list-style-type: none"> • Method • Info 	
Smart & ErgoSens see Settings for SmartSens and ErgoSens (page 64)	SmartSens left	<ul style="list-style-type: none"> • [Off] • [Door] • [Start] • [1/10d] to [1/1000d] 	
	SmartSens right	see SmartSens left	
	ErgoSens 1 (Aux1)	<ul style="list-style-type: none"> • [Off] • [Door] • [Start] • [1/10d] to [1/1000d] • [AntiStatic Kit] 	
	ErgoSens 2 (Aux2)	see ErgoSens 1 (Aux1)	
Side doors see Configuring the Side Doors (page 65)	<ul style="list-style-type: none"> • Dosing • Un/Lock • Int. Adj, int. Tst 		
Front door see Configuring the Front Door (page 65)	Front door		
	Linked with ...	<ul style="list-style-type: none"> • Dosing • Un/Lock • MinWeigh test • Int. Adj, int. Tst 	

Navigation: Application Setup			
Level 1	Level 2	Level 3	Level 4
Auto sampler see Configuring the Auto Sampler (page 65)	<ul style="list-style-type: none"> • Auto sampler Menu for METTLER TOLEDO Service Engineer • FK "Right" (samples) • FK "Left" (samples) • Sample release (steps) 		
Liquid module see Configuring the Liquid Module (page 66)	<ul style="list-style-type: none"> • Liquid module Menu for METTLER TOLEDO Service Engineer • Open air bleed valve • Max. solvent mass 		
Tapper see Settings for the Tapper (page 66)	<ul style="list-style-type: none"> • Intensity • Duration [s] • Tapping before dosing • Tapping while dosing 		
SafePos see Setting for "SafePos" Option (page 67)		Menu for METTLER TOLEDO Service Engineer	
Dosing unit see Settings for the Dosing Unit (page 67)		Menu for METTLER TOLEDO Service Engineer	
Maintenance see Maintenance (page 67)	Front door		

Navigation: User Setting		
Level 1	Level 2	Level 3
Wghparam see Defining Weighing Parameters (page 69)	Weighing Mode	<ul style="list-style-type: none"> • [Universal] • [Dosing] • [Sensor Mode] • [Checkweighing]
	Environment	<ul style="list-style-type: none"> • [Very stable] • ...[Very unstable]
	Value Release	<ul style="list-style-type: none"> • [Very fast] • ...[Very reliable]
	AutoZero	
User see Entering User Data (page 70)	User Name	
	Language	<ul style="list-style-type: none"> • English • Deutsch • Français
	User ID	
	Password	
Door see Settings for the Side Doors (page 71)	Doorway	<ul style="list-style-type: none"> • [100%] • ...[25%]
Terminal see Terminal Settings (page 72)	<ul style="list-style-type: none"> • Brightness • Colour selection • Sound • Touch Function • Touchadjust • Optical key feedback • Speedread 	

Navigation: User Setting		
Level 1	Level 2	Level 3
User Reset see Resetting User Settings (page 73)		

Navigation: System				
Level 1	Level 2	Level 3	Level 4	
Adjust/Test see Settings for Adjustment and Tests (page 75)	Adj. History	Adj. History		
		Selection	<ul style="list-style-type: none"> • Manual adjust. • Temperature • Time Adjust. 	
		Display Datasets		<ul style="list-style-type: none"> • [Last 50] • ...[Last 10]
	ProFACT	<ul style="list-style-type: none"> • Weekdays • Time 1 • Temp.Criterion • Protocol Trigger 		
	Autom. ext. Adjust.	<ul style="list-style-type: none"> • Weekdays • Time 		
	Adjustweights	Adjustweight 1		<ul style="list-style-type: none"> • Weight • ID • Certificate No.
		...Adjustweight 5		see Adjustweight 1
	Autom. ext. Test	see Autom. ext. Adjust.		
	Testweights	Testweight 1		see Adjustweight 1
		...Testweight 5		see Adjustweight 1
Protocol	<ul style="list-style-type: none"> • Date/Time • User • Balance Type • SNR • SW-Version • Balance ID • Weight ID • Certificate No. • Temperature • Nominal Weight • Actual Weight • Difference • Levelcontrol • Signature 			
Balance Info see Instrument Information (page 78)	<ul style="list-style-type: none"> • Balance ID • Balance Info 			
Standby see Standby (page 78)				
Date/Time see Date and Time (page 79)	<ul style="list-style-type: none"> • Date format • Date • Time Format • Time 			

Navigation: System				
Level 1	Level 2	Level 3	Level 4	
Peripherals see Selecting Peripheral Devices (page 80)	<ul style="list-style-type: none"> • Dosing unit • Host • Printer • Label Printer • Secondary Display • Barcode • Ext. Keyboard 			
Option see Establishing Global Settings for the Ethernet Interface (page 81)	Global Settings	<ul style="list-style-type: none"> • DHCP • IP-Adress • Subnet Mask • Standard Gateway • Domain Name Server • Hostname 		
Administrator see Configuring the Security System (page 81)	Administrator ID			
	Administrator Password			
	Master Reset			
	Home Rights	Application Setup	<ul style="list-style-type: none"> • No Protection • User Protect. • Adm. Protect. 	
		Weighing parameters Adjustweight User User ID/Password System User Setting	see Application Setup	
	User 1 Rights	see Home Rights		
	...User 7 Rights	see Home Rights		
	History	<ul style="list-style-type: none"> • History • Record Mode 		
	Passw. Change Date			
	Number of users	<ul style="list-style-type: none"> • User 1 • ...User 7 		
Levelcontrol see Settings for the Level Sensor (page 83)	Warning Text	<ul style="list-style-type: none"> • Off • Once • Repeat 		
	Warning Beep	see Warning Text		

Also see

- Selecting Function Keys (page 53)
- Selecting Information Fields (page 55)
- Defining Data Output (page 55)
- Configuring the Dosing Steps (page 61)
- Selecting the Tolerance Mode (page 62)

- Setting up the Head Definition Data (page 62)
- Selecting the Dosing Algorithm (page 62)
- Selecting the Display Unit (page 62)
- Defining Titles (page 63)
- Specifications for External Devices (page 63)
- Settings for the "MinWeigh" Function (page 63)
- Settings for SmartSens and ErgoSens (page 64)
- Configuring the Side Doors (page 65)
- Configuring the Front Door (page 65)
- Configuring the Auto Sampler (page 65)
- Configuring the Liquid Module (page 66)
- Settings for the Tapper (page 66)
- Settings for the Dosing Unit (page 67)
- Setting for "SafePos" Option (page 67)
- Maintenance (page 67)
- Defining Weighing Parameters (page 69)
- Entering User Data (page 70)
- Settings for the Side Doors (page 71)
- Terminal Settings (page 72)
- Resetting User Settings (page 73)
- Settings for the Level Sensor (page 83)
- Configuring the Security System (page 81)
- Establishing Global Settings for the Ethernet Interface (page 81)
- Selecting Peripheral Devices (page 80)
- Date and Time (page 79)
- Standby (page 78)
- Instrument Information (page 78)
- Settings for Adjustment and Tests (page 75)

12 Index

A

AC adapter	11, 18, 19, 50
AC Adapter	98, 98
Accessories	107
Adjustment	36, 74, 76
Air inlet	43
Air tube	42
Air tube fitting pin	47
Algorithm	52
Ambient conditions	16
AntiStatic Kit	19, 64
Antistatic kit	11, 95
Application Settings	51
Application Setup	13, 49
Application specific settings	24
Auto Sampler	12, 38, 40, 53
Aux connectors	11, 19, 50

B

Backspace	25
Barcode reader	52, 63
Bottle	42
Bottle holder	42

C

Cap	42
Certificate	63-64
Change liquid	47
Cleaning	85, 85
Auto Sampler	86
Liquid module	88
Side window	85
Code reader	18, 19, 50
Color	72
Compacting powder	67
Concentration	45
Connector	43
Container	
Plastic	96
Conventions and symbols	7
Copy data	31
Customizable field	30

D

Data output	52, 55
Date	13, 79
Density	48
Differentiation of user profiles	71
Dimension	
Instrument	105
Liquid module	106
Terminal	104
Display	13
Display language	71
Display unit	52, 62
Disposal	88

Dose	21, 44
Dose solution	45
Many samples	46
Dosing algorithm	62
Dosing cycle	41
Dosing head	11, 21, 26, 44
Data	61
Liquid	42, 44, 45, 45
Manual	26, 46
MinWeigh	27
Powder	26, 45
Powder test	27
Dosing powder	33
Dosing solution	
Few samples	46
Prepared samples	45
Dosing steps	21, 52, 61
Draft Shield	85
Drip pan	42
Drive ring	38, 87

E

Electrode	96
Electrostatic charge	95
ErgoSens	52, 64, 64
Error	
Exceeding limits	92
Instrument	91
Interfaces	93
Substance	92
Error messages	89
Ethernet	
Interface	11, 18, 19, 50
Serial converter	11, 18, 19, 50
Ethernet interface	81
Exhaust air outlet	43
External adjustment	37
External adjustment weight	76
External adjustment weights	37, 37
External keyboard	52, 63
External test	37
External test weight	77

F

Faceplate	43
Factory setting	53
Ferrule	47
Filling date	29
Filter	42
Footscrew	
Leveling screw	11
Front door	11, 13, 26, 38, 49, 53, 65
Front door adjustment	67
Function key	
Auto Sampler	39
Select	28
Function keys	14, 52, 53

Function without touching	64	O	Optical feedback	72
G		P		
Gear	86	Password	25, 82	
Glass draft shield	26	Password Change Reminder	83	
Gravimetric	48	PEEK nut	47	
Guide notch	44	Peripheral devices	18, 19, 50, 80	
H		Pin of air tube fitting	47	
Head data	52, 62	Powder container	27	
Host computer	18, 19, 50, 60	Powder flow	67	
I		Power supply	18, 19, 50	
ID	25, 82	Pressure release	45, 50, 66	
Information fields	14, 52, 55	Print	13, 49	
Information for service engineer	78	Application settings	53	
Inline Frit Filter	47	Manual dosing	33	
Instrument information	78	Sample data	60	
Internal adjustment	36	Printing	23	
Internal adjustment weight	37	Printout	23	
Internal test	37	ProFACT	36, 76	
Ionize	95	Pump module	42	
Ionizer		Purge	88	
see AntiStatic Kit	11	R		
L		Record adjustment operations	75	
Label layout	58	Release pressure	45, 50, 66	
Label printer	18, 19, 50, 60	Repeatability of powder dosing	95	
Language change	71	Reset settings	73	
Learning mode	23	RS232C interface	11, 18, 19, 50, 80	
Level indicator	11, 11	S		
Level sensor	83	SafePos	34, 34, 40, 53, 54, 67	
Leveling screw		Safety precautions	9	
Footscrew	11	Sample container	38	
Leveling the balance	17	Sample counter	32	
Light condition	72	Sample data	56	
Line printer	18, 19, 50, 60	Sample ID	22	
Liquid bottle	42	Sample vessel	23, 23	
Liquid dosing head	42, 44	Saving energy	79	
Liquid module	42, 44, 53	Scanner	27	
Liquid tube	42	Scope of delivery		
Location	16	AntiStatic Kit	16	
M		Auto Sampler	38	
Magazine	38	Converter	16	
Magazine support		Dosing unit	16	
see "Drive ring"	87	Liquid Module	43	
Maintenance	67, 85	Security system	25, 74, 81	
Manual dosing	32-33	Selecting the location	16	
Manual dosing head	26	Sensor	12	
Matrix code	27, 58	Service	85	
Micro dispensing valve	88	Set content	28	
MinWeigh	33, 52, 63	Side door	12, 25, 38, 49	
N		Side doors	11, 52, 65, 71	
Name of the substance	29	Single dosing	41	
New user profile	35	Slide ring	87	
		SmartSens	12, 49, 52, 64	

SmartTrac	14, 23
Solvent	102
SOP	85
Spare cap	27
Speedread	73
Standby	79
Status bar	12, 49
Status icon	13, 33, 93
Suction filter	42
Maintenance interval	87
Switching Off	20, 45
Switching On	20
Symbols and conventions	7
System settings	25, 74

T

Tapper	53, 66, 66
Tare	13, 49
Target quantity	22, 95
Target solution	45
Technical data general	97
Technical data model-specific	99, 100
Terminal	11, 12, 18, 19, 50
Terminal settings	72
Time	13, 79
Title text	63
Tolerance	22, 95
Tolerance mode	52, 62
Touchadjustment	72
Tube	
Air	42
Liquid	42
Tunnel	
Auto Sampler	38

U

Unlocking the head	
automatically	32
manually	32
User data	29, 70
User guide	
see Dosing steps	61
User ID	22
User profile	12, 24, 49, 51, 51, 69
User profile setting	12, 49
User settings	69
User specific settings	24

V

Valve	
Micro dispensing	88
Var1	30
Vial adapter	66
Volumetric	48

W

Weighing pan	11
large	41
Weighing parameters	69
Weighing unit	13
Weight basket	38, 41
Weight value	13
Wetted part	103
Wire	43
Wiring	43
Wiring QA series	18
Wiring QB series	19

X

XML format	55, 60
------------	--------

Z

Zero point	13, 49
Zeroing	13, 49

GWP® – Good Weighing Practice™

The global weighing guideline GWP® reduces risks associated with your weighing processes and helps to

- choose the appropriate balance
- reduce costs by optimizing testing procedures
- comply with the most common regulatory requirements

► www.mt.com/GWP

www.mt.com/quantos

For more information

Mettler-Toledo AG, Laboratory & Weighing Technologies

CH-8606 Greifensee, Switzerland

Tel. +41 (0)44 944 22 11

Fax +41 (0)44 944 30 60

www.mt.com

Subject to technical changes.

© Mettler-Toledo AG 05/2013

11781172K en

